



L2 SWITCH

SWP1

SWP1-8 / SWP1-8MMF / SWP1-16MMF

Owner's Manual
Bedienungsanleitung
Mode d'emploi
Manual de instrucciones
Manual do Proprietário
Manuale di istruzioni
Руководство пользователя
取扱説明書

EN
DE
FR
ES
PT
IT
RU
JA

English

Deutsch

Français

Español

Português

Italiano

Русский

日本語

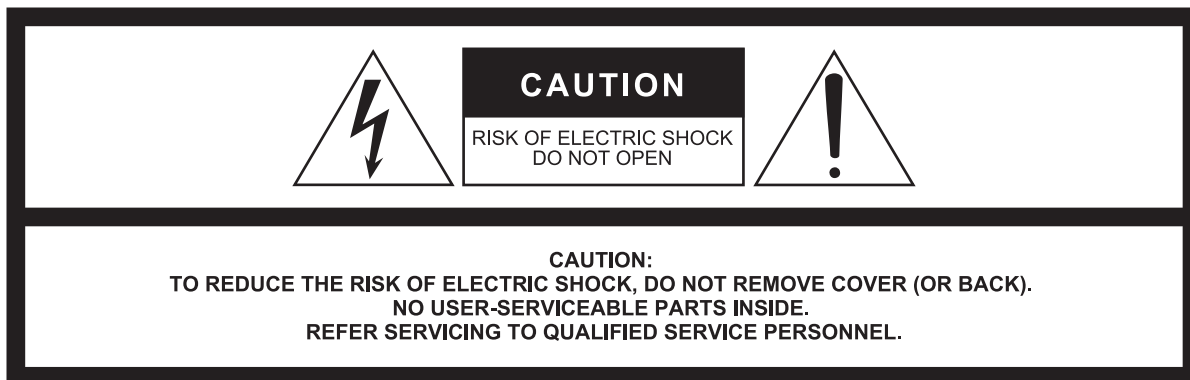

The above warning is located on the top of the unit.
L'avertissement ci-dessus est situé sur le dessus de l'unité.

Explanation of Graphical Symbols Explication des symboles



The lightning flash with arrowhead symbol within an equilateral triangle is intended to alert the user to the presence of uninsulated "dangerous voltage" within the product's enclosure that may be of sufficient magnitude to constitute a risk of electric shock to persons.

L'éclair avec une flèche à l'intérieur d'un triangle équilatéral est destiné à attirer l'attention de l'utilisateur sur la présence d'une « tension dangereuse » non isolée à l'intérieur de l'appareil, pouvant être suffisamment élevée pour constituer un risque d'électrocution.



The exclamation point within an equilateral triangle is intended to alert the user to the presence of important operating and maintenance (servicing) instructions in the literature accompanying the product.

Le point d'exclamation à l'intérieur d'un triangle équilatéral est destiné à attirer l'attention de l'utilisateur sur la présence d'instructions importantes sur l'emploi ou la maintenance (réparation) de l'appareil dans la documentation fournie.

IMPORTANT SAFETY INSTRUCTIONS

- 1 Read these instructions.
- 2 Keep these instructions.
- 3 Heed all warnings.
- 4 Follow all instructions.
- 5 Do not use this apparatus near water.
- 6 Clean only with dry cloth.
- 7 Do not block any ventilation openings. Install in accordance with the manufacturer's instructions.
- 8 Do not install near any heat sources such as radiators, heat registers, stoves, or other apparatus (including amplifiers) that produce heat.
- 9 Do not defeat the safety purpose of the polarized or grounding-type plug. A polarized plug has two blades with one wider than the other. A grounding type plug has two blades and a third grounding prong. The wide blade or the third prong are provided for your safety. If the provided plug does not fit into your outlet, consult an electrician for replacement of the obsolete outlet.
- 10 Protect the power cord from being walked on or pinched particularly at plugs, convenience receptacles, and the point where they exit from the apparatus.
- 11 Only use attachments/accessories specified by the manufacturer.
- 12 Use only with the cart, stand, tripod, bracket, or table specified by the manufacturer, or sold with the apparatus. When a cart is used, use caution when moving the cart/apparatus combination to avoid injury from tip-over.
- 13 Unplug this apparatus during lightning storms or when unused for long periods of time.
- 14 Refer all servicing to qualified service personnel. Servicing is required when the apparatus has been damaged in any way, such as power-supply cord or plug is damaged, liquid has been spilled or objects have fallen into the apparatus, the apparatus has been exposed to rain or moisture, does not operate normally, or has been dropped.
- 15 [EXT DC INPUT] Connector is intended to be supplied by UL Listed Power Supply marked "Limited Power Source", "LPS" or "Class 2" and rated 24 Vdc.



WARNING

TO REDUCE THE RISK OF FIRE OR ELECTRIC SHOCK, DO NOT EXPOSE THIS APPARATUS TO RAIN OR MOISTURE.

PRÉCAUTIONS CONCERNANT LA SÉCURITÉ

- 1 Lire ces instructions.
- 2 Conserver ces instructions.
- 3 Tenir compte de tous les avertissements.
- 4 Suivre toutes les instructions.
- 5 Ne pas utiliser ce produit à proximité d'eau.
- 6 Nettoyer uniquement avec un chiffon propre et sec.
- 7 Ne pas bloquer les orifices de ventilation. Installer l'appareil conformément aux instructions du fabricant.
- 8 Ne pas installer l'appareil à proximité d'une source de chaleur comme un radiateur, une bouche de chaleur, un poêle ou tout autre appareil (y compris un amplificateur) produisant de la chaleur.
- 9 Ne pas modifier le système de sécurité de la fiche polarisée ou de la fiche de terre. Une fiche polarisée dispose de deux broches dont une est plus large que l'autre. Une fiche de terre dispose de deux broches et d'une troisième pour le raccordement à la terre. Cette broche plus large ou cette troisième broche est destinée à assurer la sécurité de l'utilisateur. Si la fiche équipant l'appareil n'est pas compatible avec les prises de courant disponibles, faire remplacer les prises par un électricien.
- 10 Acheminer les cordons d'alimentation de sorte qu'ils ne soient pas piétinés ni coincés, en faisant tout spécialement attention aux fiches, prises de courant et au point de sortie de l'appareil.
- 11 Utiliser exclusivement les fixations et accessoires spécifiés par le fabricant.
- 12 Utiliser exclusivement le chariot, le stand, le trépied, le support ou la table recommandés par le fabricant ou vendus avec cet appareil. Si l'appareil est posé sur un chariot, déplacer le chariot avec précaution pour éviter tout risque de chute et de blessure.
- 13 Débrancher l'appareil en cas d'orage ou lorsqu'il doit rester hors service pendant une période prolongée.
- 14 Confier toute réparation à un personnel qualifié. Faire réparer l'appareil s'il a subi tout dommage, par exemple si la fiche ou le cordon d'alimentation est endommagé, si du liquide a coulé ou des objets sont tombés à l'intérieur de l'appareil, si l'appareil a été exposé à la pluie ou à de l'humidité, si l'appareil ne fonctionne pas normalement ou est tombé.
- 15 Le connecteur [EXT DC INPUT] (Entrée CC extérieure) est conçu pour être alimenté par une source d'alimentation à courant continu répertoriée UL, marquée « LPS » à puissance régulée ou de « Classe 2 » et d'une puissance de 24 V cc.

AVERTISSEMENT

POUR RÉDUIRE LES RISQUES D'INCENDIE OU DE DÉCHARGE ÉLECTRIQUE, N'EXPOSEZ PAS CET APPAREIL À LA PLUIE OU À L'HUMIDITÉ.

FCC INFORMATION (for US customers)

1. IMPORTANT NOTICE: DO NOT MODIFY THIS UNIT!

This product, when installed as indicated in the instructions contained in this manual, meets FCC requirements. Modifications not expressly approved by Yamaha may void your authority, granted by the FCC, to use the product.

2. IMPORTANT:

When connecting this product to accessories and/or another product use only high quality shielded cables. Cable/s supplied with this product MUST be used. Follow all installation instructions. Failure to follow instructions could void your FCC authorization to use this product in the USA.

3. NOTE:

This product has been tested and found to comply with the requirements listed in FCC Regulations, Part 15 for Class "A" digital devices. Compliance with these requirements provides a reasonable level of assurance that your use of this product, in a commercial environment, will not result in harmful interference with other electronic devices. However, operation of this product in a commercial area is likely to cause interference in some form. In this case you, the user, bear the responsibility of correcting this condition.

This product generates/uses radio frequencies and, if not installed and used according to the instructions found in the users manual,

may cause interference harmful to the operation of other electronic devices. Compliance with FCC regulations does not guarantee that interference will not occur in all installations. If this product is found to be the source of interference, which can be determined by turning the product "OFF" and "ON", please try to eliminate the problem by using one of the following measures:

Relocate either the product generating the interference or the device that is being affected by the interference.

Utilize power outlets that are on different branch (circuit breaker or fuse) circuits or install AC line filter/s.

In the case of radio or TV interference, relocate/reorient the antenna. If the antenna lead-in is 300 ohm ribbon lead, change the lead-in to co-axial type cable.

If these corrective measures do not produce satisfactory results, please contact the local retailer that is authorized to distribute this type of product. If you can not locate the appropriate retailer, please contact Yamaha Corporation of America, Electronic Service Division, 6600 Orangethorpe Ave, Buena Park, CA90620

The above statements apply ONLY to those products distributed by Yamaha Corporation of America or its subsidiaries.

* This applies only to products distributed by YAMAHA CORPORATION OF AMERICA.

(class A)

IMPORTANT NOTICE FOR THE UNITED KINGDOM

Connecting the Plug and Cord

WARNING: THIS APPARATUS MUST BE EARTHED IMPORTANT. The wires in this mains lead are coloured in accordance with the following code:

| | |
|------------------|-----------|
| GREEN-AND-YELLOW | : EARTH |
| BLUE | : NEUTRAL |
| BROWN | : LIVE |

As the colours of the wires in the mains lead of this apparatus may not correspond with the coloured markings identifying the terminals in your plug proceed as follows:

The wire which is coloured GREEN-and-YELLOW must be connected to the terminal in the plug which is marked by the letter E or by the safety earth symbol  or colored GREEN or GREEN-and-YELLOW.

The wire which is coloured BLUE must be connected to the terminal which is marked with the letter N or coloured BLACK.

The wire which is coloured BROWN must be connected to the terminal which is marked with the letter L or coloured RED.

(3 wires)

PRECAUTIONS

PLEASE READ CAREFULLY BEFORE PROCEEDING

Please keep this manual in a safe place for future reference.



WARNING

Always follow the basic precautions listed below to avoid the possibility of serious injury or even death from electrical shock, short-circuiting, damages, fire or other hazards. These precautions include, but are not limited to, the following:

Power supply/power cord

- Do not place the power cord near heat sources such as heaters or radiators, and do not excessively bend or otherwise damage the cord, place heavy objects on it, or place it in a position where anyone could walk on, trip over, or roll anything over it.
- Only use the voltage specified as correct for the device. The required voltage is printed on the name plate of the device.
- Use only the supplied power cord/plug.
If you intend to use the device in an area other than in the one you purchased, the included power cord may not be compatible. Please check with your Yamaha dealer.
- Check the electric plug periodically and remove any dirt or dust which may have accumulated on it.
- When setting up the device, make sure that the AC outlet you are using is easily accessible. If some trouble or malfunction occurs, immediately disconnect the plug from the outlet, and also disconnect the connected power supply from the [EXT DC INPUT] connector.
- Remove the electric plug from the outlet when the device is not to be used for extended periods of time, or during electrical storms.
- Be sure to connect to an appropriate outlet with a protective grounding connection. Improper grounding can result in electrical shock, damage to the device(s), or even fire.

Do not open

- This device contains no user-serviceable parts. Do not open the device or attempt to disassemble the internal parts or modify them in any way. If it should appear to be malfunctioning, discontinue use immediately and have it inspected by qualified Yamaha service personnel.

Water warning

- Do not expose the device to rain, use it near water or in damp or wet conditions, or place on it any containers (such as vases, bottles or glasses) containing liquids which might spill into any openings. If any liquid such as water seeps into the device, turn off the power immediately and unplug the power cord from the AC outlet. Then have the device inspected by qualified Yamaha service personnel.
- Never insert or remove an electric plug with wet hands.

Hearing loss

- When turning on the AC power in your audio system, always turn on the power amplifier LAST, to avoid hearing loss and speaker damage. When turning the power off, the power amplifier should be turned off FIRST for the same reason.

Fire warning

- Do not place any burning items or open flames near the device, since they may cause a fire.

If you notice any abnormality

- When one of the following problems occur, immediately disconnect the electric plug from the outlet. Then have the device inspected by Yamaha service personnel.
 - The power cord or plug becomes frayed or damaged.
 - Unusual smells or smoke are emitted.
 - Some object has been dropped into the device.
 - There is a sudden loss of sound during use of the device.
 - Cracks or other visible damage appear on the device.
- If this device should be dropped or damaged, immediately disconnect the electric plug from the outlet, and have the device inspected by qualified Yamaha service personnel.

Handling

- Do not touch the interior of the ports with your finger or a metal object.
- Doing so may cause electrocution or malfunctions.
If lightning is occurring nearby, do not touch the unit or the power cord. Doing so carries the risk of electrocution.

CAUTION

Always follow the basic precautions listed below to avoid the possibility of physical injury to you or others, or damage to the device or other property. These precautions include, but are not limited to, the following:

Power supply/power cord

- When removing the electric plug from the device or an outlet, always hold the plug itself and not the cord. Pulling by the cord can damage it.

Location

- Do not place the device in an unstable position where it might accidentally fall over and cause injuries.
- Do not block the vents. This device has ventilation holes at the sides to prevent the internal temperature from becoming too high. In particular, do not place the device on its side or upside down. Inadequate ventilation can result in overheating, possibly causing damage to the device(s), or even fire.
- When attempting to dissipate heat on the device, when installing it:
 - Do not cover it with any cloth.
 - Do not install it on a carpet or rug.
 - Make sure the top surface faces up; do not install on its sides or upside down.
 - Do not use the device in a confined, poorly-ventilated location.
 Inadequate ventilation can result in overheating, possibly causing damage to the device(s), or even fire.
- Do not place the device in a location where it may come into contact with corrosive gases or salt air. Doing so may result in malfunction.
- Before moving the device, remove all connected cables.
- If the device is mounted in an EIA standard rack, carefully read the section "Precautions for Rack Mounting" on page 9. Inadequate ventilation can result in overheating, possibly causing damage to the device(s), malfunction, or even fire.

Connections

- Before connecting the device to other devices, turn off the power for all devices. Also, before turning the power of all devices on or off, make sure that all volume levels are set to the minimum. Failing to do so may result in electric shock, hearing loss, or equipment damage.

Maintenance

- Remove the power plug from the AC outlet when cleaning the device.

Handling caution

- Do not insert your fingers or hands in any gaps or openings on the device (vents, panel, etc.).
- Avoid inserting or dropping foreign objects (paper, plastic, metal, etc.) into any gaps or openings on the device (vents, panel, etc.) If this happens, unplug the power cord from the outlet. Then have the device inspected by qualified Yamaha service personnel.

- Do not rest your weight on the device or place heavy objects on it, and avoid use excessive force on the buttons, switches or connectors to prevent injuries.
- Do not connect any console cable other than an RJ-45/DB-9 console cable to the [CONSOLE (RS232-C)] connector. Doing so may cause fire, electrocution, or malfunction.
- This product (SWP1-8MMF and SWP1-16MMF) uses lasers. Do not look into the tip of an optical fiber or into an optical connector. Doing so may damage your eyes.

Yamaha cannot be held responsible for damage caused by improper use or modifications to the device, or data that is lost or destroyed.

NOTICE

To avoid the possibility of malfunction/ damage to the product, damage to data, or damage to other property, follow the notices below.

Handling and maintenance

- Do not use the device in the vicinity of a TV, radio, stereo equipment, mobile phone, or other electric devices. Otherwise, the device, TV, or radio may generate noise.
- Do not expose the device to excessive dust or vibration, or extreme cold or heat (such as in direct sunlight, near a heater, or in a car during the day), in order to prevent the possibility of panel disfiguration, unstable operation, or damage to the internal components.
- Do not place vinyl, plastic or rubber objects on the device, since this might discolor the panel.
- When cleaning the device, use a dry and soft cloth. Do not use paint thinners, solvents, cleaning fluids, or chemical-impregnated wiping cloths.
- Condensation can occur in the device due to rapid, drastic changes in ambient temperature—when the device is moved from one location to another, or air conditioning is turned on or off, for example. Using the device while condensation is present can cause damage. If there is reason to believe that condensation might have occurred, leave the device for several hours without turning on the power until the condensation has completely dried out.
- When you are not using the device for a long time, make sure you unplug the power cord from the wall AC outlet.

Information

About copyrights

- Copying of the software or reproduction of this manual in whole or in part by any means is expressly forbidden without the written consent of the manufacturer.

About functions/data bundled with the device

- This is a class A product. In a domestic environment this product may cause radio interference in which case the user may be required to take adequate measures. (CISPR22)
- This product is a class 1 laser product. It is compliant with IEC60825-1, IEC60825-2, FDA 21 CFR 1002.10, and 1002.12.
- Ensure all the communication cables are kept apart from the power cable, etc. Failure to observe this could result in a large amount of voltage being generated and a subsequent malfunction.
- Ensure to initialize the settings before transferring/disposing of the product.
- Installation of the device must comply with local and national electrical codes.

About this manual

- The illustrations as shown in this manual are for instructional purposes only.
- Yamaha Corporation make no representations or warranties with regard to the use of the software and documentation and cannot be held responsible for the results of the use of this manual and the software.
- Windows is a registered trademark of Microsoft® Corporation in the United States and other countries.

- The company names and product names in this manual are the trademarks or registered trademarks of their respective companies.
- Software may be revised and updated without prior notice.

Open Source Software Used in this Product

- Please refer to Yamaha Pro Audio website for the details of licensing article.
<http://www.yamahaproaudio.com/>

Information for Users on Collection and Disposal of Old Equipment



This symbol on the products, packaging, and/or accompanying documents means that used electrical and electronic products should not be mixed with general household waste. For proper treatment, recovery and recycling of old products, please take them to applicable collection points, in accordance with your national legislation and the Directives 2002/96/EC.

By disposing of these products correctly, you will help to save valuable resources and prevent any potential negative effects on human health and the environment which could otherwise arise from inappropriate waste handling.

For more information about collection and recycling of old products, please contact your local municipality, your waste disposal service or the point of sale where you purchased the items.

[For business users in the European Union]

If you wish to discard electrical and electronic equipment, please contact your dealer or supplier for further information.

[Information on Disposal in other Countries outside the European Union]

This symbol is only valid in the European Union. If you wish to discard these items, please contact your local authorities or dealer and ask for the correct method of disposal.

(weee_eu_en_01)

The model number, serial number, power requirements, etc., may be found on or near the name plate, which is at the top of the unit. You should note this serial number in the space provided below and retain this manual as a permanent record of your purchase to aid identification in the event of theft.

Model No.

Serial No.

(rear_en_01)

SOFTWARE LICENCE AGREEMENT

This agreement is an agreement between you, the customer, and Yamaha Corporation (hereafter referred to as "Yamaha") defining the conditions under which Yamaha provides firmware for this Yamaha network product (hereafter referred to as the Product) and related programs, printed material, and electronic files (hereafter referred to as the Software).

The Software may be used only for the purpose of operating it on the Product or on a personal computer or similar device. This agreement applies to the Software provided by Yamaha to the customer and to copies of the Software created by the customer in compliance with section 1 subsection (1) of this agreement.

1. Permission to use

- (1) The customer may install and use the Software on a Product or a personal computer or similar device owned by the customer.
- (2) With the exceptions that are explicitly defined by this agreement, the customer shall not permit the reuse of, sell, distribute, rent, lease, lend, or transfer the Software, nor upload it to any website or server where it could be accessed by specified or unspecified numbers of people, nor duplicate, translate, adapt it, or rewrite it into any other program language. The customer shall not correct, revise, reverse-assemble, reverse-compile, or perform any reverse engineering of the Software, and may not cause any third party to perform such actions.
- (3) The customer shall not modify, erase, or delete the Yamaha copyright indications that are included in the Software.
- (4) With the exceptions that are explicitly defined by this agreement, Yamaha does not grant or permit the customer any of Yamaha's intellectual property rights.

2. Property rights

The Software is protected by copyright law and by other laws, and is the property of Yamaha. The customer hereby agrees that no property rights or intellectual property rights related to the Software are granted by Yamaha to the customer by this agreement nor any other means.

3. Export restrictions

The customer shall abide by all applicable export regulations and rules of the relevant countries, and shall not export or re-export the Software, neither in part nor in whole, in violation of any applicable rules and regulations.

4. Support and updates

Yamaha, its subsidiaries, their sales representatives and dealers, and any other party handling or distributing the Software do not accept any responsibility for maintaining the Software nor for supporting the customer's use of the Software. Nor do the aforementioned parties have any responsibility to update the Software, to fix bugs, or to provide support.

5. Limitation of responsibility

- (1) The software is licensed for use "in its current state (as-is)." Yamaha, its subsidiaries, their sales representatives and dealers, and any other party handling or distributing the Software make no warranty, neither explicit nor implicit, regarding the merchantability or suitability of the Software for any particular purpose.
- (2) Yamaha, its subsidiaries, their sales representatives and dealers, and any other party handling or distributing the

Software shall bear no responsibility for any damages (including but not limited to lost profit and any other consequential or incidental damages) that may arise from the use of or inability to use the Software. This shall be the case even if Yamaha, its subsidiaries, their sales representatives and dealers, or any other party handling or distributing the Software had been informed of the possibility of such damages.

- (3) Yamaha, its subsidiaries, their sales representatives and dealers, and any other party handling or distributing the Software shall bear no responsibility for any dispute between the customer and a third party that may arise from or related to the use of the Software.

6. Term of validity

- (1) This agreement shall continue in force until it is terminated by the following sub-sections (2) or (3).
- (2) The customer may terminate this agreement by deleting all instances of the Software that are installed on the Product or on a personal computer or similar device.
- (3) This agreement shall immediately terminate if the customer violates any of the terms of this agreement.
- (4) Upon the termination of this agreement due to sub-section (3) above, the customer shall immediately delete all instances of the Software that are installed on the Product or on a personal computer or similar device.
- (5) Regardless of any clauses of this agreement, the provisions of sections 2 through 6 of this agreement shall continue in force even after the termination of this agreement.

7. Separability

Even if any clause of this agreement should become invalid, the remainder of the agreement shall remain in force.

8. U.S. GOVERNMENT RESTRICTED RIGHTS NOTICE:

The Software is a "commercial item," as that term is defined at 48 C.F.R. 2.101 (Oct 1995), consisting of "commercial computer software" and "commercial computer software documentation," as such terms are used in 48 C.F.R. 12.212 (Sept 1995). Consistent with 48 C.F.R. 12.212 and 48 C.F.R. 227.7202-1 through 227.72024 (June 1995), all U.S. Government End Users shall acquire the Software with only those rights set forth herein.

9. General articles

The customer agrees that this agreement is the complete and only declaration of agreement between the customer and Yamaha regarding all matters prescribed by this agreement, and that it takes precedence over all proposals, prior agreements, or any other communication between the customer and Yamaha, whether oral or written. No change to this agreement shall have any force unless it is signed by a representative who is duly authorized by Yamaha.

10. Jurisdiction

This agreement shall be under the jurisdiction of the laws of Japan, and shall be interpreted according to those laws.

Contents

| | |
|--|-----------|
| Introduction | 9 |
| Features | 9 |
| Related Documents | 10 |
| Terms | 10 |
| Controls and Functions | 11 |
| Front panel | 11 |
| Rear panel..... | 13 |
| Status Indicator Display | 14 |
| LINK/ACT setting | 14 |
| STATUS setting | 14 |
| VLAN setting | 14 |
| OFF setting..... | 14 |
| Initializing the SWP1 | 14 |
| VLAN Use Cases | 15 |
| Redundant Dante connections | 15 |
| Separating control signals from audio signals..... | 15 |
| Specifications | 16 |

Introduction

Thank you for choosing the Yamaha SWP1-8, SWP1-8MMF, or SWP1-16MMF L2 switch.

To take full advantage of the superior functions and performance offered by the SWP1, and to enjoy years of trouble-free use, be sure to read this owner's manual carefully before operation.

This owner's manual is intended to be read by audio networking personnel.

Included items

- **SWP1 Owner's Manual (this book)**
- **Power cord (three-pin plug)**

Option item

- **MMF-SWP1 (optical expansion unit)**

* Installation must be performed by a Yamaha service engineer. Customers must not attempt to perform the installation themselves.

Precautions for Rack Mounting

This unit is rated for operation at ambient temperatures ranging from 0 to 40 degrees Celsius. When mounting the unit with other SWP1 unit(s) or other device(s) in an EIA standard equipment rack, internal temperatures can exceed the specified upper limit, resulting in impaired performance or failure. When rack mounting the unit, always observe the following requirements to avoid heat buildup:

- When mounting the unit in a rack with devices such as power amplifiers that generate a significant amount of heat, leave more than 1U of space between the SWP1 and other equipment. Also either leave the open spaces uncovered or install appropriate ventilating panels to minimize the possibility of heat buildup.
- To ensure sufficient airflow, leave the rear of the rack open and position it at least 10 centimeters from walls or other surfaces. If you've installed a fan kit, there may be cases in which closing the rear of the rack will produce a greater cooling effect. Refer to the rack and/or fan unit manual for details.

Features

- **Recommended settings for Dante are provided**

Recommended settings (such as QoS, EEE, and IGMP Snooping) for stable operation of the Dante network can be specified with only DIP switch.

- **VLAN presets provided**

Three types of preset VLAN settings are provided, allowing a more stable network to be constructed by dividing audio signals and control signals with a single SWP1 unit. The user can also customize the settings.

- **Visualize the network status**

The "Yamaha LAN Monitor" Windows application allows you to monitor the status of the network and the Dante devices. The unit's indicators also show which VLAN is connected to which port.

- **Hardware that supports safety and peace of mind**

All models can be rack-mounted. In consideration of temporary setups or other environments in which cables are liable to be pulled out, etherCON and opticalCON (except the SWP1-8) are provided as standard. In addition to an AC IN jack with V-lock, an XLR-4-32 type EXT DC INPUT jack is also provided. The internal power supply can be backed-up by providing external power (+24V) via this jack.

Related software

If you are using VLAN, connect the computer to the VLAN 1 port.

- **Yamaha LAN Monitor (Windows application)**

This is used to monitor the entire network, including SWP1 data as well as all Dante devices on the Dante network.

Download this application from the following website.
<http://www.yamahaproaudio.com/>

- **Web GUI**

Use this to view or edit the settings of SWP1 units on the network from a web browser.

Access the Web GUI from the Yamaha LAN Monitor.

To use the Web GUI, connect a computer to the VLAN 1 port.

When accessing the Web GUI, the "Windows Security" dialog box may appear. With the factory settings, the administrative password is set as follows.

| | |
|------------------|---------------|
| User name | administrator |
| Password | (blank) |

Related Documents

- **Yamaha LAN Monitor User Guide (PDF)**
This explains installation, settings, and usage of the “Yamaha LAN Monitor” Windows application.
- **Command References (PDF)**
This explains the commands used when making settings from the command line of a computer.
- **Technical Data (HTML)**
This explains details of the SWP1's functions.

These documents can be downloaded from the links in the product page of the following website.
<http://www.yamahaproaudio.com/>

Terms

• VLAN

This stands for Virtual Local Area Network. A virtual network is constructed separately from the physical connections. When there are multiple networks of differing types, setting up a VLAN allows a logically separate network to be constructed that shares the same physical switches.

A VLAN can be either a “Port-based VLAN” which constructs groups using a physical connection for each port, or a “Tag VLAN” which differentiates VLAN groups by assigning a tag to each Ethernet frame. In the case of a port-based VLAN, each VLAN requires a connection to communicate with another switch. Using a tag VLAN allows multiple VLANs to be combined into a single trunk connection (cable) that connects switches, but the total amount of data must not exceed 1 Gbps. The VLAN preset A and B of the SWP1 use tag VLAN.

• Link aggregation

Link aggregation is a function that bundles multiple LAN/SFP ports that connect network devices, and treats them as a single logical interface in order to expand the communication bandwidth. A group that is bundled using link aggregation is called a link aggregation group (LAG).

Link aggregation is a technology that is useful when multiple communications are occurring. The communications can be distributed between the aggregated connections by using a load balancing function. Since load balancing distributes the load according to IP address, we recommend that you fix the IP addresses of each device in order to stabilize load balancing.

Even if a problem occurs on one of the LAN/SFP ports that are bundled by link aggregation, so that this port is unable to communicate, communication will continue via the remaining ports.

• Trunk

This function adds tags to multiple VLANs so that they can be transmitted and received via a single connection. When one SWP1 transmits VLAN 1 data via the trunk connection, the SWP1 unit that receives this will transmit the data only to the port that corresponds to its own VLAN 1.

The bandwidth of the trunk connection for the SWP1's VLAN preset is 1 Gbps per cable. If there is only one cable, and the total bandwidth passing through the trunk connection exceeds 1 Gbps, packets will be delayed or dropped. Some of the SWP1's VLAN presets enable link aggregation of the trunk connection. If the bandwidth will exceed 1 Gbps, or if you want to provide redundancy to guard against cable breakage, you should use two trunk cables.

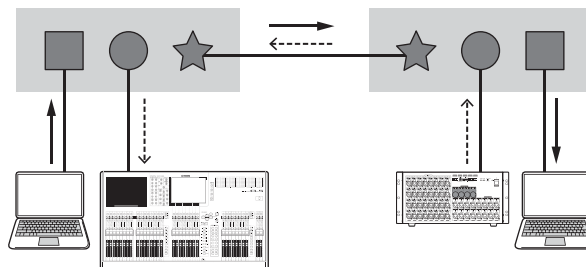
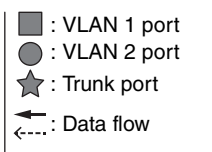

Controls and Functions

Front panel

The explanation here is based on the SWP1-16MMF.

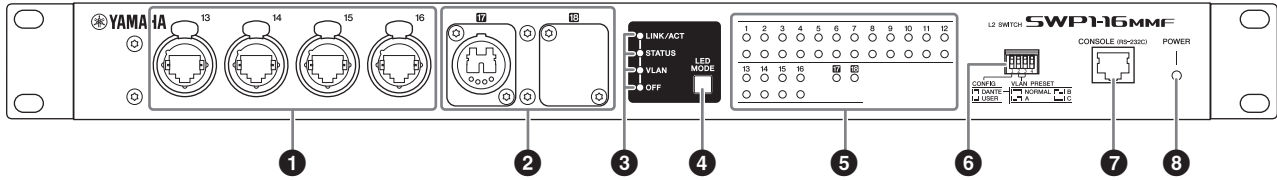

1 LAN ports

These are etherCON (RJ-45) ports for connecting Ethernet cables (CAT5e or better is recommended). A cable with an RJ-45 connector can also be connected. All ports support 1000BASE-T, 100BASE-TX, and 10BASE-T.

2 MMF port

This is an opticalCON DUO port for connecting an optical fiber cable. LC Duplex connectors can also be connected. If you use a cable with an LC Duplex connector, fasten the dust cap attached to the cable connector to prevent dust from adhering when the cable is not in use. You can expand the MMF ports by installing an optional MMF-SWP1 in the location where a cover is attached. Installation of the MMF-SWP1 must be performed by a Yamaha service engineer. Customers must not attempt to perform the installation themselves.

NOTE

- Use an opticalCON DUO multi-mode optical fiber cable made by Neutrik Corporation. Since optical fiber cables are vulnerable to being bent or pulled, you can reduce the occurrence of problems by using a cable that has a strong sheath and is equipped with a locking mechanism.
- Use GI-type multi-mode fiber cables that have a core diameter of approximately 50 μm and cladding diameter of approximately 125 μm . The maximum length between devices is 300 m

Cleaning

Correct communication might not be possible if debris and/or dust has adhered to the ends of optical fiber cables or the ports. Clean the equipment regularly by using commercially available optical fiber cleaning products.

3 LED mode indicators

This indicates what the status indicators are showing.

4 [LED MODE] button

This switches what the status indicators are showing.

5 Status indicators

These indicate the status of each port. The displayed content depends on the mode. For details on the display in each mode, refer to “Status indicator display.”

6 DIP switches

These specify startup settings for the unit. Set the DIP switches when the power is turned off. The settings are not applied if you change the setting while the power is on. The switch illustrations indicate the up/down position as follows.

| Switch position | Status |
|-----------------|--|
| | Represent a status with switch toggled up. |
| | Represent a status with switch toggled down. |

• Switch 1 (CONFIG)

Specifies whether the unit's settings are optimized for a Dante network or are set by the user.

| Switch position | Option | Functions |
|-----------------|--------|--|
| 1 | DANTE | The unit starts up with settings optimized for a Dante network. This setting is read only. |
| 1 | USER | The unit starts up with user settings. This setting can be read or written; when you change the setting, the unit starts up the next time as well with that setting. |

⚠ Caution when using this unit together with another manufacturer's switch

Dante supports both IGMP V2 and V3, but you must set all switches in the same network to operate using the same version.





If the SWP1 starts up with DANTE settings, it operates using IGMP V3. In this case, if the network includes

even one switch that is operating with IGMP V2, problems such as dropouts in the sound might occur.

• Switch 2 and 3 (VLAN PRESET)

Specifies the VLAN preset that is used when switch 1 is in the [DANTE] position. This setting is ignored if switch 1 is set to [USER].

If you change the settings via the web GUI or a command, the settings are applied temporarily but is not stored; the next time the unit starts up, it returns to the VLAN preset setting.

| Switch position | Option | Functions |
|---|--------|---|
|  | NORMAL | The following table shows how the VLAN and trunk are assigned to ports. |
|  | A | |
|  | B | |
|  | C | |

In the tables, “1,” “2,” “Tr1,” and “Tr2” respectively indicate VLAN 1, VLAN 2, trunk (LAG1), and trunk (LAG2).

For an explanation of VLAN, trunk, link aggregation, and LAG, refer to Terms on page 10. For details, you can download technical reference material (HTML).

SWP1-8/SWP1-8MMF

| VLAN PRESET | Rear panel ports | | | |
|-------------|------------------|---|---|---|
| | 1 | 2 | 3 | 4 |
| NORMAL | 1 | 1 | 1 | 1 |
| A (*1) | 1 | 1 | 2 | 2 |
| B (*1) | 1 | 1 | 2 | 2 |
| C (*2) | 1 | 1 | 2 | 2 |

| VLAN PRESET | Front panel ports | | | | | |
|-------------|-------------------|---|-----|-----|-----|-----|
| | 5 | 6 | 7 | 8 | 9 | 10 |
| NORMAL | 1 | 1 | 1 | 1 | 1 | 1 |
| A (*1) | 1 | 1 | 2 | 2 | Tr1 | Tr1 |
| B (*1) | 1 | 2 | Tr1 | Tr1 | Tr2 | Tr2 |
| C (*2) | 1 | 1 | 2 | 2 | 1 | 2 |

SWP1-16MMF

| VLAN PRESET | Rear panel ports | | | | | | | |
|-------------|------------------|---|---|---|---|---|---|---|
| | 1 | 2 | 3 | 4 | 5 | 6 | 7 | 8 |
| NORMAL | 1 | 1 | 1 | 1 | 1 | 1 | 1 | 1 |
| A (*1) | 1 | 1 | 1 | 1 | 1 | 1 | 2 | 2 |
| B (*1) | 1 | 1 | 1 | 1 | 1 | 1 | 2 | 2 |
| C (*2) | 1 | 1 | 1 | 1 | 2 | 2 | 2 | 2 |

| VLAN PRESET | Rear panel ports | | | |
|-------------|------------------|----|----|----|
| | 9 | 10 | 11 | 12 |
| NORMAL | 1 | 1 | 1 | 1 |
| A (*1) | 1 | 1 | 2 | 2 |
| B (*1) | 1 | 1 | 2 | 2 |
| C (*2) | 1 | 1 | 2 | 2 |

| VLAN PRESET | Front panel ports | | | | | |
|-------------|-------------------|----|-----|-----|-----|-----|
| | 13 | 14 | 15 | 16 | 17 | 18 |
| NORMAL | 1 | 1 | 1 | 1 | 1 | 1 |
| A (*1) | 1 | 1 | 2 | 2 | Tr1 | Tr1 |
| B (*1) | 1 | 2 | Tr1 | Tr1 | Tr2 | Tr2 |
| C (*2) | 1 | 1 | 2 | 2 | 1 | 2 |

(*1) In the VLAN presets, the IGMP Snooping function is turned on except for VLAN 2 in presets A and B, preventing multicast communication such as Dante’s multicast flow from being forwarded to unnecessary routes. For this reason, in the case of A or B you should use the VLAN 1 port for audio signals such as Dante, and use the VLAN 2 port for control signals.

(*2) If you use setting C, connect the computer that is using Yamaha LAN Monitor to the VLAN 1 port.

The SWP1-8’s 9 and 10, the SWP1-8MMF’s 10, and the SWP1-16MMF’s 18 are available only if the MMF-SWP1 option is installed.

7 [CONSOLE (RS-232C)] port

This is an RJ-45 port used to specify commands. Use an RJ-45/DB-9 serial cable to connect this to the RS-232C port (COM port) of your computer. Use an RJ-45/DB-9 serial cable that is wired as described in “Specifications.”

8 [POWER] indicator

This is lit when the SWP1 is powered-on.

Rear panel

SWP1-8/SWP1-8MMF

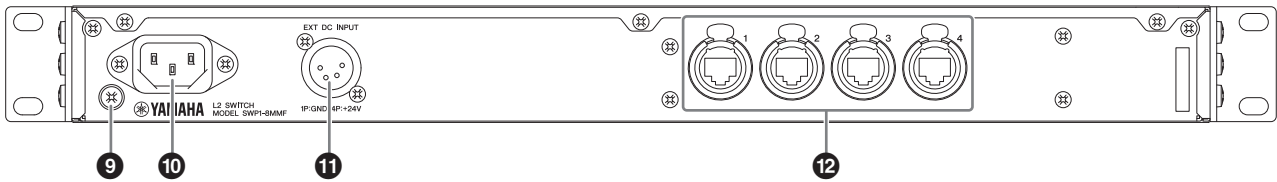

SWP1-16MMF

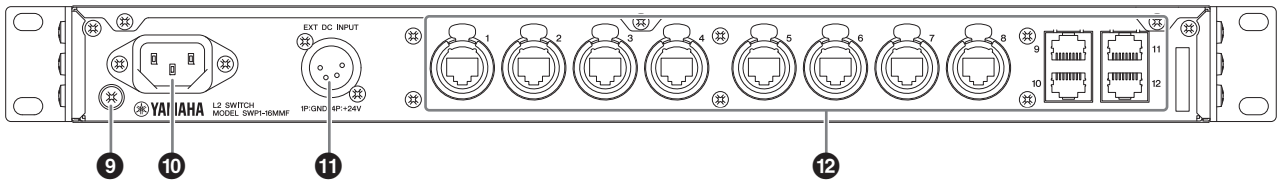

9 Grounding screw

Since the included power cord has a three-pin plug, this unit will be appropriately grounded if the AC outlet is grounded. In some cases, you may be able to reduce hum noise and interference noise by connecting this screw to ground as well.

10 AC IN connector

Connect the included power cord here. First connect the power cord to this unit, and then connect the power supply plug to an AC outlet; the SWP1's internal power supply turns on.

The supplied AC power cord features a V-lock mechanism via a latch, which prevents the power cord from coming off accidentally. Insert the cable plug all the way until it locks in securely.

Press the latch button on the plug to disconnect the power cord.

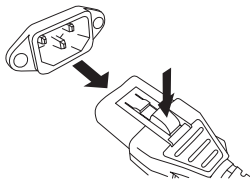

11 [EXT DC INPUT] connector

This is an XLR-4-32 type jack for supplying an external power supply (+24V) as a backup for the SWP1's internal power supply.

⚠ CAUTION

- Before connecting the external power supply, you must turn off the external power supply. Failing to do so may cause electrocution or malfunctions.
- EXT DC INPUT connector is intended to be supplied by Power Supply certified with "Limited Power Source" or "LPS" and rated 24 Vdc.

NOTE

- If an external power supply is connected, the SWP1 will operate normally when its internal power supply and the external power supply are on, as well as when only one is on.
- If both power supplies are on, and one of them is interrupted during operation, the unit will continue to operate normally.

12 LAN ports

These are etherCON (RJ-45) ports for connecting Ethernet cables (CAT5e or better is recommended). A cable with an RJ-45 connector can also be connected.

The SWP1-16MMF's ports 9 through 12 are conventional RJ-45 ports. The others are etherCON (RJ45) ports.

All ports support 1000BASE-T, 100BASE-TX, and 10BASE-T.

Status Indicator Display

The status indicators show different things depending on the LED mode setting.

LINK/ACT setting

The status indicators show each port's link status and connection status.

| Indicator | Illumination | Status |
|-----------|----------------|----------------------------------|
| Upper | Lit green | Link is established. (LINK) |
| | Flashing green | Data is being transferred. (ACT) |
| | Unlit | Link is lost. |
| Lower | Lit green | Connected with 1000BASE-T. |
| | Lit orange | Connected with 100BASE-TX. |
| | Unlit | Connected with 10BASE-T. |

STATUS setting

The status indicators show the loop-related port's status.

| Indicator | Illumination | Status |
|-----------------|-----------------|---|
| Upper and lower | Flashing orange | Loop was detected, and communication is halted. |
| | Unlit | Loop not detected. Or loop was detected, but communication is not halted. |

VLAN setting

The status indicators show the VLAN ID and trunk. If DIP switch 1 is upward ([DANTE]), VLAN 1 is shown by the upper indicator and the lower indicator unlit. VLAN 2 is shown by the upper indicator lit green and the lower indicator unlit. Trunk is shown by upper and lower indicators lit orange.

–: Unlit
G: Lit green
O: Lit orange

| Indicators | 1 | VLAN ID low → high | | | | | | Trunk |
|------------|---|--------------------|---|---|---|---|---|-------|
| Upper | – | G | O | – | – | G | O | O |
| Lower | – | – | – | G | O | O | G | O |

Note

- If a number of VLANs that cannot be completely displayed above is specified, the upper and lower indicators are lit green.
- If multiple VLAN IDs are specified for the same port, the upper and lower indicators are lit orange.

OFF setting

All status indicators are unlit.

Initializing the SWP1

Here's how to initialize the SWP1's internal memory, restoring it to the factory settings.

1. Power-off the SWP1.
2. While pressing and holding down the [LED MODE] button, then power-on the SWP1.
3. The [STATUS] indicator and the [OFF] indicator lit and all status indicators lit orange, release the [LED MODE] button.

Initialization completed, The SWP1 will automatically restart.

CAUTION

Do not turn off the power to the SWP1 during initialization. Otherwise, a malfunction may occur.

NOTE

If initialization failed, contact Yamaha service personnel.

VLAN Use Cases

Redundant Dante connections

This case double the cables between devices as a safeguard against cable breakage. This diagram shows a setup using VLAN preset C.

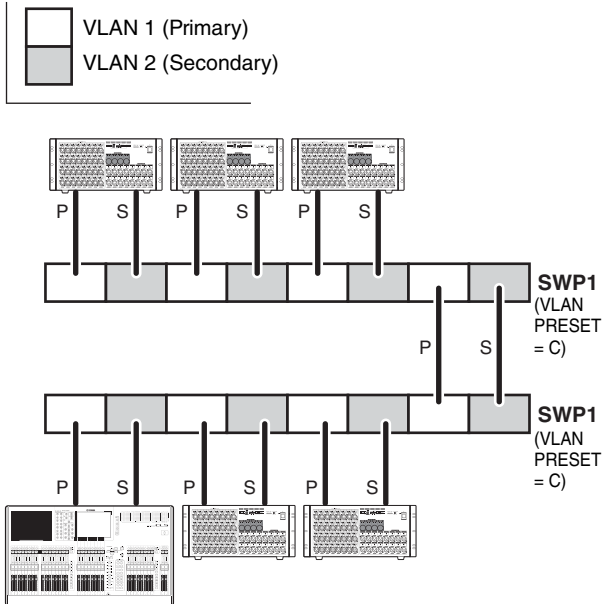

Separating control signals from audio signals

This case logically separates control signals such as Editor or StageMix from Dante's audio signals, making the network more stable. This diagram shows a setup using VLAN preset B.

If VLANs are not used, and control signals and audio signals flow across the same network, the two will compete for communication bandwidth. In order to prevent such an effect, we recommend that you use VLANs to separate the control signal and audio signal networks.

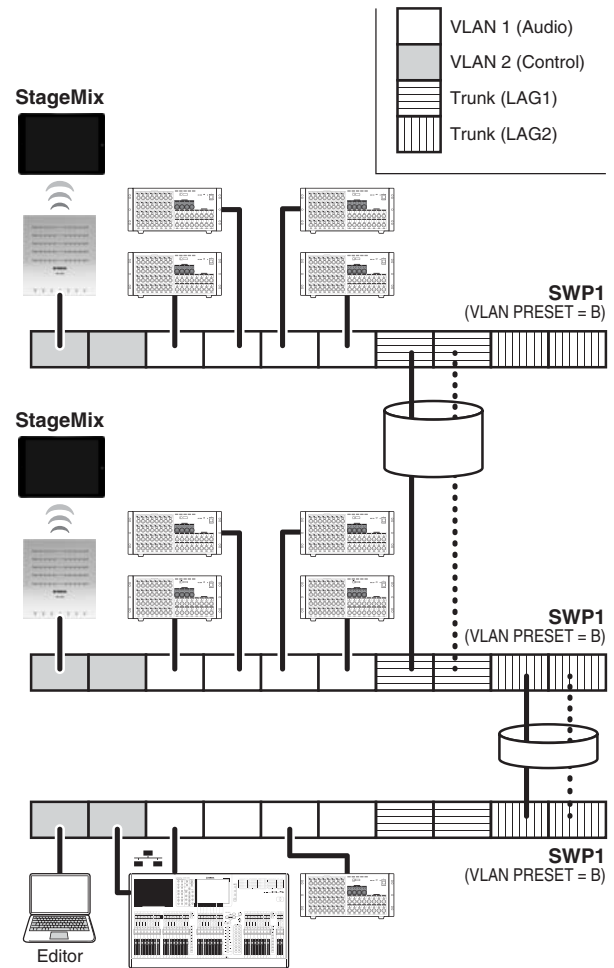

NOTE

In order to use Trunk (LAG2) link aggregation, the optional MMF-SWP1 must be installed.

Specifications

GENERAL SPECIFICATIONS

| PARAMETER | SWP1-8 | SWP1-8MMF | SWP1-16MMF |
|--|---|--------------------------------|---------------------------------|
| Number of LAN ports (1000BASE-T/100BASE-TX/10BASE-T, etherCON connector) | 8 | 8 | 12 |
| Number of LAN ports (1000BASE-T/100BASE-TX/10BASE-T, RJ-45 connector) | 0 | 0 | 4 |
| Amount of SFP ports (1000BASE-SX, opticalCON connector) | 2 (0)* ¹ | 2 (1)* ¹ | 2 (1)* ¹ |
| Console port | 1 (RJ-45) | | |
| Automatic negotiation | Available | | |
| Auto MDI/MDI-X | Available | | |
| Switching capacity | 20 Gbit/s | 20 Gbit/s | 36 Gbit/s |
| Throughput | 15 Mpps | 15 Mpps | 27 Mpps |
| Maximum number of MAC addresses | 16,384 | | |
| Frame buffer | 1,024 KB | | |
| VLAN | Port VLAN, Tag VLAN (IEEE802.1Q), Private VLAN | | |
| Maximum number of VLANs | 256 (VLAN ID 1 – 4,094)* ² | | |
| IP multicast | IGMP Snooping (v1/v2/v3) | | |
| QoS | Each port supports 8 egress queue. Policy-based QoS, Remarking (CoS, ToS, DSCP), Scheduling (SP, WRR) | | |
| Flow control | IEEE802.3x (Full-duplex), back pressure (Half-duplex) | | |
| Support functions | Storm control, HOL blocking prevention, Loop detection, ACL, SNMP agents, Link aggregation (IEEE 802.3ad LACP, Static), Spanning tree (STP* ³ , STP* ³ , MSTP), Port mirroring, Port shutdown, Link speed down shift, Packet counter, Power saving mode (IEEE802.3az EEE; Disabled in DANTE mode), DHCP client, Logging, Firmware download via TFTP/HTTP, Config file download via TFTP | | |
| DIP switches | CONFIG, VLAN PRESET | | |
| Indicators (Front) | POWER, LED MODE×4 | | |
| | PORT×8×2* ⁴ , SFP×2 | PORT×8×2* ⁴ , SFP×2 | PORT×16×2* ⁴ , SFP×2 |
| Operating temperature range | 0 to 40°C | | |
| Storage temperature range | -20 to 60°C | | |
| Power supply (AC IN inlet) | AC100V – 240V, 50/60 Hz, Internal power supply (no power switch) Power supply inlet: locking type | | |
| Power supply (EXT DC INPUT inlet) | 24VDC±2V, 1A, XLR-4-32 type Connector | | |
| Maximum power consumption (Wattage, Current) | 11W 0.21A | 11W 0.21A | 16W 0.29A |
| | 9.5 kcal/h | 9.5 kcal/h | 14.0 kcal/h |
| Body material | Metal case, no fan | | |
| Hazardous substances management | RoHS compliant | | |
| Dimensions (W x H x D) | 480 x 44 x 362 mm (18-7/8" x 1-3/4" x 14-1/4") | | |
| Weight (excluding accessories) | 4.2 kg (9.3 lbs) | 4.2 kg (9.3 lbs) | 4.6 kg (10.1 lbs) |
| Accessories | Power cord, Owner's manual | | |
| Option item | MMF-SWP1 (Optical expansion unit) | | |

*1 The number in parentheses () is the number of SFP ports in which an SFP module is inserted when the unit is shipped.

*2 VLAN ID 1 is the default VLAN ID.

*3 STP and RSTP are supported via downward compatibility of MSTP.

*4 The LED MODE button allows the PORT lamps to be switched between indicating LINK/ACT-SPEED, STATUS, or VLAN.

INTERFACE SPECIFICATIONS

| Terminal | Format | Level | Connector |
|------------------------|-----------|------------------------------------|------------------|
| 1-8 *1 1-8,13-16 *2 *3 | IEEE802.3 | 10BASE-T/100BASE-TX/ 1000BASE-T | etherCON CAT5e |
| 9-12 *2 *3 | IEEE802.3 | 10BASE-T/100BASE-TX/ 1000BASE-T | RJ-45 |
| 9,10 *4 17,18 *5 *8 | IEEE802.3 | 1000BASE-SX | opticalCON |
| CONSOLE (RS-232C) | – | RS-232C | RJ-45 *6 |
| EXT DC INPUT | – | – | XLR-4-32 type *7 |

*1 SWP1-8MMF, SWP1-8

*2 SWP1-16MMF

*3 These terminals support AutoMDI/MDI-X

*4 The SWP1-8MMF supports the option for port 10, and the SWP1-8 supports the option for both ports 9 and 10

*5 The SWP1-16MMF supports the option for port 18

*6 For the pin assignments, refer to CONNECTOR PIN ASSIGNMENTS

*7 Pin 4=+24VDC, pin 1=GND, pins 2 and 3=N.C.

External power supply requirements: 24VDC±2V, 1A

*8 Conforming cable: GI-type multi-mode fiber cables with a core diameter /cladding diameter of approximately 50 µm/125 µm.
Maximum cable length: 300 m

CONNECTOR PIN ASSIGNMENTS

CONSOLE (RS-232C)

| Signal | RJ45 | D-SUB 9 |
|--------|------|---------|
| | | 9 |
| RTS | 1 | 8 |
| DTR | 2 | 6 |
| TxD | 3 | 2 |
| GND | 4 | 5 |
| GND | 5 | |
| RxD | 6 | 3 |
| DSR* | 7 | 4 |
| CTS* | 8 | 7 |
| | | 1 |

* These signals are not used on the SWP1.

Dimensions

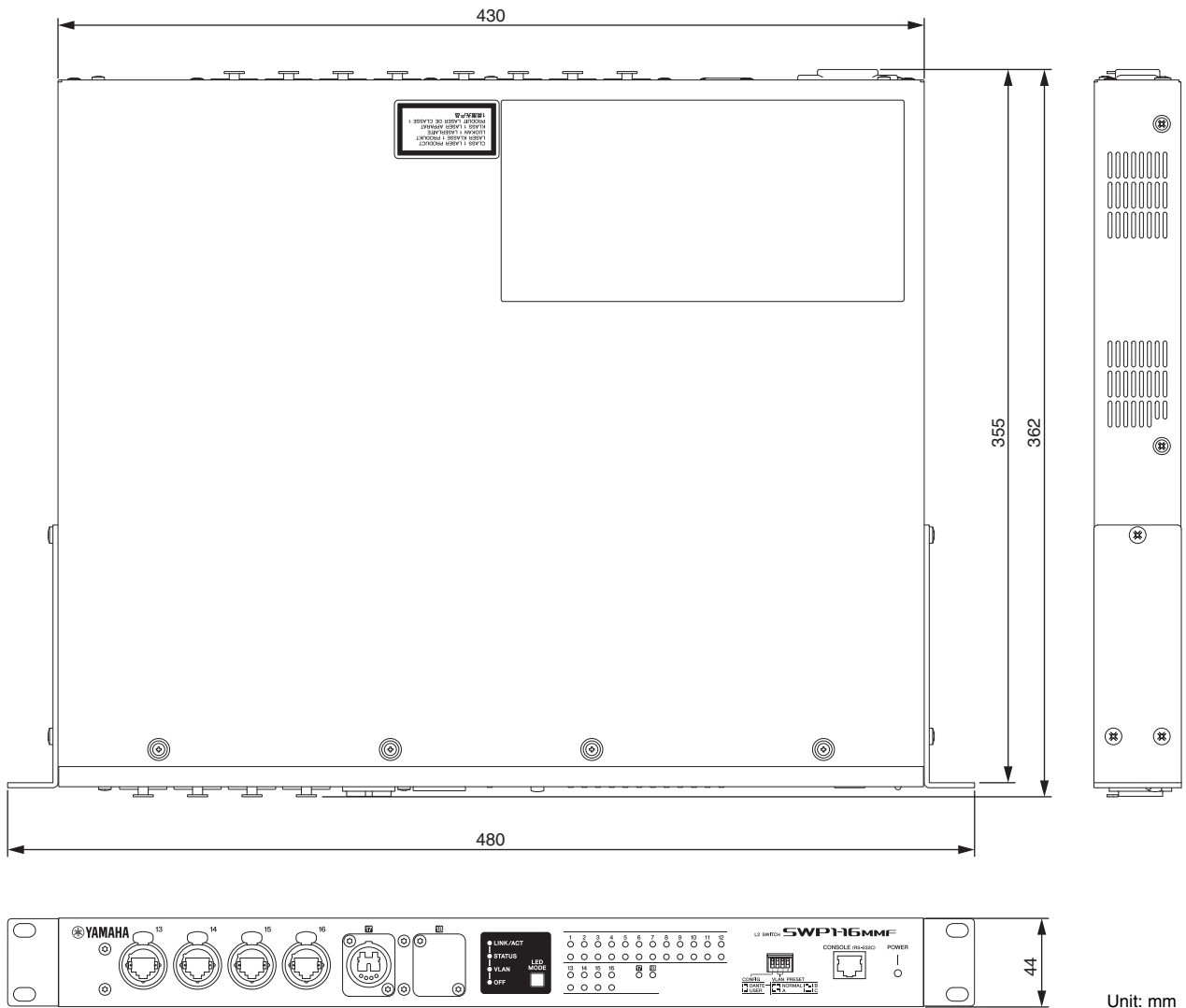

Unit: mm

* The contents of this manual apply to the specifications as of the firmware Rev. 2.01.04. To obtain the latest manual, access the Yamaha website then download the manual file.

Memo

| | |
|-------------------------|--|
| Device Name | |
| IP Address | |
| Web GUI Password | |

| Port | VLAN ID | | | | | | |
|-------------|----------------|--|--|--|--|--|--|
| 1 | | | | | | | |
| 2 | | | | | | | |
| 3 | | | | | | | |
| 4 | | | | | | | |
| 5 | | | | | | | |
| 6 | | | | | | | |
| 7 | | | | | | | |
| 8 | | | | | | | |
| 9 | | | | | | | |
| 10 | | | | | | | |
| 11 | | | | | | | |
| 12 | | | | | | | |
| 13 | | | | | | | |
| 14 | | | | | | | |
| 15 | | | | | | | |
| 16 | | | | | | | |
| 17 | | | | | | | |
| 18 | | | | | | | |

| |
|---------------|
| Others |
|---------------|

Important Notice: Guarantee Information for customers in European Economic Area (EEA) and Switzerland

| | |
|--|-----------------------|
| Important Notice: Guarantee Information for customers in EEA* and Switzerland For detailed guarantee information about this Yamaha product, and Pan-EEA* and Switzerland warranty service, please either visit the website address below (Printable file is available at our website) or contact the Yamaha representative office for your country. * EEA: European Economic Area | English |
| Wichtiger Hinweis: Garantie-Information für Kunden in der EWR* und der Schweiz Für nähere Garantie-Information über dieses Produkt von Yamaha, sowie über den Pan-EWR*- und Schweizer Garantieservice, besuchen Sie bitte entweder die folgend angegebene Internetadresse (eine druckfähige Version befindet sich auch auf unserer Webseite), oder wenden Sie sich an den für Ihr Land zuständigen Yamaha-Vertrieb. *EWR: Europäischer Wirtschaftsraum | Deutsch |
| Remarque importante: informations de garantie pour les clients de l'EEE et la Suisse Pour des informations plus détaillées sur la garantie de ce produit Yamaha et sur le service de garantie applicable dans l'ensemble de l'EEE ainsi qu'en Suisse, consultez notre site Web à l'adresse ci-dessous (le fichier imprimable est disponible sur notre site Web) ou contactez directement Yamaha dans votre pays de résidence. * EEE : Espace Economique Européen | Français |
| Belangrijke mededeling: Garantie-informatie voor klanten in de EER* en Zwitserland Voor gedetailleerde garantie-informatie over dit Yamaha-product en de garantieservice in heel de EER* en Zwitserland, gaat u naar de onderstaande website (u vindt een afdrukbaar bestand op onze website) of neemt u contact op met de vertegenwoordiging van Yamaha in uw land. * EER: Europese Economische Ruimte | Nederlands |
| Aviso importante: información sobre la garantía para los clientes del EEE* y Suiza Para una información detallada sobre este producto Yamaha y sobre el soporte de garantía en la zona EEE* y Suiza, visite la dirección web que se incluye más abajo (la versión del archivo para imprimir esta disponible en nuestro sitio web) o póngase en contacto con el representante de Yamaha en su país. * EEE: Espacio Económico Europeo | Español |
| Avviso importante: informazioni sulla garanzia per i clienti residenti nell'EEA* e in Svizzera Per informazioni dettagliate sulla garanzia relativa a questo prodotto Yamaha e l'assistenza in garanzia nei paesi EEA* e in Svizzera, potete consultare il sito Web all'indirizzo riportato di seguito (è disponibile il file in formato stampabile) oppure contattare l'ufficio di rappresentanza locale della Yamaha. * EEA: Area Economica Europea | Italiano |
| Aviso importante: informações sobre as garantias para clientes da AEE* e da Suíça Para obter uma informação pormenorizada sobre este produto da Yamaha e sobre o serviço de garantia na AEE* e na Suíça, visite o site a seguir (o arquivo para impressão está disponível no nosso site) ou entre em contato com o escritório de representação da Yamaha no seu país. * AEE: Área Económica Européia | Português |
| Σημαντική σημείωση: Πληροφορίες εγγύησης για τους πελάτες στον ΕΟΧ* και Ελλάδα Για λεπτομερείς πληροφορίες εγγύησης σχετικά με το παρόν προϊόν της Yamaha και την κάλυψη εγγύησης σε όλες τις χώρες του ΕΟΧ και την Ελλάδα, επισκεφτείτε την παρακάτω ιστοσελίδα (Εκτυπώσιμη μορφή είναι διαθέσιμη στην ιστοσελίδα μας) ή απευθυνθείτε στην αντιπροσωπεία της Yamaha στη χώρα σας. * ΕΟΧ: Ευρωπαϊκός Οικονομικός Χώρος | Ελληνικά |
| Viktigt: Garantiinformation för kunder i EES-området* och Schweiz För detaljerad information om denna Yamahaprodukt samt garantiservice i hela EES-området* och Schweiz kan du antingen besöka nedanstående webbadress (en utskriftsvänlig fil finns på webbplatsen) eller kontakta Yamahas officiella representant i ditt land. * EES: Europeiska Ekonomiska Samarbetsområdet | Svenska |
| Viktig merknad: Garantiinformasjon for kunder i EØS* og Sveits Detaljert garantiinformasjon om dette Yamaha-produktet og garantiservice for hele EØS-området* og Sveits kan fås enten ved å besøke nettstedene nedenfor (utskriftsversjon finnes på våre nettsider) eller kontakte Yamahas kontoret i landet der du bor. *EØS: Det europeiske økonomiske samarbeidsområdet | Norsk |
| Vigtig oplysning: Garantioplysninger til kunder i EØ* og Schweiz De kan finde detaljerede garantioplysninger om dette Yamaha-produkt og den fælles garantiserviceordning for EØ* (og Schweiz) ved at besøge det websted, der er angivet nedenfor (der findes en fil, som kan udskrives, på vores websted), eller ved at kontakte Yamahas nationale repræsentationskontor i det land, hvor De bor. * EØ: Det Europæiske Økonomiske Område | Dansk |
| Tärkeä ilmoitus: Takuutiedot Euroopan talousalueen (ETA)* ja Sveitsin asiakkaille Tämän Yamaha-tuotteen sekä ETA-alueen ja Sveitsin takuuta koskevat yksityiskohtaiset tiedot saatte alla olevasta nettiosoitteesta. (Tulostettava tiedosto saatavissa sivustollamme.) Voitte myös ottaa yhteyttä paikalliseen Yamaha-edustajaan. *ETA: Euroopan talousalue | Suomi |
| Ważne: Warunki gwarancyjne obowiązujące w EOG* i Szwajcarii Aby dowiedzieć się więcej na temat warunków gwarancyjnych tego produktu firmy Yamaha i serwisu gwarancyjnego w całym EOG* i Szwajcarii, należy odwiedzić wskazaną poniżej stronę internetową (Plik gotowy do wydruku znajduje się na naszej stronie internetowej) lub skontaktować się z przedstawicielstwem firmy Yamaha w swoim kraju. * EOG — Europejski Obszar Gospodarczy | Polski |
| Důležité oznámení: Záruční informace pro zákazníky v EHS* a ve Švýcarsku Podrobné záruční informace o tomto produktu Yamaha a záručním servisu v celém EHS* a ve Švýcarsku naleznete na níže uvedené webové adrese (soubor k tisku je dostupný na našich webových stránkách) nebo se můžete obrátit na zastoupení firmy Yamaha ve své zemi. * EHS: Evropský hospodářský prostor | Česky |
| Fontos figyelmeztetés: Garancia-információk az EGT* területén és Svájcban élő vásárlók számára A jelen Yamaha termékre vonatkozó részletes garancia-információk, valamint az EGT*-re és Svájcra kiterjedő garanciális szolgáltatás tekintetében keresse fel webhelyünket az alábbi címen (a webhelyen nyomtatható fájl is található), vagy pedig lépjen kapcsolatba az országában működő Yamaha képviselői irodával. * EGT: Európai Gazdasági Térség | Magyar |
| Oluline märkus: Garantiiteave Euroopa Majanduspiirkonna (EMP)* ja Šveitsi klientidele Täpsemat teabe saamiseks selle Yamaha toote garantii ning kogu Euroopa Majanduspiirkonna ja Šveitsi garantiiteeninduse kohta, külastage palun veebisaiti alljärgneval aadressil (meie saidil on saadaval printitav fail) või pöörduge Teie regiooni Yamaha esinduse poole. * EMP: Euroopa Majanduspiirkond | Eesti keel |
| Svarīgs paziņojums: garantijas informācija klientiem EEZ* un Šveicē Lai saņemtu detalizētāku garantijas informāciju par šo Yamaha produktu, kā arī garantijas apkalpošanu EEZ* un Šveicē, lūdzu, apmeklējiet zemāk norādīto tīmekļa vietnes adresi (tīmekļa vietnē ir pieejams drukājams fails) vai sazinieties ar jūsu valsti apkalpojošo Yamaha pārstāvniecību. * EEZ: Eiropas Ekonomikas zona | Latviešu |
| Dėmesio: informacija dėl garantijos pirkėjams EEE* ir Šveicarijoje Jeį reikia išsamios informacijos apie šį „Yamaha“ produktą ir jo techninę priežiūrą visoje EEE* ir Šveicarijoje, apsilankykite mūsų svetainėje toliau nurodytu adresu (svetainėje yra spausdintinas failas) arba kreipkitės į „Yamaha“ atstovybę savo šaliai. *EEE – Europos ekonominė erdvė | Lietuvių kalba |
| Dôležité upozornenie: Informácie o záruke pre zákazníkov v EHP* a Švajčiarsku Podrobné informácie o záruke týkajúce sa tohto produktu od spoločnosti Yamaha a garančnom servise v EHP* a Švajčiarsku nájdete na webovej stránke uvedenej nižšie (na našej webovej stránke je k dispozícii súbor na tlač) alebo sa obráťte na zástupcu spoločnosti Yamaha vo svojej krajine. * EHP: Európsky hospodársky priestor | Slovenčina |
| Pomembno obvestilo: Informacije o garanciji za kupce v EGP* in Švici Za podrobnejše informacije o tem Yamahinem izdelku ter garancijskem servisu v celotnem EGP in Švici, obiščite spletno mesto, ki je navedeno spodaj (natisljiva datoteka je na voljo na našem spletnem mestu), ali se obrnite na Yamahinega predstavnika v svoji državi. * EGP: Evropski gospodarski prostor | Slovenščina |
| Важно съобщение: Информация за гаранцията за клиенти в ЕИП* и Швейцария За подробна информация за гаранцията за този продукт на Yamaha и гаранционното обслужване в паневропейската зона на ЕИП* и Швейцария или посетете посочения по-долу уеб сайт (на нашия уеб сайт има файл за печат), или се свържете с представителния офис на Yamaha във вашата страна. * ЕИП: Европейско икономическо пространство | Български език |
| Notificare importantă: Informații despre garanție pentru clienții din SEE* și Elveția Pentru informații detaliate privind acest produs Yamaha și serviciul de garanție Pan-SEE* și Elveția, vizitați site-ul la adresa de mai jos (fișierul imprimabil este disponibil pe site-ul nostru) sau contactați biroul reprezentanței Yamaha din țara dumneavoastră. * SEE: Spațiul Economic European | Limba română |

<http://europe.yamaha.com/warranty/>

ADDRESS LIST

NORTH AMERICA

CANADA

Yamaha Canada Music Ltd.
135 Milner Avenue, Toronto, Ontario,
M1S 3R1, Canada
Tel: +1-416-298-1311

U.S.A.

Yamaha Corporation of America
6600 Orangethorpe Avenue, Buena Park, CA 90620,
U.S.A.
Tel: +1-714-522-9011

CENTRAL & SOUTH AMERICA

MEXICO

Yamaha de México, S.A. de C.V.
Av. Insurgentes Sur 1647 Piso 9, Col. San José
Insurgentes, Delegación Benito Juárez, México,
D.F., C.P. 03900, México
Tel: +52-55-5804-0600

BRAZIL

Yamaha Musical do Brasil Ltda.
Rua Fidêncio Ramos, 302 – Cj 52 e 54 – Torre B – Vila
Olímpia – CEP 04551-010 – São Paulo/SP, Brazil
Tel: +55-11-3704-1377

ARGENTINA

**Yamaha Music Latin America, S.A.,
Sucursal Argentina**
Olga Cossettini 1553, Piso 4 Norte,
Madero Este-C1107CEK,
Buenos Aires, Argentina
Tel: +54-11-4119-7000

PANAMA AND OTHER LATIN AMERICAN COUNTRIES/ CARIBBEAN COUNTRIES

Yamaha Music Latin America, S.A.
Edif. Torre Banco General, Piso 7, Urbanización
Marbella, Calle 47 y Aquilino de la Guardia,
Ciudad de Panamá, República de Panamá
Tel: +507-269-5311

EUROPE

THE UNITED KINGDOM/IRELAND

Yamaha Music Europe GmbH (UK)
Sherbourne Drive, Tilbrook, Milton Keynes,
MK7 8BL, U.K.
Tel: +44-1908-366700

GERMANY

Yamaha Music Europe GmbH
Siemensstrasse 22-34, 25462 Rellingen, Germany
Tel: +49-4101-303-0

SWITZERLAND/LIECHTENSTEIN

**Yamaha Music Europe GmbH, Branch
Switzerland in Thalwil**
Seestrasse 18a, 8800 Thalwil, Switzerland
Tel: +41-44-3878080

AUSTRIA/BULGARIA/ CZECH REPUBLIC/HUNGARY/ ROMANIA/SLOVAKIA/SLOVENIA

**Yamaha Music Europe GmbH
Branch Austria**
Schleiergasse 20, 1100 Wien, Austria
Tel: +43-1-60203900

POLAND/LITHUANIA/LATVIA/ESTONIA

**Yamaha Music Europe GmbH
Sp.z o.o. Oddział w Polsce**
ul. Wielicka 52, 02-657 Warszawa, Poland
Tel: +48-22-880-08-88

MALTA

Olimpus Music Ltd.
Valletta Road, Mosta MST9010, Malta
Tel: +356-2133-2093

NETHERLANDS/BELGIUM/ LUXEMBOURG

Yamaha Music Europe Branch Benelux
Clarissenhof 5b, 4133 AB Vianen, The Netherlands
Tel: +31-347-358040

FRANCE

Yamaha Music Europe
7 rue Ambroise Croizat, Zone d'activités de Pariest,
77183 Croissy-Beaubourg, France
Tel: +33-1-6461-4000

ITALY

Yamaha Music Europe GmbH, Branch Italy
Via Tinelli N.67/69 20855 Gerno di Lesmo (MB),
Italy
Tel: +39-039-9065-1

SPAIN/PORTUGAL

**Yamaha Music Europe GmbH Ibérica, Sucursal
en España**
Ctra. de la Coruna km. 17,200, 28231
Las Rozas de Madrid, Spain
Tel: +34-91-639-88-88

GREECE

Philippos Nakas S.A. The Music House
19th klm. Leof. Lavriou 190 02 Peania – Attiki,
Greece
Tel: +30-210-6686168

SWEDEN/FINLAND/ICELAND

**Yamaha Music Europe GmbH Germany filial
Scandinavia**
JA Wettergrensgata 1, 400 43 Göteborg, Sweden
Tel: +46-31-89-34-00

DENMARK

**Yamaha Music Denmark,
Fillial of Yamaha Music Europe GmbH, Tyskland**
Generatorvej 8C, ST. TH. . 2860 Søborg, Denmark
Tel: +45-44-92-49-00

NORWAY

**Yamaha Music Europe GmbH Germany -
Norwegian Branch**
Grini Næringspark 1, 1332 Østerås, Norway
Tel: +47-6716-7800

RUSSIA

Yamaha Music (Russia) LLC.
Room 37, entrance 7, bld. 7, Kievskaya street,
Moscow, 121059, Russia
Tel: +7-495-626-5005

OTHER EUROPEAN COUNTRIES

Yamaha Music Europe GmbH
Siemensstrasse 22-34, 25462 Rellingen, Germany
Tel: +49-4101-3030

AFRICA

Yamaha Music Gulf FZE
JAFZA-16, Office 512, P.O.Box 17328,
Jebel Ali FZE, Dubai, UAE
Tel: +971-4-801-1500

MIDDLE EAST

TURKEY

**Yamaha Music Europe GmbH
Merkezi Almanya Türkiye İstanbul Şubesi**
Maslak Meydanı Sokak, Spring Giz Plaza Bagimsiz
Böl. No:3, Sariyer Istanbul, Turkey
Tel: +90-212-999-8010

CYPRUS

Yamaha Music Europe GmbH
Siemensstrasse 22-34, 25462 Rellingen, Germany
Tel: +49-4101-303-0

OTHER COUNTRIES

Yamaha Music Gulf FZE
JAFZA-16, Office 512, P.O.Box 17328,
Jebel Ali FZE, Dubai, UAE
Tel: +971-4-801-1500

ASIA

THE PEOPLE'S REPUBLIC OF CHINA

Yamaha Music & Electronics (China) Co.,Ltd.
2F, Yunhedasha, 1818 Xinzha-lu, Jingan-qu,
Shanghai, China
Tel: +86-400-051-7700

INDIA

Yamaha Music India Private Limited
P-401, JMD Megapolis, Sector-48, Sohna Road,
Gurgaon-122018, Haryana, India
Tel: +91-124-485-3300

INDONESIA

PT. Yamaha Musik Indonesia (Distributor)
Yamaha Music Center Bldg. Jalan Jend. Gatot
Subroto Kav. 4, Jakarta 12930, Indonesia
Tel: +62-21-520-2577

KOREA

Yamaha Music Korea Ltd.
8F, Dongsung Bldg. 21, Teheran-ro 87-gil,
Gangnam-gu, Seoul, 06169, Korea
Tel: +82-2-3467-3300

MALAYSIA

Yamaha Music (Malaysia) Sdn. Bhd.
No.8, Jalan Perbandaran, Kelana Jaya, 47301
Petaling Jaya, Selangor, Malaysia
Tel: +60-3-78030900

SINGAPORE

Yamaha Music (Asia) Private Limited
Block 202 Hougang Street 21, #02-00,
Singapore 530202, Singapore
Tel: +65-6740-9200

TAIWAN

Yamaha Music & Electronics Taiwan Co.,Ltd.
2F., No.1, Yuandong Rd., Banqiao Dist.,
New Taipei City 22063, Taiwan (R.O.C.)
Tel: +886-2-7741-8888

THAILAND

Siam Music Yamaha Co., Ltd.
3, 4, 15, 16th Fl., Siam Motors Building,
891/1 Rama 1 Road, Wangmai,
Pathumwan, Bangkok 10330, Thailand
Tel: +66-2215-2622

VIETNAM

Yamaha Music Vietnam Company Limited
15th Floor, Nam A Bank Tower, 201-203 Cach
Mang Thang Tam St., Ward 4, Dist.3,
Ho Chi Minh City, Vietnam
Tel: +84-8-3818-1122

OTHER ASIAN COUNTRIES

**Yamaha Corporation
Sales & Marketing Division**
10-1, Nakazawa-cho, Naka-ku, Hamamatsu,
Japan 430-8650
Tel: +81-53-460-2312

OCEANIA

AUSTRALIA

Yamaha Music Australia Pty. Ltd.
Level 1, 99 Queensbridge Street, Southbank,
VIC 3006, Australia
Tel: +61-3-9693-5111

COUNTRIES AND TRUST TERRITORIES IN PACIFIC OCEAN

**Yamaha Corporation
Sales & Marketing Division**
10-1, Nakazawa-cho, Naka-ku, Hamamatsu,
Japan 430-8650
Tel: +81-53-460-2312

Free Manuals Download Website

<http://myh66.com>

<http://usermanuals.us>

<http://www.somanuals.com>

<http://www.4manuals.cc>

<http://www.manual-lib.com>

<http://www.404manual.com>

<http://www.luxmanual.com>

<http://aubethermostatmanual.com>

Golf course search by state

<http://golfingnear.com>

Email search by domain

<http://emailbydomain.com>

Auto manuals search

<http://auto.somanuals.com>

TV manuals search

<http://tv.somanuals.com>