



Tio1608-D

I/O RACK

Owner's Manual

Bedienungsanleitung

Mode d'emploi

Manual de instrucciones

Manual do Proprietário

Manuale di istruzioni

Руководство пользователя

取扱説明書

EN

DE

FR

ES

PT

IT

RU

JA

English

Deutsch

Français

Español

Português

Italiano

Русский

日本語

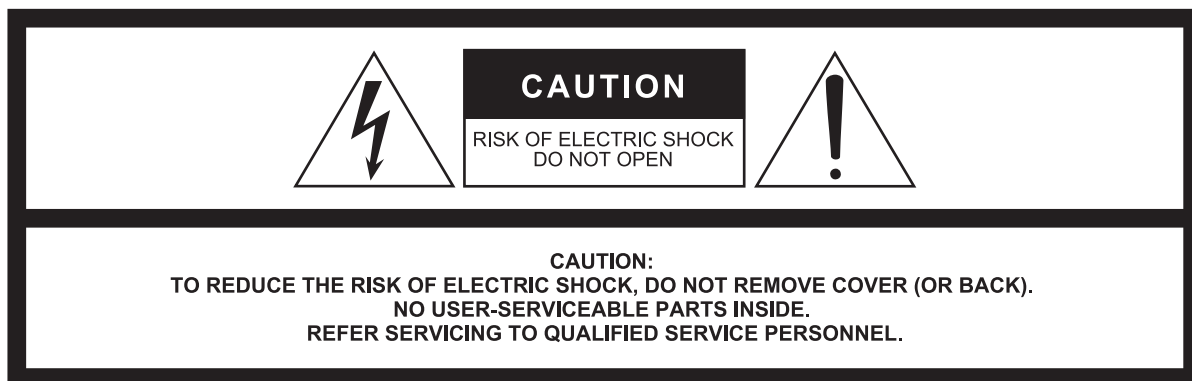

The above warning is located on the *rear* of the unit.
L'avertissement ci-dessus est situé sur l'*arrière* de l'unité.

Explanation of Graphical Symbols Explication des symboles



The lightning flash with arrowhead symbol within an equilateral triangle is intended to alert the user to the presence of uninsulated “dangerous voltage” within the product’s enclosure that may be of sufficient magnitude to constitute a risk of electric shock to persons.

L'éclair avec une flèche à l'intérieur d'un triangle équilatéral est destiné à attirer l'attention de l'utilisateur sur la présence d'une « tension dangereuse » non isolée à l'intérieur de l'appareil, pouvant être suffisamment élevée pour constituer un risque d'électrocution.



The exclamation point within an equilateral triangle is intended to alert the user to the presence of important operating and maintenance (servicing) instructions in the literature accompanying the product.

Le point d'exclamation à l'intérieur d'un triangle équilatéral est destiné à attirer l'attention de l'utilisateur sur la présence d'instructions importantes sur l'emploi ou la maintenance (réparation) de l'appareil dans la documentation fournie.

IMPORTANT SAFETY INSTRUCTIONS

- 1 Read these instructions.
- 2 Keep these instructions.
- 3 Heed all warnings.
- 4 Follow all instructions.
- 5 Do not use this apparatus near water.
- 6 Clean only with dry cloth.
- 7 Do not block any ventilation openings. Install in accordance with the manufacturer's instructions.
- 8 Do not install near any heat sources such as radiators, heat registers, stoves, or other apparatus (including amplifiers) that produce heat.
- 9 Do not defeat the safety purpose of the polarized or grounding-type plug. A polarized plug has two blades with one wider than the other. A grounding type plug has two blades and a third grounding prong. The wide blade or the third prong are provided for your safety. If the provided plug does not fit into your outlet, consult an electrician for replacement of the obsolete outlet.
- 10 Protect the power cord from being walked on or pinched particularly at plugs, convenience receptacles, and the point where they exit from the apparatus.
- 11 Only use attachments/accessories specified by the manufacturer.
- 12 Use only with the cart, stand, tripod, bracket, or table specified by the manufacturer, or sold with the apparatus. When a cart is used, use caution when moving the cart/apparatus combination to avoid injury from tip-over.
- 13 Unplug this apparatus during lightning storms or when unused for long periods of time.
- 14 Refer all servicing to qualified service personnel. Servicing is required when the apparatus has been damaged in any way, such as power-supply cord or plug is damaged, liquid has been spilled or objects have fallen into the apparatus, the apparatus has been exposed to rain or moisture, does not operate normally, or has been dropped.



WARNING

TO REDUCE THE RISK OF FIRE OR ELECTRIC SHOCK, DO NOT EXPOSE THIS APPARATUS TO RAIN OR MOISTURE.

(UL60065_03)

PRÉCAUTIONS CONCERNANT LA SÉCURITÉ

- 1 Lire ces instructions.
- 2 Conserver ces instructions.
- 3 Tenir compte de tous les avertissements.
- 4 Suivre toutes les instructions.
- 5 Ne pas utiliser ce produit à proximité d'eau.
- 6 Nettoyer uniquement avec un chiffon propre et sec.
- 7 Ne pas bloquer les orifices de ventilation. Installer l'appareil conformément aux instructions du fabricant.
- 8 Ne pas installer l'appareil à proximité d'une source de chaleur comme un radiateur, une bouche de chaleur, un poêle ou tout autre appareil (y compris un amplificateur) produisant de la chaleur.
- 9 Ne pas modifier le système de sécurité de la fiche polarisée ou de la fiche de terre. Une fiche polarisée dispose de deux broches dont une est plus large que l'autre. Une fiche de terre dispose de deux broches et d'une troisième pour le raccordement à la terre. Cette broche plus large ou cette troisième broche est destinée à assurer la sécurité de l'utilisateur. Si la fiche équipant l'appareil n'est pas compatible avec les prises de courant disponibles, faire remplacer les prises par un électricien.
- 10 Acheminer les cordons d'alimentation de sorte qu'ils ne soient pas piétinés ni coincés, en faisant tout spécialement attention aux fiches, prises de courant et au point de sortie de l'appareil.
- 11 Utiliser exclusivement les fixations et accessoires spécifiés par le fabricant.
- 12 Utiliser exclusivement le chariot, le stand, le trépied, le support ou la table recommandés par le fabricant ou vendus avec cet appareil. Si l'appareil est posé sur un chariot, déplacer le chariot avec précaution pour éviter tout risque de chute et de blessure.
- 13 Débrancher l'appareil en cas d'orage ou lorsqu'il doit rester hors service pendant une période prolongée.
- 14 Confier toute réparation à un personnel qualifié. Faire réparer l'appareil s'il a subi tout dommage, par exemple si la fiche ou le cordon d'alimentation est endommagé, si du liquide a coulé ou des objets sont tombés à l'intérieur de l'appareil, si l'appareil a été exposé à la pluie ou à de l'humidité, si l'appareil ne fonctionne pas normalement ou est tombé.



AVERTISSEMENT

POUR RÉDUIRE LES RISQUES D'INCENDIE OU DE DÉCHARGE ÉLECTRIQUE, N'EXPOSEZ PAS CET APPAREIL À LA PLUIE OU À L'HUMIDITÉ.

(UL60065_03)

FCC INFORMATION (U.S.A.)

1. IMPORTANT NOTICE: DO NOT MODIFY THIS UNIT!

This product, when installed as indicated in the instructions contained in this manual, meets FCC requirements. Modifications not expressly approved by Yamaha may void your authority, granted by the FCC, to use the product.

2. IMPORTANT:

When connecting this product to accessories and/or another product use only high quality shielded cables. Cable/s supplied with this product MUST be used. Follow all installation instructions. Failure to follow instructions could void your FCC authorization to use this product in the USA.

3. NOTE:

This product has been tested and found to comply with the requirements listed in FCC Regulations, Part 15 for Class "B" digital devices. Compliance with these requirements provides a reasonable level of assurance that your use of this product in a residential environment will not result in harmful interference with other electronic devices. This equipment generates/uses radio frequencies and, if not installed and used according to the instructions found in the users manual, may cause interference harmful to the operation of other electronic devices. Compliance with FCC

regulations does not guarantee that interference will not occur in all installations. If this product is found to be the source of interference, which can be determined by turning the unit "OFF" and "ON", please try to eliminate the problem by using one of the following measures:

Relocate either this product or the device that is being affected by the interference.

Utilize power outlets that are on different branch (circuit breaker or fuse) circuits or install AC line filter/s.

In the case of radio or TV interference, relocate/reorient the antenna. If the antenna lead-in is 300 ohm ribbon lead, change the lead-in to co-axial type cable.

If these corrective measures do not produce satisfactory results, please contact the local retailer authorized to distribute this type of product. If you can not locate the appropriate retailer, please contact Yamaha Corporation of America, Electronic Service Division, 6600 Orangethorpe Ave, Buena Park, CA90620

The above statements apply ONLY to those products distributed by Yamaha Corporation of America or its subsidiaries.

* This applies only to products distributed by YAMAHA CORPORATION OF AMERICA.

(class B)

In Finland: Laite on liitettävä suojamaadoituskoskettimilla varustettuun pistorasiaan.

In Norway: Apparatet må tilkoples jordet stikkontakt.

In Sweden: Apparaten skall anslutas till jordat uttag.

(class I hokuo)

COMPLIANCE INFORMATION STATEMENT (DECLARATION OF CONFORMITY PROCEDURE)

Responsible Party : Yamaha Corporation of America
Address : 6600 Orangethorpe Ave., Buena Park,
Calif. 90620
Telephone : 714-522-9011
Type of Equipment : I/O RACK
Model Name : Tio1608-D

This device complies with Part 15 of the FCC Rules.
Operation is subject to the following two conditions:
1) this device may not cause harmful interference, and
2) this device must accept any interference received including interference that may cause undesired operation.
See user manual instructions if interference to radio reception is suspected.

* This applies only to products distributed by
YAMAHA CORPORATION OF AMERICA

(FCC DoC)

IMPORTANT NOTICE FOR THE UNITED KINGDOM Connecting the Plug and Cord

WARNING: THIS APPARATUS MUST BE EARTHED
IMPORTANT. The wires in this mains lead are coloured in accordance with the following code:

GREEN-AND-YELLOW	: EARTH
BLUE	: NEUTRAL
BROWN	: LIVE

As the colours of the wires in the mains lead of this apparatus may not correspond with the coloured markings identifying the terminals in your plug proceed as follows:

The wire which is coloured GREEN-and-YELLOW must be connected to the terminal in the plug which is marked by the letter E or by the safety earth symbol  or colored GREEN or GREEN-and-YELLOW.

The wire which is coloured BLUE must be connected to the terminal which is marked with the letter N or coloured BLACK.

The wire which is coloured BROWN must be connected to the terminal which is marked with the letter L or coloured RED.

(3 wires)

이 기기는 가정용 (B급) 전자파적합기기로서 주로 가정에서 사용하는 것을 목적으로 하며, 모든 지역에서 사용할 수 있습니다.

(class b korea)

- Included items 5
- PRECAUTIONS 6**
- Introduction 8**
 - Main features 8
 - Updating the firmware 8
 - Dante support 8
 - Precautions when rackmounting 8
 - Recessed Installation 8
- Device features 9**
 - Front panel 9
 - Rear panel 11
- Connection methods 13**
 - Quick Config (automatic setup) 13
 - Manual setup 14
 - Head amp control 14
- Troubleshooting 15**
 - Troubleshooting 15
- How to read the indicators 16**
- Specifications 119**
 - General Specifications 119
 - Input Output Digital I/O Character 120
 - Dimensions 121

Included items

- Owner's Manual (this document)
- Power cord
- Rubber feet x4

Information for Users on Collection and Disposal of Old Equipment



This symbol on the products, packaging, and/or accompanying documents means that used electrical and electronic products should not be mixed with general household waste. For proper treatment, recovery and recycling of old products, please take them to applicable collection points, in accordance with your national legislation and the Directives 2002/96/EC.

By disposing of these products correctly, you will help to save valuable resources and prevent any potential negative effects on human health and the environment which could otherwise arise from inappropriate waste handling.

For more information about collection and recycling of old products, please contact your local municipality, your waste disposal service or the point of sale where you purchased the items.

[For business users in the European Union]

If you wish to discard electrical and electronic equipment, please contact your dealer or supplier for further information.

[Information on Disposal in other Countries outside the European Union]

This symbol is only valid in the European Union. If you wish to discard these items, please contact your local authorities or dealer and ask for the correct method of disposal.

The model number, serial number, power requirements, etc., may be found on or near the name plate, which is at the rear of the unit. You should note this serial number in the space provided below and retain this manual as a permanent record of your purchase to aid identification in the event of theft.

Model No. _____

Serial No. _____

(rear_en_01)

(weee_eu_en_01)

PRECAUTIONS

PLEASE READ CAREFULLY BEFORE PROCEEDING

Please keep this manual in a safe place for future reference.



WARNING

Always follow the basic precautions listed below to avoid the possibility of serious injury or even death from electrical shock, short-circuiting, damages, fire or other hazards. These precautions include, but are not limited to, the following:

Power supply/power cord

- Do not place the power cord near heat sources such as heaters or radiators, and do not excessively bend or otherwise damage the cord, place heavy objects on it, or place it in a position where anyone could walk on, trip over, or roll anything over it.
- Only use the voltage specified as correct for the device. The required voltage is printed on the name plate of the device.
- Use only the supplied power cord/plug.
If you intend to use the device in an area other than in the one you purchased, the included power cord may not be compatible. Please check with your Yamaha dealer.
- Check the electric plug periodically and remove any dirt or dust which may have accumulated on it.
- When setting up the device, make sure that the AC outlet you are using is easily accessible. If some trouble or malfunction occurs, immediately turn off the power switch and disconnect the plug from the outlet. Even when the power switch is turned off, as long as the power cord is not unplugged from the wall AC outlet, the device will not be disconnected from the power source.
- Remove the electric plug from the outlet when the device is not to be used for extended periods of time, or during electrical storms.
- Be sure to connect to an appropriate outlet with a protective grounding connection. Improper grounding can result in electrical shock, damage to the device(s), or even fire.

Do not open

- This device contains no user-serviceable parts. Do not open the device or attempt to disassemble the internal parts or modify them in any way. If it should appear to be malfunctioning, discontinue use immediately and have it inspected by qualified Yamaha service personnel.

Water warning

- Do not expose the device to rain, use it near water or in damp or wet conditions, or place on it any containers (such as vases, bottles or glasses) containing liquids which might spill into any openings. If any liquid such as water seeps into the device, turn off the power immediately and unplug the power cord from the AC outlet. Then have the device inspected by qualified Yamaha service personnel.
- Never insert or remove an electric plug with wet hands.

Hearing loss

- When turning on the AC power in your audio system, always turn on the power amplifier LAST, to avoid hearing loss and speaker damage. When turning the power off, the power amplifier should be turned off FIRST for the same reason.

Fire warning

- Do not place any burning items or open flames near the device, since they may cause a fire.

If you notice any abnormality

- If any of the following problems occur, immediately turn off the power switch and disconnect the electric plug from the outlet.
 - The power cord or plug becomes frayed or damaged.
 - Unusual smells or smoke are emitted.
 - Some object has been dropped into the device.
 - There is a sudden loss of sound during use of the device.
 - Cracks or other visible damage appear on the device.
 Then have the device inspected or repaired by qualified Yamaha service personnel.
- If this device should be dropped or damaged, immediately turn off the power switch, disconnect the electric plug from the outlet, and have the device inspected by qualified Yamaha service personnel.



CAUTION

Always follow the basic precautions listed below to avoid the possibility of physical injury to you or others, or damage to the device or other property. These precautions include, but are not limited to, the following:

Power supply/power cord

- When removing the electric plug from the device or an outlet, always hold the plug itself and not the cord. Pulling by the cord can damage it.

Location

- Do not place the device in an unstable position where it might accidentally fall over and cause injuries.
- Do not block the vents. This device has ventilation holes at the front/rear/sides to prevent the internal temperature from becoming too high. In particular, do not place the device on its side or upside down. Inadequate ventilation can result in overheating, possibly causing damage to the device(s), or even fire.
- Do not place the device in a location where it may come into contact with corrosive gases or salt air. Doing so may result in malfunction.
- Before moving the device, remove all connected cables.
- If the device is mounted in an EIA standard rack, carefully read the section "Precautions when rackmounting" on page 8. Inadequate ventilation can result in overheating, possibly causing damage to the device(s), malfunction, or even fire.

Connections

- Before connecting the device to other devices, turn off the power for all devices. Also, before turning the power of all devices on or off, make sure that all volume levels are set to the minimum. Failing to do so may result in electric shock, hearing loss, or equipment damage.

Maintenance

- Remove the power plug from the AC outlet when cleaning the device.

Handling caution

- Do not insert your fingers or hands in any gaps or openings on the device (vents, ports, etc.).
- Avoid inserting or dropping foreign objects (paper, plastic, metal, etc.) into any gaps or openings on the device (vents, panel, etc.) If this happens, immediately turn off the power, unplug the power cord from the AC outlet, and have the device inspected by qualified Yamaha service personnel.
- Do not rest your weight on the device or place heavy objects on it, and avoid use excessive force on the buttons, switches or connectors to prevent injuries.

Yamaha cannot be held responsible for damage caused by improper use or modifications to the device.

NOTICE

To avoid the possibility of malfunction/ damage to the product, damage to data, or damage to other property, follow the notices below.

Handling and maintenance

- Do not use the device in the vicinity of a TV, radio, stereo equipment, mobile phone, or other electric devices. Otherwise, the device, TV, or radio may generate noise.
- Do not expose the device to excessive dust or vibration, or extreme cold or heat (such as in direct sunlight, near a heater, or in a car during the day), in order to prevent the possibility of panel disfiguration, unstable operation, or damage to the internal components.
- Do not place vinyl, plastic or rubber objects on the device, since this might discolor the panel.
- When cleaning the device, use a dry and soft cloth. Do not use paint thinners, solvents, cleaning fluids, or chemical-impregnated wiping cloths.
- Condensation can occur in the device due to rapid, drastic changes in ambient temperature—when the device is moved from one location to another, or air conditioning is turned on or off, for example. Using the device while condensation is present can cause damage. If there is reason to believe that condensation might have occurred, leave the device for several hours without turning on the power until the condensation has completely dried out.
- The rubber feet included in this package can be attached to the speaker to prevent slippage when it is to be used on a slippery surface.
- Always turn the power off when the device is not in use.

Connectors

- XLR-type connectors are wired as follows (IEC60268 standard): pin 1: ground, pin 2: hot (+), and pin 3: cold (-).

Information

About this manual

- The illustrations and LCD screens as shown in this manual are for instructional purposes only.
- The company names and product names in this manual are the trademarks or registered trademarks of their respective companies.
- Software may be revised and updated without prior notice.

European models

Purchaser/User Information specified in EN55103-2:2009.

Conforms to Environments: E1, E2, E3 and E4

Thank you for purchasing the Yamaha Tio1608-D I/O rack. The Tio1608-D is an I/O rack that features 16 channels of analog inputs and 8 channels of analog outputs.

In order to take full advantage of this product's features, and to enjoy years of trouble-free use, please read this document before you begin using the product. After you have read this document, please keep it in a safe place.

Main features

- **Quick Config makes it easy to create a system based on the Yamaha TF Series Digital Mixing Console**
Simply install an NY64-D card into your TF series mixing console, and then use Quick Config to create a system using up to three Tio1608-D racks.
- **Remote control of the built-in head amps**
You can use a TF series mixing console or other compatible device to control the built-in head amps.
- **Combination jacks provide versatile connectivity**
The analog inputs use combination jacks that allow for a wide range of applications.

Updating the firmware

The firmware contained in this product can be updated to take advantage of new features, feature improvements, and bug fixes. The product uses two types of firmware.

- Main unit firmware
- Dante module firmware

Details about updating the firmware are available online.

<http://www.yamahaproaudio.com/>

For information about updating and setting up the console, please refer to the firmware update guide available on the website.

NOTE

When updating this product's Dante module firmware, make sure you also update the Dante module firmware contained in other connected devices.

Dante support

This product uses the Dante digital audio network protocol to send and receive audio signals. Dante is a protocol developed by Audinate that is designed to deliver multichannel audio signals at various sampling and bit rates, as well as device control signals over a Gigabit Ethernet network.

For information about Dante, please visit the Audinate website.

<http://www.audinate.com/>

You can also find information about Dante and Dante-compatible products on the Yamaha Pro Audio website.

<http://www.yamahaproaudio.com/>

Precautions when rackmounting

This product is designed to function in environments with a temperature of 0 to 40°C. If you install this product together with multiple units of the same device or other devices in a standard EIA rack, the heat produced by the devices may raise the ambient temperature inside the rack enclosure to the point where performance is affected. To ensure that the heat produced by this product can be dissipated appropriately, please ensure the following conditions when rackmounting it.

- When mounting the unit in a rack with devices such as power amplifiers that generate a significant amount of heat, leave at least 1U of unused space between the unit and the other device.
Additionally, install a ventilation panel in this unused space or leave it open to ensure adequate cooling.
- To ensure sufficient airflow, leave the back of the rack open and position it at least 10 centimeters from walls or other surfaces.
If the back of the rack cannot be left open, install a commercially available fan or similar ventilating option to secure sufficient airflow.
If you install a fan kit, there may be cases in which closing the back of the rack will produce a greater cooling effect. Refer to the documentation included with the rack and/or fan unit details.

Recessed Installation

If you want to recess the front panel surface of the device from the front edge of the rack, you can adjust the position of the rack mount brackets to recess the device by 50mm, as shown in the illustration below.

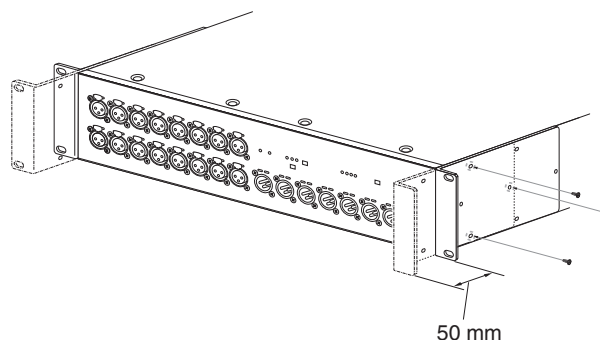

NOTE

When you install the brackets, use the same screws that you just removed.

Front panel

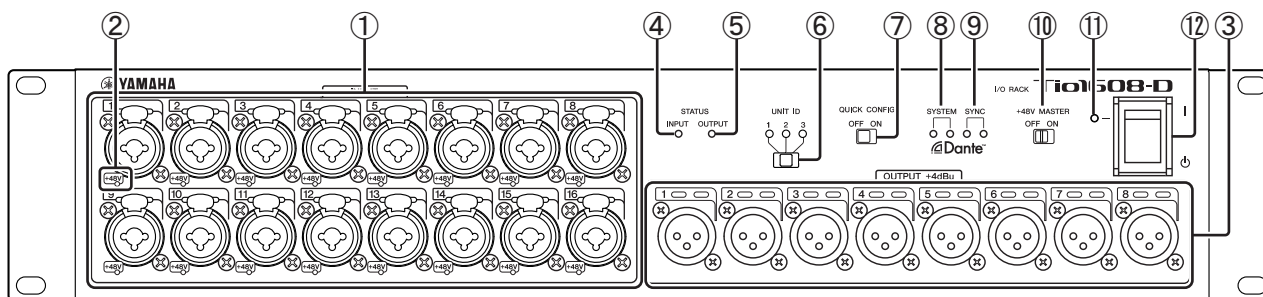

① [INPUT] jacks 1–16

Combination jacks that support both XLR and TRS phone connectors. Use these jacks to connect mics and instruments.

Nominal input level is -62 dBu to +10 dBu.

When connecting a cable that uses an XLR plug, make sure you supply +48 V phantom power to any devices that require it.

NOTE

The PAD will be switched on or off internally when the analog gain of the internal head amp is adjusted between +17dB and +18dB. When using phantom power, noise may be generated if there is a difference in the impedance between the hot and cold of the device connected to an input jack.

② [+48V] indicators

These indicators light when +48 V phantom power is turned on for the corresponding input channels. You can use a compatible mixing console or other device to turn phantom power on and off. If the [+48V MASTER] switch is turned off, no phantom power will be supplied even if phantom power is turned on for individual channels (although the +48V indicators will still flash).

⚠ Caution

- Make sure that phantom power is turned off unless it is needed.
- When turning on phantom power, make sure that no equipment other than phantom-powered devices such as condenser microphones are connected to the corresponding [INPUT] jacks. Supplying phantom power to a device that does not require it can damage the device.
- Do not connect or disconnect a device while phantom power is being supplied to it. Doing so can damage the connected device and the unit itself.
- To prevent damage to speakers, make sure that power amplifiers and powered speakers are turned off when turning phantom power on or off. We also recommend setting all digital mixing console output controls to their minimum settings when turning phantom power on or off. Sudden high-volume sound caused by turning phantom power on or off could damage equipment and hearing.

③ [OUTPUT +4dBu] jacks 1–8

These XLR-3-32 type balanced connectors deliver analog output from the unit's corresponding output channels. Nominal output level is +4 dBu.

NOTICE

If this product's balanced outputs are connected to an unbalanced audio source, a difference in ground potential may result that could cause a malfunction. Make sure each device has the same ground potential. The cable used to connect an unbalanced device should be pin 1: ground, pin 3: cold.

④ [STATUS INPUT] indicator

This indicator indicates the status of the signal being input to the analog input jacks.

If the signal input to any channel reaches or exceeds -34 dBFS, the indicator lights in green; if the signal reaches or exceeds -3 dBFS, the indicator lights in red. The indicator flashes in red if the input is muted, if the system clock is being synced, or if there is a system error.

⑤ [STATUS OUTPUT] indicator

If the signal level of any analog output jack reaches or exceeds -34 dBFS, this indicator lights in green.

The indicator flashes in red if the output is muted, if the system clock is being synced, or if there is a system error.

⑥ [UNIT ID] switch

Determines the unit's identifier (i.e., unit ID) when using Quick Config. When using multiple units, set a unique ID (1–3) to each unit.

When not using Quick Config, this switch and the DIP switches on the rear of the unit determine the ID. (→page 11)

Turn the unit off before changing the [UNIT ID] switch position. If you move the switch while the unit is turned on, the new switch position is not applied. See "Connection methods" (→page 13) for information about Quick Config.

⑦ [QUICK CONFIG] switch

Turns Quick Config on and off.

When not using Quick Config, this switch and the DIP switches on the rear of the unit determine the ID. (→page 11-12)

Turn the unit off before changing the [QUICK CONFIG] switch position. If you move the switch while the unit is turned on, the new switch position is not applied.

See "Connection methods" (→page 13) for information about Quick Config.

⑧ [SYSTEM] indicators

Indicate the status of the Tio1608-D.

During normal operation, the green indicator is lit and the red indicator is off. When the unit is turned on, if the green indicator is off and the red indicator is lit or is flashing, an error has occurred.

⑨ [SYNC] indicators

Indicate the status of the unit's internal Dante clock sync.

When the green indicator is lit, the unit is the clock slave, and the clock is in sync. When the green indicator is flashing, the unit is the clock master. When the unit is turned on, the green indicator should either light or flash; if the indicator is off, an error has occurred.

⑩ [+48V MASTER] switch

Turns the unit's +48 V phantom power on and off. If the [+48V MASTER] switch is off, no phantom power is supplied to the input jacks even if phantom power is turned on for individual inputs. In this case, the +48V indicators for individual inputs will still light, even though no phantom power will be supplied.

You can change the switch position while the unit is turned on.

⑪ Power indicator

Indicates whether the unit is turned on or off.

⑫ Power switch | / ⏻

Turns the unit on and off.

NOTICE

Rapidly turning the unit on and off in succession can cause it to malfunction. After turning the unit off, wait for about 6 seconds before turning it on again.

Rear panel

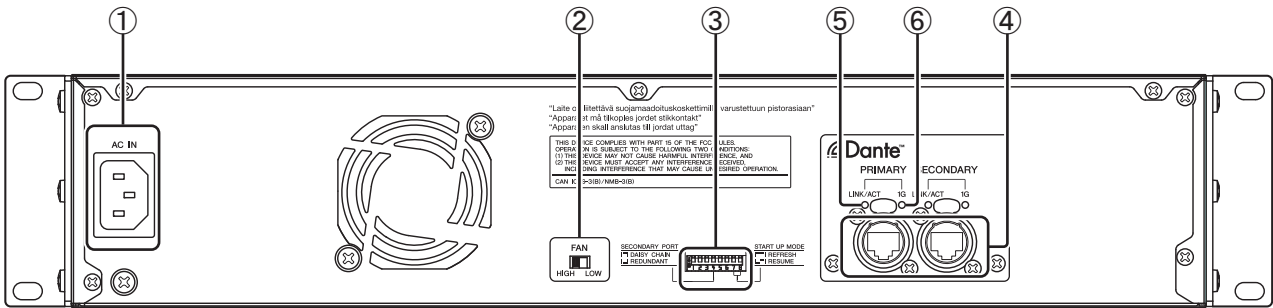

1 AC IN connector

Connect the included power cord. When connecting to a power outlet, first connect the power cord to the unit, then connect the power cord to the power outlet.

⚠ Caution

Make sure the unit is turned off before connecting or disconnecting the power cord.

2 [FAN] switch

Allows you to set the unit's internal cooling fan to run at high or low speed. The switch is set at the factory to [LOW], but as long as the unit is operated within the specified ambient temperature range either the [LOW] or [HIGH] setting can be used. The [HIGH] setting is recommended if the ambient temperature is high, if the unit is in direct sunlight (even if the ambient temperature is within the specified operating range), and in any situation in which fan noise is not a problem. When mounting three or more units without leaving space between each unit, set each unit's fan speed to HIGH. You can change the switch position while the unit is turned on.

3 DIP switches

Determines the unit's start up mode. Make sure that the unit is turned off before adjusting the DIP switches. If you adjust the switches while the unit is turned on, the new switch positions are not applied. The following information explains how the DIP switch positions.

• Switch 1 and 2 (unit ID)

These DIP switches, along with the [UNIT ID] switch, determine the unit's UNIT ID when Quick Config is not used. The UNIT ID is determined as follows.

Switch position	[UNIT ID] switch = 1	[UNIT ID] switch = 2	[UNIT ID] switch = 3
	01	02	03
	04	05	06
	07	08	09
	0A	0B	0C

When Quick Config is used, these switches are disabled.

• Switch 3 (initialize mode)

This DIP switch is used to reset the unit to its factory default settings. After the unit is reset, it starts up using the system mode that corresponds to the position of switches 7 and 8.



Switch position	Initialize mode
	Initialize mode is off (unit will not be reset when it is turned on)
	Initialize mode is on (unit will be reset when it is turned on)

NOTE

If switches 7 and 8 are set to the "update mode" or "diagnostic mode" positions, the unit will not be reset.

- **Switch 4 (Dante SECONDARY port mode)**

This switch determines the operating mode of the [SECONDARY] Dante connector.

Switch position	[SECONDARY] connector operating mode
 4	Daisy chain connection
 4	Redundant connection





When Quick Config is used, these switches are disabled.

NOTE

When the Switch 4 is set to "Redundant connection", the head amp control function ([→page 14](#)) is only available via the [PRIMARY] Dante connector.



- **Switches 5 and 6 (IP address mode)**

These switches determine how the unit's IP address is set.

Switch position	IP address mode
 5 6	Auto (link local)
 5 6	DHCP
 5 6	Static IP Auto (192.168.0.ID)
 5 6	Static IP Manual The IP address is specified from an external device such as R Remote V3.

- **Switches 7 and 8 (start up mode)**

These switches determine how the unit starts up during start up mode. When set to "refresh" mode, the settings of the mixer are applied when the unit starts up. When set to "resume" mode, the unit returns to the same state as the last time it was used.

Switch position	Start up mode
 7 8	Refresh mode (normal operation)
 7 8	Resume mode (normal operation)
 7 8	Update mode

Switch position	Start up mode
 7 8	Diagnostic mode

When Quick Config is used, the "normal operation" mode settings are disabled.

NOTE

- Update mode and diagnostic mode are used when performing maintenance on the unit. Normally you will not use these modes.
- Update mode and diagnostic mode can be enabled even when using Quick Config. Normally you will not use these modes.

- ④ **[PRIMARY] and [SECONDARY] Dante connectors**
etherCON CAT5 connector that connects the unit to a Dante device, such as a NY64-D digital audio interface card. When DIP switch 4 is set to the daisy-chain connection position (i.e., up position), signals received on one connector are sent out via the other connector. When DIP switch 4 is set to the redundant connection position (i.e., down position), the [SECONDARY] connector functions as a backup and carries the same signals as the [PRIMARY] connector. If for some reason signals cannot be carried over the [PRIMARY] connector (for example, because the cable becomes damaged or disconnected, or because the network switch malfunctions), the unit switches to the [SECONDARY] connector.

NOTE

- To avoid electromagnetic interference, use shielded twisted-pair (STP) cables that are rated at CAT5e or higher. Use conductive tape or comparable means to make sure that the metal parts of the cable plugs are electrically connected to the STP cable shield.
- We recommend using RJ-45 plugs that are compatible with Neutrik etherCON CAT5 connectors. You can also use cables with standard RJ-45 plugs.
- The maximum length of cable that can be used varies depending on the type of cable. When using CAT5e cables, data can be sent between devices that are connected by up to 100 m of cable.

⑤ **[LINK/ACT] indicators**

Indicate the status of the signals carried by the [PRIMARY] and [SECONDARY] connectors. If an indicator is flashing quickly, the corresponding Ethernet cable is not connected properly.

⑥ **[1G] indicators**

Indicate the connection status of the PRIMARY and SECONDARY connectors. If an indicator is lit, the corresponding connector is connected to a Gigabit Ethernet network.

This section explains the different methods for connecting the Tio1608-D to other Dante devices.

Quick Config (automatic setup)

When connecting the unit to a TF series mixing console, Quick Config makes it easy to set up the unit automatically. It allows you to connect up to three Tio1608-D units to one TF series mixing console, and configures Dante network settings and audio signal settings in one operation.

NOTE

An NY64-D audio interface card (sold separately) is required to connect a Tio1608-D to a TF series mixing console.

Tio1608-D procedure

1. With all the units turned off, set the DIP switches on the rear panel to the up position.

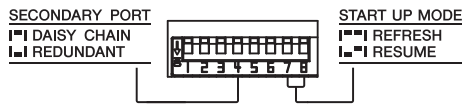

2. Set the [QUICK CONFIG] switch on the front panel to the [ON] position.

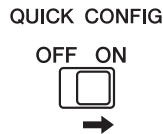

3. Set the [UNIT ID] switch on the front panel to the desired position. If you are using multiple Tio1608-D units, make sure each unit has a unique UNIT ID setting.

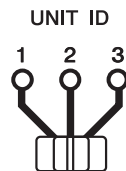

4. Use Ethernet cables to connect the Tio1608-D to the NY64-D card (installed in the TF series mixing console) or to other Tio1608-D units in a daisy-chain configuration, as shown below.

When using Quick Config, the units will operate the same whether you connect the Ethernet cables to the [PRIMARY] or [SECONDARY] Dante connector.

When connecting 3 units

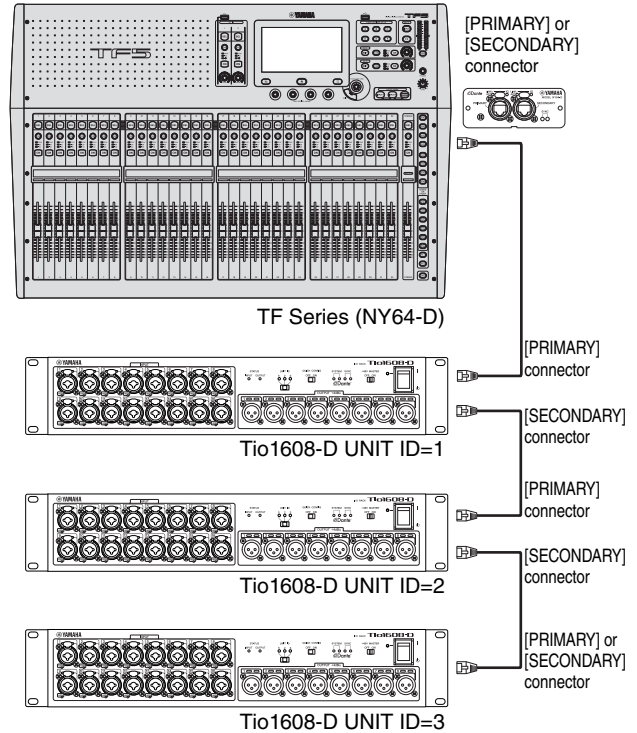

5. Turn each device on.

TF series mixing console procedure

6. Display the console's SYSTEM SETUP → SLOT SETUP screen, and confirm that Quick Config is enabled.

Now the TF series mixing console can recognize the Tio1608-D units, and all Dante settings and input and output patching settings will be configured automatically.

When the Quick Config button is displayed in white, Quick Config is enabled. If the button is grayed out, click it. If you cannot enable Quick Config, return to step 1 and confirm that the Tio1608-D is configured properly.

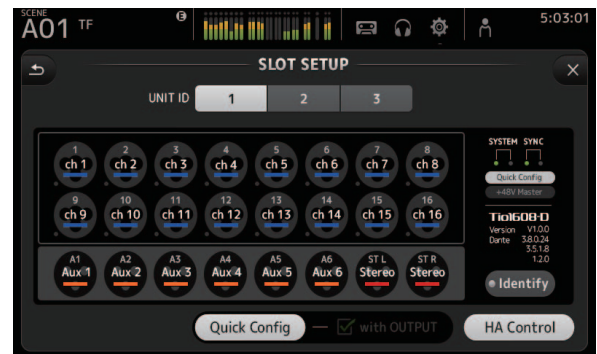

7. To assign the Tio1608-D inputs to the TF series mixing console, set the input select on the console's INPUT screen to "SLOT".



NOTE

You can use the menu in the console's INPUT screen to switch the inputs selected for the current FADER BANK.

8. Adjust the input gain and other settings as necessary.

Quick config is now complete.

Settings configured by Quick Config

Quick Config applies the following settings.

• **Dante settings**

Word clock	48 kHz (slave), no pull up/down
Latency	0.5 ms
Encoding	24-bit PCM
SECONDARY port mode	Daisy chain
Patching	Refer to the table below
IP address	Previous setting is used

NOTE

Quick Config does not configure analog input parameters.

• **Patching**

	Tio input	TF input	TF output	Tio output
#1	ID 1, Input 1	→ Channel 1	AUX 1	→ ID 1, Output 1
	ID 1, Input 2	→ Channel 2	:	:
	:	:	AUX 6	→ ID 1, Output 6
	ID 1, Input 16	→ Channel 16	Stereo L	→ ID 1, Output 7
			Stereo R	→ ID 1, Output 8
#2	ID 2, Input 1	→ Channel 17	AUX 7	→ ID 2, Output 1
	ID 2, Input 2	→ Channel 18	:	:
	:	:	AUX 12	→ ID 2, Output 6
	ID 2, Input 16	→ Channel 32	Stereo L	→ ID 2, Output 7
			Stereo R	→ ID 2, Output 8
#3	ID 3, Input 1	→ Channel 33	AUX 13	→ ID 3, Output 1
	ID 3, Input 2	→ Channel 34	:	:
	:	:	AUX 18	→ ID 3, Output 6
	ID 3, Input 8	→ Channel 40	AUX 19	→ ID 3, Output 7
			AUX 20	→ ID 3, Output 8

NOTE

- Even if only UNIT ID 2 or 3 is used, channels are patched as shown above based on the UNIT ID number.
- After you have used Quick Config to configure the settings, you can use Dante Controller to change the individual settings. However, each time the Tio1608-D is turned on, Dante Controller settings will be replaced by the Quick Config settings. For this reason, we recommend that you turn Quick Config off if you are using Dante Controller.

Manual setup

You can configure your devices manually if you do not want to use Quick Config.

Tio1608-D procedure

1. With the unit turned off, set the [QUICK CONFIG] switch on the front panel to the [OFF] position.
2. Refer to the information on page 11 - 12 and set the DIP switches to the desired positions.
3. Set the [UNIT ID] switch on the front panel to the desired position.
4. Use Ethernet cables to connect the Tio1608-D to your Dante device.
5. Turn each device on.

Dante settings

When using manual setup, use Dante Controller to configure Dante settings.

Dante Controller is a computer program that you can use to configure Dante network settings and audio signal patching settings. It is available for download at the website below. (Dante Controller v3.2.1 or later is compatible with Tio1608-D.)

<http://www.yamahaproaudio.com/>

For information about Dante Controller, refer to the Dante Controller documentation.

When using manual setup, you will need to use Dante Controller to configure the following settings at a minimum. (You can configure other settings as desired.)

- Input and output patching settings (Network View → Routing)
- Clock master settings (Network View → Clock Status)
- Sampling frequency settings (Device View → Config)

Head amp control

You can use a Yamaha digital mixer or other device to control the Tio1608-D head amp.

When the unit is connected to a TF series mixing console, you can control the unit's head amp just as you would adjust the console's head amp.

When using a CL or QL series digital mixer, you can control or use the following parameters.

- HA gain
- +48 V phantom power on/off
- HPF on/off
- HPF frequency cutoff adjustment
- Mute off
- +48 V phantom power master on/off display
- Analog input level meter display
- Firmware version display
- Device identify
- Dante SYSTEM and SYNC indicator information

NOTE

When the Dante SECONDARY port mode (→page 12) is set to "Redundant connection", the head amp control function is only available via the [PRIMARY] Dante connector. The [SECONDARY] Dante connector is not available for this function.



Troubleshooting

Issue	Cause	Solution
No power, power indicator does not light	Power cord not connected.	Make sure the power cord is connected (→page 11).
	The [POWER] switch is turned off.	Set the [POWER] switch to the "on" position. If you still cannot resolve the problem, please contact your nearest Yamaha representative.
Unit is not receiving an input signal	Cables not connected properly.	Make sure all cables are connected properly.
	Source device is not sending a signal to the unit.	Output a signal from the source device and confirm that the [STATUS INPUT] indicators light.
	Internal head amp gain is too low.	Adjust the internal head amp gain to an appropriate level.
	DIP switches are set to "refresh" mode but device that controls the Tio1608-D has not started up.	Start the device that will control the Tio1608-D and send the settings to the Tio1608-D.
Input level too low	Condenser mic is connected.	Set the [+48V MASTER] switch to the "on" position.
		Use the device that controls the Tio1608-D to turn on phantom power for the corresponding channel.
	Internal head amp gain is too low.	Adjust the internal head amp gain to an appropriate level.
No sound heard	Cables not connected properly.	Make sure all cables are connected properly.
	DIP switches are set to "refresh" mode but device that controls the Tio1608-D has not started up.	Start the device that will control the Tio1608-D and send the settings to the Tio1608-D.
[UNIT ID] switch or DIP switch settings not applied	You changed the switch positions while the unit was turned on.	Make sure the unit is turned off before changing the switch positions.





You can use the [SYSTEM] and [SYNC] indicators to confirm the unit's status. The indicators can relay operational status, error status, and warnings.

Error status

If one of the following errors has occurred, the device will not operate. Until the error is resolved, the green SYSTEM indicator will be turned off, and all indicators for all I/O channels will continue to flash. In addition, certain errors will cause the red SYSTEM indicator to light or flash.



[SYSTEM] Indicators	Description	Possible Solution
<p>SYSTEM</p>  <p>Off Flashes 2 times</p>	Internal Dante error has occurred.	The unit is malfunctioning. Please contact your nearest Yamaha representative.
<p>SYSTEM</p>  <p>Off Flashes 3 times</p>	MAC address setting is damaged and Dante communication is not possible.	
<p>SYSTEM</p>  <p>Off Lit</p>	Duplicate UNIT ID was found.	Make sure each UNIT ID is only used once on the Dante network.

The following errors affect the settings or the hardware. However, the device will still be usable. The green SYSTEM indicator will light, and all indicators for all I/O channels will work normally. In addition, certain errors will cause the red SYSTEM indicator to light or flash.

[SYSTEM] Indicators	Description	Possible Solution
<p>SYSTEM</p>  <p>Lit Flashing</p>	The number of Dante transmit flows exceeded the limit.	Reduce the number of flows by, for example, using Dante Controller to change some of the transmit flows to multicast.
<p>SYSTEM</p>  <p>Lit Flashes 2 times</p>	Error occurred when communicating with the head amp.	Turn the unit off and then on again. If this does not resolve the problem, please contact your nearest Yamaha representative.
<p>SYSTEM</p>  <p>Lit Flashes 3 times</p>	Internal memory has been corrupted.	If using [RESUME] mode, turn the unit off and then on again. If this does not resolve the problem, please contact your nearest Yamaha representative.
<p>SYSTEM</p>  <p>Lit Lit</p>	You changed the positions of the device setting DIP switches, or changed the Dante settings from Dante Controller. Therefore, the positions of the device setting DIP switches do not match the actual Dante settings.	If the Device Lock setting was enabled from Dante Controller, disable the setting, or check the device setting DIP switch positions, and set them to accommodate the current situation.

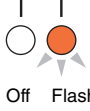

Warnings

The indicators will light and/or flash as shown until the cause is resolved.
If the green [SYNC] indicator is unlit, the unit's clock is unconfirmed.

[SYNC] Indicators	Description	Possible Solution
 <p>Off Flashing</p>	Clock settings are incorrect.	Check the clock master and sampling frequency settings of the Tio1608-D and Dante Controller.
 <p>Off Flashes 2 times</p>	Unit not connected to Dante network.	Make sure the cables are not damaged and that they are connected properly.
 <p>Off Flashes 3 times</p>	Cable wiring is wrong; cannot find other Dante devices.	Check the wiring of the Ethernet cables.

If the green indicator is flashing, the unit is the clock master.

If the green indicator is lit, the unit is the clock slave and the clock is synchronized.



[SYNC] Indicators	Description	Possible Solution
 <p>Lit or flashing Lit</p>	Device that is not Gigabit Ethernet compatible is connected.	To use Dante to send and receive digital audio, make sure your devices are Gigabit Ethernet compatible.
 <p>Lit or flashing Flashing</p>	When using a redundancy network, [SECONDARY] connector is sending/receiving audio.	Check the connections of the network connected to the [PRIMARY] connector.
 <p>Lit or flashing Flashes 2 times</p>	When using a redundancy network, error was detected on the [SECONDARY] connector.	Check the connections of the network connected to the [SECONDARY] connector.

Information Message

The indicators will remain lit and/or flashing cyclically to report the status.

If the orange [SYNC] indicator is unlit, the unit is operating normally.

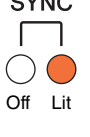
If the green [SYNC] indicator is unlit, the unit's clock is unconfirmed.

[SYNC] Indicators	Description	Possible Solution
 <p>Off Lit</p>	Synchronizing on a Dante network.	Please wait until started has completed or until the unit has finished synchronization. It may take up to 45 seconds for completion.
	Waiting to receive setting data.	If START UP MODE is set to REFRESH on the Tio1608-D unit, the input/output will be muted until the unit receives setting data after it starts up.
 <p>Flashing Off</p>	The unit is functioning correctly as the word clock master.	The unit is operating as the word clock master.
 <p>Lit Off</p>	The unit is functioning correctly as the word clock slave.	The unit is operating as the clock slave and the clock is synchronized.

General Specifications

Output impedance of signal generator: 150ohms
 Measured with another Tio1608-D through Dante network.

Frequency Response

Fs = 44.1kHz or 48kHz, 20Hz-20kHz, refer to the nominal output level @1kHz

Input	Output	RL	Conditions	Min.	Typ.	Max.	Unit
INPUT1-16	OUTPUT 1-8	600Ω	GAIN: +66dB.	-1.5	0.0	0.5	dB

Total Harmonic Distortion

Fs = 44.1kHz or 48kHz

Input	Output	RL	Conditions	Min.	Typ.	Max.	Unit
INPUT1-16	OUTPUT 1-8	600Ω	+4dBu@20Hz-20kHz, GAIN: +66dB.			0.1	%
		600Ω	+4dBu@20Hz-20kHz, GAIN: -6dB.			0.05	%

* Total Harmonic Distortion is measured with a -18dB/octave filter @80kHz

Hum & Noise

Fs = 48kHz, EIN: Equivalent Input Noise

Input	Output	RL	Conditions	Min.	Typ.	Max.	Unit
INPUT1-16	OUTPUT 1-8	600Ω	Rs=150Ω, GAIN: +66dB.		-128		dBu
					EIN		
		600Ω	Rs=150Ω, GAIN: -6dB.		-62		dBu
all Inputs	OUTPUT 1-8	600Ω	Rs=150Ω, GAINs: -6dB Master fader at nominal level and all INPUT 1-16 in faders at nominal level. Measured with TF5 (or TF3,TF1) through Dante.		-84	-80	dBu
-	OUTPUT 1-8	600Ω	Residual output noise, STEREO master off. Measured with TF5 (or TF3,TF1) through Dante.		-88		dBu

* Hum & Noise are measured with A-weighting filter.

Dynamic Range

Fs = 48kHz

Input	Output	RL	Conditions	Min.	Typ.	Max.	Unit
INPUT1-16	OUTPUT 1-8	600Ω	AD + DA, GAIN: -6dB.		108		dB
-	OUTPUT 1-8	600Ω	DA Converter		112		dB

* Dynamic Range are measured with A-weighting filter.

Crosstalk@1kHz

from/to	to/from	Conditions	Min.	Typ.	Max.	Unit
INPUT n	INPUT (n-1) or (n+1)	INPUT1-16 adjacent inputs, GAIN: -6dB.			-100	dB
OUTPUT n	OUTPUT (n-1) or (n+1)	OUTPUT 1-8, input to output			-100	dB

* Crosstalk is measured with a -30dB/octave filter @22kHz

Sampling Frequency

	Conditions	Min.	Typ.	Max.	Unit
External Clock	Frequency Range	44.1kHz / 48kHz	-200	+200	ppm
		+4.1667%/+0.1%/-0.1%/-4.0% to all of the above	-200	+200	ppm

Power Requirements

	Conditions	Min.	Typ.	Max.	Unit
Power Requirements	100-240V 50/60Hz			50	W
Heat Dissipation	100-240V 50/60Hz			43.5	kcal/h

AC Cable Length and Temperature Range

	Conditions	Min.	Typ.	Max.	Unit
AC Cable Length			2.5		m
Temperature Range	Operating temperature range	0		40	°C
	Storage temperature range	-20		60	°C

Dimensions (W x H x D) & Net weight

480(W) x 88(H) x 364(D) mm, 5.7kg

Input Output Digital I/O Character

Analog input characteristics

Input Terminals	GAIN	Actual Load Impedance	For Use With Nominal	Input Level			Connector	balanced / Unbalanced
				Sensitivity*1	Nominal	Max. before clip		
INPUT1-16	+66dB	7.5k Ω	50-600 Ω Mics or 600 Ω Lines	-82dBu (61.6 μ V)	-62dBu (0.616mV)	-42dBu (6.16mV)	Combo Jack (XLR-3-31 type*2 or TRS phone*3)	Balanced
	-6dB			-10dBu (245mV)	+10dBu (2.45V)	+30dBu (24.5V)		

In these specifications, 0dBu = 0.775Vrms.
+48V DC (phantom power) can be supplied to INPUT XLR type connectors via each individual software controlled switch.

- *1. Sensitivity is the lowest level that will produce an output of +4dBu (1.23V) or the nominal output level when the unit is set to maximum gain.
*2. 1: GND, 2: HOT, 3: COLD
*3. Tip: HOT, Ring: COLD, Sleeve: GND

Analog output characteristics

Output Terminals	Actual Source Impedance	For Use With Nominal	Output Level		Connector	balanced / Unbalanced
			Nominal	Max. before clip		
OUTPUT 1-8	75 Ω	600 Ω Lines	+4dBu (1.23 V)	+24dBu (12.3 V)	XLR-3-32 type*1	Balanced

In these specifications, 0dBu = 0.775Vrms.

- *1. 1: GND, 2: HOT, 3: COLD

Digital input/output specifications

Terminal	Format	Data length	Level	Audio	Connector
Primary / Secondary	Dante	24 or 32bit	1000BASE-T	16ch (Tio1608-D to other devices) 8ch (Other devices to Tio1608-D)	etherCON Cat5e

- * 本書は、発行時点での最新仕様で説明しています。最新版は、ヤマハウェブサイトからダウンロードできます。
- * The contents of this manual apply to the latest specifications as of the publishing date. To obtain the latest manual, access the Yamaha website then download the manual file.
- * Der Inhalt dieser Bedienungsanleitung gilt für die neuesten technischen Daten zum Zeitpunkt der Veröffentlichung. Um die neueste Version der Anleitung zu erhalten, rufen Sie die Website von Yamaha auf und laden Sie dann die Datei mit der Bedienungsanleitung herunter.
- * Le contenu de ce mode d'emploi s'applique aux dernières caractéristiques techniques connues à la date de publication du manuel. Pour obtenir la version la plus récente du manuel, accédez au site Web de Yamaha puis téléchargez le fichier du manuel concerné.
- * El contenido de este manual se aplica a las últimas especificaciones según la fecha de publicación. Para obtener el último manual, acceda al sitio web de Yamaha y descargue el archivo del manual.
- * O conteúdo deste manual se aplica às especificações mais recentes a partir da data de publicação. Para obter o manual mais recente, acesse o site da Yamaha e faça o download do arquivo do manual.
- * Il contenuto del presente manuale si applica alle ultime specifiche tecniche a partire dalla data di pubblicazione. Per ottenere la versione più recente del manuale, accedere al sito Web Yamaha e scaricare il file corrispondente.
- * В содержании данного руководства приведены последние на момент публикации технические характеристики. Для получения последней версии руководства посетите веб-сайт корпорации Yamaha и загрузите файл с руководством.

Dimensions

Tio1608-D

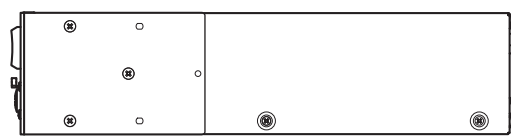
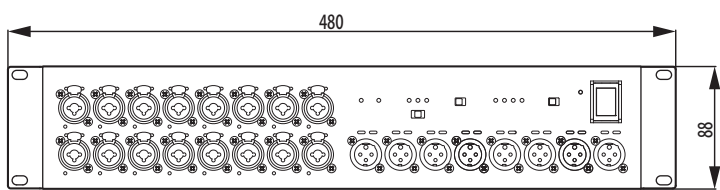
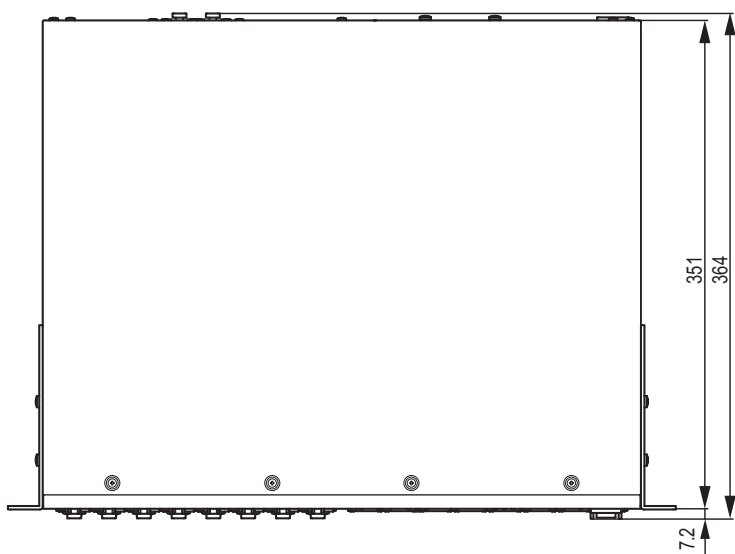

Unit: mm

English

Deutsch

Français

Español

Português

Italiano

Русский

日本語

Important Notice: Guarantee Information for customers in European Economic Area (EEA) and Switzerland

<p>Important Notice: Guarantee Information for customers in EEA* and Switzerland</p> <p>For detailed guarantee information about this Yamaha product, and Pan-EEA* and Switzerland warranty service, please either visit the website address below (Printable file is available at our website) or contact the Yamaha representative office for your country. * EEA: European Economic Area</p>	English
<p>Wichtiger Hinweis: Garantie-Information für Kunden in der EWR* und der Schweiz</p> <p>Für nähere Garantie-Information über dieses Produkt von Yamaha, sowie über den Pan-EWR*- und Schweizer Garantieservice, besuchen Sie bitte entweder die folgend angegebene Internetadresse (eine druckfähige Version befindet sich auch auf unserer Webseite), oder wenden Sie sich an den für Ihr Land zuständigen Yamaha-Vertrieb. *EWR: Europäischer Wirtschaftsraum</p>	Deutsch
<p>Remarque importante: informations de garantie pour les clients de l'EEE et la Suisse</p> <p>Pour des informations plus détaillées sur la garantie de ce produit Yamaha et sur le service de garantie applicable dans l'ensemble de l'EEE ainsi qu'en Suisse, consultez notre site Web à l'adresse ci-dessous (le fichier imprimable est disponible sur notre site Web) ou contactez directement Yamaha dans votre pays de résidence. * EEE : Espace Economique Européen</p>	Français
<p>Belangrijke mededeling: Garantie-informatie voor klanten in de EER* en Zwitserland</p> <p>Voor gedetailleerde garantie-informatie over dit Yamaha-product en de garantieservice in heel de EER* en Zwitserland, gaat u naar de onderstaande website (u vind een afdrukbaar bestand op onze website) of neemt u contact op met de vertegenwoordiging van Yamaha in uw land. * EER: Europese Economische Ruimte</p>	Nederlands
<p>Aviso importante: información sobre la garantía para los clientes del EEE* y Suiza</p> <p>Para una información detallada sobre este producto Yamaha y sobre el soporte de garantía en la zona EEE* y Suiza, visite la dirección web que se incluye más abajo (la versión del archivo para imprimir esta disponible en nuestro sitio web) o póngase en contacto con el representante de Yamaha en su país. * EEE: Espacio Económico Europeo</p>	Español
<p>Avviso importante: informazioni sulla garanzia per i clienti residenti nell'EEA* e in Svizzera</p> <p>Per informazioni dettagliate sulla garanzia relativa a questo prodotto Yamaha e l'assistenza in garanzia nei paesi EEA* e in Svizzera, potete consultare il sito Web all'indirizzo riportato di seguito (è disponibile il file in formato stampabile) oppure contattare l'ufficio di rappresentanza locale della Yamaha. * EEA: Area Economica Europea</p>	Italiano
<p>Aviso importante: informações sobre as garantias para clientes da AEE* e da Suíça</p> <p>Para obter uma informação pormenorizada sobre este produto da Yamaha e sobre o serviço de garantia na AEE* e na Suíça, visite o site a seguir (o arquivo para impressão está disponível no nosso site) ou entre em contato com o escritório de representação da Yamaha no seu país. * AEE: Área Econômica Européia</p>	Português
<p>Σημαντική σημείωση: Πληροφορίες εγγύησης για τους πελάτες στον ΕΟΧ* και Ελλάδα</p> <p>Για λεπτομερείς πληροφορίες εγγύησης σχετικά με το παρόν προϊόν της Yamaha και την κάλυψη εγγύησης σε όλες τις χώρες του ΕΟΧ και την Ελλάδα, επισκεφτείτε την παρακάτω ιστοσελίδα (Εκτυπώσιμη μορφή είναι διαθέσιμη στην ιστοσελίδα μας) ή απευθυνθείτε στην αντιπροσωπεία της Yamaha στη χώρα σας. * ΕΟΧ: Ευρωπαϊκός Οικονομικός Χώρος</p>	Ελληνικά
<p>Viktigt: Garantiinformation för kunder i EES-området* och Schweiz</p> <p>För detaljerad information om denna Yamaha-produkt samt garantiservice i hela EES-området* och Schweiz kan du antingen besöka nedanstående webbadress (en utskriftsvänlig fil finns på webbplatsen) eller kontakta Yamahas officiella representant i ditt land. * EES: Europeiska Ekonomiska Samarbetsområdet</p>	Svenska
<p>Viktig merknad: Garantiinformasjon for kunder i EØS* og Sveits</p> <p>Detaljert garantiinformasjon om dette Yamaha-produktet og garantiservice for hele EØS-området* og Sveits kan fås enten ved å besøke nettstedene nedenfor (utskriftsversjon finnes på våre nettsider) eller kontakte Yamahas offisielle representant i landet der du bor. *EØS: Det europeiske økonomiske samarbeidsområdet</p>	Norsk
<p>Vigtig oplysning: Garantioplysninger til kunder i EØ* og Schweiz</p> <p>De kan finde detaljerede garantioplysninger om dette Yamaha-produkt og den fælles garantiserviceordning for EØ* (og Schweiz) ved at besøge det websted, der er angivet nedenfor (der findes en fil, som kan udskrives, på vores websted), eller ved at kontakte Yamahas nationale repræsentationskontor i det land, hvor De bor. * EØ: Det Europæiske Økonomiske Område</p>	Dansk
<p>Tärkeä ilmoitus: Takuutiedot Euroopan talousalueen (ETA)* ja Sveitsin asiakkaille</p> <p>Tämän Yamaha-tuotteen sekä ETA-alueen ja Sveitsin takuuta koskevat yksityiskohtaiset tiedot saatte alla olevasta nettiosoitteesta. (Tulostettava tiedosto saatavissa sivustollamme.) Voitte myös ottaa yhteyttä paikalliseen Yamaha-edustajaan. *ETA: Euroopan talousalue</p>	Suomi
<p>Ważne: Warunki gwarancyjne obowiązujące w EOG* i Szwajcarii</p> <p>Aby dowiedzieć się więcej na temat warunków gwarancyjnych tego produktu firmy Yamaha i serwisu gwarancyjnego w całym EOG* i Szwajcarii, należy odwiedzić wskazaną poniżej stronę internetową (Plik gotowy do wydruku znajduje się na naszej stronie internetowej) lub skontaktować się z przedstawicielstwem firmy Yamaha w swoim kraju. * EOG — Europejski Obszar Gospodarczy</p>	Polski
<p>Důležité oznámení: Záruční informace pro zákazníky v EHS* a ve Švýcarsku</p> <p>Podrobné záruční informace o tomto produktu Yamaha a záručním servisu v celém EHS* a ve Švýcarsku naleznete na níže uvedené webové adrese (soubor k tisku je dostupný na našich webových stránkách) nebo se můžete obrátit na zástupce firmy Yamaha ve své zemi. * EHS: Evropský hospodářský prostor</p>	Česky
<p>Fontos figyelmeztetés: Garancia-információk az EGT* területén és Svájcban élő vásárlók számára</p> <p>A jelen Yamaha termékre vonatkozó részletes garancia-információk, valamint az EGT*-re és Svájcra kiterjedő garanciális szolgáltatás tekintetében keresse fel webhelyünket az alábbi címen (a webhelyen nyomtatható fájl is talál), vagy pedig lépjen kapcsolatba az országháiban működő Yamaha képviselői irodával. * EGT: Európai Gazdasági Térség</p>	Magyar
<p>Oluline märkus: Garantiiteave Euroopa Majanduspiirkonna (EMP)* ja Šveitsi klientidele</p> <p>Täpsema teabe saamiseks selle Yamaha toote garantii ning kogu Euroopa Majanduspiirkonna ja Šveitsi garantiiteeninduse kohta, külastage palun veebisaiti alljärgneval aadressil (meie saidil on saadaval printitav fail) või pöörduge Teie regiooni Yamaha esinduse poole. * EMP: Euroopa Majanduspiirkond</p>	Eesti keel
<p>Svarīgs paziņojums: garantijas informācija klientiem EEZ* un Šveicē</p> <p>Lai saņemtu detalizētu garantijas informāciju par šo Yamaha produktu, kā arī garantijas apkalpošanu EEZ* un Šveicē, lūdzu, apmeklējiet zemāk norādīto tīmekļa vietnes adresi (tīmekļa vietnē ir pieejams drukājams fails) vai sazinieties ar jūsu valsti apkalpojošo Yamaha pārstāvniecību. * EEZ: Eiropas Ekonomikas zona</p>	Latviešu
<p>Dėmesio: informacija dėl garantijos pirkejamams EEE* ir Šveicarijoje</p> <p>Jei reikia išsamios informacijos apie šį „Yamaha“ produktą ir jo techninę priežiūrą visoje EEE* ir Šveicarijoje, apsilankykite mūsų svetainėje toliau nurodytu adresu (svetainėje yra spausdintinas failas) arba kreipkitės į „Yamaha“ atstovybę savo šaliai. *EEE – Europos ekonominė erdvė</p>	Lietuvių kalba
<p>Dôležité upozornenie: Informácie o záruke pre zákazníkov v EHP* a Švajčiarsku</p> <p>Podrobné informácie o záruke týkajúce sa tohto produktu od spoločnosti Yamaha a garančnom servise v EHP* a Švajčiarsku nájdete na webovej stránke uvedenej nižšie (na našej webovej stránke je k dispozícii súbor na tlač) alebo sa obráťte na zástupcu spoločnosti Yamaha vo svojej krajine. * EHP: Európsky hospodársky priestor</p>	Slovenčina
<p>Pomembno obvestilo: Informacije o garanciji za kupce v EGP* in Švici</p> <p>Za podrobnejše informacije o tem Yamahinem izdelku ter garancijskem servisu v celotnem EGP in Švici, obiščite spletno mesto, ki je navedeno spodaj (natisljiva datoteka je na voljo na našem spletnem mestu), ali se obrnite na Yamahinega predstavnika v svoji državi. * EGP: Evropski gospodarski prostor</p>	Slovenščina
<p>Важно съобщение: Информация за гаранцията за клиенти в ЕИП* и Швейцария</p> <p>За подробна информация за гаранцията за този продукт на Yamaha и гаранционното обслужване в паневропейската зона на ЕИП* и Швейцария или посетете посочения по-долу уеб сайт (на нашия уеб сайт има файл за печат), или се свържете с представителния офис на Yamaha във вашата страна. * ЕИП: Европейско икономическо пространство</p>	Български език
<p>Notificare importantă: Informații despre garanție pentru clienții din SEE* și Elveția</p> <p>Pentru informații detaliate privind acest produs Yamaha și serviciul de garanție Pan-SEE* și Elveția, vizitați site-ul la adresa de mai jos (fișierul imprimabil este disponibil pe site-ul nostru) sau contactați biroul reprezentanței Yamaha din țara dumneavoastră. * SEE: Spațiul Economic European</p>	Limba română

<http://europe.yamaha.com/warranty/>

ADDRESS LIST

NORTH AMERICA

CANADA

Yamaha Canada Music Ltd.
135 Milner Avenue, Toronto, Ontario,
M1S 3R1, Canada
Tel: +1-416-298-1311

U.S.A.

Yamaha Corporation of America
6600 Orangethorpe Avenue, Buena Park, CA 90620,
U.S.A.
Tel: +1-714-522-9011

CENTRAL & SOUTH AMERICA

MEXICO

Yamaha de México, S.A. de C.V.
Av. Insurgentes Sur 1647 Piso 9, Col. San José
Insurgentes, Delegación Benito Juárez, México,
D.F., C.P. 03900, México
Tel: +52-55-5804-0600

BRAZIL

Yamaha Musical do Brasil Ltda.
Rua Fidêncio Ramos, 302 – Cj 52 e 54 – Torre B – Vila
Olimpia – CEP 04551-010 – São Paulo/SP, Brazil
Tel: +55-11-3704-1377

ARGENTINA

**Yamaha Music Latin America, S.A.,
Sucursal Argentina**
Olga Cossetini 1553, Piso 4 Norte,
Madero Este-C1107CEK,
Buenos Aires, Argentina
Tel: +54-11-4119-7000

PANAMA AND OTHER LATIN AMERICAN COUNTRIES/ CARIBBEAN COUNTRIES

Yamaha Music Latin America, S.A.
Edif. Torre Banco General, Piso 7, Urbanización
Marbella, Calle 47 y Aquilino de la Guardia,
Ciudad de Panamá, República de Panamá
Tel: +507-269-5311

EUROPE

THE UNITED KINGDOM/IRELAND

Yamaha Music Europe GmbH (UK)
Sherbourne Drive, Tilbrook, Milton Keynes,
MK7 8BL, U.K.
Tel: +44-1908-366700

GERMANY

Yamaha Music Europe GmbH
Siemensstrasse 22-34, 25462 Rellingen, Germany
Tel: +49-4101-303-0

SWITZERLAND/LIECHTENSTEIN

**Yamaha Music Europe GmbH, Branch
Switzerland in Thalwil**
Seestrasse 18a, 8800 Thalwil, Switzerland
Tel: +41-44-3878080

AUSTRIA/BULGARIA/ CZECH REPUBLIC/HUNGARY/ ROMANIA/SLOVAKIA/SLOVENIA

**Yamaha Music Europe GmbH
Branch Austria**
Schleiergasse 20, 1100 Wien, Austria
Tel: +43-1-60203900

POLAND

**Yamaha Music Europe GmbH
Sp.z o.o. Oddział w Polsce**
ul. Wielicka 52, 02-657 Warszawa, Poland
Tel: +48-22-880-08-88

MALTA

Olimpus Music Ltd.
Valletta Road, Mosta MST9010, Malta
Tel: +356-2133-2093

NETHERLANDS/BELGIUM/ LUXEMBOURG

Yamaha Music Europe Branch Benelux
Clarissenhof 5b, 4133 AB Vianen, The Netherlands
Tel: +31-347-358040

FRANCE

Yamaha Music Europe
7 rue Ambroise Croizat, Zone d'activités de Pariest,
77183 Croissy-Beaubourg, France
Tel: +33-1-6461-4000

ITALY

Yamaha Music Europe GmbH, Branch Italy
Via Tinelli N.67/69 20855 Gerno di Lesmo (MB),
Italy
Tel: +39-039-9065-1

SPAIN/PORTUGAL

**Yamaha Music Europe GmbH Ibérica, Sucursal
en España**
Ctra. de la Coruña km. 17,200, 28231
Las Rozas de Madrid, Spain
Tel: +34-91-639-88-88

GREECE

Philippos Nakas S.A. The Music House
19th klm. Leof. Lavriou 190 02 Peania – Attiki,
Greece
Tel: +30-210-6686168

SWEDEN/FINLAND/ICELAND

**Yamaha Music Europe GmbH Germany filial
Scandinavia**
JA Wettergrensgata 1, 400 43 Göteborg, Sweden
Tel: +46-31-89-34-00

DENMARK

**Yamaha Music Denmark,
Fillial of Yamaha Music Europe GmbH, Tyskland**
Generatorvej 8C, ST. TH. , 2860 Søborg, Denmark
Tel: +45-44-92-49-00

NORWAY

**Yamaha Music Europe GmbH Germany -
Norwegian Branch**
Grini Næringspark 1, 1332 Østerås, Norway
Tel: +47-6716-7800

CYPRUS

Yamaha Music Europe GmbH
Siemensstrasse 22-34, 25462 Rellingen, Germany
Tel: +49-4101-303-0

RUSSIA

Yamaha Music (Russia) LLC.
Room 37, entrance 7, bld. 7, Kievskaya street,
Moscow, 121059, Russia
Tel: +7-495-626-5005

OTHER EUROPEAN COUNTRIES

Yamaha Music Europe GmbH
Siemensstrasse 22-34, 25462 Rellingen, Germany
Tel: +49-4101-3030

AFRICA

Yamaha Music Gulf FZE
JAFZA-16, Office 512, P.O.Box 17328,
Jebel Ali FZE, Dubai, UAE
Tel: +971-4-801-1500

MIDDLE EAST

TURKEY

**Yamaha Music Europe GmbH
Merkezi Almanya Türkiye İstanbul Şubesi**
Maslak Meydanı Sodak, Spring Giz Plaza Bagimsiz
Böl. No:3, Sariyer İstanbul, Turkey
Tel: +90-212-999-8010

OTHER COUNTRIES

Yamaha Music Gulf FZE
JAFZA-16, Office 512, P.O.Box 17328,
Jebel Ali FZE, Dubai, UAE
Tel: +971-4-801-1500

ASIA

THE PEOPLE'S REPUBLIC OF CHINA

Yamaha Music & Electronics (China) Co.,Ltd.
2F, Yunhedasha, 1818 Xinzha-lu, Jingan-qu,
Shanghai, China
Tel: +86-400-051-7700

INDIA

Yamaha Music India Private Limited
P-401, JMD Megapolis, Sector-48, Sohna Road,
Gurgaon-122018, Haryana, India
Tel: +91-124-485-3300

INDONESIA

PT. Yamaha Musik Indonesia (Distributor)
Yamaha Music Center Bldg. Jalan Jend. Gatot
Subroto Kav. 4, Jakarta 12930, Indonesia
Tel: +62-21-520-2577

KOREA

Yamaha Music Korea Ltd.
8F, Dongsung Bldg. 21, Teheran-ro 87-gil,
Gangnam-gu, Seoul, 06169, Korea
Tel: +82-2-3467-3300

MALAYSIA

Yamaha Music (Malaysia) Sdn. Bhd.
No.8, Jalan Perbandaran, Kelana Jaya, 47301
Petaling Jaya, Selangor, Malaysia
Tel: +60-3-78030900

SINGAPORE

Yamaha Music (Asia) Private Limited
Block 202 Hougang Street 21, #02-00,
Singapore 530202, Singapore
Tel: +65-6740-9200

TAIWAN

Yamaha Music & Electronics Taiwan Co.,Ltd.
2F., No.1, Yuandong Rd., Banqiao Dist.,
New Taipei City 22063, Taiwan (R.O.C.)
Tel: +886-2-7741-8888

THAILAND

Siam Music Yamaha Co., Ltd.
3, 4, 15, 16th Fl., Siam Motors Building,
891/1 Rama 1 Road, Wangmai,
Pathumwan, Bangkok 10330, Thailand
Tel: +66-2215-2622

VIETNAM

Yamaha Music Vietnam Company Limited
15th Floor, Nam A Bank Tower, 201-203 Cach
Mang Thang Tam St., Ward 4, Dist.3,
Ho Chi Minh City, Vietnam
Tel: +84-8-3818-1122

OTHER ASIAN COUNTRIES

<http://asia.yamaha.com/>

OCEANIA

AUSTRALIA

Yamaha Music Australia Pty. Ltd.
Level 1, 80 Market Street, South Melbourne,
VIC 3205, Australia
Tel: +61-3-9693-5111

COUNTRIES AND TRUST

TERRITORIES IN PACIFIC OCEAN

<http://asia.yamaha.com/>

Yamaha Pro Audio global website
<http://www.yamahaproaudio.com/>
Yamaha Downloads
<http://download.yamaha.com/>

Manual Development Group
© 2016 Yamaha Corporation

Published 07/2017 CRES-C0

ZZ65080

Free Manuals Download Website

<http://myh66.com>

<http://usermanuals.us>

<http://www.somanuals.com>

<http://www.4manuals.cc>

<http://www.manual-lib.com>

<http://www.404manual.com>

<http://www.luxmanual.com>

<http://aubethermostatmanual.com>

Golf course search by state

<http://golfingnear.com>

Email search by domain

<http://emailbydomain.com>

Auto manuals search

<http://auto.somanuals.com>

TV manuals search

<http://tv.somanuals.com>