

PRECAUTIONS

PLEASE READ CAREFULLY BEFORE PROCEEDING

Please keep this manual in a safe place for future reference.

This product is a speaker system designed for background music and public address applications in places such as stores, restaurants and other commercial spaces. Do not use for any purposes other than the one intended. Those who are unfamiliar with handling or those who can not handle according to this manual, should be supervised by responsible persons to ensure safety.

Always consult a professional installer if the product installation requires construction work.

WARNING

Always follow the basic precautions listed below to avoid the possibility of serious injury or even death from electrical shock, short-circuiting, damages, fire or other hazards. These precautions include, but are not limited to, the following:

If you notice any abnormality

- If any of the following problems occur, immediately turn off the power of the amplifier.
 - Unusual smells or smoke are emitted.
 - Some object, or water has been dropped into the product.
 - There is a sudden loss of sound during use of the product.
 - Cracks or other visible damage appear on the product.
- Then have the product inspected or repaired by qualified Yamaha service personnel.

Do not open

- This product contains no user-serviceable parts. Do not attempt to disassemble the internal parts or modify them in any way.

Water warning

- Do not expose the product to rain, use it near water or in damp or wet conditions.

Fire warning

- Do not place any burning items or open flames near the product, since they may cause a fire.

Hearing loss

- Before turning the power of all devices on or off, make sure that all volume levels are set to the minimum. Failing to do so may result in hearing loss, electric shock, or device damage.
- When turning on the AC power in your audio system, always turn on the power amplifier LAST, to avoid hearing loss and speaker damage. When turning the power off, the power amplifier should be turned off FIRST for the same reason.

Location and connection

- Always consult a professional installer if the product installation requires construction work, and make sure to observe the following precautions.
 - Choose mounting hardware and an installation location that can support the weight of the product.
 - Avoid locations that are exposed to constant vibration.
 - Use the required tools to install the product.
 - Inspect the product periodically.
- Do not place the product in an unstable position or a location with excessive vibration, where it might accidentally fall down and cause injury.

NOTICE

To avoid the possibility of malfunction/damage to the product or damage to other property, follow the notices below.

Handling and maintenance

- Do not expose the product to excessive dust or vibration, or extreme cold or heat, in order to prevent the possibility of panel discoloration, unstable operation, or damage to the internal components.
- Be sure to observe the amplifier's rated load impedance, particularly when connecting speakers in parallel at low impedance. Connecting an impedance load outside the amplifier's rated range can damage the amplifier.
- When using a high-impedance speaker connection, make sure the audio signal is passed through an 80 Hz or above high-pass filter before being input to the speakers.
- Do not touch the speaker driver unit, since it might cause malfunction.
- Do not place vinyl, plastic or rubber objects on the product, since this might cause alteration or discoloration of the panel.
- When cleaning the product, use a dry and soft cloth. Do not use paint thinners, solvents, cleaning fluids, or chemical-impregnated wiping cloths, since this might cause alteration or discoloration.
- Protection Circuit
This speaker system has an internal protection circuit that shuts off the speaker unit when an excessive input signal is applied. If the speaker unit emits no sound, reduce the volume level of the amplifier immediately. (The sound will return automatically in several seconds.)
- Do not place the speaker face down with the grille attached, as deformation of the grille may result.
- When placing the baffle face down, always place it on a flat surface.

Information

About this manual

- The illustrations as shown in this manual are for instructional purposes only.
- The company names and product names in this manual are the trademarks or registered trademarks of their respective companies.

About disposal

- This product contains recyclable components. When disposing of this product, please contact the appropriate local authorities.

Yamaha cannot be held responsible for damage caused by improper use or modifications to the product.

CAUTION

Always follow the basic precautions listed below to avoid the possibility of physical injury to you or others. These precautions include, but are not limited to, the following:

Location and connection

- Keep this product out of reach of children. This product is not suitable for use in locations where children are likely to be present.
- Do not place the product in a location where it may come into contact with corrosive gases or salt air. Doing so may result in malfunction.
- Do not place the product in a location where it may be exposed to smoke or oil vapors, or where any of its parts might deteriorate and cause malfunction.
- Before moving the product, remove all connected cables.
- Use only speaker cables for connecting speakers to the speaker jacks. Use of other types of cables may result in fire.

Handling caution

- Do not insert your fingers in any gaps or openings on the product (clamps or moving parts on the rails).
 - Do not rest your weight on the product or place heavy objects on it.
 - When choosing a power amplifier for use with this product, make sure that the output power of the amplifier meets the following conditions:
 - When using a low-impedance connection, make sure that the output power of the amplifier is lower than the power capacity of this product.
 - When using a high-impedance connection, be sure that the total rating of the transformer taps of the speakers does not exceed the output power of the amplifier.
- If the output power is not appropriate, malfunction or fire may occur.
- Do not input excessively loud signals that may result in clipping in the amplifier or cause the following:
 - Feedback, when using a microphone
 - Continuous and extremely loud sound from a musical instrument, etc.
 - Continuous and excessively loud distorted sound
 - Noise caused by plugging/unplugging the cable while the amplifier is turned on
- Even if the output power of the amplifier is lower than the power capacity of this product (program), damage to the product, malfunction or fire may occur.

PA_en_12

Unpacking

Unpack the contents and confirm that all the following items are included.

- Speaker × 1
- Grille × 1
- Safety wire × 1
- Cutout template × 1
- Owner's Manual (this manual)

The following Reinforcing Bracket Kit is included only with VC8NB, VC8NW, VC6NB, VC6NW.

- Tile rails × 2
- C-ring × 1
- Screws (S-TITE M4, 8 mm) × 2

- * Speaker cable is not included.

Optional Items (sold separately; VC4NB and VC4NW only)

Reinforcing Bracket Kit (AB-C2)

Bundled Items

- Tile rails × 2
- C-ring × 1
- Screws (S-TITE M4, 8 mm) × 2

* In this manual, the installation method using the AB-C2 Reinforcing Bracket Kit is also explained.

Material and weight of the Reinforcing Bracket Kit (AB-C2): steel, 1.0 kg

General Specifications

	VC4NB VC4NW	VC6NB VC6NW	VC8NB VC8NW
System Type	2-way coaxial type (without back can)		
Components	HF LF	0.8" film dome 4" (10 cm) cone	0.8" soft dome 6.5" (16 cm) cone 1" soft dome 8" (20 cm) cone
Nominal Impedance	16 Ω		
Frequency Range *1 (-10 dB)	85 Hz - 20 kHz	63 Hz - 20 kHz	52 Hz - 20 kHz
Coverage Angle *1	160° conical	120° conical	110° conical
Power Rating	NOISE PGM MAX	15 W 30 W 60 W	25 W 50 W 100 W
Sensitivity *1 (1 W, 1 m)	88 dB SPL	89 dB SPL	91 dB SPL
Maximum SPL *2 (Calculated, 1 m, Peak)	106 dB SPL	109 dB SPL	111 dB SPL
Transformer Taps	100 V 70 V	1.5/3/6 W 0.8/1.5/3/6 W	3/6/12 W 1.5/3/6/12 W
Overload Protection	Full-range power limiting to protect network and transducers		
Connector	Push terminal (WAGO 294 /2 pin) × 1 Wire size: Solid conductor min. AWG18 (0.75 sq), max. AWG12 (3.5 sq) Standard conductor min. AWG18 (0.75 sq), max. AWG14 (2 sq)		
Baffle	PP, black		
Grille	Metal Grille	Punching metal, Powder coating black (Munsell N3) / white (Munsell N9.3)	
Trim Ring		ABS, black (Munsell N3) / white (N9.3)	
Dust-proof bag	Artificial fiber, black		
Dimensions (Including grille)	Ø225 × D103 mm	Ø286 × D114 mm	Ø325 × D131 mm
Weight (Including grille)	1.4 kg	2.3 kg	2.8 kg
Cutout size	Ø186 mm	Ø247 mm	Ø285 mm
Required ceiling board thickness	2 mm - 37 mm		
Conduit tube	Ø15.4 mm - Ø21.3 mm		
Packaging	1 pc		
Included in the package	Grille, Safety wire, Cutout template, Owner's Manual		
Reinforcing Bracket Kit	—	C-Ring, Tile Rails × 2	C-Ring, Tile Rails × 2
Optional accessories	AB-C2	—	—

*1 : Half-space (2π)

*2 : Calculated based on power rating and sensitivity

The contents of this manual apply to the latest specifications as of the publishing date. To obtain the latest manual, access the Yamaha website then download the manual file.

The dimensions are shown in "Dimensions" on the back side of the manual.

NOTICE

The example illustrations in this manual are of the VC4NB.

Installing the Speaker

Before installing the speaker onto the ceiling, ensure that the strength of the ceiling rail is sufficient.



CAUTION

Be careful not to hurt your hands when handling this product.

NOTICE

When installing the speakers, turn off the power amplifier.

Pre-installation (Preparation of the Cable)

- For cables attached to the spring type connector, strip the insulation as shown in the figure and connect them.

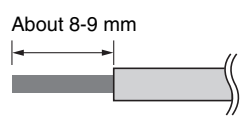

Compatible cable:
 Min. AWG18 (0.75 sq)
 Max. AWG12 (3.5 sq) for solid core wire/
 AWG14 (2 sq) for stranded wire

NOTICE

Do not plate core wires by soldering if the cable uses stranded wire. Doing so will cause the wire to break.

1 Cut Out a Hole in the Ceiling

- Put the supplied cutout template to the ceiling and draw a circle by tracing it. Make sure to use the cutout template so that hole is the correct diameter. If you use a circular cutter, set the diameter using the cutout template.
- Cut the hole by tracing the circle.



CAUTION

Wear goggles to prevent chips or powder entering your eyes while cutting the hole.

2 Connect the Wiring to the Connector

- Pull the wiring from the power amplifier through the cut hole of the ceiling.

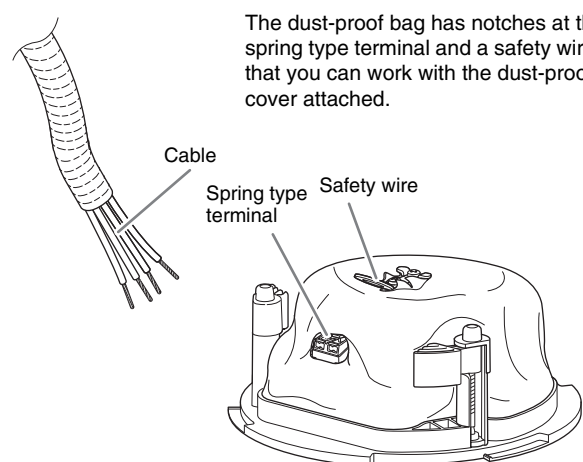

The dust-proof bag has notches at the spring type terminal and a safety wire so that you can work with the dust-proof cover attached.

- Insert the cable into each terminal. Insert the cable while holding the lever, and when fully inserted, release your finger from the lever to securely connect. (Lever operation is not required for solid core wire.) Make sure that the cables cannot be pulled out.

Spring type terminal

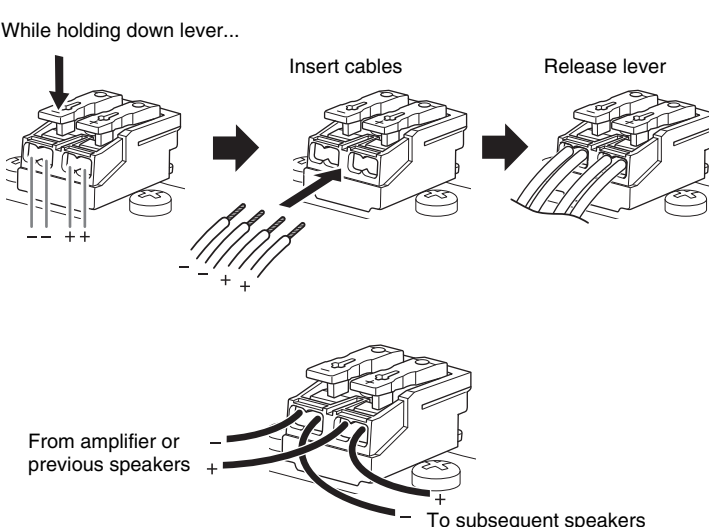

From amplifier or previous speakers
 To subsequent speakers

3 Fix the Speaker onto the Ceiling

- From the hole on the top of the dust-proof cover, attach the safety wire to the safety wire ring, and connect the wire to an independent support point, such as a joist.

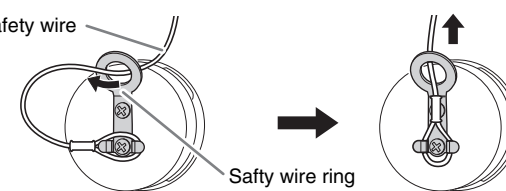

CAUTION

Always take measures to prevent the speaker from falling down. If the safety wire is too short, prepare another wire appropriate for the speaker weight and installation conditions.

- Push the speaker slowly up into the ceiling, taking care not to trap the speaker cable or safety wire.

(VC4NB, VC4NW)
 When the AB-C2 Reinforcing Bracket Kit (sold separately) is not used.

(VC4NB, VC4NW, VC6NB, VC6NW, VC8NB, VC8NW)
 When the included Reinforcing Bracket Kit or AB-C2 (sold separately; VC4NB and VC4NW only) is used.

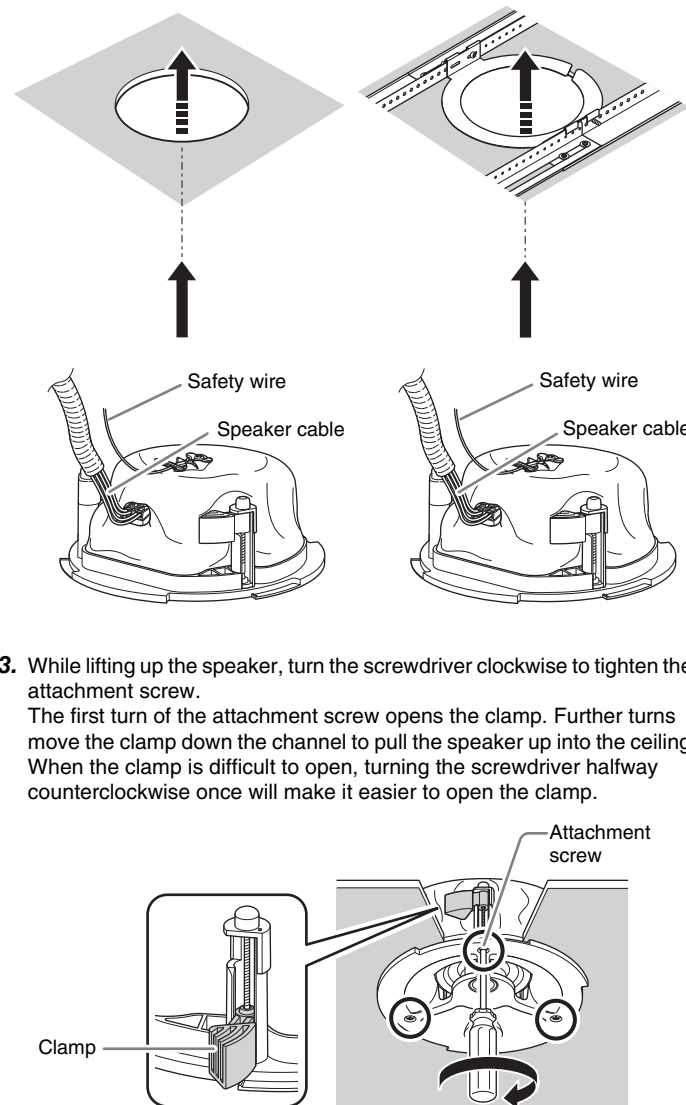

NOTICE

Do not over-tighten the attachment screws. Otherwise, the attachment screws and clamps will break.

Removing from the Ceiling

- While pressing the speaker against the ceiling, loosen the attachment screws by turning them counterclockwise. Loosen the screw and the clamp goes up, and as it reaches the top, the clamp closes as shown in figure below.

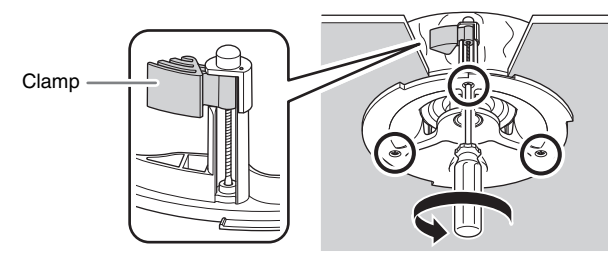

- Remove the safety wire from the speaker that is detached from the ceiling.

4 Set the Line Voltage/Impedance and Power

Select the line voltage/impedance (100 V, 70 V, 16 Ω) and power tap for a 100 V, 70 V line distributed system, by rotating the tap selector switch on the front side of the speaker with a flat-blade screwdriver. When using the speaker with high-impedance connection, select the position where wattage is indicated by the line (100 V, 70 V). Do not select the "x" setting when connecting to a 100 V line. When using it with low impedance connection, select the 16 Ω position.



The illustration indicates the setting at 6 W for a 100 V line and 3 W for a 70 V line.

NOTICE

- Make sure the amplifier is switched off before operating the tap selector switch.
- If the setting is incorrect, it may cause malfunction of the speaker and amplifier.

5 Attach the Grille

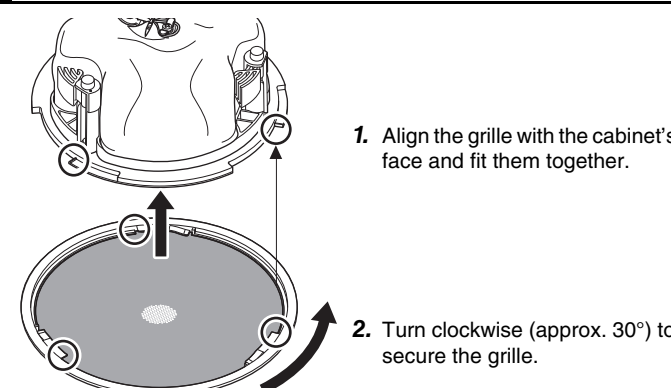

CAUTION

- If the grille is not sufficiently turned, it may fall off. Sufficiently turn the grille, until the fastening sections of the grille and speaker are securely engaged.
- If the ceiling material is soft, the baffle surface may sink into the ceiling material due to overtightening of the attachment screws, and the grill may not fit properly.

ADDRESS LIST

NORTH AMERICA

CANADA
Yamaha Canada Music Ltd.
 135 Milner Avenue, Toronto, Ontario,
 M1S 3R1, Canada
 Tel: +1-416-298-1311

U.S.A.
Yamaha Corporation of America
 6600 Orangethorpe Avenue, Buena Park, CA 90620,
 U.S.A.
 Tel: +1-714-522-9011

CENTRAL & SOUTH AMERICA

MEXICO
Yamaha de México, S.A. de C.V.
 Av. Insurgentes Sur 1647 Piso 9, Col. San José
 Insurgentes, Delegación Benito Juárez, CDMX,
 C.P. 03900, México
 Tel: +52-55-5804-0600

BRAZIL
Yamaha Musical do Brasil Ltda.
 Praça Professor José Lannes, 40, Cjs 21 e 22, Brooklin
 Paulista Novo CEP 04571-100 – São Paulo – SP, Brazil
 Tel: +55-11-3704-1377

ARGENTINA

**Yamaha Music Latin America, S.A.,
 Sucursal Argentina**
 Olga Cossetini 1553, Piso 4 Norte,
 Madero Este-C1107CEK,
 Buenos Aires, Argentina
 Tel: +54-11-4119-7000

PANAMA AND OTHER LATIN AMERICAN/CARIBBEAN REGIONS

Yamaha Music Latin America, S.A.
 Edif. Torre Bancos General, Piso 7, Urbanización
 Marbella, Calle 47 y Aquilino de la Guardia,
 Ciudad de Panamá, República de Panamá
 Tel: +507-269-5311

EUROPE

THE UNITED KINGDOM/IRELAND
Yamaha Music Europe GmbH (UK)
 Sherbourne Drive, Tilbrook, Milton Keynes,
 MK7 8BL, U.K.
 Tel: +44-1908-366700

GERMANY

Yamaha Music Europe GmbH
 Siemensstrasse 22-34, 25462 Rellingen, Germany
 Tel: +49-4101-303-0

SWITZERLAND/LIECHTENSTEIN

**Yamaha Music Europe GmbH, Branch Switzerland
 in Thalwil**
 Secstrasse 18a, 8800 Thalwil, Switzerland
 Tel: +41-44-3878080

**AUSTRIA/BULGARIA/
 CZECH REPUBLIC/HUNGARY/
 ROMANIA/SLOVAKIA/SLOVENIA**

**Yamaha Music Europe GmbH
 Branch Austria**
 Schleiergasse 20, 1100 Wien, Austria
 Tel: +43-1-60203900

POLAND

**Yamaha Music Europe GmbH
 Sp.z o.o. Oddzial w Polsce**
 ul. Wielicka 52, 02-657 Warszawa, Poland
 Tel: +48-22-880-08-88

MALTA

Olimpus Music Ltd.
 Valletta Road, Mosta MST9010, Malta
 Tel: +356-2133-2093

**NETHERLANDS/BELGIUM/
 LUXEMBOURG**

Yamaha Music Europe Branch Benelux
 Clarissenhof 5b, 4133 AB Vianen, The Netherlands
 Tel: +31-347-358040

FRANCE

Yamaha Music Europe
 7 rue Ambroise Croizat, Zone d'activités de Pariest,
 77183 Croissy-Beaubourg, France
 Tel: +33-1-6461-4000

ITALY

Yamaha Music Europe GmbH, Branch Italy
 Via Tinelli N.67/69 20855 Gerno di Lesmo (MB), Italy
 Tel: +39-039-9065-1

SPAIN/PORTUGAL

**Yamaha Music Europe GmbH Ibérica, Sucursal en
 España**
 Ctra. de la Coruña km. 17,200, 28231
 Las Rozas de Madrid, Spain
 Tel: +34-91-639-88-88

GREECE

Philippou Nakas S.A. The Music House
 19th km. Leof. Lavriou 190 02 Peania – Attiki,
 Greece
 Tel: +30-210-6686168

SWEDEN/FINLAND/ICELAND

**Yamaha Music Europe GmbH German filial
 Scandinavia**
 JA Wettergrensgata 1, 400 43 Göteborg, Sweden
 Tel: +46-31-89-34-00

DENMARK

**Yamaha Music Denmark,
 Filial of Yamaha Music Europe GmbH, Tyskland**
 Generatorvej 8C, ST. TH., 2860 Soborg, Denmark
 Tel: +45-44-92-49-00

NORWAY

**Yamaha Music Europe GmbH Germany -
 Norwegian Branch**
 Grini Næringspark 1, 1332 Østerås, Norway
 Tel: +47-6716-7800

CYPRUS

Yamaha Music Europe GmbH
 Siemensstrasse 22-34, 25462 Rellingen, Germany
 Tel: +49-4101-303-0

RUSSIA

Yamaha Music (Russia) LLC.
 Room 37, entrance 7, bld. 7, Kievskaya street, Moscow,
 121059, Russia
 Tel: +7-495-626-5005

OTHER EUROPEAN REGIONS

Yamaha Music Europe GmbH
 Siemensstrasse 22-34, 25462 Rellingen, Germany
 Tel: +49-4101-3030

AFRICA

Yamaha Music Gulf FZE
 JAFZA-16, Office 512, P.O.Box 17328,
 Jebel Ali FZE, Dubai, UAE
 Tel: +971-4-801-1500

MIDDLE EAST

TURKEY

**Yamaha Music Europe GmbH
 Merkezi Almany Türkiye İstanbul Şubesi**
 Mor Sumbul Sokak Varyap Meridian Business 1.Blok
 No:1 113-114-115
 Bati Atasehir Istanbul, Turkey
 Tel: +90-216-275-7960

OTHER REGIONS

Yamaha Music Gulf FZE
 JAFZA-16, Office 512, P.O.Box 17328,
 Jebel Ali FZE, Dubai, UAE
 Tel: +971-4-801-1500

ASIA

THE PEOPLE'S REPUBLIC OF CHINA
Yamaha Music & Electronics (China) Co.,Ltd.
 2F, Yunhedasha, 1818 Xinzha-lu, Jingan-qu,
 Shanghai, China
 Tel: +86-400-051-7700

INDIA

Yamaha Music India Private Limited
 P-401, JMD Megapolis, Sector-48, Sohna Road,
 Gurugram-122018, Haryana, India
 Tel: +91-124-485-3300

INDONESIA

PT Yamaha Musik Indonesia Distributor
 Yamaha Music Center Bldg. Jalan Jend. Gatot Subroto
 Kav. 4, Jakarta 12930, Indonesia
 Tel: +62-21-520-2577

KOREA

Yamaha Music Korea Ltd.
 11F, Prudential Tower, 298, Gangnam-daero,
 Gangnam-gu, Seoul, 06253, Korea
 Tel: +82-2-3467-3300

MALAYSIA

Yamaha Music (Malaysia) Sdn. Bhd.
 No.8, Jalan Perbandaran, Kelana Jaya, 47301
 Petaling Jaya, Selangor, Malaysia
 Tel: +60-3-78030900

SINGAPORE

Yamaha Music (Asia) Private Limited
 Block 202 Hougang Street 21, #02-00,
 Singapore 530202, Singapore
 Tel: +65-6740-9200

TAIWAN

Yamaha Music & Electronics Taiwan Co.,Ltd.
 2F., No.1, Yuandong Rd., Banqiao Dist.,
 New Taipei City 22063, Taiwan (R.O.C.)
 Tel: +886-2-7741-8888

THAILAND

Siam Music Yamaha Co., Ltd.
 3, 4, 15, 16th Fl., Siam Motors Building,
 891/1 Rama 1 Road, Wangmai,
 Pathumwan, Bangkok 10330, Thailand
 Tel: +66-2215-2622

VIETNAM

Yamaha Music Vietnam Company Limited
 15th Floor, Nam A Bank Tower, 201-203 Cach Mang
 Thang Tam St., Ward 4, Dist.3,
 Ho Chi Minh City, Vietnam
 Tel: +84-8-3818-1122

OTHER ASIAN REGIONS

<http://asia.yamaha.com/>

OCEANIA

AUSTRALIA
Yamaha Music Australia Pty. Ltd.
 Level 1, 80 Market Street, South Melbourne,
 VIC 3205, Australia
 Tel: +61-3-9693-5111

**REGIONS AND TRUST TERRITORIES
 IN PACIFIC OCEAN**

<http://asia.yamaha.com/>

Head Office/Manufacturer: Yamaha Corporation 10-1, Nakazawa-cho, Naka-ku, Hamamatsu, 430-8650, Japan
Importer (European Union): Yamaha Music Europe GmbH Siemensstrasse 22-34, 25462 Rellingen, Germany
Importer (United Kingdom): Yamaha Music Europe GmbH (UK) Sherbourne Drive, Tilbrook, Milton Keynes, MK7 8BL, United Kingdom

Dimensions

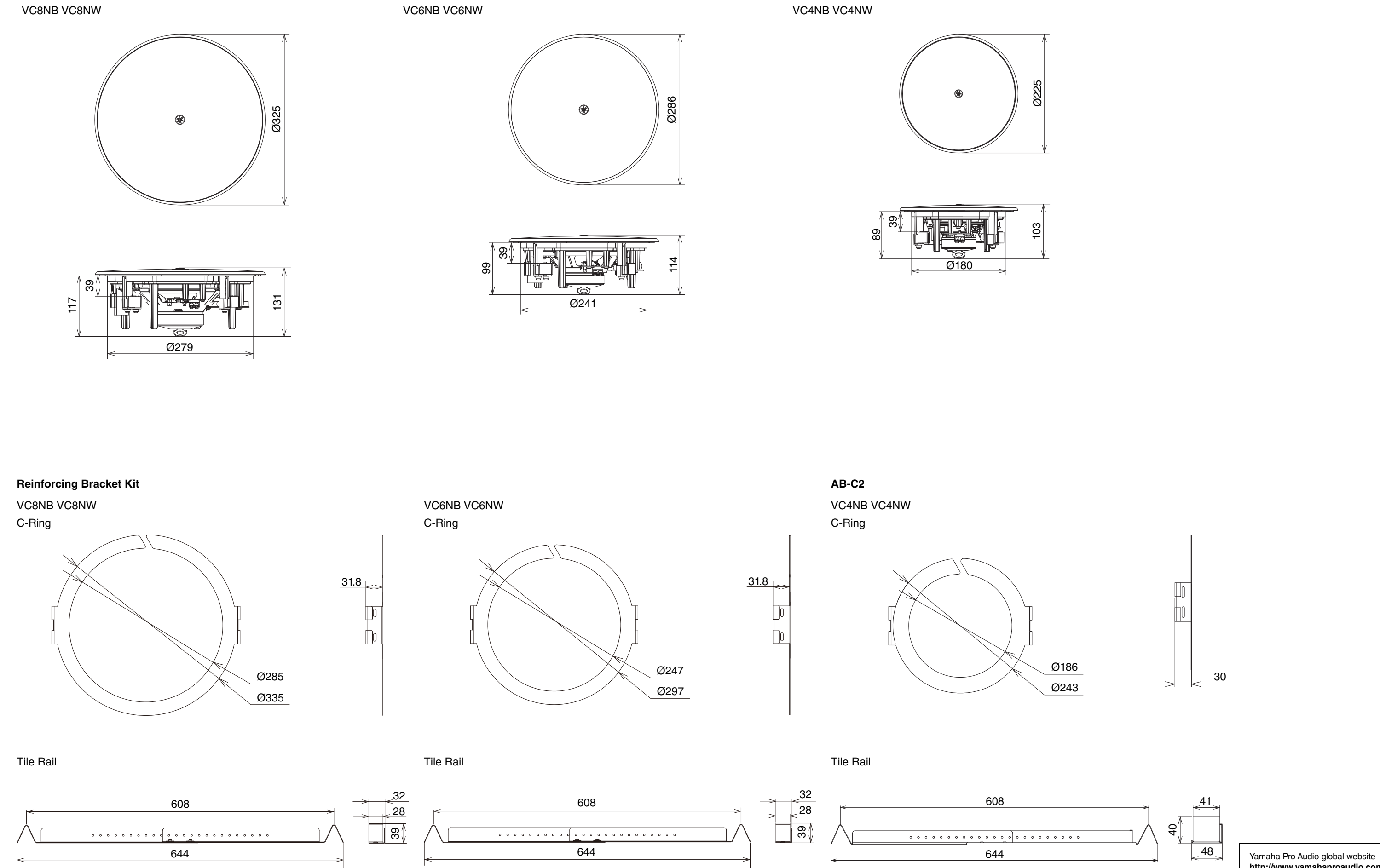

Yamaha Pro Audio global website
<http://www.yamahaproaudio.com/>
 Yamaha Downloads
<https://download.yamaha.com/>

Free Manuals Download Website

<http://myh66.com>

<http://usermanuals.us>

<http://www.somanuals.com>

<http://www.4manuals.cc>

<http://www.manual-lib.com>

<http://www.404manual.com>

<http://www.luxmanual.com>

<http://aubethermostatmanual.com>

Golf course search by state

<http://golfingnear.com>

Email search by domain

<http://emailbydomain.com>

Auto manuals search

<http://auto.somanuals.com>

TV manuals search

<http://tv.somanuals.com>