



VF250
VF225
VF200

OWNER'S MANUAL

⚠ Read this manual carefully before operating this outboard motor.

U.S.A. Edition
LIT-18626-08-91
6CB-28199-11

⚠ WARNING

The engine exhaust from this product contains chemicals known to the State of California to cause cancer, birth defects or other reproductive harm.

YAMAHA

LIT-CALIF-65-01

ZMU01690

Read this manual carefully before operating this outboard motor. Keep this manual onboard in a waterproof bag when boating. This manual should stay with the outboard motor if it is sold.

Important manual information

EMU31285

To the owner

Thank you for selecting a Yamaha outboard motor. This Owner's Manual contains information needed for proper operation, maintenance and care. A thorough understanding of these simple instructions will help you obtain maximum enjoyment from your new Yamaha. If you have any question about the operation or maintenance of your outboard motor, please consult a Yamaha dealer.

In this Owner's Manual particularly important information is distinguished in the following ways.



: This is the safety alert symbol. It is used to alert you to potential personal injury hazards. Obey all safety messages that follow this symbol to avoid possible injury or death.

EWV00781



WARNING

A WARNING indicates a hazardous situation which, if not avoided, could result in death or serious injury.

ECM00701

NOTICE

A NOTICE indicates special precautions that must be taken to avoid damage to the outboard motor or other property.

TIP:

A TIP provides key information to make procedures easier or clearer.

Yamaha continually seeks advancements in product design and quality. Therefore, while this manual contains the most current product information available at the time of printing, there may be minor discrepancies between

your machine and this manual. If there is any question concerning this manual, please consult your Yamaha dealer.

TIP:

The VF250A, VF225A, VF200A and the standard accessories are used as a base for the explanations and illustrations in this manual. Therefore some items may not apply to every model.

EMU25112

**VF250, VF225, VF200
OWNER'S MANUAL
©2009 by Yamaha Motor Corporation,
U.S.A.**

**1st edition, December 2009
All rights reserved.**

**Any reprinting or unauthorized use
without the written permission of
Yamaha Motor Corporation, U.S.A.
is expressly prohibited.**

**Printed in Japan
P/N LIT-18626-08-91**

Table of contents

Safety information.....	1	Remote control requirements.....	14
Outboard motor safety	1	Battery requirements.....	14
Propeller	1	Specifications of Battery.....	14
Rotating parts	1	Mounting battery.....	15
Hot parts.....	1	Propeller selection	15
Electric shock	1	Start-in-gear protection	15
Power trim and tilt.....	1	Engine oil requirements	15
Engine shut-off cord (lanyard)	1	Fuel requirements	16
Gasoline	1	Gasoline	16
Gasoline exposure and spills	2	Gasoline Additives.....	17
Carbon monoxide.....	2	Anti-fouling paint	18
Modifications	2	Outboard motor disposal	
Boating safety	2	requirements.....	18
Alcohol and drugs.....	2	Emergency equipment.....	18
Personal flotation devices (PFDs).....	2	Emission control information.....	18
People in the water.....	2	North American models.....	18
Passengers	2	Star labels	19
Overloading	2	Components	21
Avoid collisions.....	3	Components diagram.....	21
Weather.....	3	Remote control box	24
Accident reporting	3	Remote control lever	24
Boat education and training.....	3	Neutral interlock trigger	24
Passenger training	4	Free accelerator	25
Boating safety publications.....	4	Throttle friction adjuster.....	25
Laws and regulations	4	Engine shut-off cord (lanyard) and	
Boating organizations.....	4	clip.....	26
Basic boating rules		Main switch.....	27
(Rules of the road)	4	Power trim and tilt switch on remote	
Steering and sailing rules and sound		control	27
signals.....	4	Power trim and tilt switch on bottom	
Rules when encountering vessels.....	5	cowling	27
Other special situations	6	Cowling lock lever	28
General information	9	Flushing device	28
Identification numbers record	9	Fuel filter.....	28
Outboard motor serial number	9	Tilt support shaft (optional).....	29
Key number	9	Instruments and indicators.....	31
Read manuals and labels.....	10	Digital tachometer.....	31
Warning labels.....	10	Tachometer	31
Specifications and requirements... 13		Trim meter	31
Specifications	13	Hour meter	31
Installation requirements	14	Low oil pressure-alert indicator	31
Boat horsepower rating	14	Overheat-alert indicator	32
Mounting outboard motor	14		

Table of contents

Digital speedometer	32	Engine shut-off cord (lanyard)	50
Speedometer	32	Engine oil	50
Fuel gauge	33	Outboard motor	51
Trip meter / Clock / Voltmeter	33	Flushing device	51
Fuel level-alert indicator	34	Installing top cowling	51
Low battery voltage-alert indicator ...	34	Checking power trim and tilt unit	52
Fuel management meter	34	Battery	53
Fuel flow meter	35	Filling fuel	53
Fuel consumption meter / Fuel economy meter / Twin engine speed synchronizer	35	Operating engine	54
Water separator-alert indicator	37	Sending fuel	54
Command Link meter	37	Starting engine	54
Command Link tachometer	37	Checks after starting engine	56
Start-up checks	38	Cooling water	56
Low oil pressure-alert	38	Warming up engine	57
Overheat alert	39	Procedure for warming up engine ...	57
Water separator alert	39	Checks after engine warm up	57
Engine trouble alert	39	Shifting	57
Low battery voltage-alert	40	Stop switches	57
Command Link speed & fuel meter	40	Shifting	57
Command Link speedometer	41	Stopping boat	58
Command Link fuel management meter	42	Stopping engine	59
Engine control system	43	Procedure for stopping engine	59
Alert system	43	Trimming outboard motor	59
Overheat alert	43	Adjusting trim angle	60
Low oil pressure alert	43	Adjusting boat trim	60
Water separator alert	44	Tilting up and down	61
Installation	46	Procedure for tilting up	61
Installation	46	Procedure for tilting down	63
Mounting the outboard motor	46	Shallow water	63
Operation	48	Cruising in shallow water	63
First-time operation	48	Operating in other conditions	64
Filling engine oil	48	Maintenance	65
Breaking in engine	48	Transporting and storing outboard motor	65
Getting to know your boat	48	Storing outboard motor	65
Checks before starting engine	48	Conditioning and stabilizing gasoline	65
Fuel level	49	Procedure	65
Removing top cowling	49	Lubrication	66
Fuel system	49	Cleaning and anticorrosion measures	66
Controls	50	Flushing cooling water passage	66

Table of contents

Checking painted surface of outboard motor.....	67
Periodic maintenance.....	67
Replacement parts	67
Maintenance interval guidelines	68
Maintenance chart 1	69
Maintenance chart 2.....	71
Greasing.....	72
Inspecting spark plug	73
Inspecting engine idle speed.....	74
Changing engine oil.....	74
Inspecting wiring and connectors.....	76
Inspecting propeller	77
Removing propeller	77
Installing propeller	78
Changing gear oil	78
Inspecting and replacing anodes.....	80
Inspecting the battery	80
Connecting the battery	81
Disconnecting the battery.....	81
Trouble Recovery	82
Troubleshooting	82
Temporary action in emergency....	85
Impact damage.....	85
Replacing fuse.....	85
Power trim and tilt unit will not operate	86
Water separator-alert indicator blinks while cruising	86
Treatment of submerged outboard motor	87
Consumer information.....	89
YAMAHA MOTOR CORPORATION, U.S.A. FOUR-STROKE OUTBOARD MOTOR THREE-YEAR LIMITED WARRANTY	89
IMPORTANT WARRANTY INFORMATION IF YOU USE YOUR YAMAHA OUTSIDE THE USA OR CANADA	91

EMU33622

Outboard motor safety

Observe these precautions at all times.

EMU36501

Propeller

People can be injured or killed if they come in contact with the propeller. The propeller can keep moving even when the motor is in neutral, and sharp edges of the propeller can cut even when stationary.

- Stop the engine when a person is in the water near you.
- Keep people out of reach of the propeller, even when the engine is off.

EMU40271

Rotating parts

Hands, feet, hair, jewelry, clothing, personal flotation device (PFD) straps, etc., can become entangled with internal rotating parts of the engine, resulting in serious injury or death. Keep the top cowling in place whenever possible. Do not remove or replace the top cowling with the engine running.

Only operate the engine with the top cowling removed according to the specific instructions in the manual. Keep hands, feet, hair, jewelry, clothing, PFD straps, etc., away from any exposed moving parts.

EMU33640

Hot parts

During and after operation, engine parts are hot enough to cause burns. Avoid touching any parts under the top cowling until the engine has cooled.

EMU33650

Electric shock

Do not touch any electrical parts while starting or operating the engine. They can cause shock or electrocution.

EMU40861

Power trim and tilt

Body parts can be crushed between the outboard motor and the clamp bracket when the outboard motor is trimmed or tilted. Keep

body parts out of this area at all times. Make sure that no one is in this area before operating the power trim and tilt mechanism.

The power trim and tilt switches operate even when the main switch is turned to the “OFF” (off) position. Keep people away from the power trim and tilt switches whenever working around the outboard motor.

Never get under the outboard motor while it is tilted, even when the tilt support shaft is installed. Severe injury could occur if the outboard motor accidentally falls.

EMU41251

Engine shut-off cord (lanyard)

Attach the engine shut-off cord so that the engine stops if the operator falls overboard or leaves the helm. This prevents the boat from running away under power and leaving people stranded, or running over people or objects.

Always attach the engine shut-off cord to a secure place on your clothing or your arm or leg while operating. Do not remove it to leave the helm while the boat is moving. Do not attach the engine shut-off cord to clothing that could tear loose, or route the engine shut-off cord where it could become entangled, preventing it from functioning.

Do not route the engine shut-off cord where it is likely to be accidentally pulled out. If the engine shut-off cord is pulled during operation, the engine will shut off and you will lose most steering control. The boat could slow rapidly, throwing people and objects forward.

EMU33810

Gasoline

Gasoline and its vapors are highly flammable and explosive. Always, refuel according to the procedure on page 54 to reduce the risk of fire and explosion.

Safety information

EMU33820

Gasoline exposure and spills

Take care not to spill gasoline. If gasoline spills, wipe it up immediately with dry rags. Dispose of rags properly.

If any gasoline spills onto your skin, immediately wash with soap and water. Change clothing if gasoline spills on it.

If you swallow gasoline, inhale a lot of gasoline vapor, or get gasoline in your eyes, get immediate medical attention. Never siphon fuel by mouth.

EMU33900

Carbon monoxide

This product emits exhaust gases which contain carbon monoxide, a colorless, odorless gas which may cause brain damage or death when inhaled. Symptoms include nausea, dizziness, and drowsiness. Keep cockpit and cabin areas well ventilated. Avoid blocking exhaust outlets.

EMU33780

Modifications

Do not attempt to modify this outboard motor. Modifications to your outboard motor may reduce safety and reliability, and render the outboard unsafe or illegal to use.

EMU33740

Boating safety

This section includes a few of the many important safety precautions that you should follow when boating.

EMU33710

Alcohol and drugs

Never operate after drinking alcohol or taking drugs. Intoxication is one of the most common factors contributing to boating fatalities.

EMU40280

Personal flotation devices (PFDs)

Have an approved PFD on board for every occupant. Yamaha recommends that you must wear a PFD whenever boating. At a minimum, children and non-swimmers should always

wear PFDs, and everyone should wear PFDs when there are potentially hazardous boating conditions.

EMU33731

People in the water

Always watch carefully for people in the water, such as swimmers, skiers, or divers, whenever the engine is running. When someone is in the water near the boat, shift into neutral and stop the engine.

Stay away from swimming areas. Swimmers can be hard to see.

The propeller can keep moving even when the motor is in neutral. Stop the engine when a person is in the water near you.

EMU33751

Passengers

Consult your boat manufacturer's instructions for details about appropriate passenger locations in your boat and be sure all passengers are positioned properly before accelerating and when operating above an idle speed. Standing or sitting in non-designated locations may result in being thrown either overboard or within the boat due to waves, wakes, or sudden changes in speed or direction. Even when people are positioned properly, alert your passengers if you must make any unusual maneuver. Always avoid jumping waves or wakes.

EMU33760

Overloading

Do not overload the boat. Consult the boat capacity plate or boat manufacturer for maximum weight and number of passengers. Be sure that weight is properly distributed according to the boat manufacturers instructions. Overloading or incorrect weight distribution can compromise the boats handling and lead to an accident, capsizing or swamping.

EMU33772

Avoid collisions

Scan constantly for people, objects, and other boats. Be alert for conditions that limit your visibility or block your vision of others.

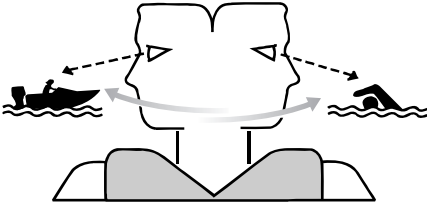

ZMU06025

Operate defensively at safe speeds and keep a safe distance away from people, objects, and other boats.

- Do not follow directly behind other boats or waterskiers.
- Avoid sharp turns or other maneuvers that make it hard for others to avoid you or understand where you are going.
- Avoid areas with submerged objects or shallow water.
- Ride within your limits and avoid aggressive maneuvers to reduce the risk of loss of control, ejection, and collision.
- Take early action to avoid collisions. Remember, boats do not have brakes, and stopping the engine or reducing throttle can reduce the ability to steer. If you are not sure that you can stop in time before hitting an obstacle, apply throttle and turn in another direction.

EMU33790

Weather

Stay informed about the weather. Check weather forecasts before boating. Avoid boating in hazardous weather.

EMU33800

Accident reporting

Boat operators are required by law to file a Boating Accident Report with their state boating law enforcement agency if their boat is involved in any of the following accidents:

1. There is loss of life or probable loss of life.
2. There is personal injury that requires medical attention beyond first aid.
3. There is property damage to boats or other property over a certain amount.
4. There is complete loss of a boat.

Contact local law enforcement personnel if a report is necessary.

EMU33870

Boat education and training

Operators should take a boating safety course. This may be required in your state. Many of the organizations listed in the next section can provide information about courses in your area.

You may also want to consider an Internet-based program for basic boater education. The Online Boating Safety Course provided by the BoatU.S. Foundation, is approved by the National Association of State Boating Law Administrators (NASBLA) and recognized by the United States Coast Guard. Most, but not all, states accept this course to meet their minimum requirements. While it cannot replace an in-depth course such as one offered by the U.S. Coast Guard, U.S. Power Squadron, or other organization, this online course does provide a general overview of the basics in boating safety, requirements, navigation, and operation. Upon successful completion of the course, the user can download a certificate of completion immediately or, for a small charge, request one by mail. To take this free course, go to boatus.org.

Safety information

EMU33880

Passenger training

Make sure at least one other passenger is trained to operate the boat in the event of an emergency.

EMU33890

Boating safety publications

Be informed about boating safety. Additional publications and information can be obtained from many boating organizations.

EMU33590

Laws and regulations

Know the marine laws and regulations where you will be boating- and obey them. Several sets of rules prevail according to geographic location, but all are basically the same as the International Rules of the Road. The rules presented in the following section are condensed- and have been provided for your convenience only.

Contact the U.S. Coast Guard, the National Association of State Boating Law Administrators, or your local Power Squadron for a complete set of rules governing the waters in which you will be using your boat.

EMU33682

Boating organizations

The following organizations provide boating safety training and information about boating safety and laws.

United States Coast Guard

Consumer Affairs Staff (G-BC)
Office of Boating, Public, and Consumer Affairs

U.S. Coast Guard Headquarters

Washington, D.C. 20593-0001

<http://www.uscgboating.org/>

United States Power Squadrons

1-888-FOR-USPS (1-888-367-8777)

<http://www.usps.org/>

Boat Owners Association of The United States

1-800-336-BOAT (1-800-336-2628)

<http://www.boatus.com/>

National Association of State Boating Law Administrators (NASBLA)

1500 Leestown Road, Suite 330

Lexington, KY 40511 859-225-9497

<http://www.nasbla.org/>

National Marine Manufacturers Association (NMMA)

200 East Randolph Drive

Suite 5100

Chicago, IL 60601

<http://www.nmma.org/>

Marine Retailers Association of America

155 N. Michigan Ave. Chicago,

IL 60304

<http://www.mraa.com/>

EMU33691

Basic boating rules (Rules of the road)

Just as there are rules that apply when you are driving on streets and highways, there are waterway rules that apply when you are driving your boat. These rules are used internationally. (For U.S.A.: and are also enforced by the United States Coast Guard and local agencies.) You should be aware of these rules, and follow them whenever you encounter another vessel on the water.

EMU33700

Steering and sailing rules and sound signals

Whenever two vessels on the water meet one another, one vessel has the right-of-way; it is called the "stand-on" vessel. The vessel that does not have the right-of-way is called the

“give-way” or “burdened” vessel. These rules determine which vessel has the right-of-way, and what each vessel should do.

Stand-on vessel

The vessel with the right-of-way has the duty to continue its course and speed, except to avoid an immediate collision. When you maintain your direction and speed, the other vessel will be able to determine how best to avoid you.

Give-way vessel

The vessel that does not have the right-of-way has the duty to take positive and timely action to stay out of the way of the Stand-On vessel. Normally, you should not cross in front of the vessel with the right-of-way. You should slow down or change directions briefly and pass behind the other vessel. You should always move in such a way that the operator of the other vessel can see what you are doing.

“ The general prudential rule ”

This rule is called Rule 2 in the International Rules and says,

“ In obeying and construing these rules due regard shall be had to all dangers of navigation and collision, and to any special circumstances, which may render a departure from the above rules necessary in order to avoid immediate danger.”

In other words, follow the standard rules except when a collision will occur unless both vessels try to avoid each other. If that is the case, both vessels become “ Give-Way ” vessels.

EMU25521

Rules when encountering vessels

There are three main situations that you may encounter with other vessels which could lead to a collision unless the Steering Rules are followed:

Meeting: (you are approaching another vessel head-on)

Crossing: (you are traveling across the other vessel’s path)

Overtaking: (you are passing or being passed by another vessel)

In the following illustration, your boat is in the center. You should give the right-of-way to any vessels shown in white area (you are the Give-Way vessel). Any vessels in the shaded area must yield to you (they are the Give-Way vessels). Both you and the meeting vessel must alter course to avoid each other.

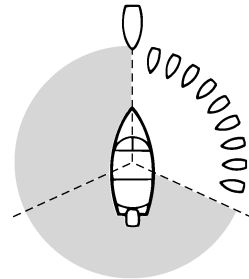

ZMU01705

Meeting

If you are meeting another power vessel head on, and are close enough to run the risk of collision, neither of you has the right-of-way Both of you should alter course to avoid an accident. You should keep the other vessel on your port (left) side. This rule doesn’t apply if both of you will clear one another if you continue on your set course and speed.

Safety information

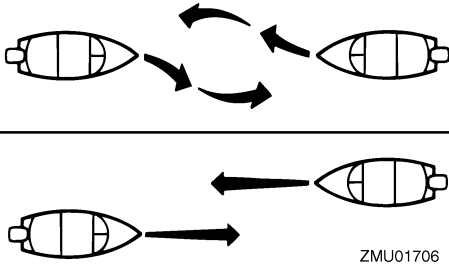

Crossing

When two power driven vessels are crossing each other's path close enough to run the risk of collision, the vessel which has the other on the starboard (right) side must keep out of the way of the other. If the other vessel is on your right, you must keep out of its way; you are the Give-Way vessel. If the other vessel is on your port (left) side, remember that you should maintain course and direction, provided the other vessel gives you the right-of-way as it should.

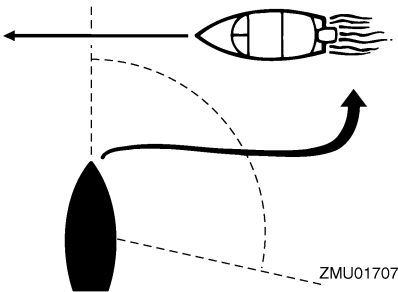

Overtaking

If you are passing another vessel, you are the "Give-Way" vessel. This means that the other vessel is expected to maintain its course and speed. You must stay out of its way until you are clear of it. Likewise, if another vessel is passing you, you should maintain your speed and direction so that the other vessel can steer itself around you.

EMU25531

Other special situations

There are three other rules you should be aware of when driving your boat around other vessels.

Narrow channels and bends

When navigating in narrow channels, you should keep to the right when it is safe and practical to do so. If the operator of a power-driven vessel is preparing to go around a bend that may obstruct the view of other water vessels, the operator should sound a prolonged blast on the whistle (4 to 6 seconds). If another vessel is around the bend, it too should sound the whistle. Even if no reply is heard, however, the vessel should still proceed around the bend with caution. If you navigate such waters with your boat, you will need to carry a portable air horn, available from local marine supply stores.

Fishing vessel right-of-way

All vessels that are fishing with nets, lines or trawls are considered to be "fishing vessels" under the International Rules. Vessels with trolling lines are not considered fishing vessels. Fishing vessels have the right-of-way regardless of position. Fishing vessels cannot, however, impede the passage of other vessels in narrow channels.

Sailing vessel right-of-way

Sailing vessels should normally be given the right-of-way. The exceptions to this are:

1. When the sailing vessel is overtaking the power-driven vessel, the power-driven vessel has the right-of-way.
2. Sailing vessels should keep clear of any fishing vessel.
3. In a narrow channel, a sailing vessel should not hamper the safe passage of a power-driven vessel that can navigate only in such a channel.

Reading buoys and other markers

The waters of the United States are marked for safe navigation by the lateral system of buoyage. Simply put, buoys and markers have an arrangement of shapes, colors, numbers and lights to show which side of the buoy a boater should pass on when navigating in a particular direction. The markings on these buoys are oriented from the perspective of being entered from seaward (the boater is going towards the port). This means that red buoys are passed on the starboard (right) side when proceeding from open water into port, and black buoys are to port (left) side. When navigating out of port, your position with respect to the buoys should be reversed; red buoys should be to port and black buoys to starboard.

Many bodies of water used by boaters are entirely within the boundaries of a particular state. The Uniform State Waterway Marking System has been devised for these waters. This system uses buoys and signs with distinctive shapes and colors to show regulatory or advisory information. These markers are white with black letters and orange borders. They signify speed zones, restricted areas, danger areas, and general information.

Remember, markings may vary by geographic location. Always consult local boating authorities before driving your boat in unfamiliar waters.

Safety information

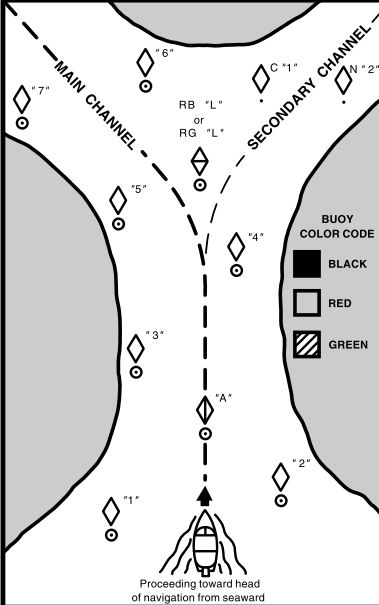
 <p>Proceeding toward head of navigation from seaward</p>	<p>MAIN CHANNEL BUOYS</p> <p>◇ "1" "3" "5" "7"</p> <p>○ LIGHTED BUOY (Port Hand)</p> <p>Odd number, increasing toward head of navigation, Leave to port (left) proceeding upstream.</p> <p>White Light OR Green Light</p> <p>old OR new</p>
<p>SECONDARY CHANNEL BUOYS STARTS NEW NUMBERING SYSTEM</p>	<p>◇ "2" "4" "6"</p> <p>○ LIGHTED BUOY (Starboard Hand)</p> <p>Even number, increasing toward head of navigation, Leave to starboard (right) proceeding upstream.</p> <p>White Light OR Red Light</p> <p>old OR new</p>
<p>◇ C "1"</p> <p>CAN BUOY</p> <p>Odd number, Leave to port.</p> <p>old OR new</p>	<p>◇ "A"</p> <p>LIGHTED SAFE WATER BUOY</p> <p>No number, Marks midchannel, pass on either side, Letter has no lateral significance, used for identification and location purposes.</p> <p>White Light OR Top Mark White Light</p> <p>old OR new</p>
<p>◇ N "2"</p> <p>NUN BUOY</p> <p>Even number, Leave to starboard</p> <p>No change</p>	<p>◇ RB "L" OR ◇ RG "L"</p> <p>LIGHTED PREFERRED CHANNEL TO PORT BUOY</p> <p>No number, Topmost band red – preferred channel is to left of buoy, Letter has no lateral significance, used for identification and location purposes.</p> <p>Red or White Light OR Red Light</p> <p>old OR new</p>

ZMU01708

EMU25171

Identification numbers record

EMU40380

Outboard motor serial number

The outboard motor serial number is stamped on the label attached to the port side of the clamp bracket.

Write down your outboard motor serial number in the spaces provided in the following illustration to assist you in ordering spare parts from your Yamaha dealer or for reference if your outboard motor is stolen.

--	--	--	--

ZMU01693

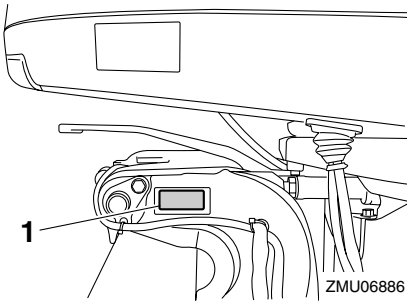

ZMU06886

1. Outboard motor serial number location

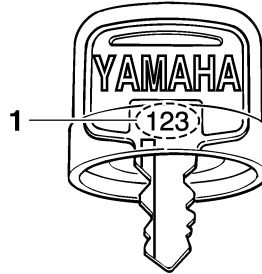

1. Key number

ZMU01694

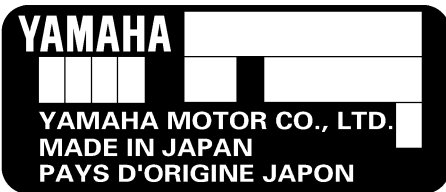

ZMU01692

EMU40391

Key number

A main switch key is included with the switch panel or remote control box. The key identification number is stamped on your key as shown in the illustration. Write down this number in the space provided for reference when ordering a new key.

General information

EMU33521

Read manuals and labels

Before operating or working on this outboard motor:

- Read this manual.
 - Read any manuals supplied with the boat.
 - Read all labels on the outboard motor and the boat.
- If you need any additional information, contact your Yamaha dealer.

EMU33831

Warning labels

If these labels are damaged or missing, contact your Yamaha dealer for replacements.

VF250A, VF225A, VF200A

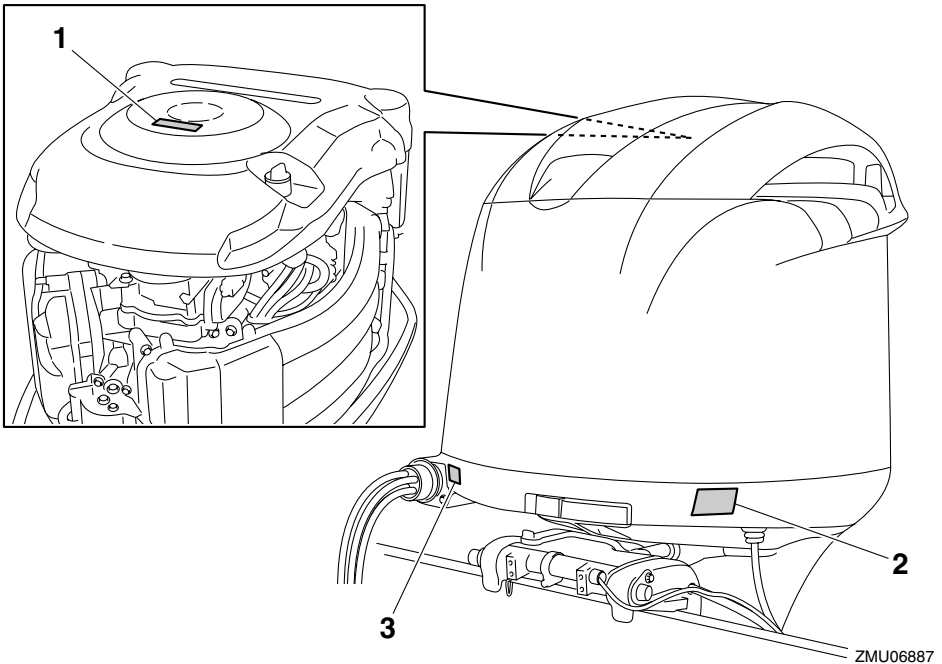

1



2

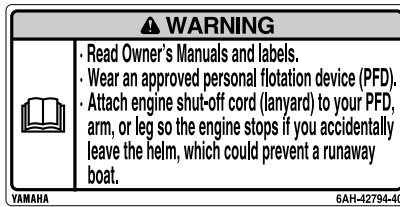

ZMU05741

EMU33850

Other labels

EMU40290

Symbols

The following symbols mean as follows.

3

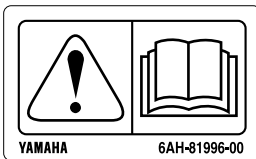

ZMU05710

Notice/Warning



ZMU05696

General information

Read Owner's Manual



ZMU05664

Remote control lever operating direction, dual direction



ZMU05667

Hazard caused by continuous rotation

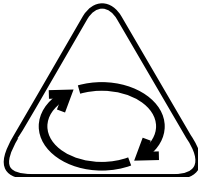

ZMU05665

Engine start/Engine cranking

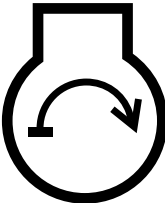

ZMU05668

Electrical hazard

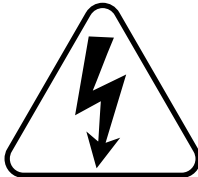

ZMU05666

Specifications and requirements

EMU40500

Specifications

TIP:

“(SUS)” indicates that the specification is for the outboard motor when it is equipped with a stainless steel propeller.

EMU2821J

Dimension:

Overall length:

959 mm (37.8 in)

Overall width:

664 mm (26.1 in)

Overall height L:

1749 mm (68.9 in)

Transom height L:

493 mm (19.4 in)

Weight (SUS) L:

234.0 kg (516 lb)

Performance:

Full throttle operating range:

5000–6000 r/min

Maximum output:

VF200A 147.0 kW@6000 r/min (200

HP@6000 r/min)

VF225A 165.0 kW@6000 r/min (225

HP@6000 r/min)

VF250A 184.0 kW@6000 r/min (250

HP@6000 r/min)

Idle speed (in neutral):

750 ±50 r/min

Engine:

Type:

4-stroke V

Displacement:

4169.0 cm³

Bore × stroke:

96.0 × 96.0 mm (3.78 × 3.78 in)

Ignition system:

TCI

Spark plug (NGK):

LFR6A-11

Spark plug gap:

1.0–1.1 mm (0.039–0.043 in)

Control system:

Remote control

Starting system:

Electric starter

Starting carburetion system:

Electronic fuel injection

Valve clearance (cold engine) IN:

0.17–0.24 mm (0.0067–0.0094 in)

Valve clearance (cold engine) EX:

0.31–0.38 mm (0.0122–0.0150 in)

Min. cold cranking amps (CCA/SAE):

700.0 A

Min. marine cranking amps (MCA/ABYC):

900.0 A

Min. reserve capacity (RC/SAE):

220 minutes

Maximum generator output:

49 A

Drive unit:

Gear positions:

Forward-neutral-reverse

Gear ratio:

1.75(21/12)

Trim and tilt system:

Power trim and tilt

Propeller mark:

T

Fuel and oil:

Recommended fuel:

VF200A Regular unleaded gasoline

VF225A Premium unleaded gasoline

VF250A Premium unleaded gasoline

Min. pump octane:

VF200A 87

VF225A 89

VF250A 89

Recommended engine oil:

YAMALUBE 4-M FC-W or 4-stroke outboard motor oil

Specifications and requirements

Recommended engine oil group:

SAE 5W-30/10W-30

API SE/SF/SG/SH/SJ/SL

Total engine oil quantity (oil pan capacity):

7.1 L (7.50 US qt, 6.25 Imp.qt)

Lubrication:

Wet sump

Recommended gear oil:

YAMALUBE MARINE LOWER UNIT

GEAR LUBE HD or Hypoid gear oil:

SAE 90, API GL-4/GL-5 or

SAE 80W, API GL-5

Gear oil quantity:

1.045 L (1.105 US qt, 0.920 Imp.qt)

Tightening torque for engine:

Spark plug:

28.0 Nm (2.86 kgf-m, 20.7 ft-lb)

Propeller nut:

54.0 Nm (5.51 kgf-m, 39.8 ft-lb)

EMU33554

Installation requirements

EMU40480

Boat horsepower rating

EWM01560



WARNING

Overpowering a boat can cause severe instability.

Before mounting the outboard motor, check that the horsepower of the outboard motor does not exceed the maximum horsepower rating on the capacity plate of the boat. If the boat does not have a capacity plate, consult the boat manufacturer.

EMU40490

Mounting outboard motor

EWM02500



WARNING

- **Improper mounting of the outboard motor could result in hazardous conditions such as poor handling, loss of control, or fire hazards.**

- **Because the outboard motor is very heavy, special equipment and training is required to mount it safely.**
-

Your dealer or other person experienced in proper rigging should mount the outboard motor using correct equipment and complete rigging instructions. For further information, see page 46.

EMU33581

Remote control requirements

EWM01580



WARNING

- **If the engine starts in gear, the boat can move suddenly and unexpectedly, possibly causing a collision or throwing passengers overboard.**
 - **If the engine ever starts in gear, the start-in-gear protection device is not working correctly and you should discontinue using the outboard. Contact your Yamaha dealer.**
-

The remote control unit must be equipped with a start-in-gear protection device(s). This device prevents the engine from starting unless it is in neutral.

EMU25694

Battery requirements

EMU25713

Specifications of Battery

Use a fully charged battery that meets the following specifications. The engine cannot be started if battery voltage is too low.

Minimum cold cranking amps

(CCA/SAE):

700.0 A

Minimum marine cranking amps

(MCA/ABYC):

900.0 A

Minimum reserve capacity (RC/SAE):

220 minutes

Specifications and requirements

ECM01061

NOTICE

Do not use a battery that does not meet the specified capacity. If a battery that does not meet specifications is used, the electric system could perform poorly or be overloaded, causing electric system damage.

EMU36290

Mounting battery

Mount the battery holder securely in a dry, well-ventilated, vibration-free location in the boat. **WARNING! Do not put flammable items, or loose heavy or metal objects in the same compartment as the battery. Fire, explosion or sparks could result.**

[EWM01820]

EMU41281

Propeller selection

Next to selecting an outboard motor, selecting the right propeller is one of the most important purchasing decisions a boater can make. The type, size, and design of your propeller have a direct impact on acceleration, top speed, fuel economy, and even engine life. Yamaha designs and manufactures propellers for every Yamaha outboard motor and every application.

Your Yamaha dealer can help you select the right propeller for your boating needs. Select a propeller that will allow the engine to reach the middle or upper half of the operating range at full throttle with the maximum boat-load. Generally, select a larger pitch propeller for a smaller operating load and a smaller pitch propeller for a heavier load. If you carry loads that vary widely, select the propeller that lets the engine run in the proper range for your maximum load but remember that you may need to reduce your throttle setting to stay within the recommended engine speed range when carrying lighter loads.

Yamaha recommends “Ventless Design For new 4-stroke VMAX SHO” for your propeller. For further information, consult your Yamaha dealer.

To check the propeller, see page 77.

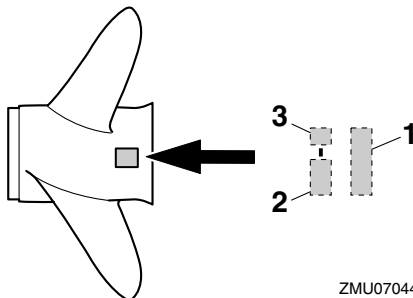

ZMU07044

1. Propeller pitch in inches
2. Propeller diameter in inches
3. Type of propeller (propeller mark)

EMU25770

Start-in-gear protection

Yamaha outboard motors or Yamaha-approved remote control units are equipped with start-in-gear protection device(s). This feature permits the engine to be started only when it is in neutral. Always select neutral before starting the engine.

EMU41093

Engine oil requirements

Select the engine oil to use from the following recommended engine oils.

Specifications and requirements

Recommended engine oil:
YAMALUBE 4-M FC-W or 4-stroke
outboard motor oil

Recommended engine oil group:
SAE 5W-30/10W-30
API SE/SF/SG/SH/SJ/SL

Total engine oil quantity (oil pan capacity):
7.1 L (7.50 US qt, 6.25 Imp.qt)

Replacement engine oil quantity (at periodic maintenance):
Without oil filter replacement:
6.4 L (6.76 US qt, 5.63 Imp.qt)
With oil filter replacement:
6.7 L (7.08 US qt, 5.90 Imp.qt)

EMU36360

Fuel requirements

EMU41330

Gasoline

Use a good quality gasoline that meets the minimum octane requirement. If knocking or pinging occurs, use a different brand of gasoline or premium unleaded fuel. Yamaha recommends that you use alcohol-free gasoline (see Gasoline with Ethanol) whenever possible.

The use of a poor quality gasoline may result in starting and running problems. If you encounter drivability problems, which you suspect could be related to the fuel you are using, we recommend that you switch to a recognized high quality brand of gasoline, such as a gasoline that is advertised as Top Tier Detergent Gasoline. Failure to comply with these recommendations may also result in unscheduled maintenance, fuel system damage, and internal engine damage.

Recommended fuel:
VF200A Regular unleaded gasoline
VF225A Premium unleaded gasoline
VF250A Premium unleaded gasoline

Min. pump octane:
VF200A 87
VF225A 89
VF250A 89

ECM01981

NOTICE

- **Do not use leaded gasoline. Leaded gasoline can seriously damage the engine.**
- **Avoid getting water and contaminants in the fuel tank. Contaminated fuel can cause poor performance or engine damage. Use only fresh gasoline that has been stored in clean containers.**

Gasoline with Ethanol

Two types of gasoline are commonly available in the U.S.A. for use in automobiles and boats: conventional gasoline without Ethanol and gasoline with Ethanol, which is typically referred to as E10 gasoline. According to federal regulations, E10 gasoline may contain up to 10% Ethanol.

A high quality gasoline without Ethanol is the preferred fuel for your Yamaha outboard motor. However, if gasoline with Ethanol is the only fuel available in your area, your Yamaha outboard motor is calibrated to run properly on fresh E10 gasoline that meets the minimum octane requirement specified for this model.

ECM02400

NOTICE

Never use a gasoline for your outboard motor that contains more than 10% Ethanol, such as E85 which contains 85% Ethanol, or gasoline containing any amount of Methanol. These fuels can cause start-

Specifications and requirements

ing and running problems, as well as serious fuel system and internal engine damage.

Gasoline containing ethanol has several properties that may cause boat fuel system problems.

- Ethanol is a strong solvent (cleaning agent) that can clean gum and varnish deposits from a boat's fuel system, particularly in older boats, as well as tanks and pipes used in gasoline distribution. These released deposits contaminate the fuel and can cause problems, such as clogged fuel filters, carburetors, or fuel injectors, which could result in engine damage.
- Ethanol may dissolve resins used in the construction of fiberglass fuel tanks. The dissolved resins contaminate the fuel and can cause problems, such as clogged fuel filters, carburetors, or fuel injectors, which could result in engine damage.
- Ethanol is hygroscopic (has a strong attraction to water). Therefore, any water that inadvertently enters the fuel system, including moisture that is absorbed from the air, will mix with the ethanol in the gasoline. If the amount of water is excessive, the ethanol and water mixture will separate from the gasoline in a layer at the bottom of the fuel tank. This ethanol and water mixture is very corrosive to aluminum fuel tanks and fuel system components.
- The usable life span of E10 gasoline may be shorter than the normal length of off-season boat storage, causing starting and running problems related to stale fuel.

For more information on using fuel containing ethanol, visit: <http://www.yamaha-motor.com>

Gasoline Filtration

Yamaha outboard motors are equipped with internal fuel filters. However, excessive water or debris entering your engine's fuel system could prematurely clog the internal filters, causing starting and running problems, fuel system damage, and internal engine damage. Therefore, it is recommended that an external 10-micron water-separating fuel filter be installed on your boat and serviced frequently. Consult your authorized Yamaha dealer for a 10-micron filter that meets your engine's requirements.

EMU41340

Gasoline Additives

Gasoline blends change to meet automobile emission regulations and economic conditions. Additives, added by gasoline distributors, necessary for proper automobile engine operation and durability, may not be sufficient for typical boat applications. Intake valve and combustion chamber deposits may accumulate in boat engines more rapidly than encountered in automotive use. In addition, gasoline used for boating will typically age longer between refills than gasoline used in automobiles, resulting in stale and unusable gasoline that may cause starting and running problems, fuel system damage, and internal engine damage.

Yamaha recommends the use of two Yamalube gasoline additives to reduce internal deposits and extend the storage life of gasoline. Continuous use of Yamalube Ring Free Fuel Additive Plus reduces harmful internal deposits. Yamalube Fuel Stabilizer & Conditioner Plus added to fresh gasoline will help protect the fuel system from varnishing while helping to keep the gasoline's octane level from decreasing excessively during storage. Other additives may also be available on the market that may have varying degrees of ef-

Specifications and requirements

fectiveness. Consult your Yamaha dealer concerning what may work best for the locally available gasoline and environmental conditions.

EMU41350

Anti-fouling paint

A clean hull is required to maintain your boat's performance. Boats moored in the water should be protected from marine growth (barnacles, mussels, and marine plants). If approved by regulations for your area, the bottom of the hull can be coated with an anti-fouling paint to inhibit marine growth.

Anti-fouling paints specifically formulated for use on aluminum may be applied to the outboard motor. The original Yamaha paint surface may be scuffed lightly before applying anti-fouling paint, but do not remove the original paint. Removal of the original paint will increase the rate of corrosion.

ECM02410

NOTICE

Anti-fouling paint for fiberglass and wood may contain materials, such as copper, graphite, and tin, that can cause corrosion if applied to aluminum boats and outboard motor components. Never apply these types of paint to your outboard motor because rapid corrosion damage could occur.

Sacrificial anodes are attached to the outboard motor to provide corrosion protection and must never be painted.

ECM02420

NOTICE

Painted sacrificial anodes will not provide corrosion protection.

EMU40301

Outboard motor disposal requirements

Never illegally discard (dump) the outboard motor. Yamaha recommends consulting the dealer about discarding the outboard motor.

EMU36352

Emergency equipment

Keep the following items onboard in case there is trouble with the outboard motor.

- A tool kit with assorted screwdrivers, pliers, wrenches (including metric sizes), and electrical tape.
- Waterproof flashlight with extra batteries.
- An extra engine shut-off cord (lanyard) with clip.
- Spare parts, such as an extra set of spark plugs.

Consult your Yamaha dealer for details.

EMU25221

Emission control information

EMU25230

North American models

This engine conforms to U.S. Environmental Protection Agency (EPA) regulations for marine SI engines. See the label affixed to your engine for details.

EMU31560

Approval label of emission control certificate

This label is attached to the bottom cowling. New Technology; (4-stroke) MFI

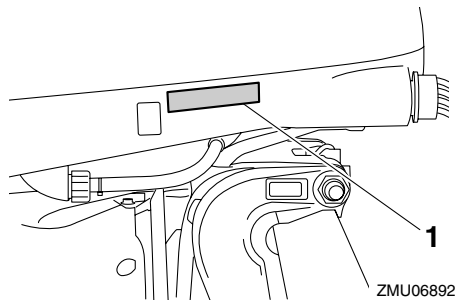

1. Approval label location

ZMU06892

Specifications and requirements

EMISSION CONTROL INFORMATION		MFI
THIS ENGINE CONFORMS TO: _____ CALIFORNIA AND U.S. EPA EXHAUST REGULATIONS FOR SI MARINE ENGINES. REFER TO THE OWNER'S MANUAL FOR MAINTENANCE SPECIFICATIONS AND ADJUSTMENTS. MEETS U.S. EPA EVAP STANDARDS USING CERTIFIED COMPONENTS.		
FAMILY: _____	FELs(HC+NOx/CO): _____	g/kW-hr MAX POWER: _____ kW
DISPLACEMENT: _____ liters	IDLE SPEED: _____ rpm IN NETRAL	
SPARK PLUG: _____	SPARK PLUG GAP (mm): _____	
FUEL: GASOLINE	VALVE LASH (mm) IN: _____ EX: _____	
YAMAHA MOTOR CO.,LTD.		

ZMU06894

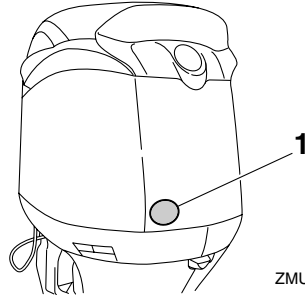

ZMU06897

1. Star labels location

EMU39200

Manufactured date label

This label is attached to the clamp bracket.

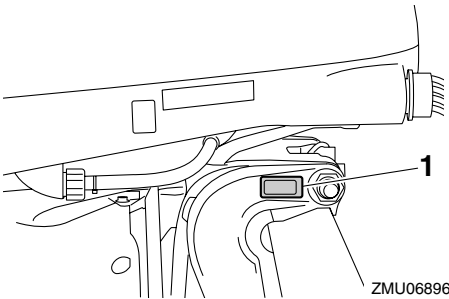

ZMU06896

1. Manufactured date label location

EMU40330

One Star—Low Emission

The one-star label identifies engines that meet the Air Resources Board's Personal Watercraft and Outboard marine engine 2001 exhaust emission standards. Engines meeting these standards have 75% lower emissions than conventional carbureted two-stroke engines. These engines are equivalent to the U.S. EPA's 2006 standards for marine engines.



ZMU01702

EMU40340

Two Stars—Very Low Emission

The two-star label identifies engines that meet the Air Resources Board's Personal Watercraft and Outboard marine engine 2004 exhaust emission standards. Engines meeting these standards have 20% lower emissions than One Star-Low-Emission engines.

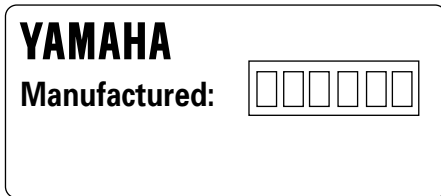

ZMU04346

EMU25273

Star labels

Your outboard motor is labeled with a California Air Resources Board (CARB) star label. See below for a description of your particular label.

Specifications and requirements



ZMU01703

EMU40350

Three Stars—Ultra Low Emission

The three-star label identifies engines that meet the Air Resources Board's Personal Watercraft and Outboard marine engine 2008 exhaust emission standards or the Sterndrive and Inboard marine engine 2003-2008 exhaust emission standards. Engines meeting these standards have 65% lower emissions than One Star-Low-Emission engines.



ZMU05663



ZMU01704

EMU33861

Four Stars—Super Ultra Low Emission

The four-star label identifies engines that meet the Air Resources Board's Sterndrive and Inboard marine engine 2009 exhaust emission standards. Personal Watercraft and Outboard marine engines may also comply with these standards. Engines meeting these standards have 90% lower emissions than One Star-Low-Emission engines.

EMU2579T

Components diagram

TIP:

* May not be exactly as shown; also may not be included as standard equipment on all models (order from dealer).

VF250A, VF225A, VF200A

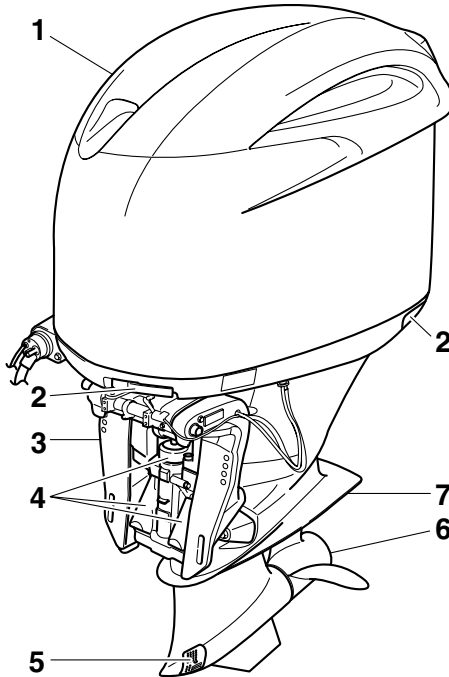

ZMU06898

1. Top cowling
2. Cowling lock lever
3. Clamp bracket
4. Power trim and tilt unit
5. Cooling water inlet
6. Propeller*
7. Anti-cavitation plate

Components

VF250A, VF225A, VF200A

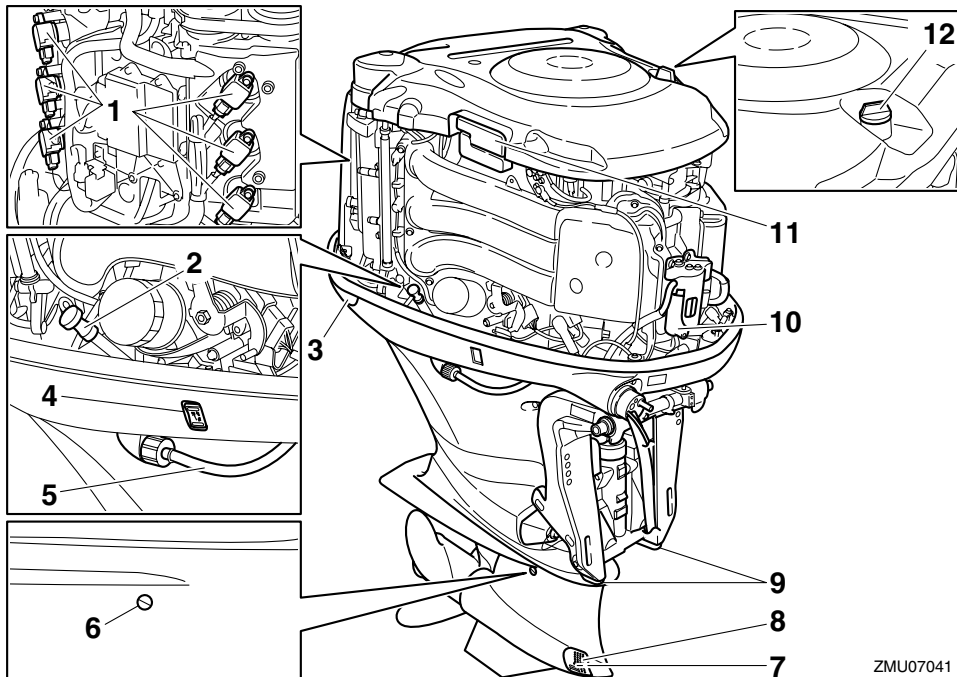

ZMU07041

1. Ignition coil
2. Oil dipstick
3. Cowling lock lever
4. Power trim and tilt switch
5. Flushing device
6. Oil level plug
7. Gear oil drain screw
8. Cooling water inlet
9. Anode
10. Fuel filter
11. Fuse box
12. Oil filler cap

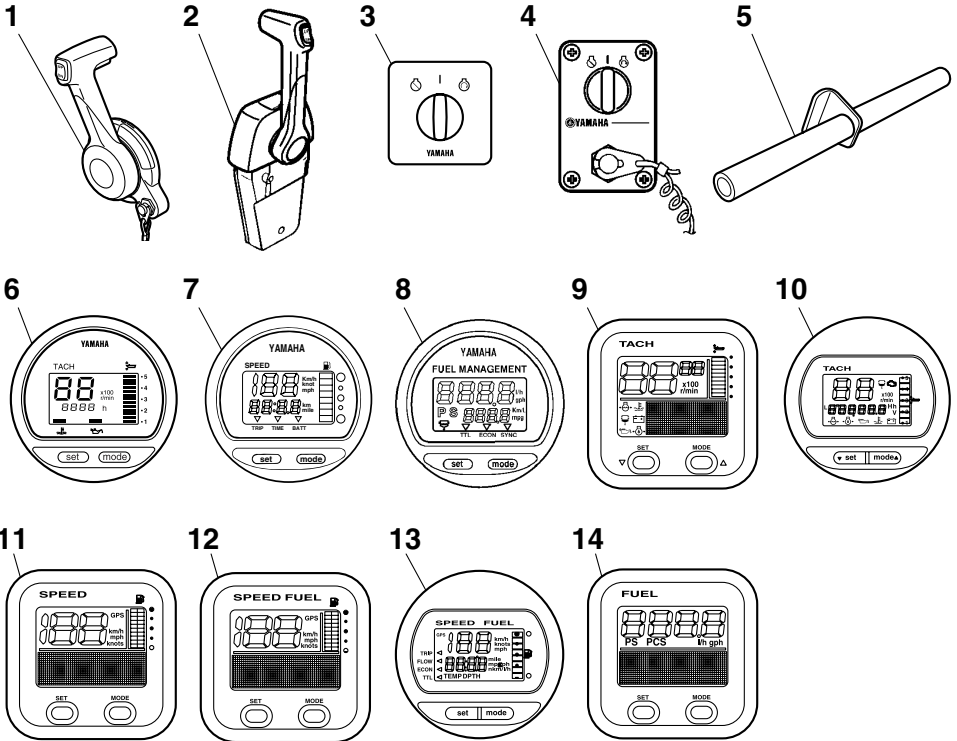

ZMU06899

1. Remote control box (side mount type)*
2. Remote control box (binnacle mount type)*
3. Switch panel (for use with side-mount type)*
4. Switch panel (for use with binnacle type)*
5. Tilt support shaft*
6. Digital tachometer*
7. Digital speedometer*
8. Fuel management meter*
9. Tachometer unit (Square type)*
10. Tachometer unit (Round type)*
11. Speedometer unit (Square type)*
12. Speed & fuel meter unit (Square type)*
13. Speed & fuel meter unit (Round type)*
14. Fuel management meter (Square type)*

Components

EMU40610

Remote control box

The remote control box is equipped with the remote control lever and electrical switches.

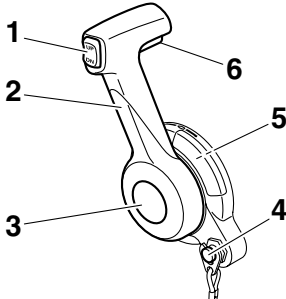

ZMU07022

1. Power trim and tilt switch
2. Remote control lever
3. Free accelerator button
4. Engine shut-off switch
5. Throttle friction adjuster
6. Neutral interlock trigger

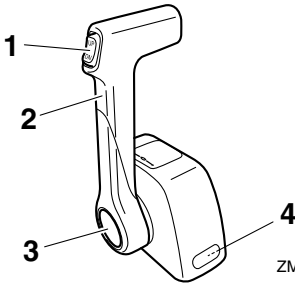

ZMU04572

1. Power trim and tilt switch
2. Remote control lever
3. Free accelerator button
4. Throttle friction adjuster

EMU26190

Remote control lever

Moving the lever forward from the neutral position engages forward gear. Pulling the lever back from neutral engages reverse. The engine will continue to run at idle until the lever is moved about 35° (a detent can be felt). Moving the lever farther opens the throttle, and the engine will begin to accelerate.

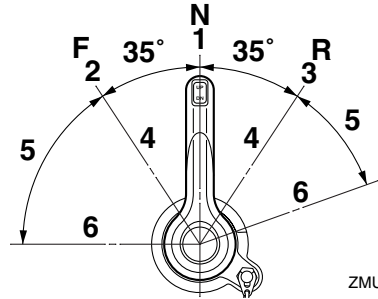

ZMU07024

1. Neutral "N"
2. Forward "F"
3. Reverse "R"
4. Fully closed
5. Throttle
6. Fully open

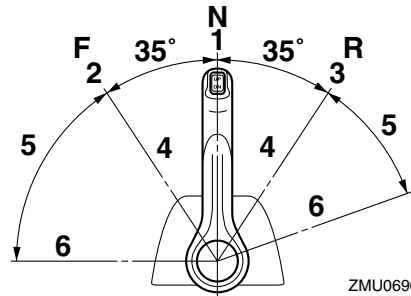

ZMU06901

1. Neutral "N"
2. Forward "F"
3. Reverse "R"
4. Fully closed
5. Throttle
6. Fully open

EMU40630

Neutral interlock trigger

The neutral interlock prevents the remote control lever from accidentally being moved forward or rearward from the neutral position. To move the remote control lever forward or rearward from the neutral position, pull the neutral interlock trigger up, and then move the remote control lever.

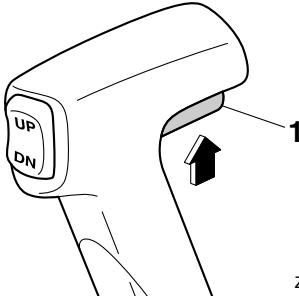

ZMU07042

1. Neutral interlock trigger

EMU26233

Free accelerator

To open the throttle without shifting into either forward or reverse, push the free accelerator button and move the remote control lever.

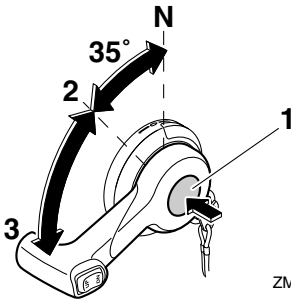

ZMU07028

1. Free accelerator button
2. Fully closed
3. Fully open

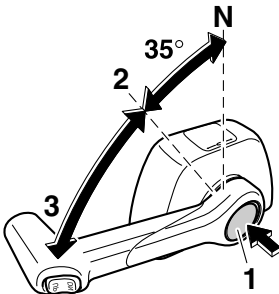

ZMU06903

1. Free accelerator button
2. Fully closed
3. Fully open

TIP:

- The free accelerator button can only be pushed when the remote control lever is in the neutral position.
- After the button is pushed, the throttle begins to open after the remote control lever is moved at least 35°.
- After using the free accelerator, return the remote control lever to the neutral position. The free accelerator button will return automatically to its set position. The remote control will then engage forward and reverse normally.

EMU40604

Throttle friction adjuster

The throttle friction adjuster can be used to adjust the resistance to movement of the remote control lever, and can be set according to operator preference. Adjust the throttle friction according to the following procedure.

1. Remove the cap.

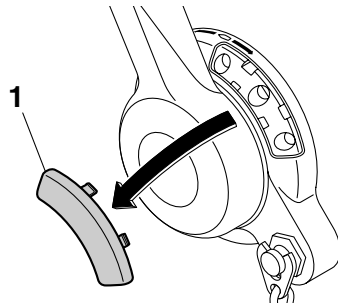

ZMU07025

1. Cap

Components

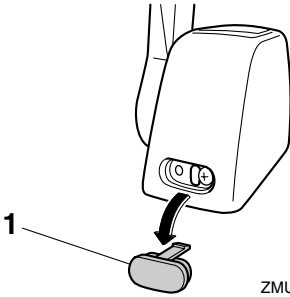

1. Cap

- To increase resistance, turn the adjuster clockwise. To decrease resistance, turn the adjuster counterclockwise. **WARNING! Do not overtighten the friction adjuster. If there is too much resistance, it could be difficult to move the remote control lever, which could result in an accident.** [EWM02580]

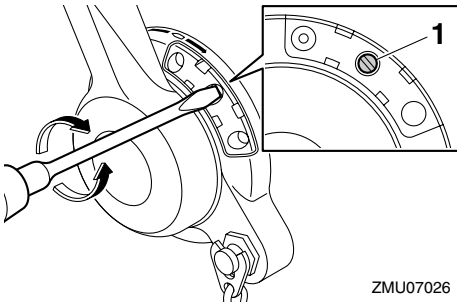

1. Throttle friction adjuster

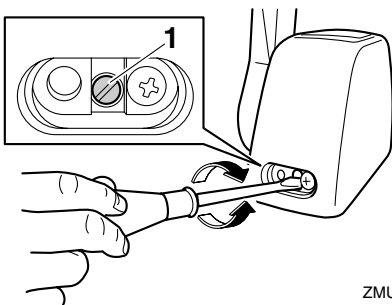

1. Throttle friction adjuster

3. Install the cap.

When constant speed is desired, tighten the adjuster to maintain the desired throttle setting.

EMU25994

Engine shut-off cord (lanyard) and clip

The clip must be attached to the engine shut-off switch for the engine to run. The cord should be attached to a secure place on the operator's clothing, or arm or leg. Should the operator fall overboard or leave the helm, the cord will pull out the clip, stopping ignition to the engine. This will prevent the boat from running away under power. **WARNING! Attach the engine shut-off cord to a secure place on your clothing, or your arm or leg while operating. Do not attach the cord to clothing that could tear loose. Do not route the cord where it could become entangled, preventing it from functioning. Avoid accidentally pulling the cord during normal operation. Loss of engine power means the loss of most steering control. Also, without engine power, the boat could slow rapidly. This could cause people and objects in the boat to be thrown forward.**

[EWM00122]

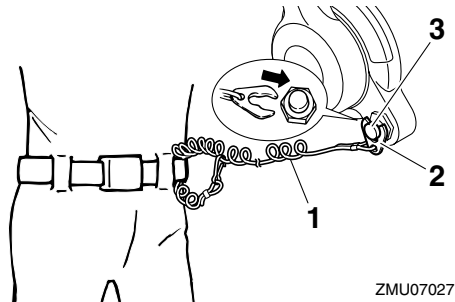

- Engine shut-off cord (lanyard)
- Clip
- Engine shut-off switch

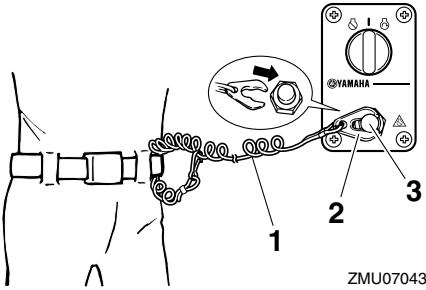

ZMU07043

1. Engine shut-off cord (lanyard)
2. Clip
3. Engine shut-off switch

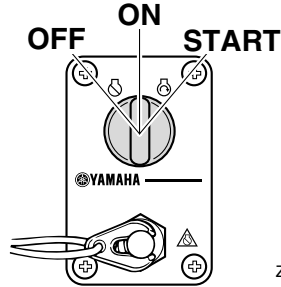

ZMU07019

EMU32053

Power trim and tilt switch on remote control

The power trim and tilt system adjusts the outboard motor angle in relation to the transom. Pushing the switch “UP” (up) trims the outboard motor up, and then tilts it up. Pushing the switch “DN” (down) tilts the outboard motor down and trims it down. When the switch is released, the outboard motor will stop in its current position. For instructions on using the power trim and tilt switch, see pages 59 and 61.

EMU26091

Main switch

The main switch controls the ignition system; its operation is described below.

● “OFF” (off)

With the main switch in the “OFF” (off) position, the electrical circuits are off, and the key can be removed.

● “ON” (on)

With the main switch in the “ON” (on) position, the electrical circuits are on, and the key cannot be removed.

● “START” (start)

With the main switch in the “START” (start) position, the starter motor turns to start the engine. When the key is released, it returns automatically to the “ON” (on) position.

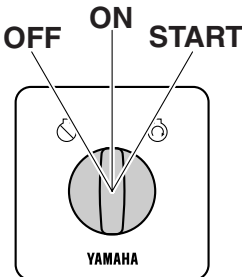

ZMU06245

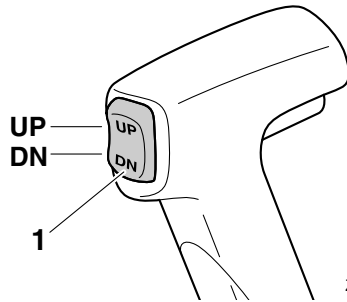

ZMU06981

1. Power trim and tilt switch

EMU26154

Power trim and tilt switch on bottom cowling

The power trim and tilt switch is located on the side of the bottom cowling. Pushing the switch “UP” (up) trims the outboard motor up, and then tilts it up. Pushing the switch “DN” (down)

Components

tilts the outboard motor down and trims it down. When the switch is released, the outboard motor will stop in its current position. For instructions on using the power trim and tilt switch, see page 61.

EWMM01031

WARNING

Use the power trim and tilt switch located on the bottom cowling only when the boat is at a complete stop with the engine off. Attempting to use this switch while the boat is moving could increase the risk of falling overboard and could distract the operator, increasing the risk of collision with another boat or an obstacle.

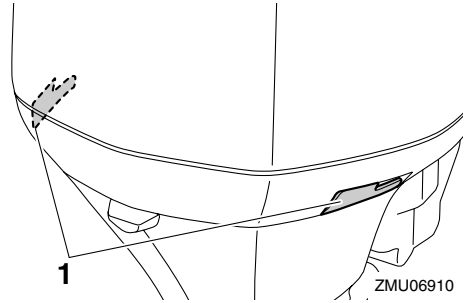

1. Cowling lock lever

EMU40802

Flushing device

The flushing device is used to clean the cooling water passages of the outboard motor using a garden hose and tap water. For instructions on using the flushing device, see page 66.

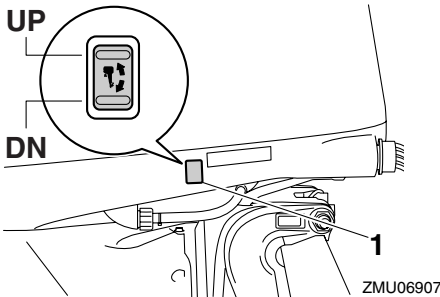

1. Power trim and tilt switch

EMU40760

Cowling lock lever

The cowling lock levers are used to secure the top cowling.

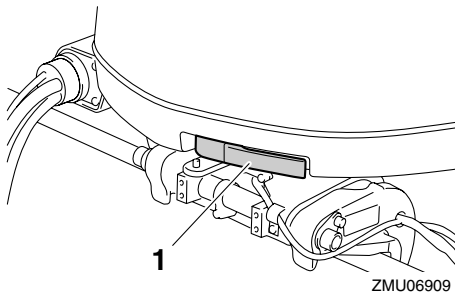

1. Cowling lock lever

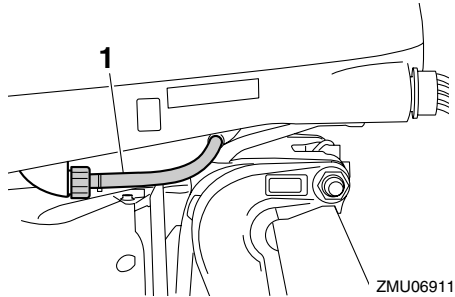

1. Flushing device

EMU40822

Fuel filter

The fuel filter functions to remove foreign material and separate water from the fuel. If water separated from the fuel exceeds a specific volume, the alert system will activate. For further information, see page 44.

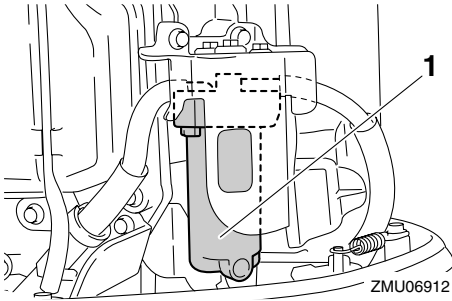

1. Fuel filter

TIP:

Adding an in-line 10-micron fuel filter has been shown to greatly reduce the chance of fuel contamination problems. Consult your dealer for information about Yamaha 10-micron fuel filters if your boat does not have one.

EMU40594

Tilt support shaft (optional)

The tilt support shaft is available as an option for this outboard motor. The tilt support shaft is used to secure the outboard motor in the tilt-up position.

Installing tilt support shaft

1. Fully tilt the outboard motor up.
2. Insert the tilt support shaft between the swivel bracket and the clamp bracket from the starboard side of the outboard motor until the plate on the tilt support shaft contacts the swivel bracket. Insert the tilt support shaft so that the end of the plate is pointing in the direction shown in the illustration and position the tilt support shaft in front of the protrusions on the clamp bracket.

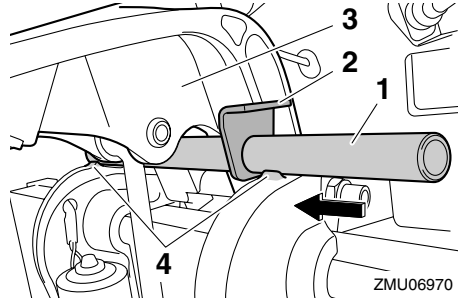

1. Tilt support shaft
2. Plate
3. Swivel bracket
4. Protrusion

3. Turn the tilt support shaft toward the bow so that the plate contacts the clamp bracket.

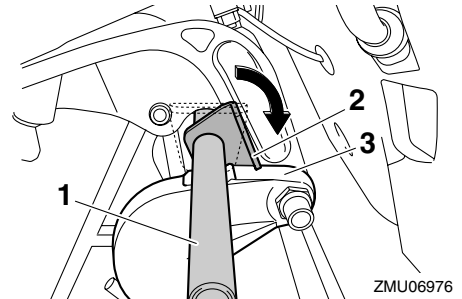

1. Tilt support shaft
2. Plate
3. Clamp bracket

4. Tilt the outboard motor down slowly until the swivel bracket contacts the tilt support shaft, and then check that the tilt support shaft is secured in place.

Removing tilt support shaft

1. Fully tilt the outboard motor up, and then remove the tilt support shaft.

Components

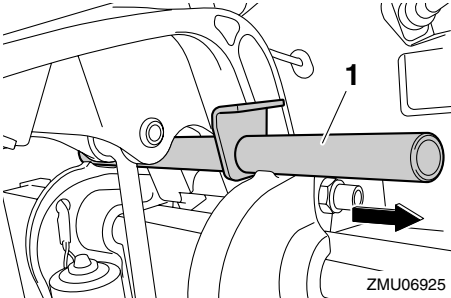

1. Tilt support shaft
2. Tilt the outboard motor down.

Instruments and indicators

EMU41390

Digital tachometer

The tachometer shows the engine speed and has the following functions.

All segments of the display will light momentarily after the main switch is turned on and will return to normal thereafter.

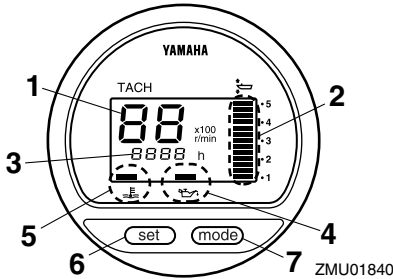

1. Tachometer
2. Trim meter
3. Hour meter
4. Low oil pressure-alert indicator
5. Overheat-alert indicator
6. Set button
7. Mode button

EMU36050

Tachometer

The tachometer displays engine speed in hundreds of revolutions per minute (r/min). For example, if the tachometer display reads "22" then the engine speed is 2200 r/min.

EMU26621

Trim meter

This meter shows the trim angle of your outboard motor.

- Memorize the trim angles that work best for your boat under different conditions. Adjust the trim angle to the desired using the power trim and tilt switch.
- If the trim angle of your motor exceeds the trim operating range, the top segment on the trim meter display will blink.

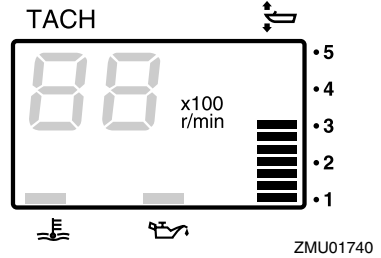

EMU26651

Hour meter

This meter shows the number of hours the engine has been run. It can be set to show the total number of hours or the number of hours for the current trip. The display can also be turned on and off.

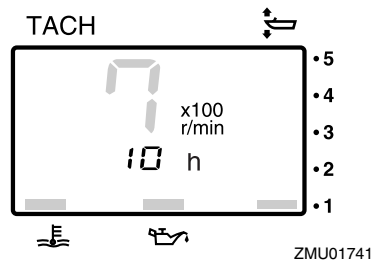

To change the display format, press the "mode" (mode) button. The display can show total hours or trip hours, or turn off.

To reset the trip hours, simultaneously press the "set" (set) and "mode" (mode) buttons for more than 1 second while the trip hours are displayed. This resets the trip counter to 0 (zero).

The total number of hours the engine has been run cannot be reset.

EMU40810

Low oil pressure-alert indicator

If oil pressure drops too low, the alert indicator will start to blink. For further information, see page 43.

Instruments and indicators

ECM02300

NOTICE

- Do not continue to operate the engine if the low oil pressure-alert indicator is on and the engine oil pressure is low. Serious engine damage will occur.
- The low oil pressure-alert indicator does not indicate the engine oil level. Use the oil dipstick to check the remaining oil quantity. For further information, see page 50.

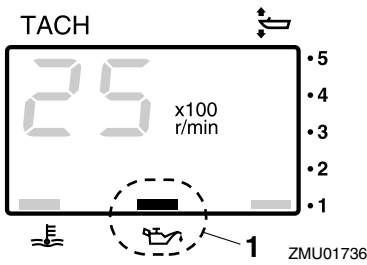

1. Low oil pressure-alert indicator

EMU26583

Overheat-alert indicator

If the engine temperature rises too high, the alert indicator will start to blink. For further information on reading the indicator, see page 43.

ECM00052

NOTICE

Do not continue to run the engine if the overheat-alert indicator is on. Serious engine damage will occur.

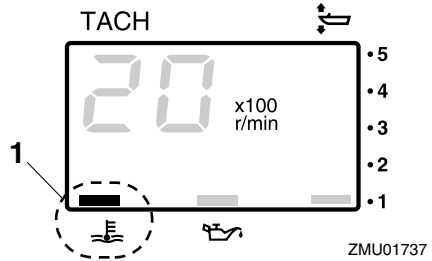

1. Overheat-alert indicator

EMU26602

Digital speedometer

This gauge shows the boat speed and other information.

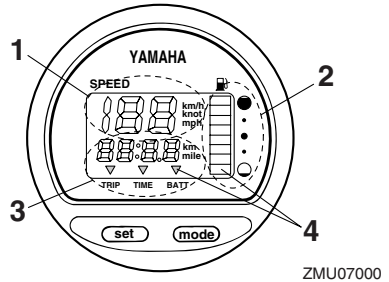

1. Speedometer
2. Fuel gauge
3. Trip meter/clock/voltmeter
4. Alert indicator(s)

All segments of the display will light momentarily after the main switch is turned on and will return to normal thereafter.

EMU36061

Speedometer

The speedometer displays km/h, mph, or knots, according to operator preference. Select the desired units of measurement by setting the selector switch on the back of the gauge. See the illustration for settings.

Instruments and indicators

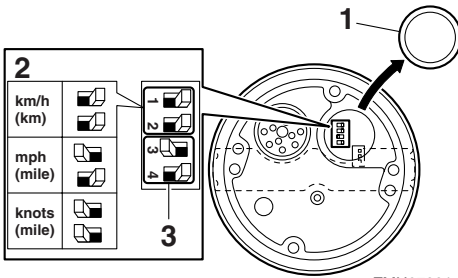

ZMU07001

1. Cap
2. Selector switch (for speed unit)
3. Selector switch (for fuel sensor)

EMU26713

Fuel gauge

Eight segments indicate the fuel level. When all segments are showing, the fuel tank is full.

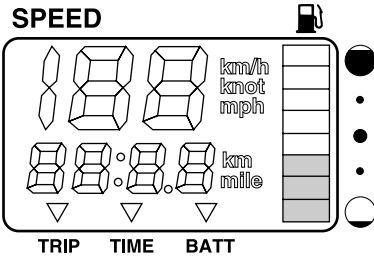

ZMU07002

The fuel level reading can be inaccurate due to the position of the sensor in the fuel tank and the attitude of the boat in the water. Operation with bow-up trim or continuous turning can give false readings.

Do not adjust the selector switch for fuel sensor. Incorrectly setting the selector switch on the gauge will give false readings. Consult your Yamaha dealer on how to correctly set the selector switch. **NOTICE: Running out of fuel can damage the engine.** [ECM01770]

EMU36071

Trip meter / Clock / Voltmeter

The display shows either the trip meter, the clock, or the voltmeter.

To change the display, press the "mode" (mode) button repeatedly until the indicator on the face of the gauge points to "TRIP" (trip meter), "TIME" (clock), or "BATT" (voltmeter).

EMU26691

Trip meter

This gauge displays the distance the boat has traveled since the gauge was last reset.

The trip distance is shown in kilometers or miles depending upon the unit of measurement selected for the speedometer.

To reset the trip meter to zero, press the "set" (set) and "mode" (mode) buttons at the same time.

The trip distance is kept in memory by battery power. The stored data will be lost if the battery is disconnected.

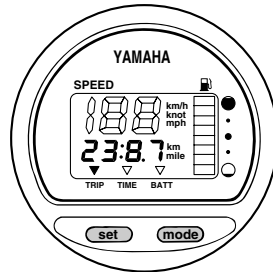

ZMU07003

EMU40841

Clock

To set the clock

1. Push the "mode" (mode) button to change the display to the "TIME" (clock) mode.
2. Push the "set" (set) button. The hour display will begin blinking.
3. Push the "mode" (mode) button until the desired hour value is displayed.
4. Push the "set" (set) button again. The 10-minute display will begin blinking.
5. Push the "mode" (mode) button until the desired 10-minute value is displayed.
6. Push the "set" (set) button again. The 1-minute display will begin blinking.

Instruments and indicators

- Push the “mode” (mode) button until the desired 1-minute value is displayed.
- Push the “set” (set) button again to start the clock.

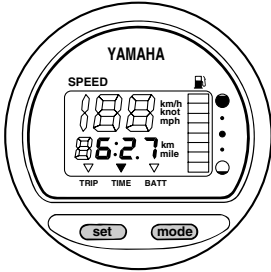

ZMU07004

The clock operates on battery power. Disconnecting the battery will stop the clock. Reset the clock after connecting the battery.

EMU36080

Voltmeter

The voltmeter displays the charge of the battery in volts(V).

EMU26721

Fuel level-alert indicator

If the fuel level decreases to one segment, the fuel level alert segment will blink.

Do not continue to operate the engine with full throttle if an alert device has activated. Get back to the port within trolling engine speed.

NOTICE: Running out of fuel can damage the engine. [ECM01770]

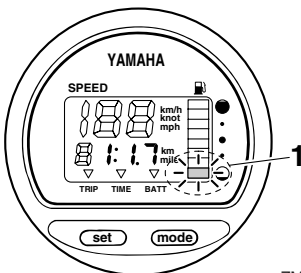

ZMU07005

- Fuel level-alert segment

EMU26732

Low battery voltage-alert indicator

If battery voltage drops, the display will automatically turn on and blink.

Get back to the port soon if an alert device has activated. For charging the battery, consult your Yamaha dealer.

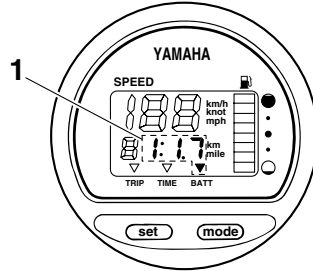

ZMU07006

- Low battery indicator

EMU26741

Fuel management meter

The fuel management meter shows the state of the fuel consumption while the engine is running.

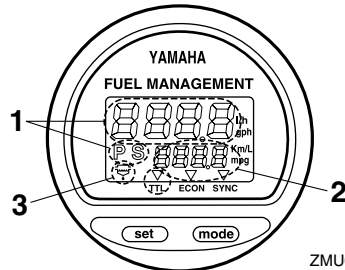

ZMU01748

- Fuel flow meter
- Fuel consumption meter / Fuel economy meter / Twin engine speed synchronizer
- Water separator-alert indicator (operates only if the sensor has been installed)

All segments of the display will light momentarily after the main switch is turned on and will return to normal thereafter.

Instruments and indicators

EMU26752

Fuel flow meter

The fuel flow meter displays the amount of fuel flow over a one-hour period, at the current rate of engine operation.

- The fuel flow meter displays gallons/hour or liters/hour according to operator preference. Select the desired units of measurement by setting the selector switch on the back of the gauge during installation.

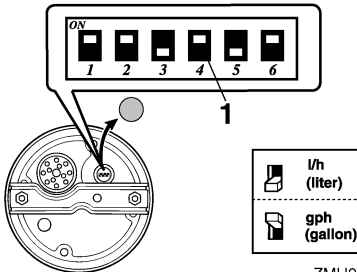

ZMU01750

1. Selector switch

- The fuel consumption meter and fuel economy meter will indicate the same unit of measurement.

Fuel flow readings are not accurate when the engine is operating under about 1300 r/min. As the fuel pump cycles on and off, the display indicates either no fuel flow or higher flow than the actual average use.

Dual engine users: the fuel flow meter can display the fuel flow of either or both engines.

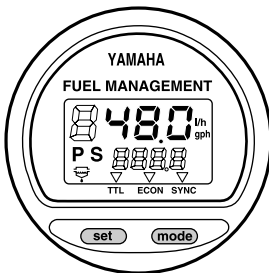

ZMU01749

To change the fuel flow display, press the "set" (set) button repeatedly until the gauge displays "S" (for fuel flow to the starboard engine only), "P" (for fuel flow to the port engine only), or "P S" (for total fuel flow both engines).

EMU36090

Fuel consumption meter / Fuel economy meter / Twin engine speed synchronizer

The display shows either the fuel consumption meter, the fuel economy meter, or the twin engine synchronizer.

To change the display, press the "mode" (mode) button repeatedly until the indicator on the face of the gauge points to "TTL" (fuel consumption meter), "ECON" (fuel economy meter), or "SYNC" (twin engine speed synchronizer).

EMU26761

Fuel consumption meter

This gauge displays the total amount of fuel consumed since the gauge was last reset.

To reset the total fuel consumption meter to zero, press the "set" (set) and "mode" (mode) buttons at the same time.

FUEL MANAGEMENT

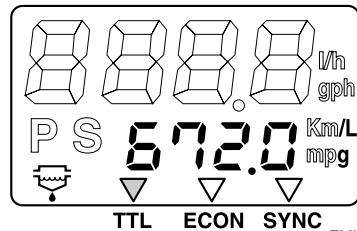

ZMU01751

EMU26771

Fuel economy

This gauge displays the approximate distance per liter or gallon when cruising.

Instruments and indicators

FUEL MANAGEMENT

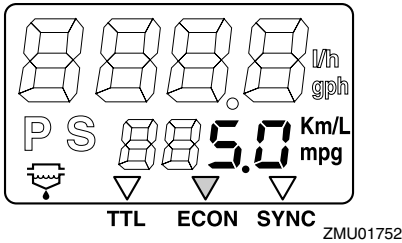

If twin engines are installed on your boat, the gauge will only display the total fuel economy of both engines.

- Fuel consumption varies greatly with boat design, weight, propeller used, engine trim angle, sea conditions (including wind), and throttle position. Fuel consumption also varies slightly with the type of water (salt, fresh, and contaminate levels), air temperature and humidity, cleanliness of the boat bottom, engine mounting height, skill of the operator, and individual gasoline formulation (winter or summer fuel and amount of additives).
- The Yamaha digital speedometer and fuel management meter calculates speed, miles traveled, and fuel economy by water movement at the stern of the boat. This distance can vary greatly from the actual distance traveled because of water currents, sea swells, and the condition of the water speed sensor (if partially plugged or damaged).
- Individual engines may slightly vary in their fuel consumption due to manufacturing variations. These variations can be even greater if the engines are of different year models. In addition, variations in propellers, even of the same basic dimensions of the same design, can also cause a slight variation in fuel consumption.

EMU26782

Twin-engine speed synchronizer

This gauge displays the difference in engine speed (r/min) between the port and starboard engines for reference purposes when synchronizing the two engines' speeds.

FUEL MANAGEMENT

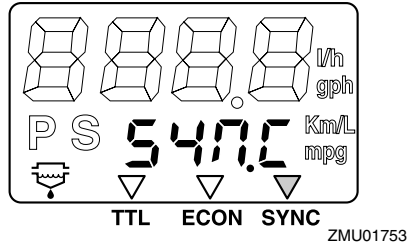

FUEL MANAGEMENT

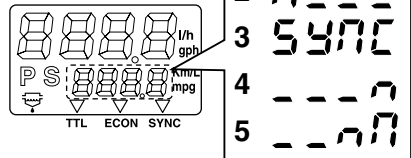

ZMU01754

1. Port engine speed is higher
2. Port engine speed is slightly higher
3. Engine speed is synchronized evenly between port and starboard engines
4. Starboard engine speed is slightly higher
5. Starboard engine speed is higher

If the two engines' speeds are not synchronized while cruising, adjusting trim angle or throttle can synchronize them.

If large differences in trim angle or throttle are needed to synchronize the engines, consult your Yamaha dealer for adjustments to the throttle cables.

Instruments and indicators

EMU26793

Water separator-alert indicator

This indicator will blink when water has accumulated in the water separator. In such an event, stop the engine and drain the water from the separator.

This indicator only operates when a water separator sensor is equipped.

FUEL MANAGEMENT

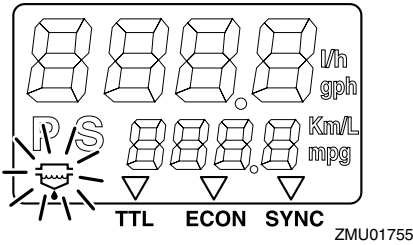

EMU40791

Command Link meter

There are 6 types of Command Link meters: tachometer unit (square and round types), speedometer unit (square type), speed & fuel meter unit (square and round types), and fuel management meter (square type). The indicator system is slightly different between the round and square types. Check the model and type of your unit carefully. This manual describes mainly the alert indicators. For more details on setting meters or changing indicator systems, see the operation manual for the meters.

EMU41162

Command Link tachometer

The tachometer shows the engine speed and has functions of trim meter, adjusting trolling speed, cooling water/engine temperature display, battery voltage display, total hour/trip hour display, oil pressure display, water detection alert, engine trouble alert, and periodic maintenance notification. If the cooling water pressure sensor is installed, the unit can also

show the cooling water pressure display. However, even if the cooling water pressure sensor is not installed, the cooling water pressure display can be shown by connecting an optional sensor to the unit. For the optional sensor, consult your Yamaha dealer. The tachometer unit is available in round and square types. Check your tachometer unit type.

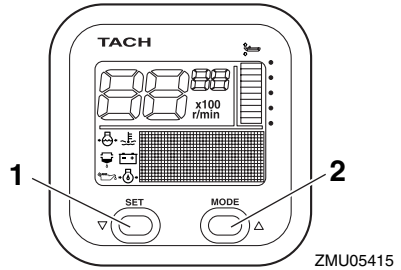

1. Set button
2. Mode button

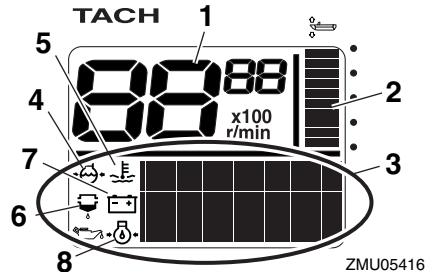

1. Tachometer
2. Trim meter
3. Multifunction display
4. Cooling water pressure
5. Cooling water/engine temperature
6. Water detection-alert indicator
7. Battery voltage
8. Oil pressure (4-stroke models)

Instruments and indicators

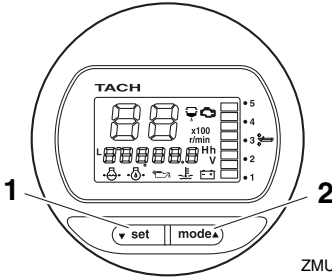

ZMU05417

1. Set button
2. Mode button

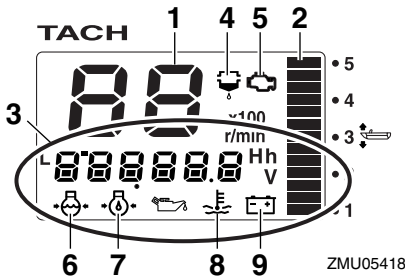

ZMU05418

1. Tachometer
2. Trim meter
3. Multifunction display
4. Water detection-alert indicator
5. Engine trouble alert/maintenance indicator
6. Cooling water pressure
7. Oil pressure (4-stroke models)
8. Cooling water/engine temperature
9. Battery voltage

EMU36110

Start-up checks

Place the remote control lever in neutral and turn the main switch to "ON" (on). After all the displays come on and the total hour display comes on, the gauge will change to normal operation. If the buzzer sounds and the water separator-alert indicator blinks, consult your Yamaha dealer immediately.

TIP:

To stop the buzzer, press the "set" (set) or "mode" (mode) button.

EMU36130

Low oil pressure-alert

If the engine oil pressure drops too low, the low oil pressure-alert indicator will start to blink, and the engine speed will automatically decrease to about 2000 r/min.

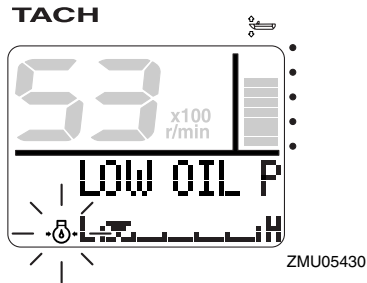

ZMU05430

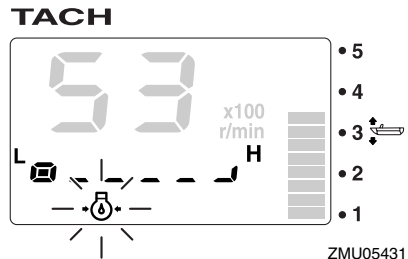

ZMU05431

Stop the engine immediately if the buzzer sounds and the low oil pressure-alert indicator blinks. Check the engine oil quantity and replenish oil if necessary. If the alert device has activated while the appropriate engine oil quantity is maintained, consult your Yamaha dealer.

ECM01601

NOTICE

Do not continue to run the engine if the low oil pressure alert device has activated. Serious engine damage will occur.

Instruments and indicators

EMU36221

Overheat alert

If the engine temperature rises too high while cruising, the overheat-alert indicator will start to blink. The engine speed will automatically decrease to about 2000 r/min.

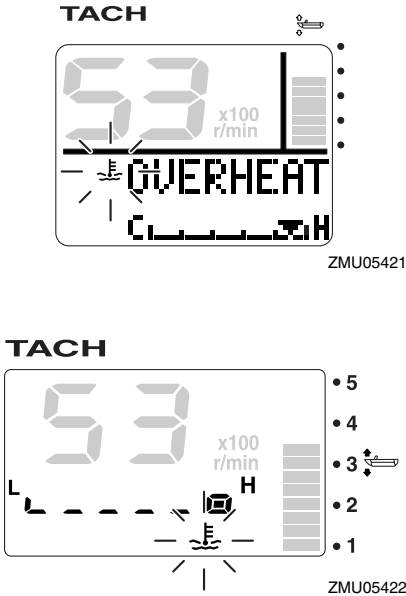

Stop the engine immediately if the buzzer sounds and the overheat alert device has activated. Check the cooling water inlet for clogging.

ECM01592

NOTICE

- Do not continue to run the engine if the overheat-alert indicator blinks. Serious engine damage will occur.
- Do not continue to operate the engine if a alert device has activated. Consult your Yamaha dealer if the problem cannot be located and corrected.

EMU36150

Water separator alert

This indicator will blink if water has accumulated in the water separator (fuel filter) while cruising. In such an event, stop the engine immediately and see page 85 of this manual to drain the water from the fuel filter. Get back to the port soon and consult a Yamaha dealer immediately.

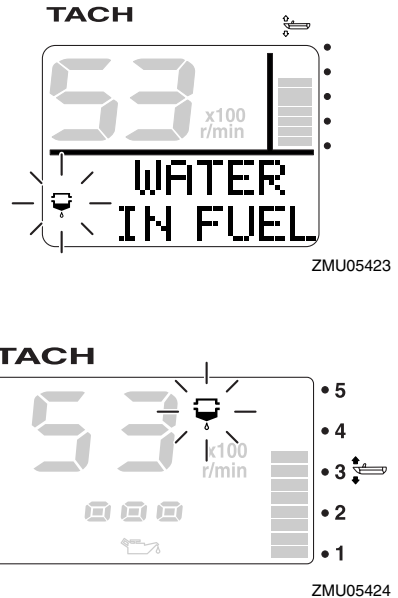

ECM00910

NOTICE

Gasoline mixed with water could cause damage to the engine.

EMU36160

Engine trouble alert

This indicator will blink if the engine malfunctions while cruising. Get back to the port soon and consult a Yamaha dealer immediately.

Instruments and indicators

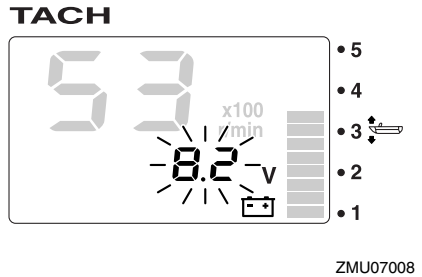
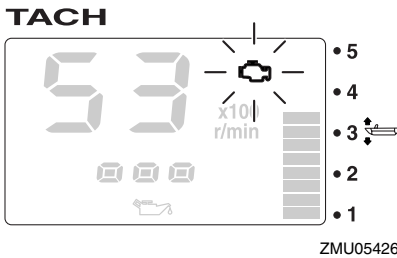
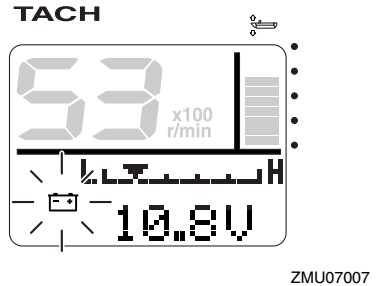
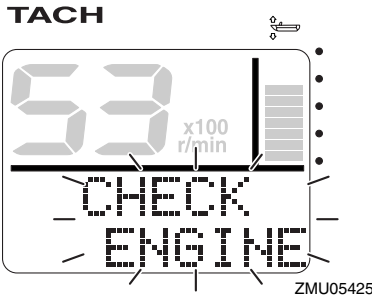

ECM00920

NOTICE

In such an event, the engine will not operate properly. Consult a Yamaha dealer immediately.

EMU36170

Low battery voltage-alert

If the battery voltage drops, the low battery voltage-alert indicator and the battery voltage value will start to blink. Get back to the port soon if the low battery voltage-alert device has activated. For charging the battery, consult your Yamaha dealer.

EMU41032

Command Link speed & fuel meter

The speed & fuel meter unit shows the boat speed and has the functions of fuel meter, total fuel consumption display, fuel economy display, fuel flow display, and system voltage display. The chosen display is selected using the “set” (set) and “mode” (mode) buttons as described in this section. If the speed sensor is installed, the unit can also show the trip display. However, even if the speed sensor is not installed, the trip display can be shown by connecting an optional sensor to the unit. In addition, if optional sensors are connected to the unit, water surface temperature display, depth display, and clock will also be available. For the optional sensors, consult your Yamaha dealer.

Instruments and indicators

The speed & fuel meter unit is available in round and square types. Check your speed & fuel meter unit type.

After the main switch is first turned to the “ON” (on) position, all of the displays come on as a test. After a few seconds, the unit will change to normal operation.

For more information, see the operation manual for the meters.

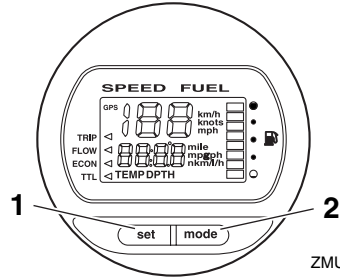

ZMU05434

1. Set button
2. Mode button

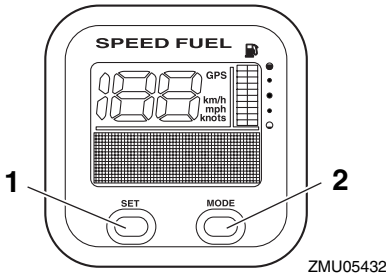

ZMU05432

1. Set button
2. Mode button

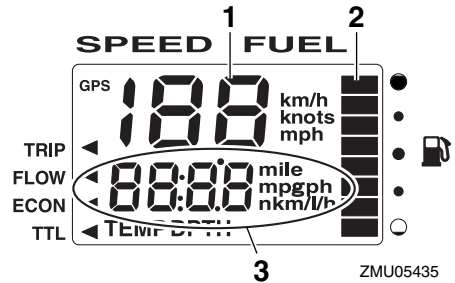

ZMU05435

1. Speedometer
2. Fuel meter
3. Multifunction display

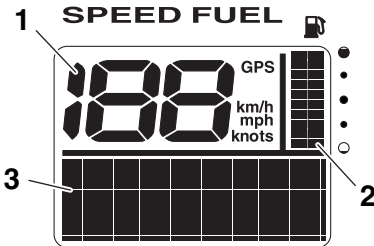

ZMU05433

1. Speedometer
2. Fuel meter
3. Multifunction display

EMU41041

Command Link speedometer

The speedometer unit shows the boat speed and has functions of fuel meter and system voltage display. The chosen display is selected using the “set” (set) and “mode” (mode) buttons as described in this section. In addition, the speedometer can show the desired unit of measurement such as km/h, mph, or knots. If the speed sensor is installed, the unit can also show the trip display. However, even if the speed sensor is not installed, the trip display can be shown by connecting an optional sensor to the unit. In addition, if optional sensors are connected to the unit, water surface

Instruments and indicators

temperature display, depth display, and clock will also be available. For the optional sensors, consult your Yamaha dealer.

After the main switch is first turned to the “ON” (on) position, all of the displays come on as a test. After a few seconds, the unit will change to normal operation.

For more information, see the operation manual for the meters.

fuel display. The chosen display is selected using the “set” (set) and “mode” (mode) buttons as described in this section.

After the main switch is first turned to the “ON” (on) position, all of the displays come on as a test. After a few seconds, the unit will change to normal operation.

For more information, see the operation manual for the meters.

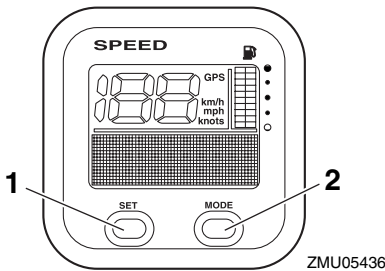

1. Set button
2. Mode button

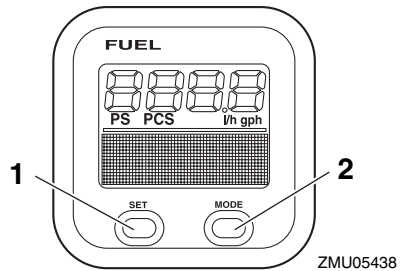

1. Set button
2. Mode button

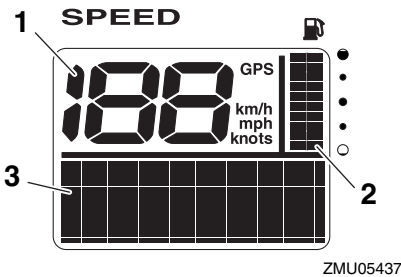

1. Speedometer
2. Fuel meter
3. Multifunction display

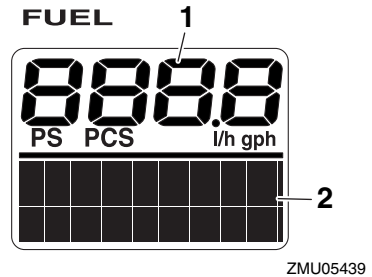

1. Fuel flow meter
2. Multifunction display

EMU41021

Command Link fuel management meter

The fuel management meter has the functions of fuel flow meter, total consumption display, fuel economy display, and remaining

EMU26803

Alert system

ECM0091

NOTICE

Do not continue to operate the engine if a alert device has activated. Consult your Yamaha dealer if the problem cannot be located and corrected.

EMU41170

Overheat alert

The outboard motor is equipped with an overheat alert system. If the engine temperature rises too high, the alert system will activate.

- The engine speed will automatically decrease to about 2000 r/min.
- The overheat-alert indicator will come on or blink.

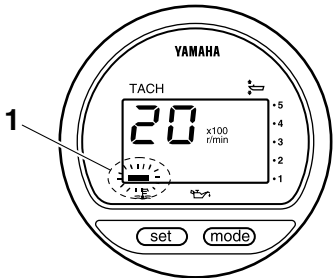

ZMU07010

1. Overheat-alert indicator

- The buzzer will sound.

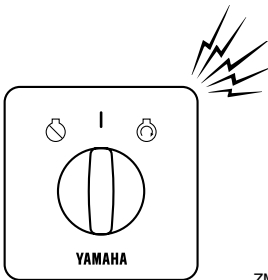

ZMU06297

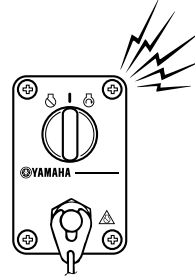

ZMU07012

If the alert system has activated, stop the engine and check the cooling water inlet.

- Check the trim angle to check that the cooling water inlet is submerged.
- Check the cooling water inlet for clogging.

EMU41180

Low oil pressure alert

The outboard motor is equipped with a low oil pressure alert system. If the engine oil pressure is low, the alert system will activate.

- The engine speed will automatically decrease to about 2000 r/min.
- The low oil pressure-alert indicator will come on or blink.

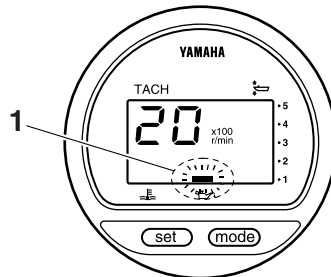

ZMU07013

1. Low oil pressure-alert indicator

- The buzzer will sound.

Engine control system

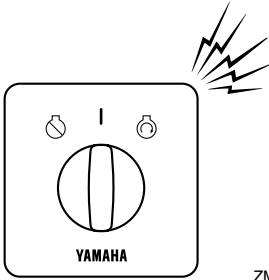

ZMU06297

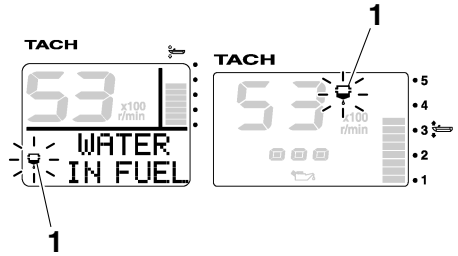

ZMU06963

1. Water separator-alert indicator

- The buzzer will sound intermittently when the remote control lever is in the neutral position.

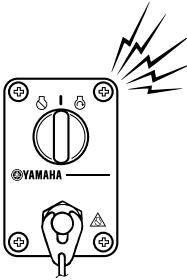

ZMU07012

If the alert system has activated, stop the engine as soon as it is safe to do so. Check the oil level and add engine oil as needed. If the oil level is correct and the alert system does not switch off, consult your Yamaha dealer.

EMU40852

Water separator alert

The outboard motor is equipped with a water separator alert system. If water separated from the fuel exceeds a specific volume, the alert system will activate.

- The water separator-alert indicator of the Command Link tachometer will come on or blink.

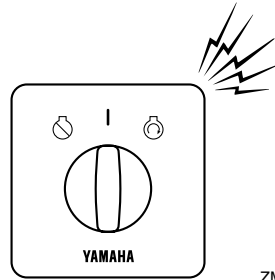

ZMU06297

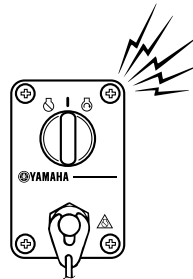

ZMU07012

If the alert system has activated, stop the engine and check the fuel filter. If any water is found in the fuel, consult a Yamaha dealer.

ECM02340

NOTICE

Although the buzzer will stop when the engine is started and the remote control lever is moved to the forward or reverse position, do not use the outboard motor. Otherwise, serious engine damage could occur.

Installation

EMU41212

Installation

The information presented in this section is intended as reference only. It is not possible to provide complete instructions for every possible boat and outboard motor combination. Proper mounting depends in part on experience and the specific boat and outboard motor combination.

EWM02572

WARNING

- **Overpowering a boat could cause severe instability. Do not mount an outboard motor with more horsepower than the maximum rating on the capacity plate of the boat. If the boat does not have a capacity plate, consult the boat manufacturer.**
- **Improper mounting of the outboard motor could result in hazardous conditions, such as poor handling, loss of control, or fire hazards. Have your Yamaha dealer mount the outboard motor properly.**

EMU41270

Mounting the outboard motor

The outboard motor should be mounted so that the boat is well balanced. Otherwise, the boat could be hard to steer. Mount the outboard motor on the centerline (keel line) of the boat.

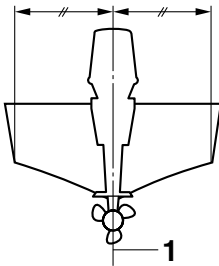

ZMU01760

1. Center line (keel line)

EMU41063

Mounting height

The mounting height of your outboard motor affects its efficiency and reliability. If it is mounted too high, propeller ventilation may occur, which will reduce propulsion due to excessive propeller slip, and the cooling water inlet for the cooling system may not get adequate water supply, which can cause engine overheating. If the engine is mounted too low, water resistance (drag) will increase, thereby reducing engine efficiency and performance. The optimum mounting height depends on the combination of the boat and outboard motor. Consult your Yamaha dealer or boat manufacturer for further information on determining the proper mounting height.

ECM01634

NOTICE

- **Make sure that the idle hole is high enough to prevent water from entering the engine even if the boat is stationary with the maximum load.**
- **Incorrect engine height or obstructions to the smooth flow of water (such as the design or condition of the boat, or accessories, such as transom ladders or depth finder transducers) can create airborne water spray while the boat is cruising. If the outboard motor is operated continuously in the presence of airborne water spray, enough water could enter the engine through the air intake opening in the top cowling to cause severe engine damage. Remove the cause of the airborne water spray.**

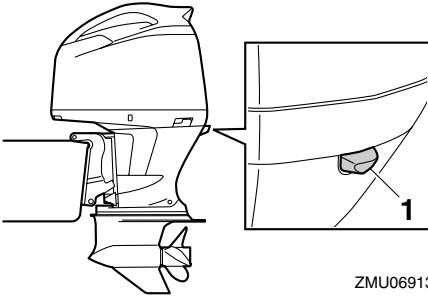

ZMU06913

1. Idle hole

Operation

EMU36381

First-time operation

EMU40510

Filling engine oil

The outboard motor is shipped from the factory without engine oil. If your Yamaha dealer did not fill the engine with engine oil, you must fill the engine before starting it. **NOTICE: Make sure that the engine is filled with engine oil before operating the outboard motor for the first time. Otherwise, the engine could be damaged severely.** [ECM02240]

The following sticker, which is affixed to the outboard motor when it is shipped from the factory, should be removed after the engine is filled with engine oil for the first time. For more information on checking the engine oil level, see page 50.



ZMU01710

EMU30174

Breaking in engine

Your new engine requires a period of break-in to allow mating surfaces of moving parts to wear in evenly. Correct break-in will help ensure proper performance and longer engine life. **NOTICE: Failure to follow the break-in procedure could result in reduced engine life or even severe engine damage.** [ECM00801]

EMU41222

Procedure for breaking in engine

Your new engine requires a period of 10 hours break-in so that mating surfaces of moving parts wear in evenly.

Operate the engine in the water under load (in gear with a propeller installed) for 10 hours as follows. When breaking in the engine, avoid extended idling, rough water, and crowded areas.

1. For the 1st hour of operation:
Operate the engine at varying speeds up to 2000 r/min or approximately 1/2 throttle.
2. For the 2nd hour of operation:
Increase the engine speed until the boat is on plane (but avoid full-throttle operation), and then back off on the throttle while keeping the boat at a planing speed.
3. For the remaining 8 hours of operation:
Operate the engine at any speed. However, avoid operating at full throttle for more than 5 minutes at a time.
4. After the 1st 10 hours of operation:
Operate the engine normally.

EMU36400

Getting to know your boat

Different boats handle differently. Operate cautiously while you learn how your boat handles under different conditions and with different trim angles (see page 59).

EMU36413

Checks before starting engine

EW01921

WARNING

If any item in “Checks before starting engine” is not working properly, have it inspected and repaired before operating the outboard motor. Otherwise, an accident could occur.

ECM00120

NOTICE

Do not start the engine out of water. Overheating and serious engine damage can occur.

EMU40520

Fuel level

Check that you have plenty of fuel for your trip. A good rule of thumb is to use 1/3 of your fuel to get to the destination, 1/3 to return, and to keep 1/3 as an emergency reserve. With the boat level on a trailer or in the water, turn the main switch to the "ON" (on) position and check the fuel level. For fuel filling instructions, see page 53.

EMU40770

Removing top cowling

For the following checks, remove the top cowling from the bottom cowling.

To remove the top cowling, pull the cowling lock levers and lift up the top cowling.

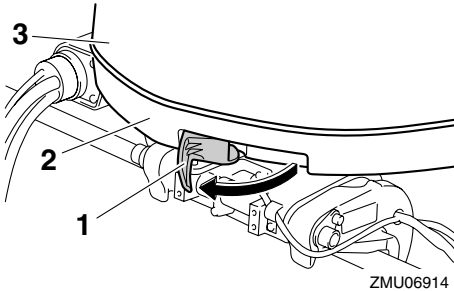

ZMU06914

1. Cowling lock lever
2. Bottom cowling
3. Top cowling

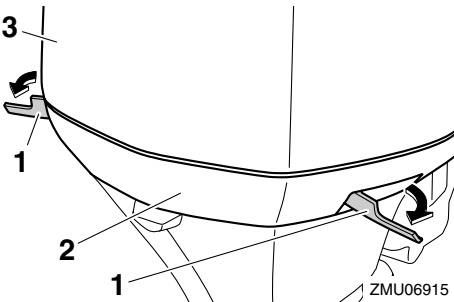

ZMU06915

1. Cowling lock lever
2. Bottom cowling
3. Top cowling

EMU36442

Fuel system

EWM00060



WARNING

Gasoline and its vapors are highly flammable and explosive. Keep away from sparks, cigarettes, flames, or other sources of ignition.

EWM00910



WARNING

Leaking fuel can result in fire or explosion.

- Check for fuel leakage regularly.
- If any fuel leakage is found, the fuel system must be repaired by a qualified mechanic. Improper repairs can make the outboard unsafe to operate.

EMU36451

Check for fuel leaks

- Check for fuel leaks or gasoline fumes in the boat.
- Check for fuel leakage from the fuel system.
- Check the fuel tank and fuel lines for cracks, swellings, or other damages.

EMU37321

Checking the fuel filter

Check that the fuel filter is clean and free of water. If any water is found in the fuel, or if a significant amount of debris is found, the fuel tank should be checked and cleaned by a Yamaha dealer.

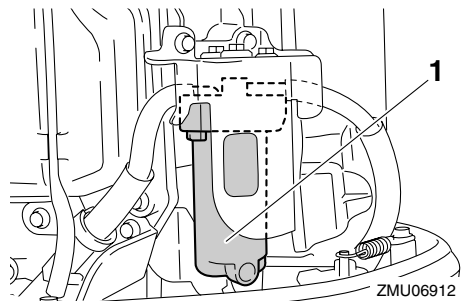

ZMU06912

1. Fuel filter

Operation

EMU40541

Controls

- Turn the steering wheel fully to port and starboard. Check that operation is smooth and unrestricted throughout the whole range with no binding or excessive free play.
- Operate the remote control lever several times to check that there is no hesitation in its travel. Operation should be smooth over the complete range of motion.
- Inspect the throttle and shift cable connections for damage and looseness.

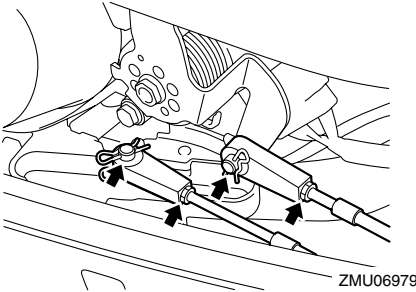

EMU40362

Engine shut-off cord (lanyard)

Check the engine shut-off cord and clip for damage, such as cuts, breaks, and wear.

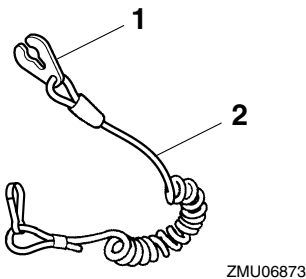

1. Clip
2. Engine shut-off cord (lanyard)

EMU40993

Engine oil

1. Place the outboard motor in a vertical position (not tilted). **NOTICE: If the outboard motor is not level, the oil level indicated on the oil dipstick may not be accurate.** [ECM01861]
2. Remove the oil dipstick and wipe it clean.

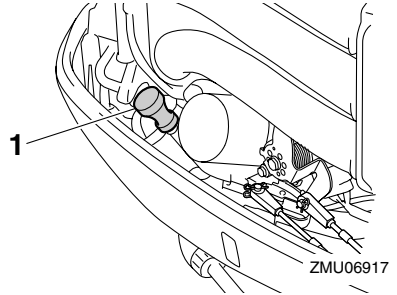

1. Oil dipstick
3. Insert the oil dipstick completely and remove it again.
4. Check that the oil level on the oil dipstick is between the upper and lower marks. Consult your Yamaha dealer if the oil level is not at the proper level or if it appears milky or dirty.

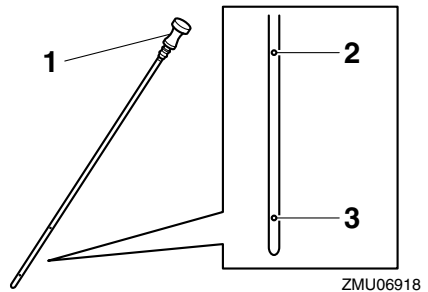

1. Oil dipstick
2. Upper mark
3. Lower mark

EMU40411

Outboard motor

- Check that the outboard motor is mounted properly and check the outboard motor mounting bolts for looseness.
- Check the propeller for damage.
- Check for engine oil leaks.

EMU36491

Flushing device

Check that the flushing device's garden hose connector is securely screwed on to the fitting on the bottom cowling. **NOTICE: If the garden hose connector is not properly connected, cooling water can leak out and the engine can overheat during operation.**

[ECM01801]

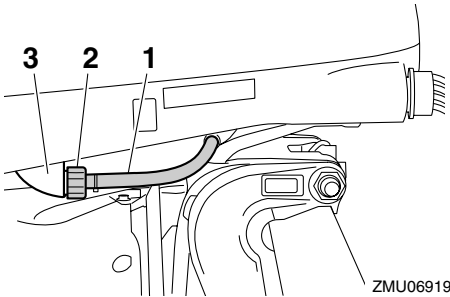

ZMU06919

1. Flushing device
2. Garden hose connector
3. Fitting

EMU40751

Installing top cowling

1. Check the rubber seal for damage. If the rubber seal is damaged, have it replaced by a Yamaha dealer.

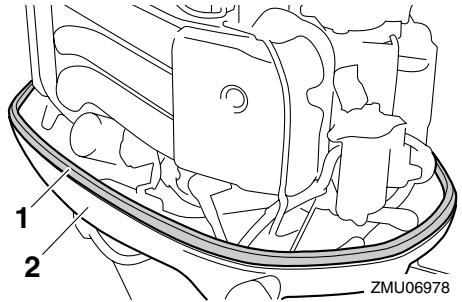

ZMU06978

1. Rubber seal
 2. Bottom cowling
2. Check that the rubber seal is seated all the way around the bottom cowling.
 3. Check that all of the cowling lock levers are pulled outward.
 4. Align the 3 protrusions on the top cowling with the corresponding holders on the bottom cowling, and then place the top cowling on the bottom cowling.

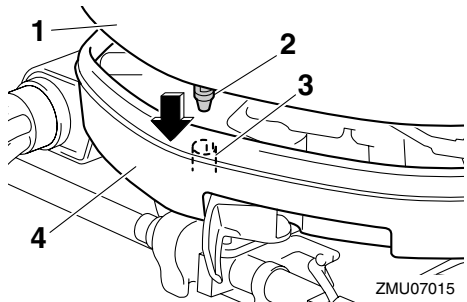

ZMU07015

1. Top cowling
2. Protrusion
3. Holder
4. Bottom cowling

Operation

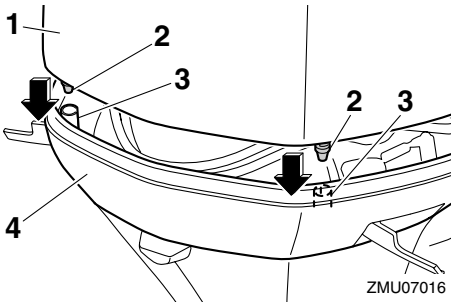

1. Top cowling
 2. Protrusion
 3. Holder
 4. Bottom cowling
5. Push the cowling lock levers inward to secure the top cowling.

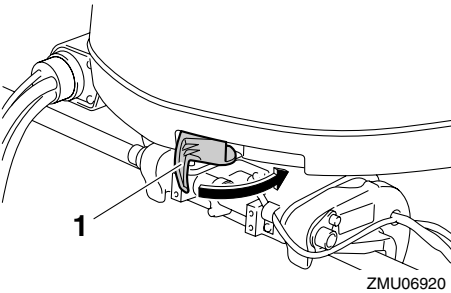

1. Cowling lock lever

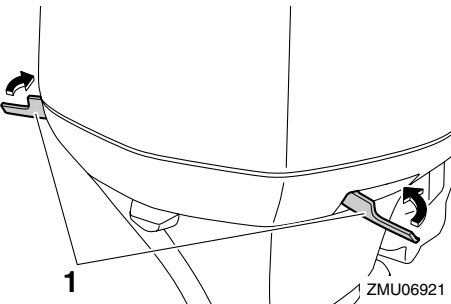

1. Cowling lock lever
6. Check the fitting of the top cowling by pushing it with both hands. **NOTICE: If the top cowling is not installed cor-**

rectly, water can enter the top cowling and damage the engine, or the top cowling can blow off at high speeds.

[ECM02370]

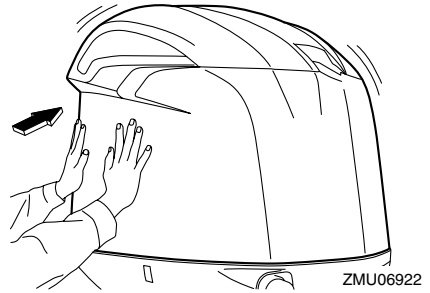

EMU40583

Checking power trim and tilt unit

EWM02523

! WARNING

- Never get under the lower unit while it is tilted, even when the tilt support shaft is installed. Severe injury could occur if the outboard motor accidentally falls.
- Body parts can be crushed between the outboard motor and the clamp bracket when the outboard motor is trimmed or tilted.
- Make sure that no one is near the outboard motor before performing this check.

1. Check the power trim and tilt unit for fluid leakage.

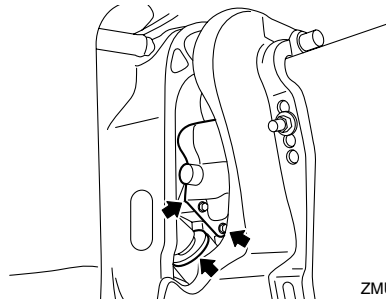

2. Operate each of the power trim and tilt switches on the bottom cowling and remote control lever to check that all switches work.

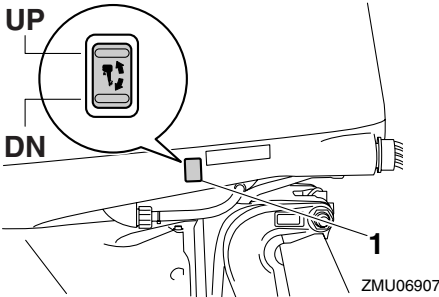

1. Power trim and tilt switch

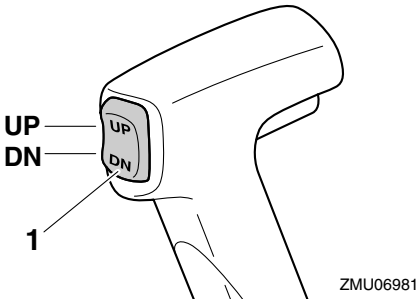

1. Power trim and tilt switch
3. Tilt the outboard motor up and check that the tilt rod and trim rods are extended completely.

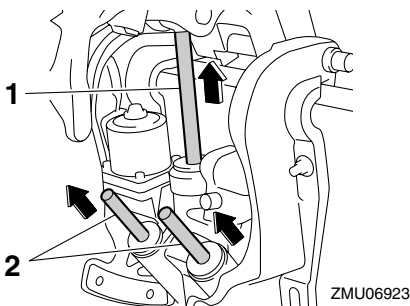

1. Tilt rod
2. Trim rod

4. Check that the tilt rod and trim rods are not corroded or damaged.
5. Tilt the outboard motor down. Check that the tilt rod and trim rods operate smoothly.

EMU36582

Battery

Check that the battery is in good condition, and fully charged. Check that the battery connections are clean, secure and covered by insulating covers. The electrical contacts of the battery and cables must be clean and properly connected or the battery will not start the engine.

Refer to the battery manufacturer's instructions for checks for your particular battery.

EMU30024

Filling fuel

EWM01830

WARNING

- Gasoline and its vapors are highly flammable and explosive. Always refuel according to this procedure to reduce the risk of fire and explosion.
- Gasoline is poisonous and can cause injury or death. Handle gasoline with care. Never siphon gasoline by mouth. If you should swallow some gasoline or inhale a lot of gasoline vapor, or get some gasoline in your eyes, see your doctor immediately. If gasoline spills on your skin, wash with soap and water. If gasoline spills on your clothing, change your clothes.

1. Make sure that the engine is stopped.
2. Make sure that the boat is in a well-ventilated outdoor area, either securely moored or trailered.
3. Make sure that no one is in the boat.
4. Do not smoke and keep away from sparks, flames, static electric discharge, or other sources of ignition.

Operation

5. If you use a portable container to store and dispense fuel, only use a locally approved GASOLINE container.
6. Touch the fuel nozzle to the filler opening or funnel to help prevent electrostatic sparks.
7. Fill the fuel tank, but do not overfill. Fuel can expand and overflow if the temperature increases.
8. Tighten the fuel tank cap securely.
9. Wipe up any spilled gasoline immediately with dry rags. Dispose of rags properly according to local laws or regulations.

EMU40251

Operating engine

EWMO2600

WARNING

This product emits exhaust gases which contain carbon monoxide, a colorless, odorless gas which could cause brain damage or death when inhaled. Symptoms include nausea, dizziness, and drowsiness. Keep cockpit and cabin areas well ventilated. Avoid blocking exhaust outlets.

EMU41290

Sending fuel

1. If your boat is equipped with a fuel tank selector valve, turn the valve to select the appropriate fuel tank.
2. Squeeze the primer pump, with the arrow pointing up, until you feel it become firm.

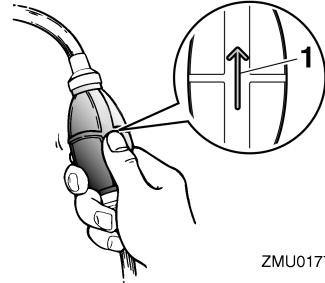

ZMU01770

1. Arrow

EMU27493

Starting engine

EWMO1600

WARNING

Before starting the engine, make sure that the boat is tightly moored and that you can steer clear of any obstructions. Be sure there are no swimmers in the water near you.

EMU40642

Procedure for starting engine

EWMO2591

WARNING

- Failure to attached engine shut-off cord (lanyard) could result in a runaway boat if operator is ejected. Attach the engine shut-off cord to a secure place on your clothing, or your arm or leg while operating. Do not attach the engine shut-off cord to clothing that could tear loose. Do not route the engine shut-off cord where it could become entangled, preventing it from functioning.
- Avoid accidentally pulling the engine shut-off cord during normal operation. Loss of engine power means the loss of most steering control. Also, without engine power, the boat could slow rapidly. This could cause people and objects in the boat to be thrown forward.

1. Move the remote control lever to the neutral position.

TIP:

The start-in-gear protection device prevents the engine from starting except when in neutral.

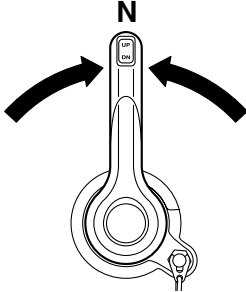

ZMU07034

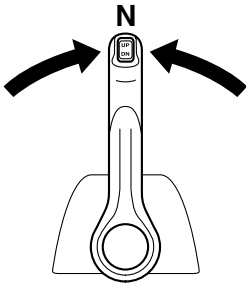

ZMU06926

2. Attach the engine shut-off cord to a secure place on your clothing, or your arm or leg. Then, attach the clip on the other end of the engine shut-off cord to the engine shut-off switch.

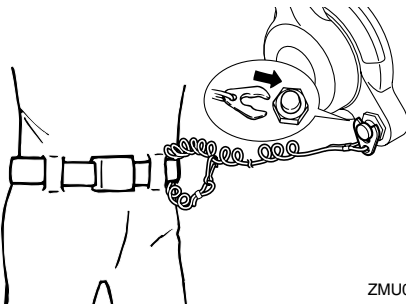

ZMU07037

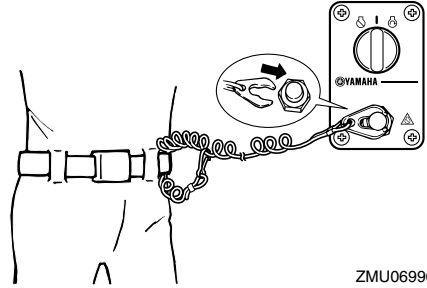

ZMU06996

3. Turn the main switch to the "ON" (on) position.

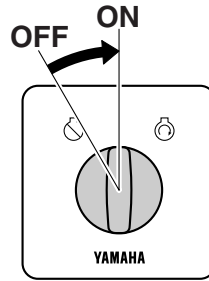

ZMU07031

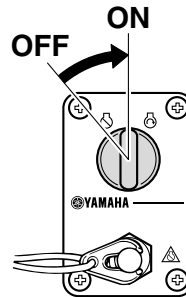

ZMU06927

4. Turn the main switch to the "START" (start) position, and hold it for a maximum of 5 seconds.

Operation

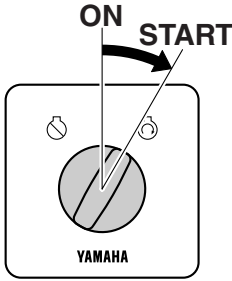

ZMU07032

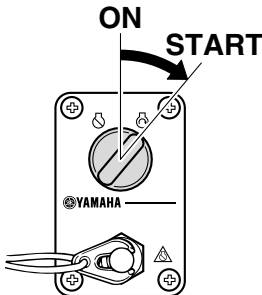

ZMU06928

5. Immediately after the engine starts, release the main switch to return it to the "ON" (on) position. **NOTICE:** Never turn the main switch to "START" (start) while the engine is running. Do not keep the starter motor turning for more than 5 seconds. If the starter motor is turned continuously for more than 5 seconds, the battery will be quickly discharged, thus making it impossible to start the engine. The starter can also be damaged. If the engine will not start after 5 seconds of cranking, return the main switch to "ON" (on), wait 10 seconds, then crank the engine again. [ECM00192]

EMU36510

Checks after starting engine

EMU41360

Cooling water

Check for a steady flow of water from the cooling water pilot hole. A continuous flow of water from the cooling water pilot hole shows that the water pump is pumping water through the cooling water passages.

TIP:

When the engine is started, there may be a slight delay before water flows from the cooling water pilot hole.

ECM02250

NOTICE

If water is not flowing out of the cooling water pilot hole at all times while the engine is running, overheating and serious damage could occur. Stop the engine and check whether the cooling water inlet on the lower case or the cooling water pilot hole is blocked. Consult your Yamaha dealer if the problem cannot be located and corrected.

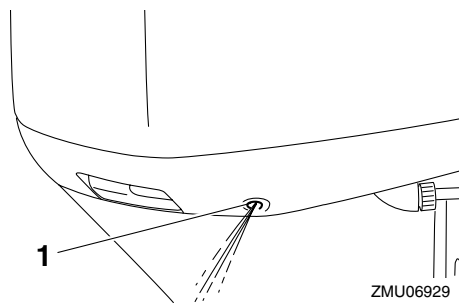

ZMU06929

1. Cooling water pilot hole

EMU27670

Warming up engine

EMU41231

Procedure for warming up engine

1. After starting the engine, warm up the engine until the engine speed stabilizes at idle speed to provide maximum operating performance and acceleration. Failure to do so will shorten engine life.
2. Check that the low oil pressure-alert indicator remains off. **NOTICE: If the low oil pressure-alert indicator blinks after the engine starts, stop the engine. Otherwise, serious engine damage could occur. Consult your Yamaha dealer.** [ECM02380]

EMU36531

Checks after engine warm up

EMU36541

Shifting

While the boat is tightly moored, and without applying throttle, confirm that the engine shifts smoothly into forward and reverse, and back to neutral.

EMU40460

Stop switches

Perform the following procedure to check that the main switch and engine shut-off switch operate properly.

- Check that the engine stops when the main switch is turned to the "OFF" (off) position.
- Check that the engine stops when the clip is pulled from the engine shut-off switch.
- Check that the engine cannot be started with the clip removed from the engine shut-off switch.

EMU31733

Shifting

EWM00180

WARNING

Before shifting, make sure there are no swimmers or obstacles in the water near you.

ECM01610

NOTICE

Warm up the engine before shifting into gear. Until the engine is warm, the idle speed may be higher than normal. High idle speed can prevent you from shifting back to neutral. If this occurs, stop the engine, shift to neutral, then restart the engine and allow it to warm up.

To shift out of neutral

1. Pull the neutral interlock trigger up (if equipped).

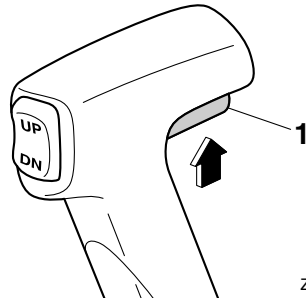

ZMU07042

1. Neutral interlock trigger
2. Move the remote control lever firmly and crisply forward (for forward gear) or rearward (for reverse gear) about 35° (a detent can be felt).

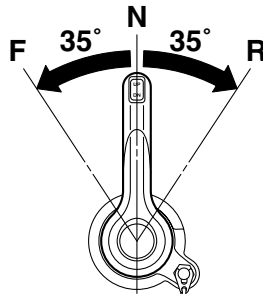

ZMU07035

Operation

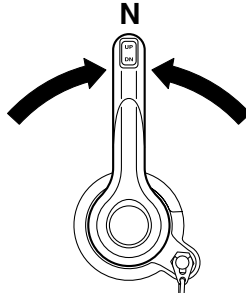
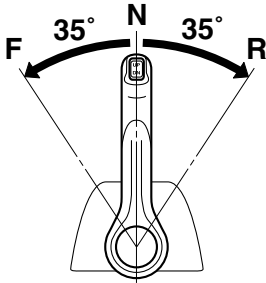

ZMU07034

To shift from in gear (forward/reverse) to neutral

1. Close the throttle so that the engine slows to idle speed.

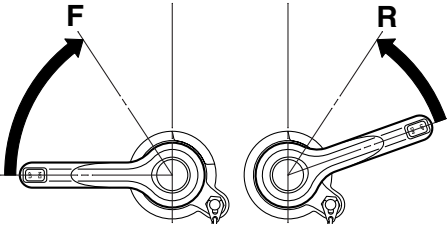

ZMU07036

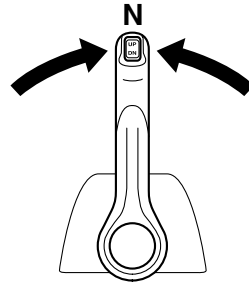

ZMU06926

EMU40472

Stopping boat

EWM01510

WARNING

- Do not use the reverse function to slow down or stop the boat as it could cause you to lose control, be ejected, or impact the steering wheel or other parts of the boat. This could increase the risk of serious injury. It could also damage the shift mechanism.
- Do not shift into reverse while traveling at planing speeds. Loss of control, boat swamping, or damage to the boat could occur.

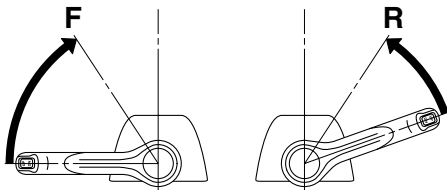

ZMU06931

2. After the engine is at idle speed in gear, move the remote control lever firmly and crisply to the neutral position.

The boat is not equipped with a separate braking system. Water resistance stops it after the throttle is closed and the engine returns to idle speed. The stopping distance varies depending on gross weight, water surface conditions, and wind direction.

EMU27821

Stopping engine

Before stopping the engine, first let it cool off for a few minutes at idle or low speed. Stopping the engine immediately after operating at high speed is not recommended.

EMU40670

Procedure for stopping engine

1. Turn the main switch to the "OFF" (off) position.

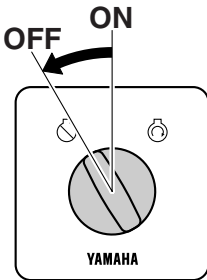

ZMU07033

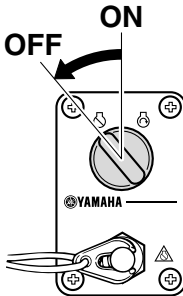

ZMU06932

2. Remove the key if the boat will be left unattended.

TIP:

The engine can also be stopped by pulling the engine shut-off cord (lanyard) and removing the clip from the engine shut-off switch, then turning the main switch to the "OFF" (off) position.

EMU27862

Trimming outboard motor

EWM00740

WARNING

Excessive trim for the operating conditions (either trim up or trim down) can cause boat instability and can make steering the boat more difficult. This increases the possibility of an accident. If the boat begins to feel unstable or is hard to steer, slow down and/or readjust the trim angle.

The trim angle of the outboard motor helps determine the position of the bow of the boat in the water. Correct trim angle will help improve performance and fuel economy while reducing strain on the engine. Correct trim angle depends upon the combination of boat, engine, and propeller. Correct trim is also affected by variables such as the load in the boat, sea conditions, and running speed.

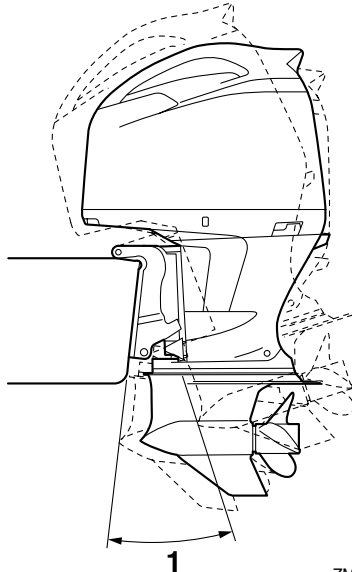

ZMU06933

1. Trim operating angle

Operation

EMU40421

Adjusting trim angle

EWM02471

WARNING

- Make sure that all people are clear of the outboard motor when adjusting the trim angle. Body parts can be crushed between the outboard motor and the clamp bracket when the outboard motor is trimmed or tilted.
- Use caution when trying a trim angle for the first time. Increase speed gradually and watch for any signs of instability or control problems. Improper trim angle can cause loss of control.
- If the outboard motor is equipped with a power trim and tilt switch located on the bottom cowling, use the switch only when the boat is at a complete stop with the engine off. Do not adjust the trim angle with this switch while the boat is moving.

Adjust the outboard motor trim angle using the power trim and tilt switch.

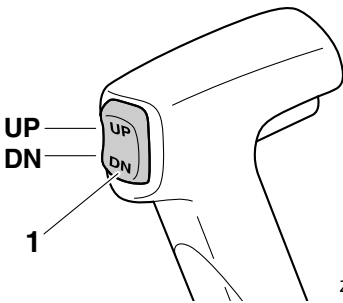

1. Power trim and tilt switch

To raise the bow (trim-out), push the “UP” (up) side of the switch.

To lower the bow (trim-in), push the “DN” (down) side of the switch.

Make test runs with the outboard motor set at different trim angles to find the position that works best for your boat and operating conditions.

EMU41081

Adjusting boat trim

When the boat is on plane, a bow-up attitude results in less drag, greater stability and efficiency. This is generally when the keel line of the boat is up about 3 to 5 degrees. With the bow up, the boat may have a greater tendency to steer to one side or the other. Compensate for this as you steer. When the bow of the boat is down, it is easier to accelerate from a standing start onto plane.

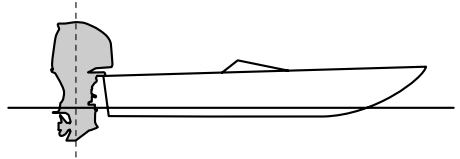

ZMU07038

Bow Up

Too much trim-out puts the bow of the boat too high in the water. Performance and economy are decreased because the hull of the boat is pushing the water and there is more air drag. Excessive trim-out can also cause the propeller to ventilate, which reduces performance further, and the boat may “porpoise” (hop in the water), which could throw the operator and passengers overboard.

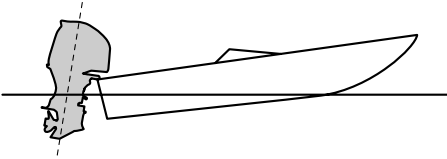

ZMU07039

Bow Down

Too much trim-in causes the boat to “plow” through the water, decreasing fuel economy and making it hard to increase speed. Operating with excessive trim-in at higher speeds also makes the boat unstable. Resistance at the bow is greatly increased, heightening the danger of “bow steering” and making operation difficult and dangerous.

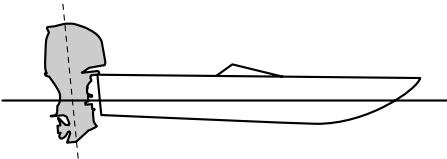

ZMU07040

EMU27946

Tilting up and down

If the engine will be stopped for some time or if the boat is moored in shallows, the outboard motor should be tilted up to protect the propeller and lower case from damage by collision with obstructions, and also to reduce salt corrosion.

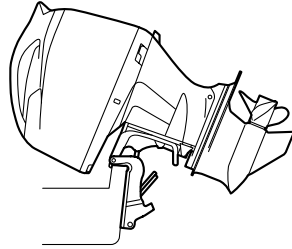

ZMU06998

EWM01543

WARNING

Make sure that all people are clear of the outboard motor when tilting the outboard motor up and down. Body parts can be crushed between the outboard motor and the clamp bracket when the outboard motor is trimmed or tilted.

ECM00991

NOTICE

- Before tilting the outboard motor, follow the procedure under “Stopping engine” in this chapter. Never tilt the outboard motor while the engine is running. Severe damage from overheating can result.
- To prevent the cooling water passages from becoming frozen when the ambient temperature is 5°C or below, tilt the outboard motor up after it has been stopped 30 seconds or more.

EMU40692

Procedure for tilting up

1. Move the remote control lever to the neutral position.

Operation

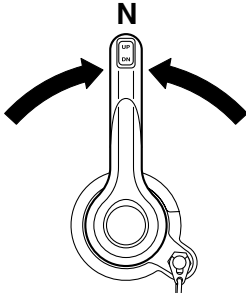

ZMU07034

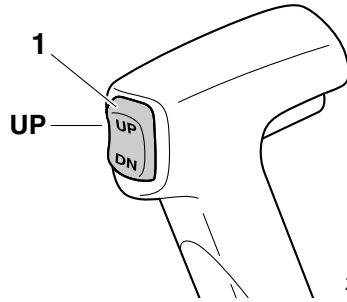

ZMU06986

1. Power trim and tilt switch

3. If you have the tilt support shaft, install the tilt support shaft. For information on installing the tilt support shaft, see page 29.

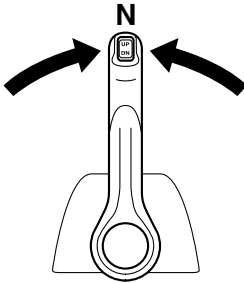

ZMU06926

2. Push the "UP" (up) side of the power trim and tilt switch to fully tilt the outboard motor up.

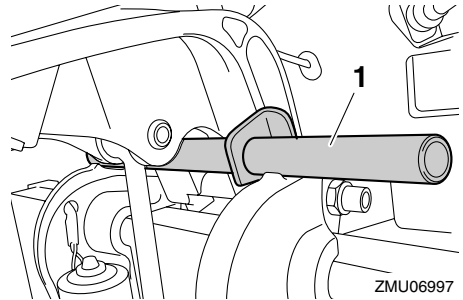

ZMU06997

1. Tilt support shaft

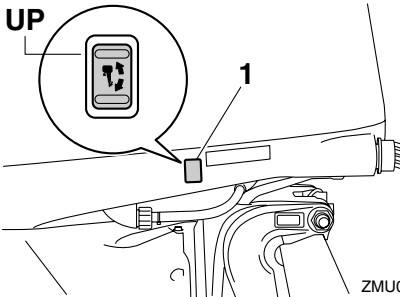

ZMU06937

1. Power trim and tilt switch

4. Once the outboard motor is supported with the tilt support shaft, push the "DN" (down) side of the power trim and tilt switch to retract the trim rods. **NOTICE: Make sure that the trim rods retract completely during mooring. This protects the rods from marine growth and corrosion, which could damage the power trim and tilt mechanism.** [ECM00252]

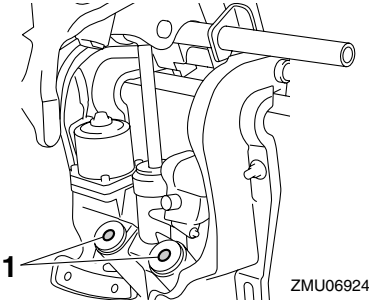

1. Trim rod

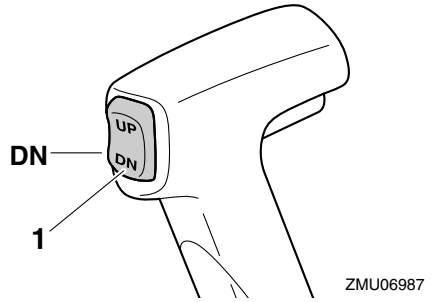

1. Power trim and tilt switch

EMU40733

Procedure for tilting down

1. If using the tilt support shaft, fully tilt the outboard motor up, and then remove the tilt support shaft.

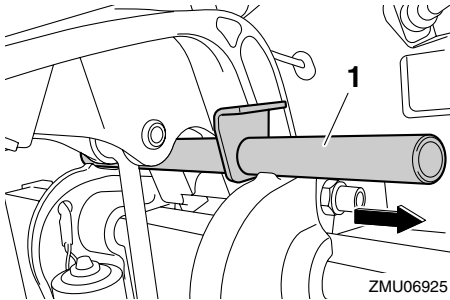

1. Tilt support shaft

2. Push the "DN" (down) side of the power trim and tilt switch to tilt the outboard motor down.

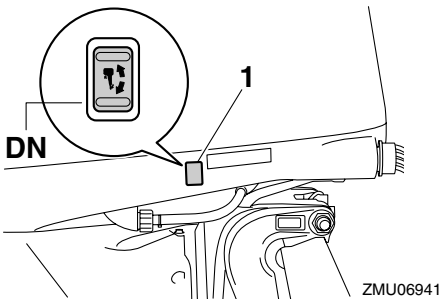

1. Power trim and tilt switch

EMU28061

Shallow water

EMU40701

Cruising in shallow water

The outboard motor can be tilted up partially to allow operation in shallow water.

ECM02360

NOTICE

Do not tilt the outboard motor up so that the cooling water inlet on the lower unit is above the surface of the water when setting up for and cruising in shallow water. Otherwise severe damage from overheating can result.

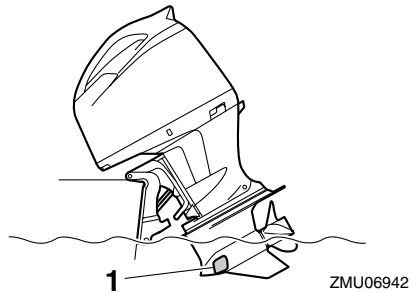

1. Cooling water inlet

EMU40711

Procedure for shallow water cruising

1. Move the remote control lever to the neutral position.

Operation

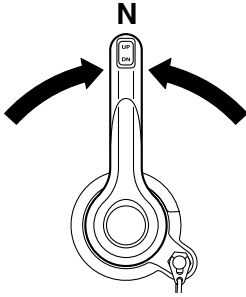

ZMU07034

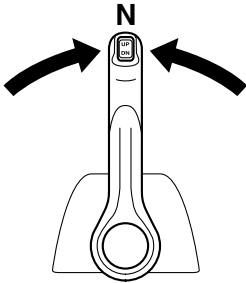

ZMU06926

2. Push the "UP" (up) side of the power trim and tilt switch to tilt the outboard motor up slightly to the desired position. **WARNING! Using the power trim and tilt switch on the bottom cowling while the boat is moving or engine is on could increase the risk of falling overboard and could distract the operator, increasing the risk of collision with another boat or an obstacle.** [EWM01850]

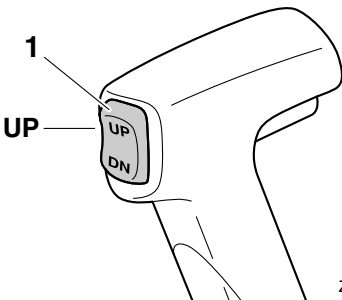

ZMU06986

1. Power trim and tilt switch

3. To return the outboard motor to the normal running position, push the "DN" (down) side of the power trim and tilt switch to tilt the outboard motor down slowly.

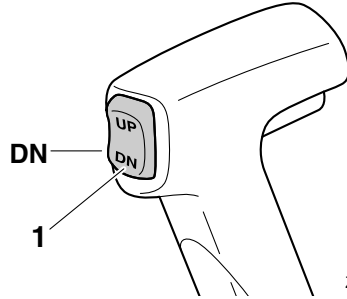

ZMU06987

1. Power trim and tilt switch

EMU41370

Operating in other conditions

Operating in salt water

After operating in saltwater, brackish water, or water high in other minerals, flush the cooling system with fresh water to minimize corrosion and clogging of the cooling water passages with deposits. Also, rinse the exterior of the outboard motor with fresh water.

Operating in water containing mud, sand, silt, debris, or vegetation

Mud, sand, silt, debris, and vegetation in the water may restrict water flow into the cooling water inlet covers or clog internal water passages. Check and clean the cooling water inlet covers frequently when operating in these conditions. Flush the engine with clean, fresh water after use in these environments. Consult your dealer if normal water flow can not be restored by cleaning the cooling water inlet covers or flushing with fresh water.

EMU40833

Transporting and storing outboard motor

EWM02551



- **Leaking fuel is a fire hazard. When transporting and storing the outboard motor, close the fuel cock to prevent fuel from leaking.**
- **Never get under the outboard motor while it is tilted, even when the tilt support shaft is installed. Severe injury could occur if the outboard motor accidentally falls.**

The outboard motor should be trailered and stored in the fully tilted-down position. If the outboard motor cannot be trailered in the fully tilted-down position, the outboard motor must be secured in the tilted-up position using a support device, such as the Yamaha Trailering Support.

EMU41001

Storing outboard motor

When storing your Yamaha outboard motor for prolonged periods of time (2 months or longer), several important procedures must be performed to prevent excessive damage. It is advisable to have your outboard motor serviced by an authorized Yamaha dealer prior to storage. However, you, the owner, with a minimum of tools, can perform the following procedures.

ECM02281

NOTICE

Store the outboard motor in a dry, well-ventilated place, not in direct sunlight.

EMU41380

Conditioning and stabilizing gasoline

When preparing to store a boat for extended periods (2 months or longer) it is best to completely remove all gasoline from the boat's

fuel tank(s). If it is not possible to remove the gasoline, add one ounce of "Yamalube Fuel Stabilizer & Conditioner Plus" to each gallon of gasoline in a full tank of gasoline to provide fuel stability and corrosion protection.

TIP:

Do not fill the fuel tank(s) to the point of overflowing. Approximately 7/8 full will allow enough space in the fuel tank to prevent gasoline purging from the fuel tank vent due to expansion with temperature changes.

Do not cap the fuel tank vent. Excessive pressure could damage the boat and motor's fuel systems.

A partially filled fuel tank, less than 7/8 full but not completely empty, is not recommended.

Air space above the gasoline allows air movement which can bring in water through condensation as the air temperature changes.

Condensation inside the fuel tank can cause corrosion problems and phase separation of gasoline containing ethanol.

Consult your Yamaha dealer concerning preventative measures that may work best for the gasoline and environmental conditions in your area.

EMU28305

Procedure

EMU41141

Cleaning the outboard motor

When cleaning the outboard motor, the top cowling must be installed.

1. Wash the exterior of the outboard motor using fresh water. **NOTICE: Do not spray water into the air intake.** [ECM01840]

Maintenance

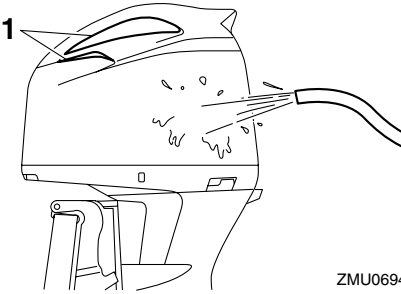

1. Air intake
2. Drain the cooling water completely out of the outboard motor. Clean the body thoroughly.

EMU41071

Lubrication

1. Change the gear oil. For instructions, see page 78. Check the gear oil for the presence of water that indicates a leaky seal. Seal replacement should be performed by an authorized Yamaha dealer prior to use.
2. Lubricate all grease fittings. For further details, see page 72.

TIP:

For long-term storage, fogging the engine with fogging oil is recommended. Contact your Yamaha dealer for information about fogging oil and procedures for your outboard motor.

EMU41152

Cleaning and anticorrosion measures

1. Wash the exterior of the outboard motor using fresh water, and then dry the outboard motor completely. For instructions on cleaning the outboard motor, see page 65. **NOTICE: Do not spray water into the air intake.** [ECM01840]
2. Spray the outboard motor powerhead with "Yamaha Silicone Protectant."
3. Wax the cowling with a non-abrasive wax such as "Yamaha Silicone Wax."

EMU40962

Flushing cooling water passage

Perform this procedure right after operation for the most thorough flushing.

ECM01530

NOTICE

Do not perform this procedure while the engine is running. The water pump may be damaged and severe damage from overheating can result.

1. Disconnect the garden hose connector from the fitting on the bottom cowling.

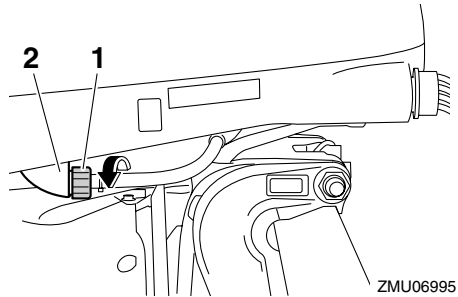

1. Garden hose connector
 2. Fitting
2. Connect the garden hose to the garden hose connector.

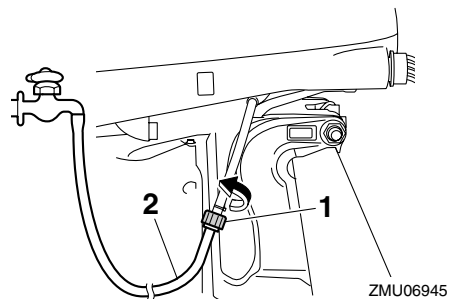

1. Garden hose connector
2. Garden hose

3. With the engine off, turn on the water supply and let the water flush through the cooling water passages for about 15 minutes.
4. Turn off the water supply, and then disconnect the garden hose from the garden hose connector.
5. Connect the garden hose connector to the fitting on the bottom cowling and tighten it securely. **NOTICE: If the garden hose connector is not properly connected, cooling water can leak out and the engine can overheat during operation.** [ECM01801]

TIP:

When flushing the cooling water passages with the boat in the water, tilting the outboard motor up until it is completely out of the water will achieve better results.

EMU28461

Checking painted surface of outboard motor

Check the outboard motor for scratches, nicks, or flaking paint. Areas with damaged paint are more likely to corrode. If necessary, clean and paint the areas. A touch-up paint is available from your Yamaha dealer.

EMU40440

Periodic maintenance

EWM02480



These procedures require mechanical skills, tools, and supplies. If you do not have the proper skills, tools, or supplies to perform a maintenance procedure, have a Yamaha dealer or other qualified mechanic do the work.

The procedures involve disassembling the outboard motor and exposing dangerous parts. To reduce the risk of injury from moving, hot, or electrical parts:

- **Unless otherwise specified, stop the engine and keep the key and engine shut-off cord (lanyard) with you when you perform maintenance.**
- **The power trim and tilt switches operate even when the main switch is turned to the “OFF” (off) position. Keep people away from the power trim and tilt switches whenever working around the outboard motor. When the outboard motor is tilted, keep away from the area under it or between it and the clamp bracket. Make sure that no one is in this area before operating the power trim and tilt mechanism.**
- **Allow the engine to cool before handling hot parts or fluids.**
- **Always assemble the outboard motor completely before operating it.**

Maintenance, replacement, or repair of the emission control devices and system may be performed by any marine engine repair establishment or individual. All warranty repairs; however, including those to the emission control system, must be performed by an authorized Yamaha marine dealership.

A service manual is available for purchase through your Yamaha dealer for owners who have the mechanical skills, tools, and other equipment necessary to perform maintenance not covered by this owner's manual.

EMU28511

Replacement parts

If replacement parts are necessary, use only genuine Yamaha parts or parts of equivalent design and quality. Any part of inferior quality may malfunction, and the resulting loss of control could endanger the operator and pas-

Maintenance

sengers. Yamaha genuine parts and accessories are available from your Yamaha dealer.

EMU35521

Maintenance interval guidelines

The service intervals provided in the Maintenance Chart were developed based upon “typical” use that includes operating at varied speeds, with sufficient time for engine warm up and cool-down, a medium to light load, and an average cruising speed near the 3000 to 4000 rpm range. As with any engine, however, if your normal operating conditions are different, you should consider service more often than shown, especially how often you change your engine oil and gear oil. Examples might include extended wide-open-throttle use or long periods of trolling or idling, carrying heavy loads, or frequent starting and stopping or shifting. More frequent maintenance will often pay off many times over in increased engine life and greater owner satisfaction. Consult your Yamaha dealer for additional maintenance recommendations.

EMU34446

Maintenance chart 1

TIP:

- Refer to the sections in this chapter for explanations of each owner-specific action.
- The maintenance cycle on these charts assume usage of 100 hours per year and regular flushing of the cooling water passages. Maintenance frequency should be adjusted when operating the engine under adverse conditions such as extended trolling.
- Disassembly or repairs may be necessary depending on the outcome of maintenance checks.
- Expendable or consumable parts and lubricants will lose their effectiveness over time and through normal usage regardless of the warranty period.
- When operating in salt water, muddy, other turbid (cloudy), acidic water, the engine should be flushed with clean water after each use.

The “●” symbol indicates the check-ups which you may carry out yourself.

The “○” symbol indicates work to be carried out by your Yamaha dealer.

Item	Actions	Initial	Every			
		20 hours (3 months)	100 hours (1 year)	300 hours (3 years)	500 hours (5 years)	
Anode(s) (external)	Inspection or replacement as necessary		●/○			
Anode (cylinder head exhaust passage)	Inspection or replacement as necessary		○			
Anodes (cylinder head, cylinder block, cylinder block thermostat portion, oil cooler cover, exhaust guide)	Replacement					○
Battery (electrolyte level, terminal)	Inspection	●/○	●/○			
Battery (electrolyte level, terminal)	Fill, charging or replacing as necessary		○			
Cooling water leakage	Inspection or replacement as necessary	○	○			
Cowling lock lever	Inspection		●/○			
Engine starting condition/noise	Inspection	●/○	●/○			
Engine idle speed/noise	Inspection	●/○	●/○			
Engine oil	Replacement	●/○	●/○			
Engine oil filter (cartridge)	Replacement		○			
Fuel filter (can be disassembled)	Inspection or replacement as necessary	●/○	●/○			

Maintenance

Item	Actions	Initial	Every			
		20 hours (3 months)	100 hours (1 year)	300 hours (3 years)	500 hours (5 years)	
Fuel line (High pressure)	Inspection or replacement as necessary	○	○			
Fuel line (Low pressure)	Inspection or replacement as necessary	○	○			
Fuel pump	Inspection or replacement as necessary			○		
Fuel/engine oil leakage	Inspection	○	○			
Gear oil	Replacement	●/○	●/○			
Greasing points	Greasing	●/○	●/○			
Impeller/water pump housing	Inspection or replacement as necessary		○			
Impeller/water pump housing	Replacement			○		
OCV (Oil Control Valve) filter	Replacement				○	
Power trim and tilt unit	Inspection	●/○	●/○			
Propeller/propeller nut/cotter pin	Inspection or replacement as necessary	●/○	●/○			
Shift link/shift cable	Inspection, adjustment or replacement as necessary	○	○			
Spark plug(s)	Inspection or replacement as necessary		●/○			
Ignition coils/ignition coil leads	Inspection or replacement as necessary	○	○			
Water from the cooling water pilot hole	Inspection	●/○	●/○			
Throttle link/throttle cable	Inspection, adjustment or replacement as necessary	○	○			
Thermostat	Inspection or replacement as necessary		○			
Timing belt	Inspection or replacement as necessary		○			
Valve clearance	Inspection and adjustment				○	
Cooling water inlet	Inspection	●/○	●/○			
Main switch/stop switch	Inspection or replacement as necessary	○	○			

Maintenance

Item	Actions	Initial	Every			
		20 hours (3 months)	100 hours (1 year)	300 hours (3 years)	500 hours (5 years)	
Wire harness connections/wire coupler connections	Inspection or replacement as necessary	○	○			
(Yamaha) Meter/gauge	Inspection	○	○			

EMU34451

Maintenance chart 2

Item	Actions	Every
		1000 hours
Exhaust guide/exhaust manifold	Inspection or replacement as necessary	○
Timing belt	Replacement	○

EMU28910

TIP:

When using lead or high-sulfur gasoline, inspecting valve clearance may be required more frequently than every 500 hours.

Maintenance

EMU41300

Greasing

Yamalube Marine Grease

VF250A, VF225A, VF200A

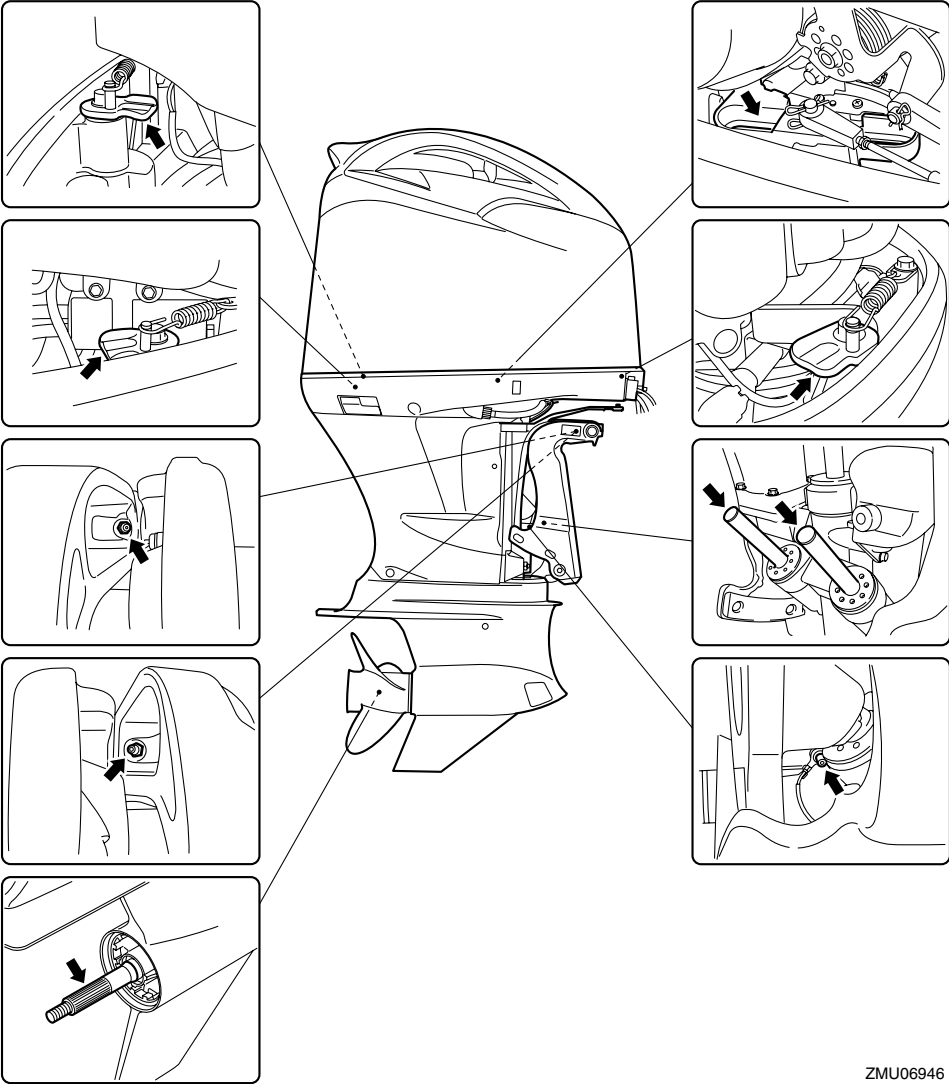

ZMU06946

EMU40662

Inspecting spark plug

The spark plug is an important engine component. The condition of the spark plug can indicate something about the condition of the engine. For example, if the center electrode porcelain is very white, this could indicate an intake air leak or carburetion problem in that cylinder. Do not attempt to diagnose any problems yourself. Instead, take the outboard motor to a Yamaha dealer. You should periodically remove and check the spark plug because heat and deposits will cause the spark plug to slowly break down and erode.

To remove the spark plug

1. Remove the flywheel magnet cover.

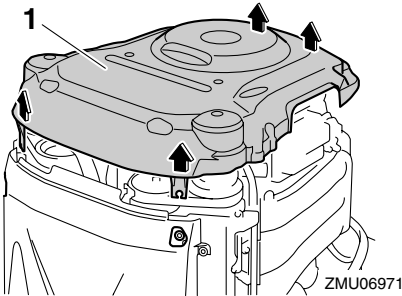

1. Flywheel magnet cover
2. Remove the ECM (Electronic Control Module) cover.

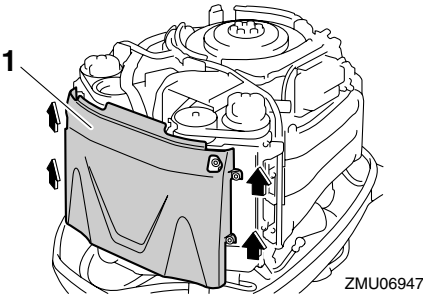

1. ECM (Electronic Control Module) cover

3. Remove the bolt that is securing the ignition coil, and then remove the ignition coil. **NOTICE: Do not use any tools to remove or install the ignition coil. Otherwise, the ignition coil coupler could be damaged.** [ECM02330]

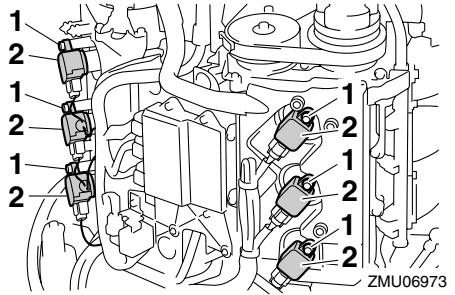

1. Bolt
2. Ignition coil

4. Remove the spark plug. **WARNING! When removing or installing a spark plug, be careful not to damage the insulator. A damaged insulator could allow external sparks, which could lead to explosion or fire.** [EWM00561]

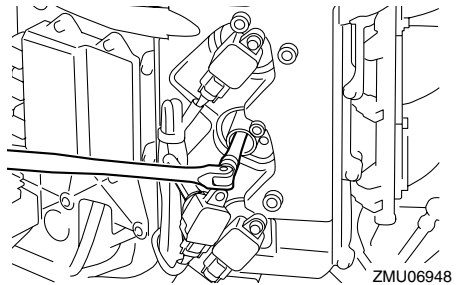

To check the spark plug

1. Check the condition of the spark plug. If electrode erosion becomes excessive or carbon and other deposits are excessive, replace the spark plug with the specified plug.

Maintenance

Standard spark plug:
LFR6A-11

2. Measure the spark plug gap using a thickness gauge. If the spark plug gap is out of specification, replace the spark plug with the specified plug.

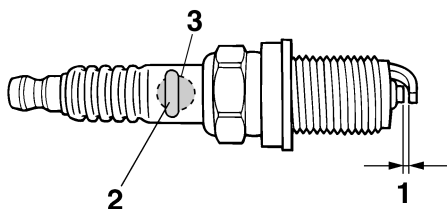

ZMU01797

1. Spark plug gap
2. Spark plug part number
3. Spark plug I.D. mark (NGK)

Spark plug gap:
1.0–1.1 mm (0.039–0.043 in)

To install the spark plug

1. Wipe off any dirt from the threads, insulator, and gasket surface of the spark plug.
2. Install the spark plug, and then tighten it to the specified torque.

Spark plug tightening torque:
28.0 Nm (2.86 kgf-m, 20.7 ft-lb)

TIP:

If a torque-wrench is not available when you are fitting a spark plug, fully tighten a spark plug with a spark plug wrench. Then tighten 1/4 to 1/2 turn more. Have the spark plug adjusted to the correct torque as soon as possible with a torque-wrench.

3. Install the ignition coil, and then tighten the bolt to the specified torque.

Bolt tightening torque:
8.0 Nm (0.82 kgf-m, 5.9 ft-lb)

4. Install the ECM cover.
5. Install the flywheel magnet cover.

EMU40872

Inspecting engine idle speed

ECM01690

NOTICE

This procedure must be performed while the outboard motor is in the water.

Inspect the engine idle speed using the Command Link tachometer or digital tachometer that is equipped on the boat. Results may vary depending on whether testing is conducted with the outboard motor in the water.

1. Start the engine and allow it to warm up fully in neutral until it is running smoothly.
2. Inspect the engine idle speed. If the engine idle speed is out of specification, consult a Yamaha dealer or other qualified mechanic.

Idle speed (in neutral):
750 \pm 50 r/min

EMU41203

Changing engine oil

ECM01710

NOTICE

Change the engine oil after the first 20 hours of operation or 3 months, and every 100 hours or at 1-year intervals thereafter. Otherwise the engine will wear quickly.

When changing the engine oil, the outboard motor must be placed in a vertical position. If you are not able to place the outboard motor in a vertical position, have a Yamaha dealer change the engine oil.

Maintenance

Procedure for changing engine oil using an oil changer

1. Place the outboard motor in a vertical position (not tilted). **NOTICE: If the outboard motor is not level, the oil level indicated on the oil dipstick may not be accurate.** [ECM01861]

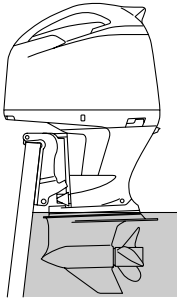

ZMU07021

2. Start the engine and warm it up until the engine speed stabilizes at idle speed.
3. Stop the engine and leave it for 5-10 minutes.
4. Remove the top cowling.
5. Remove the oil filler cap.

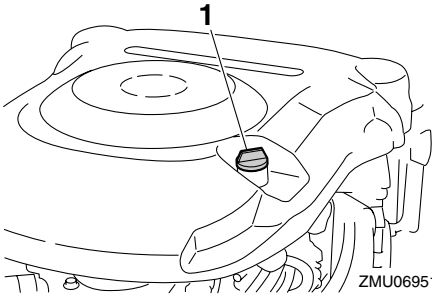

ZMU06951

1. Oil filler cap
6. Remove the oil dipstick.

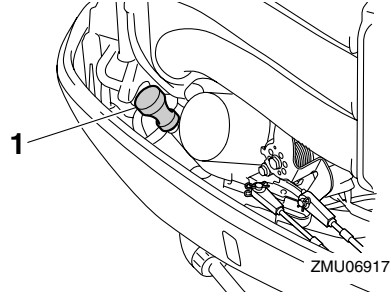

ZMU06917

1. Oil dipstick
7. Insert the tube of the oil changer into the oil dipstick guide, and then extract the engine oil completely.

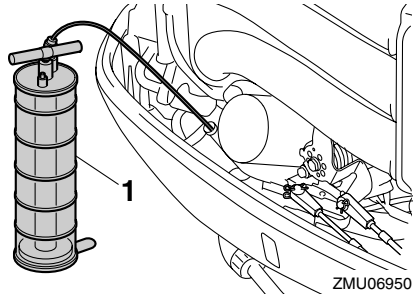

ZMU06950

1. Oil changer
8. Add the correct amount of engine oil through the filler hole. **NOTICE: Overfilling the engine with engine oil could cause leakage or damage. If the oil level is above the upper mark, extract engine oil until the oil level is between the upper and lower marks.** [ECM02270]

Maintenance

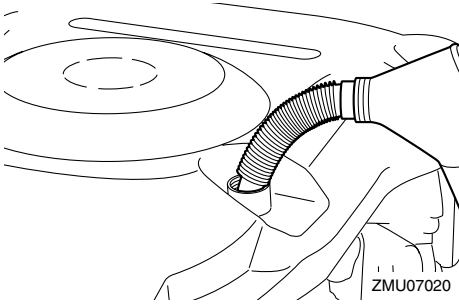

Replacement engine oil quantity (at periodic maintenance):

Without oil filter replacement:
6.4 L (6.76 US qt, 5.63 Imp.qt)

With oil filter replacement:
6.7 L (7.08 US qt, 5.90 Imp.qt)

9. Install the oil filler cap and oil dipstick.
10. Leave the outboard motor for 5-10 minutes.
11. Remove the oil dipstick and wipe it clean.
12. Insert the oil dipstick completely and remove it again.
13. Check that the oil level on the oil dipstick is between the upper and lower marks. Consult your Yamaha dealer if the oil level is not at the proper level.

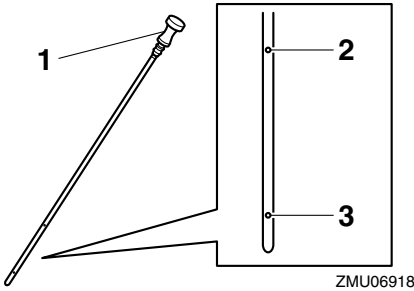

1. Oil dipstick
2. Upper mark
3. Lower mark

14. Start the engine and make sure that the low oil pressure-alert indicator remains off. Also, check that there are no oil leaks. **NOTICE:** If the low oil pressure-alert indicator comes on or if there are oil leaks, stop the engine and find the cause. Continued operation with a problem could cause severe engine damage. Consult your Yamaha dealer if the problem cannot be located and corrected. [ECM01622]
15. Dispose of used engine oil according to local regulations.

TIP:

- For more information on the disposal of used engine oil, consult your Yamaha dealer.
 - Change the engine oil more often when operating the engine under adverse conditions, such as extended trolling.
16. Install the top cowling.

EMU29114

Inspecting wiring and connectors

- Inspect that each connector is engaged securely.
- Inspect that each ground lead is properly secured.

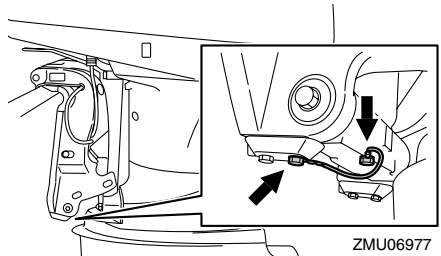

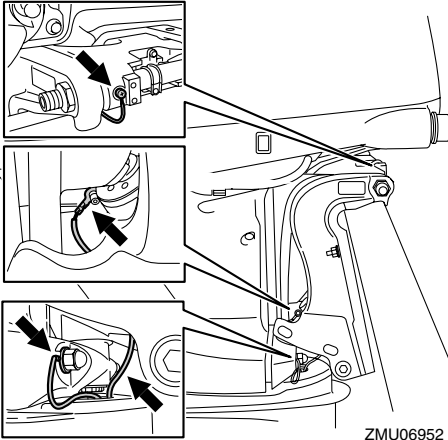

EMU40891

Inspecting propeller

EWM02561



WARNING

You could be seriously injured if the engine accidentally starts when you are near the propeller. Before inspecting, removing, or installing the propeller, move the remote control lever to the neutral position, turn the main switch to the “OFF” (off) position, remove the key, and remove the clip from the engine shut-off switch. Turn off the battery cut-off switch if your boat has one.

Do not use your hand to hold the propeller when loosening or tightening the propeller nut. Place a block of wood between the anti-cavitation plate and the propeller to prevent the propeller from turning.

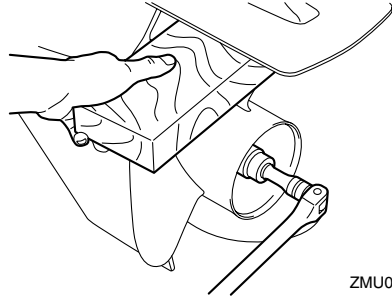

Checkpoints

- Check each of the propeller blades for erosion from cavitation or ventilation, and other damage.
- Check the propeller shaft for damage.
- Check the splines for wear and damage.
- Check for fish line tangled around the propeller shaft.

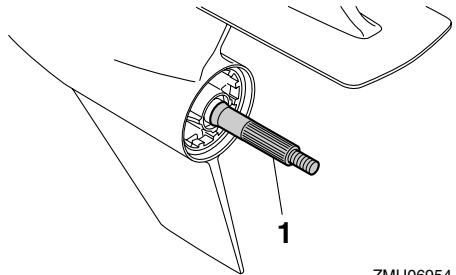

1. Propeller shaft

EMU40912

Removing propeller

1. Straighten the cotter pin and pull it out using a pair of pliers.
2. Remove the propeller nut, washer, and spacer. **WARNING! Do not use your hand to hold the propeller when loosening the propeller nut.** [EWM01890]

Maintenance

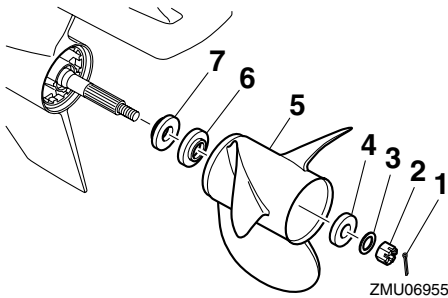

1. Cotter pin
2. Propeller nut
3. Washer
4. Spacer
5. Propeller
6. Spacer
7. Thrust washer

3. Remove the propeller, spacer, and thrust washer.

EMU40943

Installing propeller

ECM00501

NOTICE

Make sure to use a new cotter pin and bend the ends over securely. Otherwise, the propeller could come off during operation and be lost.

1. Apply Yamalube Marine Grease to the propeller shaft.
2. Install the thrust washer, spacer, and propeller on the propeller shaft. **NOTICE: Make sure to install the thrust washer before installing the propeller. Otherwise, the lower case and propeller boss could be damaged.** [ECM01881]
3. Install the spacer, washer, and propeller nut. Tighten the propeller nut to the specified torque.

Propeller nut tightening torque:
54.0 Nm (5.51 kgf-m, 39.8 ft-lb)

4. Align the propeller nut slot with the propeller shaft hole. Insert a new cotter pin in the hole and bend the cotter pin ends. **NOTICE: Do not reuse the cotter pin. Otherwise, the propeller can come off during operation.** [ECM01891]

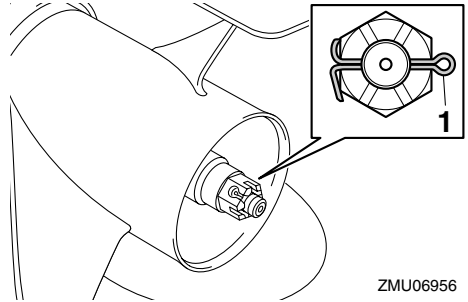

1. Cotter pin

TIP:

If the propeller nut slot does not align with the propeller shaft hole after tightening the propeller nut to the specified torque, tighten the nut further to align the slot with the hole.

EMU41191

Changing gear oil

EWM02530

WARNING

- Make sure that the outboard motor is mounted securely to the transom or a stable stand. You could be severely injured if the outboard motor falls on you.
- Never get under the lower unit while it is tilted. Severe injury could occur if the outboard motor accidentally falls.

Before filling the lower unit with gear oil, the outboard motor must be placed in a vertical position. If you are not able to place the outboard motor in a vertical position, have a Yamaha dealer change the gear oil.

1. Tilt the outboard motor so that the gear oil drain screw is at the lowest point possible.

- Place a suitable container under the gear case.
- Loosen the bolt, and then remove the cooling water inlet covers on both sides of the gear case.

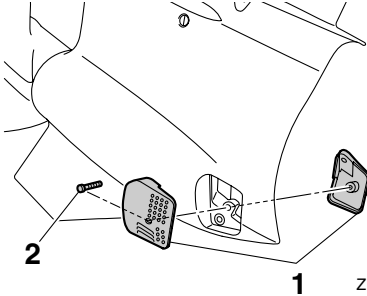

ZMU06957

- Cooling water inlet cover
- Bolt
- Remove the gear oil drain screw and gasket.

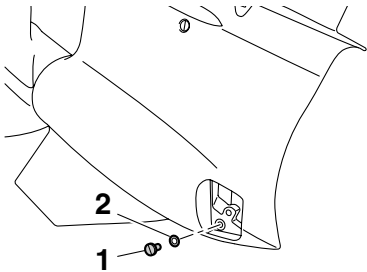

ZMU06993

- Gear oil drain screw
- Gasket
- Remove the oil level plug and gasket to allow the gear oil to drain completely. **NOTICE: Check the used gear oil after it has been drained. If the gear oil is milky or contains water or a large amount of metal particles, the gear case may be damaged. Have a Yamaha dealer check and repair the outboard motor.** [ECM00713]

TIP:

For disposal of used gear oil, consult your Yamaha dealer.

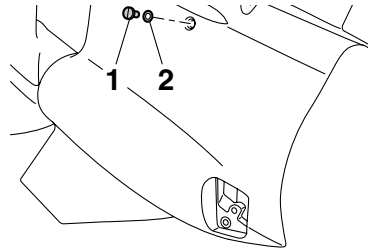

ZMU06994

- Oil level plug
- Gasket
- Remove any metal particles on the magnetic gear oil drain screw. **NOTICE: If there is an excessive quantity of metal particles on the magnetic gear oil drain screw, this can indicate lower unit problem. Consult your Yamaha dealer.** [ECM01900]
- Place the outboard motor in a vertical position. Using a flexible or pressurized filling device, inject the gear oil into the gear oil drain screw hole.

Gear oil quantity:
1.045 L (1.105 US qt, 0.920 Imp.qt)

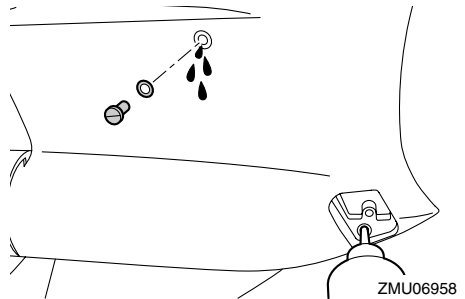

ZMU06958

Maintenance

- Put a new gasket on the oil level plug. When the gear oil begins to flow out of the oil level plug hole, insert and tighten the oil level plug to the specified torque.

Tightening torque:
9.0 Nm (0.92 kgf-m, 6.6 ft-lb)

- Put a new gasket on the gear oil drain screw. Insert and tighten the gear oil drain screw to the specified torque.

Tightening torque:
9.0 Nm (0.92 kgf-m, 6.6 ft-lb)

- Install the cooling water inlet covers on both sides of the gear case, and then tighten the bolt to the specified torque.

Tightening torque:
2.0 Nm (0.20 kgf-m, 1.5 ft-lb)

EMU41133

Inspecting and replacing anodes

Yamaha outboard motors are protected from corrosion by sacrificial anodes. Inspect the external anodes periodically. Remove scales from the surfaces of the anodes. Consult a Yamaha dealer for replacement of external anodes.

ECM00720

NOTICE

Do not paint anodes, as this would render them ineffective.

TIP:

Consult a Yamaha dealer for inspecting and replacement of internal anodes attached to the engine.

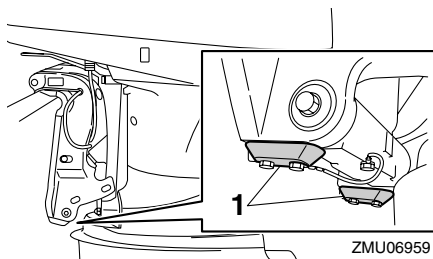

- Anode

EMU41102

Inspecting the battery

EWM01902

WARNING

Battery electrolyte is poisonous and caustic, and batteries generate explosive hydrogen gas. When working near the battery:

- Wear protective eye gear and rubber gloves.
- Do not smoke or bring any other source of ignition near the battery.

The procedure for inspecting the battery varies for different batteries. This procedure contains typical inspections that apply to many batteries, but you should always refer to the battery manufacturer's instructions.

ECM01920

NOTICE

A poorly maintained battery will quickly deteriorate.

- Check the electrolyte level.

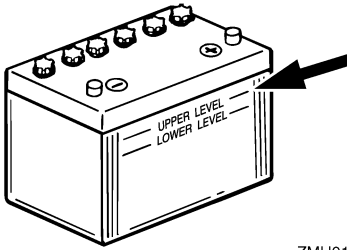

ZMU01810

2. Check that the battery is in good condition and fully charged. If your boat is equipped with the digital speedometer or Command Link tachometer, the voltmeter and low battery alert functions will help you monitor the battery's charge. If the battery needs charging, consult your Yamaha dealer.
3. Check that the battery connections are clean, secure, and covered by insulating covers. **WARNING! Bad connections can produce shorting or arcing and cause an explosion.** [EWM01912]

EMU41111

Connecting the battery

EWM00572



WARNING

Mount the battery holder securely in a dry, well-ventilated, vibration-free location in the boat. Install a fully charged battery in the holder.

ECM01124

NOTICE

Do not reverse the battery cables. Otherwise, the electrical parts could be damaged.

1. Check that the main switch is turned to the "OFF" (off) position before working on the battery.

2. Connect the positive battery cable (red) to the positive (+) terminal first. Then, connect the negative battery cable (black) to the negative (-) terminal.

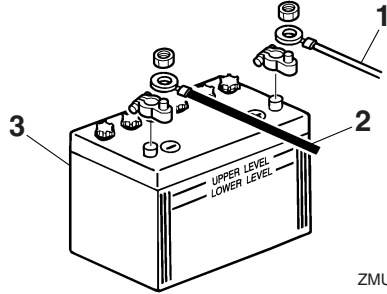

ZMU01811

1. Positive battery cable (red)
 2. Negative battery cable (black)
 3. Battery
3. The electrical contacts of the battery and cables must be clean and properly connected, or the battery will not start the engine.

EMU41120

Disconnecting the battery

1. Turn off the battery cut-off switch (if equipped) and main switch. **NOTICE: If they are left on, the electrical system can be damaged.** [ECM01930]
2. Disconnect the negative battery cable (black) from the negative (-) terminal. **NOTICE: Always disconnect the negative battery cable (black) first to avoid a short circuit and damage to the electrical system.** [ECM02310]
3. Disconnect the positive battery cable (red) from the positive (+) terminal and remove the battery from the boat.
4. Clean, maintain, and store the battery according to the manufacturer's instructions.

Trouble Recovery

EMU40972

Troubleshooting

This section describes the likely causes and remedies for problems, such as those in the fuel, compression, and ignition systems, poor starting, and loss of power. Please note that all of the items in this section may not apply to your model.

If your outboard motor requires repair, bring it to a Yamaha dealer.

If the engine trouble-alert indicator is blinking, consult your Yamaha dealer.

Starter will not operate.

Q. Is remote control lever in gear?

A. Shift to neutral.

Q. Is battery capacity low or weak?

A. Check battery condition. Use battery of recommended capacity.

Q. Are battery connections corroded or loose?

A. Tighten battery cables and clean battery terminals.

Q. Is fuse for starter relay or electric circuit blown?

A. Check for cause of electric overload and repair. Replace fuse with one of correct amperage.

Q. Are starter components malfunctioning?

A. Have serviced by a Yamaha dealer.

Engine will not start (starter operates).

Q. Is clip on engine shut-off cord (lanyard) installed?

A. Install clip to engine shut-off switch.

Q. Is fuel tank empty?

A. Fill tank with clean, fresh fuel.

Q. Is fuel contaminated or stale?

A. Fill tank with clean, fresh fuel.

Q. Is fuel filter clogged?

A. Clean or replace fuel filter.

Q. Is fuel pump malfunctioning?

A. Have serviced by a Yamaha dealer.

Q. Are spark plugs fouled or of incorrect type?

A. Inspect spark plugs. Clean or replace with recommended type.

Q. Are ignition parts malfunctioning?

A. Have serviced by a Yamaha dealer.

Q. Is ignition wiring damaged or poorly connected?

A. Inspect wires for breaks and wear. Have connections tightened and broken or worn wires replaced by a Yamaha dealer.

Q. Are engine inner parts damaged?

A. Have serviced by a Yamaha dealer.

Engine idles irregularly or stalls.

Q. Are spark plugs fouled or of incorrect type?

A. Inspect spark plugs. Clean or replace with recommended type.

Q. Is fuel system clogged?

A. Inspect for pinched or kinked fuel line or other obstructions in fuel system.

Q. Is fuel contaminated or stale?

A. Fill tank with clean, fresh fuel.

Q. Is fuel filter clogged?

Trouble Recovery

A. Clean or replace fuel filter.

Q. Are ignition parts malfunctioning?

A. Have serviced by a Yamaha dealer.

Q. Has alert system activated?

A. Find and correct cause of alert.

Q. Is spark plug gap incorrect?

A. Replace spark plug.

Q. Is ignition wiring damaged or poorly connected?

A. Inspect wires for breaks and wear. Have connections tightened and broken or worn wires replaced by a Yamaha dealer.

Q. Is specified engine oil not being used?

A. Inspect engine oil and replace with specified type.

Q. Is thermostat clogged or malfunctioning?

A. Have serviced by a Yamaha dealer.

Q. Is fuel pump malfunctioning?

A. Have serviced by a Yamaha dealer.

Q. Is fuel tank air vent restricted or clogged?

A. Remove obstruction.

Q. Is fuel joint connection incorrect?

A. Connect correctly.

Q. Is throttle cable adjustment incorrect?

A. Have serviced by a Yamaha dealer.

Q. Is battery cable disconnected?

A. Connect securely.

Alert buzzer sounds or indicator lights.

Q. Is cooling system clogged?

A. Inspect cooling water inlet for obstructions.

Q. Is low oil pressure-alert indicator on or blinking?

A. Have serviced by a Yamaha dealer.

Q. Is heat range of spark plugs incorrect?

A. Inspect spark plugs and replace with recommended type.

Q. Is specified engine oil not being used?

A. Inspect engine oil and replace with specified type.

Q. Is engine oil contaminated or deteriorated?

A. Replace engine oil with specified type.

Q. Is oil filter clogged?

A. Have serviced by a Yamaha dealer.

Q. Is oil pump malfunctioning?

A. Have serviced by a Yamaha dealer.

Q. Is thermostat or water pump malfunctioning?

A. Have serviced by a Yamaha dealer.

Q. Is there excess water in fuel filter?

A. Drain fuel filter.

Engine power loss.

Q. Is propeller damaged?

A. Have propeller repaired or replaced.

Q. Is propeller pitch or diameter incorrect?

A. Install correct propeller to operate outboard motor at its recommended speed (r/min) range.

Q. Is outboard motor mounted at incorrect height on transom?

Trouble Recovery

A. Have outboard motor adjusted to proper transom height.

Q. Has alert system activated?

A. Find and correct cause of alert.

Q. Is boat bottom fouled with marine growth?

A. Clean boat bottom.

Q. Are spark plugs fouled or of incorrect type?

A. Inspect spark plugs. Clean or replace with recommended type.

Q. Are weeds or other foreign material tangled on gear housing?

A. Remove foreign material and clean lower unit.

Q. Is fuel system clogged?

A. Inspect for pinched or kinked fuel line or other obstructions in fuel system.

Q. Is fuel filter clogged?

A. Clean or replace fuel filter.

Q. Is fuel contaminated or stale?

A. Fill tank with clean, fresh fuel.

Q. Is spark plug gap incorrect?

A. Replace spark plug.

Q. Is ignition wiring damaged or poorly connected?

A. Inspect wires for breaks and wear. Have connections tightened and broken or worn wires replaced by a Yamaha dealer.

Q. Are electrical parts malfunctioning?

A. Have serviced by a Yamaha dealer.

Q. Is specified fuel not being used?

A. Replace fuel with specified type.

Q. Is specified engine oil not being used?

A. Replace engine oil with specified type.

Q. Is thermostat clogged or malfunctioning?

A. Have serviced by a Yamaha dealer.

Q. Is fuel tank air vent restricted or clogged?

A. Remove obstruction.

Q. Is fuel pump malfunctioning?

A. Have serviced by a Yamaha dealer.

Q. Is fuel joint connection incorrect?

A. Connect correctly.

Q. Is heat range of spark plugs incorrect?

A. Inspect spark plugs and replace with recommended type.

Q. Is engine not responding properly to remote control lever position?

A. Have serviced by a Yamaha dealer.

Engine vibrates excessively.

Q. Is propeller damaged?

A. Have propeller repaired or replaced.

Q. Is propeller shaft damaged?

A. Have serviced by a Yamaha dealer.

Q. Are weeds or other foreign material tangled on propeller?

A. Remove and clean propeller.

Q. Are outboard motor mounting bolts loose?

A. Tighten bolts or have serviced by a Yamaha dealer.

Q. Is steering pivot loose or damaged?

A. Have serviced by a Yamaha dealer.

EMU29433

Temporary action in emergency

EMU29441

Impact damage

EWM00870

WARNING

The outboard motor can be seriously damaged by a collision while operating or trailering. Damage could make the outboard motor unsafe to operate.

If the outboard motor hits an object in the water, follow the procedure below.



ZMU06999

1. Stop the engine immediately.
2. Check the control system and all components for damage. Also, check the boat for damage.
3. Whether damage is found or not, return to the nearest harbor slowly and carefully.
4. Have a Yamaha dealer check the outboard motor before operating it again.

EMU40952

Replacing fuse

EWM00631

WARNING

Substituting an incorrect fuse or a piece of wire could allow excessive current flow. This could cause electric system damage and a fire hazard.

If a fuse has blown, replace the fuse according to the following procedure.

1. Turn the main switch to the "OFF" (off) position.
2. Remove the fuse box cover.
3. When replacing the main fuse, remove the screws, and then remove the main fuse. Install the spare main fuse, and then tighten the screws.

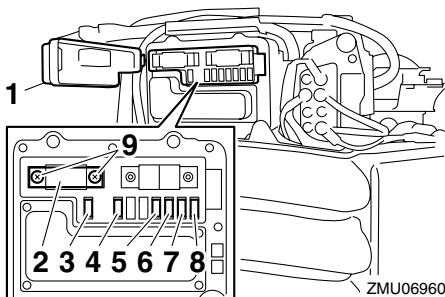

ZMU06960

1. Fuse box cover
2. Main fuse (60 A)
3. Fuel feed pump fuse (10 A)
4. Main switch / PTT switch fuse (20 A)
5. Starter relay fuse (30 A)
6. Ignition coil / Fuel injector / Variable camshaft timing / ECM (Electronic Control Module) fuse (30 A)
7. Electric throttle valve fuse (10 A)
8. Fuel pump fuse (15 A)
9. Screw

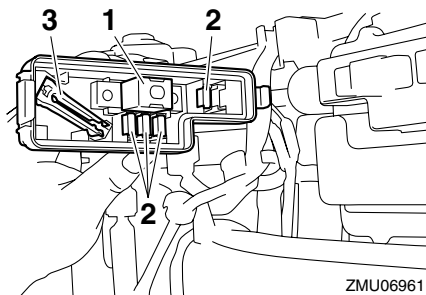

ZMU06961

1. Spare main fuse (60 A)
2. Spare fuse (10 A, 15 A, 20 A, 30 A)
3. Fuse puller

Trouble Recovery

- When replacing a fuse other than the main fuse, remove the fuse using the fuse puller. Install a spare fuse of the proper amperage.

Consult your Yamaha dealer if the new fuse immediately blows again.

EMU40981

Power trim and tilt unit will not operate

If the outboard motor cannot be tilted up or down using the power trim and tilt unit because of a discharged battery or a failure with the power trim and tilt unit, the outboard motor can be tilted manually.

- Stop the engine.
- Loosen the manual valve screw by turning it counterclockwise until it stops.

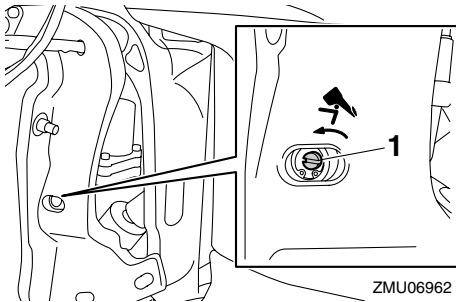

- Manual valve screw

- Tilt the outboard motor up manually to the desired position, and then tighten the manual valve screw by turning it clockwise.

EMU41013

Water separator-alert indicator blinks while cruising

EWM02542

WARNING

Gasoline is highly flammable, and its vapors are flammable and explosive.

- Do not perform this procedure on a hot or running engine. Allow the engine to cool.

- There will be fuel in the fuel filter. Keep away from sparks, cigarettes, flames or other sources of ignition.
- Some fuel will spill during this procedure. Catch the fuel in a rag. Wipe up any spilled fuel immediately.
- The fuel filter must be reassembled carefully with the O-ring and filter cup in place. Improper assembly or replacement could result in a fuel leak, which could result in a fire or explosion hazard.

If the water separator-alert indicator on the Command Link tachometer blinks, perform the following procedure.

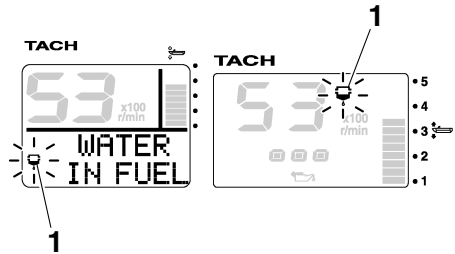

ZMU06963

- Water separator-alert indicator

- Stop the engine.
- Remove the top cowling.
- Remove the bolts, and then remove the fuel filter cover.

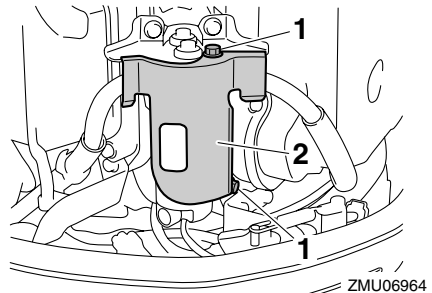

ZMU06964

- Bolt
- Fuel filter cover

Trouble Recovery

4. Disconnect the water detection switch coupler. **NOTICE: Be careful not to get any water on the water detection switch coupler, otherwise a malfunction could occur.** [ECM01950]

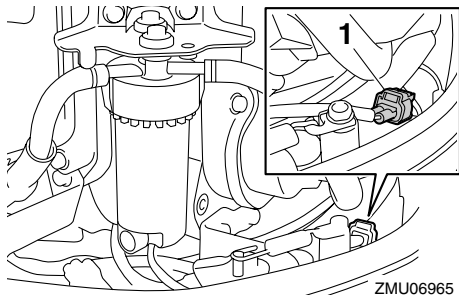

1. Water detection switch coupler

5. Remove the filter cup from the filter housing, and then remove the O-ring from the filter cup. **NOTICE: Be careful not to twist the water detection switch lead when unscrewing the filter cup.** [ECM01960]

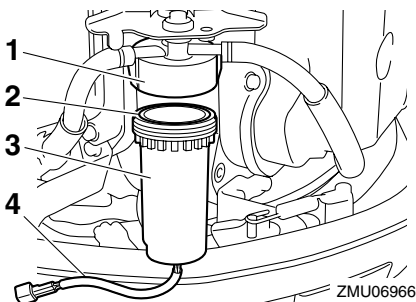

1. Filter housing
2. O-ring
3. Filter cup
4. Water detection switch lead

6. Drain the water in the filter cup by soaking it up with a rag.
7. Put the O-ring on the filter cup in its original position, and then install the filter cup onto the filter housing. **NOTICE: Be care-**

ful not to twist the water detection switch lead when screwing the filter cup onto the filter housing. [ECM01970]

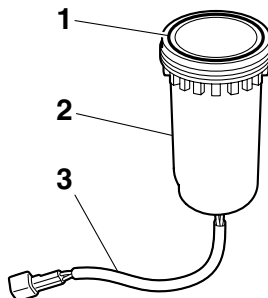

1. O-ring
 2. Filter cup
 3. Water detection switch lead
8. Connect the water detection switch coupler securely until a click is heard.
 9. Install the fuel filter cover, and then tighten the bolts.
 10. Install the top cowling.
 11. Turn the main switch to the "ON" (on) position and check that the water separator-alert indicator remains off and the buzzer does not sound. If the water separator-alert indicator blinks or the buzzer sounds, have your Yamaha dealer check the outboard motor. **NOTICE: Although the buzzer will stop when the engine is started and the remote control lever is moved to the forward or reverse position, do not use the outboard motor. Otherwise, serious engine damage could occur.** [ECM02390]

EMU41260

Treatment of submerged outboard motor

If the outboard motor is submerged, immediately take it to a Yamaha dealer. Otherwise some corrosion may begin almost immediate-

Trouble Recovery

ly. **NOTICE:** Do not attempt to run the out-board motor until it has been completely checked. [ECM02320]

EMU29830

YAMAHA MOTOR CORPORATION, U.S.A. FOUR-STROKE OUTBOARD MOTOR THREE-YEAR LIMITED WARRANTY

Yamaha Motor Corporation, U.S.A. hereby warrants that new Yamaha 1999-or-later model four-stroke outboard motors originally distributed by Yamaha Motor Corporation, U.S.A. will be free from defects in material and workmanship for the period of time stated herein, subject to certain stated limitations.

PERIOD OF WARRANTY. Any new Yamaha 1999-or-later model four-stroke outboard motor purchased and registered with Yamaha Motor Corporation, U.S.A. for pleasure use in the United States, will be warranted against defects in material or workmanship for a period of three (3) years from the date of purchase, subject to exclusions noted herein. Any Yamaha outboard motor purchased and utilized for commercial applications will be warranted for a period of one (1) year from the date of purchase, subject to exclusions noted herein. Yamaha peripheral equipment (control cables, propellers, gauges, remote control boxes, key switches, engine harnesses, throttle and shift cables, and wiring external from the motor unit) installed with the motor will be warranted for one (1) year from the date of purchase of either pleasure or commercial use. Replacement parts used in warranty repairs will be warranted for the balance of the applicable warranty period.

The second and third year of warranty (if applicable) shall be limited to covering the cost of parts and labor for major components only. The major components covered are:

Power Unit Section

- Power Head
- Intake Manifold
- Carburetor Assembly and its Related Components
- Fuel Injection System and its Related Components
- Fuel and Oil Pump Assemblies
- Ignition System (Standard and Microcomputer)

Lower Unit Section

- Exhaust System
- Upper Casing
- Lower Unit Assembly

Bracket Section

- Bracket System
- Power Trim and Tilt Assembly

WARRANTY REGISTRATION. To be eligible for warranty coverage, the outboard motor must be registered with Yamaha Motor Corporation, U.S.A. Warranty registration can be accomplished by any authorized Yamaha Outboard Motor Dealer. Upon receipt of the registration, an Owner's Warranty Card will be sent by Yamaha to the registered purchaser.

OBTAINING REPAIRS UNDER WARRANTY. To receive repairs under this warranty, a valid Owner's Warranty Card must be presented to an authorized Yamaha Outboard Motor Dealer.

During the period of warranty, any authorized Yamaha outboard dealer will, free of charge, repair or replace, at Yamaha's option, any parts adjudged defective by Yamaha due to faulty workmanship or material from the factory. All replaced parts will become the property of Yamaha Motor Corporation, U.S.A.

CUSTOMER'S RESPONSIBILITY. Under the terms of this warranty, the customer will be responsible for ensuring that the outboard motor is properly operated, maintained, and stored as specified in the applicable Owner's Manual.

The owner of the outboard motor shall give notice to an authorized Yamaha Outboard Motor Dealer of any and all apparent defects within ten (10) days of discovery and make the motor available at that time for inspection and repairs at the dealer's place of business.

GENERAL EXCLUSIONS FROM WARRANTY. This warranty will not cover the repair of damage if the damage is a result of abuse or neglect of the product. Examples of abuse and neglect include, but are not limited to:

1. Racing or competition use, modification of original parts, abnormal strain.
2. Lack of proper maintenance and off season storage as described in the Owner's Manual; installation of parts or accessories that are not equivalent in design and quality to genuine Yamaha parts.
3. Operation of the motor at an rpm other than specified, use of lubricants or oils that are not suitable for outboard motor use.
4. Damage as a result of accidents, collisions, contact with foreign materials, or submersion.
5. Growth of marine organism on motor surfaces.
6. Normal deterioration.

ZMU07048

Consumer information

SPECIFIC PARTS EXCLUDED FROM WARRANTY. Parts replaced due to normal wear or routine maintenance such as oil, spark plugs, shear pins, propellers, hubs, fuel and oil filters, brushes for the starter motor and power tilt motor, water pump impellers, and anodes, are not covered by warranty.

Charges for removal of the motor from a boat and transporting the motor to and from an authorized Yamaha Outboard Motor Dealer are excluded from warranty coverage.

Specific parts excluded from the second and third year of warranty (if applicable) are:

- Top and Bottom Cowling
- Electric Components (other than ignition system)
- Rubber Components (such as hoses, tubes, rubber seals, fittings, and clamps)

EMISSION CONTROL WARRANTY. Yamaha warrants to the ultimate purchaser and any subsequent owner, that the emission control components on this engine are designed, built and equipped so as to conform at the time of sale with applicable regulations under section 213 of the Clean Air Act and that this engine, if manufactured from January 2004 through December 2009, is free from defects in materials and workmanship which cause said engine to fail to conform with applicable regulations for two (2) years from the date of purchase or 200 hours of operation, whichever comes first, except for certain major emission components, if equipped, which are covered for three (3) years from the date of purchase or 200 hours, whichever comes first. For engines manufactured January 2010 or after, the coverage for exhaust emissions is five (5) years from the date of purchase or 175 hours of operation, whichever comes first, and hoses under the cowl are covered for evaporative emissions for two (2) years from the date of purchase. Some states have different emission control warranty provisions. As these vary from state to state, consult your Yamaha dealer or contact Yamaha Customer Relations at 1-866-894-1626 for more information.

TRANSFER OF WARRANTY. Transfer of the warranty from the original purchaser to any subsequent purchaser is possible by having the motor inspected by an authorized Yamaha Outboard Motor Dealer and requesting the dealer to submit a change of registration to Yamaha Motor Corporation, U.S.A. within ten (10) days of the transfer.

YAMAHA MOTOR CORPORATION, U.S.A. MAKES NO OTHER WARRANTY OF ANY KIND, EXPRESSED OR IMPLIED. ALL IMPLIED WARRANTIES OF MERCHANTABILITY AND FITNESS FOR A PARTICULAR PURPOSE WHICH EXCEED THE OBLIGATIONS AND TIME LIMITS STATED IN THIS WARRANTY ARE HEREBY DISCLAIMED BY YAMAHA MOTOR CORPORATION, U.S.A. AND EXCLUDED FROM THIS WARRANTY.

SOME STATES DO NOT ALLOW LIMITATIONS ON HOW LONG AN IMPLIED WARRANTY LASTS, SO THE ABOVE LIMITATIONS MAY NOT APPLY TO YOU. ALSO EXCLUDED FROM THIS WARRANTY ARE ANY INCIDENTAL OR CONSEQUENTIAL DAMAGES INCLUDING LOSS OF USE. SOME STATES DO NOT ALLOW THE EXCLUSION OR LIMITATION OF INCIDENTAL OR CONSEQUENTIAL DAMAGES, SO THE ABOVE EXCLUSION MAY NOT APPLY TO YOU.

THIS WARRANTY GIVES YOU SPECIFIC LEGAL RIGHTS, AND YOU MAY ALSO HAVE OTHER RIGHTS WHICH VARY FROM STATE TO STATE.

**YAMAHA MOTOR CORPORATION, U.S.A.
1270 Chastain Road
Kennesaw, GA 30144**

ZMU07047

EMU29841

IMPORTANT WARRANTY INFORMATION IF YOU USE YOUR YAMAHA OUTSIDE THE USA OR CANADA

Welcome to the Yamaha Family!

Congratulations on the purchase of your new Yamaha Products. Yamaha is committed to exceptional customer satisfaction, and we want your ownership experience to be a satisfying one. Please read the following warranty information to help ensure satisfaction with your Yamaha.

This model was manufactured as a USA specification model, and the warranty statement shown in this manual is for the United States market.

Please note the following information:

1. As explained in the Limited Warranty Statement, the Yamaha warranty covers your Yamaha when it is registered and used in the United States or Canada.
2. If you need repairs while temporarily using your Yamaha in another country, contact the local authorized Yamaha distributor for that country. Yamaha will work with that distributor to make the needed repairs as quickly as possible. If you have to pay for a repair that you believe your warranty would have covered at home, present all repair orders, receipts, or other related documents to your local dealer when you return home. He will be able to contact Yamaha on your behalf to see if any refund can be provided.

TIP:

Your Yamaha model may not be sold in some countries. Therefore, a Yamaha dealer outside the United States or Canada may not have all of the replacement parts or technical information available to provide proper service. This may unavoidably delay repairs. Thank you for your understanding should this happen.

3. If your Yamaha is registered or used primarily outside the United States or Canada, the warranty printed in this manual does not apply to you. Contact the dealer who sold the Yamaha marine power unit to you for customer support information.

ZMU05199



Printed in Japan
December 2009-1.1 × 1 CR

Printed on recycled paper

Free Manuals Download Website

<http://myh66.com>

<http://usermanuals.us>

<http://www.somanuals.com>

<http://www.4manuals.cc>

<http://www.manual-lib.com>

<http://www.404manual.com>

<http://www.luxmanual.com>

<http://aubethermostatmanual.com>

Golf course search by state

<http://golfingnear.com>

Email search by domain

<http://emailbydomain.com>

Auto manuals search

<http://auto.somanuals.com>

TV manuals search

<http://tv.somanuals.com>