

MUSIC SYNTHESIZER

WS/W7

Owner's Manual

SPECIAL MESSAGE SECTION

PRODUCT SAFETY MARKINGS: Yamaha electronic products may have either labels similar to the graphics shown below or molded / stamped facsimiles of these graphics on the enclosure. The explanation of these graphics appears on this page.

Please observe all cautions indicated on this page and those indicated in the safety instruction section.

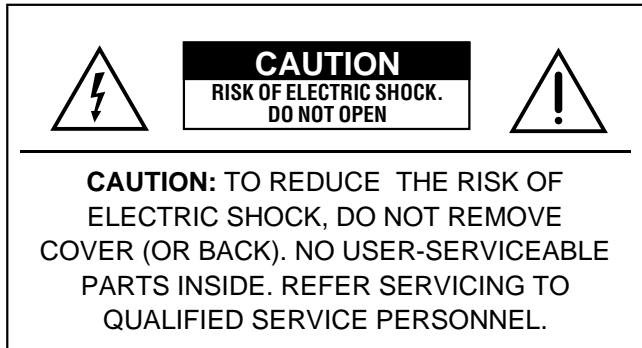

See the name plate for graphic symbol markings.



The exclamation point within the equilateral triangle is intended to alert the user to the present of important operating and maintenance (servicing) instructions in the literature accompanying the product.

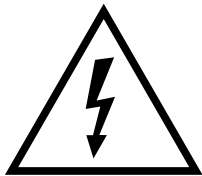

The lightning flash with arrowhead symbol within the equilateral triangle is intended to alert the user to the presence of uninsulated "dangerous voltage" within the product's enclosure that may be of sufficient magnitude to constitute a risk of electrical shock.

IMPORTANT NOTICE: All Yamaha electronic products are tested and approved by an independent safety testing laboratory in order that you may be sure that when it is properly installed and used in its normal and customary manner, all foreseeable risks have been eliminated. DO NOT modify this unit or commission others to do so unless specifically authorized by Yamaha.

Product performance and/or safety standards may be diminished. Claims filed under the expressed warranty may be denied if the unit is/has been modified. Implied warranties may also be affected.

SPECIFICATIONS SUBJECT TO CHANGE: The information contained in this manual is believed to be correct at the time of printing. However, Yamaha reserves the right to change or modify any of the specifications without notice or obligation to update existing units.

ENVIRONMENTAL ISSUES: Yamaha strives to produce products that are both user safe and environmentally friendly.

We sincerely believe that our products and the production methods used to produce them, meet these goals. In keeping with both the letter and the spirit of the law, we want you to be aware of the following:

BATTERY NOTICE: This product MAY contain a small nonrechargeable battery which (if applicable) is soldered in place. The average life span of this type of battery is approximately five years. When replacement becomes necessary, contact a qualified service representative to perform the replacement.

WARNING: Do not attempt to recharge, disassemble, or incinerate this type of battery. Keep all batteries away from children. Dispose of used batteries promptly and as regulated by applicable laws. Note: In some areas, the servicer is required by law to return the defective parts. However, you do have the option of having the servicer dispose of these parts for you.

DISPOSAL NOTICE: Should this product become damaged beyond repair, or for some reason its useful life is considered to be at an end, please observe all local, state, and federal regulations that relate to the disposal of products that contain lead, batteries, plastics, etc.

NOTICE: Service charges incurred due to lack of knowledge relating to how a function or effect works (when the unit is operating as designed) are not covered by the manufacturer's warranty, and are therefore the owner's responsibility.

Please study this manual carefully and consult your dealer before requesting service.

NAME PLATE LOCATION: The graphic below indicates the location of the name plate. The model number, serial number, power requirements, etc., are located on this plate. You should record the model number, serial number, and the date of purchase in the spaces provided below and retain this manual as a permanent record of your purchase.

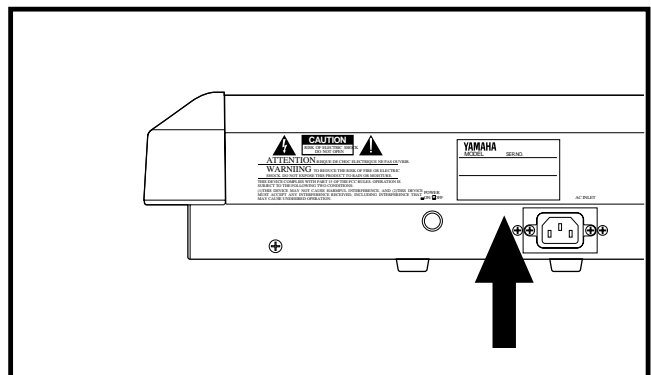

Model _____

Serial No. _____

Purchase Date _____

IMPORTANT SAFETY INSTRUCTIONS

INFORMATION RELATING TO PERSONAL INJURY, ELECTRICAL SHOCK, AND FIRE HAZARD POSSIBILITIES HAS BEEN INCLUDED IN THIS LIST.

WARNING- When using any electrical or electronic product, basic precautions should always be followed. These precautions include, but are not limited to, the following:

- 1.** Read all Safety Instructions, Installation Instructions, Special Message Section items, and any Assembly Instructions found in this manual BEFORE making any connections, including connection to the main supply.
- 2.** Do not attempt to service this product beyond that described in the user-maintenance instructions. All other servicing should be referred to qualified service personnel.
- 3.** Main Power Supply Verification: Yamaha products are manufactured specifically for the supply voltage in the area where they are to be sold. If you should move, or if any doubt exists about the supply voltage in your area, please contact your dealer for supply voltage verification and (if applicable) instructions. The required supply voltage is printed on the name plate. For name plate location, please refer to the graphic found in the Special Message Section of this manual.
- 4. DANGER-** Grounding Instructions: This product must be grounded and therefore has been equipped with a three pin attachment plug. If this product should malfunction, the ground pin provides a path of low resistance for electrical current, reducing the risk of electrical shock. If your wall socket will not accommodate this type plug, contact an electrician to have the outlet replaced in accordance with local electrical codes. Do NOT modify the plug or change the plug to a different type!
- 5. WARNING:** Do not place this product or any other objects on the power cord or place it in a position where anyone could walk on, trip over, or roll anything over power or connecting cords of any kind. The use of an extension cord is not recommended! If you must use an extension cord, the minimum wire size for a 25' cord (or less) is 18 AWG. NOTE: The smaller the AWG number, the larger the current handling capacity. For longer extension cords, consult a local electrician.
- 6.** Ventilation: Electronic products, unless specifically designed for enclosed installations, should be placed in locations that do not interfere with proper ventilation. If instructions for enclosed installation are not provided, it must be assumed that unobstructed ventilation is required.
- 7.** Temperature considerations: Electronic products should be installed in locations that do not seriously contribute to their operating temperature. Placement of this product close to heat sources such as; radiators, heat registers etc., should be avoided.

8. This product was NOT designed for use in wet/damp locations and should not be used near water or exposed to rain. Examples of wet /damp locations are; near a swimming pool, spa, tub, sink, or wet basement.

9. This product should be used only with the components supplied or; a cart ,rack, or stand that is recommended by the manufacturer . If a cart, rack, or stand is used, please observe all safety markings and instructions that accompany the accessory product.

10. The power supply cord (plug) should be disconnected from the outlet when electronic products are to be left unused for extended periods of time. Cords should also be disconnected when there is a high probability of lightning and/or electrical storm activity.

11. Care should be taken that objects do not fall on and liquids are not spilled into the enclosure through any openings that may exist.

12. Electrical/electronic products should be serviced by a qualified service person when:

- a. The power supply cord has been damaged; or
- b. Objects have fallen, been inserted, or liquids have been spilled into the enclosure through openings; or
- c. The product has been exposed to rain; or
- d. The product does not operate, exhibits a marked change in performance; or
- e. The product has been dropped, or the enclosure of the product has been damaged.

13. This product, either alone or in combination with an amplifier and headphones or speaker/s, may be capable of producing sound levels that could cause permanent hearing loss. Do NOT operate for a long period of time at a high volume level or at a level that is uncomfortable. If you experience any hearing loss or ringing in the ears, you should consult an audiologist.

IMPORTANT: The louder the sound, the shorter the time period before damage occurs.

14. Some Yamaha products may have benches and / or accessory mounting fixtures that are either supplied as a part of the product or as optional accessories. Some of these items are designed to be dealer assembled or installed. Please make sure that benches are stable and any optional fixtures (where applicable) are well secured BEFORE using. Benches supplied by Yamaha are designed for seating only. No other uses are recommended.

PLEASE KEEP THIS MANUAL

CONTENTS

BEFORE YOU BEGIN 7

FRONT PANEL	10
REAR PANEL	15
SYSTEM LOGIC	17

GETTING STARTED 43

SETUP & PLAY	44
LOADING & PLAYING THE DEMO	52
PROGRAMMING	56
SAVING & LOADING	64
INTEGRATING INTO A MIDI SYSTEM	67

■ FEATURE REFERENCE..... 71

SONG MODE 72

SONG PLAY	73
SONG MULTI	74
SYSTEM EFFECTS	79
SONG SEQUENCE PLAY	80
SONG SETUP	82
SONG RECORD	85
REALTIME RECORDING	87
STEP RECORDING	89
SONG EDIT	91
SEQUENCE TRACK GRAPH	91
SEQUENCE/TEMPO TRACK DATA CHANGE	92
SEQUENCE/TEMPO TRACK DATA INSERT	93
SONG JOB	95
SONG JOB 1	96
SONG JOB 2	98
SONG JOB 3	100

A WM TONE GENERATION 104

VOICE MODE 106

VOICE PLAY	107
VOICE EDIT	108
NORMAL VOICE EDIT MODE	109
DRUM VOICE EDIT MODE	124

STORE MODE..... 129

- STORE MULTI 129
- STORE VOICE 130

DISK MODE 131

- DISK STATUS 133
- SAVE TO DISK 134
- LOAD FROM DISK 136
- RENAME FILE 139
- DELETE FILE 140
- FORMAT DISK 141

UTILITY MODE 142

- SONG VOICE MEMORY 143
- INITIALIZE 144
- VOICE BULK DUMP 144
- SYNTHESIZER SETUP 145
- CONTROLLERS 147
- MIDI SETUP 148
- OTHER SETUP 149
- GREETING MESSAGE 149

■ APPENDIX 151

- ERROR MESSAGES 152
- TROUBLESHOOTING 153
- MOUNTING THE EXPANSION BOARD 155
- SPECIFICATIONS 156

INDEX 158

BEFORE YOU BEGIN

GETTING STARTED

SONG MODE

AWM TONE GENERATION

VOICE MODE

STORE MODE

DISK MODE

UTILITY MODE

APPENDIX

THANK YOU FOR PURCHASING THE YAMAHA W5/W7 MUSIC SYNTHESIZER

The Yamaha W5 (76-key) / W7 (61-key) Music Synthesizer is a full-featured, professional level music production and performance keyboard complete with 32-note synthesizer and sequencer, extensive voice and song editing capabilities, digital effects, GM compatibility and much more.

Featuring Yamaha's unique AWM2 (second generation Advanced Wave Memory) tone generation system, where sounds are generated from high quality digital recordings of actual instruments, the W5/W7 is a *multitimbral* keyboard that can function as several synthesizers at once and play up to 16 different instrument sounds simultaneously via the internal song sequencer or an external MIDI source.

The W5/W7 is specifically designed with the music composer and performer in mind to give serious musicians all the tools they need to make great sounding music, in one compact, easy-to-use, yet powerful, package.

To take full advantage of the W5/W7's many in-depth features and music production capabilities, and to enjoy many years of long and trouble-free use, please read this manual carefully.

HOW TO USE THIS MANUAL

This manual is divided into three distinct sections, as follows:

● INTRODUCTORY SECTION: BEFORE YOU BEGIN

A big picture overview of the W5/W7, complete with explanation of the instrument's main features and capabilities, front and rear panel diagrams with detailed descriptions of controls and other features, plus an explanation of system logic and other technical considerations everything you need to know before you begin using the W5/W7 in order to put its numerous features and capabilities into proper context.

● TUTORIAL SECTION: GETTING STARTED

A simple yet comprehensive guided tour of the basic operation of all main features of the W5/W7, including setting up and connecting to a monitor system, exploring the preprogrammed voices and realtime control features,

basic voice editing, song creation and sound mixing, saving and loading data, plus integrating the W5/W7 into a larger MIDI system everything you need to get started right away familiarizing yourself with the W5/W7 through hands on experience.

● REFERENCE SECTION: FEATURE REFERENCE

A virtual encyclopedia of all features of the W5/W7, including detailed information about voice, song, utility, disk and storage modes, as well as an extensive feature index everything you need for quick and easy access to any subject you want to locate.

IMPORTANT NOTE: *Keep this manual in a safe place for future reference.*

PRECAUTIONS

IMPORTANT! PLEASE READ BEFORE PROCEEDING.

The W5/W7 is a powerful electronic musical instrument featuring sensitive high technology. To ensure many years of trouble-free use, please take the important precautions below seriously.

LOCATION

- In order to avoid causing serious damage to the W5/W7, do not expose the instrument to direct sunlight, high temperatures, excessive humidity, excessive dust or strong vibration.
- Place the W5/W7 on a solid surface such as a keyboard stand or a sturdy table or desk.

POWER SUPPLY

- Turn the power switch off when the instrument is not in use.
- The power supply cord should be unplugged from the AC outlet if the instrument is not to be used for an extended period of time. (NOTE: When AC power is reconnected, song sequencer data, including Song voice data, will have been erased.)
- Unplug the instrument during electrical storms.
- Avoid plugging the instrument into the same AC outlet as appliances with high power consumption such as electric heaters or ovens. Also avoid using multiple-plug adapters since these can result in reduced sound quality and possibly even damage to the W5/W7.

UNPLUG ALL INSTRUMENTS WHEN MAKING CONNECTIONS

- To avoid causing damage to the instrument and other devices to which it is connected (such as a sound system or MIDI instruments), turn off power and unplug all related devices prior to connecting or disconnecting audio and MIDI cables. When connecting AC power be sure the W5/W7 is properly grounded.

ELECTRICAL INTERFERENCE

- Avoid using the W5/W7 near televisions, radios or other devices which generate electromagnetic fields, since this may cause the W5/W7 to malfunction, and possibly generate interference noise in the other devices.

BACK-UP BATTERY

- The W5/W7 contains a special long-life battery that retains the contents of its internal voice and multi memory when the power is turned off. The back-up battery should last for several years. When it needs to be replaced, the message Change internal battery! will appear on the display when the power is turned on. When this happens, have the

backup battery replaced by qualified Yamaha service personnel. Do not attempt to replace the backup battery yourself.

HANDLING AND TRANSPORT

- Handle with care. Physical shocks caused by dropping, bumping the instrument, or placing heavy objects upon it, can result in serious damage to the W5/W7.
- Never apply excessive force to the controls, connectors or other parts of the instrument.
- Disconnect all cables before moving the instrument. Always unplug cables by gripping the plug firmly, and not by pulling on the cable itself.

CLEANING

- Never use chemical solvents or thinners to clean the W5/W7, since these will damage the finish or dull the keys. Wipe the instrument clean with a soft, dry cloth. If necessary, use a soft, clean cloth slightly moistened with a diluted, mild detergent. Then wipe the instrument thoroughly with a dry cloth.
- Avoid placing vinyl objects on top of the instrument, since vinyl can stick to and discolor the surface.

DATA BACKUP AND STORAGE

- Be sure to save all song sequence and Song voice data to floppy disk before turning off the power. At power off, these types of data are not retained in the W5/W7's internal memory.
- Since it is possible for data in internal memory to be lost as a result of improper operation, handling, or other reasons, always keep floppy disk backups of important voice, song sequence and multi data, and store them in a cool, dry place. Since it is also possible for the data in a floppy disk to be lost as a result of static electricity, magnetic fields, or other causes, it is always a good idea to make at least two backup copies of the floppy disks and store them in different locations, just to be safe.
- To prevent accidental erasure of important data you have saved to floppy disk, be sure to slide the disk's write-protect tab to the write protect position (the tab window should be open). When this is done the data on the disk cannot be accidentally overwritten.

- Make regular backup copies of important data to a separate floppy disk, and keep your backup disks in a separate, safe place.
- To ensure the safety of your data (and of the disk drive itself) always use floppy disks from a well-known, reliable manufacturer. No-name brand disks may cause trouble.

IMPORTANT NOTE: Yamaha recommends that you regularly save your data onto floppy disks and store the disks in a safe place! Yamaha cannot be held responsible for the accidental loss of important music data.

HANDLE FLOPPY DISKS AND TREAT THE DISK DRIVE WITH CARE

- Use only 3.5 2DD type floppy disks.
- The actual recording medium inside a floppy disk has a fine coating of magnetic particles in which the data is stored. To protect this coating as well as the disk drive's delicate read-write head, always keep floppy disks in their protective cases when they are not in use.
- Do not place heavy objects on a disk or bend or apply pressure to the disk in any way. Do not open the sliding shutter and touch the exposed surface of the floppy disk inside. Do not expose the disk to direct sunlight, extremely high or low temperatures, or excessive humidity, dust or liquids. Do not expose the disk to magnetic fields, such as those produced by televisions, speakers, motors, etc., since magnetic fields can partially or completely erase data on the disk, rendering it unreadable.
- Never use a floppy disk with a deformed shutter or housing.
- Do not attach anything other than the provided labels to a floppy disk. Also make sure that labels are attached in the proper location.
- To insert a floppy disk into the W5/W7's disk drive, hold the disk so that the label of the disk is facing upward and the sliding shutter is facing forward, towards the disk insertion slot. Carefully insert the disk shutter first into the slot, slowly pushing it all the way in until it clicks into place and the eject button pops out.
- When writing and reading data to and from disk, the red LED on the floppy disk drive will light up. Never attempt to remove the disk or turn the power off while this LED is lit. Doing so could damage the disk and possibly the disk drive.
- To eject a floppy disk, press the eject button slowly as far as it will go; the disk will automatically pop out. When the disk is fully ejected, carefully remove it by hand. If the eject button is pressed too quickly, or if it is not pressed in as far as it will go, the disk may not eject properly. The eject button may become stuck in a half-pressed position with the disk extending from the drive slot by only a few

millimeters. If this happens, do not attempt to pull out the partially ejected disk, since using force in this situation can damage the disk drive mechanism or the floppy disk. To remove a partially ejected disk, try pressing the eject button once again, or push the disk back into the slot and then repeat the eject procedure.

- Never insert anything but floppy disks into the disk drive. Other objects may cause damage to the disk drive or floppy disks.
- Be sure to remove the floppy disk from the disk drive before turning off the power. A floppy disk left in the drive for extended periods can easily pick up dust and dirt that can cause data read and write errors.

CLEANING THE DISK DRIVE READ/WRITE HEAD

- Clean the read/write head regularly. This instrument employs a precision magnetic read/write head which, after an extended period of use, will pick up a layer of magnetic particles from the disks used that will eventually cause read and write errors. To maintain the disk drive in optimum working order Yamaha recommends that you use a commercially-available dry-type head cleaning disk to clean the head about once a month. Ask your Yamaha dealer about the availability of proper head-cleaning disks.

SERVICE AND MODIFICATION

- The W5/W7 contains no user serviceable parts, so never open the case or tamper with the internal circuitry in any way. Doing so may result in electrical shock or damage to the instrument. Refer all servicing to qualified Yamaha service personnel.

THIRD PARTY SOFTWARE

- Yamaha cannot take responsibility for software produced for this product by third-party manufacturers. Please direct any questions or comments about such software to the manufacturer or their official agents.

IMPORTANT NOTE: Yamaha cannot be held responsible for damage to the W5/W7 resulting from improper handling or operation.

BEFORE YOU BEGIN

Congratulations! You are now the proud owner of the Yamaha W5/W7 Music Synthesizer. The W5/W7 is a self contained, full-featured, easy-to-operate multitimbral music production and performance *workstation*, complete with 32-note polyphonic synthesizer, 16-track sequencer, full voice and song editing capabilities, studio quality digital effects, powerful stereo sound mixing features, large memory capacity, on-board floppy disk drive, GM compatibility, friendly user-interface and more. Main features include:

- **AWM2 TONE GENERATION**

Second generation Advanced Wave Memory tone generation system, where instrument sounds are generated from high-quality digital samples of actual instruments and other sounds.

- **LARGE-CAPACITY WAVEFORM ROM**

8Mbytes of 16-bit linear waveforms sampled at maximum 48kHz sampling frequency, plus expandability.

- **EASY CONTROL AND FRIENDLY USER INTERFACE**

Multiple assignable controllers, large LCD screen, multi-purpose function keys, data entry pad, jog/shuttle and other data input features, plus individual sequencer track buttons and more give you instant access to any mode or parameter. Accessing functions rarely takes more than two or three presses of a button.

- **SONG MULTI**

The basic Song Play operation mode of the W5/W7, a multi lets you design a complete music production from start to finish and store it as a song in any of the 16 internal song memories. A multi is the configuration of all performance and voice settings and other data which combine to create a stereo song mix. Within a multi, you can assign up to 16 on-board *Instrument* voices to the 16-track sequencer, plus determine all effects and mixer settings as well as MIDI control status and many other parameters.

- **16-TRACK, 16-SONG MUSIC SEQUENCER**

Large capacity memory (approximately 100,000 notes) song sequencer with real-time, step and punch-in recording, and extensive song editing jobs. The 16 sequences in song memory can be specified to play back one after another.

• **GENERAL MIDI**

Global standard configuration of 128 instrument voices and specified MIDI channel assignments and other parameters. General MIDI lets you load and play music data created by another sequencer and saved to disk in the Standard MIDI File format.

ABOUT THE GM SYSTEM LEVEL 1



The General MIDI (GM) world standard protocol was developed by a consortium of musical instrument hardware and software makers in order to minimize confusion and the need for reprogramming when playing music software created by one device on another device. The W5/W7 supports the GM System Level 1 , which is the current minimum MIDI configuration standard recognized by the International MIDI Association.

GM permits performance and other data to be transferred between different instruments, even instruments made by different manufacturers. For example, sequence data originally created to control a specific tone generator can be used to control a different tone generator from another manufacturer without reconfiguring MIDI channel and other assignments. Program change and other data transmitted from the sequencer will select the correct voices and settings on the destination tone generator.

GM defines a standard voice allocation chart in which the same or similar voices are accessed by the same program change numbers (001 ~ 128) and MIDI channels (1 ~ 16), and the same type of drum sounds are assigned to specific keys, and controllers such as pitch bend range, octave registration, expression, modulation, etc., are designated with specific controller numbers. (For more information about GM sounds and mapping, see the *W5/W7 Technical Information* booklet, supplied separately.)

• **384 INSTRUMENT VOICES AND 10 DRUM KITS**

384 preset normal voices plus 10 drum voices (or kits), including the 128 General MIDI voices and 8 kits, constructed from the hundreds of preset AWM elements and the many on-board synthesizer parameters.

• **VOICE EDITING**

Extensive synthesizer voice editing features give you unlimited sound creation potential. A voice, which can be constructed from between 1 and 4 AWM elements, has hundreds of editable parameters.

• **LARGE INTERNAL VOICE AND SONG VOICE RAM**

128 Internal or user normal voice memories and 2 Internal drum voice memories, for storing your own instrument sounds and drum kits. There are also 16 banks of 128 Song voice memories and 16 banks of 2 Song drum voice memories one Song voice bank per each song memory which are handy for organizing voices and drums for specific songs or live performance setups and storing them together with song multi data on floppy disks for quick and easy access.

• 75 DIGITAL EFFECTS

Two independent, studio quality DSP effects systems Insertion Effects and System Effects each with three different types of effects generators. An Insertion Effect can be assigned to each voice in Voice Edit Mode, and switched on and off via the mixer. As many as three Insertion Effects can be used in a multi. The three System Effects can be applied to the overall sound mix. Preset stereo effects include reverb, delay, chorus, auto panning, 3-band EQ, Aural Exciter[®], pitch change, distortion and many more. There are a total of 35 preprogrammed Insertion Effects and 40 System Effects, which can be edited and configured in a variety of ways in the multi for a song or performance setup.

**Aural Exciter[®] is a registered trademark of and is manufactured under license from Aphex Systems Ltd.*

• STEREO SOUND MIXING

Extensive stereo sound mixing capabilities, via the on-board tone generator sound mixer, the digital effects and others. In conjunction with the sequencer you can even achieve an automated mixdown for your final playback output.

• PERFORMANCE FEATURES

76-key (W5) or 61-key (W7) polyphonic keyboard with key velocity sensitivity and aftertouch, plus keyboard splitting, layering and 4-Zone capabilities. The W5/W7 can play a maximum of 32 notes simultaneously. In Song Multi Mode, it can play a maximum of 16 timbres, or voices, simultaneously; in Voice Mode, it can play one timbre at a time. There are also many performance controllers, including pitch bend and modulation wheels, foot controller, and a multi-function continuous slider.

• FLOPPY DISK DRIVE

For storing your song and voice data on 3.5 2DD type floppy disks.

• EXPANSION POTENTIAL

The factory preprogrammed sound memory can be expanded with an optional Yamaha 4Mbyte Expansion Wave/Voice Board.

FRONT PANEL

DIAGRAM & FEATURES

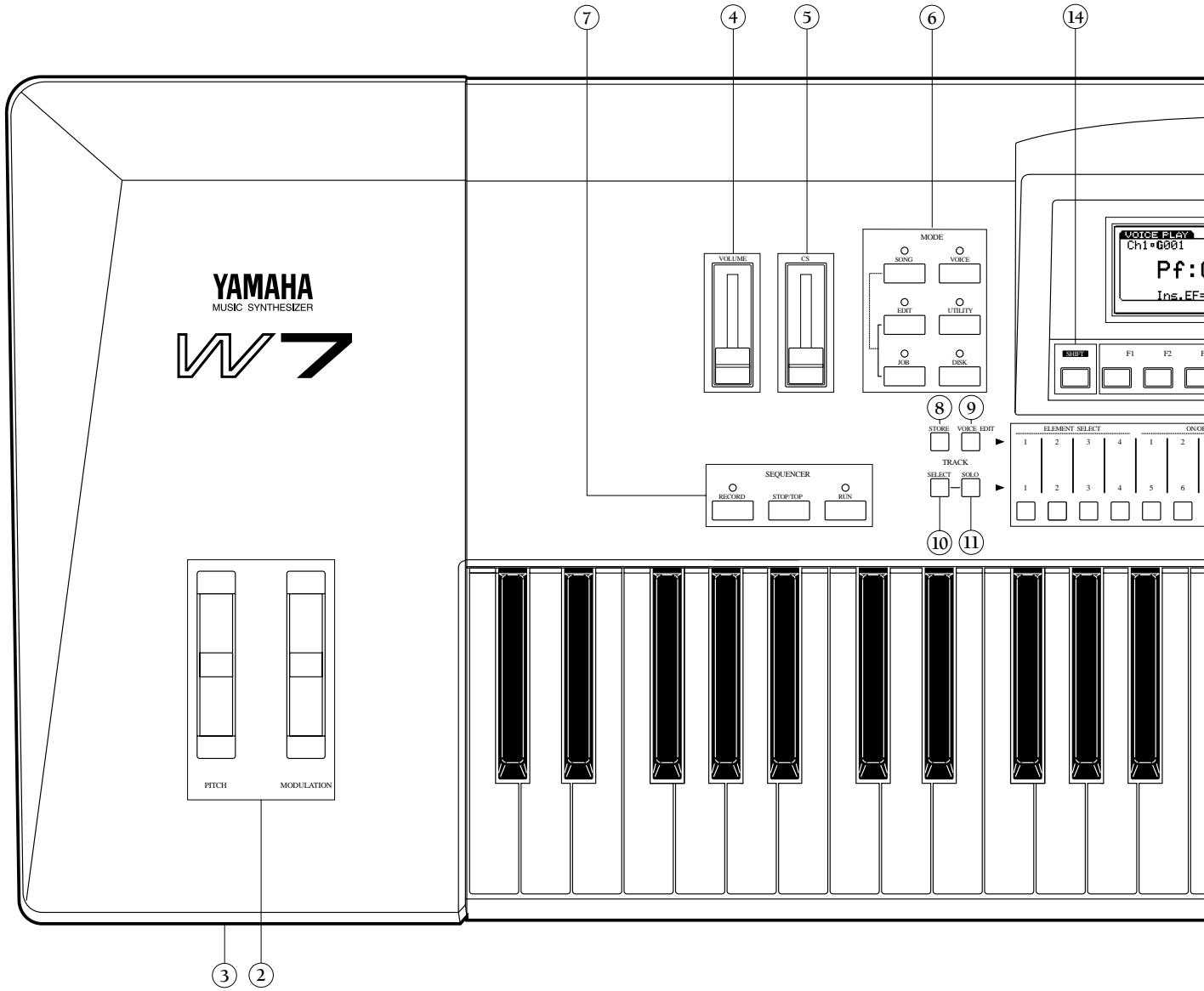

NOTE: The above diagram is the 61-key W7 Music Synthesizer. The 76-key W5 has precisely the same on-board controls and internal operating system, only the number of keys on the keyboard is different.

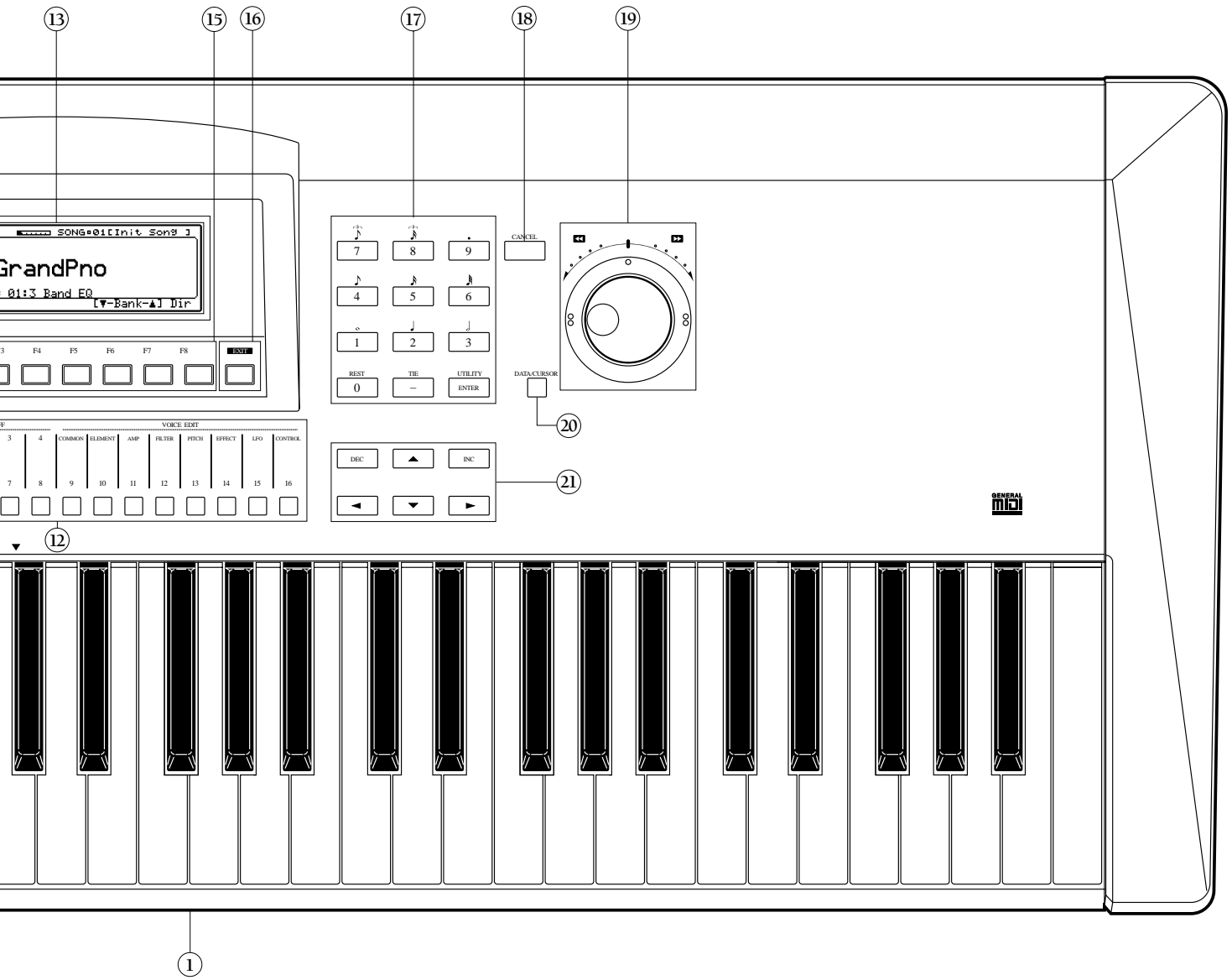

1 **KEYBOARD**

76-key (W5) or 61-key (W-7) keyboard with key-on velocity sensitivity and channel aftertouch sensitivity gives you full control over expression and nuance as you play.

2 **PITCH AND MODULATION WHEELS**

The pitch wheel lets you bend the pitch up or down as you play. It is spring-loaded to return to center position when you let go of it. The modulation wheel lets you apply or set a designated amount of vibrato or tremolo. You can also assign it to affect EG bias, filter cutoff, amplitude modulation, pitch modulation, frequency modulation and various other controllable parameters.

3 **FLOPPY DISK DRIVE**

The 3.5 2DD floppy disk drive can store large amounts of voice, multi and song sequence data. The red disk drive indicator LED will light when the disk is being written or read. (NOTE: Never attempt to remove the disk while this LED is lit. Doing so could damage the disk and the disk drive. Always insert the disk with the label facing up, from the end with the shutter facing forward. To remove the disk, press the eject button at the lower right of the drive.)

4 **VOLUME SLIDER**

Regulates the output volume from the stereo output jacks on the rear panel.

5 **CONTINUOUS SLIDER (CS)**

This is a multiple function controller that can control the parameter you assign to it, including pan, foot control functions, expression, data entry and others.

6 **MODE SECTION**

For choosing the six main operation modes of the W5/W7 Song, Edit, Job, Voice, Utility and Disk.

7 **SEQUENCER SECTION**

For starting and stopping the recording and playback functions of the internal sequencer, and returning the song to the top, or first measure. Pressing RECORD engages the Song Record Mode; pressing STOP/TOP once stops a song which is playing back, while pressing STOP/TOP twice returns the song to the top, or measure one; pressing RUN starts the song playback from the currently designated measure.

8 **STORE BUTTON**

For entering Store Mode in order to store multis into the song memory bank and voices into the Internal voice bank. In Store Mode the STORE button will light green.

9 VOICE EDIT BUTTON

For switching directly into Voice Edit Mode, regardless of whatever mode you're in at the time, to access the voice editing functions and parameters. During the editing operation, pressing VOICE EDIT lets you compare the sound of the voice you're editing to the sound of the original voice you started from. In Voice Edit Mode the VOICE EDIT button lights in orange (as do various TRACK buttons, which in Voice Edit Mode double as voice editing function and element selectors).

10 TRACK SELECT BUTTON

In the normal operating modes the TRACK SELECT button will be lit with a green light, indicating that you can select tracks 1 ~ 16 of the song multi. In Voice Edit and Solo Modes, the light on the TRACK SELECT button will go out, indicating that you cannot select tracks.

11 TRACK SOLO BUTTON

When a song sequence is playing back, pressing the SOLO button will allow you to solo and mute the various tracks with music data in them. Soloed tracks will light in red and muted tracks will light in green.

12 TRACK BUTTONS 1 ~ 16

In Song Play, Voice Play and Song Record Modes, the TRACK buttons let you select any track in the multi the selected track button will be indicated with a red light. In Song Sequence Play Mode, the TRACK buttons corresponding with tracks which have music data in them will be indicated with a green light. In Voice Edit Mode, various TRACK buttons double as edit function select, element select and element on/off switches as indicated on the panel directly above each button. In Voice Edit Mode, the selected buttons will be indicated with orange lights.

13 LCD SCREEN

The 240 x 64 dot Liquid Crystal Display with adjustable contrast provides graphic, numeric and much other visual information.

14 SHIFT KEY

SHIFT is used in conjunction with the function keys to access secondary functions and parameters, as well as to jump directly to main menus and other functions.

15 FUNCTION KEYS 1 ~ 8

The functions of these keys [F1 ~ F8] depend on the selected mode. They are used to engage a function indicated on the display immediately above the key.

16 EXIT KEY

EXIT is for exiting from any function or submode. In many cases pressing EXIT more than once will let you retrace your previous few steps.

17 DATA ENTRY KEYPAD

For precise, specific entry of data, by punching in a number, then pressing ENTER. The [—] button lets you enter a negative value. In Song Record Mode you can enter music notation values according to the corresponding musical symbols and indications printed above the buttons. ENTER is used to execute many different operations.

18 CANCEL BUTTON

If you change a parameter and then decide you want to retrieve the previous data value, pressing CANCEL before proceeding to another function will cancel out the data entry, reverting to the previous value status.

19 JOG/SHUTTLE DIAL

Two-function concentric (inner and outer) dial. The JOG (inner dial) lets you enter data or scroll through functions. The SHUTTLE (outer dial) lets you fast forward or rewind through measures in a song sequence.

20 DATA/CURSOR BUTTON

Determines the function of the JOG dial. When switched off (no light), the JOG will be used primarily for entering data. When switched on (red light indicator), spinning the JOG will move the cursor.

21 CURSOR CONTROL & INC/DEC BUTTONS

The arrow CURSOR-UP, -DOWN, -LEFT and -RIGHT buttons let you move the cursor in these respective directions one step at a time. INC lets you enter data one increment with each press of the button, while DEC lets you enter data one decrement with each press of the button. The INC/DEC buttons are also used to confirm execution of or abort an operation after pressing ENTER.

REAR PANEL

DIAGRAM & FEATURES

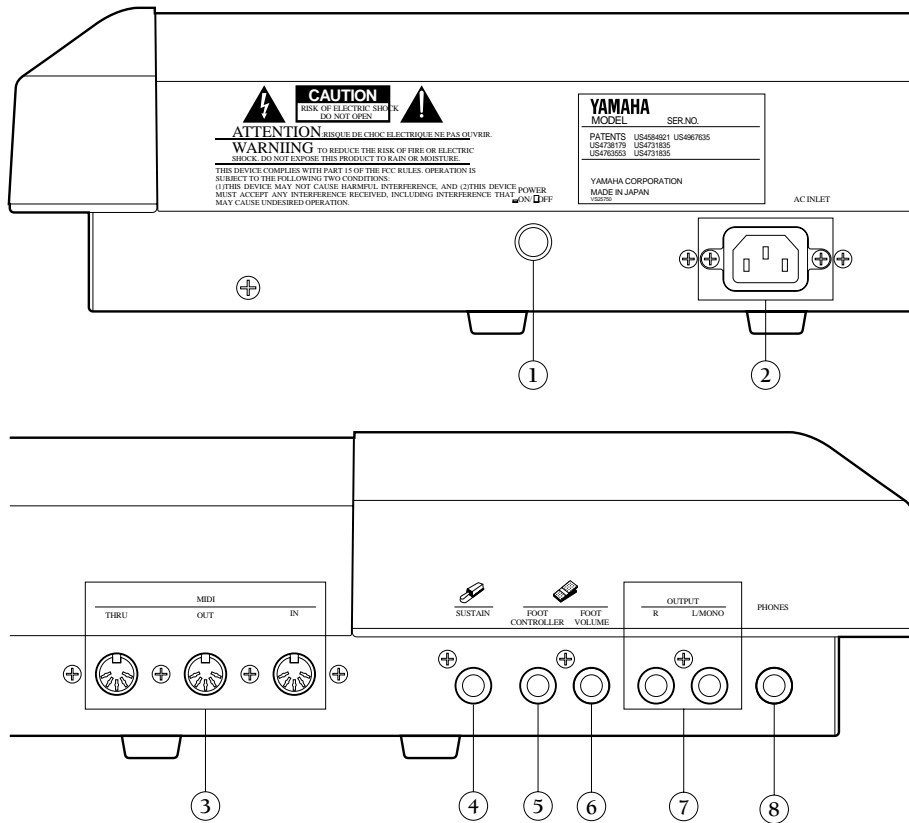

1 POWER SWITCH

Press to turn the power on or off.

2 POWER CONNECTOR

Attach the power supply cord and plug into the AC power outlet.

3 MIDI CONNECTORS

For connecting other MIDI devices. The MIDI IN connector receives MIDI data from an external sequencer or other MIDI device which will control or transmit data to the W5/W7. The MIDI THRU connector simply passes along the data received at the MIDI IN connector, allowing convenient chaining of MIDI devices. The MIDI OUT connector transmits data corresponding to all W5/W7 performance operations, or bulk data when one of the MIDI data transmission functions are activated.

4 SUSTAIN JACK

An optional Yamaha FC4 or FC5 foot switch connected here will permit press-on/release-off sustain control by foot. You can also determine the expression level limit.

5 **FOOT CONTROLLER JACK**

An optional Yamaha FC7 or FC9 foot controller connected here can be used for amplitude modulation, pitch modulation, frequency modulation, envelope generator bias, and filter cutoff frequency control.

6 **FOOT VOLUME JACK**

An optional FC7 or FC9 foot controller connected here can be used to regulate overall volume.

7 **OUTPUT JACKS**

Audio outputs for monitoring the W5/W7 by external amplification in either stereo or mono. If a plug is inserted into only the L/MONO jack, the left and right channel signals are combined and delivered via this single jack.

8 **PHONES JACK**

Accepts a standard pair of stereo headphones (1/4" stereo phone plug) for private monitoring of the W5/W7.

SYSTEM LOGIC

MUSICIAN S WORKSTATION

The W5/W7 Music Synthesizer is a true music workstation designed with the composer as well as performer in mind. In one streamlined, easy-to-use package is bundled all the tools a musician needs to concentrate on making music *naturally* whether composing, recording, performing or practicing rather than being distracted by lots of machines and cables.

The W5/W7 comes equipped with 32-note polyphonic keyboard, 16-track, 16-song sequencer, full voice and song editing capabilities, studio quality digital effects, powerful stereo sound mixing features, large memory capacity, on-board floppy disk drive, GM compatibility, and more everything a musician needs for any modern music situation. Its AWM2 tone generation, which includes hundreds of high quality digital samples that form the core wave of sound elements from which the synthesizer voices are constructed, provides rich, dynamic and powerful, *professional* quality sound.

With the W5/W7, there is no single prescribed method of working the way you use it will be dictated by the needs of your particular music session. All operations are performed within a song multi , or configuration of all parameter settings and other data which make up a song , that can be stored in one of the 16 internal song memories and saved to floppy disk.

One key to the W5/W7 s ease of operation is its intuitive, friendly user interface. Through a balance of easy reach, multi-purpose buttons, sliders and controllers, plus a large LCD screen, the W5/W7 allows you to go directly to any function, whether it s voice editing, recording, song editing, or others, in usually the touch of a single button, and rarely more than two or three.

Another key to the W5/W7 s ease of operation is the flexible nature of the song multis. A song multi is a specific configuration of all settings you make for a particular music session whether composing, recording, performing or practicing which you store in the 16 song memories, and can save to floppy disk in a variety of ways.

Finally, with the W5/W7 you can literally perform any operation on the fly , moving around within functions and jumping from mode to mode intuitively switching back and forth between the various modes freely as you work. You can even switch into Voice Edit Mode while the sequencer is running, in order to make specific voice editing parameter adjustments during song mixdown.

SYSTEM OVERVIEW



BEFORE YOU BEGIN

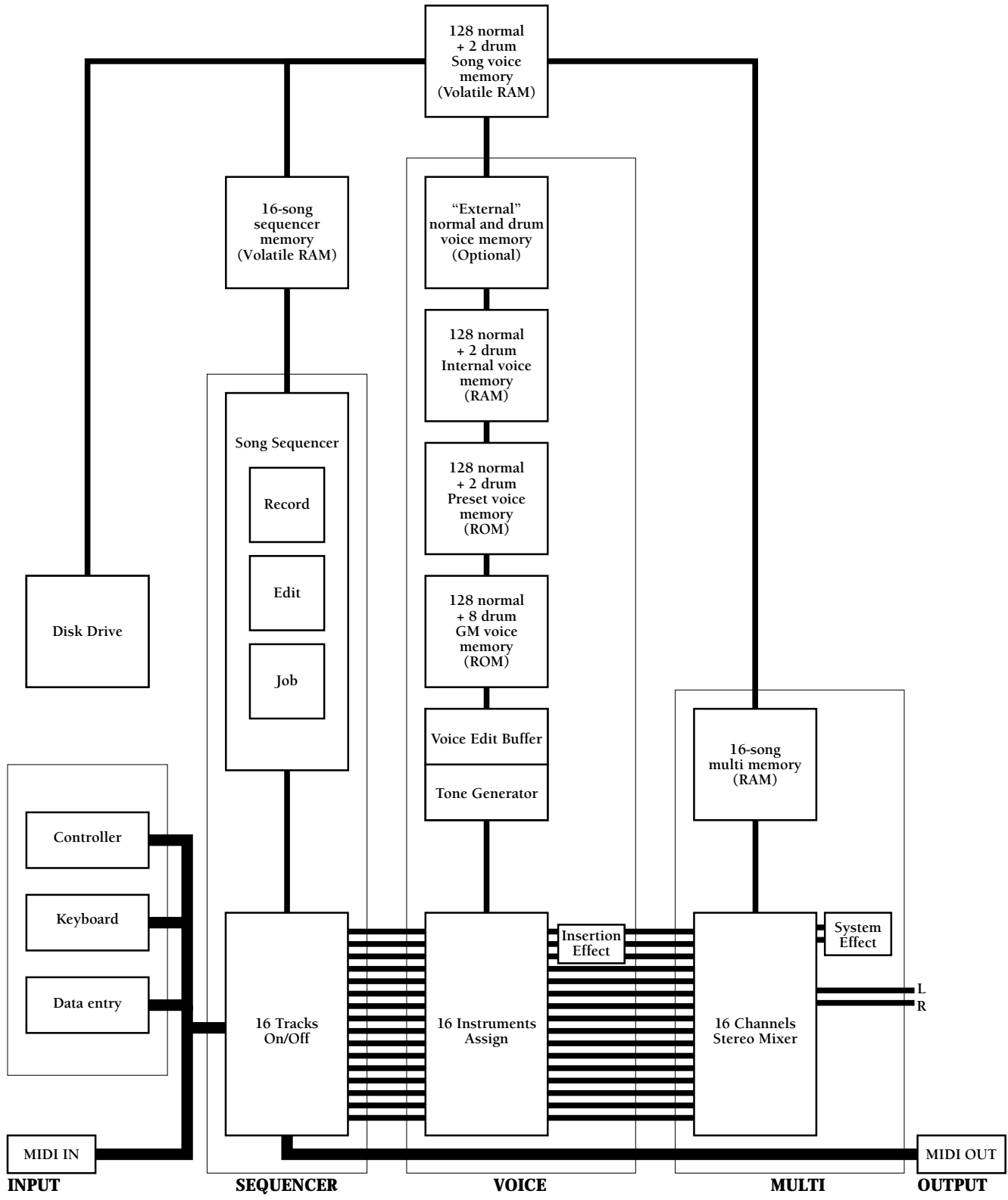

OPERATING MODES

The basic operating modes of the W5/W7 are as follows:

● SONG MODE

For performing Song Play, Song Record, Song Edit and Song Job mode operations. (For more information, see Song Mode, page 72.)

SONGPLAY - Lets you choose between Song Multi, Song Sequence Play and Song Setup functions, in order to *define* a multi by assigning an Instrument voice to each of the 16 tracks and determining sound mixer and other settings for each track (including volume, panning, effects, tuning, note shift and pitch bend), choose any of the 16 songs in internal song memory, assign various MIDI settings including transmit channel, set the keyboard mode to Normal, Split, Layer or 4-Zone, set the sequencer clock to internal or MIDI sync, and determine other settings which affect the currently selected song multi. (For more information, see Song Play Mode, page 73.)

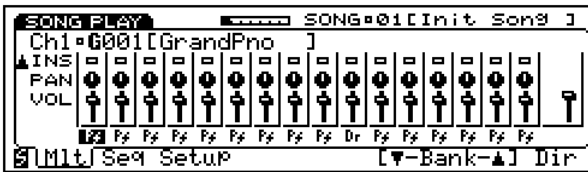

SONGRECORD - Lets you record a sequence in the currently selected song memory, either in real-time (including replace, overdub and punch-in recording) or step-time, as well as determine record parameters like quantize, tempo, click volume and others. (For more information, see Song Record Mode, page 85.)

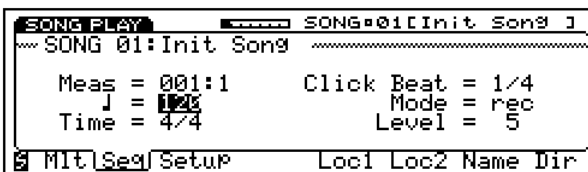

SONGEDIT - Lets you view and edit individual note, controller and other MIDI events in the song sequence, through three separate functions Data Change, which lets you modify the data, Data Insert, which lets you insert new data, and Graph, which lets you view notes as black squares on a keyboard diagram plus a horizontal line which displays black dots that indicate the position of note data in a measure. (For more information, see Song Edit Mode, page 91.)





SONGJOB - Lets you make changes to the sequence that apply to all the data in one or more entire measures. Song Job operations include song copy, append and clear, track copy, clear and mix, measure copy, erase, create, delete and insert, data thin out, extract and chord sort, plus quantize, move clock, modify gate time, modify velocity, transpose, shift note, and crescendo. (For more information, see Song Job Mode, page 95.)



● **VOICE MODE**

For performing single Voice Play and Voice Editing operations. (For more information, see Voice Mode, page 106.)

VOICEPLAY - Lets you play the individual voices (from the Preset, GM, Internal, Song or optional External voice banks) without multi settings applied. (For more information, see Voice Play, page 107.)



VOICEEDIT - Lets you edit any and all parameters which make up a voice, including Insertion Effect and controller settings. You can go directly to Voice Edit Mode from either Voice Play or Song Play and start editing the currently selected voice at any time, even while the sequencer is running. (For more information, see Voice Edit Mode, page 108.)



● STORE MODE

Lets you store multis in an internal song multi memory (01 ~ 16) as well as store original and preset voices in the Internal voice bank. Store Mode is handy for organizing your voices and multis before saving them to disk. (For details, see Store Mode, page 129.)

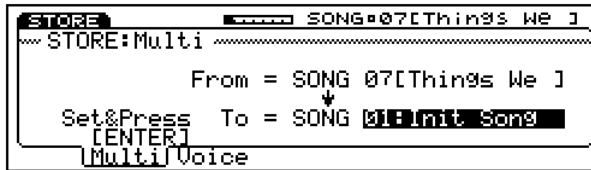

● DISK MODE

Lets you save your original voices, song multis and sequence data in various combinations into disk files on a floppy disk (3.5 2DD type), as well as load the files back into Internal/Song voice and song memory. It also lets you perform various disk file management functions like renaming and deleting files and formatting a disk for the W5/W7 operating system. (For details, see Disk Mode, page 131.)

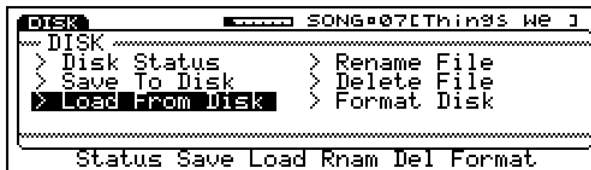

● UTILITY MODE

Lets you manage Song voices, initialize the Internal voice bank, determine various MIDI settings and transmit bulk MIDI data, set master tuning and keyboard velocity parameters, and access other functions which affect the W5/W7's overall system. (For details, see Utility Mode, page 142.)



SYSTEM ARCHITECTURE

The W5/W7 s overall system is comprised of three distinct sections: the Controller section, the Sequencer section and the Tone Generator section. The MIDI signal, originated externally or from the keyboard and controllers, flows through the sequencer before reaching the tone generator.

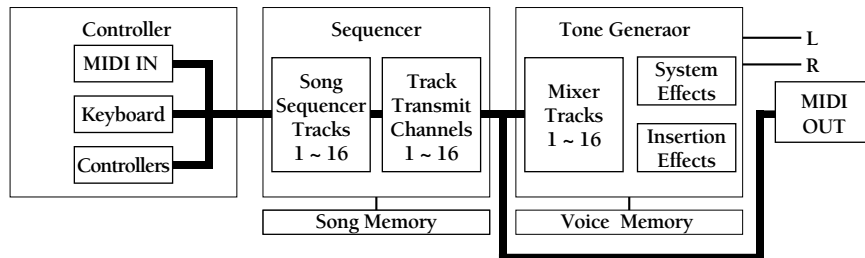

● CONTROLLER SECTION

Controls the source of the MIDI data, whether from an external source, or via the W5/W7 s keyboard and controllers, or from both.

● SEQUENCER SECTION

Receives 16 channels of MIDI data from a source and routes each channel to the corresponding 16 tracks in the sequencer. The sequencer lets you record, edit and play back song sequences, and assign MIDI transmit channel for each track.

● TONE GENERATOR SECTION (MIXER)

Can play up to 16 different Instrument voices simultaneously, as assigned to the sequencer tracks. The tone generator s mixer lets you determine song multi parameters including voice select, volume, pan, Insertion Effect on/off, System Effect (1 ~ 3) send levels, tuning, note shift and pitch bend range for each track, as well as overall settings which affect all tracks equally.

SONG MULTIS

The Song Multi function lets you assign an Instrument voice to each of the 16 TRACK buttons on the panel, plus designate all sound mixer and other settings for each track as well as for the overall mix including volume, panning and digital effects settings, as well as tuning, note shift and pitch bend parameters.

A song multi is the complete configuration of all MIDI, voice, mixer and other assignments and settings which determine the operating status of the W5/W7.

Depending on your particular needs for a setup, i.e., whether you are composing, practicing, recording, or performing live or are using the W5/W7 as a master keyboard controller or as a slave tone generator a song multi may be comprised of the following:

- multi settings (i.e., all parameter settings), song sequence data, and accompanying Song voice bank;
- multi settings with accompanying Song voice bank;
- multi settings only.

A song multi can be stored in any of the 16 song memories in the W5/W7 and saved to floppy disk and loaded back in via the disk drive. And since each song memory also contains a Song voice bank into which you can store up to 128 normal voices and 2 drum voices copied from the Internal, Preset or GM voice bank (or the External voice bank if the optional Expansion Wave/Voice Board is installed), you can organize an entire bank of Song voices specifically for a single multi. This lets you keep all data for a multi in one place, i.e., inside a single song memory.

Song multis are an integral part of the W5/W7's flexibility and user friendliness. Basically, you define the multis naturally as you work, whether you're composing, or recording, or preparing setups for live performance by selecting a track and assigning an Instrument voice to it, setting a pan position here, an effect send level there, and so on. Every multi will take on the unique character of the work session. Then you save your multis to floppy disk, so that whenever you need any particular multi, you can load it back into one of the 16 song memories and be assured that all settings and other data are always exactly as they should be and instantly accessible.

There are literally hundreds of parameters which make up a song multi, but only four basic steps involved in the process of creating and defining the multi: (1) select a song memory location; (2) assign Instrument voices to tracks and determine multi parameter settings as you work, whether you're recording or structuring a performance setup; (3) store the multi in song memory as you work; and (4) save the multi to floppy disk. (For more information about song multis, see Song Mode, page 74.)

NOTE: Song multis can be saved to floppy disk and loaded back into the W5/W7 in various ways, including all 16 songs with accompanying Song voice banks, one song only, one song with accompanying Song voice bank, and in the Standard MIDI File format. For more information on saving to and loading from disk, see Disk Mode, page 131.

L R

MIXER CHANNEL
1~9/11~16

Pitch Bend Range
Note Shift
Tune
System Effect Send 1 Level
System Effect Send 2 Level
System Effect Send 3 Level
Insertion Effect On/Off
Pan Position
Volume Level
INSTRUMENT Assign

Voice Edit			
STEREO VOICE			
Voice Name			
Volume Level			
Insertion Effect Type/Parameter			
Element Edit			
Element 1	Element 2	Element 3	Element 4

NORMAL VOICE

MIXER CHANNEL
10

System Effect Send 1 Level
System Effect Send 2 Level
System Effect Send 3 Level
Insertion Effect On/Off
Pan Position
Volume Level
INSTRUMENT Assign

Voice Edit
STEREO VOICE
Voice Name
Volume Level
Insertion Effect Type/Parameter
Key (Element) Edit
Pan
Volume
System Effect Send Levels

DRUM VOICE

BEFORE YOU BEGIN

INSTRUMENT VOICES AND POLYPHONY

Instrument voices are those Preset, GM, Internal, Song and (optional) External voices assigned to tracks in the tone generator mixer. The number of notes you can play simultaneously with an Instrument voice either from the keyboard or from the sequencer is a maximum of 32, but is determined practically by the number of elements used in a voice, as well as the number of voices used in a sequence. The more elements that make up a voice, the fewer number of keys that can be played on the keyboard, or generated by the tone generator from the sequencer.

VOICE BANKS

The W5/W7 has a total of 10 separate *voice banks*. Eight of these are provided as standard features, while two of them are available as optional ROM memories that you can purchase separately and plug into the W5/W7's logic board via a special access located on the bottom of the instrument.

The various voice banks are organized according to the type of instrument sounds that are in them i.e., by normal voices (voices with pitched sounds) or drum voices (voices with assorted percussion sounds). Whether the voice bank is a normal or a drum voice bank is indicated by a one- or two-letter abbreviation code, respectively, which appears immediately to the left of the voice number. Following is a list of the various voice banks, along with abbreviation codes and descriptions:

NORMAL VOICES

● **(G) GM VOICE**

128 ROM sounds preset according to the General MIDI standard, which cannot be overwritten.

● **(P) PRESET VOICE**

128 ROM sounds preset at the factory, which cannot be overwritten.

● **(I) INTERNAL VOICE**

128 RAM user memory locations which have voices stored in them when shipped from the factory, but can be overwritten when storing your own original normal voices, and will be retained in memory even when the power is turned off.

● **(S) SONG VOICE**

128 RAM user memory locations for storing GM, Preset or Internal voices used in a particular song or multi. Song voice banks each holding 128 normal voices for each song can be saved to and loaded from floppy disks via the disk drive. Song voices will not be retained in memory when the power is turned off.

● **(E) EXTERNAL VOICE**

Additional ROM voices available as an option. (NOTE: The E will not display unless the optional Expansion Wave/Voice Board memory upgrade package is installed.)

● (GD) GM DRUM VOICE

8 ROM drum sets, each with dozens of sounds arrayed on the keyboard, preset according to the General MIDI standard, which cannot be overwritten.

● (PD) PRESET DRUM VOICE

2 ROM drum sets, each with dozens of sounds arrayed on the keyboard, preset at the factory, which cannot be overwritten.

● (ID) INTERNAL DRUM VOICE

2 RAM user memory locations for storing your own original drum voices, which will be retained in memory even when the power is turned off.

● (SD) SONG DRUM VOICE

2 RAM user memory locations for storing GM, Preset or Internal drum voices used in a particular song or multi. Up to 16 Song drum voice banks each holding 2 drum voices can be saved to and loaded from floppy disks via the disk drive. Song drum voices will not be retained in memory when the power is turned off.

● (ED) EXTERNAL DRUM VOICE

Additional ROM drum sets available as an option. (NOTE: The ED will not display unless the optional Expansion Wave/Voice Board memory upgrade package is installed.)

(For more information about voices and elements, please refer to the *W5/W7 Technical Information* booklet, supplied separately.)

VOICE CATEGORIES

The individual voices are organized into 21 classes of instrument groups, called Voice Categories, for easier access, as follows:

—	No Assign		
Pf	Piano	Ld	Synth Lead
Cp	Chromatic Percussion	Pd	Synth Pad
Or	Organ	Fx	Synth Sound Effects
Gt	Guitar	Et	Ethnic
Ba	Bass	Pc	Percussive
St	Strings/Orchestral	Se	Sound Effect
En	Ensemble	Dr	Drums
Br	Brass	Sc	Synth Comping
Rd	Reed	Vo	Voice
Pi	Pipe	Co	Combination

NOTE: When the voice bank is set to off, no Voice Category code will display.

The Voice Category for each voice is identified by a two-character prefix, which in Voice Mode will appear to the left of the voice name, and in Song Mode will appear just below the track volume section in the mixer screen.

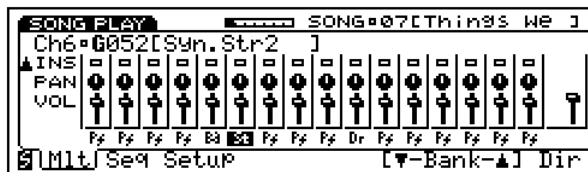

NOTE: You can assign a voice category code to your own voices in Voice Edit Mode.

BEFORE YOU BEGIN

INSERTION EFFECTS & SYSTEM EFFECTS

The W5/W7 has 75 digital effects inside two independent, studio quality DSP stereo effects processors with editable parameters called Insertion Effects and System Effects, which provides for enormous sound processing flexibility and control. Effects include reverb, delay, chorus, auto panning, 3-band EQ, Aural Exciter™, pitch change, distortion and many more.

BEFORE YOU BEGIN

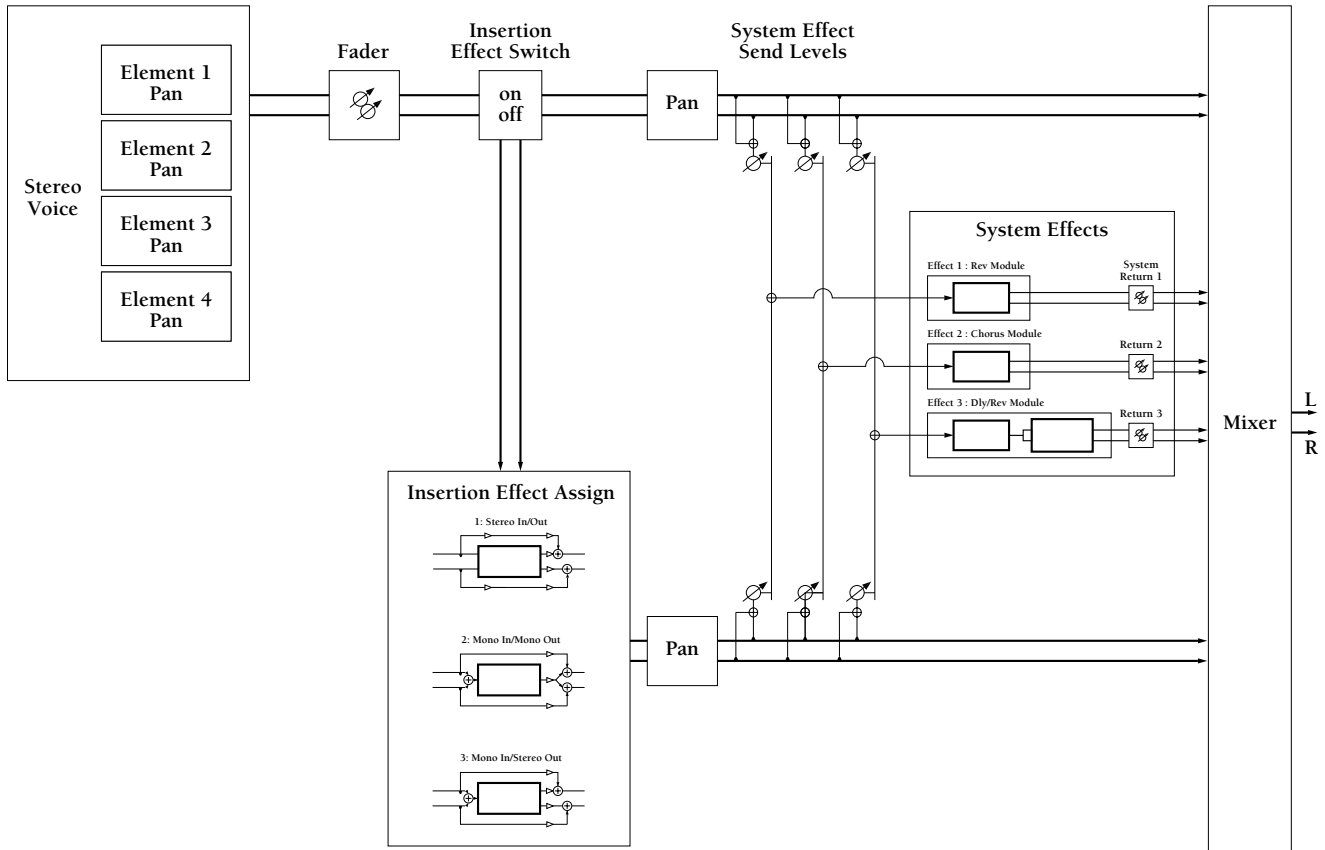

*Aural Exciter™ is a registered trademark of and is manufactured under license from Aphex Systems Ltd.

INSERTION EFFECTS - An Insertion Effect can be assigned to an Instrument voice. A maximum of three voices may use an Insertion Effect at any one time, one Insertion Effect per voice for a song. A specific Insertion Effect, along with user-assigned parameter settings, can be specified for a voice within Voice Edit Mode.

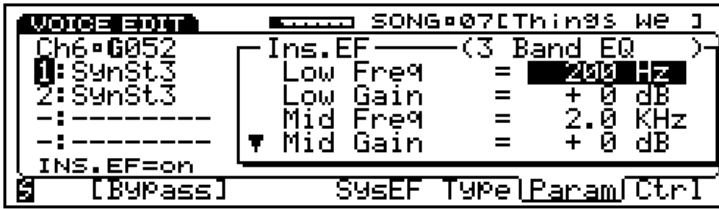

The Insertion Effect for each voice may be switched on and off from within a mixer track. There are a total of 35 preprogrammed Insertion Effects, which can be edited and configured in a variety of ways in the voice and multi for a song or performance setup. (For more information about Insertion Effects, see page 119.)

SYSTEM EFFECTS - There are three System Effects which can be applied to the overall mix, and send levels for each effect can be adjusted via the mixer. System Effects can be designated, and System Effect parameters can be edited, from within the multi.

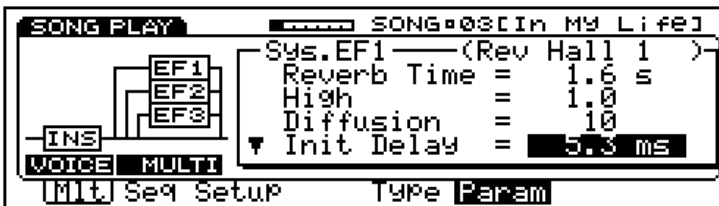

There are a total of 40 preprogrammed System Effects, which can be edited and configured in a variety of ways in the voice and multi for a song or performance setup. (For more information about System Effects, see page 79.)

AWM2 TONE GENERATION

The W5/W7 creates sounds through Yamaha's exclusive AWM2 (2nd generation Advanced Wave Memory) tone generation process, which starts with high-quality digital samples of actual instruments and sounds.

The W5/W7's extensive on-board synthesizer and voice editing features give you unlimited sound sculpting potential, and its intuitive user interface lets you access literally any sound parameter in rarely more than two pushes of a button.

The W5/W7 comes equipped with a large capacity waveform ROM full of preset AWM sound elements (8Mbytes of 16-bit linear waveforms sampled at maximum 48kHz sampling frequency). These preset sounds are the fundamental waves which make up a W5/W7 element—the building blocks that make up an Instrument voice.

There are hundreds of preset elements to choose from, and an optional External Expansion Wave/Voice Board can be purchased separately and plugged into the W5/W7's logic board to increase the on-board capacity by another 4Mbytes.

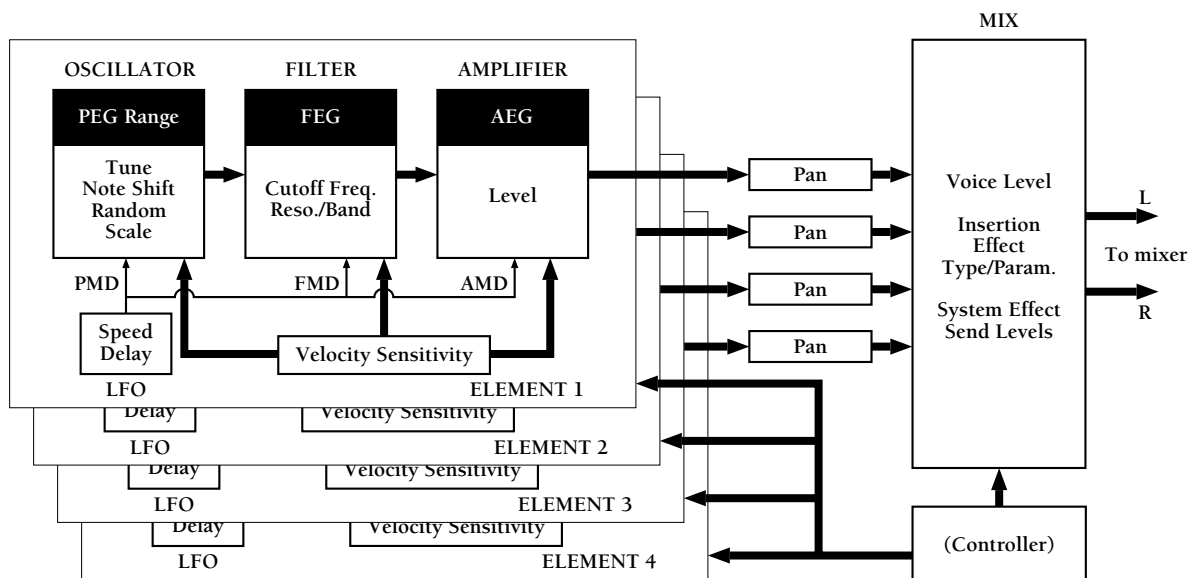

AWM elements are at the heart of the W5/W7's rich, dynamic sound quality. One AWM element is capable of making an Instrument voice, but the W5/W7 lets you construct voices that contain as many as four elements in order to obtain virtually unlimited sonic and performance potential.

An AWM element is a wholly formed, complete musical instrument sound unto itself. It is made up of an AWM sample, or wave, plus pitch, filter, amplitude, LFO and controller components, all of which can be manipulated in a variety of ways.

The AWM wave, which forms the fundamental characteristic of a voice, can be controlled in various ways to modify the pitch of the sound. The pitch envelope generator (PEG) can be used to give each note a fixed pattern of pitch change over time. The pitch change can also be affected by key velocity. Vibrato (pitch modulation) can be created using the low frequency oscillator (LFO). Amount of vibrato can be regulated by a controller. The pitch can be controlled directly by the pitch bend wheel and by aftertouch.

The filter can be controlled in various ways to modify the tone of the sound. Each note can be given a fixed pattern of tonal change by using the filter envelope generator (FEG), which can also be affected by key velocity. Wah-wah (filter modulation) can be created using the LFO, and wah-wah depth can be regulated by a controller. Tone can also be directly affected by a controller.

The amplifier, or amp, can be controlled in various ways to manipulate the volume of the sound. Each note can be given a fixed pattern of volume change by using the amplifier envelope generator (AEG), which can also be affected by key velocity. Tremolo (volume modulation) can be created using the LFO, and tremolo depth can be regulated by a controller. Volume can also be directly affected by a controller.

CONTROLLING THE SOUND

Musical instrument sounds are complex and constantly changing. Different types of instrument sounds change over time in very different ways. With an instrument such as a piano, for example, the tone and volume of each note changes in a predictable way over time. With an instrument such as a violin, on the other hand, the volume, tone, or pitch may be continuously modified by the musician during performance. The W5/W7 provides many ways to control the various aspects of the sound, as follows:

- **ENVELOPE GENERATOR (EG)** - The EG produces a fixed pattern of change over time. For example, to simulate the attack and decay of a piano, you would set the amplitude EG to be loud when the note is first played, and then to gradually diminish in volume over the following moments.

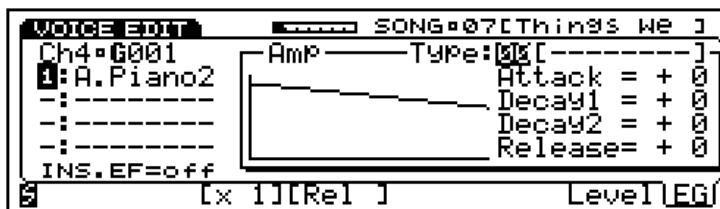

- **KEY VELOCITY** - The velocity (speed) with which you play each key can affect various aspects of the sound. For example, strongly and softly played notes can be made to differ in pitch, tone, or volume.

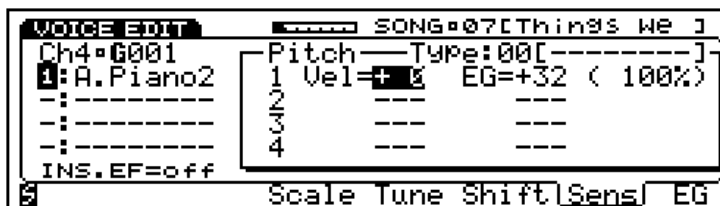

- **LOW FREQUENCY OSCILLATOR (LFO)** - The LFO produces various patterns of cyclical change. Applying the LFO to the pitch component produces vibrato; applying it to the filter component produces wah-wah; applying it to the amplifier component produces tremolo.

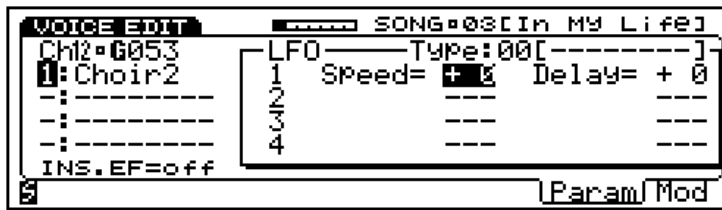

- **CONTROLLERS** - Controllers such as the pitch and modulation wheels, aftertouch, and optional foot controllers can be used to control the sound in a variety of ways. Some controllers such as the pitch bend wheel can directly determine the pitch. You can assign the various other controllers to control many aspects of the sound. For example, you might assign aftertouch so that the amount of vibrato (LFO modulation to the wave component) increases as you apply pressure to the keyboard after the initial attack.

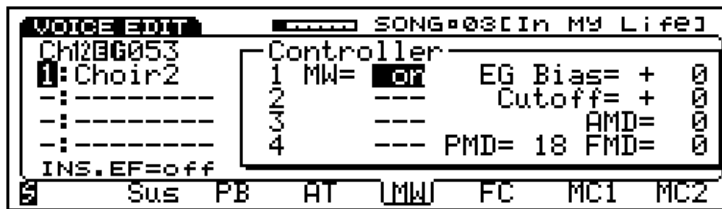

VOICE EDITING

In Voice Edit Mode you can edit any and all parameters which make up a voice, including Insertion Effect assignment and parameter settings, as well as controller settings. You can go directly to Voice Edit Mode from any mode and start editing the currently selected voice at any time, even while the sequencer is running.

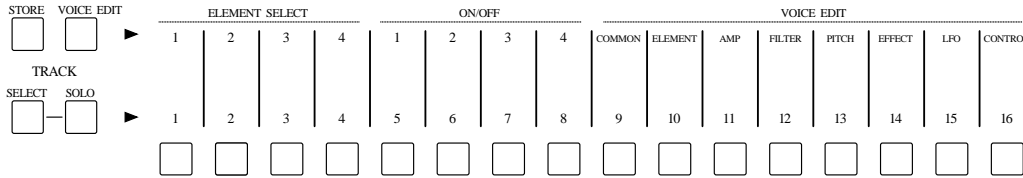

In Voice Edit Mode, the TRACK buttons on the panel double as voice editing function access and control, letting you choose the main voice editing functions with one touch, as well as select the AWM elements and switch them on and off. The orange lights in the VOICE EDIT and TRACK buttons will always indicate the voice editing status, including which elements are selected or switched on or off, and which element edit function is currently selected. Also, in Voice Edit Mode, the VOICE EDIT button doubles as a compare button, to let you compare the sound of the original voice to the sound of the voice you re creating.

Normal voice editing starts with either an initialized voice when you want to edit a voice from scratch, or a Preset, GM, Internal (or optional External) voice when you want to modify an existing sound. Accessing all voice editing features, including common, element, amplifier, filter, pitch, effect, LFO and control, rarely takes more than the press of a button or two, and adjusting parameter settings is just as simple, using the JOG, INC/DEC and KEYPAD.



Drum voice editing starts with an existing Preset or GM drum voice. Accessing all voice editing features, including common, key, effect and control, rarely takes more than the press of a button or two, and adjusting parameter settings is just as simple, using the JOG, INC/DEC and KEYPAD.



(For more information about voice editing, see Voice Edit Mode, page 108.)

SONG SEQUENCING

The W5/W7 comes equipped with a powerful 16-track, 16-song music sequencer with large capacity memory (approximately 100,000 notes) that permits realtime (including overdub and punch-in) and step recording, plus extensive song editing.

The W5/W7 s sequencer doesn t record actual sounds, it records note, controller, program change and other MIDI data. Regardless of whatever sound you used to record a specific part, you can always change the sound later by assigning a different voice to the track. The music events inside each track can be singled out in the song editing process and changed in many ways.

The currently selected sequencer track will be lit red. TRACK buttons for tracks with sequencer data in them will be lit green, while an unlit Track button will indicate that no music data is in the track. During sequence playback, you can solo and mute the different tracks.

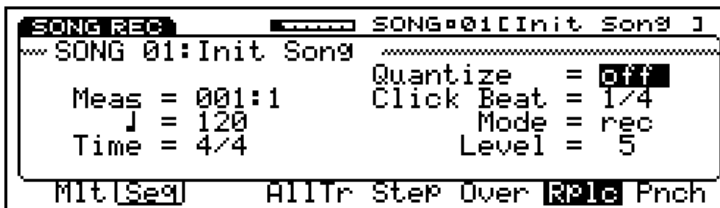
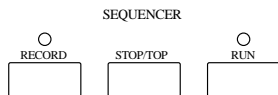

As you re composing, you can use some or all of the 16 song memories to hold parts of a song, then hear how they sound in context by having them play back in numeric order without pausing in between.

During song editing you can view and edit individual note, controller and other MIDI events in the song sequence, through three separate functions Data Change, which lets you modify the data, Data Insert, which lets you insert new data, and Graph, which lets you view notes as squares on a keyboard diagram plus a horizontal line which displays dots that indicate the position of note data in a measure.

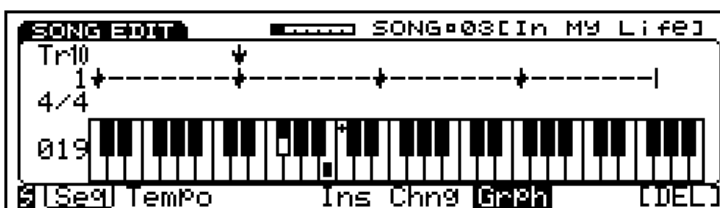

You can also make changes to the sequence that apply to all the data in one or more entire measures with song jobs . Song Job operations include song copy, append and clear, track copy, clear and mix, measure copy, erase, create, delete and insert, data thin out, extract and chord sort, plus quantize, move clock, modify gate time, modify velocity, transpose, shift note, and crescendo.

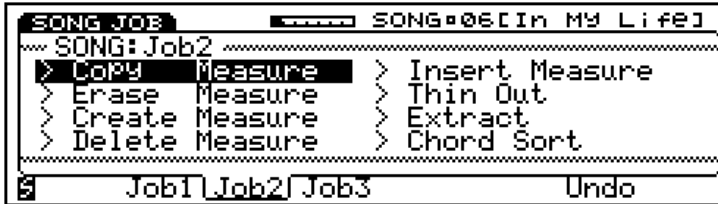

(For more information about song sequencing, see Song Record Mode, page 85.)

SOUND MIXING

The W5/W7 has extensive stereo sound mixing capabilities, via the on-board tone generator sound mixer, the digital effects and other Song Multi parameters. In conjunction with specific program change, controller and other events you can record into the sequencer, you can even achieve an automated mixdown for your final playback output.

Sound mixing doesn't necessarily have to be a final procedure in the music making process using the W5/W7. You can construct your mix as you go along, then fine-tune it at the end. What's more, depending on the sound, you may want to switch into Voice Edit Mode and tweak a few parameters in individual voices in order to make them sit better within the context of the sounds of all tracks.

The Song Multi function screen, which displays a graphic representation of a sound mixer, is designed to let you quickly access all functions and parameters in the multi, as well as give you ample visual feedback as you work. This basic operating home screen, in conjunction with the function keys [F1 ~ F8], the CURSOR keys, the JOG, INC/DEC and the KEYPAD, give you enormous sound sculpting capabilities.

NOTE: Pressing a TRACK button will select the track, and automatically place the cursor within that track on the mixer. With that track still selected, you can use CURSOR-LEFT and CURSOR-RIGHT to specify another track, so that you can adjust parameters of another track that's playing back from the sequencer while you are performing a live part.

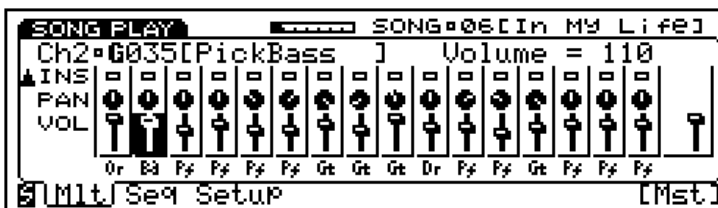

The sound mixer as displayed in the LCD screen is actually only a partial view, since the mixer is made up of several sections, and in effect extends beyond the top of the screen! The diagram below shows the mixer as it would appear in its entirety, complete with other visual information in and functions accessible from the Song Multi screen.

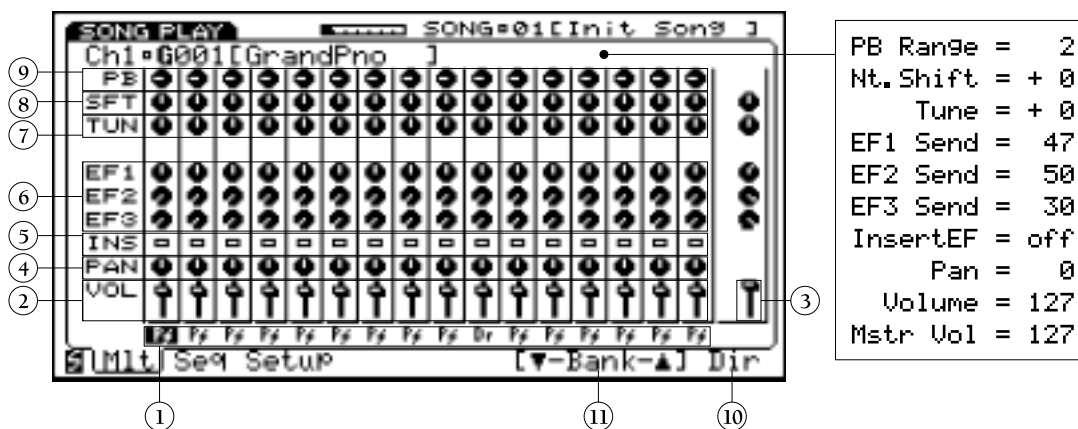

The 16-channel sound mixer is made up of various sections, or blocks, devoted to specific functions available in all tracks, including the following:

1 VOICE SELECT

The Voice Select block is the first stop in each of the 16 mixer channels, represented graphically by the two-letter Voice Category code of the voice currently assigned to the track. The cursor must be positioned at Voice Select before you can choose a voice to assign to the track.

2 VOICE VOLUME

The Voice Volume block is the second stop in each of the 16 mixer channels, represented graphically by a fader. The cursor must be positioned at Voice Volume before you can make volume adjustments to the track.

NOTE: The Master Volume, Master Tune and Master Note Shift settings affect all songs.

3 MASTER VOLUME

From within Voice Volume parameter select, pressing [F8] (Mst) accesses the Master Volume control, which lets you set the overall output volume of the sound mix.

4 VOICE PAN

The Voice Pan block is the third stop in each of the 16 mixer channels, represented graphically by a pot. The cursor must be positioned at Voice Pan before you can set the stereo pan position of the voice between the left and right outputs.

5 INSERTION EFFECT SWITCH

The Insertion Effect switch block is the fourth stop in each of the 16 mixer channels, represented graphically by an empty square (off) or a solid square (on). It lets you apply an Insertion Effect to a voice. (Up to three Insertion Effects can be applied in a song, one per Instrument voice.) The cursor must be positioned at Insertion Effect Switch before you can turn the Insertion Effect on and off. (Insertion Effect type assignment and parameter settings for any particular voice are determined in Voice Edit Mode.)

6 SYSTEM EFFECT SENDS 1/2/3

The System Effect block, with sends 3, 2, and 1, are the fifth, sixth and seventh stops, respectively, in each of the 16 mixer channels, represented graphically by pots. From within a System Effect Send you can determine the amount of signal level which gets sent to each respective System Effect, as well as designate the type of System Effects for the multi, plus edit System Effect parameters. The cursor must be positioned at a System Effect Send stop before you can set the send level. You can also directly access System Effect type and parameters from the mixer.

NOTE: You can modify a particular parameter for all tracks at once by holding down SHIFT while modifying the parameter. All value changes will be real time to the setting in each track unless you use the KEYPAD, in which case all values will be entered as the same.

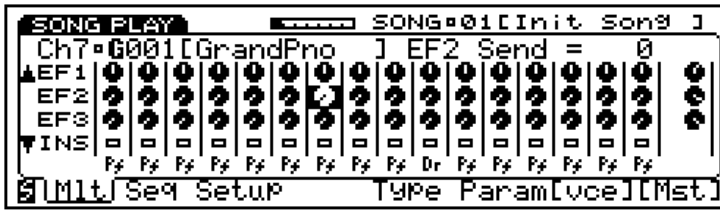

7 TUNE

The Voice Tune block is the eighth stop in each of the 16 mixer channels, represented graphically by a pot. It lets you adjust the fine-tuning of the voice in steps of 1.17 cents. The cursor must be positioned at Voice Tune before you can set the track tuning. Pressing [F8] (Mst) lets you set the Master Tune, which affects overall fine-tuning for all tracks equally.

8 NOTE SHIFT

The Note Shift block is the ninth stop in each of the 16 mixer channels, represented graphically by a pot. It lets you determine the coarse-tuning of the voice in half-steps. The cursor must be positioned at Note Shift before you can set the track note shift. Pressing [F8] (Mst) lets you set the Master Note Shift, which affects overall note shift for all tracks equally.

9 PITCH BEND RANGE

The Pitch Bend Range block is the tenth and final stop in each of the 16 mixer channels, represented graphically by a pot. It lets you designate the range the voice's pitch bends up or down by the Pitch Bend wheel. The cursor must be positioned at Pitch Bend Range before you can set the track pitch bend value.

10 VOICE DIRECTORY

From within Voice Select, pressing [F8] (Dir) accesses the Voice Directory, which displays the voices in the currently selected voice bank by list, eight at a time.



Within the Voice Directory you can select voices by scrolling through the entire list using the JOG, INC/DEC, or the CURSOR keys, or enter a specific number on the KEYPAD the list will advance accordingly. (You can also select voice banks from within the Voice Directory.)

11 VOICE BANK SELECT

When the cursor is positioned at Voice Select, pressing [F6] and [F7] lets you choose a voice bank. The one- or two-letter voice bank code will begin flashing, indicating that you must then press ENTER to lock in the desired bank.

MEMORY ALLOCATION

The W5/W7 has large internal ROM and RAM memory capacity, but some RAM data is retained at power off and some is not. Data which is retained at power off includes Internal normal and drum voice banks, and multi *settings* in the 16 song multi memories. Data which is not retained at power off include song sequences and accompanying Song voice bank memories.

NOTE: When the power is turned back on, the multi set-up data for all songs in the memory at power off will still be retained, and therefore the song name will still appear; however, the song sequence data and Song voice data will be gone.

Because of the on-board floppy disk drive, the voice and multi storing functions, and the many ways in which you can save and load the various types of data, this need not be a problem. A little discipline in the area of always remembering to save important music data to floppy disk before turning the power off a good habit to foster in any case will render this not a problem at all.

There are various modes and functions for managing the various types of data.

● SONG VOICE MEMORY

The Song Voice Memory function lets you manage Song voice memory banks by copying an entire bank of normal and drum voices from the Internal, GM and Preset voice banks to the Song voice memory bank of the currently selected song.

NOTE: You can also copy from the External preset voice bank if the optional Expansion Wave/Voice Board is installed.

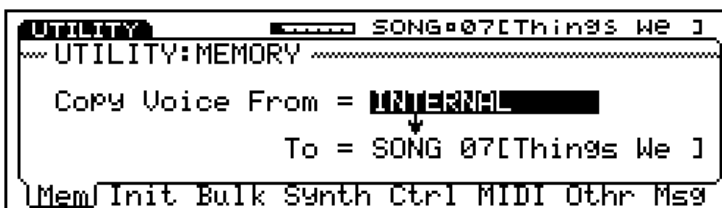

Each internal song multi (01 ~ 16) can accommodate a Song voice memory bank that will hold 128 normal and 2 drum voices. These Song voices are exclusive to each song multi, and can only be accessed by the currently selected multi. (Song voices from other multis cannot be accessed from within the currently selected multi).

One of the most useful ways to manage Song voices is to first arrange the voices you want in the Internal voice bank, using the Voice Store function. Then copy the Internal voice bank to the currently selected Song voice bank using the Utility Mode's Song Voice Memory function.

● STORE MULTI

Store Multi Mode lets you store the currently selected multi into a song memory location (01 ~ 16). Multi data which can be stored in a Song memory location includes all multi settings (i.e., MIDI, mixer and other parameter settings for the 16 Instrument voice tracks) and other setup data.

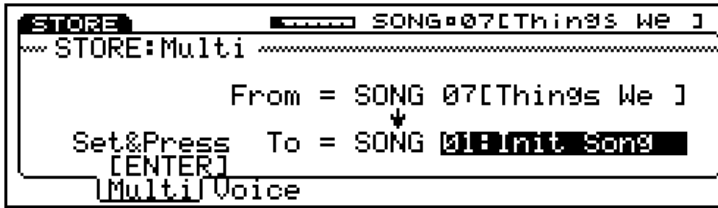

As you set parameters in a multi, as well as record or edit a song sequence within the song multi, all settings and data are entered within the currently selected song memory as you input it. However, you must store the multi using Store Mode before you select another song, or the setting changes will be lost.

Also, all song sequence data and Song voice data will only be retained as long as the power is on. Therefore, you must *always save your important song sequence and Song voice data to floppy disks before turning the power off*, or it will be lost.

NOTE: Multi settings for SMF song data will load into the W5/W7, but will not be retained at power off unless you first store it in a song location. In order to be sure that you don't accidentally lose your important multi settings, it is a good habit to periodically perform the Store Multi operation as you work.

● STORE VOICE

Store Voice Mode lets you store the currently selected voice, including any voice edit changes, to an Internal voice bank memory (001 ~ 128).

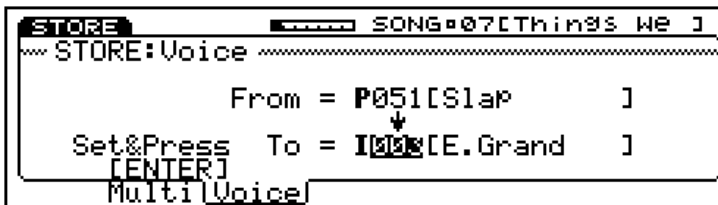

As you make parameter setting changes in Voice Edit Mode, the changes are made on a copy of the original voice which is temporarily held in the voice edit buffer. The settings will be retained as you switch back and forth between edit and compare, but will be lost if you select another voice before storing it to an Internal voice memory. Therefore, you must *always store your important user-created voices to an Internal voice bank memory before selecting another voice*.

In Store Voice Mode, currently selected Preset, GM and Internal voices can only be stored in the Internal voice bank; therefore, the Internal bank is automatically selected as the store destination.

● DISK

Disk Mode lets you save your original voices, song multis and sequence data in various combinations into disk files on a floppy disk (3.5 2DD type), as well as load the files back into Internal/Song voice and song memory. It also lets you perform various disk file management functions like renaming and deleting files and formatting a disk for the W5/W7 operating system.

```
DISK          SONG#07[Things We I
~DISK:Load from Disk~
> All Data          > ESEQ/SMF
> 1 Song           > Voice
> 1 Song+Voice
~-----~
[5] All 1Song 1S+V SMF Voice
```

And it permits the saving of songs in Standard MIDI File Format-0, as well as the loading of sequences recorded on other devices and saved in the Standard MIDI File Format-0 and -1, and the Yamaha ESEQ format.

```
DISK          SONG#07[Things We I
~FILE Directory~
01: [REDACTED] 05: NORWEGAN.MID
02: ELEANOR .MID 06: PENNY .MID
03: INMYLIF .MID 07: THINGS .MID
04: LONGROAD.MID 08: WITH .MID
                               [Dir]
```

Within the respective file management operations, the File Directory provides a convenient display of data lists.

DATA ENTRY

The W5/W7 provides many convenient ways to access and manipulate data. The various multi-purpose buttons, sliders and controllers allow you to go directly to any function, in usually the touch of a single button, and rarely more than two or three. The large LCD screen and other visual indicators give you ample feedback to always let you know exactly where you are and what status the W5/W7 is in.

Selecting parameters and entering data entry is equally straightforward. The basic data entry section is made up of a keypad, four-way cursor controls, increment and decrement buttons and a jog/shuttle dial.

Following is a breakdown of the various indicators and data controls:

LCDSCREEN - The 240 x 64 dot Liquid Crystal Display with adjustable contrast provides graphic, numeric and much other visual information depending on the selected mode or current status.

TRACK BUTTONS 1 ~ 16 - In Song Play, Voice Play and Song Record Modes, the TRACK buttons let you select any track in the multi the selected TRACK button will be indicated with a red light.

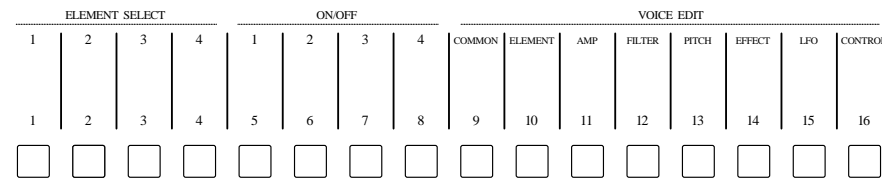
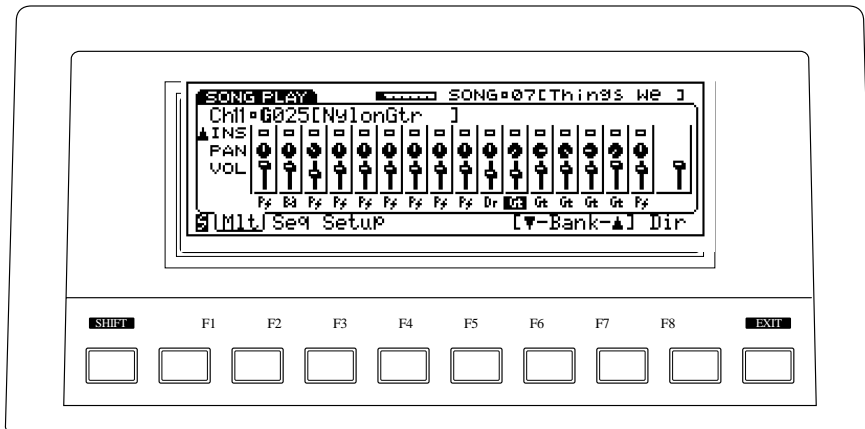

In Song Sequence Play Mode, the TRACK buttons corresponding with tracks which have music data in them will be indicated with a green light. (In Solo Mode, a green TRACK button indicates that the track is muted, and a red TRACK button indicates that the track is soloed.) In Normal Voice Edit Mode, TRACK buttons 1 ~ 4 double as element select switches, buttons 5 ~ 8 as element on/off switches, and buttons 9 ~ 16 as edit function selectors as indicated on the panel directly above each button. When in Voice Edit Mode, the selected buttons will be indicated with orange lights.

FUNCTION KEYS 1~8 - The functions of these keys [F1 ~ F8] depend on the selected mode. They are used to engage a function indicated on the display immediately above the key.

SHIFT KEY - The SHIFT key is used in conjunction with the function keys to access secondary functions and parameters, as well as to jump directly to main menus and other functions. A small capital S inside a black box in the lower left corner of the screen will indicate that SHIFT functions are accessible.

EXIT KEY - EXIT is for exiting from any function or submode. Depending on how deep inside a function you are, you may need to press the EXIT key more than once to return to the basic mode screen.

DATA ENTRY KEYPAD - For precise, specific entry of data, by punching in a number, then pressing ENTER. The [—] button lets you enter a negative value, by pressing it immediately before pressing ENTER. In Song Record Mode you can enter music notation values according to the corresponding musical symbols and indications printed above the buttons. ENTER is used to execute many different operations.

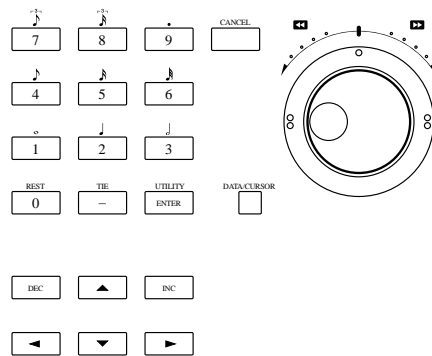

CANCEL BUTTON - If you change a parameter and then decide you want to retrieve the previous data value, pressing CANCEL before proceeding to another function will cancel out the data entry, reverting to the previous value status.

JOG/SHUTTLE DIAL - The two-function concentric (inner and outer) dial has various uses. The JOG (inner dial) lets you enter data or scroll through functions. The SHUTTLE (outer dial) lets you fast forward or rewind through measures in a song sequence.

DATA/CURSOR BUTTON - The DATA/CURSOR button status determines the function of the JOG dial. When switched off (no light), the JOG will be used primarily for entering data. When switched on (red light indicator), spinning the JOG will move the cursor.

CURSOR CONTROL & INC/DEC BUTTONS - The arrow CURSOR-UP, -DOWN, -LEFT and -RIGHT buttons let you move the cursor in these respective directions one step at a time. INC lets you enter data one increment with each press of the button, while DEC lets you enter data one decrement with each press of the button. The INC/DEC buttons are also used to confirm execution of or abort an operation after pressing ENTER.

GETTING STARTED

You're probably in a hurry to get started enjoying the W5/W7's beautiful sounds and other spectacular musical wonders, so we've structured this section as a basic tutorial to get you up and going with a minimum of detail, so you can spend your first few hours pushing buttons, twiddling knobs, riding faders and just generally having a good time familiarizing yourself with the W5/W7.

We'll take the grand tour of the instrument and step through all of the basic operating procedures, including:

- Connecting the W5/W7 to a monitor system, powering up and exploring the preset musical instrument voices and realtime performance control capabilities.
- Loading the demonstration songs from the floppy disk provided with the instrument and exploring the W5/W7's song play options.
- Editing and naming user voices and storing them in Internal voice memory.
- Creating song sequences and stereo sound mixing.
- Saving voices and songs to floppy disk, plus tips on how to best organize and manage your music data.
- Integrating the W5/W7 into an expanded music system by connecting it to other external MIDI devices like tone generators, samplers and computers, and using it as either a master keyboard controller or a multitimbral tone generator or sequencer controlled by other devices.

The subsequent tutorial assumes that you have not yet hooked up the W5/W7 and started exploring its many features. If you have already begun using the W5/W7, some of the screens may be different from the ones which appear in the tutorial.

Finally, since this and other sections in this manual use concepts and terms specific to the W5/W7, if you haven't done so already, please take a few moments to go back and read *Before You Begin*, page 7.

SETUP & PLAY

After unpacking the W5/W7 and placing it on a keyboard stand or sturdy table or desk, you'll want to **MAKE ALL CONNECTIONS BEFORE PLUGGING IN AND TURNING ON THE POWER OF ALL DEVICES**. This is extremely important in order to avoid the possibility of causing a power spike that could potentially damage the W5/W7 or your monitor system, or worse, the possibility of electrical shock.

IMPORTANTNOTE: *Danger! Type of electrical cable may be different depending on countries a third prong may be provided for grounding purposes. Improper connection of the grounding conductor can create the risk of electrical shock. Do not modify the plug provided with the W5/W7. If the plug will not fit the outlet, have a proper outlet installed by a qualified electrician. Do not use an adapter which defeats the grounding conductor. If you are unsure as to whether the W5/W7 is properly grounded, check with a qualified service technician or electrician.*

CONNECTING TO A MONITOR SYSTEM

The diagram below shows a basic setup using only the W5/W7 monitored by a stereo system.

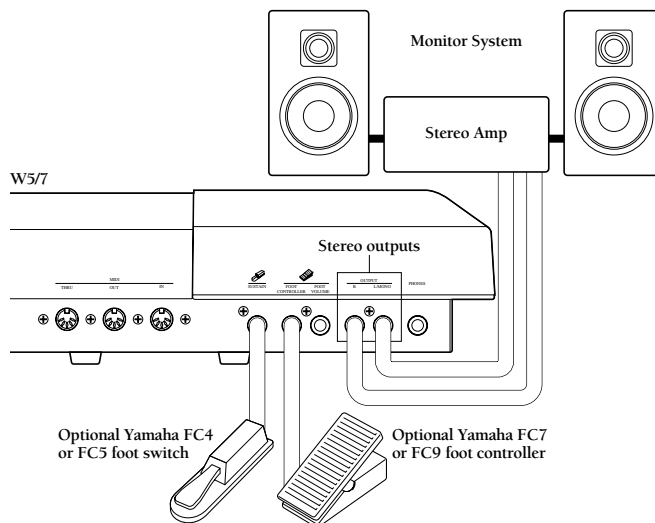

NOTE: *Connect only L/Mono if you have a monophonic sound system*

POWER-ON PROCEDURE

There is actually a correct process for switching the various components in an electronic music system on and off. The rules are simple but important. Before turning anything on:

- Be sure that all components are actually plugged in, and check to make sure that all volume controls are turned down to their zero positions.
- Always turn the W5/W7 on first (followed by any additional MIDI devices which may be connected).
- Always turn the sound system on last.
- Raise the sound system volume to a reasonable level.
- Gradually raise the W5/W7 volume fader while playing the keyboard to set the desired listening level.

NOTE: When turning the various components off, simply reverse the process: lower all volume levels to zero, turn the sound system off first, and the W5/W7 off last. The reason for turning the W5/W7 on first and off last is to avoid the possibility of sending a power surge through the sound system which could damage the amplifier or speakers. If other MIDI devices are connected to the W5/W7 MIDI OUT port and the W5/W7 is acting as the controller keyboard, turning the W5/W7 on before them is wise because the W5/W7 automatically transmits MIDI control change data corresponding to its control status when its power switch is turned on and off, which could interfere with operation of other MIDI equipment.

EXPLORING THE PRESET VOICES

The W5/W7 powers up in Song Multi Play Mode, ready for you to play the Instrument voices from the keyboard. After the brief startup process, a graphic representation of a 16 track stereo sound mixer will appear on the screen. A brand new W5/W7 (or one that has been reset to its default settings) will start up with Track 1 selected and GM voice #001 Grand Piano assigned to it.

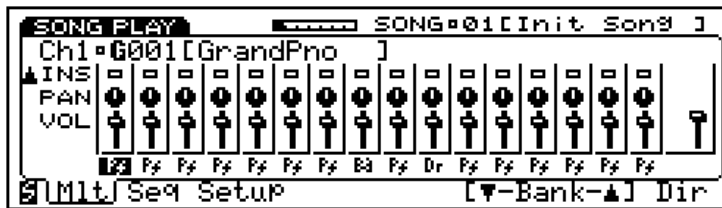

This basic default sound mixer screen, plus the red light over the SONG MODE button, a green TRACK SELECT button, and a red TRACK 1 button, indicate that the W5/W7 is in Song Multi Play Mode, with Track 1 of the song multi #01 selected, and GM voice #001 [Grand Piano] assigned to the track. (For more information about song multis, see page 74.)

You can select any of the 16 tracks in the multi and play the instrument voice assigned to it simply by pressing one of the TRACK buttons. With the W5/W7, an instrument can be either a normal or pitched voice, or a drum or percussion voice.

NOTE: In the factory set default setup, the 16 tracks of all 16 song multis are basically unassigned, meaning that they are ready and waiting for you to assign the Instrument voice of your choice to each track. At factory default, every track except Track 10 will have GM normal voice #001 assigned to it. Track 10 will have GM drum voice #01 assigned to it. Track 10 is dedicated to drum voices only in accordance with the General MIDI standard which mandates that MIDI channel 10 be reserved for drums. (Therefore, normal voices can not be assigned to Track 10.)

In Song Multi Play Mode, the W5/W7 is set to play a stereo mix of the Instrument voice assigned to the currently selected track in the multi, complete with System Effects and other various parameters applied to the sound through the tone generator mixer.

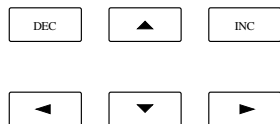

You can use the CURSOR keys to move around to the various mixer sections, or feature blocks such as panning and effects sections in order to adjust those parameters. At power on, the cursor is always placed over the Voice Select block of Track 1 (of song multi #01) as indicated by the two-letter Voice Category abbreviation in reverse type (for details, see below, page 47).

There are many submodes and functions you can access from the Song Multi Play screen, but for the time being take a look at the three-digit voice number (001 ~ 128) and name on the second line of the display and start choosing the various preset voices. There are a variety of ways to call them up, as follows:



- Spin the JOG dial back and forth.
- Press the INC and DEC buttons.
- Use the data entry KEYPAD to punch in a 1-, 2-, or 3-digit number (between 1 ~ 128), followed by ENTER.

As you choose the different sounds, the voice number and name on the screen will change accordingly. When you find a voice you like and want to assign it as the Instrument voice of Track 1 of the multi, you do not have to perform any specific execute operation all you have to do is leave that particular sound selected and then simply press another TRACK button, and assign an Instrument voice to the next track in the same way.

Thus, it is simple to set up Instrument voices in a song multi quickly: Choose a track, select a voice, choose another track, select another voice, and so on. It is just as simple to select the various parameters and adjust their settings for each track. For example, if you position the cursor over the Voice Volume section of a mixer track and adjust its level, simply pressing another TRACK button will cause the cursor to jump to the Voice Volume of the new track. Also, the cursor will remain wherever you leave it as you jump from function to function.

***NOTE:** As you move around within the multi assigning Instrument voices to tracks, adjusting a pan position, tweaking a System Effect Send level, etc. the parameter setting changes you make will be entered as you make them, without having to perform a specific execute operation to lock these settings in. Sometimes you may want to revert to a previous setting of the value you just changed. In such a case, pressing the CANCEL button before performing any other function will retrieve the previous parameter value. You should always store multis you want to keep into song memories, using the Store Mode, before selecting any other song multi. Also, you should always save your multis and other important data to floppy disk.*

SONG PLAY & VOICE PLAY

The Instrument voices you hear in Song Multi Play Mode also have digital effects, such as reverb and chorus, and other performance related parameters assigned to them which define the currently selected multi.

As you work, sometimes it will be necessary for you to single out a specific voice and hear it without any System Effects or other multi parameter settings applied to it. To do this, you must switch into Voice Mode.

To switch into Voice Mode, press the VOICE button in the Mode section of the panel, located just to the left of the LCD. The Voice Play screen will appear.



This screen indicates that the W5/W7 is in Voice Play Mode. Within this mode you can select the various instrument sounds precisely the same way as in Song Play mode using the JOG, INC/DEC, or the KEYPAD (i.e., punch in a number between 1 and 128 followed by ENTER). You can still change Instrument tracks from within Voice Play Mode. As you do, the voice name and number on the screen will change accordingly.

The two-letter abbreviation preceding the voice name is the Voice Category code for the currently selected voice. The individual voices are organized into 21 Voice Categories, or groups, for easier access.

—	No Assign		
Pf	Piano	Ld	Synth Lead
Cp	Chromatic Percussion	Pd	Synth Pad
Or	Organ	Fx	Synth Sound Effects
Gt	Guitar	Et	Ethnic
Ba	Bass	Pc	Percussive
St	Strings/Orchestral	Se	Sound Effect
En	Ensemble	Dr	Drums
Br	Brass	Sc	Synth Comping
Rd	Reed	Vo	Voice
Pi	Pipe	Co	Combination

NOTE: In Voice Mode the Voice Category will appear to the left of the voice name, and in Song Mode it will appear just below the track volume section in the mixer screen. You can assign a Voice Category to your own voices in Voice Edit Mode.

NOTE: When the voice bank is set to off, no Voice Category code will display.

From within Voice Play or Song Multi Play, you can call up voices via the Voice Directory. Press [F8], the function key located directly beneath the abbreviation Dir at the lower right of the screen. A subpage that displays the voices in groups of eight will overlay onto the Voice Play screen.



NOTE: When switching back to Song Play Mode from Voice Play Mode, the Voice Play settings (i.e., the voice in its original state) will be maintained for that specific track. To restore the original multi setting for the track, you must switch to another song and then back again.

From within the Voice Directory you can select voices with the JOG, the CURSOR keys, INC/DEC and the KEYPAD. As you scroll through the voice list the display will advance accordingly. To return to the Voice Play screen, simply press EXIT.

SELECTING VOICE BANKS

The sounds you have been selecting in Song Play and Voice Play are stored in the GM voice bank, indicated by the letter G appearing immediately to the left of the three-digit voice number. These preset General MIDI sounds were programmed at the factory and stored in ROM (Read Only Memory) and therefore cannot be overwritten; however, they can be edited in Voice Edit Mode and then stored in the Internal voice bank RAM (Random Access Memory) by Store Mode.

The W5/W7 has a total of 10 separate voice banks. Eight of these are provided as standard features, while two of them are available as optional ROM memories that you can purchase separately and plug into the W5/W7's logic board via a special access located on the bottom of the instrument.

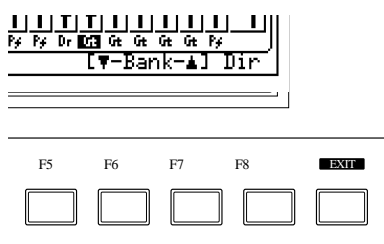

To choose the different voice banks, press function keys [F6] and [F7], located directly beneath the [Bank-Dir] display at the lower right of the screen. The letter P will change according to the particular voice bank selected, and will flash on and off, indicating that you need to press ENTER (or rotate the JOG or press INC/DEC) to lock in the voice bank you want.

The various voice banks are organized according to the type of instrument sounds that are in them i.e., by normal voices (voices with pitched sounds) or drum voices (voices with assorted percussion sounds). Whether the voice bank is a normal or a drum voice bank is indicated by a one- or two-letter abbreviation code, respectively, which appears immediately to the left of the voice number. Following is a list of the various voice banks, along with abbreviation codes and descriptions:

NORMAL VOICES	(G) GM PRESET VOICE - 128 ROM sounds preset according to the General MIDI standard, which cannot be overwritten.
	(P) PRESET VOICE - 128 ROM sounds preset at the factory, which cannot be overwritten.
	(I) INTERNAL VOICE - 128 RAM user memory locations which have voices stored in them when shipped from the factory, but can be overwritten when storing your own original normal voices, and will be retained in memory even when the power is turned off.
	(S) SONG VOICE - 128 RAM user memory locations for storing GM, Preset or Internal voices used in a particular song or multi. Song voice banks—each holding 128 normal voices for each song—can be saved to and loaded from floppy disks via the disk drive. Song voices will not be retained in memory when the power is turned off.
	(E) EXTERNAL VOICE - Additional ROM voices available as an option. <i>NOTE: The "E" will not display unless the optional Expansion Wave/Voice Board memory upgrade package is installed.</i>
DRUM VOICES	(GD) GM PRESET DRUM VOICE - 8 ROM drum sets, each with dozens of sounds arrayed on the keyboard, preset according to the General MIDI standard, which cannot be overwritten.
	(PD) PRESET DRUM VOICE - 2 ROM drum sets, each with dozens of sounds arrayed on the keyboard, preset at the factory, which cannot be overwritten.
	(ID) INTERNAL DRUM VOICE - 2 RAM user memory locations for storing your own original drum voices, which will be retained in memory even when the power is turned off.
	(SD) SONG DRUM VOICE - 2 RAM user memory locations for storing GM, Preset or Internal drum voices used in a particular song or multi. Up to 16 Song drum voice banks—each holding 2 drum voices—can be saved to and loaded from floppy disks via the disk drive. Song drum voices will not be retained in memory when the power is turned off.
	(ED) EXTERNAL DRUM VOICE - Additional ROM drum sets available as an option. <i>NOTE: The "ED" will not display unless the optional Expansion Wave/Voice Board memory upgrade package is installed.</i>

For more information about voices and elements, please refer to the *W5/W7 Technical Information* booklet (supplied separately).

REALTIME CONTROL

The W5/W7 has a number of controllers and control functions that can be used for realtime performance control. Some, such as the pitch bend wheel, have a single function, while others can be set to control a wide range of parameters as you play, including amplitude and pitch modulation, filter modulation, effect parameters like stereo panning, and others.

Each voice has its own completely independent set of controller assignments, so any assignments you make using the appropriate Voice Edit Mode functions will apply only to the current voice.

● PITCH WHEEL

Rolling the pitch wheel forward will raise the pitch of notes played on the keyboard, while rolling it backward will lower the pitch. The pitch bend wheel is automatically self-centering so it will always return to center position (normal pitch) when released.

● MODULATION WHEEL

Rolling the modulation wheel forward will increase the depth of the type of modulation set for the currently selected voice. The modulation wheel will stay wherever you position it, so you can set it to any position that produces the desired modulation effect and leave it. You can use the modulation wheel to control pitch, amplitude, and frequency modulation, as well as envelope generator bias and filter cutoff frequency. (For more information, see Voice Edit Mode, Controller function, page 123.)

● CONTINUOUS SLIDER

The continuous slider (CS) is assignable to just about any parameter, including reverb, chorus depth or speed, filter cutoff frequency plus other parameters that produce a useful realtime sound variation. (For more information, see Utility Mode, Controllers function, page 147.)

***NOTE:** Changes made by the CS while playing in the voice or song modes are not stored by the W5/W7.*

● FOOT CONTROLLER

An optional Yamaha FC7 or FC9 foot controller plugged into the rear panel foot controller jack can be assigned to control amplitude modulation, pitch modulation, frequency modulation, envelope generator bias depth and filter cutoff frequency depth. (For more information, see Voice Edit Mode, Controller function, page 123.)

● FOOT VOLUME

An optional Yamaha FC7 or FC9 foot controller plugged into the rear panel foot volume jack can regulate the overall volume of the W5/W7. (For more information, see Utility Mode, Controllers function, page 147.)

● FOOT SUSTAIN

An optional Yamaha FC4 or FC5 foot switch plugged into the rear panel sustain jack can act as a sustain pedal. You can assign the expression level limit. (For more information, see Voice Edit Mode, Controller function, page 122.)

● **KEYBOARD VELOCITY SENSITIVITY**

The W5/W7 s keyboard responds to attack pressure (or speed) as you play, thus permitting control over nuance and expression as you play. (For more information, see Utility Mode, Velocity function, page 145.)

● **KEYBOARD AFTERTOUCH**

Keyboard aftertouch response is most frequently used for vibrato control, i.e., the harder you press the keys after the initial attack, the more vibrato is applied. This makes it possible to control vibrato without having to remove one hand from the keyboard to use the modulation wheel. For the same reason, aftertouch is also often used for pitch control. Many of the voices provided with the W5/W7 have preset aftertouch functions, but you can assign aftertouch to control pitch, amplitude, and frequency modulation, as well as envelope generator bias and filter cutoff frequency depth. (For more information, see Voice Edit Mode, Controller function, page 122.)



LOADING & PLAYING THE DEMO

Before you dive deeper into the many features of the W5/W7, you might enjoy listening to one or more of the demonstration songs by loading song data into the sequencer from the Factory Set & Demonstration disk provided with the instrument. This will give you an idea of the powerful potential of the W5/W7's programming capabilities. It will also give you a brief overview of some of the disk options and song playback features.

LOADING THE DEMONSTRATION SONGS

Following is the procedure for loading and playing the demonstration songs:

1. INSERT THE FACTORY SET & DEMONSTRATION DISK

Insert the disk into the floppy disk drive. (NOTE: Make sure the label of the disk is facing upward, and be sure to put the end with the sliding disk shutter into the disk drive slot first.)

2. ENTER DISK MODE

Press the DISK button in the Mode section. The screen will display the various Disk Mode functions.

3. CHOOSE LOAD FROM DISK

Using the CURSOR keys or the JOG dial, position the cursor at Load From Disk and press ENTER. (You can also directly access the load function by pressing function key [F4], located directly beneath the word Load at the bottom of the screen.)

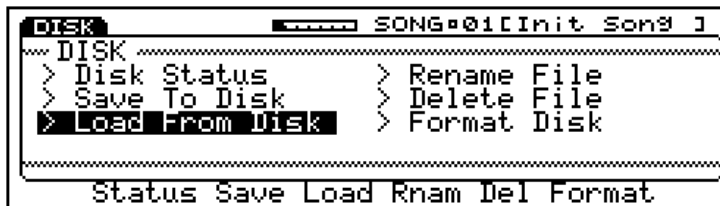

The various file types All, 1 Song, 1 Song + Voice, ESEQ/SMF, Voice will appear on the display.

4. CHOOSE ALL DATA

Now position the cursor at All Data and press ENTER (or press function key [F2], located beneath the word All at the bottom of the screen). The Load from Disk/All Data screen will appear.



NOTE: Loading the demonstration data overwrites the multi settings and sequencer data in the destination song multi locations, so if you have any important music data you don't want to lose, make sure it is safely saved to disk before loading the demonstration data.

NOTE: The entire memory bank of 16 songs can be saved at once into one file on a floppy disk, and then loaded back into the W5/W7. The number of files a floppy disk can hold depends on how large the file is i.e., longer, more complex songs will naturally take up more disk space. Within the Load from Disk/All function, you can press [F8] (Dir) to view the File Directory of the All Data type files currently on the inserted disk. You may also select a file and execute the loading operation from within the File Directory.

5. LOAD THE DEMONSTRATION SONGS

Press ENTER and the W5/W7 will give you a chance to change your mind, asking Are You Sure? . Press DEC to abort the operation, or press INC and the demonstration songs will begin loading. As they do, the screen will display the Executing message. When the loading operation is finished, the Completed! message will appear briefly before returning to the previous display.

6. SELECT A DEMONSTRATION SONG

Before you can play the demonstration song you must return to Song Play Mode. Press SONG in the Mode section on the panel to leave Disk Mode and return to Song Play Mode.

Before you can select a demonstration song, you must switch to the Song Sequence Play function. Press function key [F2] (Seq) and the Song Sequence Play function screen will appear.

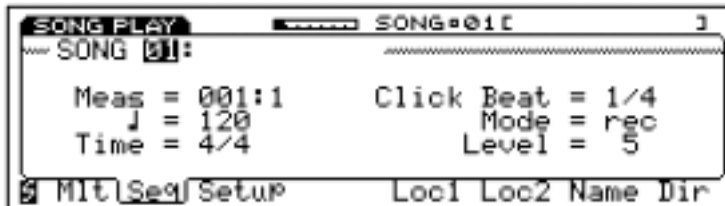

Position the cursor over the Song number and press INC/DEC (or use the JOG) to select a song.

7. PLAY THE DEMONSTRATION SONG

In Song Multi Play Mode, the TRACK buttons should indicate which tracks have sequencer data in them. Green Track buttons will signify that there is data in the track. (The red Track button is the currently selected track.) Unlit TRACK buttons signify that there is no data in the track.

Press the RUN button in the Sequencer section on the panel and the song will begin playing.

8. EJECT THE DISK

When you've finished loading the demonstration songs, press the eject button on the disk drive to eject the Factory Set & Demonstration disk. Store the disk in a safe place for future reference.

NOTE: the sequencer will not run when you are in Disk, Utility, Song Edit, or Song Job modes.

NOTE: To access the Song Directory and view a list of the songs loaded into the W5/W7, press [F8] (Dir). Positioning the cursor over a song name in the list, then pressing ENTER will select the song. Likewise, you could punch in the song number on the KEYPAD, followed by ENTER, to select a song.

NOTE: If you want, you can play along with the demo. Just press a green TRACK button to play on top of one of the parts, or press an unlit TRACK button to play with an Instrument voice not used in any of the parts. If you want to stop playback before the song is finished, press the STOP/TOP button once. To resume play from that point, press RUN again. To reset the song at the first measure, or the top of the song, press STOP/TOP twice. Then pressing RUN again will start the song from the beginning. You can also fast-forward and rewind through the song as it plays, using the SHUTTLE dial.

EXPLORING SONG PLAYBACK OPTIONS

As the song plays, you might want to explore some of the various playback options like adjusting instrument volumes or stereo panning, soloing instruments, changing the tempo and others.

NOTE: Any changes you make will be reset when you restart the song from the top, since all voice selection and other performance event data is programmed in the sequence.

● SELECTING TRACKS AND ADJUSTING PARAMETERS

After loading the demonstration song data and choosing a demonstration song number in the Song Sequence Play function screen, press [F1] (Mlt) to return to the Song Multi Play screen, which displays the sound mixer.

TRACKSELECT - The TRACK SELECT button (located on the panel just to the left of the 16 TRACK buttons) will be green. The 16 TRACK buttons will be either green, red or unlit. (Green indicates that there is data in the track. Red indicates the currently selected track. An unlit button indicates that no data is recorded in the sequencer track.)

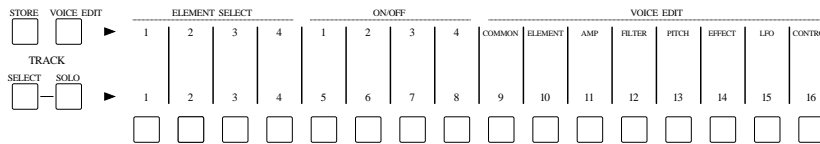

At this stage, since the cursor should be positioned at the Voice Category section of the mixer, spinning the JOG, or pressing the INC/DEC buttons, or entering a number on the KEYPAD followed by ENTER will change the Instrument voice. To make volume, panning or other adjustments to any given track as the song plays back, press the green TRACK button corresponding to the Instrument you want to work with; it will then change to red.

VOLUMEADJUST - To change the volume level of the instrument voice, first press the CURSOR-UP button once. The volume fader on the mixer will become highlighted. Now entering data will increase or decrease the instrument volume level; the graphic fader corresponding to the track on the mixer will change accordingly, and you will also see the numeric value of the volume level at the top right area of the screen change as well.



PANNINGADJUST - To adjust stereo panning, press CURSOR-UP once more. The pan pot on the mixer will become highlighted, and entering data will change the stereo pan position of the instrument.



NOTE: Use the CURSOR keys to move around to the various mixer sections, and the JOG or INC/DEC or KEYPAD to change parameter settings. Every time you press CURSOR-UP you access another mixer section, or feature block, in the selected track, whose parameters you can change. Pressing CURSOR-DOWN will step you back through each block until you end up back where you started at the Voice Select section. The CURSOR-LEFT and CURSOR-RIGHT keys will step you up or down through the 16 mixer tracks.

NOTE: Sequence note-on data for each track will indicate by blinking track buttons and Voice Category sections as the song plays back.

● SOLOING AND MUTING INSTRUMENTS

To isolate one or more Instrument voices as the song plays, press the SOLO button while the sequencer is running. The SOLO button will become red, indicating that the W5/W7 is in Solo Mode. Tracks with sequencer data in them will be either red (solo status), or green (mute status).

SOLO - After pressing the SOLO button the currently selected TRACK button will become red, indicating that it is in solo status. Also, it will be the only sound you hear. You can solo more than one track at a time.

MUTE - The other tracks with data in them will all be green, indicating that they are in mute status, or are turned off, and therefore you won't be able to hear them.

EXIT - To exit Solo Mode, simply press the TRACK SELECT button.

● CHANGING THE TEMPO

To change the tempo, press function key [F2], located immediately below the abbreviation Seq. The Song Sequence Play function screen will appear.

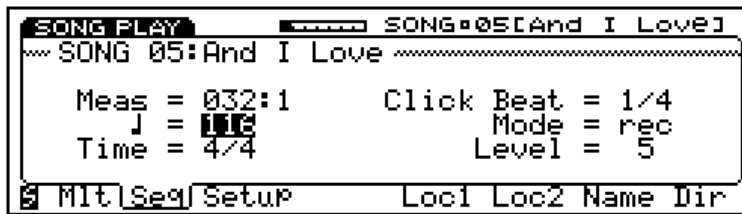

***NOTE:** The Song Sequence Play function also lets you choose a specific measure to start playing the song from, as well as choose different songs, name a song, or view the Song Directory. (For more information about the Song Sequence display when recording and playing back songs, see Song Mode, page 88.)*

While the sequencer is running, you can position the cursor over the musical note symbol (which represents tempo in quarter-notes per minute). Now you can change the tempo as the song plays, using the JOG, INC/DEC, or the KEYPAD.

PROGRAMMING

The various types of programming operations you can perform with the W5/W7 include setting up or defining a multi, voice editing, song recording and editing, and sound mixing. Each generate different types of data.

Practically, since you'll be performing the various programming operations according to your needs as you work, and since the W5/W7's flexibility lets you switch back and forth easily between the different modes, most of the time your main concern will be with the overall *sound*.

It is important to distinguish between the various types of data, however, since you must store them within the W5/W7 and save them to floppy disk in various ways.

Voice editing operations affect only voice data; song recording and editing operations affect only sequence data, and defining a multi and sound mixing operations affect only song multi data.

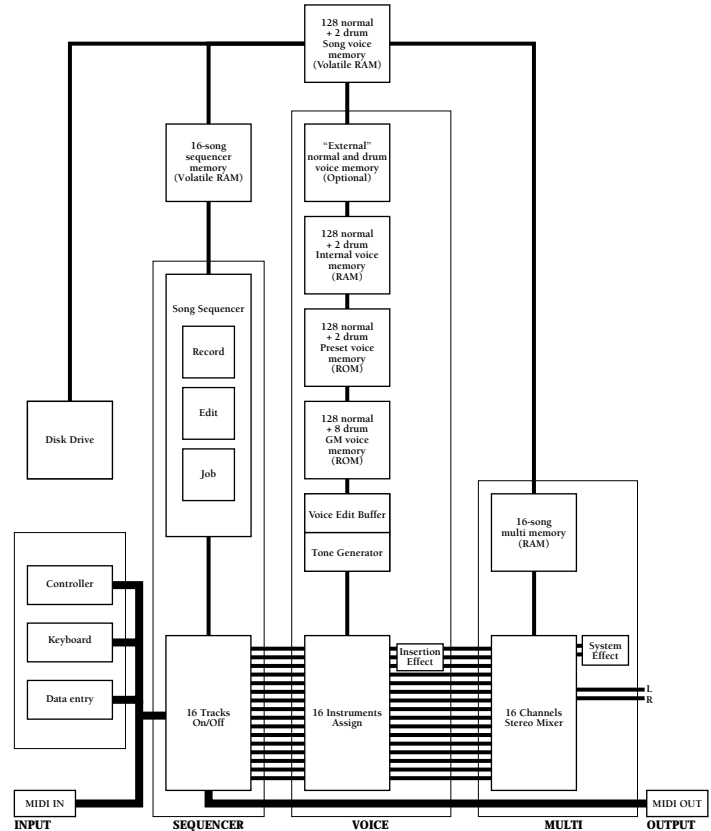

DEFINING MULTIS

The process of defining a multi is basically just making the various Instrument assignments, setting volume, panning, System Effect send levels and other parameters for each of the 16 tracks in the tone generator mixer. Every multi will take on the unique character of the work session.

A multi may be made up of multi settings only (i.e., all parameter settings), or multi settings plus song sequence data, or multi settings plus song sequence data and accompanying Song voice bank. You can store multis in any of the 16 song memory locations using Store Mode.

There are literally hundreds of parameters which make up a song multi, but only four basic steps involved in the process of creating and defining the multi, as follows:

1. SELECT A SONG MEMORY

In Song Multi Play Mode, press [F2] (Seq) to access the Song Sequence Play function, then select a song memory location (01 ~ 16). Then press [F1] (Mlt) to jump to the Song Multi function, which displays the mixer screen. *The currently selected song is the currently selected multi.*

2. ASSIGN INSTRUMENTS TO TRACKS AND DETERMINE MULTI PARAMETER SETTINGS

Press a TRACK button (1 ~ 16) on the panel (it will light red, indicating that it is the currently selected track in the multi) and assign an Instrument to it by selecting a voice from the Preset, GM, or Internal voice bank. Then determine the settings for each parameter (voice volume, pan, effects send levels, tuning, etc., plus keyboard, controller and MIDI assignments, etc.) as you work, whether you re recording a song sequence or structuring a performance setup. *All settings that you make in Song Mode define the multi.*

3. STORE THE MULTI IN A SONG MEMORY

When you re in the middle of an intense music session, it s a good idea to be in the habit of storing your song multi (and sequence) in a song memory bank. If you keep storing the multi periodically as you go, perhaps even storing the various noteworthy permutations of it in different song memories, you ll always have a back-up to resume from in a worst case scenario where an important multi is lost. Before storing your multi, give it a name within the Song Sequence Play function. To store the multi in a song memory location (01 ~ 16), press STORE followed by [F2] (Multi). Use the JOG, INC/DEC or KEYPAD to choose an internal song memory location, then press ENTER to execute the operation. To exit the Store Mode, press EXIT or any other desired MODE button. *Always store multis in a song memory location as you work.*

4. SAVE THE MULTI TO FLOPPY DISK

When you ve finished defining a multi, or even if you re in the middle of the process and have to stop, save the multi to floppy disk, so you can load it back into the W5/W7 the next time you need it and pick up from precisely where you left off. *Always save multis and other important music data to floppy disk.*

For more information about song multis, see Song Mode, page 74.

EDITING VOICES

The process of voice editing may be as simple as shortening the envelope decay for a single-element voice, or as complex as constructing a four-element voice with crossfades between elements and other interesting sonic tricks.

Voice editing can be done from within the multi (i.e., in Song Play Mode) or in Voice Play Mode. You can even edit a voice while the sequencer is running, which allows you to make sonic adjustments to a voice in context with other Instruments in the mix.

Although there are literally thousands of ways you can change the sound of a voice, there are really only three steps to Voice Editing, as follows:

1. SELECT A VOICE

Select a voice from a Preset, GM or Internal voice bank that is as similar to the sound you want to create as you can find. *It is also possible to initialize a voice, or set it to its most basic values, and build up a new voice from scratch (see page 110).*

2. EDIT THE PARAMETERS

Press VOICE EDIT. The Voice Edit button will light orange, as will some of the Track buttons, indicating that you are in Voice Edit Mode. Choose the various Voice Edit functions with the function keys [F1 ~ F8], and modify the parameters as you like. *As you edit a voice, pressing the VOICE EDIT button toggles back and forth between compare and edit status so you can listen to the sound of the voice you're editing in comparison with the sound of the original voice you started with.*

3. NAME AND STORE THE VOICE

When you're happy with the voice you've created, you must first give it a name by pressing [F1] (Com) to access the Common parameters function, followed by [F7] (Name). Then, press STORE to enter Store Mode and store the voice to an Internal voice bank location. *You must store the voice in an Internal voice bank memory before selecting any other voice or your newly created voice will be lost.*

In Voice Edit Mode, the 16 Track buttons double as voice editing functions. Tracks 1 ~ 4 serve as element selectors; Tracks 5 ~ 8 serve as element on/off switches; Tracks 9 ~ 16 serve as edit function selectors.

When you're inside a specific function parameter screen, you can jump to other functions by pressing SHIFT followed by the function key [F1 ~ F8] which corresponds to the abbreviation of the parameter name at the bottom of the screen of the parameter you want to access.

Although the basic editing operation for normal voices and drum voices are the same, there are some differences, due to the different natures and requirements of pitched sounds and percussion sounds.

Following is the basic normal voice edit screen, along with a brief overview of its various functions and parameters.



COMMON - Lets you access those parameters which affect the voice as a whole, including Voice Category, Voice Volume, Voice Name, and Initialize. (For details, see page 110.)

ELEMENT - Lets you access those parameters which affect each element as a whole, including Element Assign, Element Pan, Keyboard Velocity Limit, and Note Limit. (For details, see page 112.)

AMP - Lets you access those parameters which modify each element's volume in various ways, including output Level, Velocity Sensitivity and Amplitude Envelope Generator (AEG). (For details, see page 113.)

FILTER - Lets you access those parameters which modify each element's tone, including Cutoff frequency and Filter Envelope Generator (FEG). (For details, see page 115.)

PITCH - Lets you access those parameters which modify each element's pitch, including keyboard Scale, Tune, Note Shift, Velocity Sensitivity, and Pitch Envelope Generator (PEG). (For details, see page 117.)

EFFECT - Lets you assign an Insertion Effect to the voice and determine its parameters, as well as assign a send level for each of the three System Effects. (For details, see page 119.)

LFO - Lets you determine each element's Low Frequency Oscillator's Speed and Delay, as well as Amplitude Modulation, Frequency Modulation and Pitch Modulation ranges. (For details, see page 121.)

CONTROLLER - Lets you determine how each element responds to the various controllers, including Sustain, Pitch Bend, Aftertouch, Modulation Wheel, Foot Control and MIDI Control. (For details, see page 122.)

Following is the basic drum voice edit screen, along with a brief overview of its various functions and parameters.



COMMON - Lets you access those parameters which affect the voice as a whole, including Voice Category, Voice Volume, Voice Name, and Initialize. (For details, see page 125.)

KEY - Lets you assign a different element to each key on the keyboard, and set each element's Gate Time, Decay and Alternate Group, Tune, Volume and Pan, and send levels for each of the three System Effects. (For details, see page 125.)

EFFECT - Lets you assign an Insertion Effect to the voice and determine its parameters, as well as assign an overall send level for each of the three System Effects. (For details, see page 127.)

CONTROLLER - Lets you assign Expression Low Limit for the voice, as well as MIDI Control. (For details, see page 128.)

CREATING SONG SEQUENCES

The process of creating a song sequence may be as simple as recording a solo piano performance from start to finish, with no subsequent alterations, or as complex as a quantized dance floor techno marvel with a heavy groove and many instrument parts that starts as a four-measure riff and is copied, appended, transposed, note shifted and crescendoed into an eight-minute masterpiece!

With the W5/W7, a sequence is a piece of music inside a song memory with up to 16 different Instrument parts that s as short as you want or as long as internal song memory will allow. Depending on the size of your songs, you can store between one and sixteen songs in song memory at any one time while the power is on (but must be saved to floppy disk before the power is turned off). Therefore, a song sequence may be a complete song from start to finish, or it might be the A part of a song, while another is the B part, and still another is the C part for working on smaller chunks of a song at a time that you can play back in numeric order using the Next Song function to hear in context, or piece together in any way you like using Song Jobs to create one complete song sequence.

● SEQUENCER CONTROLS

When recording and playing back song sequences you will use the three controls in the Sequencer section on the panel.

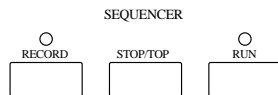

RECORD - For engaging the record standby mode.

RUN - For engaging recording (if the RECORD button has been pressed beforehand) or song playback after recording.

STOP/TOP - For stopping the sequence in either record or playback status. Pressing STOP/TOP once will stop the song at a specific location, from where you can continue recording or playback from that point by pressing RUN again. Pressing STOP/TOP twice resets the song to measure 1 for starting the song at the top the next time RUN is pressed.

● SONG SEQUENCING

There are three different types of operations involved in the process of song sequencing, which all work hand-in-hand to give you enormous music making power: *recording*, in either realtime (including overdub and punch-in) or step-time to input the basic sequence; *editing*, or inserting and changing specific music events inside measures; and song *jobs*, or inserting and deleting measures and performing other functions which involve single measures and groups of measures. The basic steps in song sequencing are as follows:

1. SELECT A SONG MEMORY AND DEFINE THE MULTI

From within Song Play Mode, press [F2] (Seq) and select a song memory location (01 ~ 16), then press [F1] (Mlt) to jump to the Song Multi function and assign Instrument voices to Tracks, so that when you record, all you have to do is press a TRACK button in preparation for recording each Instrument part. (For more information about selecting songs, see page 80. For more information about song multis, see page 74.)

2. RECORD THE SONG PARTS

After defining the multi, press [F2] (Seq) again, then press RECORD; this engages the record standby mode, where you determine quantizing, metronome click status, tempo, time signature, and realtime or step record status. After determining these, press the TRACK button assigned with the Instrument voice of the first part you want to record. Then press RUN to either perform the part in realtime or input the performance in step-time. When you're finished, press STOP/TOP. Then record other Instrument parts in the same way. (For more information about song recording, see page 85.)

3. EDIT SONG EVENTS

After recording, if you want to single out and change any event, or insert new events (including program change and other MIDI control messages) inside any measure in any track, press EDIT in the Mode section on the panel. Locate the specific event to change, or the place to insert an event, with the SHUTTLE, which lets you rewind and fast forward through the measures, or the CURSOR keys. Insert and change data with the JOG, INC/DEC and KEYPAD. (For more information about song editing, see page 91.)

4. PERFORM SONG JOBS

You can press JOB in the Mode section on the panel in order to perform operations like appending one song onto another, deleting and inserting measures, transposing specific tracks, modifying gate time and velocity, and others. (For more information about song jobs, see page 95.)

5. FINE-TUNE THE MIX

After creating a song sequence, you can have it play back in a loop, or chain more than one song sequence to play back one after another using the Next Song feature in the Song Setup function [F3] (Setup). By pressing [F1] (Mlt), you can make adjustments to volume levels and panning, System Effect send levels, and other parameters for each track in the multi. You can also assign completely different voices to tracks, or even switch into Voice Edit Mode while the sequencer is running and make modifications to specific voice parameters in context with the overall mix. When you're finished, you can dub your digital masterpiece to cassette, DAT, or other format simply by pressing RUN!

6. SAVE THE SONG TO FLOPPY DISK

When you've finished creating a song sequence, or if you're in the middle of the process and have to stop, save the song to floppy disk, so you can load it back into the W5/W7 the next time you need it and pick up from where you left off. *Always save important music data to floppy disk.*

FINE-TUNING THE STEREO MIX

The process of sound mixing may be as simple as slightly increasing a volume level on a single track, or as complex as completely overhauling the sound of a song with different voices and effects and drastic parameter setting changes.

Mixing happens within the multi, in Song Multi Play mode. To access the Song Multi Play function, from within Song Mode, press [F1] (Mlt). The Song Multi Play function screen, which displays a partial view of a 16 channel sound mixer, will appear.

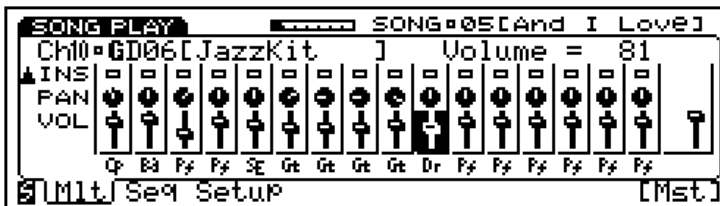

Mixing consists of selecting tracks, and selecting parameters and modifying parameter settings. Primarily you use the TRACK buttons or CURSOR-LEFT and CURSOR-RIGHT keys to select tracks, and CURSOR-UP and CURSOR-DOWN keys to select mixer sections, or parameters, and the JOG, INC/DEC and KEYPAD to change settings.

INSTRUMENT TRACK SELECT (1 ~ 16) - To select an Instrument track, press a TRACK button or use the CURSOR-LEFT and CURSOR-RIGHT keys. The Track button will light red, indicating that it is the currently selected track.

INSTRUMENT PARAMETER SELECT (Voice, Volume, Pan, Insertion Effect, System Effect Send 1 ~ 3, Tune, Note Shift, Pitch Bend Range) - To select a parameter within the track, use the CURSOR-UP and CURSOR-DOWN keys. (The screen advances or retreats accordingly as you step through each parameter.) The currently selected parameter will be highlighted, and the parameter name, plus a numeric value of its current setting, will be displayed in the upper right area of the screen. (For more information about the various parameters, see page 76.)

INSTRUMENT PARAMETER DISPLAY - To select parameters via the Instrument Parameter display, which lets you view all Instrument parameter settings for the selected track at once, from within the Song Multi Play function, press and hold SHIFT, then press [F1] (Inst). Use the CURSOR keys to select a parameter, and the JOG, INC/DEC or KEYPAD to modify parameter settings.

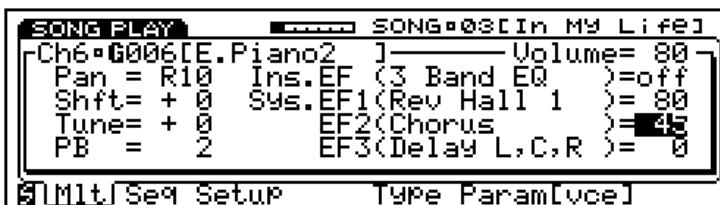

To return to the Song Multi screen, press EXIT or hold SHIFT and press [F1] (Mixer).

SAVING & LOADING

MUSIC DATA

You can save your songs, multis and voices to floppy disk in a variety of ways for easier file management and access. All saving and loading (and other disk management) operations are performed from within Disk Mode. The basic steps are as follows:

1. INSERT DISK AND ENTER DISK MODE

First insert a floppy disk into the disk drive, then press DISK in the Mode section on the panel.

2. SELECT A FUNCTION

From within Disk Mode, select the type of function you want to perform. If you want to save data to floppy disk, position the cursor over Save To Disk and press ENTER, or press [F3] (Save). If you want to load data from a floppy disk into the W5/W7, position the cursor over Load From Disk and press ENTER, or press [F4] (Load).



3. SELECT A FILE TYPE

From within Save To Disk or Load From Disk, you can select the specific type of file you want to save or load, respectively. File types include the following:

All, or multi, sequence and Song voice data for all 16 songs; 1 Song, or multi and sequence data for one song; 1 Song + Voice, or multi and sequence data plus Song voice data for one song; (ESEQ)/SMF, for saving a song in the Standard MIDI File Format-0 or loading a song which has been saved in either the Yamaha ESEQ format or the Standard MIDI File Format-0 or Format-1; and Voice, for saving the entire Internal voice memory bank, or loading an entire set of voices into the Internal voice bank or individual voices into Internal or Song voice memories.

NOTE: If the floppy disk is new, you will need to format it to be compatible with the W5/W7 operating system. If a disk is already too full to receive more data, you may want to delete some or all files on the disk to make space. These and other file management operations can be done within Disk Mode. For more information, see page 131.

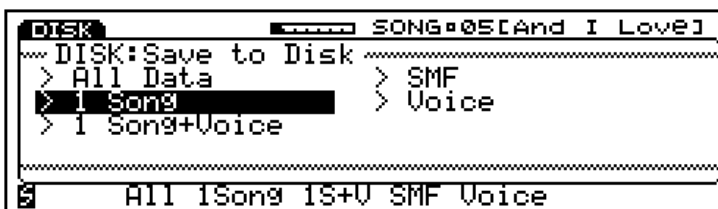

4. EXECUTE THE OPERATION

After selecting a file type, press ENTER, followed by INC to execute the operation, or DEC to abort the operation.

ORGANIZING & MANAGING DATA

If you're a prolific composer and/or voice programmer, the number of floppy disks lying around can mount up quickly. It's amazing how easy it is to lose track of what voices, mults and song sequences you've stored where. To wit, a well-organized data library is essential.

For general purposes, it's a good idea to store different types of files on different disks, i.e., keep voices on one disk, performance type mults on another, composing type mults on another, and sequences on another. Or you might want to keep all multi, sequence and voice data for a specific song or session together on its own disk.

It's a good strategy to store specific types of voices on different disks. For example, you might store a complete bank of Strings voices on one disk, so you can load them in to find just the right one without having to wade through a lot of different disks. This is where the Store Mode comes in handy, since you can store the desired voices for a song into its accompanying Song voice bank, in order to put your data together in one place when you need it.

It's helpful to prepare sets of Internal voice banks with good all round selections of instruments for practicing, or different genres of music or prepare mults for the same purpose and save them to disk for quick access.

Likewise, it's a good idea to prepare special disks for either upcoming performances or studio gigs, so you'll be ready to load and play within seconds of powering up. In such cases, you'll want to prepare voice data in entire banks, and perhaps even song data for more than one song, since loading each voice or song individually from your data library is not practical in time-limited situations.

Always label your disks clearly, with as much detail as possible, so that you'll be able to find exactly the file you need when you need it. And it's always a good idea to back your disks up at least once, preferably twice, and keep them in separate places, in case of a worst case scenario where one is defective or gets destroyed or lost somehow. That way, you can rest assured that you'll always have that important song or sound whenever you need it.

RELOADING THE FACTORY SET VOICE DATA

If you've initialized the Internal voice bank, or have replaced the original Internal voices shipped with the instrument, you can reload them at any time using the Factory Set & Demonstration disk that comes with the W5/W7.

Following is the procedure for reloading the preprogrammed data.

1. INSERT THE FACTORY SET & DEMONSTRATION DISK

Insert the disk into the disk drive. (NOTE: Make sure the label of the disk is facing upward, and be sure to put the end with the sliding disk shutter into the disk drive slot first.)

2. ENTER DISK MODE

Press the DISK button in the Mode section. The screen will display the various Disk Mode functions.

3. CHOOSE LOAD FROM DISK

Press the function key [F4] located directly beneath the word Load displayed at the bottom of the screen. The screen will display the various file types.

4. CHOOSE VOICE

Press the function key [F6] (Voice).

5. LOAD THE VOICES

Press ENTER to load the voices into the W5/W7.

6. EJECT THE DISK

When you're finished with the voice loading operation, press the eject button on the disk drive to eject the disk. Store the disk in a safe place in case you need to reload the voice data again in the future.

***NOTE:** Loading the preprogrammed voice data overwrites any other data that is in the W5/W7's memory, so make sure all your important music data is saved to floppy disk before loading the operation.*

INTEGRATING INTO A MIDI SYSTEM

The W5/W7 includes all the basic MIDI features which make it suitable for any role in an expanded electronic music system as the main keyboard controller at the heart of the system, or as a powerful support component in the system, or as a subordinate tone generator.

NOTE: Before connecting other MIDI devices, first make sure power switches for all devices are turned off and all power cables are unplugged. Follow all safety and other relevant instructions as printed in the owner's manual of the W5/W7 and other devices.

CONTROLLING OTHER MIDI DEVICES

The diagram below shows one of the simplest systems possible, where the W5/W7 is the master keyboard controller, and an external tone generator is connected to provide additional musical instrument sounds.

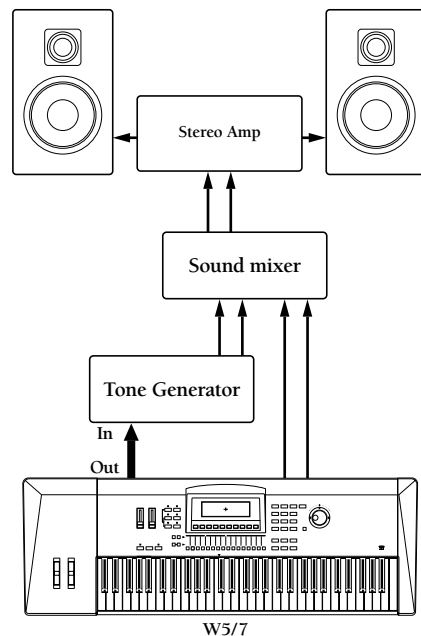

With this system only a single MIDI cable is required, with one end plugged into the W5/W7's MIDI OUT port and the other end plugged into the tone generator's MIDI IN port. Each device's stereo outputs are plugged into the two channels of an external audio mixer, which is in turn plugged into a stereo amp and speakers for monitoring.

With this system the W5/W7 can control the other device through MIDI note, control, program change and other messages, from both its keyboard and controllers as well as on-board sequencer.

MIDI SYSTEM COMPONENT

The diagram below shows a much more complicated system, configured with a personal computer operating as the main sequencer and system brain, the W5/W7 acting as the master performance input device, and three additional samplers or tone generators also connected.

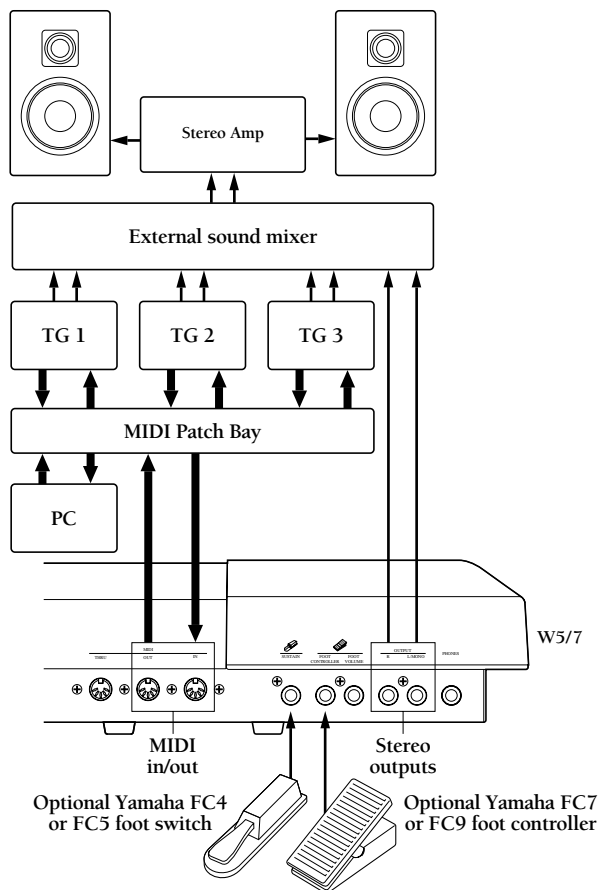

With this system a MIDI patch bay is required, and MIDI INs and OUTs of all devices are connected to it. Each device's stereo outputs are plugged into the two channels of an external audio mixer, which is in turn plugged into a stereo amp and speakers for monitoring.

With this system the W5/W7 can switch back and forth between master and slave roles, as designated by the sequencing (and or librarian) software installed on the personal computer.

SLAVING TO OTHER MIDI DEVICES

The diagram below shows a relatively simple system, where the W5/W7 is the master keyboard controller, and an external drum machine is acting as the master clock driving the W5/W7 s sequencer; the W5/W7 s sequencer and keyboard are in turn controlling an additional tone generator.

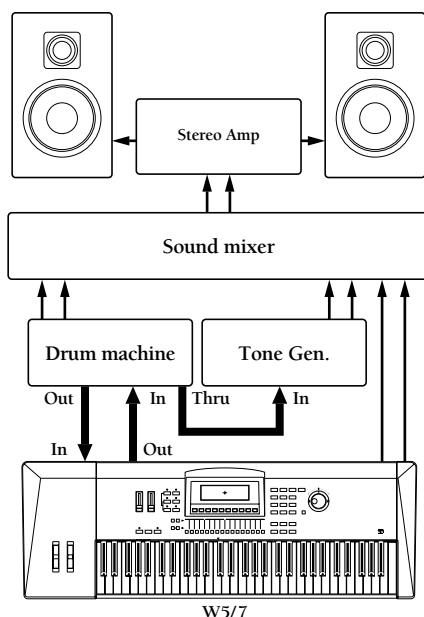

With this system the drum machine s MIDI OUT is connected to the W5/W7 s MIDI IN, and the W5/W7 s MIDI OUT is connected to the drum machine s MIDI IN. The tone generator s MIDI IN is connected to the drum machine s MIDI THRU. Each device s stereo outputs are plugged into the two channels of an external audio mixer, which is in turn plugged into a stereo amp and speakers for monitoring.

With this system the W5/W7 s sequencer clock can be controlled by the drum machine, or rhythm note data can be fed from the drum machine into the W5/W7 s sequencer. Any MIDI messages sent from the W5/W7 to the tone generator will be ignored by the drum machine.

1



FEATURE REFERENCE

SONG MODE

The W5/W7 s Song Mode is actually made up of four separate operating modes: Song Play, Song Record, Song Edit and Song Job. Jumping back and forth between each requires only the push of a MODE button on the panel, so it is easy to access any feature you need quickly as you work with rarely more than two or three clicks of a function key.

● SONG PLAY MODE

Song Play Mode is accessed by pressing the SONG button in the Mode section on the panel. From within Song Play Mode you can choose between Song Multi, Song Sequence Play and Song Setup functions, in order to *define* a multi by assigning an Instrument voice to each of the 16 tracks, determining sound mixer and other settings for the voice in each track (including volume, panning, effects, tuning, note shift and pitch bend), select any of the 16 songs in internal song memory, assign various MIDI settings including transmit channel, set the keyboard mode to Normal, Split, Layer or 4-Zone, set the sequencer clock to internal or MIDI sync, and determine other settings which affect the currently selected song multi.

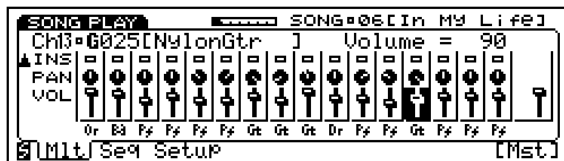

● SONG RECORD MODE

Song Record Mode is accessed by pressing the RECORD button in the Sequencer section on the panel from within the Song Multi function or Song Sequence Play function of Song Mode. From within Song Record Mode you can record a sequence in the currently selected song memory, either in real-time (including replace, overdub and punch-in recording) or step-time, as well as determine record parameters like time signature, tempo, quantize, click volume and others.

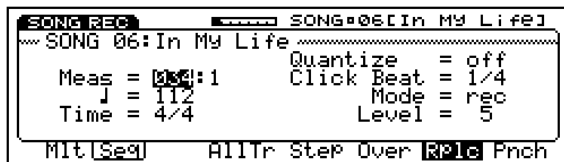

● SONG EDIT MODE

Song Edit Mode is accessed by pressing the EDIT button in the Mode section on the panel. From within Song Edit Mode you can view and edit individual note, controller and other MIDI events in the sequence, through three separate functions Data Change, which lets you modify the data, Data Insert, which lets you insert new data, and Graph, which lets you view notes as dots on a keyboard diagram plus a horizontal line which displays dots that indicate the position of note data in a measure.

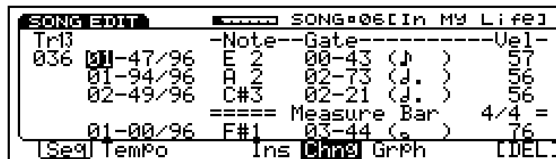

● SONG JOB MODE

Song Job Mode is accessed by pressing the JOB button in the Mode section on the panel. From within Song Job Mode you can make changes to the sequence that apply to all the data in one or more entire measures. Song Job operations include song copy, append and clear, track copy, clear and mix, measure copy, erase, create, delete and insert, data thin out, extract and chord sort, plus quantize, move clock, modify gate time, modify velocity, transpose, shift note, and crescendo.

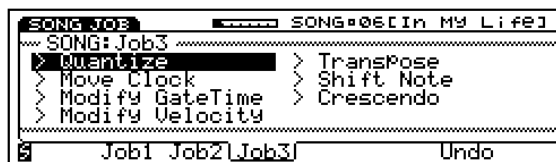

SONG MODE

SONG PLAY

In Song Play Mode you can access the functions which let you define a song multi, select and playback a song sequence, or designate various keyboard, MIDI and controller settings.

At power on, the W5/W7 always starts up in Song Play Mode, Song Multi function status, ready to play the Instrument voice assigned to Track 1 of Song Multi #01, as indicated by the Song Multi function screen, which displays the 16 channel stereo mixer.

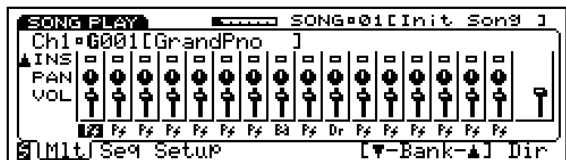

When the W5/W7 is shipped from the factory, all 16 song multis are undefined, i.e., every track in every multi is set to GM voice #001, except for Track 10 the drum voice track which is set to GM drum voice #01.

NOTE: At power on, the names and parameter settings of all 16 song multis in internal song memory remain as they were stored at the time of power off; however, song sequencer data and Song voice bank memory is always dumped at power off, and therefore must be reloaded when needed. Always remember to save your important song data to floppy disk before turning the power off!

● ENTERING AND EXITING SONG PLAY MODE

To enter Song Play Mode from another mode, simply press SONG in the Mode section on the panel. To exit song play mode, simply press another MODE button.

NOTE: When entering Song Play Mode from another mode, either the Song Multi function screen or the Song Sequence Play function screen will appear, depending on which one was selected the last time you were in Song Play Mode.

● ACCESSING A SONG PLAY FUNCTION

To access the Song Play functions, press the SONG button in the Mode section on the panel. Pressing [F1] (Mlt) accesses the Song Multi function. Pressing [F2] (Seq) accesses the Song Sequence Play function. Pressing [F3] (Setup) accesses the Song Setup function.

SONG MULTIPLAY - The Song Multi function lets you assign an Instrument voice to each of the 16 track buttons on the panel and designate all sound mixer and other settings for each track as well as for the overall mix including volume, panning and digital effects settings, plus tuning, note shift and pitch bend parameters and access the Voice Directory.

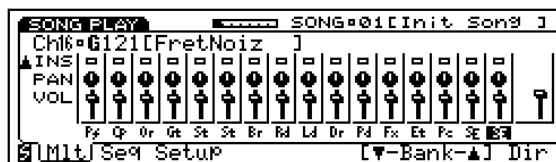

SONG SEQUENCE PLAY - The Song Sequence Play function lets you select any of the 16 songs in internal song memory, designate a specific measure for the sequence to start playing back from, adjust tempo, assign two measure-locate positions for instant access to the two most frequently accessed measures, name a song, and access the Song Directory.

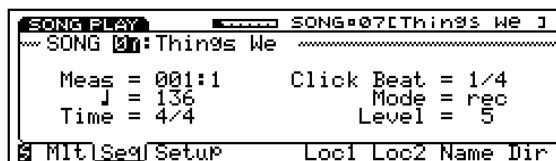

SONG SETUP - The Song Setup function lets you assign various MIDI settings including transmit channel, MIDI filter and control status, set the keyboard mode to normal, split, layer or 4-zone, set the sequencer clock to internal or MIDI sync, and determine a transposition value.



● PLAYING A SONG SEQUENCE

You can play back the currently selected song sequence from within either the Song Multi function or the Song Sequence Play function, by pressing the RUN button in the Sequencer section on the panel. You can also switch back and forth between the two functions and adjust parameter settings as the song plays. (NOTE: When you start the sequence again from the top, all settings will be reset according to the MIDI events as recorded in the sequence.)

SIMULTANEOUS NOTE CAPACITY - The W5/W7 can play up to 32 notes at once (either from the keyboard or the sequencer). During playback, any new notes which would exceed this number will be ignored.

NOTE: The sequencer will not run when the W5/W7 is in Song Edit, Song Job, Utility, or Disk Modes, nor will it run when the Song Setup function is selected. Likewise, when the sequencer is running in record or playback modes you cannot enter Song Edit, Song Job, Utility, or Disk Modes, nor can you select the Song Setup function.

● SELECTING TRACKS FOR PLAYBACK

Use the 16 memory select buttons to select the tracks for playback. The track button of each track with data in it will be lit in green. A red track button indicates the currently selected track.

● TRACK SOLO AND MUTE

When a song is playing back, pressing SOLO lets you isolate one or more Instrument voices as the song plays. The SOLO button will become red, indicating that the W5/W7 is in Solo Mode. In Solo Mode, tracks with sequencer data in them will be either red (solo status), or green (mute status).

SOLO - After pressing the SOLO button the currently selected Track button will become red, indicating that it is in solo status. Also, it will be the only sound you hear. You can solo more than one track at a time.

MUTE - The other tracks with data in them will all be green, indicating that they are in mute status, or are turned off, and therefore you won't be able to hear them.

EXIT - To exit Solo Mode, simply press the TRACK SELECT button.

SONG MULTI

The Song Multi function lets you assign an Instrument voice to each of the 16 Track buttons on the panel, plus designate all sound mixer and other settings for each track as well as for the overall mix including volume, panning and digital effects settings, as well as tuning, note shift and pitch bend parameters.

A song multi, also referred to as a multi, is the complete configuration of all MIDI, voice, mixer and other assignments and settings which determine the operating status of the W5/W7 within each song, or song memory location.

Depending on your particular needs for a setup, i.e., whether you are composing, practicing, recording, or performing live or are using the W5/W7 as a master keyboard controller or as a slave tone generator a song multi may be comprised of multi settings (i.e., all parameter settings), song sequence data, and accompanying Song voice bank, or it may be comprised of multi settings with accompanying Song voice bank, or it may be comprised of multi settings only.

A song multi can be stored in any of the 16 song memories in the W5/W7 and saved to floppy disk and loaded back in via the disk drive. And since each song memory also contains a Song voice bank into which you can store up to 128 normal voices and 2 drum voices copied from the Internal, Preset or GM voice bank (or the External voice bank if the optional Expansion Wave/Voice Board is installed). You can organize an entire bank of Song voices specifically for a single multi. This lets you keep all data for a multi together in one place, i.e., inside a single song memory. (NOTE: Sequence data and Song voice data are not retained in memory when the power is turned off. Always save your important song data to floppy disk before turning off the power.)

NOTE: Song multis can be saved to floppy disk and loaded back into the W5/W7 in various ways, including all 16 songs with accompanying Song voice banks, one song only, and one song with accompanying Song voice bank. (For more information on saving to and loading from disk, see Disk Mode, page 131.)

● DEFINING A SONG MULTI

There are literally hundreds of parameters which make up a song multi, but only four basic steps involved in the process of creating and defining the multi, as follows:

1. SELECT A SONG MEMORY

In Song Multi Play Mode, press [F2] (Seq) to access the Song Sequence Play function, then select a song memory location (01 ~ 16). Then press [F1] (Mlt) to jump to the Song Multi function, which displays the mixer screen. The currently selected song is the currently selected multi.

2. ASSIGN INSTRUMENTS TO TRACKS AND DETERMINE MULTI PARAMETER SETTINGS

Press a TRACK button (1 ~ 16) on the panel (it will light red, indicating that it is the currently selected track in the multi) and assign an Instrument to it by selecting a voice from the Preset, GM, or Internal voice bank. Then determine the settings for each parameter (voice volume, pan, effects send levels, tuning, etc., plus keyboard, controller and MIDI assignments, etc.) as you work, whether you re recording or structuring a performance setup. *All settings that you make in Song Mode define the multi.*

3. STORE THE MULTI IN A SONG MEMORY

The settings you make in the song multi will stay as is unless you choose another song memory location. Therefore, you must *store* your multi in a song memory. When you re in the middle of an intense music session, it s a good idea to be in the habit of storing your song multi (and sequence) in a song memory bank. If you keep storing the multi periodically as you go, perhaps even storing the various noteworthy permutations of it in different song memories, you ll always have a back-up to resume from in a worst case scenario where an important multi is lost. Before storing your multi, give it a name within the Song Sequence Play function. To store the multi in a song memory location (01 ~ 16), press STORE followed by [F2] (Multi). Use the JOG, INC/DEC or KEYPAD to choose an internal song memory location, then press ENTER to execute the operation. To exit the Store Mode, press EXIT or any other desired MODE button. *Always store multis in a song memory location as you work.*

4. SAVE THE MULTI TO FLOPPY DISK

When you ve finished defining a multi, or even if you re in the middle of the process and have to stop, save the multi to floppy disk, so you can load it back into the W5/W7 the next time you need it and pick up working from where you left off. *Always save multis and other important music data to floppy disk.*

NOTE: Once a multi has been stored in a song memory location, you can switch back and forth between other song memories and the multi settings will still be retained. The multi settings will even be maintained when the power is turned off. When the power is turned back on, the multi set-up data for all songs in the memory at power off will still be retained, and therefore the song name will still appear; however, the song sequence data and Song voice data will be gone. When storing the currently selected multi to another multi location, although multi settings will be stored in the new location, sequencer and Song voice data will not be transferred to the new location. Song sequence and Song voice data in one song memory location can be copied into other song locations in Song Job Mode (for details, see page 96.)

● ACCESSING SONG MULTI

To access the Song Multi function, from within Song Mode, press [F1] (Mlt). The Song Multi function screen, which displays a partial view of a 16 channel stereo sound mixer, will appear.

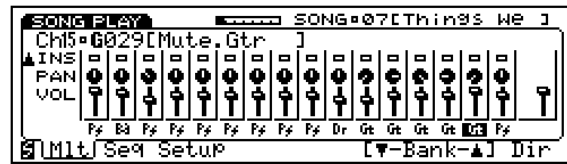

INSTRUMENT TRACK SELECT (1 ~ 16) - To select an Instrument track in the song multi, simply press a TRACK button, or use the CURSOR-LEFT and CURSOR-RIGHT keys. The Track button will light red, indicating that it is the currently selected track.

INSTRUMENT PARAMETER SELECT (Voice, Volume, Pan, Insertion Effect, System Effect Send 1 ~ 3, Tune, Note Shift, Pitch Bend Range) - To select a parameter within the track, use the CURSOR-UP and CURSOR-DOWN keys. (The screen advances or retreats accordingly as you step up and down through each parameter.) The currently selected parameter will be highlighted, and the parameter name, plus a numeric value of its current setting, will be displayed in the upper right area of the screen.

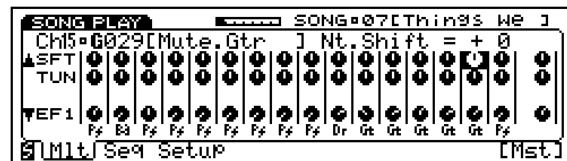

INSTRUMENT PARAMETER DISPLAY - To select parameters via the Instrument Parameter display, which lets you view all instrument parameter settings for the selected track at once, from within the Song Multi Play function, press and hold SHIFT, then press [F1] (Inst). Use the CURSOR keys to select a parameter.

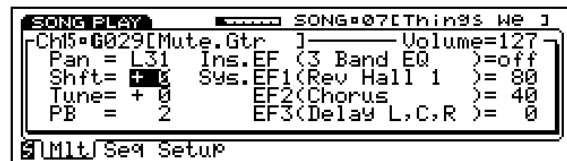

To return to the Song Multi screen, press EXIT or hold SHIFT and press [F1] (Mixer).

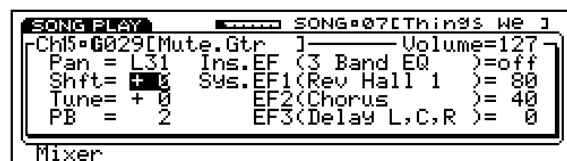

● **MOVING AROUND IN THE SONG MULTI**

The operations you perform in Song Multi Play Mode go hand-in-hand with the sound mixing process, since besides assigning voices, you'll be selecting tracks and accessing the sections, or blocks, on the mixer which contain the parameters volume, pan, System Effect sends, etc. whose settings you'll need to modify. Primarily you use the CURSOR-LEFT and CURSOR-RIGHT keys to specify the track whose parameters you want to access, and CURSOR-UP and CURSOR-DOWN to access the mixer sections, or parameters, and the JOG, INC/DEC and KEYPAD to change settings.

NOTE: Pressing a TRACK button will select the track, and automatically place the cursor within that track on the mixer. With that track still selected, you can use CURSOR-LEFT and CURSOR-RIGHT to specify another track, so that you can adjust parameters of another track that's playing back from the sequencer while you are performing a live part.

SONG MULTISCREEN - The Song Multi Play screen is designed to let you quickly access all functions and parameters in the multi, as well as give you ample visual feedback as you work. This is the W7's basic operating home screen.

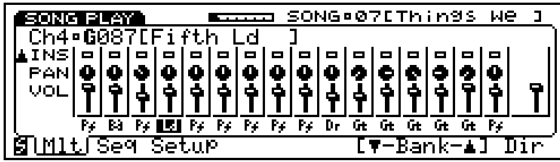

The sound mixer as displayed in the LCD is actually only a partial view, since the mixer is made up of several sections, and in effect extends beyond the top of the screen! The black up- or down-arrows at the far left side of the screen indicate that other parameters are accessible, by using the CURSOR-UP or CURSOR-DOWN keys.

The diagram below shows the mixer as it would appear in its entirety, complete with other visual information in and functions accessible from the Song Multi Play function screen.

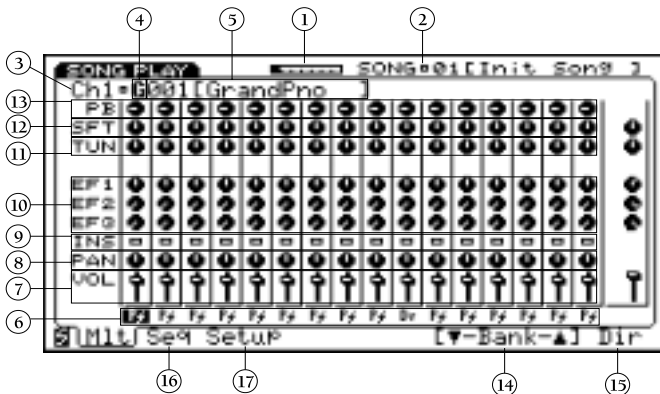

① **AVAILABLE MEMORY**

Displays a visual gauge of the available memory left. Used memory portion will be indicated in black. This is always displayed, regardless of selected mode or function screen.

② **SONG NUMBER AND NAME**

Displays the currently selected song memory number (01 ~ 16) and the song name. You cannot select a song from the Song Multi Play function screen. To select a different song, you must first press [F2] (Seq), and then select the song from the Song Sequence Play function screen.

③ **MIDI CHANNEL/INSTRUMENT TRACK (Ch 1 ~ 16)**

Displays the MIDI channel number of the currently selected track. Since each track of the 16 tracks corresponds with each MIDI input channel, this number represents both MIDI channel input number and selected track number.

④ **VOICE BANK (G, P, I, S, E*, GD, PD, ID, SD, ED*)**

Displays the one-letter (for normal voice) or two-letter (for drum voice) code that represents each voice bank. (* NOTE: E and ED will display only if the optional Expansion Wave/Voice Board has been installed.)

⑤ **VOICE NUMBER (001 ~ 128) / NAME**

Displays the currently selected voice number and name in the voice bank.

⑥ **VOICE SELECT (Voice Category)**

Voice Select is the first section, or stop, in each of the 16 mixer channels, represented graphically by the two-letter Voice Category code of the voice currently assigned to the track. The cursor must be positioned at Voice Select before you can choose a voice to assign to the track. To access Voice Select, use the CURSOR-DOWN key.

NOTE: You can modify a particular parameter for all tracks at once by holding down SHIFT while modifying the parameter. All value changes will be realtime to the setting in each track unless you use the KEYPAD, in which case all value will be entered as the same.

⑦ **VOICE VOLUME (0 ~ 127)**

Voice Volume is the second stop in each of the 16 mixer channels, represented graphically by a fader. It lets you make volume adjustments to the track. To access Voice Select, use the CURSOR-UP or CURSOR-DOWN keys.

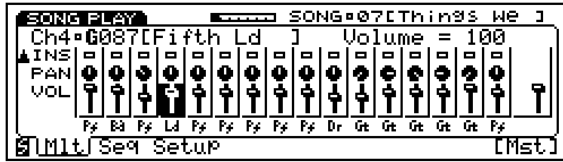

MASTER VOLUME (0 ~ 127) - When the cursor is positioned at Voice Volume you can access the Master Volume control, by pressing [F8] (Mst). The Master Volume lets you set the overall output volume of the sound mix. (You can also select Master Volume using the CURSOR-RIGHT key.)

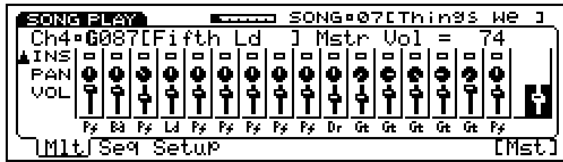

⑧ **VOICE PAN (L31 ~ R31)**

Voice Pan is the third stop in each of the 16 mixer channels, represented graphically by a pot. It lets you set the stereo pan position of the voice between the left and right outputs. L values position the voice in the left side of the stereo spectrum and R values position the voice in the right side of the stereo spectrum. A setting of 0 positions the voice straight-up center. To access Voice Pan, use the CURSOR-UP or CURSOR-DOWN keys. To input L values, press the DEC key or spin the JOG counter-clockwise, or punch in a number between 1 ~ 31 on the KEYPAD followed by [—] and then ENTER. To input R values, press the INC key, or spin the JOG clockwise, or punch in a number between 1 ~ 31 on the KEYPAD followed by ENTER.

NOTE: When the Insertion Effect is off, changing a pan setting while keys are pressed will not change the pan position for those notes.

NOTE: If you set the voice pan to the left or right side in Voice Edit Mode, then set the pan to the opposite side on the mixer, the voice may not be audible, or the result may be different from your intention.

⑨ **INSERTION EFFECT SWITCH (off, on)**

The Insertion Effect switch is the fourth stop in each of the 16 mixer channels, represented graphically by an empty square (off) or a solid square (on). It lets you apply an Insertion Effect to up to three Instrument

voices inside a multi. (NOTE: Insertion Effect type and parameter settings for any particular voice are determined in Voice Edit Mode, Effect parameters function. For more information, see page 119.) To access the Insertion Effect switch, use the CURSOR-UP or CURSOR-DOWN keys.

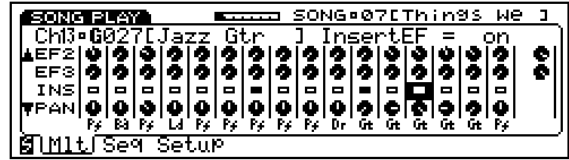

⑩ **SYSTEM EFFECT SENDS 1/2/3 (0 ~ 127, vce)**

System Effect Sends 3, 2, and 1 are the fifth, sixth and seventh stops, respectively, in each of the 16 mixer channels, represented graphically by pots. From within a System Effect Send you can determine the amount of signal level which gets sent to each System Effect, as well as designate the types of System Effects for the song multi, plus edit System Effect parameters. To access a System Effect Send, use the CURSOR-UP or CURSOR-DOWN keys.

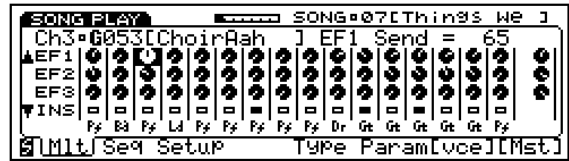

When the cursor is positioned over one of the three System Effect sends, you can also access several effects related parameters via the function keys.

VOICE- Pressing [F7] (vce) assigns the effect send value for the selected voice as designated in Voice Edit Mode, Effect parameters function. (For more information, see page 119.)

MASTER RETURN LEVEL - Pressing [F8] (Mst) lets you access the Master Return level, in order to set the overall return level for all tracks. (You can also access the Master Return using the CURSOR-RIGHT key.)

TYPE - Pressing [F5] (Type) lets you access the System Effect Type display, from where you can choose which type of effect is assigned to each of the three effect sends, as well as set the return level for each effect. (To return to the Song Multi function screen, press EXIT.)



PARAMETER - Pressing [F6] (Param) lets you access the System Effect parameter edit display, from where you can edit the individual parameters of the effect as selected in the System Effect Type display.

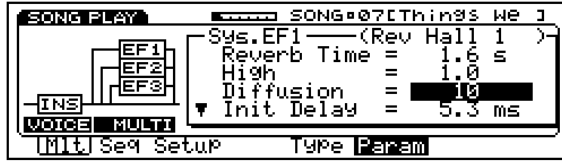

The black arrow pointing downwards in the lower left of the parameter display indicates that the list of editable parameters continues, which you can access using the CURSOR-DOWN key. To return to the Song Multi function screen, press EXIT.

NOTE: For a complete listing of System Effect Types and Parameters, see the *W5/W7 Technical Information booklet*.

⑪ **TUNE (-63 ~ +63)**

Voice Tune is the eighth stop in each of the 16 mixer channels, represented graphically by a pot. It lets you adjust the fine-tuning of the voice in steps of 1.17 cents. To access Tune, use the CURSOR-UP or CURSOR-DOWN keys.

MASTERTUNE - When the cursor is positioned at Voice Tune, pressing [F8] (Mst) lets you set the Master Tune, which affects overall fine-tuning for all tracks equally.

⑫ **NOTE SHIFT (-63 ~ +63)**

Note Shift is the ninth stop in each of the 16 mixer channels, represented graphically by a pot. It lets you determine the coarse-tuning of the voice in half-steps. To access Note Shift, use the CURSOR-UP or CURSOR-DOWN keys.

MASTERNOTESHIFT - When the cursor is positioned at Note Shift, pressing [F8] (Mst) lets you set the Master Note Shift, which affects overall note shift for all tracks equally.

⑬ **PITCH BEND RANGE (0 ~ 12)**

Pitch Bend Range is the tenth and final stop in each of the 16 mixer channels, represented graphically by a pot. It lets you designate the range the voice s pitch bends up or down by the Pitch Bend wheel. To access Pitch Bend Range, use the CURSOR-UP key.

VOICE- When the cursor is positioned at Pitch Bend Range, pressing [F7] (vce) assigns the pitch bend setting for the voice as determined in Voice Edit Mode, Control parameters function. (For more information, see page 122.)

⑭ **VOICE BANK SELECT**

When the cursor is positioned at Voice Select, pressing [F6] and [F7] lets you choose a voice bank. The one- or two-letter Voice Bank code will begin flashing, indicating that you must then press ENTER to lock in the desired bank. (For more information about voice banks, see page 25.)

⑮ **VOICE DIRECTORY**

When the cursor is positioned at Voice Select, pressing [F8] (Dir) accesses the Voice Directory, which displays the voices in the currently selected voice bank by list, eight at a time.



Within the Voice Directory you can select voices by scrolling through the entire list using the JOG, INC/DEC, or the CURSOR keys, or enter a specific number on the KEYPAD the list will advance accordingly. (You can also select voice banks from within the Voice Directory.) To return to the Song Multi screen, press EXIT. To jump directly to the Instrument Parameter display, press [F1] (Mlt) once.

⑯ **JUMP TO SONG SEQUENCE PLAY FUNCTION**

Pressing [F2] (Seq) lets you jump directly to the Song Sequence Play function.

⑰ **JUMP TO SONG SETUP FUNCTION**

Pressing [F3] (Setup) lets you jump directly to the Song Setup function.

NOTE: The Master Volume, Master Tune and Master Note Shift settings affect all songs.

NOTE: Multi settings for SMF song data will load into the W5/W7, but will not be retained at power off unless you first store it in a song location. In order to be sure that you don't accidentally lose your important multi settings, it is a good habit to periodically perform the Store Multi operation as you work.

SYSTEM EFFECTS

The W5/W7's three System Effects are powerful, studio quality stereo digital sound processing modules that you assign to a multi in order to provide extra depth and dimension to the overall mix. There are a total of 40 separate effects devices, or effect types, from which you can choose to assign to each of the three System Effect sends of the mixer. You can also access and edit the various parameters of each device.

System Effects

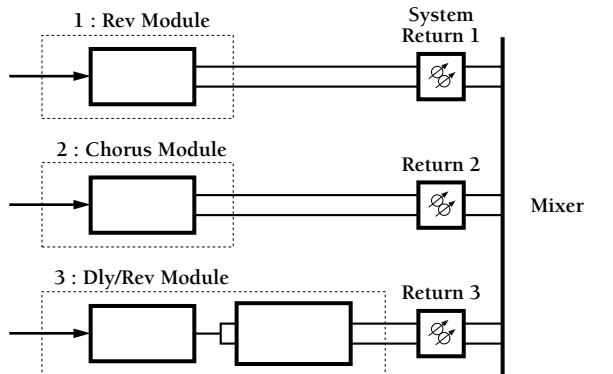

Each System Effect is routed to a specific processor module.

The types of effects that you can assign to each of the three System Effects depends on the particular send, as each System Effect send is routed to a specific DSP module. You cannot assign a hall reverb from system effect module 1 to a send 2.

SYSTEM EFFECT 1: REVERB MODULE - The types of effects in the reverb module includes halls, rooms, tunnel, plate and other reverbs, plus echo and various stereo delays.

SYSTEM EFFECT 2: CHORUS MODULE - The types of effects in the chorus module includes chorus, flanger, phaser, auto pan, rotary speaker, pitch change, Aural Exciter[®], and more.

SYSTEM EFFECT 3: DELAY/REVERB MODULE - The types of effects in the delay/reverb module includes various delays and reverbs, including gate, reverse and early reflection, as well as series combinations such as distortion/delay, EQ/reverb and others.

NOTE: For a complete listing of System Effect Types and Parameters, see the W5/W7 Technical Information booklet.

* Aural Exciter[®] is a registered trademark of and is manufactured under license from Aphex Systems Ltd.

The System Effect send levels for each Instrument track are located in the effects block section of the mixer, and are accessed and adjusted from within Song Multi Play Mode by positioning the cursor over any effect send (1, 2, or 3) pot in any track. The send level is simply the amount of volume of the Instrument voice that gets routed, or sent, to an effects device.

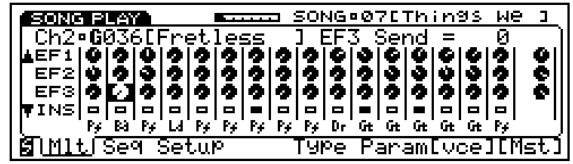

When you position the cursor over an effect send pot, you can adjust the send level using JOG, INC/DEC, or the KEYPAD. Also, the screen will display additional functions which you can access via the function keys.

TYPE - Pressing [F5] (Type) lets you assign which type of effect (i.e., which particular effects device) you want for each of the three System Effects, as well as the return level for each. The return level is simply the amount of volume of the effected signal which gets sent back, or returned, to the stereo mixer.

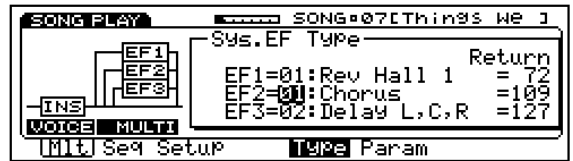

To assign an effect type to each System Effect, using the CURSOR keys, position the cursor over the value field of EF1, EF2, or EF3, and using JOG, INC/DEC (or the KEYPAD), select an effects device the names of each effect will appear to the right of the value field as you step or scroll through them.

To set the return level of each effect, position the cursor over the corresponding Return level field of the desired effect, and using the JOG, INC/DEC or the KEYPAD, adjust the value.

PARAMETER - Whichever type of effect the cursor is placed at in the System Effect Type display, above, determines the parameter list which will appear when you press [F6] (Param).

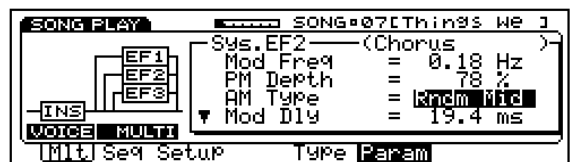

To modify the effect parameters, using CURSOR-UP and CURSOR-DOWN, scroll through the various parameters and select the one you want to adjust. (The inverted black arrow-head to the left of the display indicates that more parameters are on the list, out of view.)

(To choose another System Effect whose parameters you also want to adjust, press [F5] (Type) and do so from the System Effect Type display, as noted above. Then press [F6] (Param) again to modify the parameters.)

VOICE- Pressing [F7] (vce) assigns the effect send level as assigned in Voice Edit Mode. Via the Effect parameters function of Voice Edit Mode, you can access a System Effect display which lets you assign an effect send level for each of the three System Effects which become the Voice Send Levels for that particular voice. (NOTE: For more information, see Voice Edit Mode, Normal Voice, Effect parameters function, page 119, and Voice Edit Mode, Drum Voice, Effect parameters function, page 127.)

SONG SEQUENCE PLAY

The Song Sequence Play function lets you select any of the 16 songs in internal song memory, access a specific measure in the song, adjust tempo, assign two measure-locate positions, name a song, and access the Song Directory.

● ACCESSING SONG SEQUENCE PLAY

To access the Song Sequence Play function, from within Song Mode, press [F2] (Seq). The Song Sequence Play function screen will appear.

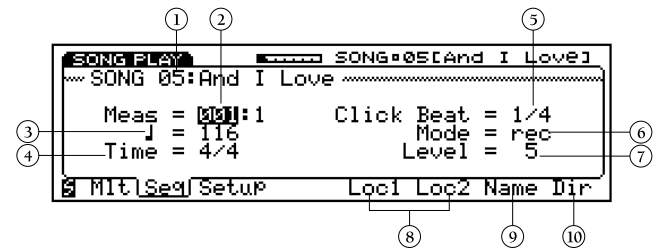

- ① **SONG SELECT (01 ~ 16)**
To select a song from song memory, position the cursor over the song number and use the JOG, INC/DEC, or KEYPAD. (NOTE: You can also select a song from the Song Directory. See page 81.)
- ② **MEASURE SELECT (001 ~ 999)**
To select a specific measure from which the song will begin playing when you press RUN on the sequencer, position the cursor over the measure number and use the JOG, INC/DEC, or KEYPAD.
- ③ **TEMPO SELECT (30 ~ 250)**
To set the tempo of the song in quarter notes per minute, position the cursor over the quarter note value and use the JOG, INC/DEC, or KEYPAD.
- ④ **TIME SIGNATURE SELECT**
For viewing the time signature of the song, as specified in Song Record Mode. (You cannot modify this setting in Song Play Mode.)
- ⑤ **CLICK BEAT SELECT (1/4, 1/8, 1/16)**
To determine the beat on which the metronome click will sound, position the cursor over the beat value and use the JOG, INC/DEC, or KEYPAD.
- ⑥ **CLICK MODE SELECT (off, rec, play, always)**
To determine in what status the metronome click will sound, position the cursor over the mode setting and use the JOG or INC/DEC.

OFF - Off means the metronome will not sound.

REC - Rec means the metronome will sound only during song recording.

PLAY - Play means the metronome will sound during recording and playback.

ALWAYS - Always turns the metronome on whether the sequencer is running or not, in order to set the tempo before recording or the tempo level.

⑦ **CLICK LEVEL SELECT (0 ~ 31)**

To set the volume level of the metronome click, position the cursor over the level value and use the JOG, INC/DEC, or KEYPAD.

⑧ **MEASURE LOCATE (Loc 1, Loc 2)**

To tag, or specify two different measures that you need to locate often, so you can jump directly to them with one touch, by pressing [F5] and [F6] even during playback.

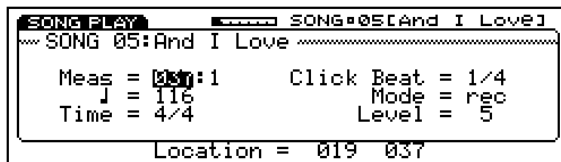

MEASURE LOCATE ASSIGN - To assign the measure locations, first position the cursor over Measure Select and enter the measure number you want to tag for [F5]. Then press the SHIFT key, and while keeping the SHIFT key held down, press [F5] the measure number will be assigned to it instantly. To tag a measure for [F6], simply repeat the process using the [F6] key.

⑨ **SONG NAME**

To give your song a 10-character name, press [F7] (Name). The Song Name screen will appear.



All the available characters will appear on the display. (A space can be entered by pressing [F3] ([SPC]).)

NAMING THE SONG - To name the song, position the inverted pointer over a letter space with [F4] and [F5], and choose a character with the JOG dial, INC/DEC buttons, or CURSOR keys. When you've entered the name, simply press EXIT to return to the Song Sequence Play function screen.

⑩ **SONG DIRECTORY**

To view the list of all 16 songs currently in memory, press [F8] (Dir). (The song names in the list are abbreviated, but the name of the song with the cursor positioned over it will display in all 10 characters in the upper right area of the screen.)

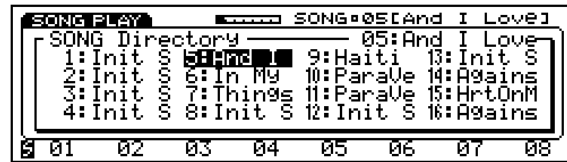

SELECTING A SONG - To select a song from within the Song Directory, use the KEYPAD, or position the cursor over a song name using the CURSOR keys and press ENTER. (You can also position the cursor using [F1] ~ [F8] to select songs 1 ~ 8, respectively, and SHIFT plus [F1] ~ [F8] to select songs 9 ~ 16, respectively.) After pressing ENTER, the W5/W7 automatically returns you to the Song Sequence Play function screen. To leave the Song Directory without selecting a different song, press EXIT or any Mode button on the panel.

SONG SETUP

The Song Setup function lets you assign various MIDI settings including transmit channel, MIDI filter and control status, as well as designate keyboard mode, set the sequencer clock to internal or MIDI sync, and set overall transposition.

● ACCESSING SONG SETUP

To access the Song Setup function, from within Song Mode, press [F3] (Setup). One of the Song Setup function displays will appear Playback Filter, Track Transmit Channel, Keyboard Setup, or Other Setup depending on which was selected the last time you exited the Song Setup function.

MIDIFILTER - Pressing [F5] (Filter) accesses the MIDI Filter, from where you determine how the W5/W7 responds to various MIDI data.



Through the MIDI Filter, the W5/W7 s internal sequencer can receive Aftertouch, Control Change and System Exclusive messages when these parameters are set to rec status. The W5/W7 s internal sequencer can send Bank Select, Program Change and Control Change messages when these parameters are set to play status. When a parameter is set to ignore status, the W5/W7 will not acknowledge these messages.

To select a MIDI Filter parameter, use the CURSOR-UP and CURSOR-DOWN keys. to change a parameter setting, use the JOG or INC/DEC.

TRACK TRANSMIT CHANNEL - Pressing [F6] (T.Ch) accesses the MIDI transmit channel display, from where you can turn MIDI transmit channels on and off, or assign the transmit channel for each W5/W7 track.

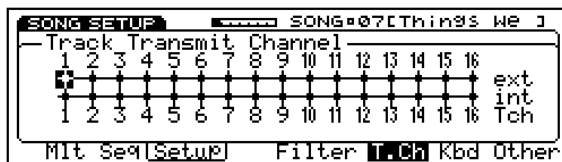

TRACK NUMBER (1 ~ 16) - The first line of information is a row of numbers which represent each track number, and therefore cannot be changed.

EXTERNAL ON/OFF (ext) - The second line of information represent the on/off switches for each track that determine whether W5/W7 MIDI data will be transmitted to external devices. A dot means the track is turned on, and a horizontal line means the track is turned off. To set External On or Off for a track, position the cursor over the field just below the number of the track you want to set, and use the JOG or INC/DEC.

INTERNAL ON/OFF (int) - The third line of information represents the on/off switches for each track that determine whether W5/W7 MIDI data will be transmitted to the internal tone generator. A dot means the track is turned on, and a horizontal line means the track is turned off. To set Internal On or Off for a track, position the cursor over the field just above the number of the track you want to set, and use the JOG or INC/DEC.

MIDI TRANSMIT CHANNEL (1 ~ 16) - The fourth line of information is a row of numbers which represent the MIDI channel the track is transmitting on. The MIDI transmit channel of each track can be changed freely. To change the MIDI transmit channel number, position the cursor over the transmit channel number field corresponding with the track whose transmit number you want to change, and use the JOG, INC/DEC or KEY-PAD.

NOTE: Changing a transmit channel affects the way tracks respond in Song Multi Play Mode. For example, if you change the transmit channel of Track 4 to MIDI channel 1, pressing the TRACK 4 button in Song Multi Play Mode will cause the cursor to automatically position itself at Track 1 within the mixer.

KEYBOARD SETUP - Pressing [F7] (Kbd) accesses the four keyboard setup modes, from where you determine whether the W5/W7 s keyboard will operate in Normal, Split, Layer, or 4-Zone modes.

To access one of the keyboard setup modes, use the JOG or INC/DEC.

NORMALMODE - In Normal Mode, the keyboard will play one voice at a time the currently selected track over the entire range of the keyboard. (NOTE: A small + plus sign on the keyboard represents middle C, or C3.)

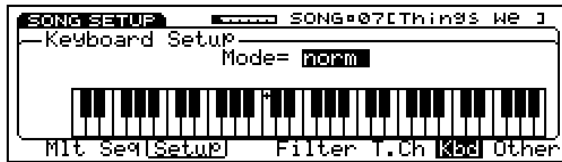

SPLITMODE - In Split Mode, the keyboard will play two voices at once, one track from the left side (Lower) of the designated split point, and another track from the right side (Upper) of the split point.

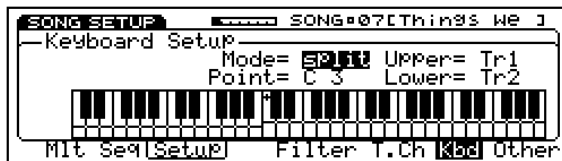

POINT - To designate the split point, position the cursor over Point and use the JOG or INC/DEC, or press a key on the keyboard while holding down [F7] (Kbd). (NOTE: The actual split point key will belong to the Upper region.)

UPPER/LOWER - To determine which voices will play in each region, position the cursor over Upper or Lower and assign a track (1 ~ 16) to it with the JOG, INC/DEC or the KEYPAD. Horizontal lines on the keyboard will indicate the range of each region.

LAYERMODE - In Layer Mode, the keyboard will play two voices at once, by specifying two tracks to play simultaneously.

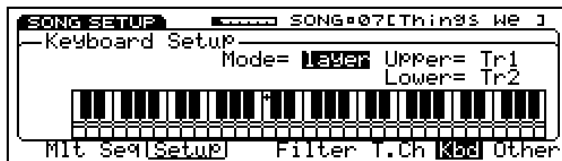

UPPER/LOWER - To determine which voices will play, position the cursor over Upper or Lower and assign a track (1 ~ 16) to it with the JOG, INC/DEC or the KEYPAD.

4-ZONEMODE - In 4-Zone Mode, the keyboard will play four voices at once, by specifying four different tracks to play simultaneously. You can set the note range and octave shift, as well as turn controllers on and off, for each zone track. (Horizontal lines on the keyboard will indicate the note range of each zone.)

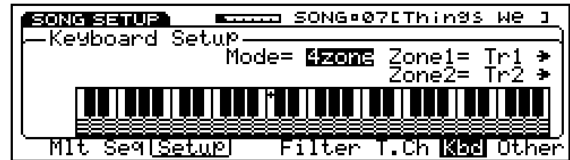

Only two zones are visible on the screen at a time. To access Zone-3 and Zone-4, use the CURSOR-UP and CURSOR-DOWN keys the screen will advance accordingly. To access the various parameters within each zone, use the CURSOR-LEFT and CURSOR-RIGHT keys.

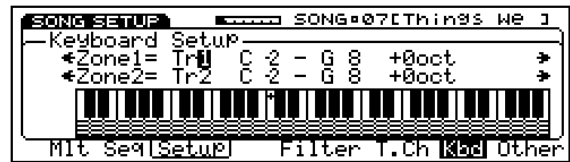

ZONE TRACK SELECT (1 ~ 16) - To assign a track to each zone, position the cursor over Zone (1 ~ 4) and use the JOG, INC/DEC, or the KEYPAD.

ZONE LOW LIMIT (C-2 ~ G8) - To assign the lowest note that will play in the zone, position the cursor over the first note parameter and use the JOG or INC/DEC, or press a key on the keyboard while holding down [F7] (Kbd).

ZONE HIGH LIMIT (C-2 ~ G8) - To assign the highest note that will play in the zone, position the cursor over the second note parameter and use the JOG or INC/DEC, or press a key on the keyboard while holding down [F7] (Kbd).

OCT (-3 ~ +3) - To shift the pitch of the zone up or down by up to 3 octaves, position the cursor over +0 oct and use the JOG, INC/DEC or the KEYPAD.

CONTROLLER ON/OFF - To determine which controller will be active in the zone, position the cursor over AT (aftertouch), PB (pitch bend), MW (modulation wheel), Sus (sustain), FV (foot volume), or FC (foot controller) and turn it on or off with the JOG or INC/DEC.

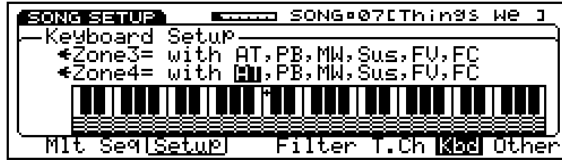

The abbreviation represents on status for each controller. Two dashes represent off status for each controller.

OTHERSETUP - Pressing [F8] (Other) accesses the Other Setup parameters, Next Song, MIDI Control, Sync and Transpose.

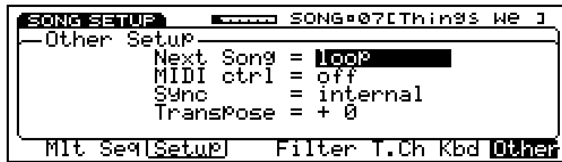

To select an Other Setup parameter, use the CURSOR-UP and CURSOR-DOWN keys. To change the parameter, use the JOG or INC/DEC.

NEXT SONG (off, loop, chain stop, chain play, chain continue) - Lets you play song sequences back in the numeric order of the song memory bank (1 ~ 16), i.e., consecutively, one after another, starting with the currently selected song. The Next Song setting determines whether or not the subsequent song will play, and under what condition.

Next Song is especially useful when you re composing a song and have located different parts of the song in different song memories. Ultimately you'll assemble all the parts into one song location, but before you get to that stage, Next Song lets you play the parts back one after another, without pausing, in order to hear them in the context of the entire song.

OFF - The selected song will stop at the end after playing back once.

LOOP - When the selected song reaches the last measure it will automatically return to the first measure and keep playing until the sequencer STOP/TOP button is pressed.

CHAINSTOP - When the selected song reaches the last measure it will stop, the subsequent song memory will automatically be selected and prepared for playback i.e., waiting for you to press RUN on the sequencer.

CHAINPLAY - When the selected song reaches the last measure the subsequent song memory will automatically be selected and begin playing from measure one, without a pause.

CHAINCONTINUE - When the selected song reaches the last measure the subsequent song memory will automatically be selected and begin playing from measure one, without a pause; however, any changes in mixer or other settings made during playback of the previous song will be maintained, i.e., the next song's own parameter offset settings will be ignored.

MIDI CONTROL (off, on) - For determining whether the W5/W7 will receive/transmit (on) or will not receive/transmit (off) the following types of MIDI messages: sequencer start, continue, stop reception and transmission; MIDI clock transmission; song position pointer reception.

SYNC (internal, MIDI) - For determining the timing source which will control the sequencer, i.e., whether the W5/W7's internal sequencer will run from its own clock or from an incoming MIDI sync signal.

INTERNAL - The W5/W7's own sequencer clock will determine the tempo.

MIDI - MIDI clock messages received at MIDI IN i.e., from an external MIDI sequencer or rhythm machine will determine the tempo.

TRANSPOSE (-63 ~ +63) - To set the overall pitch of the W5/W7 in half-steps, use the JOG, INC/DEC or the KEYPAD.

SONG RECORD

In Song Record Mode you can record a sequence in the currently selected song memory, either in real-time or step-time, as well as determine recording related parameters like time signature, tempo, quantize, click volume and others.

Realtime recording lets you record the different parts of a song as you would if using a multi-track tape recorder, i.e., one part after another *live*, with or without a click track to keep time to. Step recording lets you input each part one after another *one step at a time*, in accordance with note duration and other values which you can specify. The basic process of song recording is as follows:

1. SELECT A SONG MEMORY AND DEFINE THE MULTI

From within Song Play Mode, press [F2] (Seq) to access the Song Sequence Play screen, and select a song memory location (01 ~ 16). Then press [F1] (Mlt) to jump to the Song Multi function screen and assign Instrument voices to Tracks, so that when you record, all you have to do is press a TRACK button in preparation for recording each Instrument part.

NOTE: If the selected song number contains data, then first clear the song using the Clear Song function in Song Job Mode. (For information, see page 96.)

2. DESIGNATE REALTIME OR STEP STATUS

After defining the multi, press [F2] (Seq) again to return to the Song Sequence Play screen. Then press the RECORD button in the Sequencer section on the panel. The red LED above the RECORD button will light, and certain information in the screen will change, to indicate that the W5/W7 is in record standby mode.

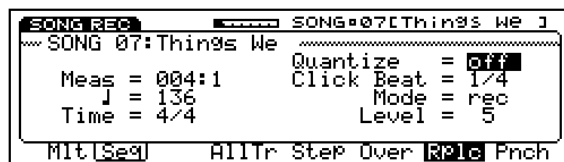

(Display for realtime recording.)

In record standby mode, the display changes to the Song Sequence Record function screen, which is basically the same as the Song Sequence Play function screen, except the Quantize parameter is also displayed, and the recording mode functions will appear above function keys [F4 ~ F8] to let you determine realtime or step record status.

3. RECORD THE SONG PARTS

In record standby mode, press the TRACK button of the track which contains the Instrument voice of the first part you want to record. Then press RUN to record the part. When you're finished, press STOP/TOP and the sequence will reset at the measure you started from. To record another part, simply repeat the process. (To playback the part, simply press RUN.)

4. SAVE THE SONG TO FLOPPY DISK

When you've finished recording a sequence, or even if you're in the middle of the process and have to stop, save it to floppy disk, so you can load it back into the W5/W7 the next time you need it and pick up from where you left off. (NOTE: Always save your song sequences to floppy disk before turning off the power. Sequence data is cleared from song memory at power off.)

NOTE: The various Song Job functions also provide valuable song creation tools. For example, you can build up parts of a song by using the Copy Measure function (for more information, see Song Job, page 98).

● ENTERING AND EXITING SONG RECORD MODE

To enter Song Record Mode from another mode, first press SONG in the Mode section on the panel, then press RECORD in the Sequencer section on the panel. The red LED over the RECORD button will light, and the Song Sequence Record function screen will appear, which lets you access all recording related functions and parameters. To exit Song Record Mode, press RECORD again, or press STOP/TOP, or EXIT, or SONG. (You can also jump directly to another mode from Song Record Mode, by pressing a MODE button on the panel.)

NOTE: You cannot enter the Song Record Mode when the W5/W7 is in Song Edit, Song Job, Utility, or Disk Modes, or in the Song Setup display.

● USING THE SEQUENCER CONTROLS

When recording and playing back song sequences you will use the three control buttons in the Sequencer section on the panel.

RECORD - Pressing RECORD once from within Song Multi Play Mode will engage the record standby mode, causing the red LED above the RECORD button to light. The LED will stay lit during the recording process.

RUN - Pressing RUN after engaging record standby mode will begin the recording process. Otherwise, pressing RUN in Song Multi Play Mode will play back the currently selected song. When in Run status during realtime recording, the LED above the RUN button will blink green on each beat and blink red on the first beat of each measure, until STOP/TOP is pressed.

STOP/TOP - During recording or playback, pressing STOP/TOP once will stop the song at a specific location. (You can continue recording or playback from that point by pressing RUN again.) Pressing STOP/TOP twice resets the song to measure 1, i.e., the top of the song.

● ACCESSING A SONG RECORD FUNCTION OR PARAMETER

To access the Song Record functions and parameters, press the SONG button in the Mode section on the panel, then press RECORD in the Sequencer section. This switches the W5/W7 into record standby mode, indicated by the red LED over the RECORD button, and the Song Sequence Record function screen.



① SONG (01 ~ 16)

Displays the currently selected song. (NOTE: You cannot select a song in Song Record Mode. To select a song, you must return to Song Play Mode and press [F2] (Seq) to access the Song Sequence Play function.)

② MEASURE SELECT (001 ~ 999)

To select a specific measure from which the song will begin recording when you press RUN on the sequencer, position the cursor over the measure number and use the JOG, INC/DEC, or KEYPAD. When the sequencer is running, the measure number will advance to show the number of the measure currently being recorded. In realtime record, the measure will count down two measures before the actual recording begins.

NOTE: A song can be as long as remaining internal memory will allow, even more than 999 measures. In such a case, since the measure number indicator will only accommodate a maximum of three digits, during recording and playback, when the 1000th measure point is reached, the measure number indicator will return to the beginning and continue counting.

③ TEMPO SELECT (30 ~ 250)

To set the tempo of the song in quarter notes per minute, position the cursor over the quarter note value and use the JOG, INC/DEC, or KEYPAD. When recording begins the cursor will automatically jump to the tempo value field. You cannot change the tempo during recording; however, you can change the tempo in Song Edit Mode. (For information, see Data Insert Tempo Track, page 94.)

④ TIME SIGNATURE

(1/4 ~ 8/4, 1/8 ~ 16/8, 1/16 ~ 16/16)

For selecting the time signature of the song before recording.

NOTE: The time signature can only be selected before recording. If no specific time signature is selected, then the default 4/4 time signature will automatically be specified. After recording, the time signature cannot be changed. (Likewise, if song data has been loaded into the sequencer, its time signature cannot be changed.) It is possible for a song to contain measures with differing time signatures throughout. Different time signatures can be created with the Create Measure feature in Song Job Mode. For more information, see Song Job, page 98.

⑤ QUANTIZE

(off, 1/32, 1/24, 1/16, 1/12, 1/8, 1/4, 1/2)

To determine the timing accuracy to which the notes you play will be corrected, position the cursor over the quantize field and use the JOG or INC/DEC. When quantization is turned off the notes you play will be recorded at the exact timing as they occur. When a quantization factor is selected, all notes you play will be moved to the nearest timing at the specified interval.

NOTE: When a quantization factor is designated for recording, all data is quantized, even controller parameters and pitch bend data. You may find it more convenient to record with quantization turned off, then apply a quantize factor in Song Job Mode, Quantize function (see page 100). When quantizing in Song Job Mode, only note data will be quantized.

⑥ **CLICK BEAT SELECT (1/4, 1/8, 1/16)**

To determine the beat on which the metronome click will sound, position the cursor over the beat value and use the JOG, INC/DEC, or KEYPAD.

⑦ **CLICK MODE SELECT (off, rec, play, always)**

To determine in what status the metronome click will sound, position the cursor over the mode setting and use the JOG or INC/DEC.

OFF- When off is selected the metronome will not sound.

REC- When rec is selected the metronome will sound only during song recording.

PLAY- When play is selected the metronome will sound during recording and playback.

ALWAYS- When always is selected the metronome will sound whether the sequencer is running or not, in order to set the tempo before recording, or to set the click level.

⑧ **CLICK LEVEL SELECT (0 ~ 31)**

To set the volume level of the metronome click, position the cursor over the level value and use the JOG, INC/DEC, or KEYPAD.

⑨ **ALL TRACKS**

To engage the All Tracks mode of Realtime Record, press [F4] (AllTr). The AllTr abbreviation will only display and can only be selected when one of the realtime recording functions is selected.

⑩ **STEP**

To designate Step Record, press [F5] (Step).

⑪ **OVERDUB**

To engage the Overdub mode of Realtime Record, press [F6] (Over).

⑫ **REPLACE**

To engage the Replace mode of Realtime Record, press [F7] (Rplc).

⑬ **PUNCH-IN**

To engage the Punch-in mode of Realtime Record, press [F8] (Pnch).

NOTE: The W5/W7 s sequencer can play a maximum of 32 notes simultaneously, which is sufficient for most sequencing situations. However, if you build up a large number of parts by overdubbing, you may exceed the 32-note maximum, and therefore some notes will not sound. In such a case, you will have to simplify certain parts.

NOTE: The W5/W7 s memory capacity is 416Kbytes, or 100,000 notes, which is sufficient for most sequencing situations. If there is a large amount of sequence data currently stored in memory, it may not be possible to record your song data. If you happen to run out of memory during recording, the error message Song memory Full! will appear on the screen. In such a case, use the Clear Song function in Job Mode (see page 96) to clear unwanted data. Before clearing the data, always check it to make sure if you need to save it to floppy disk.

REALTIME RECORDING

In realtime recording, the notes you play will be recorded exactly as you play them. Realtime recording lets you record the different parts of a song as you would if using a multi-track tape recorder, i.e., one part after another *live*, with or without a click track to keep time to. However, since you re recording music *data*, or MIDI *events*, into memory, and not recording actual sounds onto tape, you have far much more flexibility than multi-track tape recording before, during and after the fact.

With the W5/W7, a song sequence may have a single Instrument part, such as a solo piano performance, or it may have several parts, such as bass part, drums part, strings part, etc. With the W5/W7 each part is recorded into a sequencer track (1 ~ 16) independently, without affecting other parts.

The basic steps to realtime recording an Instrument part are as follows: (1) select a song and define the multi; (2) designate realtime record status; (3) record a performance of the part, and if you re satisfied with it, proceed to the next step, but if you re not satisfied, start over and replace the part with a new performance; (4) overdub , or add, another performance on top of the part; (5) punch-in , or spot-fix, specific measures in the part, without risk of losing anything you want to keep as is.

Your realtime recording session may include some or all of the above steps. You certainly don t have to perfect one part before moving on to the next part; you can perform realtime recording operations to any part at any time, as well as jump freely back and forth between Song Record, Song Edit and Song Job functions as inspiration and music making necessity dictates.

● PREPARING FOR REALTIME RECORDING

Before beginning the realtime recording process, first you must choose a song location from within Song Play Mode, by pressing [F2] (Seq). Then, press RECORD to enter record standby mode. Next, determine the time signature, quantize factor, tempo value and click status. (If you want to start recording from a particular measure, then specify the measure number). Finally, you will need to determine how the newly recorded data will be recorded to the track.



REPLACE - Pressing [F7] (Rplc) designates replace recording status. In replace recording, notes you record will replace the data previously in the track. After recording, the track will contain only the new data, and the previous data will be effectively erased. When recording in an empty track, then designate replace. (NOTE: If step recording has been selected then replace recording will not engage.)

OVERDUB - Pressing [F6] (Over) designates overdub recording status. In overdub recording, notes you record will be added to the data already in the track. After recording, the track will contain both the previous as well as the and new data. (NOTE: If step recording has been selected then overdub status will engage automatically.)

PUNCH-IN - Pressing [F8] (Pnch) designates punch-in recording status. In punch-in recording, you can re-record a particular series of measures that you specify in the From To fields of the punch-in display. During punch-in recording, notes you record will *replace* the previous data in the specified measures.

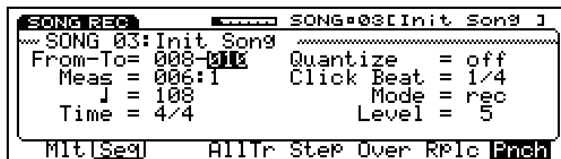

To choose the measure you want the punch-in process to begin from (i.e., the punch in point), position the cursor over the left field and enter the measure number. To choose the measure you want the punch-in process to finish at (i.e., the punch-out point), position the cursor over the right field and enter the measure number.

After engaging RECORD RUN, the actual recording process will only occur during the specified From and To measures. (NOTE: Depending on where the punch-in point is, most times you'll probably want to begin the song from a few measures before the punch-in point, in order to play along with the part to get ready for the punch-in recording, rather than from the beginning of the song, or from the punch-in point itself.)

ALLTRACKS - Pressing [F4] (AllTr) designates that all tracks are to be recorded at once. You will use the All Tracks function when recording MIDI data in realtime from an external sequencer.



● REALTIME RUN

After preparing for realtime recording, press RUN. A two-measure count-in will commence, after which recording from the designated measure will begin. When you've finished recording, or want to stop in process, press STOP/TOP.

NOTE: The word *Quantize* will disappear when you press RUN to Start realtime recording.

NOTE: If you initiate any event during the two-measure count-in like pressing a key on the keyboard or moving a controller such data will be recorded at the top of the song.

STEP RECORDING

Step recording lets you input each part one after another *one step at a time*, in accordance with certain note duration and other values which you can specify. In step record, notes will be recorded one by one with the specified time value, regardless of the actual timing at which you play. This makes it possible to input very complex passages which would be difficult even impossible to play in realtime.

● PREPARING FOR STEP RECORDING

Before beginning the step recording process, first you must choose a song memory location from within Song Play Mode, by pressing [F2] (Seq), and then select a track by pressing one of the TRACK buttons. Then, press RECORD to enter record standby mode. Next, press [F5] (Step) to designate Step Record status. Then, determine the time signature, quantize factor, and click status. (If you want to start recording from a particular measure, then specify the measure number).

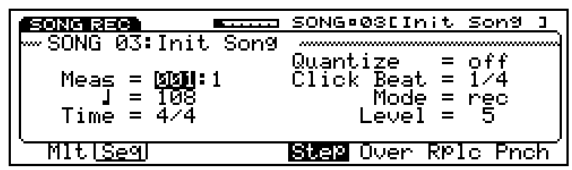

● STEP RUN

After preparing for step recording, press RUN. The step record input screen will appear, and the W5/W7 will be ready and waiting for you to start inputting data.

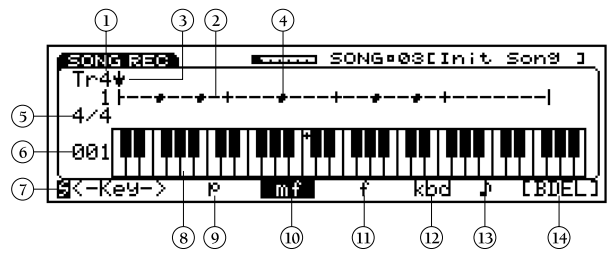

① TRACK NUMBER

Indicates the currently selected track.

② MEASURE BAR

The horizontal line represents one measure, and the vertical divisions each represent one beat. When data is input, a dot will display on the bar to indicate a 32nd note area which contains data.

NOTE: The number of vertical divisions or beats depend on the time signature you selected before recording, and depending on the time signature, the measure bar may not display in its entirety on the screen, as the number of beats in the measure may require two screen pages to display indicated by the number immediately to the left of the measure bar.

③ POSITION POINTER

As you move backward or forward through the data in time by using the CURSOR keys or JOG, a downward-pointing arrow will move in 32nd note steps to indicate the current position in the measure.

④ NOTE DATA DISPLAY

If the currently selected 32nd note area contains data, the notes in that area will display as small black squares on the keyboard diagram.

⑤ TIME SIGNATURE

Indicates the time signature as designated before recording.

⑥ MEASURE NUMBER

Indicates the current measure represented by the measure bar.

⑦ SHIFT PARAMETERS

During step record you can specify how long the note will be held in relation to its note value by accessing Normal, Staccato and Slur parameters, as well as delete notes with the Delete function by pressing and holding SHIFT, followed by [F1 ~ F3] and [F8], respectively. (The selected parameter will display in reverse type.)

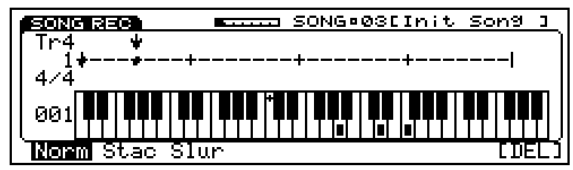

NORMAL - To record normal notes which sound for 90% of their note lengths, press SHIFT + [F1] (Norm).

STACCATO - To record staccato notes which sound for 50% of their note lengths, press SHIFT + [F2] (Stac).

SLUR - To record slurred notes which sound for 99% of their note lengths press SHIFT + [F3] (Slur).

DELETE - To delete all data in the 32nd note area where the position pointer is located, press SHIFT + [F8] (Del). (NOTE: The position pointer location will not change.)

⑧ **KEYBOARD VIEW (C-1 ~ B7)**

The entire keyboard will not fit in the screen, but you can access views of the lower region of the keyboard by pressing [F1] once or more, and the upper region of the keyboard by pressing [F2] once or more. A small plus + sign indicates middle C, or C3.

⑨ ~ ⑫ **VELOCITY**

To determine the velocity value of notes, press [F3 ~ F6] before entering note data on the keyboard. (The selected velocity value will display in reverse type.)

PIANO - Pressing [F3] (p) designates that the subsequent notes will be assigned a piano velocity value of 56.

MEZZOFORTE - Pressing [F4] (mf) designates that the subsequent notes will be assigned a mezzo forte velocity value of 88.

FORTE - Pressing [F5] (f) designates that the subsequent notes will be assigned a forte velocity value of 120.

KEYBOARD - Pressing [F6] (kbd) designates that the subsequent notes will be assigned a velocity value according to how you strike the keys.

⑬ **NOTE LENGTH**

Indicates the currently selected note length. At any time during step recording you can use the numeric keypad to enter note lengths as shown by the symbols printed above each key on the keypad. You can also modify the note lengths by pressing [F7]. If possible, the note values in this area will be displayed as graphic symbols for a whole note, quarter note, etc. Otherwise the note length will display as a number representing clocks (at a maximum of 960 clocks).

NOTE: The CANCEL button will not function in Song Record Mode.

⑭ **BACK DELETE**

The back delete function, engaged by pressing [F8] (BDel) depends on the current note length. For example, if the currently selected note length is a quarter note, then data at the location quarter note previous to the current position will be deleted, and the cursor will move back by a quarter note.

● **DATA INPUT**

To input data in step record, you'll use a combination of the keyboard (to input actual notes), the KEYPAD (to input note and other values as indicated above the KEYPAD buttons), and the function keys (to determine velocity and other values and access additional parameters).

KEYBOARD - Each time you press and release a key on the keyboard it will be recorded, or input, and the position will move ahead one step as specified by the step time. The note will not be entered until all keys have been released. This allows you to enter more than one note at the same location by pressing more than one note before releasing the first.

KEYPAD - The numeric keys #1 ~ #8 on the KEYPAD let you specify the note length to be recorded. Pressing each key will select the note length printed above it, from a whole note (#1) to a 16th note triplet (#8). This also determines the step time by which the cursor will automatically advance after each note has been entered. To create a dotted note, press #9. To create a double dotted note, press #9 twice. To extend the duration of the previously entered note by the current note length with a tie, press [—]; the cursor will advance accordingly. To advance one step without entering data with a rest, press #0, or just move the position pointer.

SCROLL - Using the JOG/SHUTTLE or the CURSOR keys, you can scroll back and forth through the measures and stop to enter notes wherever you like. As you cross note data, it will display on the keyboard diagram and sound by the tone generator.

● **STEP STOP**

When you've finished the step recording process, press STOP/TOP. The Song Sequence Play function screen will appear, from where you can press RUN and hear the song you just recorded.

NOTE: Since song sequences are not retained in memory at power off, always be sure to save your important sequence data to disk before turning off the power.

NOTE: The note length can be doubled by pressing the same key on the keyboard twice, or by pressing [F7]. For example, pressing #7 creates an 8th note triplet. Pressing it again (or pressing [F7]) creates a quarter note triplet.

SONG EDIT

In Song Edit Mode you can view and edit individual note, controller and other MIDI events in each track of the currently selected sequence, through three separate functions: (1) Data Change, which lets you modify the data; (2) Data Insert, which lets you insert new data; and (3) Graph, which lets you view notes as dots on a keyboard diagram plus a horizontal line which displays dots that indicate the position of note data in the measure.

● ENTERING AND EXITING SONG EDIT MODE

To enter Song Edit Mode, press EDIT in the Mode section on the panel, and select the various functions with the function keys. To exit Song Edit Mode, press EXIT once or more, or any other MODE button on the panel.

SEQUENCE TRACK GRAPH

The Sequence Track Graph function lets you view notes as small black squares on a keyboard diagram plus a horizontal line which displays dots that indicate the position of note data in the measure. The Graph function lets you view the data in a track as well as delete the data at the point where the position pointer is located.

● MOVING AROUND THE GRAPH

Using the JOG, or SHUTTLE, or the CURSOR keys, you can scroll back and forth through the measures in the graph and stop wherever you like (then switch to Data Change or Data Insert to change or insert data, respectively). As you cross note data, it will display on the keyboard diagram and sound by the tone generator.

● ACCESSING GRAPH

To access the Graph function, from within Song Edit Mode, press [F6] (Grph). The Graph function screen will appear.

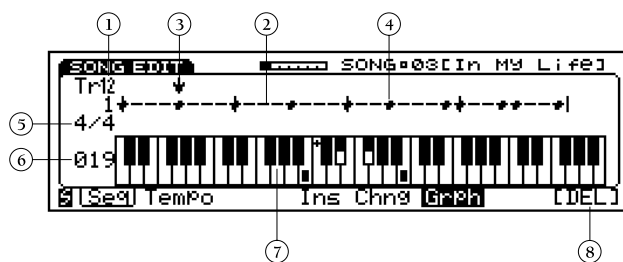

① TRACK NUMBER

Indicates the currently selected track. To select a track, press a TRACK button (1 ~ 16) on the panel.

② MEASURE BAR

The horizontal line represents one measure, and the vertical divisions each represent one beat. When data exists, a dot will display on the bar to indicate a 32nd note area which contains data.

③ POSITION POINTER

As you scroll backward or forward through the data using the JOG, the CURSOR keys or the SHUTTLE, a downward-pointing arrow will move in 32nd note steps to indicate the current position in the measure.

④ NOTE DATA DISPLAY

If the currently selected 32nd note area contains data, the notes in that area will display as small black squares on the keyboard diagram.

⑤ TIME SIGNATURE

Indicates the time signature as designated before recording.

⑥ MEASURE NUMBER

Indicates the current measure represented by the measure bar.

⑦ KEYBOARD VIEW

The entire keyboard will not fit in the screen, but you can access views of the lower region of the keyboard by pressing and holding SHIFT followed by pressing [F1] once or more, and the upper region of the keyboard by pressing and holding SHIFT followed by pressing [F2] once or more. A small plus + sign indicates middle C, or C3.

⑧ DELETE

Pressing [F8] (DEL) lets you delete the note data at the point where the position pointer is located. If more than one note is in the location, all notes will be deleted.

SEQUENCE/TEMPO TRACK DATA CHANGE

The Sequence Track Data Change function lets you single out individual events and modify them. The display will show the type and numerical values for each event. All data in the selected track will be displayed numerically. You can change the values of existing data, or delete the currently displayed data. You can also access the Data Change Tempo Track function to view a list of the locations of tempo changes within the song.

● LOCATING DATA

To move around in Data Change and locate the data you want to change, you can conveniently scroll back and forth through the data in the measures, using the SHUTTLE. You can also scroll using CURSOR-UP and CURSOR-DOWN. To access a specific event to change, use the CURSOR keys.

● CHANGING DATA

There are three ways to change data: (1) input a new value for the specified data; (2) move the specified data from one measure to another within the song, or from one beat to another within a measure; and (3) delete the specified data.

NEWDATAVALUE - After positioning the cursor at a specific data location, input a new value using the JOG and INC/DEC, and if the event is a numerical value, use the KEYPAD (all three data input methods must be followed by ENTER in order to execute the change)

DATAMOVE - Position the cursor over the measure/beat of the specific event you want to move. Then, using the KEYPAD, punch-in the new measure/beat number, followed by enter.

DATADELETE - To delete a selected event, simply press [F8] (DEL).

● ACCESSING DATA CHANGE

To access the Data Change function, from within Song Edit Mode, press [F5] (Chng). The Data Change function screen will appear.

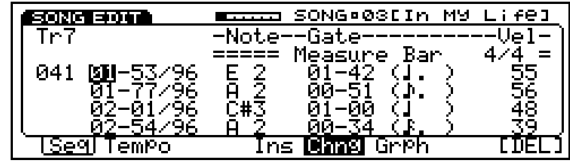
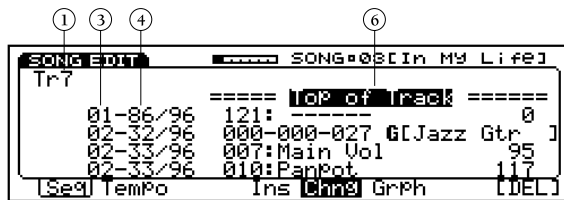

① TRACK NUMBER

Indicates the currently selected track. To select a track, press a TRACK button (1 ~ 16) on the panel.

② MEASURE NUMBER

Indicates the currently selected measure in the track.

③ BEAT

Displays the beat number of the measure.

④ CLOCK

Displays the clock value of the beat.

⑤ TIME

Displays the time signature of the current measure in the track.

NOTE: You cannot change the time signature from within Sequencer Track Data Change. You can change the time signature in the Create Measure function of Song Job Mode. (For information, see page 98.)

⑥ TOP OF TRACK/END OF TRACK

Indicates the beginning or end of the track, the display will show Top of Track or End of Track .

⑦ MEASURE MARK (Measure Bar)

Indicates the beginning of the measure.

● TYPES OF DATA THAT CAN BE CHANGED

The various types of data which can be changed in Sequence Track Data Change are as follows:

NOTE - Displays the actual note in the location.

NOTE NUMBER (C-2 ~ G8) - Displays the actual note event in the location. When the cursor is positioned at the note number, the note number can easily be changed by pressing the desired key on the keyboard while holding down [F5] (Chng).

GATE TIME (00-01 ~ 99-95) - Displays the gate time, or the number of clocks (1/96th of a beat) that the note is held. (The graphic note symbols indicate the nearest note value which represents the gate time, without exceeding it.)

VELOCITY (1 ~ 127) - Displays the note-on velocity value.

PROGRAMCHANGE - Displays the program change message in the location.

BANKSELECTNUMBER - MSB/LSB, 0 ~ 127, *** (off or no data)

MSB=0, LSB=0 - For selecting GM voices.

MSB=1, LSB=0 - For selecting Preset voices.

PROGRAMCHANGE NUMBER - 1 ~ 128

PITCH BEND (-8192 ~ 8191) - Displays the pitch bend value in the location.

CONTROLCHANGE - Displays the control change message in the location.

CONTROLCHANGENUMBER - 1 ~ 31, 33 ~ 122, 124 ~ 127

VALUE - 0 ~ 127

AFIERTOUCHE - Displays the aftertouch value in the location.

NOTE - Ch, C-2 ~ G8

VALUE - 0 ~ 127

SYSTEMEXCLUSIVE - Displays the system exclusive message.

TYPE (00 ~ 7F) - When inputting the Type, use the decimal numbers (0 ~ 127); the Type will display in the hexadecimal system.

● ACCESSING DATA CHANGE TEMPO TRACK

To access the Data Change Tempo Track function, from within the Data Change function, press [F2] (Tempo). The Data Change Tempo Track will appear.

SONG EDIT		SONG#07[Things We I	
Temp	Value		
01-00/96	Tempo	119	
====	Measure Bar	4/4	=
====	Measure Bar	4/4	=
====	Measure Bar	4/4	=
01-00/96	Tempo	119	
Seq [Tempo]	Ins [Chng]	[DEL]	

TEMPO (30 ~ 250) - The Data Change Tempo Track function displays a list of the locations of any tempo changes in the song. If no tempo changes exist, the list will be empty. Top or Track and End of Track delineate the beginning and end of the song, respectively. (NOTE: Tempo changes can only be entered in the Data Insert Tempo Track function.)

SEQUENCE/TEMPO TRACK DATA INSERT

The Sequence Track Data Insert function lets you single out a specific location in a track and insert any type of data. The display will show the type of event as well as the numerical values of each event. You can also access the Data Insert Tempo Track function to insert a tempo change anywhere in the song.

● LOCATING AND INSERTING DATA

To move around in Data Insert and locate the place in the track you want to insert data, you can conveniently scroll back and forth through the data in the measures, using the SHUTTLE. You can also scroll using CURSOR-UP and CURSOR-DOWN. To insert an event, position the cursor over the appropriate field for the type of event you want to insert, and use the JOG, INC/DEC, and if the event is a numerical value, use the KEYPAD; all three methods must be followed by ENTER in order to execute the change.

● ACCESSING DATA INSERT

To access the Data Insert function, from within Song Edit Mode, press [F4] (Ins). The Data Insert function screen will appear.

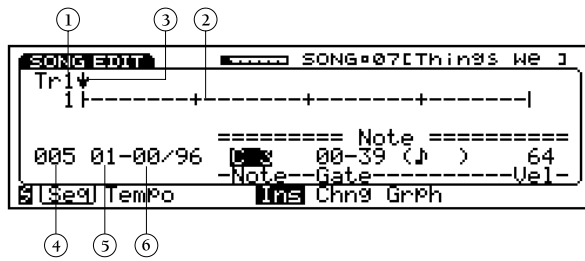

① TRACK NUMBER

Indicates the currently selected track. To select a track, press a TRACK button (1 ~ 16) on the panel. (NOTE: Selecting a different track from within Data Insert will automatically engage the Data Change function.)

② MEASURE BAR

The horizontal line represents one measure, and the vertical divisions each represent one beat.

③ POSITION POINTER

As you change the value of the beat or clock, a downward-pointing arrow will move in 32nd note steps to visually indicate the current position in the measure.

④ MEASURE NUMBER

Indicates the current measure represented by the measure bar.

⑤ BEAT

For accessing a specific beat.

⑥ CLOCK

For accessing a specific clock.

● INSERTING DATA

To insert data, press SHIFT to display the types of data you can insert, then, while holding SHIFT, choose the type of data you want to insert by pressing a function key [F1 ~ F6].

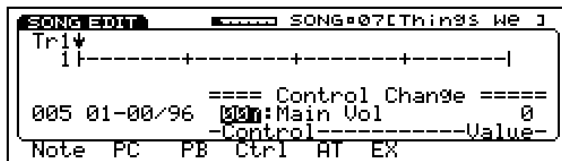

NOTE- While holding SHIFT, press [F1] (Note) to insert a numeric note value, gate value and velocity value at the specified location. Select the value of each with JOG or INC/DEC, then press ENTER. When the cursor is positioned at the note number, the note number can easily be inserted by pressing the desired key on the keyboard while holding down [F4] (Ins).

PROGRAMCHANGE - While holding SHIFT, press [F2] (PC) to insert a program change message at the specified location. Select the program change number with JOG or INC/DEC, then press ENTER.

PITCHBEND - While holding SHIFT, press [F3] (PB) to insert a pitch bend at the specified location. Select the value with JOG or INC/DEC, then press ENTER.

CONTROLCHANGE - While holding SHIFT, press [F4] (Ctrl) to insert a control change message at the specified location. Select the control change with JOG or INC/DEC, then press ENTER.

AFTERTOUCHE - While holding SHIFT, press [F5] (AT) to insert an aftertouch event at the specified location. Select the value with JOG or INC/DEC, then press ENTER.

SYSTEMEXCLUSIVE - While holding SHIFT, press [F6] (EX) to insert a system exclusive message at the specified location.

NOTE: The System Exclusive message for setting General MIDI to on status is as follows: F0 (fixed) — 126 (7E) — 127 (7F) — 9 (09) 1 (01) — F7 (fixed).

● ACCESSING DATA INSERT TEMPO TRACK

To access the Data Insert Tempo Track function, from within Data Change Sequence Track, press [F2] (Tempo), then select [F4] (Ins). The Data Insert Tempo Track screen will appear.

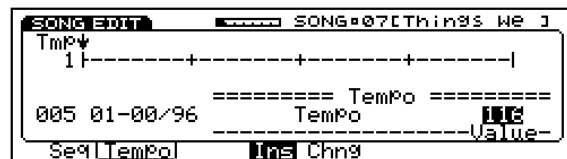

TEMPOCHANGE - To insert a tempo change anywhere in the song, first locate the specific point in the song by measure, beat and clock, then position the cursor over the Value field and use the JOG, INC/DEC or KEYPAD to select a tempo value, then press ENTER. (NOTE: The value will only have an effect if the W5/W7 s sequencer is synchronized to its own internal clock.)

SONG JOB

In Song Job Mode you can make changes to the sequence that apply to all data in one or more measures. Song Job operations include song copy, append and clear, track copy, clear and mix, measure copy, erase, create, delete and insert, data thin out, extract and chord sort, plus quantize, move clock, modify gate time, modify velocity, transpose, shift note, and crescendo.

● ENTERING AND EXITING SONG JOB MODE

To enter Song Job Mode, press the JOB button in the Mode section on the panel. A list of jobs (Job 1, Job 2, or Job 3) will appear, depending on which was accessed the last time Song Job Mode was exited. To exit Song Job Mode, simply press EXIT, or any MODE button on the panel.



● UNDO/REDO

Any time you execute an operation and then change your mind, you can *undo* it so long as you press [F7] (Undo) while holding down SHIFT, *before* pressing any other button. If you want, you can *redo* the operation as the screen indicates.



● MOVING AROUND IN JOB MODE

From within any of the three main Job menus, pressing SHIFT will display the list of functions in the selected Job (1, 2, or 3) along the bottom of the display, so you can jump straight to a particular function in the Job number without having to position the cursor and press ENTER. To jump to a function, while holding down the SHIFT key, press the function key that corresponds to the function you want to access.



After entering a function within a particular Job number, the menu of functions for that Job number will display at the bottom of the screen, so you can jump directly to any of them by pressing the corresponding function key, without having to return to the main menu or press SHIFT.

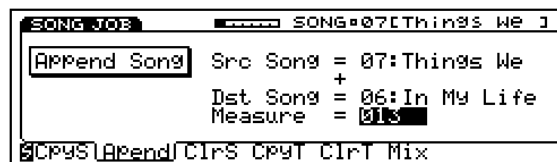

From within a particular Job, SHIFT lets you jump directly to one of the Job menus. To do so, while holding down the SHIFT key, press a function key [F2 ~ F4] corresponding to the Job menu you want to access.

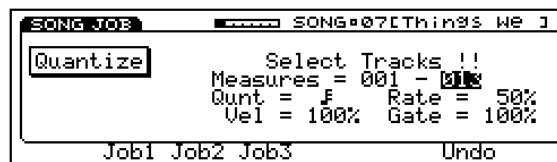

NOTE: Attempting to perform certain Job functions may cause various warning messages to appear on the screen. For example, exceeding the internal song memory capacity will result in the Song memory full! message; trying to execute an illogical operation like copying a song to itself will result in the Illegal data! message; if the source song/track contains no data, the Data empty! message may appear.

SONG JOB 1

Song Job 1 lets you perform Copy Song, Append Song, Clear Song, Copy Track, Clear Track, and Mix Track operations.



COPISONG - Pressing [F1] (CpyS) accesses Copy Song, which lets you copy a complete song from one song memory location to another song memory location, including all multi, sequencer and Song voice data.

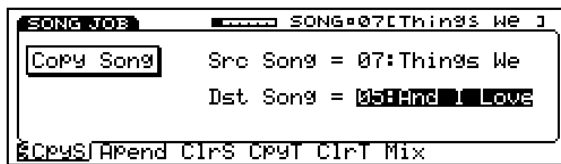

SOURCE SONG (01 ~ 16) - Specify the song you want to copy.

DESTINATION SONG (01 ~ 16) - Specify the song memory location you want to copy the song into. If the destination song is already occupied by song data, this data will be erased by the copy operation. Before executing the copy song operation, always check to make sure the destination song does not contain data you wish to keep.

EXECUTE - To execute the operation press ENTER.

NOTE: If you want to copy the Song voices from one song to another, use the Song Voice Memory function in Utility Mode. (For more information, see page 143.)

APPENDSONG - Pressing [F2] (Append) accesses Append Song, which lets you place a complete song in one song memory location into a specified measure of another song. The specified measure of the destination song, as well as all measures following it, will be deleted.

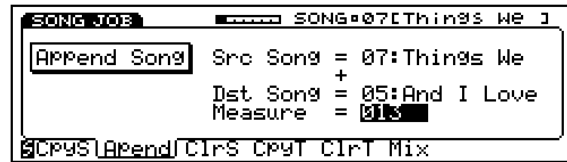

SOURCE SONG (01 ~ 16) - Specify the song you want to append.

DESTINATION SONG (01 ~ 16) - Specify the song you want the source song to be appended to.

MEASURE (001 ~ 999) - Specify the measure in the destination song where you want the source song placed. The song multi data (including voices) of the source song will not affect the destination song; however, the time signature of the source song will be maintained, i.e., if the time signature of the source song is different than the time signature of the destination song, then the time signature will change at the specified measure.

EXECUTE - To execute the operation press ENTER.

CLEARSONG - Pressing [F3] (ClrS) accesses Clear Song, which lets you clear, or eliminate, a specified song from a song memory, and reset the multi of the song memory to its basic default values.

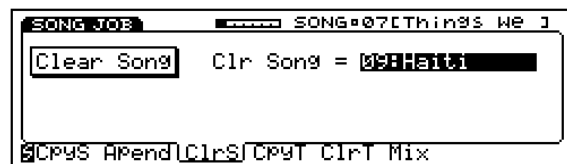

CLEAR SONG (01 ~ 16) - Specify the song you want to clear. (NOTE: Make sure the song to be cleared is saved to floppy disk, if it contains important data you don't want to lose.)

EXECUTE - To execute the operation press ENTER.

NOTE: If you want to clear the sequence data only, use the Clear Track function.

COPYTRACK - Pressing [F4] (CpyT) accesses Copy Track, which lets you copy all data from one or more tracks in one song to the corresponding tracks of another song.



SELECT TRACKS (1 ~ 16) - Press the TRACK buttons of the tracks that you wish to copy.

SOURCE SONG (01 ~ 16) - Specify the song whose tracks you want to copy.

DESTINATION SONG (01 ~ 16) - Specify the song you want the source song tracks to be copied to. All data in the selected tracks will be copied from the source to the destination. If the tracks copied are longer than the destination song, the destination song will become longer as a result of the copy operation. However, the measure table of the destination song will not be changed as a result of the operation. If the selected track of the destination song is already occupied by song data, this data will be erased by the copy operation. Before executing the copy track operation, always check to make sure the selected tracks of the destination song does not contain data that you don't want to lose.

COPY WITH TEMPO TRACK (yes, no) - When set to yes, the tempo of the source song will replace the tempo of the destination song. When set to no, the tempo of the destination song will remain as is.

EXECUTE - To execute the operation press ENTER.

CLEARTRACK - Pressing [F5] (ClrT) accesses Clear Track, which lets you erase all sequence data in the specified tracks of the selected song.

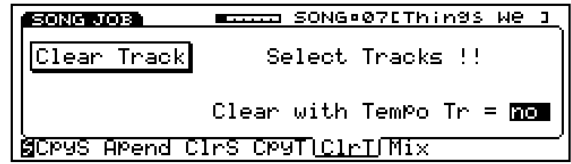

SELECT TRACKS (1 ~ 16) - Press the TRACK buttons of the tracks that you wish to clear.

CLEAR WITH TEMPO TRACK (yes, no) - When set to yes, the tempo of the source song will be reset to the basic default value. When set to no, the tempo will remain as is.

EXECUTE - To execute the operation press ENTER.

NOTE: Even if all tracks are selected and cleared by the Clear Track function, song multi data, setup parameters and the name of the song will remain. To clear all data, use the Clear Song function.

MIXTRACK - Pressing [F6] (Mix) accesses Mix Track, which lets you combine the data in one track of the currently selected song with the data of another track in the same song.

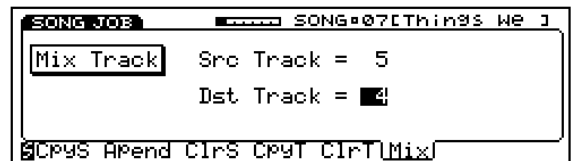

SOURCE TRACK (01 ~ 16) - Specify the track whose data you want to combine with the destination track. The data in the source track will remain as is after the operation is executed.

DESTINATION TRACK (01 ~ 16) - Specify the track you want the source track to be combined with.

EXECUTE - To execute the operation press ENTER.

SONG JOB 2

Song Job 2 lets you perform Copy Measure, Erase Measure, Create Measure, Delete Measure, Insert Measure, Thin Out, Extract and Chord Sort operations.

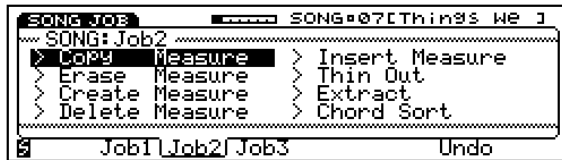

COPYMEASURE - Pressing [F1] (Copy) accesses Copy Measure, which lets you copy the data in the selected tracks of a specified range of measures one or more times and place it into another location in the currently selected song.



SELECT TRACKS (1 ~ 16) - Press the TRACK buttons of the tracks that you wish to copy.

SOURCE MEASURES (001 ~ 999) - Specify the first (left field) measure and last (right field) measure of the range of measures to be copied.

DESTINATION MEASURE (001 ~ 999) - Specify the first measure into which the source measures will be copied. The source range of measures will replace the destination measures to which it is copied.

TIMES (1 ~ 99) - Specify how many copies of the source range of measures which will be copied.

COPY WITH TEMPO TRACK (yes, no) - When set to yes , the tempo of the source measures will replace the tempo of the destination measures the data is copied into. When set to no , the tempo of the destination measures will remain as is.

EXECUTE - To execute the operation press ENTER.

ERASEMEASURE - Pressing [F2] (Eras) accesses Erase Measure, which lets you erase all data in the selected tracks of a specified range of measures.

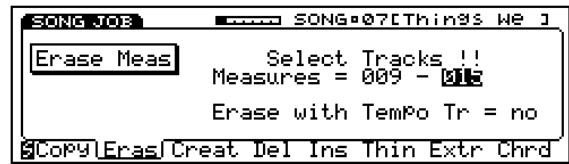

SELECT TRACKS (1 ~ 16) - Press the TRACK buttons of the tracks that you wish to erase.

MEASURES (001 ~ 999) - Specify the first (left field) and last (right field) measures of the series of measures that you wish to erase.

ERASE WITH TEMPO TRACK (yes, no) - When set to yes , the tempo of the erased measures will be set to the basic default value. When set to no , the tempo of the erased measures will remain as is.

EXECUTE - To execute the operation press ENTER.

CREATEMEASURE - Pressing [F3] (Creat) accesses Create Measure, which lets you insert one or more empty measures with a designated time signature into a specified measure in the currently selected song.

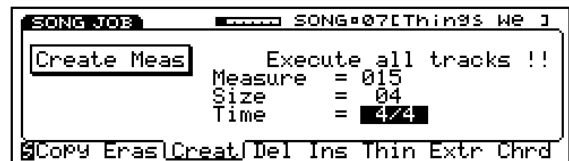

MEASURE (001 ~ 999) - Specify the measure before which the newly created measures will be inserted. The specified measure and those after it will be pushed towards the end of the song, i.e., the new measures will be inserted between the specified measure and the measure that came before it.

SIZE (01 ~ 99) - Specify the number of measures to create.

TIME (1/4 ~ 8/4, 1/8 ~ 16/8, 1/16 ~ 32/16) - Specify the time signature of the measures you wish to create.

EXECUTE - To execute the operation press ENTER.

SONG MODE

DELETEMEASURE - Pressing [F4] (Del) accesses Delete Measure, which lets you delete a specified range of measures from the currently selected song. Any measures which follow the last measure in the specified range will move forward to fill the gap .

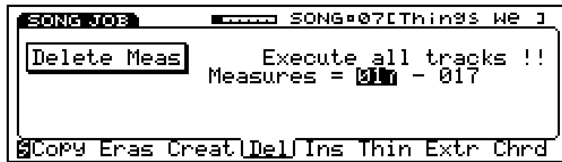

MEASURES (001 ~ 999) - Specify the first (left field) and last (right field) measures in the range of measures you wish to delete.

EXECUTE - To execute the operation press ENTER.

INSERTMEASURE - Pressing [F5] (Ins) accesses Insert Measure, which lets you specify a range of measures to be copied once or more and then inserted before another measure in the currently selected song.

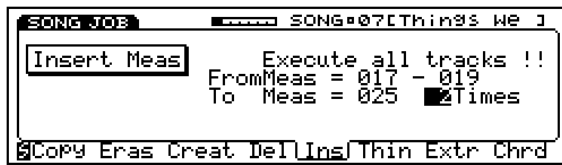

FROM MEASURE (001 ~ 999) - Specify the first (left field) and last (right field) measures of the series of measures that you wish to insert before the destination measure.

TO MEASURE (001 ~ 999) - Specify the measure before which you want the copies of the source measures to be inserted.

TIMES (1 ~ 99) - Specify how many copies of the source range of measures which will be inserted into before the destination measure.

EXECUTE - To execute the operation press ENTER.

THINOUT - Pressing [F6] (Thin) accesses Thin Out, which lets you conserve sequencer memory by deleting approximately every other occurrence of a designated type of controller event of the selected tracks from a specified range of measures.

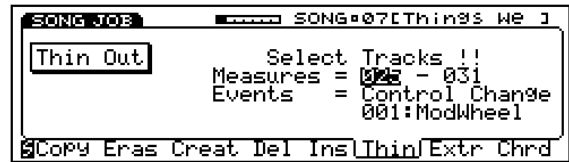

SELECT TRACKS (1 ~ 16) - Press the TRACK buttons of the tracks that you wish to thin out.

MEASURES (001 ~ 999) - Specify the first (left field) and last (right field) measures in the range of measures you wish to thin out.

EVENTS (Pitch Bend, Control Change 001 ~ 127 excl. 32 and 123, Channel aftertouch, Polyphony Aftertouch) - Designate the type of continuous controller to thin out.

EXECUTE - To execute the operation press ENTER.

EXTRACT - Pressing [F7] (Extr) accesses Extract, which lets you extract designated events from a specified range of measures in one track of the currently selected song and place the events into another track of the song.

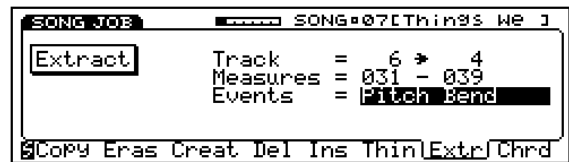

TRACK (1 ~ 16) - Specify the track you want to extract event from (left field) as well as the track you want to place the event into (right field).

MEASURES (001 ~ 999) - Specify the first (left field) and last (right field) measures of the range of measures to extract the designated event from.

EVENTS (Note [C-2 ~ G8, all], Program Change, Pitch Bend, Control Change [1 ~ 127 excl. 32 and 123], Ch. Aftertouch, Poly Aftertouch, System Exclusive) - Designate the type of event to extract.

EXECUTE - To execute the operation press ENTER.

NOTE: If data exists in the destination track, the extracted data will be mixed with it.

CHORDSORT - Pressing [F8] (Chrd) accesses Chord Sort, which lets you sort a cluster of notes in a specified range of measures, in either ascending or descending order.



SELECT TRACKS (1 ~ 16) - Press the TRACK buttons of the tracks on which you wish to perform the chord sort operation.

MEASURES (001 ~ 999) - Specify the first (left field) and last (right field) measures in the range of measures that you wish to perform the chord sort operation on.

TYPE (up order, down order) - Designate ascending (up order) or descending (down order) sort.

EXECUTE - To execute the operation press ENTER.

SONG JOB 3

Song Job 3 lets you perform Quantize, Move Clock, Modify Gate Time, Modify Velocity, Transpose, Shift Note and Crescendo operations.

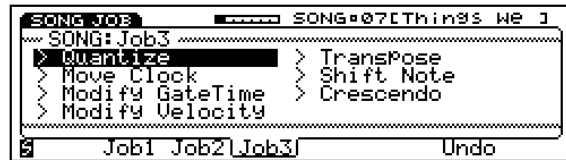

QUANTIZE - Pressing [F1] (Qunt) accesses Quantize, which lets you adjust the timing of each event in the specified measures of the selected track to the nearest interval of the specified value.

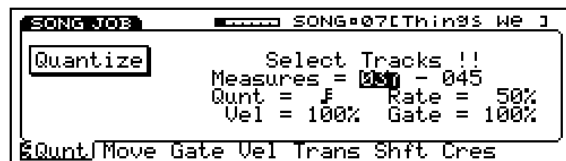

SELECT TRACKS (1 ~ 16) - Press the TRACK buttons of the tracks which you wish to quantize.

MEASURES (001 ~ 999) - Specify the first (left field) and last (right field) measures in the range of measures that you wish to quantize.

QUANTIZE

(F / F₁₆ / F₃₂ / F₆₄ / F₁₂₈ / F₂₅₆ / F₅₁₂ / F₁₀₂₄) - Specify the timing interval to which the notes will be quantized. For example, if the shortest note value should be a 16th note, then specify the 16th note symbol.

RATE - Designate swing rate by delaying the timing of the offbeat according to the quantization factor.

↓ / ↓₁₆ / ↓₃₂ / ↓₆₄ (50% ~ 75%)

↓₁₆ / ↓₃₂ / ↓₆₄ (66% ~ 83%)

↓+↓₁₆ / ↓+↓₃₂ (50% ~ 66%)

VELOCITY (1% ~ 200%) - Designate swing by increasing or decreasing the velocity of the offbeat value, where 100% represents no velocity change.

GATE (1% ~ 200%) - Designate swing by increasing or decreasing the gate time of the offbeat value, where 100% represents no gate time change.

EXECUTE - To execute the operation press ENTER.

MOVECLOCK - Pressing [F2] (Move) accesses Move Clock, which lets you move the specified measures of the track forward or backward in time by a specified clock value.

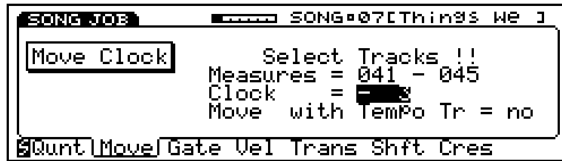

SELECT TRACKS (1 ~ 16) - Press the TRACK buttons of the tracks whose clock you wish to move.

MEASURES (001 ~ 999) - Specify the first (left field) and last (right field) measures in the range of measures whose clock you wish to move.

CLOCK (-999 ~ +999) - Specify the number of clocks (units of 1/96th of a quarter note) by which the track is to be moved. Positive settings will move the track forward in time so that it plays later. Negative settings will move the track backward in time so that it plays earlier. It is often effective to use clock move to compensate for voices that have a slow attack. For example strings often have a slower attack than other voices, and will appear to be lagging behind the other voices even if the note on messages are actually simultaneous. In such cases you can use the Move Clock operation to move the strings track earlier in time so that the string voices begin playing slightly before the other voices to improve perceived timing.

MOVE WITH TEMPO TRACK (yes, no) - When set to yes , the tempo will be affected by the Move Clock value. When set to no , tempo will not be affected.

EXECUTE - To execute the operation press ENTER.

MODIFYGATETIME - Pressing [F3] (Gate) accesses Modify Gate Time, which lets you modify the durations (gate times) of all notes in a specified range of measures of the selected track.

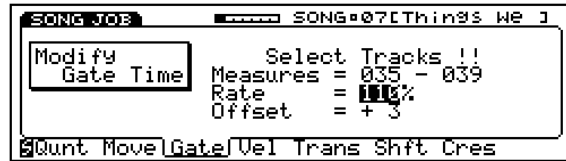

SELECT TRACKS (1 ~ 16) - Press the TRACK buttons of the tracks whose gate time you wish to modify.

MEASURES (001 ~ 999) - Specify the first (left field) and last (right field) measures in the range of measures whose gate time you wish to modify.

RATE (1% ~ 200%) - The specified percentage is the multiplication factor of all gate times. A rate of 100% will result in no change. A rate of 200% will make all gate times twice as long.

OFFSET (-99 ~ +99) - The specified offset will be added to all gate times.

NOTE: The rate and offset settings can be used separately or together. First the value is multiplied by the rate, and then the offset is added. If you want only to multiply each gate time by the same percentage, then set offset to 0 so it will have no effect. If you want only to add an absolute value to each gate time, set the rate to 100% so that it will have no effect. If the resulting gate time is 0, the note may be inaudible.

EXECUTE - To execute the operation press ENTER.

NOTE: Gate times can be modified by a ratio or by an absolute value. Each note event in a track has a gate time which determines the duration of the note. The gate time is indicated in units of a 1/384th note (1/96th of a quarter note), The modify gate time operation will not increase or decrease the gate time beyond these values.

MODIFYVELOCITY - Pressing [F4] (Vel) accesses Modify Velocity, which lets you modify the note-on velocity values for all note events of selected tracks in a specified range of measures.

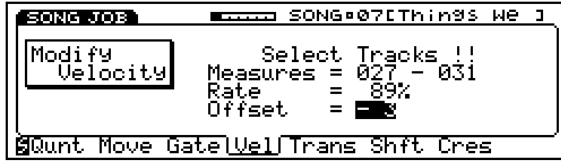

SELECT TRACKS (1 ~ 16) - Press the TRACK buttons of the tracks whose velocity you wish to modify.

MEASURES (001 ~ 999) - Specify the first (left field) and last (right field) measures in the range of measures whose velocity you wish to modify.

RATE (1% ~ 200%) - All note-on velocity values will be multiplied around the central value of 64 by the specified percentage. A rate of 100% will result in no change. A rate of 200% will move all velocity values further away from 64; i.e., it will expand the dynamic range. A rate of 0% will set all velocities to the central value of 64; i.e., it will compress the dynamic range.

OFFSET (-99 ~ +99) - The specified offset will be added to all note-on velocity values.

***NOTE:** The rate and offset settings can be used separately or together. First the value is multiplied by the specified rate, and then the offset is added. If you want only to add an absolute value to each velocity, set the rate at 100% so it will have no effect. If you want only to modify each velocity around the central value of 64, then set the offset at 0 so it will have no effect.*

EXECUTE - To execute the operation press ENTER.

***NOTE:** Each note event in a track has a note-on velocity which determines the force with which the note is played. The velocity has a range of 1 ~ 127, so the modify velocity operation cannot increase or decrease the velocity beyond these values.*

TRANPOSE - Pressing [F5] (Trans) accesses Transpose, which lets you transpose all notes of the selected tracks in a specified range of measures by a designated interval.

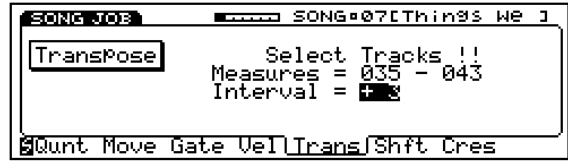

SELECT TRACKS (1 ~ 16) - Press the TRACK buttons of the tracks that you want the transpose applied to.

MEASURES (001 ~ 999) - Specify the first (left field) and last (right field) measures of the range of measures you wish to transpose.

INTERVAL (-99 ~ +99) - The note number of all notes will be transposed by the specified interval. Settings of +1 ~ +99 will transpose up, and settings of -1 ~ -99 will transpose down. The note number is limited to a range of 0 (C-2) to 127 (G8), and the note numbers resulting from the transpose operation will not exceed these limits.

EXECUTE - To execute the operation press ENTER.

SHIFTNOTE - Pressing [F6] (Shft) accesses Shift Note, which lets you *shift* a specified note number to another note number, over a specified range of measures in the selected tracks.

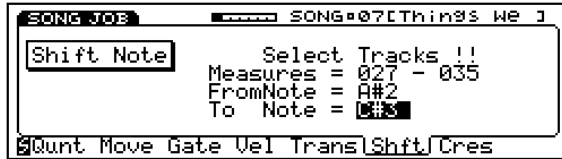

SELECT TRACKS (1 ~ 16) - Press the TRACK buttons of the tracks that you want the note shift applied to.

MEASURES (001 ~ 999) - Specify the first (left field) and last (right field) measures of the range of measures which you wish to shift.

FROM NOTE (C-2 ~ G8) - Specifies the specific note to shift.

TO NOTE (C-2 ~ G8) - Specifies the new note that the specific note will become.

EXECUTE - To execute the operation press ENTER.

NOTE: Shift Note is particularly useful when controlling a drum machine from the W5/W7 s sequencer, since most drum machines play specific sounds for each note. (For example, shifting all D#2 notes to F#2 might change all snare hits to hi-hat hits, depending on the instrument/note table for the drum machine.)

CRESCENDO - Pressing [F7] (Cres) accesses Crescendo, which lets you create a gradual change in note-on velocity over a specified range of measures in the selected tracks, to let you achieve an effect of crescendo or diminuendo.

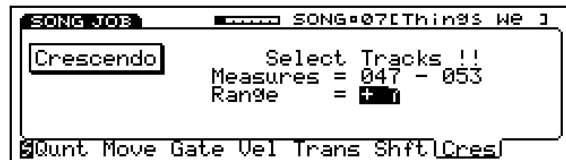

SELECT TRACKS (1 ~ 16) - Press the TRACK buttons of the tracks that you want the crescendo applied to.

MEASURES (001 ~ 999) - Specify the first (left field) and last (right field) measures in the range of measures over which you wish to create a crescendo.

RANGE (-99 ~ +99) - Specifies the final change in velocity which will be reached at the end of the crescendo or diminuendo. Starting at the beginning of the first measure you specify, note-on velocity will gradually be modified until the increase or decrease specified by the range is reached at the end of the last measure. Settings of +1 ~ +99 will result in a crescendo. Settings of -1 ~ -99 will result in a diminuendo.

EXECUTE - To execute the operation press ENTER.

NOTE: Each note event in a track has a note-on velocity which indicates the force with which the note is played. The velocity value of each note is limited to a range of 1 ~ 127, and the velocity values resulting from this operation will not exceed these limits. If a voice has not been programmed with velocity sensitivity, the velocity value of the note-on message will have no effect on the sound.

AWM TONE GENERATION

The W5/W7 creates sounds through Yamaha's exclusive AWM2 (2nd generation Advanced Wave Memory) tone generation process, which starts with high-quality digital samples of actual instruments and sounds.

The W5/W7's extensive on-board synthesizer and voice editing features give you unlimited sound sculpting potential, and its intuitive user interface lets you access literally any sound parameter in rarely more than two presses of a button.

The W5/W7 comes equipped with a large capacity waveform ROM full of preset AWM sound elements. 8Mbytes of 16-bit linear waveforms sampled at maximum 48kHz sampling frequency. These preset sound elements are the waves which define the fundamental character of the voice elements which form the building blocks that make up a W5/W7 stereo Instrument voice.

There are hundreds of preset waves to choose from, and an optional external Expansion Wave/Voice Board can be purchased separately and plugged into the W5/W7's logic board to increase the on-board capacity by another 4Mbytes.

AWM ELEMENTS

AWM elements are at the heart of the W5/W7's rich, dynamic sound quality. Only one AWM element is capable of making a voice, but the W5/W7 lets you construct voices that contain as many as four elements in order to obtain virtually unlimited sonic and performance potential.

An AWM element is a wholly formed, complete musical instrument sound unto itself. It is made up of an AWM sample, or wave, plus pitch, filter, amplitude, LFO and controller components, all of which can be manipulated in a variety of ways.

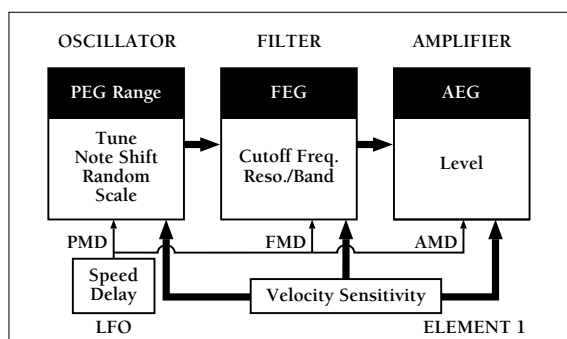

WAVE - The wave component plays back an AWM sample and determines the pitch, thus defining the basic characteristic of the tone. The basic tone of each element is produced by an AWM sound wave or a digitally sampled sound.

PITCH - The pitch component determines how the pitch changes over time. The pitch change over time, created by the pitch envelope generator (PEG), can be controlled by key-on velocity for each note. The speed

of the pitch change can be adjusted across the keyboard. Pitch modulation, or vibrato, can be created using the low frequency oscillator (LFO), and the amount of vibrato can be regulated by a controller. The pitch can be controlled directly by the pitch bend wheel as well as by aftertouch.

FILTER - The filter component can be controlled in a variety of ways to modify the tone of the wave. For example, each note can be given a fixed pattern of tonal change by using the filter envelope generator (FEG). Filter modulation, or wah-wah, can be created using the LFO, and wah-wah depth can be regulated by a controller. The tone can also be directly affected by a controller.

AMP - The amplifier component can be controlled in various ways to control the volume of the sound. For example, each note can be given a fixed pattern of volume change by using the amplifier envelope generator (AEG), which can also be affected by key velocity. Volume Modulation (tremolo) can be created using the LFO, and tremolo depth can be regulated by a controller. Volume can also be directly affected by a controller.

LFO - The LFO (Low Frequency Oscillator) component can control the tone in a variety of ways. The LFO creates a cyclically changing control signal that can be used to create amplitude modulation (tremolo), pitch modulation (vibrato), and filter modulation (wah-wah). The W5/W7's LFO can produce various types, or shapes, of modulation waves, including triangle, square, sine, and assorted sawtooth waves and others, plus sample & hold, which produces a control signal whose level will change randomly at intervals of time which you can determine by speed.

VOICE CONTROL

Musical instrument sounds are constantly changing and can be very complex. Different types of instruments change in very different ways. With an instrument such as a piano, for example, the tone and volume of each note changes in a predictable way over time. With an instrument such as a violin, on the other hand, the volume, tone and pitch may be continuously modified by the musician during performance.

The W5/W7 provides many ways to control the various aspects of the sound, as follows:

ENVELOPE GENERATOR (EG) - The EG produces a fixed pattern of change over time. For example, to simulate the attack and decay of a piano, you would set the amplitude EG (AEG) to be loud when the note is first played, and then to gradually diminish in volume over the following moments.

KEYVELOCITY - The velocity (speed) with which you play each key can affect various aspects of the sound. For example, strongly and softly played notes can be made to differ in pitch, tone, or volume.

LOW FREQUENCY OSCILLATOR (LFO) - The LFO produces various patterns of cyclical change. Applying the LFO to the pitch component produces vibrato; applying it to the filter component produces wah-wah; applying it to the amplifier component produces tremolo.

CONTROLLERS - Controllers such as the pitch bend and modulation wheels, aftertouch, and optional foot controllers can be used to control the sound in a variety of ways. Some controllers such as the pitch bend wheel can directly determine the pitch. You can assign the various other controllers to control many aspects of the sound. For example, you might assign aftertouch so that the amount of vibrato (LFO modulation to the wave component) increases as you apply pressure to the keyboard after the initial attack.



VOICE MODE

The W5/W7's Voice Mode has two distinct functions: (1) playing back single voices without system effects or other multi settings applied, and (2) editing voices while comparing them to the original voice or initialized status and storing them in Internal voice memory.

● VOICE PLAY MODE

In Voice Play Mode the W5/W7 will play the individual voices (from the Preset, GM, Internal, Song or optional External voice banks) in their original state, bypassing system effects and other multi settings.

● VOICE EDIT MODE

In Voice Edit Mode you can edit any and all parameters which make up a voice, including Insertion Effect and controller settings. You can go directly to Edit Mode from either Voice Play or Song Play and start editing the currently selected voice at any time, even while the sequencer is running.

NORMAL VOICES & DRUM VOICES

There are two basic types of voices in the W5/W7, the normal voice and the drum voice, each with many editable parameters. A normal voice is an instrument sound that contains between 1 and 4 elements and can be played from the keyboard (or an external MIDI device) in either a pitched or fixed (i.e., every key or note number plays the same sound) status. A drum voice is an entire drum kit or set of percussion sounds. In a drum voice, a different element (i.e., drum sound) can be assigned to each key on the keyboard or MIDI note number.

Voice Edit				
STEREO VOICE				
Voice Name				
Volume Level				
Insertion Effect Type/Parameter				
Element Edit				
Element 1	Element 2	Element 3	Element 4	

NORMAL VOICE

Voice Edit	
STEREO VOICE	
Voice Name	
Volume Level	
Insertion Effect Type/Parameter	
Key(Element) Edit	
Pan	
Volume	
System Effect Send Levels	

DRUM VOICE

Normal voices and drum voices are organized in various preset and user-defined normal and drum *voice banks*. (NOTE: You can access voice banks in both Voice and Song Modes, by pressing function keys [F6] and [F7], located directly beneath the [▼-Bank-▲] display at the lower right of the screen). Normal and drum voice banks are designated with a one- or two-letter abbreviation code, respectively, which appears immediately to the left of the voice number. (For more information about voice banks, see page 25.)

All of the individual voices are organized into 21 classes of instrument groups, called Voice Categories, for easier access. The Voice Category for each voice is identified by a two-character prefix, which in Voice Mode will appear to the left of the voice name, and in Song Mode will appear just below the track volume section in the mixer screen. (For more information about Voice Categories, see page 27.)



VOICE PLAY

In Voice Play Mode you can select voice banks and voices for the currently selected track and hear them in their original state, without system effects or other multi parameters applied. In Voice Play Mode, the Insertion Effect which is assigned to voice in Voice Edit Mode is also applied to the selected voice.

● ENTERING AND EXITING VOICE PLAY MODE

To enter Voice Play Mode, simply press the VOICE button in the Mode section on the panel. To exit Voice Play Mode, simply press another MODE button.

NOTE: When switching back to Song Play Mode from Voice Play Mode, the Voice Play settings (i.e., the voice in its original state) will be maintained for that specific track. To restore the original multi setting for the track, you must switch to another song and then back again.

● ACCESSING VOICE PLAY FUNCTIONS

When entering Voice Play Mode, the Voice Play screen will appear, from where you can access the Voice Play functions.

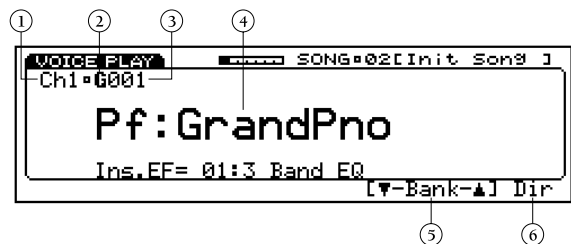

① MIDI CHANNEL NUMBER (Ch. 1~16)

The MIDI channel number also indicates the currently selected track in the multi (Track 1~16), since each instrument track number corresponds with its respective MIDI channel number.

② VOICE BANK (G, P, I, S, E*, GD, PD, ID, SD, ED*)

Displays the one-letter (for normal voice) or two-letter (for drum voice) code that represents each voice bank. (* NOTE: E and ED will display only if the optional Expansion Wave/Voice Board has been installed.)

③ VOICE NUMBER (001 ~ 128)

Displays the currently selected voice number of the voice bank.

④ VOICE NAME

Displays the Voice Category and name of the currently selected voice. (If you select a different instrument track while viewing this screen, the name and location of the track's instrument voice will display.)

⑤ VOICE BANK SELECT

Pressing [F6] and [F7] lets you choose a voice bank. The one- or two-letter voice bank code will begin flashing, indicating that you must then press ENTER to lock in the desired bank. (For more information about voice banks, see page 25.)

⑥ VOICE DIRECTORY

Pressing [F8] (Dir) accesses the Voice Directory, which displays the voices in the currently selected voice bank by list, eight at a time.



Within the Voice Directory you can select voices by scrolling through the entire list using the JOG, INC/DEC, or the CURSOR keys, or enter a specific number on the KEYPAD the list will advance accordingly. (You can also select voice banks from within the Voice Directory.)

NOTE: In Voice Play Mode, basic settings are configured as follows: Volume = 100; Pan = Center; Insertion Effect = on; System Effect Sends = vce; System Effect Type/Parameter = default; System Effect Return = default; Tune = 0; Note Shift = 0; Pitch Bend Range = vce.

VOICE EDIT

In Voice Edit Mode you can edit any and all parameters which make up a voice, including Insertion Effect assignment and parameter settings, as well as controller settings. You can go directly to Voice Edit Mode from any mode and start editing the currently selected voice at any time, even while the sequencer is running.

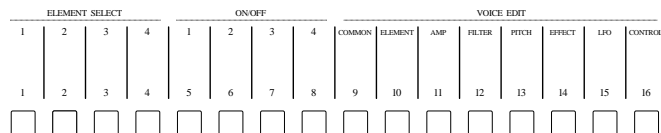

In Voice Edit Mode, the TRACK buttons on the panel double as voice editing function access and control, letting you choose the main voice editing functions with one touch, and in Normal Voice Edit Mode, select the AWM elements and turn them on and off. The orange lights in the VOICE EDIT and TRACK buttons will always indicate the voice editing status, including which elements are selected or switched on or off, and which element edit function is currently selected. Also, in Voice Edit Mode, the VOICE EDIT button doubles as a compare button, to let you compare the sound of the original voice to the sound of the voice you re creating.

Normal voice editing starts with either an initialized voice (see page 110) when you want to edit a voice from scratch, or a Preset, GM, Internal, Song or optional External voice when you want to modify an existing sound. Drum voice editing starts with an existing Preset or GM drum voice. Accessing all voice editing features rarely takes more than the press of a button or two, and adjusting parameter settings is just as simple, using the JOG, INC/DEC and KEYPAD.

● EDITING A VOICE

The types of sounds you can create using the W5/W7 are literally endless, since there are hundreds of parameters which you can access and modify. The steps in the process of voice editing are as follows: (1) select a track and assign the voice that you want to edit to it; (2) switch into Voice Edit Mode; (3) edit the parameters; and (4) store the voice into an Internal voice bank memory.

● VOICE EDIT/COMPARE

To compare the voice you re editing to the original voice you started from. Press VOICE EDIT and play the keyboard. Pressing VOICE EDIT again returns you to the voice you re editing.

When you are in Voice Edit Mode but have not yet modified any data, there will be a small square positioned between the MIDI channel number of the track and the voice bank and number.

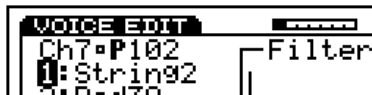

If you edit the data in any way, the square will be replaced by a capital letter E inside a black box, which indicates that the data has been modified.

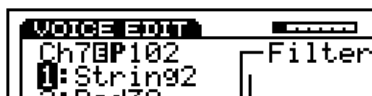

When you want to compare the voice you re editing to the original voice that you started from, press VOICE EDIT,

which doubles as an edit/compare toggle switch. In Compare status, the letter in the black box will change to a capital C, and the light in the VOICE EDIT button will start blinking.

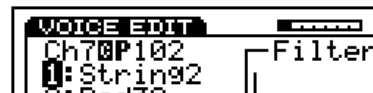

NOTE: Whenever you select a voice, it is temporarily located in the voice buffer. Choosing another voice replaces the buffer with the selected voice. When you are editing a voice, you are operating on the voice which is currently in the voice buffer. The W5/W7 is very flexible, so you can switch back and forth between modes without losing your newly created voice. However, once you call up a different voice, your voice will be cleared from the voice buffer.

● STORING A VOICE

To store the voice, press STORE followed by [F3] (Voice). Rotate the JOG or press the INC/DEC buttons to choose an Internal voice memory location, then press ENTER. To exit Store Mode, press EXIT or any other desired MODE button.

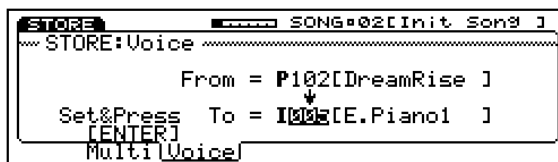

NOTE: Depending on the selected voice, changing certain parameters may not create an audible change.

NORMAL VOICE EDIT MODE

Normal Voice Edit Mode lets you modify a preset voice or create an entirely new voice from scratch.

● ENTERING AND EXITING NORMAL VOICE EDIT MODE

To enter Normal Voice Edit Mode select a track with a normal voice assigned to it and press the VOICE EDIT button. The screen will display a menu of the eight main normal voice editing functions. To exit the Voice Edit Mode, simply press EXIT or any other MODE button.



● ACCESSING VOICE EDIT PARAMETERS

To access the normal voice edit parameters, use the function keys [F1 ~ F8] which correspond to the names of the edit functions at the bottom of the screen, or use the CURSOR keys to position the cursor over the various parameter name blocks in the display, followed by ENTER. You can also access the respective normal voice edit parameters by pressing TRACK buttons [9 ~ 16] as indicated on the panel. From within any voice edit function you can jump directly to another voice edit function by holding down the SHIFT key and pressing the appropriate function key.

COMMON - For accessing those parameters common to all AWM elements, including volume, name and initialize.

ELEMENT - For assigning between one and four elements to a voice, plus setting each element's pan, velocity limit and note limit.

AMP - For determining the element output volume and accessing the amplitude envelope generator (AEG) parameters, which determine how the volume of an element changes over time.

FILTER - For determining the cutoff frequency, cutoff scaling and filter envelope generator (FEG) settings, which can greatly modify the tone.

PITCH - For determining how the pitch changes over time, through the pitch envelope generator (PEG) settings. The pitch change over time created by the PEG can be controlled by key-on velocity. The speed of the pitch change can be adjusted across the keyboard.

EFFECT - For determining Insertion Effect type, parameter, control and on/off status, plus the system effect send level for the voice.

LFO - For determining the low frequency oscillator (LFO) settings. The LFO creates a cyclically changing control signal that can be used to create tremolo (amplitude modulation), vibrato (pitch modulation), and wah-wah (filter modulation).

CONTROL - For determining the function and status of the various controllers, including sustain, pitch bend and modulation wheels, aftertouch, foot control and MIDI control.

● SELECTING ELEMENTS AND SWITCHING THEM ON AND OFF

When editing a voice which uses two or more elements it is often necessary to hear only one element at a time, especially the one you're editing. The W5/W7 provides quick access to each element you need to single out, as well as ample visual feedback about element on/off and select status.

ELEMENT DISPLAY - Each Voice Edit function screen displays information in two areas. The left area displays the element number (1 ~ 4) and names of the four elements and the right area displays the parameters which you can edit. The element number (1 ~ 4) of the currently selected element will display in reverse type. The element number of an element which is turned off will display smaller than the numbers of elements which are turned on. Only assigned elements will display.

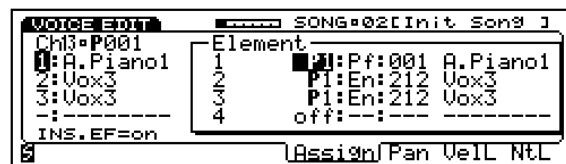

TRACKBUTTONS - In Voice Edit Mode, the TRACK buttons double as voice editing function access and control, letting you choose the main voice editing functions with one touch, as well as select and turn the AWM elements on and off. The orange lamps on the VOICE EDIT and TRACK buttons indicate the voice edit status, including which elements are selected or switched on or off, and which element edit function is currently selected.

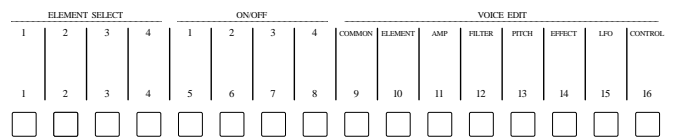

ELEMENT SELECT - To select elements within any edit function, press TRACK buttons [1 ~ 4].

ELEMENT ON/OFF - To switch elements on and off within any edit function, press TRACK buttons [5 ~ 8].

COMMON PARAMETER

The common parameter function lets you perform operations which effect all elements or the entire normal voice.

● ACCESSING COMMON PARAMETERS

To access the common parameter function, from within Voice Edit Mode, press [F1] (Com) or TRACK [9].



VOLUME - To designate the Voice Category or set the volume for the voice, press [F6] (Vol).

CATEGORY (21 types) - For choosing the two-letter voice category code for the voice. Choose a voice category with the JOG or INC/DEC. (For a complete list of the different voice categories, see page 27.)

VOLUME (0 ~ 127) - For adjusting the overall output volume of the voice. Position the cursor over the numeric value and enter a new number with the JOG, INC/DEC, or the KEYPAD.

NAME (10 characters) - To name a voice, press [F7] (Name). Position the pointer over a letter space with [F4] and [F5], and choose a character with the JOG dial, INC/DEC buttons, or CURSOR keys. A space can be entered by pressing [F3] ([SPC]).

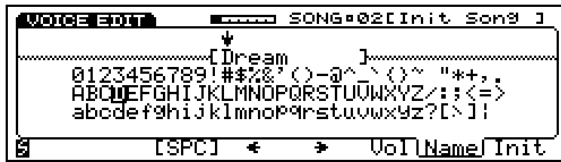

INITIALIZE - To initialize the voice to its basic default values, press [F8] (Init). Press ENTER to engage the initialization process. To initialize the voice, press INC. To abort the operation, press DEC.

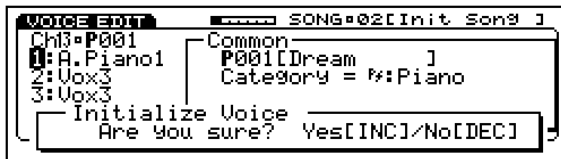

COMMON INITIALIZATION VALUES

Voice Name _____ Init Voice
 Category _____ No Assign
 Voice Type _____ Normal

Insertion Effect Level 1 _____ 0
 Level 2 _____ 0
 Level 3 _____ 0
 Level 4 _____ 0
 Switch _____ Off

Effect Control Parameter _____ Off
 Minimum Limit _____ 0
 Maximum Limit _____ 100

Effect Type _____ 1

MIDI Control 1 Device# _____ 1
 Parameter _____ 0
 Parameter Minimum Limit _____ 0
 Parameter Maximum Limit _____ 100

MIDI Control 2 Device# _____ 1
 Parameter _____ 0
 Parameter Minimum Limit _____ 0
 Parameter Maximum Limit _____ 100

System Effect Send 1 _____ 0
 Send 2 _____ 0
 Send 3 _____ 0

Voice Total Level _____ 127

Modulation Wheel Pitch Modulation Range _____ 0
 Amplitude Modulation Range _____ 0
 Frequency Modulation Range _____ 0
 Cutoff Range _____ 0
 EG Bias Range _____ 0

Foot Controller Pitch Modulation Range _____ 0
 Amplitude Modulation Range _____ 0
 Frequency Modulation Range _____ 0
 Cutoff Modulation Range _____ 0
 EG Bias Range _____ 0

Attack Pitch Modulation Range _____ 0
 Amplitude Modulation Range _____ 0
 Frequency Modulation Range _____ 0
 Cutoff Modulation Range _____ 0
 EG Bias Range _____ 0
 Pitch Bend Range _____ 0

Pitch Bend Range _____ 0

VOICE MODE

ELEMENT INITIALIZATION VALUES

Element Memory Bank _____ No Change

Element Switch _____ No Change
Number _____ No Change
Volume _____ 127
Pan _____ 0
Note Shift _____ 0
Note Number _____ C3
Frequency Fix Switch _____ Normal
Pitch Scaling _____ 0
Random Pitch _____ 0

Element Note Limit Low _____ C-2
Limit High _____ G8

Element Velocity Limit Low _____ 1
Limit High _____ 127

Element Volume Low Limit _____ 0
Switch _____ All on

Element PEG Type _____ 0 (Default)
Attack _____ 0
Decay 1 _____ 0
Decay 2 _____ 0
Release _____ 0
Sensitivity _____ +32 (100%)
Velocity Sensitivity _____ 0

Element AEG Type _____ 0 (Default)
Attack _____ 0
Decay 1 _____ 0
Decay 2 _____ 0
Release _____ 0
Velocity Sensitivity _____ 0

Element FEG Type _____ 0 (Default)
Attack _____ 0
Decay 1 _____ 0
Decay 2 _____ 0
Release _____ 0

Element Band Width Velocity Sensitivity _____ 0
Element Filter Velocity Sensitivity _____ 0
Element Filter Foot Controller _____ 0
Element Filter Reso/Band _____ 0

Element LFO Type _____ 0 (Default)
Speed _____ 0
Delay _____ 0
Pitch Modulation _____ 0
Amplitude Modulation _____ 0
Frequency Modulation _____ 0

ELEMENT

The Element parameters function lets you perform operations which determine the fundamental characteristics of the element.

● ACCESSING ELEMENT PARAMETERS

To access the Element parameters function, from within Voice Edit Mode, press [F2] (Elem) or TRACK [10].

ASSIGN - To designate the elements that will make up the voice, from within the Element parameters function, press [F5] (Assign). Within Element Assign you can specify the element bank and the AWM sample (i.e., the element number) within it which forms the fundamental characteristic of each element. To select either the element bank or the element number, use the CURSOR-LEFT and CURSOR-RIGHT keys. To select an element (1 ~ 4) to assign an element bank and element number to, use the CURSOR-UP and CURSOR-RIGHT keys. (NOTE: The names of assigned elements will display in the left area of the screen in all Voice Edit functions. Unassigned elements will display only dashes [—] in all relevant fields.)

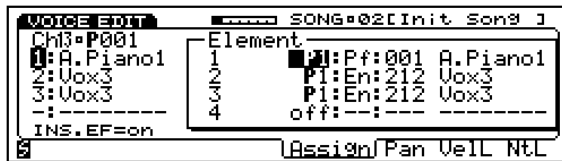

ELEMENT BANK (off, P.1 [Preset 1], P.2 [Preset 2], I [Internal], S [Song], E [External]) -

Position the cursor over the left-most field and use the JOG or INC/DEC to choose the element bank. When the W5/W7 is shipped from the factory, the two preset element banks are the only banks with samples in them. (For a listing of the elements, refer to the Element List in the W5/W7 Technical Information booklet, provided separately.)

NOTE: Bank E is accessible only if the optional Expansion Wave/Voice Expansion Board has been installed. Banks I and S contain no data and will therefore display *****. These banks are reserved as space for additional Internal and Song elements which may be loaded into the W5/W7 by optional song disks. If Song elements are loaded they will be cleared when the power is turned off.

ELEMENT NUMBER - Position the cursor over the element number field and use the JOG, INC/DEC or the KEYPAD to choose the desired element.

PAN (-31 ~ +31) - To determine the stereo positioning of the element between the left and right outputs, from within the Element parameters function, press [F6] (Pan).

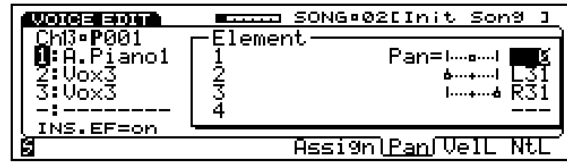

PAN POSITION - Specify the pan position using the JOG, INC/DEC or the KEYPAD. L values will move the sound towards the left output, while R values will move the sound towards the right output. A value of +0 is straight-up center position. The indicator to the left of the numeric value provides a graphic display of the setting.

NOTE: If you set the voice pan to the left or right side in Voice Edit Mode, then set the pan to the opposite side on the mixer, the voice may not be audible, or the result may be different from your intention.

VELOCITYLIMIT - To determine the range of key-on velocities that will play each element, from within the Element parameters function, press [F7] (VelL). (The black horizontal bar in between the low and high fields provides a graphic representation of the range setting.)

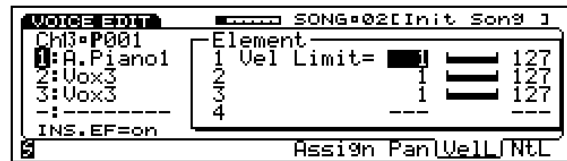

LOW (1 ~ 127) - Position the cursor over the left field and use the JOG, INC/DEC or the KEYPAD to determine the low velocity limit value, which is the lowest key-on velocity for which the element will sound.

HIGH (1 ~ 127) - Position the cursor over the right field and use the JOG, INC/DEC or the KEYPAD to determine the high velocity limit value, which is the highest key-on velocity for which the element will sound.

With settings of Low = 1 and High = 127 you can play an element over the full range of key velocities. You can use the velocity limit parameters to make strongly played notes play different elements than softly played notes.

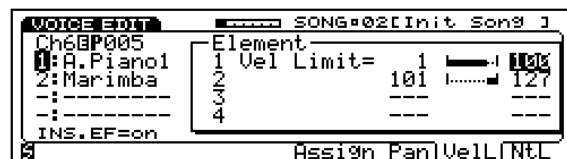

For example, in a two-element voice where element 1 is a piano sound and element 2 is a strings sound, set element 1 to Low = 1 and High = 100, and set element 2 to Low = 101 and High = 127. With these settings, soft notes will play the piano (element 1) and strong notes will play strings (element 2). If you want, you can overlap the velocity limits of the elements, or use more than two elements.

It is possible to set the low limit above the high limit. In such a case, the element will be sounded by key-on velocities outside the limits, ignoring the key-on velocities in between.

NOTE LIMIT - To specify the range of notes that will play each element, from within the Element parameters function, press [F8] (NtL). (The black horizontal bar in between the low and high fields provides a graphic representation of the range setting.)

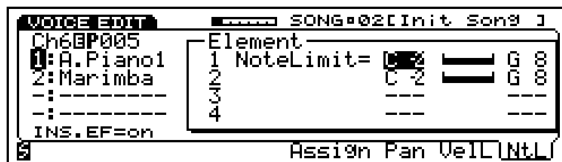

LOW (C-2 ~ G8) - Position the cursor over the left field and use the JOG or INC/DEC to determine the low note limit, which is the lowest note that will be played by the element,.

HIGH (C-2 ~ G8) - Position the cursor over the right field and use the JOG or INC/DEC to determine the high note limit, which is the highest note that will be played by the element.

To play an element over the entire range of the keyboard, leave the note limits set at Low = C-2 and High = G8. You can use the note limit parameters to create keyboard split effects where different elements are played by different keyboard areas.

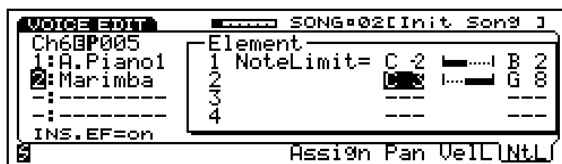

For example, in a two-element voice where element 1 is a bass sound and element 2 is a piano sound, set element 1 to Low = C-2 and High = B2, and set element 2 to Low = C3 and High = G8. With these settings notes below middle C will play bass (element 1) and notes above middle C will play piano (element 2).

It is also possible to set the low limit above the high limit. In such a case, the element will be played by notes which lie above the low limit and notes which lie below the high limit ignoring all notes in between.

AMPLITUDE

The Amplitude parameters function lets you determine the output volume level and velocity sensitivity for each element, as well as access the amplitude envelope generator (AEG) parameters, which determine how the volume of an element changes over time.

● ACCESSING AMP PARAMETERS

To access the Amp parameters function, from within Voice Edit Mode, press [F3] (Amp) or TRACK [11].

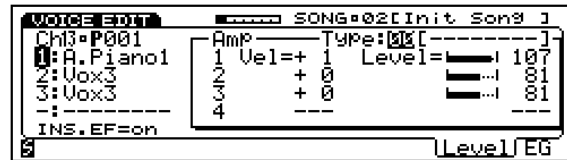

LEVEL - To specify velocity sensitivity and volume level for each element, from within the Amp parameters function, press [F7] (Level).

VELOCITY SENSITIVITY (-14 ~ +14) - Position the cursor over the Vel offset field and use the JOG, INC/DEC or the KEYPAD to determine how the output level of the element changes in response to velocity changes (keyboard dynamics) as you play. Positive settings produce higher output level in response to higher velocity values, i.e., the harder (or faster) a key is played, the louder the sound. The maximum setting produces the maximum level variation in response to velocity changes. Negative settings produce the opposite effect, i.e., lower level in response to higher velocity. A setting of 0 results in no level variation.

AMP LEVEL (0 ~ 127) - Position the cursor over the Level offset field and use the JOG, INC/DEC or the KEYPAD to determine the output level of each element. (The black horizontal bar to the left of the level value field displays a graphic representation of the level setting of each element, which effectively gives you a visual view of the mix .)

TEMPLATE TYPE (00 ~ 39) - Position the cursor over the Type number field and use the JOG, INC/DEC or the KEYPAD to select the type of amplitude envelope generator (AEG) *template*, which gives you instant access to the EG shapes of many popular sounds. There are a wide variety of EG types to choose from, including those from all major acoustic and many electronic instruments. A setting of 00 is the default EG for the preset voice. (To see a list of the various template types, refer to the W5/W7 *Technical Information* booklet, provided separately.)

NOTE The template type determines the maximum and minimum range of velocity sensitivity and amplitude level. Therefore, a velocity sensitivity or amplitude level offset which exceeds the range of the template type will have no effect.

AMPLITUDE ENVELOPE GENERATOR - To access the Amplitude envelope generator (AEG) parameters, from within the Amp parameters function, press [F8] (EG).

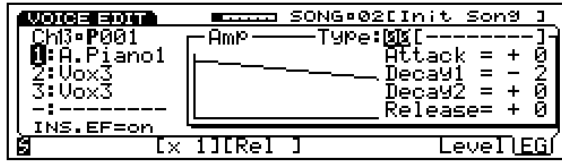

ATTACK/HOLD (-63 ~ +63) - Position the cursor over the Attack/Hold value field and use the JOG, INC/DEC or the KEYPAD to determine the attack or hold offset of the AEG. (Which parameter appears on the display depends on the selected element.) The attack and hold mode offset affects the initial attack of the sound, determining how the amplitude envelope begins. In elements which utilize the *attack* mode, the envelope begins from zero level, reaching the maximum AWM level at a rate determined by the attack setting. In elements which utilize the *hold* mode, the envelope begins immediately from maximum AWM level, allowing the fast attack transients of waveforms to pass unaffected. The hold setting of the attack determines the length of time the envelope reaches maximum volume level, between the beginning of the envelope and the point at which the envelope begins to move towards Decay 1.

DECAY 1 (-63 ~ +63) - Position the cursor over the Decay 1 offset field and use the JOG, INC/DEC or the KEYPAD to determine the length of time of the first decay of the sound, between the maximum level and Decay 2.

DECAY 2 (-63 ~ +63) - Position the cursor over the Decay 2 offset field and use the JOG, INC/DEC or the KEYPAD to determine the length of time of the second decay of the sound, between Decay 1 and key-off.

RELEASE (-63 ~ +63) - Position the cursor over the Release offset field and use the JOG, INC/DEC or the KEYPAD to determine the amount of time it takes for the sound to reach zero volume after the key is released.

TIME RANGE (x 1, x 2, x 5, x 10, x 20, x 50) - Pressing [F3] selects the time range of the EG graphic display, where x 1 displays the shortest time in the most detail.

SEGMENT (Seg 1 ~ 3, Koff, Rel) - Pressing [F4] selects the particular segment of the EG which is displayed.

TEMPLATE TYPE (00 ~ 39) - See Level, above.

The EG will function in two ways, depending on the Attack or Hold mode.

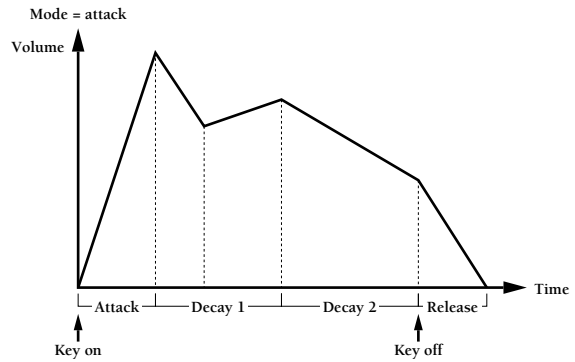

In attack mode the EG level will begin from 0 and rise to its maximum level as determined by the attack setting. When maximum level is achieved the sound will start decaying and move at the rate of the Decay 1 setting. When Decay 1 is achieved the sound will move at the rate of the Decay 2 setting to zero. (If the Decay 2 rate is 0 or less, the sound will move at an infinitely slow rate toward zero, i.e., it will sustain at Decay 2 as long as the key is pressed.) When you release the key, the level will move towards zero at the rate of the Release setting.

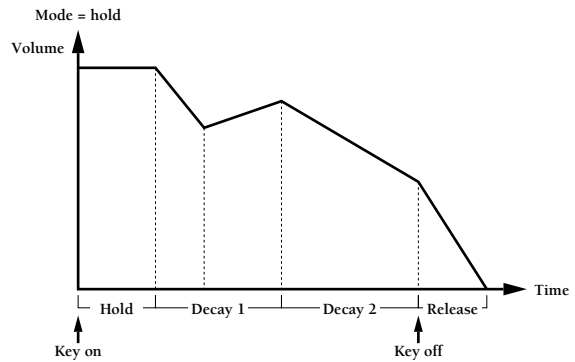

In hold mode the EG level will begin at maximum level and stay there for the duration of the specified Hold setting. When the hold time has elapsed, the level will change and move according to the Decay 1 setting. When Decay 1 is achieved the sound will move at the rate of the Decay 2 setting to zero. (If the Decay 2 rate is 0 or less, the sound will move at an infinitely slow rate toward zero, i.e., it will sustain at Decay 2 as long as the key is pressed.) When you release the key, the level will move towards zero at the rate of the Release setting.

Hold mode is especially effective with elements which include a strong attack, since keeping the level at maximum for a while allows the natural attack of the AWM sample to be heard. After the natural attack is over the AWM waveform will continue sustaining, and you can use the remaining EG parameters to create an appropriate decay and release.

VOICE MODE

FILTER

The Filter parameters function lets you perform operations which determine the characteristics of the tone.

The filter can be used to greatly modify the sound. Filter parameters let you determine the cutoff frequency (i.e., the frequency at which the filter begins to affect the sound), cutoff scaling and settings for the filter envelope generator (FEG). The filter removes a specified range of frequencies from the sound and allows the rest to pass through, thus giving you powerful control over a sound's characteristics. For example, if the high frequencies are removed and the low frequencies are allowed to pass through, the result will be a darker sound, since the lower range is emphasized and the upper range is de-emphasized. This type of filter is called a Low Pass Filter, or LPF. The various types of filters include the following:

LPF (Low Pass Filter) - The LPF produces a filter response that allows only frequencies below the cutoff frequency to pass. The LPF filter type has a steep 24-dB/octave cutoff slope.

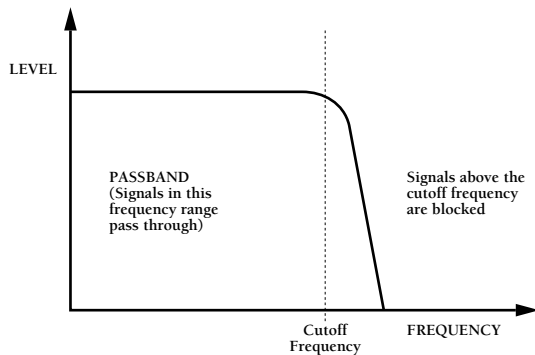

HPF (High Pass Filter) - The HPF produces a filter response that allows only frequencies above the cutoff frequency to pass.

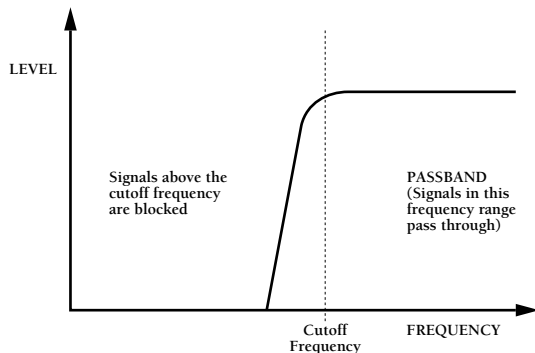

BPF (Band Pass Filter) - The BPF produces a filter response that allows only a band of frequencies centered at the cutoff frequency to pass. The band parameter determines the width of the pass band.

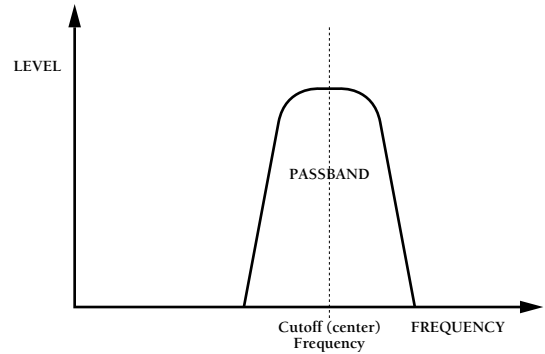

BEF (Band Elimination Filter) - The BEF produces a filter response that eliminates a band of frequencies centered at the cutoff frequency to pass. The band parameter determines the width of the elimination band.

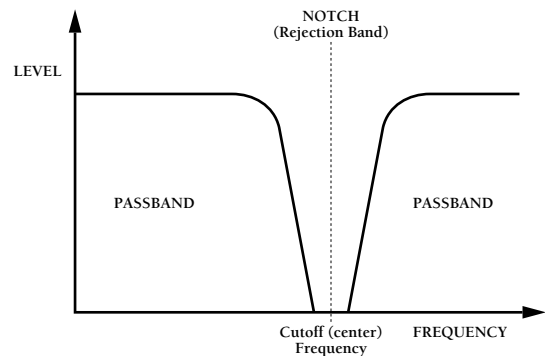

THRU (Through) - The THRU setting allows all frequencies to pass through, i.e., no filter is applied.

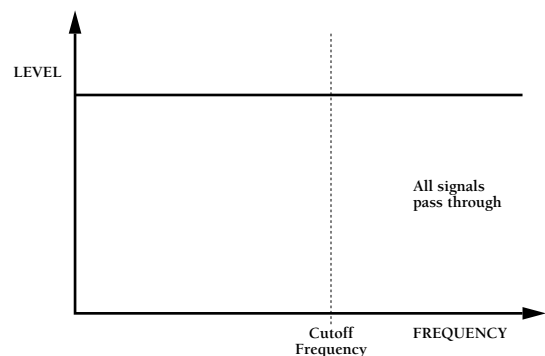

You can also control the filter by key velocity sensitivity by EG or low frequency oscillator (LFO). The velocity changes affect the attack portion. Applying LFO to the filter creates filter modulation, or wah-wah. A specified controller (such as modulation wheel or foot controller) can be used to adjust the depth of the filter modulation caused by the LFO. Depending on the filter selected, EG or LFO is displayed in the screen.

● ACCESSING FILTER PARAMETERS

To access the Filter parameters function, from within Voice Edit Mode, press [F4] (Filt) or TRACK [12].

TONE- To specify the filter Tone parameters for each element, from within the Filter parameters function, press [F7] (Tone).

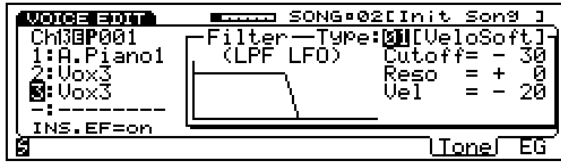

CUTOFF (-127 ~ +127) - Position the cursor over the Cutoff offset field and use the JOG, INC/DEC or the KEYPAD to set the cutoff frequency, or the frequency at which the filter begins to affect the sound, for the selected element. Lower cutoff values produce a lower cutoff frequency and higher values produce a higher cutoff frequency. With an LPF response, a lower cutoff frequency reduces the range of high frequencies passed, thus making the sound darker, or rounder. With an HPF response, a higher cutoff frequency reduces the range of low frequencies passed, thus making the sound thinner, or sharper.

RESONANCE/BAND (-99 ~ +99) - Position the cursor over the Reso./Band offset field and use the JOG, INC/DEC or the KEYPAD to determine filter resonance or bandwidth settings (depending on the current filter type). Resonance determines the degree of filter resonance when the LPF filter is activated. This parameter has a similar effect to the resonance settings on traditional analog synthesizer filters, i.e., it determines the height of a peak in the filter response at the cutoff frequency. Higher resonance values produce a higher resonant peak and reduce the overall bandwidth of the filter, passing a narrow band of frequencies at the filter's cutoff. Band determines the width of the frequency pass for the BPF (Band Pass Filter) or elimination band for the BEF (Band Elimination Filter). The minimum setting of -99 produces an extremely narrow pass or elimination band, while the maximum setting of +99 produces a wide pass or elimination band.

VELOCITY SENSITIVITY (-127 ~ +127) - Position the cursor over the Vel. offset field and use the JOG, INC/DEC or the KEYPAD to determine the amount of tonal change produced by the FEG. Positive settings permit strongly played notes to cause a greater change in tone. Negative settings permit lightly played notes to cause a greater change in tone.

VELOCITY BAND SENSITIVITY (-63 ~ +63) - Position the cursor over the V.Band offset field (displayed when the filter type is a BPF or BEF) and use the JOG, INC/DEC or the KEYPAD to determine how the filter cutoff frequency changes in response to velocity changes (keyboard dynamics) as you play. Positive settings produce higher cutoff frequencies in response to higher velocity values, i.e., the harder a key is played, the higher the cutoff frequency will be. The maximum setting of +63 produces the maximum level variation in response to velocity changes. Negative settings produce the opposite effect lower cutoff in response to higher velocity. A setting of +0 results in no cutoff variation.

TEMPLATE TYPE (00 ~ 59) - Position the cursor over the Type number field and use the JOG, INC/DEC or the KEYPAD to select the type of filter envelope generator (FEG) *template*, which gives you instant access to the basic EG shapes of many types of sounds. There are a wide variety of EG types to choose from, including those from all major acoustic and many electronic instruments. A setting of 00 is the default EG for the preset voice. The Thru setting turns the filter off. The type of EG shape selected will determine the levels of each EG segment (Attack, Decay 1, Decay 2, Release). (To see a list of the various template types, refer to the W5/W7 *Technical Information* booklet, provided separately.)

NOTE: The template type determines the maximum and minimum range. Therefore, an offset which exceeds the range of the template type will have no effect.

FILTER ENVELOPE GENERATOR - To specify the Filter Envelope Generator (FEG) parameters, from within the Filter parameters function, press [F8] (EG).

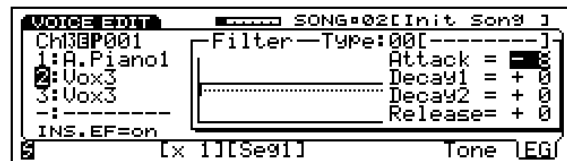

ATTACK (-63 ~ +63) - Position the cursor over the Attack offset field and use the JOG, INC/DEC or the KEYPAD to determine the attack rate of the FEG. The attack rate determines how the filter envelope begins. A value of 0 represents normal level. Negative values cause the attack to begin below normal level. Positive values cause the attack to begin above normal level.

DECAY 1 (-63 ~ +63) - Position the cursor over the Decay 1 offset field and use the JOG, INC/DEC or the KEYPAD to determine the length of time of the first decay of the sound, between the maximum level and Decay 2.

DECAY 2 (-63 ~ +63) - Position the cursor over the Decay 2 offset field and use the JOG, INC/DEC or the KEYPAD to determine the length of time of the second decay of the sound, between Decay 1 and key-off.

RELEASE (-63 ~ +63) - Position the cursor over the Release offset field and use the JOG, INC/DEC or the KEYPAD to determine the amount of time it takes for the sound to reach zero volume after the key is released.

TIME RANGE (x 1, x 2, x 5, x 10, x 20, x 50) - Pressing [F3] selects the time range of the EG graphic display, where x 1 displays the shortest time in the most detail.

SEGMENT (Seg 1 ~ 3, Koff, Rel) - Pressing [F4] selects the particular segment of the EG which is displayed.

TEMPLATE TYPE (00 ~ 59) - See Tone, above.

The filter EG is entirely separate from the amplitude EG, and is used specifically to create time-based timbre variations. It can be used to simulate the natural timbre variations produced by acoustic instruments, or to create more pronounced electronic effects.

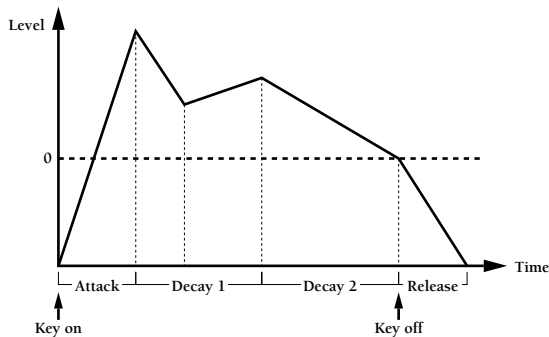

In the above example, when the note is pressed, the envelope begins at zero (normal level) as determined by the Attack setting, reaching the maximum level as determined by the EG type. When the attack phase is achieved, the envelope moves to Decay 1 at the specified Decay 1 rate, then moves to Decay 2 at the specified Decay 2 rate. When the key is released, the sound fades according to the specified Release rate.

PITCH

The Pitch parameters function lets you perform operations which determine how the pitch changes over time. The pitch change over time, created by the pitch envelope generator (PEG), can be controlled by key-on velocity for each note. The speed of the pitch change can be adjusted across the keyboard.

● ACCESSING PITCH PARAMETERS

To access the Pitch parameters function, from within Voice Edit Mode, press [F5] (Pitch) or TRACK [13].

SCALE - To specify the Scale parameters for each element, from within the Pitch parameters function, press [F4] (Scale).

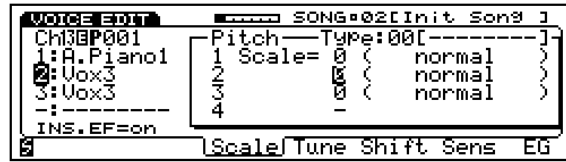

KEYBOARD PITCH SCALE (0 ~ 4) - Position the cursor over the Scale setting field and use the JOG, INC/DEC or the KEYPAD to adjust the pitch change of the selected element across the keyboard .

0 (normal) - Normal pitch setting, or equal temperament.

1 (50 cents/key) - Starting at C3, the pitch changes 50 cents from key to key.

2 (20 cents/key) - Starting at C3, the pitch changes 20 cents from key to key.

3 (10 cents/key) - Starting at C3, the pitch changes 10 cents from key to key.

4 (5 cents/key) - Starting at C3, the pitch changes 5 cents from key to key.

TEMPLATE TYPE (00 ~ 40) - Position the cursor over the Type number field and use the JOG, INC/DEC or the KEYPAD to select the type of pitch envelope generator (PEG) *template*, which gives you instant access to the basic EG shapes of many types of sounds. There are a wide variety of EG types to choose from, including those from all major acoustic and many electronic instruments. A setting of 00 is the default EG for the preset voice. (To see a list of the various template types, refer to the W5/W7 *Technical Information* booklet, provided separately.)

NOTE: The template type determines the maximum and minimum range. Therefore, an offset which exceeds the range of the template type will have no effect.

TUNE - To specify the Tune parameters for each element, from within the Pitch parameters function, press [F5] (Tune).

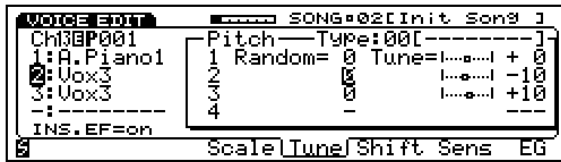

RANDOM (0 ~ 7) - Position the cursor over the Random value field and use the JOG, INC/DEC or the KEYPAD to specify the intensity of random pitch shift of the element.

TUNE (-63 ~ +63) - Position the cursor over the Tune value field and use the JOG, INC/DEC or the KEYPAD to adjust fine tuning of the element.

TEMPLATE TYPE (00 ~ 40) - See Keyboard Pitch Scale, above.

NOTESHIFT - To specify the Note Shift parameters, from within the Pitch parameters function, press [F6] (Shift).

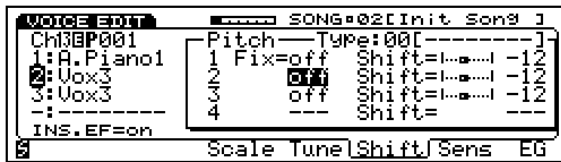

FIX (off/on) - Position the cursor over the Fix status field and use the JOG or INC/DEC to turn the Note Shift Fix on or off.

OFF - When set to off, you can *shift*, or detune, the element by the number of semitones as specified by the Shift parameter (see below).

ON - When set to on the element will sound at the same pitch across the entire range of the keyboard, according to the note as specified by the Note parameter (see below). (NOTE: Switching the Note Shift Fix to on status disables the Keyboard Pitch Scale function.)

SHIFT/NOTE (-64 ~ +63 / C-2 ~ G8) - When the Fix parameter (see above) is off, position the cursor over the Shift value field and use the JOG, INC/DEC or the KEYPAD to specify the number of semitones you want to *shift*, or detune, the element. When the Fix parameter is on, position the cursor over the Note field and use the JOG or INC/DEC to specify the note you want to sound across the entire range of the keyboard.

TEMPLATE TYPE (00 ~ 40) - See Keyboard Pitch Scale, above.

SENSITIVITY - To specify the Sensitivity parameters, from within the Pitch parameters function, press [F7] (Sens).

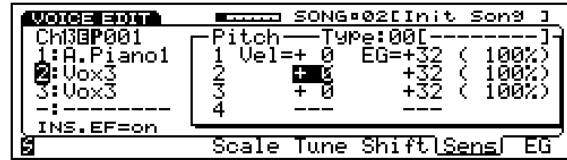

VELOCITY SENSITIVITY (-14 ~ +14) - Position the cursor over the Vel value field and use the JOG, INC/DEC or the KEYPAD to specify how velocity will control the pitch change of the element. Positive values permit strongly played notes to cause a greater change in pitch. Negative settings permit lightly played notes to cause a greater change in pitch.

EG RANGE (-63 ~ +63) - To set the total amount of pitch changes against the original pitch of the element. Setting 0 cause no change in pitch.

TEMPLATE TYPE (00 ~ 40) - See Keyboard Pitch Scale, above.

PITCH ENVELOPE GENERATOR - To specify the EG parameters, from within the Pitch parameters function, press [F8] (EG).

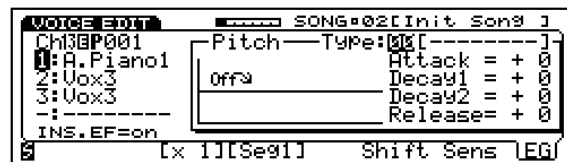

ATTACK (-63 ~ +63) - Position the cursor over the Attack offset field and use the JOG, INC/DEC or the KEYPAD to determine the attack rate of the FEG. The attack rate determines how the filter envelope begins. A value of 0 represents normal level. Negative values cause the attack to begin below normal level. Positive values cause the attack to begin above normal level.

DECAY 1 (-63 ~ +63) - Position the cursor over the Decay 1 offset field and use the JOG, INC/DEC or the KEYPAD to determine the length of time of the first decay of the sound, between the maximum level and Decay 2.



DECAY 2 (-63 ~ +63) - Position the cursor over the Decay 2 offset field and use the JOG, INC/DEC or the KEYPAD to determine the length of time of the second decay of the sound, between Decay 1 and key-off.

RELEASE (-63 ~ +63) - Position the cursor over the Release offset field and use the JOG, INC/DEC or the KEYPAD to determine the amount of time it takes for the sound to reach zero volume after the key is released.

TIME RANGE (x 1, x 2, x 5, x 10, x 20, x 50) - Pressing [F3] selects the time range of the EG graphic display, where x 1 displays the shortest time in the most detail.

SEGMENT (Seg 1 ~ 3, Koff, Rel) - Pressing [F4] selects the particular segment of the EG which is displayed.

TEMPLATE TYPE (00 ~ 40) - See Keyboard Pitch Scale, above.

The pitch EG is entirely separate from the filter and amplitude EGs, and is used to create a fixed shape of pitch change over time.

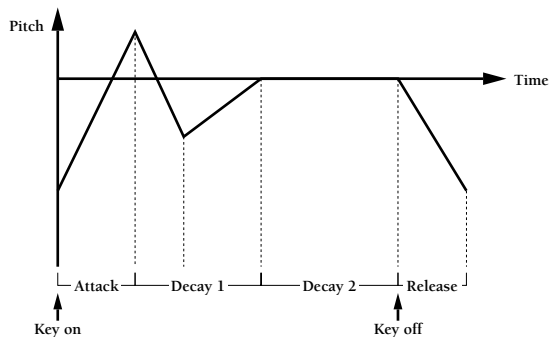

In the above example, when the note is pressed, the envelope begins at the specified attack rate then reaches its maximum level, at which point it moves towards Decay 1 at the specified Decay 1 rate. When the Decay 2 phase is initiated, the pitch envelope will remain at Decay 2 as long as the key is pressed.

EFFECT

The Effect parameters function lets you perform effects related operations for the voice, including designating Insertion Effect type, parameter, control and on/off status, plus determining the three System Effect send levels for the voice.

● ACCESSING EFFECT PARAMETERS

To access the Effect parameters function, from within Voice Edit Mode, press [F6] (Efect) or TRACK [14].

SYSTEM EFFECT SEND LEVEL - To specify each System Effect Send Level for the voice, from within the Effect parameters function, press [F5] (SysEF).

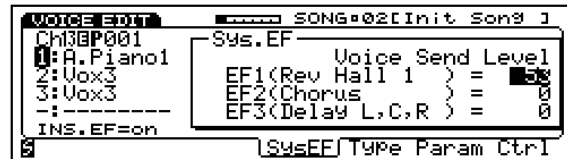

EF1/2/3 (0 ~ 127) - Position the cursor over the EF1 , EF2 , or EF3 value field and use the JOG, INC/DEC or the KEYPAD to set the send level for each of the three System Effects.

NOTE: The types of System Effects, their return levels, and their parameters can only be accessed and specified in Song Play Mode, when the cursor is positioned over a System Effect on the mixer. (For more information, see System Effects, page 79.)

INSERTION EFFECT TYPE - To specify the type of Insertion Effect for the voice, from within the Effect parameters function, press [F6] (Type).

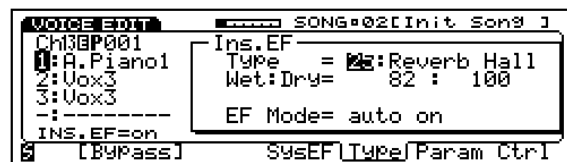

TYPE (00 ~ 35) - Position the cursor over the Type number field and use the JOG, INC/DEC or the KEYPAD to select which type of Insertion Effect is assigned to the voice.

EFFECT MODE (auto off, auto on) - Position the cursor over the EF Mode select field and use the JOG or INC/DEC to set the on/off status for the selected insertion effect in the multi.

INSERTION EFFECT PARAMETER - To modify the parameters of the specified Insertion Effect for the voice, from within the Effect parameters function, press [F7] (Param).

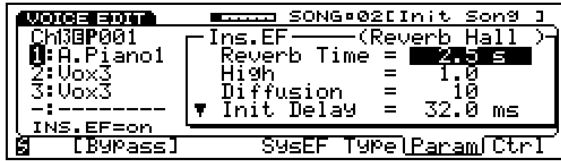

PARAMETERS - Position the cursor over a parameter value field with CURSOR-UP/DOWN and use the JOG or INC/DEC to enter a value. (NOTE: The black downward-pointing arrow in the lower left of the parameter display indicates that the list of editable parameters continues.)

NOTE: The accessible parameters depend on the selected Insertion Effect type. For a complete listing of Insertion Effect Types and Parameters, see the *W5/W7 Technical Information* booklet.

NOTE: When a specific parameter is set to be controlled by the Insertion Effect Control (see following), a C mark will display to the right of the parameter.

INSERTION EFFECT CONTROL - To specify the Insertion Effect Control parameters for the voice, from within the Effect parameters function, press [F8] (Ctrl).

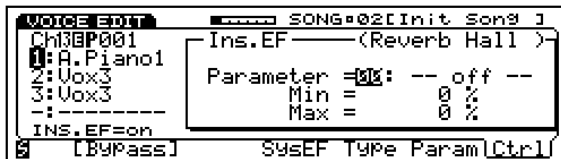

PARAMETER (off, 1 ~ 12) - Position the cursor over the Parameter select field and use the JOG or INC/DEC to designate the specific Insertion Effect parameter to control through the MIDI Control 1 or MIDI Control 2 function. (For details, see MIDI Control, page 124).

MIN/MAX (0 ~ 100%) - Position the cursor over the Min or Max value field and use the JOG, INC/DEC or the KEYPAD to set the range of minimum and maximum values by which the parameter will respond to the MIDI Control message.

NOTE: Depending on the Insertion Effect Type, you can adjust the balance of the effect signal level in relation to the original voice signal level. For example, some effect types will display a wet:dry = 60% parameter that lets you adjust the amount of effect signal level. Other effect types will display wet:dry = 60:100 parameters that let you adjust the amount of effect signal level (wet signal) as well as original voice signal level (dry signal).

NOTE: When selecting and modifying Insertion Effect Parameters (Type , Param , Ctrl), the word Bypass will appear above function key [F2], which acts as a compare function. By pressing [F2] (Bypass) you can bypass the Insertion Effect and hear the voice without the Insertion Effect applied, in order to compare the original voice to the voice with Insertion Effect applied as you set the Insertion Effect parameters. When the Insertion Effect is bypassed, the word Bypass will appear in reverse type. When you exit Voice Edit Mode, the bypass will become inactive.

Special conditions regarding the Insertion Effect include the following:

RECORDING - Any Insertion Effect on/off changes you make during recording will not be recorded by the sequencer.

VOICEPLAYMODE - Entering Voice Play Mode will always switch the Insertion Effect for the selected voice on. When selecting tracks the Insertion Effect for the selected track will always be turned on, regardless of its setting, and the Insertion Effects for any other tracks will be turned off. Whenever a program change message is received by the currently selected track, the Insertion Effect for the Instrument voice assigned to the track is always turned on. Any song select messages from an external device is ignored, and the Insertion Effect switch parameter change is also ignored.

VOICEEDITMODE - When you enter Voice Edit Mode, if the Insertion Effect on/off switch in the song multi is set to on , the Insertion Effect will be turned on; if the on/off switch in the song multi is set to off , the Insertion Effect will be turned off.

LFO

The LFO parameters function lets you perform operations which determine how the Low Frequency Oscillator controls the voice.

The LFO creates a cyclically changing control signal that can be used to create amplitude modulation (tremolo), pitch modulation (vibrato), and filter modulation (wah-wah). The W5/W7's LFO can produce various types, or shapes, of modulation waves, including triangle, square, sine, and assorted sawtooth waves and others, plus sample & hold, which produces a control signal whose level will change randomly at intervals of time which you can determine by speed.

● ACCESSING LFO PARAMETERS

To access the LFO parameters function, from within Voice Edit Mode, press [F7] (LFO) or TRACK [15].

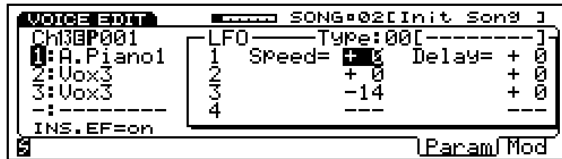

PARAMETER - To specify the Parameter settings for each element, from within the Parameter function, press [F7] (Param).

SPEED (-99 ~ +99) - Position the cursor over the Speed value field and use the JOG, INC/DEC or the KEYPAD to set the speed of the LFO modulation. Higher settings result in faster modulation, and lower settings result in slower modulation.

DELAY (-99 ~ +99) - Position the cursor over the Delay value field and use the JOG, INC/DEC or the KEYPAD to set the time delay before the LFO modulation begins.

TEMPLATE TYPE (00 ~ 33) - Position the cursor over the Type number field and use the JOG, INC/DEC or the KEYPAD to select the type, or shape of the LFO modulation wave *template*. A setting of 00 is the default shape for the preset voice. (To see a list of the various LFO template types, refer to the W5/W7 *Technical Information* booklet, provided separately.)

NOTE The template type determines the maximum and minimum range. Therefore, an offset which exceeds the range of the template type will have no effect.

MODULATION - To specify the Modulation parameters for each element, from within the Parameter function, press [F8] (Mod).

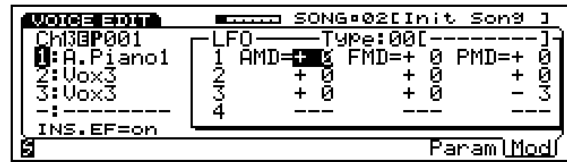

AMPLITUDE MODULATION DEPTH (-99 ~ +99) - Position the cursor over the AMD value field and use the JOG, INC/DEC or the KEYPAD to determine how greatly the LFO will affect the output level (amplitude) of the element.

FILTER MODULATION DEPTH (-99 ~ +99) - Position the cursor over the FMD value field and use the JOG, INC/DEC or the KEYPAD to determine how greatly the LFO will affect the cutoff frequency of the filter.

PITCH MODULATION DEPTH (-99 ~ +99) - Position the cursor over the PMD value field and use the JOG, INC/DEC or the KEYPAD to determine how greatly the LFO will affect the pitch of the element.

TEMPLATE TYPE (00 ~ 33) - (See Parameter, above.)

CONTROLLER

The Controller parameters function screen lets you perform operations which determine the status of the various controllers, including pitch bend and modulation wheels, sustain, aftertouch, foot control and MIDI control.

● ACCESSING CONTROLLER PARAMETERS

To access the Controller parameter function, from within Voice Edit Mode, press [F8] (Ctrl) or TRACK [16].

SUSTAIN - To specify the Sustain parameters for each element, from within the Controller parameters function, press [F2] (Sus).

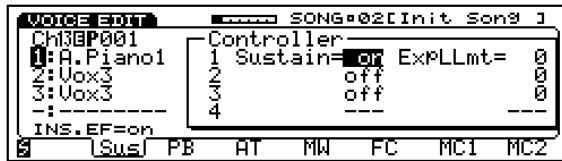

SUSTAIN (off, on) - Position the cursor over the Sustain status field and use the JOG or INC/DEC to switch the sustain controller on or off. When switched on, the foot switch will control sustain on and off when the foot switch is connected to the SUSTAIN jack on the rear panel.

EXPRESSION LOW LIMIT (0 ~ 127) - Position the cursor over the ExpLLmt value field and use the JOG, INC/DEC or the KEYPAD to set the minimum volume for the foot controller (i.e., volume pedal) connected to the FOOT VOLUME jack on the rear panel.

NOTE: The Expression Low Limit Setting will have no effect unless you set the Foot Volume assignment to 011 (see Utility Mode, Controllers, Expression, page 147).

PITCHBEND - To specify the Pitch Bend status for each element and Pitch Bend settings which affect all elements equally, from within the Controller parameters function, press [F3] (PB).



PITCH BEND (off, on) - Position the cursor over the PB status field and use the JOG or INC/DEC to switch the pitch bend controller on or off for each element.

PITCH BEND RANGE (0 ~ 12) - Position the cursor over the PB Range value field and use the JOG, INC/DEC or the KEYPAD to determine how much the pitch will change (for all elements equally) when moving the pitch bend wheel.

AFTERTOUCH PITCH BEND RANGE (-12 ~ +12)

- Position the cursor over the AT P. Bend value field and use the JOG, INC/DEC or the KEYPAD to determine how much the pitch will change (for all elements equally) by aftertouch. (NOTE: The aftertouch parameter must be switched to on status. See Aftertouch, below.)

AFTERTOUCH - To specify the Aftertouch parameters for each element and Aftertouch settings which affect all elements equally, from within the Controller parameters function, press [F4] (AT).

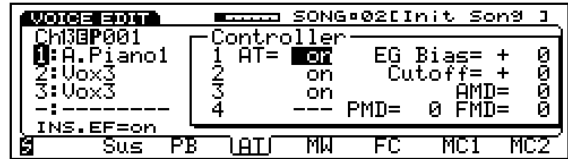

AFTERTOUCH (off, on) - Position the cursor over the AT status field and use the JOG or INC/DEC to switch the aftertouch controller on or off for each element.

EG BIAS (-127 ~ +127) - Position the cursor over the EG Bias value field and use the JOG, INC/DEC or the KEYPAD to determine how much the amplitude EG (for all elements equally) is increased or decreased by aftertouch.

CUTOFF (-127 ~ +127) - Position the cursor over the Cutoff value field and use the JOG, INC/DEC or the KEYPAD to determine how the cutoff frequencies (for all elements equally) are controlled by aftertouch. Positive settings cause the cutoff frequencies to increase when a key is pressed harder.

AMPLITUDE MODULATION DEPTH (0 ~ 127)

- Position the cursor over the AMD value field and use the JOG, INC/DEC or the KEYPAD to determine how greatly aftertouch will affect the output level (amplitude) of all elements equally.

PITCH MODULATION DEPTH (0 ~ 127)

- Position the cursor over the PMD value field and use the JOG, INC/DEC or the KEYPAD to determine how greatly aftertouch will affect the pitch of all elements equally.

FILTER MODULATION DEPTH (0 ~ 127)

- Position the cursor over the FMD value field and use the JOG, INC/DEC or the KEYPAD to determine how greatly aftertouch will affect the cutoff frequencies of the filter (for all elements equally).

VOICE MODE

MODULATION WHEEL - To specify the Modulation Wheel parameters for each element and Modulation Wheel settings which affect all elements equally, from within the Controller parameters function, press [F5] (MW).

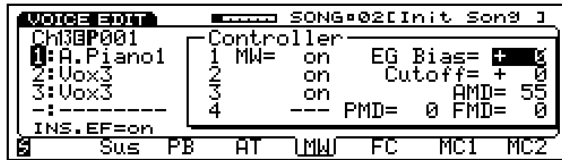

MODULATION WHEEL (off, on) - Position the cursor over the MW status field and use the JOG or INC/DEC to switch the modulation wheel controller on or off for each element.

EG BIAS (-127 ~ +127) - Position the cursor over the EG Bias value field and use the JOG, INC/DEC or the KEYPAD to determine how much the amplitude EG (for all elements equally) is increased or decreased by the modulation wheel.

CUTOFF (-127 ~ +127) - Position the cursor over the Cutoff value field and use the JOG, INC/DEC or the KEYPAD to determine how the cutoff frequencies (for all elements equally) are controlled by the modulation wheel. Positive settings cause the cutoff frequencies to increase when the modulation wheel is at maximum position.

AMPLITUDE MODULATION DEPTH (0 ~ 127) - Position the cursor over the AMD value field and use the JOG, INC/DEC or the KEYPAD to determine how greatly the modulation wheel will affect the output level (amplitude) of all elements equally.

PITCH MODULATION DEPTH (0 ~ 127) - Position the cursor over the PMD value field and use the JOG, INC/DEC or the KEYPAD to determine how greatly the modulation wheel will affect the pitch of all elements equally.

FILTER MODULATION DEPTH (0 ~ 127) - Position the cursor over the FMD value field and use the JOG, INC/DEC or the KEYPAD to determine how greatly the modulation wheel will affect the cutoff frequencies of the filter (for all elements equally).

FOOT CONTROLLER - To specify the Foot Controller status for each element and Foot Controller settings which affect all elements equally, from within the Controller parameters function, press [F6] (FC).

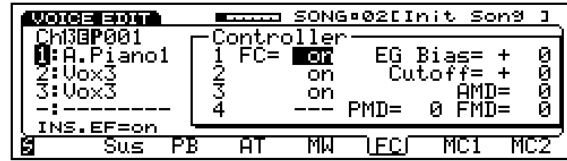

FOOT CONTROLLER (off, on) - Position the cursor over the FC status field and use the JOG or INC/DEC to switch the foot controller on or off for each element, when a foot switch is connected to the FOOT CONTROLLER jack on the rear panel.

EG BIAS (-127 ~ +127) - Position the cursor over the EG Bias value field and use the JOG, INC/DEC or the KEYPAD to determine how much the amplitude EG (for all elements equally) is increased or decreased by the foot controller.

CUTOFF (-127 ~ +127) - Position the cursor over the Cutoff value field and use the JOG, INC/DEC or the KEYPAD to determine how the cutoff frequencies (for all elements equally) are controlled by the foot controller. Positive settings cause the cutoff frequencies to increase when the foot controller is at maximum position.

AMPLITUDE MODULATION DEPTH (0 ~ 127) - Position the cursor over the AMD value field and use the JOG, INC/DEC or the KEYPAD to determine how greatly the foot controller will affect the output level (amplitude) of all elements equally.

PITCH MODULATION DEPTH (0 ~ 127) - Position the cursor over the PMD value field and use the JOG, INC/DEC or the KEYPAD to determine how greatly the foot controller will affect the pitch of all elements equally.

FILTER MODULATION DEPTH (0 ~ 127) - Position the cursor over the FMD value field and use the JOG, INC/DEC or the KEYPAD to determine how greatly the foot controller will affect the cutoff frequencies of the filter (for all elements equally).

MIDI CONTROL 1/2 - To specify the status of the two MIDI Control functions for each element, and the MIDI Control settings which affect all elements equally, from within the Controller parameters function, press [F7] (MC1) or [F8] (MC2).

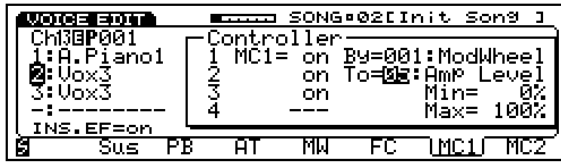

MIDI CONTROL 1/2 (off, on) - Position the cursor over the MC1 (or MC2) status field and use the JOG or INC/DEC to switch MIDI Control on or off for each element.

BY (off, 1 ~ 119 excl. 32) - Position the cursor over the By number field and use the JOG, INC/DEC or the KEYPAD to designate the type of control change message that will affect the parameter (for all elements equally) as specified in the To number field (see below).

TO (0 ~ 29) - Position the cursor over the By number field and use the JOG, INC/DEC or the KEYPAD to specify the parameter that will be controlled by the control change as specified in the By number field (see above).

MIN/MAX (0% ~ 100%) - Position the cursor over the Min or Max value field and use the JOG, INC/DEC or the KEYPAD to determine the range that the parameter will respond to the MIDI control message.

The Parameters that will be controlled

To (Parameter Assign)	To (Parameter Assign)	To (Parameter Assign)
0 off	10 Filter Cutoff	20 PEG Release
1 Ins.EF *1	11 Filter Resonance	21 Elem Random
2 Sys.EF1 Send	12 Filter Band	22 Elem Tune
3 Sys.EF2 Send	13 Filter Vel Sens	23 Elem Pan
4 Sys.EF3 Send	14 FEG Attack	24 Elem Exp Low Limit
5 Amp Level	15 FEG Decay *2	25 LFO Speed
6 Amp Vel Sens	16 FEG Release	26 LFO Delay
7 AEG Attack	17 PEG Vel Sens	27 LFO PMD
8 AEG Decay *2	18 PEG Attack	28 LFO AMD
9 AEG Release	19 PEG Decay *2	29 LFO FMD

*1 The same as the parameter set in the Insertion Effect Control.
 *2 May be different from the Decay 1 change.

DRUM VOICE EDIT MODE

Drum Voice Edit Mode lets you construct your own drum kits.

● ENTERING AND EXITING DRUM VOICE EDIT MODE

To enter Drum Voice Edit Mode, from within Track 10 (the drum voice track) or the track to which a drum voice is assigned, press the VOICE EDIT button. The screen will display a menu of the four main drum voice editing functions. To exit the Voice Edit Mode, simply press EXIT or any other MODE button.



● ACCESSING VOICE EDIT PARAMETERS

To access the drum voice edit parameters, use the function keys [F1, F2, F6, F8] which correspond to the names of the edit functions at the bottom of the screen, or use the CURSOR keys to position the cursor over the various parameter name blocks in the display, followed by ENTER. You can also access the respective drum voice edit parameters by pressing TRACK buttons [9, 10, 14, 16]. From within any voice edit function you can jump directly to another voice edit function by holding down the SHIFT key and pressing the appropriate function key.

COMMON - For accessing those parameters common to all drum sounds in the voice, including volume, name and initialize.

KEY - For assigning an element to each key number (C0 ~ C6), plus setting each element's volume, pan, tuning and System Effect send level.

EFFECT - For determining Insertion Effect type, parameter, control and on/off status, plus the system effect send level for the voice.

CONTROL - For determining the function and status of the MIDI control and expression low limit.

COMMON PARAMETER

The Common parameters function lets you perform operations which affect all elements or the entire drum voice.

● ACCESSING COMMON PARAMETERS

To access the common parameter function, from within Voice Edit Mode, press [F1] (Com) or TRACK [9].



VOLUME - To designate the Voice Category or set the volume for the voice, press [F6] (Vol).

CATEGORY (21 types) - For choosing the two-letter voice category code for the voice. Choose a voice category with the JOG or INC/DEC. (For a complete list of the different voice categories, refer to page 27.)

VOLUME (0 ~ 127) - For adjusting the overall output volume of the voice. Position the cursor over the numeric value and enter a new number with the JOG, INC/DEC, or the KEYPAD.

NAME (10 characters) - To name a voice, press [F7] (Name). Position the pointer over a letter space with [F4] and [F5], and choose a character with the JOG dial, INC/DEC buttons, or CURSOR keys. A space can be entered by pressing [F3] ([SPC]).



NOTE: You can name the currently editing drum voice, but you cannot name the drum sounds on each key.

INITIALIZE - To initialize the Internal drum voice (1 or 2) which will assign the standard GM kit #01 to the voice, press [F8] (Init). Press ENTER to engage the initialization process. To initialize the voice, press INC. To abort the operation, press DEC.

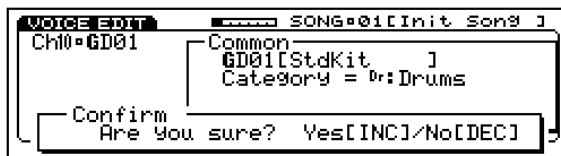

NOTE: The initialization affects all key assignments in the voice.

KEY PARAMETER

The key parameter function lets you perform operations which determine the fundamental characteristics of the drum voice.

● ACCESSING KEY PARAMETERS

To access the key parameters function, from within Voice Edit Mode, press [F2] (Key) or TRACK [10].

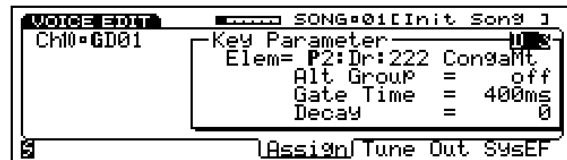

ASSIGN - To designate which element will be assigned to each key, press [F5] (Assign). Within Key Assign you can specify the element bank and designate the AWM sample (i.e., the element number) within it to assign to each key. To select either the element bank or the element number, use the CURSOR-LEFT and CURSOR-RIGHT keys. To select key, alternate group, gate time or decay, use the CURSOR-UP and CURSOR-DOWN keys.

NOTE: You can assign only one element to each key. So any edit operations that you perform on the element will affect only the key the element is assigned to.

KEY SELECT (C0 ~ C6) - To select the key you want to assign an element to, position the cursor over the key select field and use the JOG or INC/DEC, or simply press the specific key on the keyboard.

ELEMENT BANK SELECT (off, P.1 [Preset 1], P.2 [Preset 2], I [Internal], S [Song], E [External]) - Position the cursor over the bank field and use the JOG or INC/DEC to choose the element bank. When the W5/W7 is shipped from the factory, the two preset element banks are the only banks with samples in them. (For a listing of the elements, refer to the Element List in the W5/W7 Technical Information booklet, provided separately.)

NOTE: Bank E is accessible only if the optional Expansion Wave/Voice Expansion Board has been installed. Banks 1 and S contain no data and will therefore display *****. These banks are reserved as space for additional Internal and Song elements which may be loaded into the W5/W7 by optional song disks. If Song elements are loaded they will be cleared when the power is turned off.

ELEMENT NUMBER SELECT - Position the cursor over the element number field and use the JOG, INC/DEC or the KEYPAD to choose the desired element.

NOTE: Key Select, Element Bank Select, and Element Number Select can be performed within any Key Parameter function.

ALTERNATE GROUP (off, 1 ~ 8) - Position the cursor over the Alt.Group setting field and use the JOG, INC/DEC or the KEYPAD to assign the element to a specific group, so that only one sound within the group will play at a time. Assigning certain sounds to a group will prevent unnatural occurrences such as a closed and open hi-hat sounding at the same time. If you assign both of these instruments to one of the alternate groups, the closed and open hi-hat will not sound simultaneously even if you play them at the same time.

GATE TIME (keyoff, 200ms, 400ms, 650ms, 1000ms, 1400ms, 2000ms, 2600ms) - Position the cursor over the Gate Time value field and use the JOG or INC/DEC to determine the gate time for the assigned element. Gate Time is especially useful for sustained sounds like a crash symbol.

DECAY (0 ~ 31) - Position the cursor over the Decay value field and use the JOG, INC/DEC or the KEYPAD to set the decay time for the assigned element.

TUNE - To designate Tune parameters for each drum element, press [F6] (Tune).

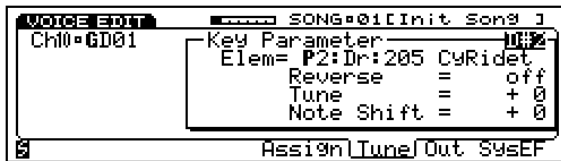

KEY/ELEMENT BANK/ELEMENT NUMBER SELECT - See Assign, above.

REVERSE (off, on) - Position the cursor over the Reverse status field and use the JOG or INC/DEC to make the assigned element play backwards.

TUNE (-63 ~ +63) - Position the cursor over the Tune value field and use the JOG, INC/DEC or the KEYPAD to adjust the fine-tuning of the assigned element.

NOTE SHIFT (-63 ~ +63) - Position the cursor over the Note Shift value field and use the JOG, INC/DEC or the KEYPAD to shift the pitch of the assigned element in semitones.

OUTPUT - To designate Output parameters for each drum element, press [F7] (Out).

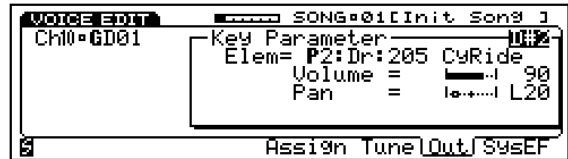

KEY/ELEMENT BANK/ELEMENT NUMBER SELECT - See Assign, above.

VOLUME LEVEL (0 ~ 127) - Position the cursor over the Volume value field and use the JOG, INC/DEC or the KEYPAD to adjust the output volume of the assigned element.

PAN POSITION (L31 ~ R31) - Position the cursor over the Pan position field and use the JOG or INC/DEC to designate the panning for the assigned element.

SYSTEM EFFECT SEND LEVEL - To specify each System Effect Send Level for the assigned element, from within the Key Parameters function, press [F8] (SysEF).

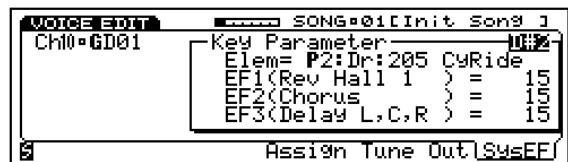

KEY/ELEMENT BANK/ELEMENT NUMBER SELECT - See Assign, above.

EF1/2/3 (0 ~ 127) - Position the cursor over the EF1, EF2, or EF3 value field and use the JOG, INC/DEC or the KEYPAD to set the send level for each of the three System Effects. (NOTE: The send levels that you assign in the Key Parameters function is for each assigned element. To set the send levels for the overall drum voice, see Effect, below.)

NOTE: If the Insertion Effect is set to on, each System Effect Send level for each key element will be set to maximum and the settings as defined in the display will be ignored.

EFFECT

The Effect parameters function lets you perform effects related operations for the drum voice, including designating Insertion Effect type, parameter, control and on/off status, plus determining the three System Effect send levels for the voice.

● ACCESSING EFFECT PARAMETERS

To access the Effect parameters function, from within Voice Edit Mode, press [F6] (Efect) or TRACK [14].

SYSTEM EFFECT SEND LEVEL - To specify each System Effect Send Level for the drum voice, from within the Effect parameters function, press [F5] (Sys).

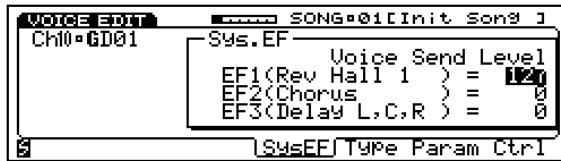

EF1/2/3 (0 ~ 127) - Position the cursor over the EF1 , EF2 , or EF3 value field and use the JOG, INC/DEC or the KEYPAD to set the send level for each of the three System Effects.

NOTE: The types of System Effects, their return levels, and their parameters can only be accessed and specified in Song Play Mode, when the cursor is positioned over a System Effect on the mixer. (For more information, see System Effects, page 79.)

INSERTION EFFECT TYPE - To specify the type of Insertion Effect for the drum voice, from within the Effect parameters function, press [F6] (Type).

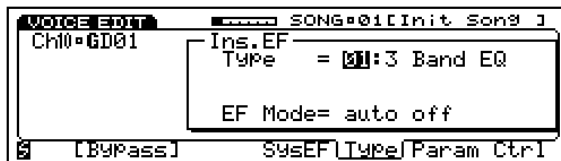

TYPE (00 ~ 35) - Position the cursor over the Type number field and use the JOG, INC/DEC or the KEYPAD to select which type of Insertion Effect will be assigned to the voice.

EFFECT MODE (auto off, auto on) - Position the cursor over the EF Mode select field and use the JOG or INC/DEC to set the on/off status for the selected insertion effect.

NOTE: Depending on the Insertion Effect Type, you can adjust the balance of the effect signal level in relation to the original voice signal level. For example, some effect types will display a wet:dry = 60% parameter that lets you adjust the amount of effect signal level. Other effect types will display wet:dry = 60:100 parameters that let you adjust the amount of effect signal level (wet signal) as well as original voice signal level (dry signal).

INSERTION EFFECT PARAMETER - To modify the parameters of the specified Insertion Effect for the voice, from within the Effect parameters function, press [F7] (Param).



PARAMETERS - Position the cursor over a parameter value field with CURSOR-UP/DOWN and use the JOG, INC/DEC or the KEYPAD to enter a value. (NOTE: The black downward-pointing arrow in the lower left of the parameter display indicates that the list of editable parameters continues.)

NOTE: The accessible parameters depend on the selected Insertion Effect type. For a complete listing of Insertion Effect Types and Parameters, see the W5/W7 Technical Information booklet.

INSERTION EFFECT CONTROL - To specify the Insertion Effect Control parameters for the voice, from within the Effect parameters function, press [F8] (Ctrl).

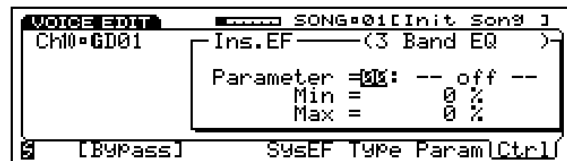

PARAMETER (off, 1 ~ 12) - Position the cursor over the Parameter select field and use the JOG or INC/DEC to designate the specific Insertion Effect parameter to control through the MIDI Control 1 or MIDI Control 2 function. (For details, see MIDI Control, page 128).

MIN/MAX (0 ~ 100%) - Position the cursor over the Min or Max value field and use the JOG, INC/DEC or the KEYPAD to set the range of minimum and maximum values by which the parameter will respond to the MIDI Control message.

NOTE: When selecting and modifying Insertion Effect Parameters (Type , Param , Ctrl), the word Bypass will appear above function key [F2], which acts as a compare function. By pressing [F2] (Bypass) you can bypass the Insertion Effect and hear the voice without the Insertion Effect applied, in order to compare the original voice to the voice with Insertion Effect applied as you set the Insertion Effect parameters. When the Insertion Effect is bypassed, the word Bypass will appear in reverse type. When you exit Voice Edit Mode, the bypass will become inactive.

Special conditions regarding the Insertion Effect include the following:

RECORDING - Any Insertion Effect on/off changes you make during recording will not be recorded by the sequencer.

VOICEPLAYMODE - Entering Voice Play Mode will always switch the Insertion Effect for the selected voice on. When selecting tracks the Insertion Effect for the selected track will always be turned on, regardless of its setting, and the Insertion Effects for any other tracks will be turned off. Whenever a program change message is received by the currently selected track, the Insertion Effect for the Instrument voice assigned to the track is always turned on. Any song select messages from an external device is ignored, and the Insertion Effect switch parameter change is also ignored.

VOICEEDITMODE - When you enter Voice Edit Mode, if the Insertion Effect on/off switch in the song multi is set to on, the Insertion Effect will be turned on; if the on/off switch in the song multi is set to off, the Insertion Effect will be turned off.

CONTROLLER

The Controller parameters function lets you perform expression low limit and MIDI control operations.

● ACCESSING CONTROLLER PARAMETERS

To access the Controller parameter function, from within Voice Edit Mode, press [F8] (Ctrl) or TRACK [16].

EXPRESSION LOW LIMIT - To specify the Expression Low Limit for the voice, from within the Controller parameters function, press [F6] (Limit).



EXPRESSION LOW LIMIT (0 ~ 127) - Use the JOG, INC/DEC or the KEYPAD to set the minimum volume for the foot controller (i.e., volume pedal) connected to the FOOT VOLUME jack on the rear panel.

NOTE: The Expression Low Limit Setting will have no effect unless you set the Foot Volume assignment to 011 (see Utility Mode, Controllers, Expression, page 147).

MIDI CONTROL 1/2 - To specify the MIDI Control status and function settings for the voice, from within the Controller parameters function, press [F7] (MC1) or [F8] (MC2).



MIDI CONTROL 1/2 (off, on) - Position the cursor over the MC1 (or MC2) status field and use the JOG or INC/DEC to switch MIDI Control on or off for the voice.

BY (off, 1 ~ 119 excl. 32) - Position the cursor over the By number field and use the JOG, INC/DEC or the KEYPAD to designate the type of control change message that will affect the parameter as specified in the To number field (see below).

TO (0 ~ 29) - Position the cursor over the By number field and use the JOG, INC/DEC or the KEYPAD to specify the parameter that will be controlled by the control change as specified in the By number field (see above).

MIN/MAX (0% ~ 100%) - Position the cursor over the Min or Max value field and use the JOG, INC/DEC or the KEYPAD to determine the range that the parameter will respond to the MIDI control message.



STORE MODE

Store Mode lets you store multis (with or without song sequencer data) in an internal song multi memory (01 ~ 16) as well as store original and preset voices into the Internal voice bank. Store Mode is handy for organizing your voices and multis before saving them to disk.

● ENTERING AND EXITING STORE MODE

To enter Store Mode, press the STORE button on the panel. From within Store Mode, you can choose the Store Multi [F2] (Multi) or Store Voice [F3] (Voice) function, depending on which type of data you want to store. To exit Store Mode, press EXIT once or more or press any other MODE button on the panel.

STORE MULTI

Store Multi Mode lets you store the multi in the currently selected Song memory into another song memory location (01 ~ 16). Multi data which can be stored in a Song memory location includes all multi settings (i.e., MIDI, mixer and other parameter settings for the 16 instrument voice tracks) and other setup data.

As you set parameters in a multi, as well as record or edit a song sequence within the song multi memory, all settings and data are entered within the currently selected song memory as you input it.

● BEFORE STORING A MULTI

Before entering Store Mode, first assign Instrument voices to tracks and adjust the other song multi parameters you want to store for all the necessary instrument tracks from within Song Mode. (NOTE: For more information about song multis, see page 74.)

● ACCESSING STORE MULTI FUNCTION

To access the Store Multi function, press STORE, followed by [F2] (Multi).

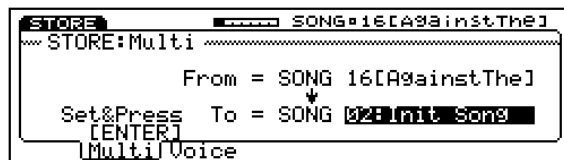

SELECTING THE SONG LOCATION - To select a Song location (01 ~ 16) to store the currently selected multi into, use JOG, INC/DEC or the KEYPAD.

STORING THE MULTI - Press ENTER, and the W5/W7 will give you a chance to change your mind, asking Are You Sure? Press INC to store the song or multi, or press DEC to abort the operation.

NOTE: Multi settings for SMF song data will load into the W5/W7, but will not be retained at power off unless you first store it in a song location. In order to be sure that you don't accidentally lose your important multi settings, it's a good habit to periodically perform the Store Multi operation as you work.

STORE VOICE

Store Voice Mode lets you store the currently selected voice, including any voice edit changes, into an Internal voice bank memory (001 ~ 128).

As you make parameter setting changes in Voice Edit Mode, the changes are made on a copy of the original voice which is temporarily held in the voice edit buffer. The settings will be retained as you switch back and forth between edit and compare, but will be lost if you select another voice before storing it to an Internal voice memory. Therefore, you must *always store your important user-created voices to an Internal voice bank memory before selecting another voice.*

NOTE: For more information about voice editing, see Voice Mode, page 108

In Store Voice Mode, currently selected Preset, GM and Internal voices can only be stored in the Internal voice bank; therefore, the Internal bank is automatically selected as the store destination.

```
STORE          SONG#16[Against The]
-----
STORE:Voice
-----
          From = P128[MacKinley ]
                ↓
Set&Press To = I000[E.Piano2 ]
[ENTER]
MultiVoice
```

However, if the currently selected voice is a Song voice, then it can only be stored in the Song voice bank of the currently selected multi; therefore, in this case, the Song bank for the currently selected song is automatically selected as the store destination.

```
STORE          SONG#06[In My Life]
-----
STORE:Voice
-----
          From = $029[Grit Organ]
                ↓
Set&Press To = $01E[EP 60's ]
[ENTER]
MultiVoice
```

Song voices are exclusive to each song i.e, only Song voices from the currently selected song can be accessed. Also, as with song sequence data, voice data in the Song voice bank memory will not be retained when the power is turned off; therefore, you must *always save your important Song voice data to floppy disks before turning the power off.*

NOTE: For more information about Song voices, see Utility Mode, Song Voice Memory function, page 143.

● BEFORE STORING A VOICE

Before entering Store Mode, either select a voice you want to store as is from a voice bank, or select a voice and edit it to your liking from within Voice Edit Mode.

● ACCESSING STORE VOICE FUNCTION

To access the Store Voice function, press STORE, followed by [F3] (Voice).

```
STORE          SONG#16[Against The]
-----
STORE:Voice
-----
          From = P128[MacKinley ]
                ↓
Set&Press To = I000[E.Piano2 ]
[ENTER]
MultiVoice
```

SELECTING THE VOICE LOCATION - To select an Internal voice bank location (001 ~ 128) to store the current voice into, use JOG, INC/DEC or the KEYPAD.

STORING THE VOICE - Press ENTER, and the W5/W7 will give you a chance to change your mind, asking Are You Sure? Press INC to store the voice, or press DEC to abort the operation.

STORE MODE

DISK MODE

Disk Mode lets you save your original voices, song multis and sequence data in various combinations into disk files on a floppy disk (3.5 2DD type), as well as load the files back into Internal/Song voice and song memory. It also lets you perform various disk file management functions like renaming and deleting files and formatting a disk for the W5/W7 operating system.

Disk Mode also permits the saving of songs in Standard MIDI File Format-0, as well as the loading of sequences recorded on other devices and saved in the Standard MIDI File Format-0 and -1, and the Yamaha ESEQ format. (NOTE: The Standard MIDI File Format was created and implemented by a consortium of software and hardware makers so that song data could be transferred easily between different music sequencers, including those made by different manufacturers. The W5/W7 supports two Standard MIDI File types, known as Format-0 and Format-1. In Format-0, all sequencer data is recorded as a single track, which may include data for more than one MIDI channel. In Format-1, more than one track may be used, each of which may contain data for more than one channel. Data saved by the W5/W7 using the Standard MIDI File Format will be saved as Format-0. The W5/W7 is capable of loading data saved in either of these formats, so long as the floppy disk the data is on is a 2DD type disk formatted in 9 sectors, 720 kilobytes.)

NOTE: If you try to use an unformatted disk, the Disk unformatted! message will appear on the display, indicating that you must perform the disk formatting operation.

NOTE: This sequencer will not run when the W5/W7 is in Disk mode.

● ENTERING AND EXITING DISK MODE

To enter Disk Mode, press the DISK button in the Mode section on the panel. The screen will display the main menu of Disk Mode functions.

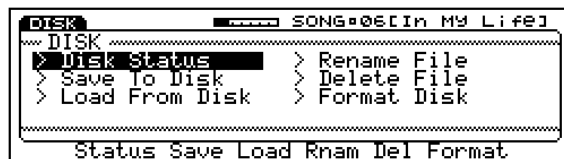

To exit Disk Mode from within the Disk Mode menu screen, press EXIT once. To exit Disk Mode from within a Disk Mode function, press EXIT twice or more. Or simply press any other MODE button on the panel.

● ACCESSING DISK MODE FUNCTIONS

To access the various Disk Mode functions, position the cursor over the name of the function you want and press ENTER, or simply press the function key [F2 ~ F7] located beneath the abbreviation of the function name located at the bottom of the screen. The Disk Mode functions are as follows:

DISK STATUS - Lets you review how many and what types of files are saved on the inserted floppy disk.

SAVETODISK - Lets you save Internal and Song voices and song sequence data onto the inserted floppy disk

LOADFROMDISK - Lets you load Internal and Song voices and song sequence data from floppy disk into the W5/W7's RAM memory.

RENAME FILE - Lets you change the name of any file on the inserted floppy disk.

DELETE FILE - Lets you erase a file from the inserted floppy disk.

FORMAT DISK - Lets you format a 3.5 2DD type floppy disk to be compatible with the W5/W7's operating system.

NOTE: A floppy disk must be inserted into the disk drive to perform Disk Mode operations. When attempting to perform Disk Mode operations when a floppy disk is not inserted, Disk not ready! will appear on the screen.

● MOVING AROUND IN DISK MODE

When you are within a particular Disk Mode function or subfunction, you can often jump directly to another function by holding SHIFT and pressing a function key [F2 ~ F7] a letter S inside a black box at the lower left of the screen will indicate that you can do so. To get back to the Disk Mode main menu from within a function, press EXIT once or more, or press the DISK button in the Mode section on the panel. You can execute disk saving and loading operations from within the File Directory.

● SELECTING FILES

Whenever you choose a Disk Mode saving and loading function, a subfunction menu of file types will appear. This menu lets you access the type of file data to save to or load from a floppy disk.

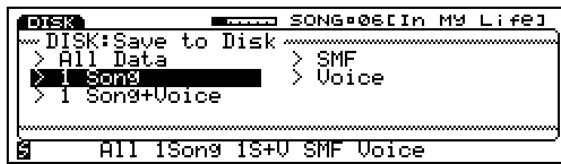

To select the various file types, position the cursor over the name of the type of file you want to perform the operation on and press ENTER or simply press the function key [F2 ~ F6] located beneath the abbreviation of the function name located at the bottom of the screen.

FILETYPES - After saving a file, the file type will be delineated by a period followed by a three-character code, which appears after the file name in the File Directory. File types are as follows:

ALL DATA (A1A) - A W5/W7 All Data type data file contains all data in the W5/W7 multi, including the 16 songs (sequencer and/or multi data) plus accompanying Song voice banks. All data is offloaded from and loaded back into an internal song bank (01 ~ 16) RAM.

1 SONG (A1Q) - A W5/W7 1 Song type data file contains one song (sequencer and/or multi data) only. 1 Song data is offloaded from and loaded back into an internal song bank (01 ~ 16) RAM.

1 SONG + VOICE (A1S) - A W5/W7 1 Song + Voice type data file contains one song (sequencer and/or multi data) only, plus accompanying 128 Song voices and 2 Song drum voices. 1 Song + Voice data is offloaded from and loaded back into an internal song bank (01 ~ 16) RAM.

ESEQ/SMF (.MID) - An SMF type data file contains one song (sequencer and multi data) saved in the Standard MIDI File Format. SMF type files allow easy data exchange with instruments from different makers that support the SMF standard. SMF data is offloaded from and loaded back into an internal song memory (01 ~ 16) RAM. (NOTE: The W5/W7 can accept files which have been saved in either SMF Format-0 or SMF Format-1. It can only save in SMF Format-0.) An ESEQ type data file contains one song saved in the Yamaha ESEQ format (compatible with SY99, SY77, Piano Player and Clavinova; however, the commercially available music data disks for Piano Player and Clavinova cannot be loaded). ESEQ files can be loaded into the W5/W7; however, the W5/W7 cannot save files in the ESEQ format.

VOICE (A1V) - A W5/W7 Voice type data file contains a complete bank of 128 Internal normal voices plus 2 Internal drum voices. Voice data is offloaded to floppy disk in a complete Internal voice bank with elements, but can be loaded back into the Internal voice bank either all voices at once (including drum voices) or one voice into a specific Internal voice number (excluding Internal drum voices). If the destination song memory location has a Song voice bank, you can load the Internal voice bank into it, or you can load a single Internal voice into a Song voice number.

● SELECTING A FILE TYPE

To select a file type, position the cursor over the name of the subfunction of the type of file you want and press ENTER, or simply press the function key [F2 ~ F6] located beneath the abbreviation of the file type name located at the bottom of the screen. If the operation is a saving or renaming type function, you can name the file and view the File Directory, and execute the operations from within either subfunction.



NAMEFILE - To name a file, press [F7] (Name) and the Name screen will appear, where you can enter an 8-character name for the file.



To name the file, position the inverted arrow pointer with [F4] and [F5], and select characters with the CURSOR keys, INC/DEC, or the JOG. A blank letter space can be entered by pressing [F3] ([SPC]). When you've finished entering the name, you can either press EXIT once to return to the subfunction screen, or go ahead and press ENTER to perform the operation.

FILE DIRECTORY - The File Directory displays the list of files on the currently inserted disk by type (i.e., song file type, voice file type, etc.). The type of files displayed depends on which particular Disk Mode subfunction you're in (i.e., All, Voice, etc.). You can perform the particular operation from within the File Directory.

The example below shows a partial list of Voice type files, accessed by pressing [F8] (Dir) from within any of the Voice type file subfunctions.

NOTE: The A1V appearing after the filename is the W5/W7 operating system code delineating a voice type file.

```

DISK          SONG#06 In My Life1
-----
FILE Directory
01: AGAINST .A1V  05: PARA2  .A1V
02: HEART  .A1V  06:      .
03: HPN_1SNG.A1V 07:      .
04: PARA1  .A1V  08:      .
                               Dir
  
```

The screen will only display eight files on the list at a time, but you can scroll through the list using the CURSOR keys, in order to view all files. As you scroll, the screen will advance accordingly, depending on how many files are on the disk.

NOTE: The number of files that will fit on the disk depends on how large your music data is. Long songs will naturally require more disk space.

DISK STATUS

The Disk Status function lets you review how many and what types of files are saved on a floppy disk.

```

DISK          SONG#06 In My Life1
-----
> Disk Status  > Rename File
> Save to Disk > Delete File
> Load From Disk > Format Disk
-----
Status Save Load Rnam Del Format
  
```

● ACCESSING DISK STATUS

To access the Disk Status function, from within the Disk Mode main menu screen, position the cursor over Disk Status and press ENTER, or simply press [F2] (Status).

```

DISK          SONG#06 In My Life1
-----
DISK:Status
-----
Total 12 Files All Data 2 Files
Used 267kBytes 1 Song 5 Files
Free 446kBytes 1 Song+Voice 4 Files
                               Voice 1 Files
-----
Status Save Load Rnam Del Format
  
```

ALLDATA - Tells you how many files containing 16 song multis (with sequencer and/or multi data) plus accompanying Song voice and Song drum voice banks are on the disk.

1SONG - Tells you how many files containing song multi data (sequencer and/or multi) for one song only are on the disk.

1SONG+VOICE - Tells you how many files containing song multi data (sequencer and/or multi) for one song plus accompanying Song voice and Song drum voice banks are on the disk.

VOICE - Tells you how many files containing voice bank data are on the disk.

SAVE TO DISK

The Save To Disk function lets you designate the type of data you want to save, and offload it into a file on a floppy disk.

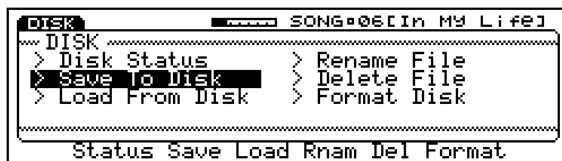

NOTE: If there is not enough space on the disk to complete a Save To Disk operation, the Disk Full message will appear. In such a case, either delete some files on the disk or remove the disk and insert another one. When attempting to save a file using the same filename as the one which already exists, the WSM7 will ask you: Overwrite? Be careful not to delete or overwrite an important data file, since deleted or overwritten files will be erased from the disk.

● ACCESSING SAVE TO DISK

To access the Save to Disk submenu of functions, from within the Disk Mode main menu screen, position the cursor over Save To Disk and press ENTER, or simply press [F3] (Save).

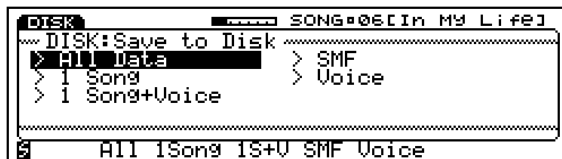

SAVEALLDATA - For saving all 16 songs (sequencer and/or multi data) plus accompanying Song voice and Song drum voice banks into a file on the floppy disk. To select the Save All subfunction, from within the Save to Disk submenu screen, position the cursor over All Data and press ENTER, or simply press [F2] (All). The Save to Disk/All Data screen will appear.



FILE DIRECTORY - To view the File Directory and see what All-type files are already on the inserted disk before saving your new file, press [F8] (Dir). After viewing the File Directory, to return to the Save to Disk/All screen, press EXIT once.

NAME FILE - To name the file before saving, from within the Save to Disk/All screen, press [F7] (Name). Position the pointer with [F4] and [F5], and select characters with the CURSOR keys, INC/DEC, or the JOG. To return to the Save to Disk/All screen, press EXIT.

SAVING ALL TO DISK - After naming the new file, you can engage the save operation directly from within the Name screen. (You may also engage the save operation by pressing ENTER from the Save to Disk/All screen or from within the File Directory.) The Executing message will appear, indicating that the saving operation is underway. When finished, the message will change to Completed!

SAVE 1 SONG - For saving a single song (sequencer and/or multi data) into a file on the floppy disk. To select the 1 Song subfunction, from within the Save to Disk submenu screen, position the cursor over 1 Song and press ENTER, or simply press [F3] (1 Song). The Save to Disk/1 Song screen will appear.



Choose the song you want to save using the JOG, INC/DEC, or the KEYPAD. To return to the Save to Disk/1 Song screen, press EXIT.

FILE DIRECTORY - To view the File Directory and see what 1 Song files are already on the inserted disk before saving your new file, press [F8]. After viewing the File Directory, to return to the Save to Disk/1 Song screen, press EXIT once.

NAME FILE - To name the file before saving, from within the Save to Disk/1 Song screen, press [F7] (Name). Position the pointer with [F4] and [F5], and select characters with the CURSOR keys, INC/DEC, or the JOG. When you've finished entering the name, press EXIT once to return to the Save to Disk/1 Song screen.

SAVING 1 SONG TO DISK - After naming the new file, you can engage the save operation directly from within the Name screen. (You may also engage the save operation by pressing ENTER from the Save to Disk/1 Song screen or from within the File Directory.) The Executing message will appear, indicating that the saving operation is underway. When finished, the message will change to Completed!

SAVE 1 SONG + VOICE - For saving a single song (sequencer and/or multi) plus accompanying Song voice and Song drum voice banks into a file on the floppy disk. To select the 1 Song+Voice subfunction, from within the Save to Disk menu screen, position the cursor over 1 Song+Voice and press ENTER, or simply press [F4] (1S+V). The Save to Disk/1 Song + Voice screen will appear.



Choose the song you want to save using the JOG, INC/DEC, or the KEYPAD (01 ~ 16) followed by ENTER.

FILE DIRECTORY - To view the File Directory and see what 1 Song+Voice files are already on the inserted disk before saving your new file, press [F8]. After viewing the File Directory, to return to the Save to Disk/1 Song + Voice screen, press EXIT once.

NAME FILE - To name the file before saving, press [F7] (Name). Position the pointer with [F4] and [F5], and select characters with the CURSOR keys, INC/DEC, or the JOG. To return to the Save to Disk/1 Song + Voice screen, press EXIT.

SAVING 1 SONG + VOICE TO DISK - After naming the new file, you can engage the save operation directly from within the Name screen. (You may also engage the save operation by pressing ENTER from the Save to Disk/1 Song + Voice screen or from within the File Directory.) The Executing message will appear, indicating that the saving operation is underway. When finished, the message will change to Completed!

NOTE: If the currently selected song contains Song voices, the W5W7 automatically saves them in the file. If the selected song does not contain Song voices, the W5W7 automatically copies the Internal voice bank to the Song voice bank and saves them.

SAVESMF - For saving a single song (sequencer and multi data) in the Standard MIDI File format (Format 0) into a file on the floppy disk. To select the SMF subfunction, from within the Save to Disk menu screen, position the cursor over SMF and press ENTER, or simply press [F5] (SMF). The Save to Disk/SMF screen will appear.



Choose the song you want to save using the JOG, INC/DEC, or the KEYPAD.

FILE DIRECTORY - To view the File Directory and see what SMF files are already on the inserted disk before saving your new file, press [F8]. After viewing the File Directory, to return to the Save to Disk/SMF screen, press EXIT once.

NAME FILE - To name the file before saving, press [F7] (Name). Position the pointer with [F4] and [F5], and select characters with the CURSOR keys, INC/DEC, or the JOG. To return to the Save to Disk/SMF screen, press EXIT.

SAVING SMF TO DISK - After naming the new file, you can engage the save operation directly from within the Name screen. (You may also engage the save operation by pressing ENTER from the Save to Disk/SMF screen or from within the File Directory.) The Executing message will appear, indicating that the saving operation is underway. When finished, the message will change to Completed!

SAVE VOICE - For saving the Internal voice bank (all 128 normal and 2 drum voices) data into a file on the disk at one time. To select the Voice subfunction, from within the Save to Disk menu screen, position the cursor over Voice and press ENTER, or simply press [F6] (Voice). The Save to Disk/Voice screen will appear.



FILE DIRECTORY - To view the File Directory and see what Voice files are already on the inserted disk before saving your new file, press [F8]. After viewing the File Directory, to return to the Save to Disk/Voice screen, press EXIT once.

NAME FILE - To name the file before saving, press [F7] (Name). Position the pointer with [F4] and [F5], and select characters with the CURSOR keys, INC/DEC, or the JOG. To return to the Save to Disk/Voice screen, press EXIT.

SAVING VOICE TO DISK - After naming the new file, you can engage the save operation directly from within the Name screen. (You may also engage the save operation by pressing ENTER from the Save to Disk/Voice screen or from within the File Directory.) The Executing message will appear, indicating that the saving operation is underway. When finished, the message will change to Completed!

LOAD FROM DISK

The Load From Disk function lets you designate which file on a floppy disk to load into the W5/W7 and, depending on the file type, where to load it.

NOTE: When any type of file is loaded into the W5/W7, it replaces the existing data, completely erasing it. Be sure to save important music data to a floppy disk before loading a file into the W5/W7.

NOTE: Unintentionally selecting the wrong file type from a floppy disk will cause the File not found message to appear.

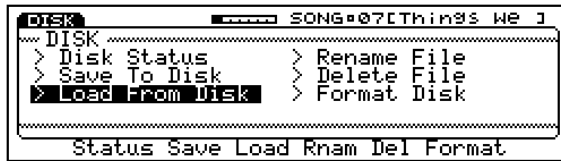

● ACCESSING LOAD FROM DISK

To access the Load From Disk submenu of functions, from within the Disk Mode main menu screen, position the cursor over Load From Disk and press ENTER, or simply press [F4] (Load).



LOADALLDATA - For loading a file containing 16 songs (sequencer and/or multi data) plus accompanying song voice and song drum voice banks into the internal song memory bank. To select the All Data subfunction, from within the Load From Disk submenu screen, position the cursor over All and press ENTER, or simply press [F2] (All). The Load from Disk/All Data screen will appear.



FILE DIRECTORY - To view the list of All files on the inserted disk from the File Directory, press [F8] (Dir).

SELECT FILE - Select the file you want to load using the JOG, INC/DEC, or the KEYPAD. (NOTE: If there is only one file in the disk, you cannot choose.)

LOADING ALL FROM DISK - You may initiate the loading operation from either the Load from Disk/All screen or from within the File Directory, by pressing ENTER. The W5/W7 will give you a chance to change your mind, asking Are You Sure? Press DEC to abort the operation, or press INC to load the file from the floppy disk. The Executing message will appear, indicating that the loading operation is underway. When finished, the message will change to Completed!

LOAD 1 SONG - For loading a file containing a single song (sequencer and/or multi data) into a song memory location (1 ~ 16). To select the 1 Song subfunction, from within the Load From Disk submenu screen, position the cursor over 1 Song and press ENTER, or simply press [F3] (1 Song). The Load from Disk/1 Song screen will appear.



SELECT FILE - Select the file you want to load by positioning the cursor over the From = FILE field and using the JOG, INC/DEC, or the KEYPAD.



SELECTLOCATION - Select the song memory location you want to load the file into by positioning the cursor over the To = SONG field and using the JOG, INC/DEC, or the KEYPAD.

FILEDIRECTORY - To view the list of 1 Song files on the inserted disk from the File Directory, press [F8] (Dir).

LOADING 1 SONG FROM DISK - You may initiate the loading operation from either the Load from Disk/1 Song screen or from within the File Directory, by pressing ENTER. The W5/W7 will give you an opportunity to change your mind by asking Are You Sure? Press DEC to abort the operation, or press INC to load the file from the floppy disk. The Executing message will appear, indicating that the loading operation is underway. When finished, the message will change to Completed!

NOTE: Loading a 1 Song type file into a W5/W7 song memory location will erase any Song voice data already in the song memory.

LOAD 1 SONG+VOICE - For loading a file containing a single song (sequencer and/or multi) plus accompanying song voice and song drum voice banks into a song memory location (01 ~ 16). To select the 1 Song+Voice subfunction, from within the Load From Disk submenu screen, position the cursor over 1 Song+Voice and press ENTER, or simply press [F4] (1S+V). The Load From Disk/1 Song + Voice screen will appear.



SELECT FILE - Select the file you want to load by positioning the cursor over the From = FILE field and using the JOG, INC/DEC, or KEYPAD.



SELECTLOCATION - Choose the song memory location you want to load the file into by positioning the cursor over the To = SONG field and using the JOG, INC/DEC, or the KEYPAD.

FILEDIRECTORY - To view the list of 1 Song+Voice files on the inserted disk from the File Directory, press [F8] (Dir).

LOADING 1 SONG + VOICE FROM DISK - You may initiate the loading operation from either the Load from Disk/1 Song + Voice screen or from within the File Directory, by pressing ENTER. The W5/W7 will give you an opportunity to change your mind by asking Are You Sure? Press DEC to abort the operation, or press INC to load the file from the floppy disk. The Executing message will appear, indicating that the loading operation is underway. When finished, the message will change to Completed!

LOAD ESEQ/SMF - For loading a file containing a single song (sequencer and multi data) saved in the Yamaha ESEQ format or saved in the Standard MIDI File format (Format 0 or Format 1), into a song memory location (01 ~ 16). To select the ESEQ/SMF subfunction, from within the Load From Disk submenu screen, position the cursor over ESEQ/SMF and press ENTER, or simply press [F5] (SMF). The Load From Disk/ESEQ/SMF screen will appear.

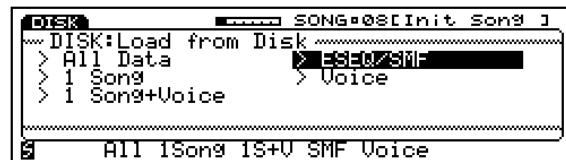

SELECT FILE - Select the file you want to load by positioning the cursor over the From = FILE field and using the JOG, INC/DEC, or KEYPAD.



SELECTLOCATION - Select the song memory location you want to load the file into by positioning the cursor over the To = SONG field and using the JOG, INC/DEC, or the KEYPAD.

FILEDIRECTORY - To view the list of ESEQ/SMF files on the inserted disk from the File Directory, press [F8] (Dir).

LOADING ESEQ/SMF FROM DISK - You may initiate the loading operation from either the Load from Disk/ESEQ/SMF screen or from within the File Directory, by pressing ENTER. The W5/W7 will give you an opportunity to change your mind by asking Are You Sure? Press DEC to abort the operation, or press INC to load the file from the floppy disk. The Executing message will appear, indicating that the loading operation is underway. When finished, the message will change to Completed!

NOTE: The File Directory will show all file names even if they aren't specifically W5/W7, ESEQ or SMF files. You can select the ESEQ and SMF type files to load into the W5/W7, but attempting to load files from other operating systems will cause the "Illegal file" message to appear on the display, and you will not be able to load an illegal file.

LOAD VOICE - For loading a file containing voices into the Internal or a Song voice bank.

To select the Voice subfunction, from within the Load From Disk submenu screen, position the cursor over Voice and press ENTER, or simply press [F6] (Voice). The Load from Disk/Voice screen will appear.

From the Load from Disk/Voice screen you can access Voice type files and load either a single voice (normal voice only) into a single Internal or Song voice memory location (if the selected song memory contains a Song voice bank). You can load a complete set of 128 normal voices and 2 drum voices into the Internal voice bank or a Song voice bank.

LOADING ALL VOICES - To load all voices (normal and drum voices) in a Voice type file into the Internal voice bank or a Song voice bank, all voice must be selected.



SELECT FILE - Select the Voice file you want to load by positioning the cursor over the From = FILE field and using the JOG, INC/DEC, or KEYPAD.

SELECT INTERNAL OR SONG BANK - If you want to load the file into the Internal voice bank, position the cursor over the To = field and choose INTERNAL, using JOG or INC/DEC. If you want to load the file into a Song voice bank (01 ~ 16), position the cursor over the To = field and choose SONG, using JOG or INC/DEC. Then press the CURSOR-RIGHT button once to position the cursor over the song voice memory select field.



Using JOG, INC/DEC or the KEYPAD, choose the song voice memory location (01 ~ 16).

LOADING A SINGLE VOICE - To load a single voice (normal voice only) from a Voice type file into an Internal or Song voice memory location.

SELECT FILE - First select a file in the From = FILE field. Then position the cursor over the all voice field and choose a voice (001 ~ 128) from within the file, using JOG, INC/DEC or the KEYPAD.



SELECT INTERNAL OR SONG VOICE - If you want to load the voice into an Internal voice memory, position the cursor over the To = field and choose INTERNAL, using JOG or INC/DEC. If you want to load the voice into a Song voice memory, position the cursor over the To = field and choose SONG, using JOG or INC/DEC. Then press the CURSOR-RIGHT button once to position the cursor over the Song voice memory select field.

SELECT VOICE NUMBER - Next, position the cursor over the voice number field and choose the voice location (001 ~ 128) to load the voice into, using JOG, INC/DEC or the KEYPAD.

FILE DIRECTORY - You can view the list of Voice files on the inserted disk from the File Directory, by pressing [F8] (Dir).

LOADING VOICE FROM DISK - You may initiate the loading operation from the Load from Disk/Voice screen, by pressing ENTER. The W5/W7 will give you an opportunity to change your mind by asking Are You Sure? Press DEC to abort the operation, or press INC to load the file from the floppy disk. The Executing message will appear, indicating that the loading operation is underway. When finished, the message will change to Completed!

NOTE: It is possible to load all voices, even if the selected destination song memory does not contain a Song voice bank. However, before you can load a single voice into a Song voice memory location, first you must create a Song voice memory area using the Song Voice Memory function in Utility Mode. (For details see page 143)

RENAME FILE

The Rename File function lets you change the name of any type of file on a disk.



● RENAMING A FILE

To access the Rename File function, from within the Disk Mode main menu screen, position the cursor over Rename File and press ENTER, or simply press [F5] (Rename).

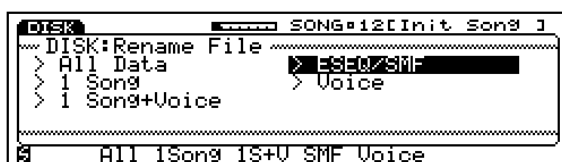

SELECT FILETYPE - Position the cursor over the file type and press ENTER, or simply press a function key [F2 ~ F6] corresponding to the type of file you want to access.

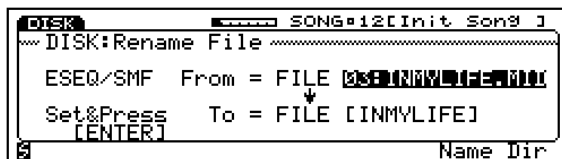

SELECT A FILE - Select the file you want to rename using JOG, INC/DEC or the KEYPAD (in the From = field). If you want, you can view the various files in the File Directory, by pressing [F8] (Dir).

FILENAME - Press [F7] (Name) to advance to the file Name screen and change the name. After giving the file a new name, press ENTER to rename the file.



After pressing ENTER, the W5/W7 will give you an opportunity to change your mind by asking Are You Sure? Press DEC to abort the operation, or press INC to rename the file on the floppy disk. The Executing message will appear, indicating that the renaming operation is underway. When finished, the message will change to Completed!

DELETE FILE

The Delete File function lets you delete any type of file on a floppy disk.

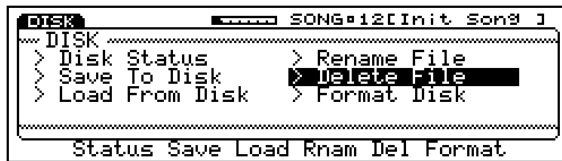

● DELETING A FILE

To access the Delete File function, from within the Disk Mode main menu screen, position the cursor over Delete File and press ENTER, or simply press [F6] (Delete).



SELECT FILETYPE - Position the cursor over the file type and press ENTER, or simply press a function key [F2 ~ F6] corresponding to the type of file you want to access.

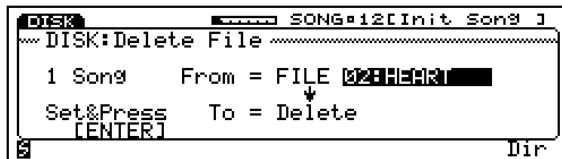

SELECT A FILE - Select the file you want to delete using JOG, INC/DEC or the KEYPAD. If you want, you can view the various files in the File Directory, by pressing [F8] (Dir).

DELETE FILE - Press ENTER to delete the file.

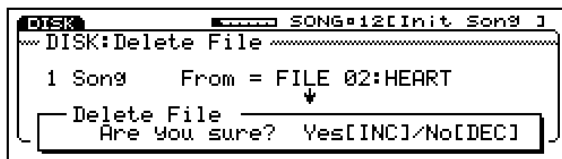

You may initiate the deleting operation from either the Delete File screen or from within the File Directory, by pressing ENTER. The W5/W7 will give you an opportunity to change your mind by asking Are You Sure? Press DEC to abort the operation, or press INC to Delete the file on the floppy disk. The Executing message will appear, indicating that the deleting operation is underway. When finished, the message will change to Completed!

DISK MODE

FORMAT DISK

The Format Disk function lets you format a 3.5 2DD type floppy disk to be compatible with the W5/W7 s operating system (9 sectors, 720 kilobyte.)

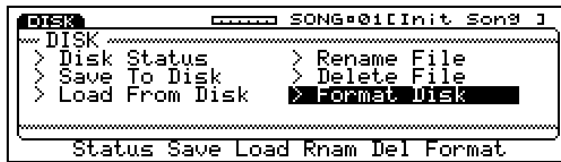

● FORMATTING A DISK

To access the Format Disk function, from within the Disk Mode main menu screen, position the cursor over Format Disk and press ENTER, or simply press [F7] (Format).

INSERT DISK - The W5/W7 will ask you to insert a blank disk and to press ENTER.



DISK FORMAT - The W5/W7 will give you a chance to change your mind, asking Are You Sure?



Press DEC to abort the operation, or press INC to format the floppy disk. The Executing message will appear, indicating that the formatting operation is underway. When finished, the message will change to Completed!

NOTE: Once the disks formatted, any data which may have existed on the disks will be erased. Be careful not to erase your disks which contain important music data!

UTILITY MODE

Utility Mode lets you manage Song voices, initialize the Internal voice bank, determine various MIDI settings and transmit bulk MIDI data, set master tuning and keyboard velocity parameters, and access other functions which affect the W5/W7's overall system.

● ENTERING UTILITY MODE

To enter Utility Mode, press the UTILITY button in the Mode section on the panel. The screen will display the main menu of the eight utility functions. To access the various functions, use the CURSOR keys to position the cursor over the function you want, followed by ENTER, or simply use the function keys [F1 ~ F8] corresponding to the abbreviated names of the utility functions displayed at the bottom of the screen.



MEMORY - Lets you manage Song voice memory banks by copying an entire bank of normal and drum voices from Internal, Song (01 ~ 16), GM, Preset and optional External voice banks to the Song voice memory of the currently selected song.

INITIALIZE - Lets you recall the initial bank of factory set Internal normal and drum voices that shipped with the instrument.

VOICEBULKDUMP - Lets you transmit the entire bank of Internal normal and drum voices currently stored in the W5/W7 to another W5/W7 or external MIDI device.

SYNTHESIZERSETUP - Lets you determine master tuning, keyboard velocity settings and controller settings.

CONTROLLERS - Lets you set the continuous slider (CS) assignment, the foot volume assignment, and the foot control initialization value.

MIDISETUP - Lets you determine the W5/W7 device number, set local keyboard status and set program change status.

OTHERSETUP - Lets you adjust the contrast of the LCD and determine if the confirmation screen will appear before an editing operation is engaged.

GREETINGMESSAGE - Lets you create a two-line, 20-character per line message that will appear on the screen during the system start-up process at power on.

● MOVING AROUND IN UTILITY MODE

No matter what Utility Mode function you are in, you can always jump directly to another utility function by pressing the function key [F1 ~ F8] which corresponds to the abbreviated function names displayed at the bottom of the screen.

● EXITING UTILITY MODE

To exit Utility Mode from within the Utility Mode main menu screen, press EXIT once. To exit Utility Mode from within a Utility Mode function, press EXIT twice. Or simply press any other MODE button on the panel.

NOTE: The sequencer will not run when the W5/W7 is in Utility mode.

SONG VOICE MEMORY

The Song Voice Memory function lets you manage Song voice memory banks by copying an entire bank of normal and drum voices from the Internal, Song (01 ~ 16), GM and Preset voice banks to the Song voice memory bank of the currently selected song. (NOTE: You can also copy from the External preset voice bank if the optional Expansion Wave/Voice Board is installed.)

Each internal song multi (01 ~ 16) can accommodate a Song voice memory bank that will hold 128 normal and 2 drum voices. These Song voices are exclusive to each song multi, and can be accessed by the currently selected multi. (Song voices from other multis cannot be accessed from within the currently selected multi).

When the Song voice bank for the currently selected multi is empty, whenever a Song voice is selected, it will display ten asterisks where the song name should appear, and no sound will be produced when the W5/W7 s keyboard is played, or if incoming MIDI note messages are being received by the particular track.

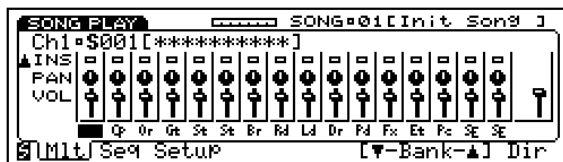

NOTE: One of the most useful ways to manage Song voices is to first arrange the voices you want in the Internal voice bank, using the Store Voice function (see Store Mode page 130). Then copy the Internal voice bank to the currently selected Song voice bank using the Utility Mode's Song Voice Memory function.

● ACCESSING SONG VOICE MEMORY

To access the Memory function, from within the Utility Mode main menu screen, position the cursor over MEMORY and press ENTER, or simply press [F1] (Mem). The Copy Voice screen will appear.

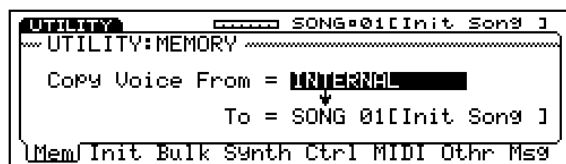

SELECTING A VOICE BANK - The From = field will be highlighted, indicating that you can select which bank to copy to the currently selected Song voice memory.

To select a voice bank Internal, Song (01 ~ 16), GM, Preset to copy from, use the JOG or the INC/DEC keys.

NOTE: You cannot place the cursor over the To = field and select a Song voice memory from within the Utility Mode. The song number displayed is the currently selected song, which is accessed from Song Mode. To choose a different Song voice memory, copy the voice bank into, return to Song Mode, press [F2] (Seq) and select another song. (For more information about selecting songs, see Song Mode, page 80)

COPYING TO SONG VOICE MEMORY - After designating the voice bank to copy from, press ENTER. The W5/W7 will give you a chance to change your mind, asking Are You Sure? Press DEC to abort the operation, or INC to copy the voice bank. The Executing message will appear, indicating that the copying operation is underway. When finished, the message will change to Completed!

NOTE: If the currently selected multi's Song voice bank is empty, the copying process will commence after memory space has been allocated. If the currently selected multi's Song voice bank already has voices in it, then the copying process will begin after deleting the existing Song voices.

NOTE: As with song sequence data in a multi, voice data in the Song voice bank memory will not be retained when the power is turned off; therefore, you must always save your important Song voice data to floppy disks before turning the power off.

INITIALIZE

The initialization process sets all Internal normal voices to their basic initial values. The Internal AWM element and other normal voice settings will be cleared and each voice will be initialized as a one-element sine wave voice i.e., the status you will want when creating a voice from scratch. The two Internal drum voice memories will simply be assigned GM Drum Voice #01 and #02, respectively.

● ACCESSING INITIALIZE

To access the Initialize function, from within the Utility Mode main menu screen, position the cursor over INITIALIZE and press ENTER, or simply press [F2] (Init). The Initialize screen will appear.

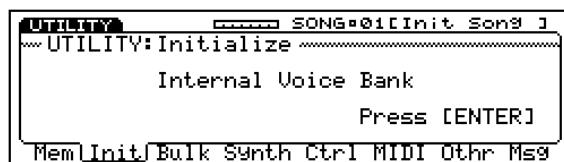

INITIALIZING INTERNAL VOICE BANK -

To initialize the internal voice bank, press ENTER. The W5/W7 will give you a chance to change your mind, asking Are You Sure? Press DEC to abort the operation, or INC to initialize the bank. The Executing message will appear briefly, indicating that the initializing operation is underway. When finished, the message will change to Completed!

VOICE BULK DUMP

The Voice Bulk Dump function lets you transmit the entire bank of Internal 128 normal voices and 2 drum voices currently stored in the W5/W7 to another W5/W7 or to external MIDI devices.

NOTE: Before executing the operation, the W5/W7's MIDI OUT jack must be connected to the MIDI IN of the external device by a MIDI cable, and the device number for both instruments must be set to the same number. (For information about setting the W5/W7's device number, see page 148.)

● ACCESSING VOICE BULK DUMP

To access the Voice Bulk Dump function, from within the Utility Mode main menu screen, position the cursor over VOICE BULK DUMP and press ENTER, or simply press [F3] (Bulk). The Voice Bulk Dump screen will appear.

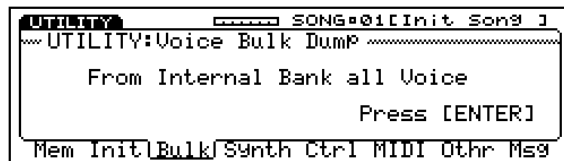

● RECEIVING BULK VOICE DATA

To receive voice bulk data into the W5/W7 from an external device, first cease song recording, song editing, or voice editing operations. Set the device number for both instruments to the same number. Then initiate the voice bulk dumping process from the external device.

DUMPING INTERNAL VOICE BANK - To dump the Internal voice bank, press ENTER. The W5/W7 will give you a chance to change your mind, asking Are You Sure? Press DEC to abort the operation, or press INC to initiate the voice dump process. Each voice will count off as it is dumped. When finished, the message will change to Completed!

SYNTHESIZER SETUP

The Synthesizer Setup function lets you determine master tuning, keyboard velocity settings and controller settings.

● ACCESSING SYNTHESIZER SETUP

To access the Synthesizer Setup function, from within the Utility Mode main menu screen, position the cursor over INITIALIZE and press ENTER, or simply press [F4] (Synth). The Synthesizer Setup screen will appear.

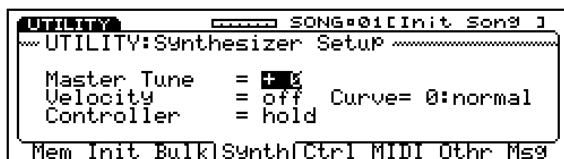

MASTER TUNE (-63 ~ + 63) - For adjusting the overall fine tuning of the W5/W7 in steps of 1.17 cents. The master tune setting affects only the W5/W7 s internal tone generator, and has no effect on the note numbers transmitted from MIDI OUT. (NOTE: You can adjust the tuning of specific voices in the Voice Edit Mode. For information, see page 118.)

VELOCITY (off, 1 ~ 127) - For adjusting the velocity sensitivity response of the W5/W7 s keyboard. (NOTE: The velocity settings affect only the W5/W7 s keyboard, and not the internal sequencer or incoming MIDI data.)

1 ~ 127 - When Velocity is set to a specified velocity value, all notes will be fixed to the same velocity value regardless of your true playing velocity.

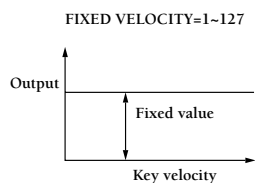

When playing the sound of an instrument that normally does not respond to key velocity (such as organ or harpsichord) it s effective to use a fixed velocity value. It is preferable, however, to set all velocity sensitivity parameters of the voice to 0 (in Voice Edit Mode) since this will leave all other voices at their normal velocity settings.

OFF - When Velocity is turned off, the W5/W7 tone generator will respond to playing velocity in accordance with the specified Velocity Curve setting.

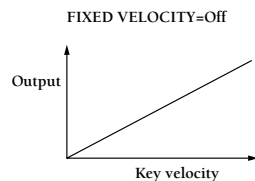

VELOCITY CURVE (0: normal, 1: soft-1, 2: soft-2, 3: easy, 4: wide, 5: hard, 6: cross-1, 7: cross-2)

The specified Velocity Curve setting determines the way the W5/W7 s tone generator responds to playing velocity when the Velocity parameter is set to off (see Velocity, above).

The Velocity Curve setting affects only notes played on the W5/W7 s keyboard, and can also be transmitted from MIDI OUT. The curve setting has no effect on the incoming note messages transmitted from external device and received at MIDI IN.

NORMAL - Setting the Velocity Curve to Normal means the W5/W7 s keyboard will respond to playing speed at its basic velocity input level, as determined by the voice s key velocity setting. (For more information, see Voice Edit Mode, Amp function, page 113.)

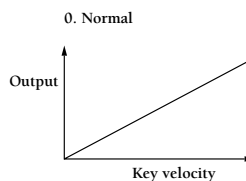

SOFT-1 AND SOFT-2 - Velocity Curves 1 (soft-1) and 2 (soft-2) allow you to increase sound output to greater and lesser degrees at slower slower key velocities.

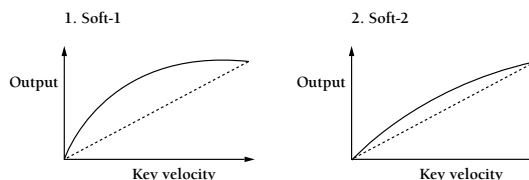

EASY - Velocity Curve 3 (easy) allows you to slightly increase output with faster and slower key velocities, while producing a normal velocity curve with key velocity values between the two extremes.

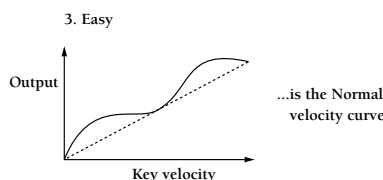

WIDE - Velocity Curve 4 (wide) allows you to slightly decrease output at slower key velocities while increasing output at faster key velocities.

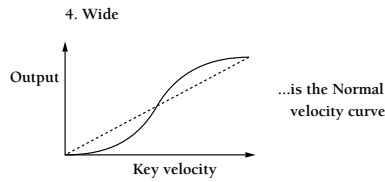

HARD - Velocity Curve 5 (hard) requires you to press the keys extremely hard in order to produce a louder sound.

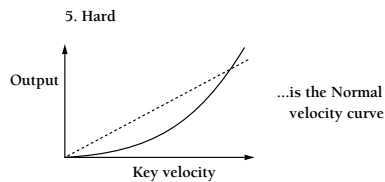

CROSS-1 AND CROSS-2 - Velocity Curve 6 (cross-1) and Curve 7 (cross-2) allow you to crossfade between two voices with key velocity. To do so, set one voice to positive key velocity sensitivity and the other to negative key velocity sensitivity. (For more about key velocity sensitivity, see Voice Edit Mode, Amp function, page 113.) This works with Layered voices, 4-Zone voices and normal voices which have two or more AWM elements.

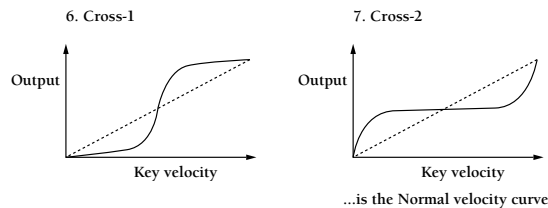

CONTROLLER (hold, reset) - For determining how the W5/W7 responds to various controller data.

HOLD - Prevents the resetting of modulation and other parameters affected by foot switch and other controllers and incoming MIDI data. (NOTE: When receiving GM data, the Controller must be set to hold .)

RESET - Assigns the system default values to the controllers, where: FC = Init Value (see Controllers, below); Foot Volume = Max; Pan = Center; Expression = Max; Pitch Bend = Center; Others = 0.



CONTROLLERS

The Controllers function lets you set the continuous slider (CS) assignment, the foot volume assignment, and the foot controller initial value.

The W5/W7's various controllers can send MIDI control change information, including continuous type and on/off type control, as defined by the MIDI specification.

CONTINUOUS TYPE	
001	Modulation wheel
002	Breath controller
004	Foot controller
005	Portamento time pedal
006	Data entry
007	Main volume
008	Balance control
010	Panpot
011	Expression

ON/OFF TYPE	
064	Sustain
065	Portamento
066	Sostenuto
067	Soft pedal
069	Hold 2
084	Portamento control (legato)
091	Ex effect depth (reverb)
092	Tremolo depth (effect 2)
093	Chorus depth
094	Celeste depth (effect 4)
095	Phaser depth (delay)

● ACCESSING CONTROLLERS

To access the Controllers function, from within the Utility Mode main menu screen, position the cursor over CONTROLLERS and press ENTER, or simply press [F5] (Ctrl). The Controllers screen will appear.

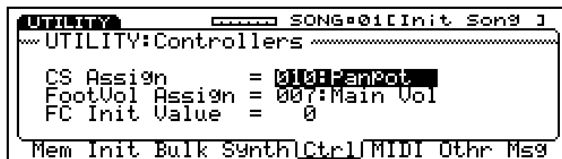

CS ASSIGN (off, 001 ~ 031, 033 ~ 119) - For assigning the function of the continuous slider. The CS may be used for controlling W5/W7 parameters and MIDI data, as well as for sending control change messages to external MIDI devices, since the CS will transmit data using the MIDI control number you specify. If you want to use the CS to control the W5/W7's voices, make sure that the MIDI control number you assign to it matches the MIDI control number selected for the parameter you want to control. (Control change numbers 000 and 032 are used by the bank select message and cannot be chosen.)

FOOT VOLUME ASSIGN (007: main volume, 011: expression) - For setting the MIDI control change number of the Foot Volume controller.

MAIN VOLUME - When set to 007 (main volume), the W5/W7 foot control can function as the main volume control. MIDI messages will be sent according to the Foot Volume controller position. If the Insertion Effect is on, the main volume is controlled after the Insertion Effect, and the Expression Low Limit assignment will not be effective.

EXPRESSION - When set to 011 (expression), the foot controller functions as an expression pedal. MIDI messages will be sent according to the Foot Volume controller position, as determined by the Expression Low Limit assignment (see Voice Edit Mode, Controller function, page 122).

FC INIT VALUE (0 ~ 127) - For assigning the foot controller initial value when the foot controller is not connected. When using the foot controller in realtime, this value has no effect. When receiving MIDI foot controller messages, the value set here is the maximum value that the W5/W7 will receive. (The value set here also determines the reset value of the Synthesizer Setup Controller; see page 145, above.)

MIDI SETUP

The MIDI Setup function lets you determine the W5/W7 device number, set local keyboard status and set program change status.

● ACCESSING MIDI SETUP

To access the MIDI Setup function, from within the Utility Mode main menu screen, position the cursor over MIDI SETUP and press ENTER, or simply press [F6] (MIDI). The MIDI Setup screen will appear.

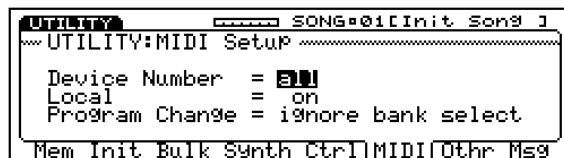

DEVICE NUMBER (off, 1 ~ 16, all) - For determining the channel (1 ~ 16) on which the W5/W7 will receive or transmit MIDI system exclusive messages, such as parameter changes and bulk data. (NOTE: When receiving and transmitting data between the W5/W7 and external devices, the device number parameter for each instrument must be assigned the same number.)

OFF - When set to off, system exclusive messages will not be transmitted or received.

ALL - When set to all, system exclusive messages will be transmitted on channel 1 and received on any channel.

LOCAL (off, on) - For determining whether or not the keyboard will play the W5/W7's tone generator. If you are using the W5/W7 by itself, you should usually leave Local set to on.

ON - When set to on the W5/W7 keyboard will play the internal tone generator

OFF - When set to off, the W5/W7's tone generator will produce sound only in response to messages from MIDI IN; however, messages will be transmitted from MIDI OUT when you play the keyboard or move the various controllers. Data from the W5/W7's internal song sequencer will always be sent to the internal tone generator regardless of the Local setting.

If you are using the W5/W7 as a master keyboard controller with other MIDI tone generators connected, you will want to leave Local off so you can play the other tone generators by selecting one of the tracks (1 ~ 16) in the multi that corresponds to the

MIDI channel of the desired external tone generator. Although when Local is off you cannot play the W5/W7's tone generator from the multi in Song Mode, the keyboard still sends MIDI data to the internal song sequencer. As you record, the MIDI data will echo back from the internal sequencer to the internal tone generator, so you can hear what you're playing as you record.

Local off can also be useful in other situations. Some commercially available MIDI processing devices are able to receive a stream of MIDI note and controller data and process it to create parallel harmony or other musical effects. If you have this type of MIDI processing unit, it may be interesting to turn the W5/W7 local setting off and make MIDI connections so that the note and controller data transmitted from the W5/W7's MIDI OUT is processed by the MIDI processing unit and then transmitted back to the W5/W7's MIDI IN.

If you use an external sequencer with the W5/W7, you will probably record from the W5/W7's MIDI OUT to the sequencer, and playback from the sequencer's MIDI OUT to the W5/W7's MIDI IN. If the external sequencer is able to echo back (retransmit) the data being recorded, you can turn Local off so the W5/W7 will produce sound only in response to data from the external sequencer.

PROGRAM CHANGE (off, on, ignore bank select) - For determining how the W5/W7 responds when a program change message is received at MIDI IN, and how program change messages are transmitted from MIDI OUT. Usually you will leave this set to on.

ON - When set to on, incoming bank select and program change messages will be executed. (NOTE: When loading data from floppy disk, set the Program Change to on.)

OFF - When set to off, incoming bank select and program change messages will be ignored, and program change messages will not be transmitted.

IGNORE BANK SELECT - When set to ignore bank select, only bank select messages will be ignored.

OTHER SETUP

The Other Setup function lets you adjust the LCD contrast and determine if the confirmation screen will appear before an editing operation is engaged.

● ACCESSING OTHER SETUP

To access the Other Setup function, from within the Utility Mode main menu screen, position the cursor over OTHER SETUP and press ENTER, or simply press [F7] (Other). The Other Setup screen will appear.

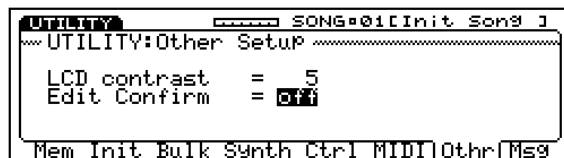

LCD CONTRAST (0 ~ 31) - For adjusting the contrast of the LCD. Lower values make the screen lighter, and higher values make the screen darker.

EDIT CONFIRM (off, on) - When Edit Confirm is turned on, the W5/W7 will give you an opportunity to change your mind before executing an edit operation, asking Are You Sure? Yes[INC]/No[DEC] after you press ENTER. When turned off, the confirmation will not appear, i.e., the edit operation will be executed as soon as you press ENTER.

GREETING MESSAGE

The Greeting Message function lets you create a two-line, 20-character per line message that will appear on the screen during the start-up process after turning on the power.

● ACCESSING GREETING MESSAGE

To access the Greeting Message function, from within the Utility Mode main menu screen, position the cursor over GREETING MESSAGE and press ENTER, or simply press [F8] (Msg). The Greeting Message screen will appear.



CREATING A GREETING MESSAGE - To create a greeting message, choose the upper or lower message line using [F6] and [F7]. Position the character pointer with [F4] and [F5], and select characters with the CURSOR keys, INC/DEC, or the JOG. After you've created your message, press EXIT to return to Utility Mode main menu, or any MODE button on the panel. A space can be entered by pressing [F3] ([SPC]).



APPENDIX

ERROR MESSAGES

During operation, the W5/W7 may display a number of error messages when attempting to perform certain functions. Descriptions of each are explained below.

MEMORY

DISPLAY	COMMENTS
Song memory full !	The sequencer's internal memory is full. Execution of song jobs including recording, bulk reception, and loading from disks is not possible.
Data Empty !	You have attempted to perform a song job on a measure that contains no data.
Song voice memory full !	Since the internal memory is full, a Song voice memory bank cannot be created.
Song element memory full !	Since the internal memory is full, the elements cannot be loaded.
Song voice does not exist !	Since a Song voice bank has not been created for the selected song, voices cannot be selected or edited from the Song voice bank.
Voice bank is off !	Since the voice bank is set to off (no display at the Voice Category), you cannot enter Voice Edit Mode.
No data !	Since the source Song voice bank does not exist, the Song voice memory operation cannot be executed.

DISK

DISPLAY	COMMENTS
Disk not ready !	The disk is not correctly inserted into the disk drive.
Bad disk !	The inserted disk is faulty.
Write protected !	You are trying to write to a disk that has its write-protect tab in place.
Media type error !	The disk is not a 2DD type disk.
Illegal file !	The file is not of a type that can be read by the W5/W7.
File not found !	The file could not be located on the inserted disk.
Disk full !	There is no more memory available on the disk.
Illegal disk !	The data in the disk is faulty.
Disk unformatted !	The disk has not been formatted.
File already exists !	A file with the same name already exists on the disk.
Illegal file name !	The file name cannot be recognized by W5/W7.

MIDI

DISPLAY	COMMENTS
MIDI buffer full !	When attempting to receive or transmit a large amount of MIDI data, the W5/W7's handling capacity was exceeded.
MIDI data error !	An error occurred while receiving or transmitting MIDI data.
MIDI checksum error !	An error occurred while receiving bulk data.
Device number is off !	Since the device number is switched off, bulk data cannot be transmitted or received.
Device number mismatch !	Since the device numbers are not matched, the bulk data was not received or transmitted.

OTHERS

DISPLAY	COMMENTS
Change internal battery !	The internal backup battery needs to be replaced.
Illegal data !	The entered data is not logical.
Data is corrupted. Fixed !	Since the data is corrupted, the internal memory has been replaced by the factory-set status.
SMF illegal timebase !	The tempo data created by another SMF device is not compatible with the W5/W7's tempo track.

TROUBLESHOOTING

During operation, sometimes the W5/W7 may not behave as you expect it to. This doesn't necessarily mean that there is a problem; usually, as you're intensely involved in the music making process, you may leave out an important step or fail to press the correct button for the operation you want to perform.

In fact, most operational errors are of the too simple to even consider variety, such as failing to turn up the volume on the instrument or the monitor system! An improperly set parameter or bad cable or improper cable connection are also common causes of distress.

ISOLATE THE PROBLEM

When an apparent problem exists, the first thing to do is isolate the cause of the problem, and determine whether it is internal (e.g., caused by parameter settings) or external (e.g., caused by bad connections, or the amplifier, etc.).

1. LISTEN VIA HEADPHONES

Plug a pair of headphones into the W5/W7's PHONES jack, turn the volume up, and play. If the headphone sound is OK, then the problem is external, which means the connections are not properly made, or a cable is bad, or you need to check the amplifier or mixer settings.

2. SELECT ANOTHER TRACK OR SWITCH MODES

If the problem still exists while listening via headphones, then select another track and play. If you're in Voice Play Mode, switch to Song Play Mode and select another track. If this alleviates the problem, then it is most likely that a parameter setting for the Instrument voice in the trouble track is the cause. If the problem occurs in all tracks or modes, then the cause may be a utility parameter or other parameter that affects all modes.

COMMON PROBLEMS AND POSSIBLE CAUSES

AMPLIFIER, MIXER, CONNECTION PROBLEMS*

SYMPTOM	POSSIBLE CAUSE
No sound	<ul style="list-style-type: none"> ¥ Is the amplifier/mixer power turned on? ¥ Is the amplifier/mixer volume set to an appropriate level? ¥ Are the W5/W7 outputs properly connected to the amplifier/mixer inputs? ¥ Are the connection cables shorted, open, or otherwise faulty? Try replacing cables.
Distorted sound	<ul style="list-style-type: none"> ¥ Is the W5/W7 connected to a high-sensitivity microphone or instrument input on your amplifier or mixer? Try turning the W5/W7 output level down to avoid over loading the amplifier/mixer inputs.

W5/W7 PARAMETER SETTING PROBLEMS

SYMPTOM	POSSIBLE CAUSE
No sound	<ul style="list-style-type: none"> ¥ Is the pan setting on the mixer set to one side and the pan setting of the voice (Voice Edit Mode) set to the opposite side? (See page 112.) ¥ Is the volume of the selected track set to an appropriate level? (See page 77.) ¥ Are the amp level parameters set high enough? (See page 113.) ¥ Are the voice note and velocity parameters set to appropriate values? (See page 113, 112.) ¥ If a foot volume pedal is connected or a controller is assigned to volume control, is the controller set to produce a high enough volume level? (See page 147.) ¥ Is the highest note limit or lowest note limit set correctly? (See page 112.) ¥ Is the pitch envelope generator set properly? The pitch may be set below the audible range. (See page 117.) ¥ Is the filter set in such a way that most of the sound is filtered out? (See page 116.) ¥ Is the total voice level set high enough? (See page 110.) ¥ Is the amplitude envelope generator attack time set to an excessively long value? (See page 114.) ¥ Is an appropriate wave (element) assigned to the voice? (See page 112.) ¥ Is the velocity curve setting appropriate? (See page 145.) ¥ Are the volume levels of the multi Instruments set high enough? (See page 77.) ¥ Are the sequencer track transmit channels properly matched to the multi Instrument channels? (See page 82.) ¥ Is the tuning set properly? (See page 78.) ¥ Is the note shift parameter set properly? (See page 78.) ¥ Is the keyboard local off mode selected? (See page 148.) ¥ If the multi used the Song voices before turning the power off, no sound is produced from the keyboard when turning the power back on, since the Song voice data has been lost. Change the voice bank or reload the Song voice data.
Wrong pitch	<ul style="list-style-type: none"> ¥ Are the note shift parameters for each voice set to appropriate values? (See page 118.) ¥ Are the note shift parameters for each multi Instrument set properly? (See page 78.) ¥ Are the tune parameters for each multi Instrument set properly? (See page 78.) ¥ Is the master tune parameter set properly? (See page 78.)
Unstable, indefinite pitch	<ul style="list-style-type: none"> ¥ Is the random pitch parameter set properly? (See page 118.) ¥ Is the aftertouch EG bias parameter set properly? (See page 122.) ¥ Is the LFO pitch modulation parameter set to an excessively high value? (See page 121.) ¥ Is the pitch envelope generator set properly? (See page 118.)
Some notes not played	<ul style="list-style-type: none"> ¥ Does the sequence data exceed the playback maximum 32-note polyphony of the W5/W7?
The song sequence data doesn't run even though the song name is displayed on the screen	<ul style="list-style-type: none"> ¥ Song multi settings including the song name will be retained even when the power is turned off; however, song sequence data (and Song voice data) will be lost.

MOUNTING THE EXPANSION BOARD

The optional W5/W7 Expansion Wave/Voice Board allows you to increase the amount of voices and AWM elements by an additional 4Mbytes. (NOTE: For information about the types of boards available, please consult your nearest Yamaha dealer.)

IMPORTANT NOTE: Caution! Mounting the Expansion Wave/Voice Board may erase the internal memory. Be sure to save all internal data to floppy disk before installing the board.

MOUNTING THE BOARD

To mount the Expansion Wave/Voice Board, please follow the steps below.

1. SWITCH THE POWER OFF

Turn the W5/W7 power switch off, and disconnect its power cord from the AC outlet.

2. PLACE ON A STURDY LEVEL SURFACE

Place the W5/W7 face down on a sturdy table or other level surface. (In order to keep from scratching the finish of the instrument, lay a blanket or thick towel on the table first.)

3. REMOVE THE COVER

Using a phillips screwdriver, unscrew the eight screws holding the square cover into place, and remove the cover as shown in the illustration being extremely careful not to drop the screws or any other foreign materials into the W5/W7 s chassis.

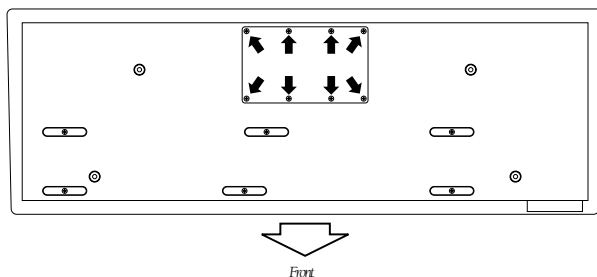

4. MOUNT THE BOARD

Holding the board by its edges, check to make sure the two connectors on the Expansion Board are facing the same direction as the two ports on the W5/W7 s circuit board. Then, position the Expansion Board over the four supporting clips, as illustrated, and carefully insert the Board, applying equal downward pressure on all four corners. The Board should click into place. Do not apply excess pressure to the Board.

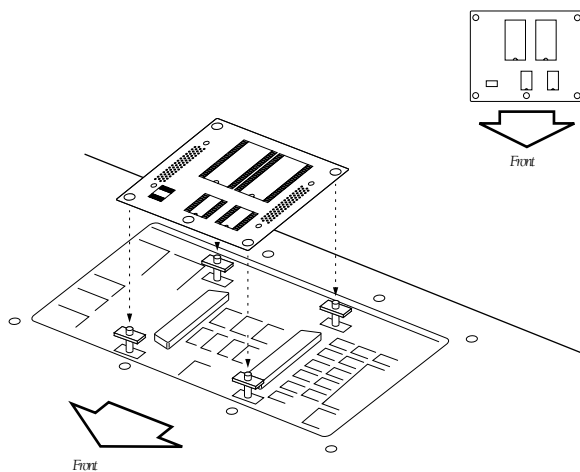

5. REPLACE THE COVER

When the board has clicked into place, the installation process is finished. Reposition the square cover over the access hole and reattach the eight screws.

SPECIFICATIONS

DESCRIPTION

Easy operation professional music production workstation featuring synthesizer, sequencer, full voice and song editing capabilities, large memory capacity and GM compatibility

TONE GENERATOR

AWM2 (2nd Generation Advanced Wave Memory): 16 bit linear waveform data, maximum 48kHz sampling frequency

Maximum simultaneous notes: 32

Maximum simultaneous timbres: 1 (Voice Mode), 16 (Song Multi Play Mode)

Note assignment: Last note priority

KEYBOARD

W5: 76 notes, key velocity sensitivity, aftertouch

W7: 61 notes, key velocity sensitivity, aftertouch

DSP EFFECTS

Insertion Effects modules (35 effects): Stereo in/out module, Mono in/Stereo out module, Mono in/out module

System Effect 1, 2, 3 modules (40 effects): Reverb module, Chorus module, Delay/Reverb module

SEQUENCER

Songs: 16

Tracks: 16

Resolution: 1/96 of a quarter note (for internal clock), 1/96 of a quarter note (for MIDI sync)

Maximum simultaneous notes: 32

Capacity: Approximately 100,000 notes

Recording: Realtime, Step, Punch-in

Editing: Event Change, Event Insert, Song Jobs

Format: Song (Load/Save), SMF Format-0 (Load/Save), SMF Format-1 (Load), ESEQ (Load)

MEMORY

Preset waves: 8Mbytes

GM voices: 128 (normal) + 8 (drum)

Preset voices: 128 (normal) + 2 (drum)

Internal voices: 128 (normal) + 2 (drum)

Song voices: 128 (normal) + 2 (drum) × 16 songs

External voices (option):

Disk drive: 3.5 2DD type floppy disk (9 sector, 720kbyte formatted)

CONTROLLERS

Wheels: Pitch Bend, Modulation

Sliders: Volume, Continuous (CS)

Dials: Jog/Shuttle

Panel switches: Song Mode; Voice Mode; Edit Mode; Utility Mode; Job Mode; Disk Mode; Store; Voice Edit; Track Select; Solo; Track \times 16; Sequencer Record, Stop/Top, Run; Shift; Function \times 8; Exit; Numeric Keypad [0 ~ 9], Negative value [—], Enter; Cancel; Data/Cursor; Increment [INC]; Decrement [DEC]; Cursor-up, -down, -left, -right

DISPLAY

LCD: 240 \times 64 dot (with contrast adjust)

LED: 20 (square), 8 (round)

TERMINALS

Audio output: Output (L/Mono, R), Phones

Foot pedals: Sustain, Foot Controller, Foot Volume,

MIDI: IN, OUT, THRU

POWER REQUIREMENTS

USA and Canadian models: 120V

General model: 220 ~ 240V

POWER CONSUMPTION

20 watts

OUTPUT IMPEDANCE

Output: +6.5 dBm (10 k Ω)

Phones: +13 dBm (150 Ω), +7.5 dBm (33 Ω)

DIMENSIONS

W5: 1288 (W) \times 371 (D) \times 121 (H) mm (50-3/4 \times 14-1/2 \times 4-3/4)

W7: 1067 (W) \times 371 (D) \times 121 (H) mm (42 \times 14-1/2 \times 4-3/4)

WEIGHT

W5: 18 kg (39-1/2 lbs.)

W7: 14 kg (30-1/2 lbs.)

INCLUDED ACCESSORIES

Factory Set & Demonstration Disk, AC Power Cable

Specifications and descriptions in this Owner's Manual are for information purposes only.
Yamaha Corp. reserves the right to change or modify products or specifications at any time without prior notice.
Since specifications, equipment or options may not be the same in every locale, please check with your Yamaha dealer.

INDEX

A

AEG, see amplitude envelope generator

AFTERTOUCH, description of keyboard aftertouch control, 51, element controller, 122, insert aftertouch data, 94

AFTERTOUCH PITCH BEND RANGE, pitch bend controller, 122

ALL TRACKS, description, 87, realtime recording, 88

ALTERNATE GROUP, drum voice key parameter, 126

AMD, see amplitude modulation depth

AMP, see amplitude

AMP LEVEL, element amplitude edit, 113

AMP TEMPLATE TYPE, 113

AMPLITUDE, accessing amp parameters, 113, normal voice edit mode, 113, velocity sensitivity, 113

AMPLITUDE ENVELOPE GENERATOR, normal voice edit mode, 114

AMPLITUDE MODULATION DEPTH, 121

AMPLITUDE MODULATION DEPTH, aftertouch controller, 122, foot controller, 123, modulation wheel controller, 123

APPEND SONG, song job 1, 96

APPENDIX, 151

ASSIGN, CS assign, 147, drum voice key element assign, 125, normal voice element assign, 112

AVAILABLE MEMORY, 76

AWM, element diagram, 30, overview, 30, tone generation, 104

AWM ELEMENTS, description and diagram, 104

AWM TONE GENERATION, overview and element chart, 30, feature reference, 104

B

BACK DELETE, step recording, 90

BACKUP, data backup and storage, 5

BAND, filter velocity band sensitivity, 116

BANK, normal voice element bank, 112

BEAT, sequence/tempo track data insert, 94

BEF (BAND ELIMINATION FILTER), filter, 115

BEFORE YOU BEGIN, introductory section, 7

BIAS, element aftertouch controller EG bias, 122

BPF (BAND PASS FILTER), filter, 115

BULK DUMP, utility mode, 144

C

CANCEL, cancel button, 42, front panel diagram description, 14, when to use, 42

CHANGE, changing data, 92, sequence/tempo track data change, 92

CHANGING DATA, sequence/tempo track data change, 92

CHANGING THE TEMPO, getting started, 55

CHORD SORT, song job 2, 100

CHORUS MODULE, system effect diagram and description, 79

CLEANING, cleaning the disk drive read/write head, 6, cleaning the instrument, 5

CLEAR SONG, song job 1, 96

CLEAR TRACK, song job 1, 97

CLICK, click beat select, 80, 87, click level select, 81, 87, click mode select, 80, 87

CLOCK, sequence/tempo track data insert, 94

COMMON, accessing drum voice common parameters, 125, accessing normal voice common parameters, 110, drum voice common parameter, 125, normal voice common initialization values, 110, normal voice common parameter, 110

COMMON INITIALIZATION VALUES, normal voice, 110

COMMON PARAMETER, drum voice edit mode, 125, normal voice edit mode, 110

COMPARE, voice edit/compare, 108

CONFIRM, edit confirm on/off, 149

CONNECTING TO A MONITOR SYSTEM, getting started, 44

CONTINUOUS SLIDER, CS assign, 147, description of continuous slider control, 50, front panel diagram description, 12

CONTROL, normal voice insertion effect control, 120, realtime control, 50, voice control, 105

CONTROL CHANGE, insert control change data, 94

CONTROLLER, accessing drum voice controller parameters, 128, accessing normal voice controller parameters, 122, aftertouch pitch bend range, 122, aftertouch, 122, amplitude modulation depth, 122, controller section, 22, cutoff, 122, drum voice edit mode, 128, drum voice MIDI control, 128, EG bias, 122, expression low limit, 122, filter modulation depth, 122, foot controller, 50, keyboard 4-zone mode, 84, normal voice edit mode, 122, normal voice MIDI control, 124, pitch bend range, 122, pitch bend, 122, pitch modulation depth, 122, sustain, 122, synthesizer setup, 145

CONTROLLER SECTION, system architecture description, 22

CONTROLLERS, accessing controllers, 147, continuous type chart, 147, CS assign, 147, description, 32, foot controller initial value, 147, foot volume assign, 147, on/off type chart, 147, realtime control, 50, utility mode, 147

CONTROLLING THE SOUND, sound control features, 31

CONTROLS, sequencer controls, 61

COPY MEASURE, song job 2, 98

COPY SONG, song job 1, 96

COPY TRACK, song job 1, 97

CREATE MEASURE, song job 2, 98

CRESCENDO, song job 3, 103

CS, see continuous slider

CS ASSIGN, utility mode controllers, 147

CURSOR, cursor position at power on, 46, front panel diagram description, 14, how to use, 42, location when selecting tracks and functions, 46

CURVE, synthesizer setup velocity curve, 145

CUTOFF, aftertouch controller, 122, filter, 116, foot controller, 123, modulation wheel controller, 123

D

DATA, backup and storage, 5, data delete, 92, data entry functions and methods, 41, data entry keypad, 42, data move, 92, how to save and load data, 64, inserting data, 94, modes and functions for managing data, 38, new data value, 92, organizing and managing data, 65, receiving bulk voice data, 144, sequence/tempo track data change, 92, sequence/tempo track data insert, 93, step recording data input, 90, types of data that can be changed, 93, voice bulk data dump, 144

DATA/CURSOR BUTTON, front panel diagram description, 14, on and off status, 42

DATA BACKUP AND STORAGE, safety precautions, 5

DATA CHANGE, accessing data change, 92, changing data, 92, locating data, 92, sequence/tempo track data change, 92

DATA CHANGE TEMPO TRACK, how to access, 93

DATA ENTRY, data entry keypad, 42, various data entry functions and methods, 41

DATA ENTRY KEYPAD, front panel diagram description, 14, how to use, 42

DATA INPUT, step recording, 90, how to access, 93, inserting data, 93, locating data, 93, sequence/tempo track data insert, 93

DATA INSERT TEMPO TRACK, how to access, 94

DECAY, drum voice key parameter, 126

DEFINING A SONG MULTI, steps in the process, 74

DELAY, LFO, 121

DELAY/REVERB MODULE, system effect diagram and description, 79

DELETE, data delete, 92, deleting notes in sequence track graph, 91, step recording back delete, 90, step recording, 90

DELETE FILE, disk mode, 140

DELETE MEASURE, song job 2, 99

DEMONSTRATION SONGS, loading and playing the demonstration songs, 52

DIAGRAM, AWM element, 30, 104, front panel, 10, insertion effects and system effects, 28, normal and drum voice mixer channels, 24, normal voice and drum voice, 106, song multi screen, 76, system overview diagram, 18, voice bank chart, 49, voice categories, 27, voice categories, 47

DIRECTORY, file directory, 132, song directory, 81

DISK, description of disk mode, 40, disk mode, 131

DISK DRIVE, how to use and proper care of, 6

DISK MODE, accessing disk mode functions, 131, delete file, 140, disk status, 133, entering and exiting disk mode, 131, feature reference, 131, format disk, 141, load from disk, 136, moving around in disk mode, 131, operating modes description, 21, rename file, 139, save to disk, 134, selecting files, 132

DISK STATUS, accessing disk status function, 133, disk mode, 133

DRUM, drum voice edit mode, 124

DRUM VOICE, description and diagram, 106, effect parameters, 127, mixer channel diagram, 24

DRUM VOICE, voice bank abbreviation codes and descriptions, 26

DRUM VOICE BANKS, chart of list and description of each, 49

DRUM VOICE COMMON PARAMETER, drum voice edit mode, 125

DRUM VOICE EDIT MODE, accessing voice edit parameters, 124, effect, 127, entering and exiting drum voice edit mode, 124, voice edit mode, 124

DRUM VOICE KEY PARAMETER, drum voice edit mode, 125

E

EDIT, accessing drum voice edit parameters, 124

EDIT, accessing normal voice edit parameters, 109, edit confirm on/off, 149, editing a voice, 108, normal voice edit mode, 109, normal voice edit mode, 124, steps in editing a voice, 58, voice edit/compare, 108, voice editing overview, 33

EDIT/COMPARE, voice edit/compare, 108

EDIT CONFIRM, utility mode other setup, 149

EDITING A VOICE, 108

EFFECT, accessing drum voice effect parameters, 127, accessing normal voice effect parameters, 119, drum voice edit mode, 127, drum voice effect mode, 127, drum voice insertion effect parameter, 127, drum voice insertion effect type, 127, mixer insertion effect switch, 77, mixer master return level, 77, mixer system effect sends, 77, normal voice edit mode, 119, normal voice effect mode, 119, normal voice insertion effect control, 120, normal voice insertion effect parameter, 120, normal voice insertion effect type, 119, song multi screen, 36, system effect drum voice send level, 127, system effect normal voice send level, 119, system effect parameter select, 78, system effect parameter, 79, system effect type select, 77, system effect type, 79

EFFECT MODE, drum voice insertion effect type, 127, normal voice insertion effect type, 119

EG, see envelope generator

EG BIAS, aftertouch controller, 122, foot controller, 123, modulation wheel controller, 123

EG RANGE, element pitch sensitivity, 118

ELEMENT, accessing filter parameters, 116, accessing normal voice element parameters, 112, amplitude envelope generator, 114, amplitude velocity sensitivity, 113, amplitude, 113, description and diagram, 104, diagram, 30, drum voice element bank select, 125, drum voice element number select, 126, drum voice key element assign, 125, element display, 109, element pitch sensitivity, 118, filter envelope generator, 116, filter, 115, LFO, 121, normal voice edit mode, 112, normal voice element assign, 112, normal voice element bank, 112, normal voice element initialization values, 111, normal voice element number, 112, normal voice element pan, 112, normal voice note limit, 113, normal voice velocity limit, 112, note shift, 118, pitch, 117, pitch envelope generator, 118, selecting elements, 109, switching elements on and off, 109, tune, 118

ELEMENT ASSIGN, normal voice element parameter, 112

ELEMENT BANK, normal voice element parameter, 112

ELEMENT BANK SELECT, drum voice key parameter, 125

ELEMENT INITIALIZATION VALUES, normal voice, 111

ELEMENT NOTE LIMIT, normal voice, 113

ELEMENT NUMBER, normal voice element parameter, 112

ELEMENT NUMBER SELECT, drum voice key parameter, 126

ELEMENT ON/OFF, 109

ELEMENT PAN, normal voice element parameter, 112

ELEMENT SELECT, 109

ELEMENT VELOCITY LIMIT, normal voice element parameter 112

END OF TRACK, sequence/tempo track data change, 92

ENVELOPE GENERATOR, amplitude envelope generator, 114, description, 31, filter envelope generator, 116, pitch envelope generator, 118

ERASE MEASURE, song job 2, 98

ERROR MESSAGES, appendix, 152

ESEQ, load from disk, 137

EXIT KEY, front panel diagram description, 13

EXPANSION WAVE/VOICE BOARD, how to mount, 155

EXPLORING SONG PLAYBACK OPTIONS, getting started, 54

EXPLORING THE PRESET VOICES, getting started, 45

EXPRESSION, foot volume assign, 147

EXPRESSION LOW LIMIT, drum controller, 128

EXPRESSION LOW LIMIT, normal voice sustain controller, 122

EXTRACT, song job 2, 99

F

FACTORY SET & DEMONSTRATION DISK, loading the demonstration songs, 52

FACTORY SET & DEMONSTRATION DISK, reloading the factory set voice data, 66

FC INIT VALUE, utility mode controllers, 147

FEATURE REFERENCE, 71

FEG, see filter envelope generator

FILE, file directory, 132, name file, 132, selecting files, 132

FILE DIRECTORY, disk mode, 132

FILE TYPE, selecting a file type, 132, three-character codes, 132

FILTER, accessing filter parameters, 116, normal voice edit mode, 115, song setup MIDI filter, 82, tone, 116

FILTER CUTOFF, 116

FILTER ENVELOPE GENERATOR, normal voice edit mode, 116

FILTER MODULATION DEPTH, 121, aftertouch controller, 122, foot controller, 123, modulation wheel controller, 123

FILTER TEMPLATE TYPE, 116

FIX, element pitch note shift, 118

FLOPPY DISK, how to use and proper care and storage of, 6

FLOPPY DISK DRIVE, front panel diagram description, 12, how to use and proper care of, 6

FMD, see filter modulation depth

FOOT CONTROLLER, controller, 123, description of foot controller control, 50, FC initial value, 147

FOOT CONTROLLER JACK, rear panel diagram description, 16

FOOT SUSTAIN, description of foot sustain control, 50

FOOT VOLUME, description of foot volume control, 50

FOOT VOLUME ASSIGN, utility mode controllers, 147

FOOT VOLUME JACK, rear panel diagram description, 16

FORMAT DISK, disk mode, 141

FORTE, step recording velocity value, 90

FOUR-ZONE, keyboard 4-zone mode, 83

FUNCTION KEYS, front panel diagram description, 13

G

GATE TIME, drum voice key parameter, 126

GENERAL MIDI, about the GM system level 1, 8, drum voice track and, 45, system exclusive message setting for, 94

GETTING STARTED, tutorial, 43

GRAPH, sequence track graph, 91

GREETING MESSAGE, utility mode, 149

H

HIGH LIMIT, keyboard 4-zone mode, 83
HOLD, synthesizer setup controller, 145
HOW TO USE THIS MANUAL, 4
HPF (HIGH PASS FILTER), filter, 115

I

INC/DEC BUTTONS, front panel diagram description, 14
INC/DEC BUTTONS, how to use, 42
INITIAL VALUE, foot controller, 147
INITIALIZE, drum voice common parameter, 125, normal voice common parameter, 110, utility mode, 144
INITIALIZATION VALUES, normal voice common initialization values, 110, normal voice element initialization values, 111
INITIALIZE INTERNAL VOICE BANK, utility mode, 144
INSERT, inserting data, 93, sequence/tempo track data insert, 93
INSERT MEASURE, song job 2, 99
INSERTION EFFECT, description, 29, drum voice insertion effect parameter, 127, drum voice insertion effect type, 127, mixer insertion effect switch, 77, multi diagram, 28, normal voice insertion effect control, 120, normal voice insertion effect parameter, 120, normal voice insertion effect type, 119
INSERTION EFFECT CONTROL, drum voice edit mode, 127, normal voice edit mode, 120
INSERTION EFFECT PARAMETER, drum voice edit mode, 127, normal voice edit mode, 120
INSERTION EFFECT SWITCH, mixer, 77, song multi screen, 36
INSERTION EFFECT TYPE, drum voice edit mode, 127, normal voice edit mode, 119
INSTRUMENT, instrument parameter display, 63, instrument parameter select, 63, instrument track select, 63, instrument parameter display, 75, instrument parameter select, 75, instrument track select, 75
INSTRUMENT VOICES, definition, 25
INTERNAL VOICE, internal voice store, 130, recalling the factory set internal voices, 144
INTERNAL VOICE BANK, recalling the factory set internal voices, 144, reloading the factory set voice data, 66

J

JACKS, foot controller jack, foot volume jack, midi connectors, phones jack, power connector, stereo output jacks, sustain jack, 16
JOB, song job mode, 95
JOG/SHUTTLE DIAL, front panel diagram description, 14, functions of, 42

K

KEY, drum voice key element assign, 125, drum voice key parameter, 125, drum voice key select, 125, key velocity description, 31
KEY ASSIGN, drum voice key parameter, 125
KEY PARAMETER, accessing drum voice key parameters, 125, drum voice edit mode, 125
KEY SELECT, drum voice key parameter, 125
KEY VELOCITY, description, 31
KEYBOARD, 4-zone mode, 83, front panel diagram description, 12, keyboard aftertouch control, 51, keyboard pitch scale, 117, keyboard velocity sensitivity control, 51, layer mode, 83, local on/off, 148, normal mode, 83, sequence track graph, 91, split mode, 83, split point, 83, step recording data input, 90, step recording velocity value, 90
KEYBOARD PITCH SCALE, 117
KEYBOARD SETUP, how to access, 82
KEYBOARD VELOCITY SENSITIVITY, description of keyboard velocity sensitivity control, 51
KEYBOARD VIEW, sequence track graph, 91, step recording, 90
KEYPAD, data entry, 42, step recording data input, 90

L

LAYER, keyboard layer mode, 83, upper/lower assign, 83
LCD, data entry information, 41
LCD CONTRAST, utility mode other setup, 149
LCD SCREEN, data entry information, 41, front panel diagram description, 13
LFO, accessing LFO parameters, 121, amplitude modulation depth, 121, filter modulation depth, 121, low frequency oscillator description, 32, modulation, 121, normal voice edit mode, 121, pitch modulation depth, 121
LFO DELAY, 121
LFO MODULATION, 121
LFO PARAMETER, 121
LFO SPEED, 121
LIMIT, normal voice element note limit, 113, normal voice element velocity limit, 112
LOAD FROM DISK, accessing load from disk function, 136, load all, 136, disk mode, 136, load 1 song, 136, load 1 song + voice, 137, load ESEQ/SMF, 137, load voice, 138
LOADING & PLAYING THE DEMO, getting started, 52
LOCAL, keyboard local on/off, 148
LOW FREQUENCY OSCILLATOR, see LFO
LOW LIMIT, keyboard 4-zone mode, 83
LPF (LOW PASS FILTER), filter, 115

M

MAIN VOLUME, foot volume assign, 147

MASTER NOTE SHIFT, how to access, 78

MASTER RETURN LEVEL, how to access, 77

MASTER TUNE, how to access, 78, synthesizer setup, 145

MASTER VOLUME, song multi screen, 36, voice volume select, 77

MEASURE BAR, sequence track graph, 91, sequence/tempo track data insert, 94, step recording, 89

MEASURE, measure locate assign, 81, measure locate, 81, measure mark, 92, measure select, 80, measure select, 86

MEMORY, accessing song voice memory, 143, available memory gauge, 76, copying to song voice memory, 143, memory allocation, 38, modes and functions for managing data, 38, selecting a song voice memory, 143, song voice memory, 143, volatile and nonvolatile memory banks, 38

MEZZO FORTE, step recording velocity value, 90

MIDI, about the GM system level, 8, controlling other devices, 67, device number, 148, drum voice track and GM, 45, integrating the W5/W7 into a midi system, 67, keyboard local on/off, 148, MIDI channel/instrument track, 76, MIDI filter, 82, MIDI setup, 148, program change, 148, slaving to other devices, 69, song other setup MIDI control, 84, sync, 84, system component, 68, transmit channel, 82

MIDI CONNECTORS, rear panel diagram description, 15

MIDI CONTROL 1/2, drum voice controller, 128, normal voice controller, 124

MIDI FILTER, how to access, 82

MIDI SETUP, accessing MIDI setup, 148, device number, 148, keyboard local on/off, 148, program change, 148, utility mode, 148

MIX TRACK, song job 1, 97

MIXER, fine-tuning the stereo mix, 63, mixer channel diagram, 24, sound mixing, 35, tone generator mixer, 22

MIXING, fine-tuning the stereo mix, 63, sound mixing, 35

MODE, see data change mode, data graph mode, data insert mode, disk mode, drum voice edit mode, normal voice edit mode, realtime record mode, solo mode, song mode, song multi play mode, song play mode, song record mode, step record mode, store mode, utility mode, voice edit mode, voice mode, voice play mode

MODE SECTION, front panel diagram description, 12

MODIFY GATE TIME, song job 3, 101

MODIFY VELOCITY, song job 3, 102

MODULATION, LFO, 121

MODULATION WHEEL, controller, 123, description of modulation wheel control, 50, front panel diagram description, 12

MOVE CLOCK, song job 3, 101

MULTI, mixer channel diagram, 24, song multis, 23, steps in defining a song multi, 56, 74, store multi, 39, 129

MUSIC DATA, backup and storage, 5, how to save and load data, 64, organizing and managing data, 65

MUTE, soloing and muting instruments, 55, track solo and mute, 74

N

NAME, drum voice name, 125, name file, 132, naming a song, 81, normal voice name, 110

NEXT SONG, other setup, 84

NORMAL, keyboard normal mode, 83, normal voice edit mode, 109, step recording, 89

NORMAL VOICE, description and diagram, 106, effect parameters, 119, mixer channel diagram, 24, voice bank abbreviation codes and descriptions, 25

NORMAL VOICE BANKS, chart of list and description of each, 49

NORMAL VOICE COMMON PARAMETER, 110

NORMAL VOICE EDIT MODE, accessing normal voice edit parameters, 109, effect, 119, entering and exiting normal voice edit mode, 109, feature reference, 109

NOTE, element pitch note shift, 118, insert note data, 94, normal voice element note limit, 113, note capacity/polyphony, 25, simultaneous note capacity, 74

NOTE CAPACITY, instrument voices and polyphony, 25, simultaneous note capacity, 74

NOTE LENGTH, step recording, 90

NOTE LIMIT, normal voice element note limit, 113

NOTE SHIFT, drum voice key parameter, 126, how to access, 78, master note shift, 78, normal voice edit mode, 118, song multi screen, 37

O

OCTAVE, keyboard 4-zone mode, 83

OTHER, utility mode other setup, 149

OTHER SETUP, accessing other setup, 149, edit confirm on/off, 149, how to access, 84, LCD contrast, 149, MIDI control, 84, next song, 84, sync, 84, transpose, 84, utility mode, 149

OUTPUT, drum voice key parameter, 126

OVERDUB, realtime recording, 88

P

PAN, drum voice key element pan position, 126, normal voice element pan, 112, selecting and adjusting voice pan, 54, song multi screen, 36, voice pan, 77

PAN POSITION, drum voice key parameter, 126

PANEL, front panel diagram, 10, rear panel diagram, 15

PARAMETER, drum voice insertion effect control, 127, drum voice insertion effect parameter, 127, LFO, 121, normal voice insertion effect control, 120, normal voice insertion effect parameter, 120

PEG, see pitch envelope generator

PHONES JACK, rear panel diagram description, 16

PIANO, step recording velocity value, 90

PITCH, accessing pitch parameters, 117, envelope generator, 118, normal voice edit mode, 117, scale, 117, sensitivity, 118, template type, 117, tune, 118

PITCH BEND, element controller, 122, insert pitch bend data, 94, song multi screen, 37

PITCH BEND RANGE, how to access, 78, pitch bend controller, 122, song multi screen, 37

PITCH ENVELOPE GENERATOR, 118

PITCH MODULATION DEPTH, 121

PITCH MODULATION DEPTH, aftertouch controller, 122, foot controller, 123, modulation wheel controller, 123

PITCH TEMPLATE TYPE, 117

PITCH WHEEL, description of pitch wheel control, 50, front panel diagram description, 12

PLAYBACK, selecting tracks for playback, 74

PMD, see pitch modulation depth

POLYPHONY, instrument voices and polyphony, 25, simultaneous note capacity, 74

POWER CONNECTOR, rear panel diagram description, 15

POWER SUPPLY, safety precautions, 5

POWER SWITCH, rear panel diagram description, 15

POWER-ON PROCEDURE, getting started, 45

PRECAUTIONS, safety precautions and other important instructions, 5

PRESET VOICES, exploring the, 45

PROGRAM CHANGE, insert program change data, 94, MIDI setup, 148

PROGRAMMING, getting started, 56

Q

QUANTIZE, song job 3, 100, song record mode, 86

R

RANDOM, pitch tune, 118

REALTIME CONTROL, controllers, 50

REALTIME RECORDING, all tracks, 87, all tracks, 88, feature reference, 87, overdub, 88, preparing for, 88, realtime run, 88, replace, 88

REALTIME RUN, realtime recording, 88

RECORDING, all tracks, 87, all tracks, 88, overdub, 88, preparing for realtime recording, 88, preparing for step recording, 89, realtime run, 88, replace, 88, steps to recording a song, 85

REDO, song job undo/redo, 95

RENAME FILE, disk mode, 139

REPLACE, realtime recording, 88

RESET, synthesizer setup controller, 145

RESONANCE/BAND, filter, 116

RETURNS, mixer master return level, 77

REVERB MODULE, system effect diagram and description, 79

REVERSE, drum voice key parameter, 126

S

SAFETY, safety precautions and other important instructions, 5

SAVE TO DISK, accessing save to disk function, 134, disk mode, 134, save all, 134, save 1 song, 134, save 1 song + voice, 135, save SMF, 135, save voice, 135

SAVING & LOADING, how to save and load data, 64

SCALE, pitch, 117

SCROLL, step recording data input, 90

SELECTING A SONG, from within the song directory, 81

SELECTING TRACKS AND ADJUSTING PARAMETERS, getting started, 54

SEND, drum voice system effect send level, 126, mixer system effect send levels, 77, system effect drum voice send level, 127, system effect normal voice send level, 119, system effect voice send level setting, 77, system effect voice send level, 80

SENSITIVITY, description of keyboard velocity sensitivity control, 51, element pitch sensitivity, 118, filter velocity sensitivity, 116, pitch, 118

SEQUENCE, playing a song sequence, 73, sequence track graph, 91, song sequence play, 80

SEQUENCE/TEMPO TRACK DATA CHANGE, feature reference, 92

SEQUENCE/TEMPO TRACK DATA INSERT, feature reference, 93

SEQUENCE TRACK GRAPH, feature reference, 91

SEQUENCER, accessing a song record function or parameter, 86, playing a song sequence, 73, sequencer controls, 61, sequencer section, 22, song sequence play, 80, using the sequencer controls, 86

SEQUENCER CONTROLS, getting started, 61, using the sequencer controls, 86

SEQUENCER SECTION, front panel diagram description, 12, system architecture description, 22

SEQUENCING, accessing a song record function or parameter, 86, creating song sequences, 61, song sequencing overview, 34

SETUP, MIDI setup, 148, song setup, 82, utility mode other setup, 149

SETUP & PLAY, getting started, 44

SHIFT, element pitch note shift, 118

SHIFT KEY, front panel diagram description, 13

SHIFT NOTE, song job 3, 103

SINGLE VOICE, loading a single voice, 138

SLUR, step recording, 89

SMF, load from disk, 137, save to disk, 135, saving and loading, 131

SOLO, soloing and muting instruments, 55, track solo and mute, 74

SOLOING AND MUTING INSTRUMENTS, getting started, 55

SONG, selecting a song from within the song directory, 81, song select, 80, song setup, 82

SONG DIRECTORY, how to access, 81, selecting a song from within, 81

SONG EDIT MODE, entering and exiting song edit mode, 91, feature reference, 91, operating modes description, 19, overview, 72, sequence track graph, 91

SONG JOB 1, append song, 96, clear song, 96, clear track, 97, copy song, 96, copy track, 97, feature reference, 96, mix track, 97

SONG JOB 2, chord sort, 100, copy measure, 98, create measure, 98, delete measure, 99, erase measure, 98, extract, 99, feature reference, 98, insert measure, 99, thin out, 99

SONG JOB 3, crescendo, 103, feature reference, 100, modify gate time, 101, modify velocity, 102, move clock, 101, quantize, 100, shift note, 103, transpose, 102

SONG JOB MODE, entering and exiting song job mode, 95, feature reference, 95, moving around in job mode, 95, operating modes description, 20, overview, 72, undo/redo, 95

SONG MODE, feature reference, 72, operating modes description, 19

SONG MULTI, accessing song multi, 75, feature reference, 74, instrument parameter display, 75, instrument parameter select, 75, instrument track select, 75, mixer channel diagram, 24, moving around in the song multi, 76, overview, 23, song multi screen, 76, steps in defining a multi, 56, steps in defining a song multi, 74

SONG MULTI PLAY FUNCTION, description, 73

SONG MULTI PLAY MODE, status at power on, 45

SONG MULTI SCREEN, feature reference, 76

SONG NAME, how to name a song, 81

SONG OTHER SETUP, how to access, 84

SONG PLAY MODE, feature reference, 73, operating modes description, 19, overview, 72

SONG PLAYBACK, exploring song playback options, 54

SONG RECORD, accessing a song record function or parameter, 86

SONG RECORD MODE, entering and exiting song record mode, 85, feature reference, 85, operating modes description, 19, overview, 72, steps to recording a song, 85

SONG SEQUENCE, playing a song sequence, 73, song sequence play, 80

SONG SEQUENCE PLAY, feature reference, 80, how to access, 80

SONG SEQUENCE PLAY FUNCTION, description, 73

SONG SEQUENCING, accessing a song record function or parameter, 86, overview, 34, steps in creating a song sequence, 61

SONG SETUP, feature reference, 82, how to access, 82, keyboard setup, 82, other setup, 84, playback filter, 82, track transmit channel, 82

SONG SETUP FUNCTION, description, 73

SONG VOICE, description and how to manage, 38, song voice memory, 143, song voice store, 130

SONG VOICE MEMORY, accessing song voice memory, 143, copying to song voice memory, 143, description and how to manage Song voices, 38, selecting a song voice memory, 143, utility mode, 143

SOUND CONTROL, controlling the sound, 31

SOUND MIXING, overview, 35

SPECIFICATIONS, appendix, 156

SPEED, LFO, 121

SPLIT, keyboard split mode, 83, keyboard split point, 83, keyboard split upper/lower assign, 83

STACCATO, step recording, 89

STEP RECORDING, back delete, 90, data input, 90, delete, 90, feature reference, 89, forte, 90, keyboard view, 90, keyboard, 90, mezzo forte, 90, normal, 90, note length, 90, piano, 90, preparing for, 89, slur, 90, staccato, 90, step stop, 90, velocity values, 90

STEP RUN, step recording, 89

STEP STOP, step recording, 90

STEREO OUTPUT JACKS, rear panel diagram description, 16

STORAGE, data backup and storage, 5

STORE, store mode, 129, store multi, 39, store multi, 129, store voice, 39, store voice, 130, storing a voice, 108

STORE BUTTON, front panel diagram description, 12

STORE MODE, entering and exiting store mode, 129, feature reference, 129, operating modes description, 21

STORE MULTI, accessing store multi function, 129, before storing a multi, 129, description, types of data which can be stored, when to use, 39, selecting the song location, 129, store mode, 129

STORE VOICE, accessing store voice function, 130, before storing a voice, 130, description, types of voices which can be stored, 39, selecting the voice location, 130

STORING A VOICE, 108

SUSTAIN, element controller, 122, foot sustain control, 50

SUSTAIN JACK, rear panel diagram description, 15

SYNC, song other setup, 84

SYNTH SETUP, see synthesizer setup

SYNTHESIZER SETUP, accessing synthesizer setup, 145, controller, 145, master tune, 145, utility mode, 145, velocity curve, 145, velocity, 145

SYSTEM, system architecture, 22, system logic, 17, system overview diagram, 18

SYSTEM EFFECT, description, 29, drum voice send level, 127, drum voice system effect send level, 126, feature reference, 79, mixer system effect sends, 77, multi diagram, 28, normal voice send level, 119, system effect parameter select, 78, system effect type select, 77

SYSTEM EFFECT MODULES, diagram and description, 79

SYSTEM EFFECT PARAMETER, description and how to access, 79, how to access, 78

SYSTEM EFFECT SEND LEVEL, drum voice edit mode, 127, drum voice key parameter, 126, normal voice edit mode, 119

SYSTEM EFFECT SENDS, mixer, 77, song multi screen, 36

SYSTEM EFFECT TYPE, description and how to access, 79, how to access, 77

SYSTEM EXCLUSIVE, insert system exclusive data, 94

SYSTEM LOGIC, 17

SYSTEM OVERVIEW, diagram, 18

T

- TEMPLATE, element amplitude template type, 113, filter template type, 116, LFO template type, 121, pitch template type, 117
- TEMPLATE TYPE, element amplitude edit, 113, filter, 116, LFO, 121, pitch, 117
- TEMPO, changing the tempo, 55, data change tempo track, 93, data insert tempo track, 94, tempo change, 94, tempo select, 80, tempo select, 86
- TEMPO CHANGE, data insert tempo track, 94
- THIN OUT, song job 2, 99
- THRU (THROUGH), filter, 115
- TIME SIGNATURE, description, 80, song record mode, 86
- TONE, filter, 116
- TONE GENERATION, AWM2 tone generation, 30, 104
- TONE GENERATOR, tone generator section, 22
- TOP OF TRACK, sequence/tempo track data change, 92
- TRACK, data entry by track buttons, 41, selecting tracks for playback, 74, selecting tracks, 54, track buttons, 13, track select button, 13
- TRACK BUTTONS, data entry by, 41, front panel diagram description, 13, selecting elements and switching them on and off, 109
- TRACK DATA CHANGE, sequence/tempo track data change, 92
- TRACK DATA INSERT, sequence/tempo track data insert, 93
- TRACK SELECT, instrument track select, 63
- TRACK SELECT BUTTON, front panel diagram description, 13
- TRACK SELECTION, selecting tracks for playback, 74
- TRACK SOLO BUTTON, front panel diagram description, 13
- TRACK TRANSMIT CHANNEL, external on/off, 82, internal on/off, 82, MIDI transmit channel, 82, track number, 82
- TRANSPOSE, song job 3, 102, song other setup, 84
- TROUBLESHOOTING, appendix, 153
- TUNE, drum voice key parameter, 126, how to access, 78, master tune, 78, normal voice edit mode, 118, pitch, 118, song multi screen, 37
- TUTORIAL, getting started, 43
- TYPE, drum voice insertion effect type, 127, element amplitude template type, 113, file types, 132, filter template type, 116, LFO template type, 121, normal voice insertion effect type, 119, pitch template type, 117, selecting a file type, 132

U

- UNDO, song job undo/redo, 95
- UTILITY MODE, controllers, 147, entering and exiting utility mode, 142, feature reference, 142, greeting message, 149, internal voice bank initialize, 144, MIDI setup, 148, moving around in utility mode, 142, operating modes description, 21, other setup, 149, song voice memory, 143, synthesizer setup, 145

V

- VELOCITY, description of keyboard velocity sensitivity control, 51, element pitch sensitivity, 118, filter velocity band sensitivity, 116, filter velocity sensitivity, 116, key velocity description, 31, normal voice element velocity limit, 112, step recording, 90, synthesizer setup, 145
- VELOCITY BAND SENSITIVITY, filter, 116
- VELOCITY CURVE, synthesizer setup, 145
- VELOCITY LIMIT, normal voice element parameter, 112
- VELOCITY SENSITIVITY, amplitude level parameter, 113, description of keyboard velocity sensitivity control, 51, element pitch sensitivity, 118, filter, 116, step recording, 90
- VOICE, difference between a normal voice and a drum voice, 58, drum voice category common parameter, 125, element diagram, 30, exploring the preset voices, 45, how to select a voice, 46, load from disk, 138, normal and drum voice mixer channel diagram, 24, normal voice category common parameter, 110, normal voices and drum voices, 106, recalling the factory set internal voices, 144, reloading the factory set voice data, 66, song voice memory description, 38, store voice, 39, store voice, 130, storing a voice, 108, system effect voice send level setting, 77, system effect voice send level, 80, voice banks description and type list, 25, voice bulk dump, 144, voice categories, 27, voice control, 105, voice edit mode, 108, voice mode, 106, voice pitch bend range setting, 78, voice play mode, 107, voice select, 36, voice select, 76, voice volume, 36, volume, 77
- VOICE BANK, chart of list and description of each, 49, description and type list, 25, how to select, 48, how to select, 78, reloading the factory set voice data, 66
- VOICE BANK SELECT, song multi screen, 37
- VOICE BULK DUMP, utility mode, 144
- VOICE CATEGORY, definition and type list, 27, diagram, 47, drum voice common parameter, 125, normal voice common parameter, 110
- VOICE CONTROL, ways to control a voice, 105
- VOICE DATA, reloading the factory set voice data, 66
- VOICE DIRECTORY, how to access, 78, song multi screen, 37
- VOICE EDIT BUTTON, front panel diagram description, 13
- VOICE EDIT MODE, accessing filter parameters, 116, accessing normal voice edit parameters, 109, amplitude, 113, drum voice controller, 128, drum voice edit mode, 124, drum voice effect, 127, element note shift, 118, feature reference, 108, filter envelope generator, 116, filter, 115, LFO, 121, normal voice controller, 122, normal voice edit mode, 109, normal voice effect, 119, operating modes description, 20, pitch, 117
- VOICE EDIT/COMPARE, 108
- VOICE EDITING, accessing drum voice edit parameters, 124, accessing normal voice edit parameters, 109, drum voice edit mode, 124, normal voice edit mode, 109, overview, 33, steps in editing a voice, 58
- VOICE MODE, feature reference, 106, operating modes description, 20
- VOICE NAME, drum voice common parameter, 125, normal voice common parameter, 110
- VOICE PAN, song multi screen, 36

VOICE PLAY MODE, accessing voice play functions, 107, entering and exiting voice play mode, 107, feature reference, 107, operating modes description, 20

VOICE SELECT, song multi screen, 36

VOICE SEND LEVEL, how to access, 80

VOICE VOLUME, song multi screen, 36

VOLUME, drum voice common parameter, 125, drum voice key volume level, 126, foot volume control, 50, master volume, 77, normal voice common parameter, 110, selecting and adjusting voice volume, 54, voice volume, 77

VOLUME LEVEL, drum voice key parameter, 126

VOLUME SLIDER, front panel diagram description, 12



CANADA

THIS DIGITAL APPARATUS DOES NOT EXCEED THE "CLASS B" LIMITS FOR RADIO NOISE EMISSIONS FROM DIGITAL APPARATUS SET OUT IN THE RADIO INTERFERENCE REGULATION OF THE CANADIAN DEPARTMENT OF COMMUNICATIONS.

- This applies only to products distributed by Yamaha Canada Music LTD.

LE PRESENT APPAREIL NUMERIQUE N'EMET PAS DE BRUITS RADIOELECTRIQUES DEPASSANT LES LIMITES APPLICABLES AUX APPAREILS NUMERIQUES DE LA "CLASSE B" PRESCRITES DANS LE REGLEMENT SUR LE BROUILLAGE RADIOELECTRIQUE EDICTE PAR LE MINISTERE DES COMMUNICATIONS DU CANADA.

- Ceci ne s'applique qu'aux produits distribués par Yamaha Canada Music LTD.

FCC INFORMATION (U.S.A)

1. IMPORTANT NOTICE: DO NOT MODIFY THIS UNIT!

This product, when installed as indicated in the instructions contained in this manual, meets FCC requirements. Modifications not expressly approved by Yamaha may void your authority, granted by the FCC, to use the product.

2. IMPORTANT: When connecting this product to accessories and/or another product use only high quality shielded cables.

Cable/s supplied with this product MUST be used. Follow all installation instructions. Failure to follow instructions could void your FCC authorization to use this product in the USA.

3. NOTE: This product has been tested and found to comply with the requirements listed in FCC Regulations, Part 15 for Class "B" digital devices. Compliance with these requirements provides a reasonable level of assurance that your use of this product in a residential environment will not result in harmful interference with other electronic devices. This equipment generates/uses radio frequencies and, if not installed and used according to the instructions found in the user's manual, may cause interference harmful to the operation of other electronic devices. Compliance with FCC regulations does not guarantee that interference will not occur in all installations. If this product is found to be the source of interference, which can be determined by turning the unit "OFF" and "ON", please try to eliminate the problem by using one of the following measures :

Relocate either this product or the device that is being affected by the interference.

Utilize power outlets that are on different branch (circuit breaker or fuse) circuits or install AC line filter/s.

In the case of radio or TV interference, relocate/reorient the antenna.

If the antenna lead-in is 300 ohm ribbon lead, change the lead-in to co-axial type cable.

If these corrective measures do not produce satisfactory results, please contact the your local retailer authorized to distribute this type of product. If you can not locate the appropriate retailer, please contact Yamaha Corporation of America, Electronic Service Division, 6600 Orangethorpe Ave, Buena Park, CA 90620

The above statements apply ONLY to those products distributed by Yamaha Corporation of America or its subsidiaries.

Litiumbatteri!

Bör endast bytas av servicepersonal.
Explosionsfara vid felaktig hantering.

VAROITUS!

Lithiumparisto, Räjähdyksvaara.
Pariston saa vaihtaa ainoastaan alan ammattimies.

ADVARSEL!

Lithiumbatteri!
Eksplosionsfare. Udsigtning må kun foretages af en sagkyndig, - og som beskrevet i servicemanualen.

Wichtiger Hinweis für die Benutzung in der Bundesrepublik Deutschland.

Bescheinigung des Importeurs

Hiermit wird bescheinigt, daß der/die/das

Gerät: Synthesizer Typ: W5
(Gerät, typ, Bezeichnung)

in Übereinstimmung mit den Bestimmungen der

VERFÜGUNG 1046/84
(Amtsblattverfügung)

funkentstört ist.

Der Deutschen Bundespost wurde das Inverkehrbringen dieses Gerätes angezeigt und die Berechtigung zur Überprüfung der Serie auf Einhaltung der Bestimmungen eingeräumt.

Yamaha Europa GmbH
(Name des Importeurs)

*Dies bezieht sich nur auf die von der Yamaha Europa GmbH Vertriebenen Produkte.

Wichtiger Hinweis für die Benutzung in der Bundesrepublik Deutschland.

Bescheinigung des Importeurs

Hiermit wird bescheinigt, daß der/die/das

Gerät: Synthesizer Typ: W7
(Gerät, typ, Bezeichnung)

in Übereinstimmung mit den Bestimmungen der

VERFÜGUNG 1046/84
(Amtsblattverfügung)

funkentstört ist.

Der Deutschen Bundespost wurde das Inverkehrbringen dieses Gerätes angezeigt und die Berechtigung zur Überprüfung der Serie auf Einhaltung der Bestimmungen eingeräumt.

Yamaha Europa GmbH
(Name des Importeurs)

*Dies bezieht sich nur auf die von der Yamaha Europa GmbH Vertriebenen Produkte.

Dit produkt is gefabriceerd in overeenstemming met de radiostoringsvoorschriften van de Richtlijn van de Raad(82/499/EEG).

ΑΥΤΗ Η ΣΥΣΚΕΥΗ ΑΝΤΑΠΟΚΡΙΝΕΤΑΙ ΣΤΙΣ ΑΠΑΙΤΗΣΕΙΣ ΤΩΝ ΟΔΗΓΙΩΝ ΤΗΣ ΕΥΡΩΠΑΙΚΗΣ ΟΙΚΟΝΟΜΙΚΗΣ ΚΟΙΝΟΤΗΤΑΣ 82/499/Ε.Ο.Κ..

Este produto está de acordo com o radio de interferencia frequente requeridos do Conselho Diretivo 82/499/EEC.

Dette apparat overholder det gældende EF-direktiv vedrørende radiostøj.

Cet appareil est conforme aux prescriptions de la directive communautaire 87/308/CEE.

Diese Geräte entsprechen der EG-Richtlinie 82/499/EWG und/oder 87/308/EWG.

This product complies with the radio frequency interference requirements of the Council Directive 82/499/EEC and/or 87/308/EEC.

Questo apparecchio é conforme al D.M.13 aprile 1989 (Direttiva CEE/87/308) sulla soppressione dei radiodisturbi.

Este producto está de acuerdo con los requisitos sobre interferencias de radio frecuencia fijados por el Consejo Directivo 87/308/CEE.

YAMAHA CORPORATION

IMPORTANT NOTICE FOR THE UNITED KINGDOM

Connecting the plug and Cord

WARNING: THIS APPARATUS MUST BE EARTHED

IMPORTANT: THE WIRES IN THIS MAINS LEAD ARE COLOURED IN ACCORDANCE WITH THE FOLLOWING CODE:

GREEN-AND-YELLOW : EARTH
BLUE : NEUTRAL
BROWN : LIVE

As the colours of the wires in the mains lead of this apparatus may not correspond with the coloured markings identifying the terminals in your plug proceed as follows:

The wire which is coloured GREEN-and-YELLOW must be connected to the terminal in the plug which is marked by the letter E or by the safety earth symbol or colored GREEN or GREEN-and-YELLOW.

The wire which is coloured BLUE must be connected to the terminal which is marked with the letter N or coloured BLACK.

The wire which is coloured BROWN must be connected to the terminal which is marked with the letter L or coloured RED.

Free Manuals Download Website

<http://myh66.com>

<http://usermanuals.us>

<http://www.somanuals.com>

<http://www.4manuals.cc>

<http://www.manual-lib.com>

<http://www.404manual.com>

<http://www.luxmanual.com>

<http://aubethermostatmanual.com>

Golf course search by state

<http://golfingnear.com>

Email search by domain

<http://emailbydomain.com>

Auto manuals search

<http://auto.somanuals.com>

TV manuals search

<http://tv.somanuals.com>