



# OmniView™

## PRO2 Series KVM Switch

User Manual

F1DA104T  
F1DA108T  
F1DA116T

PRO2 Series

# TABLE OF CONTENTS

## Overview

Feature Overview	.2
Equipment Requirements	.3
Operating Systems	.4
Unit Display Diagrams	.5
Specifications	.7

## Installation

Pre-Configuration	.8
Step-by-Step Installation Guide	.9
Single PRO2 Installation	.10
Connecting Multiple PRO2s (Daisy-Chaining)	.12
Powering up the Systems	.16

## Using your PRO2

Selecting a Computer Using Keyboard Hot Key Commands	.17
AutoScan Mode	.18
Selecting a Computer Using Direct-Access Port Selectors	.18
Bank Up and Bank Down Scroll Buttons	.18
On-Screen Display Menu Control	.20

## Belkin KVM Switches and Accessories

OmniView KVM Switches	.23
OmniView All-In-One KVM Cables	.25
OmniView Accessories and Adapters	.26

PRO2 Series FAQs	.27
------------------	-----

Troubleshooting	.30
-----------------	-----

Information	.34
-------------	-----

# OmniView™

## PRO2 Series KVM Switch

Congratulations on your purchase of this Belkin OmniView PRO2 Series KVM Switch (the PRO2). Our diverse

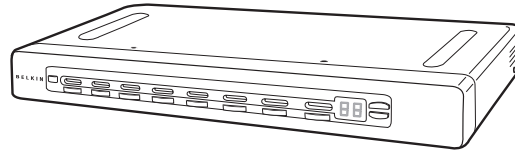

line of KVM solutions exemplifies the Belkin commitment to delivering high-quality, durable products at a reasonable price. Designed to give you control over multiple computers and servers from one console, Belkin PRO2s come in a variety of capacities suitable for all configurations, large or small.

Belkin has designed and developed this PRO2 with the server administrator in mind. The result is a KVM Switch that surpasses any other switch on the market. The PRO2 is engineered to work with the most advanced server room and laboratory environments, offering intuitive port indicators, direct-access port selectors, high video resolution support, and flash upgradeable firmware. The PRO2 also comes with an unparalleled Belkin Five-Year Warranty.

This manual will provide details about your new PRO2, from installation and operation to troubleshooting—in the unlikely event of a problem.

For quick and easy installation, please refer to the Quick Installation Guide included in your PRO2 packaging.

Thank you for purchasing the PRO2. We appreciate your business and have confidence that you will soon see for yourself why over 1 million Belkin OmniView products are being used worldwide.

### **Package Contents**

- OmniView PRO2 Series KVM Switch
- Adjustable Rack-mount Brackets with Screws
- DB25-to-RJ45 Parallel Flash Cable
- User Manual
- Quick Installation Guide
- 12-Volt DC, 1-Amp Power Supply
- Registration Card

## OVERVIEW

The PRO2s allow you to control up to a maximum of 256 computers with one keyboard, monitor, and mouse. They support PS/2 input devices (keyboard and mouse) as well as VGA, SVGA, XGA, and XGA-2 video.

They support both PS/2 and USB output. This enables cross-platform control over PCs and USB-based computers including USB Sun™ workstations and Mac® computers.

### **Feature Overview**

#### **Hot Keys:**

Hot key functionality allows you to select a desired port using designated key commands. By using a simple hot key sequence on your keyboard, selecting one computer from as many as 256 computers is instantaneous. For a listing of complete hot key instructions and commands, see pages 17-19.

#### **AutoScan:**

The AutoScan feature allows you to set your PRO2 to scan and monitor the activities of all operating computers connected to the switch—one by one. The time interval allotted for each computer can be defined or adjusted through the On-Screen Display (OSD) menu. For complete instructions on AutoScan usage, please refer to page 18.

#### **Video Resolution:**

Through a 400MHz bandwidth, the PRO2s support video resolutions of up to 2048x1536@85Hz. To preserve signal integrity at these higher resolutions, your PRO2 requires 75-Ohm coaxial VGA cabling.

#### **Flash Upgrade:**

Flash upgradeable firmware allows you to install the latest firmware for your PRO2. This enables your PRO2 to maintain consistent compatibility with the latest devices and computers. Firmware upgrades are free for the life of your PRO2. Refer to the enclosed flash upgrade instruction document or visit us at [belkin.com](http://belkin.com) for complete upgrade information and support.

#### **On-Screen Display (OSD):**

The OSD feature simplifies server management by allowing you to assign individual names to each connected server throughout the system. It provides a visual means of switching between computers and setting the time interval for the AutoScan function.

## OVERVIEW

### **Front-Panel Push Button:**

Direct-access port selectors, located conveniently on the front panel of the PRO2, allow for simple, manual port-selection. Each button controls a port.

### **LED Display:**

An LED display on the face of the PRO2 serves as a status monitor. An LED next to each direct-access port selector illuminates to indicate that the console currently controls the corresponding computer. As a port selector is pushed, the LED next to it will light up. A flashing port LED indicates that there is no computer connected to that port.

### **Seven-Segment LED Display:**

When daisy-chaining multiple PRO2s together, the seven-segment LED display serves as a quick indicator of the selected BANK.

## **Equipment Requirements**

### **Cables:**

To connect to the PRO2, each PS/2 computer requires one VGA cable, one PS/2 keyboard cable, and one PS/2 mouse cable. Keyboard and mouse cables must have PS/2 male-to-PS/2 male connectors. Each USB computer requires one VGA cable and one USB A-to-B cable.

Video resolution support of up to 2048x1536@85Hz requires use of a 75-Ohm coaxial VGA cable to preserve signal integrity. VGA cables must have HDDB15 female-to-HDDB15 male connectors.

Belkin highly recommends that you use OmniView All-In-One PRO Series Plus or Gold Series Cables. These cables offer the highest quality possible to ensure optimal data transmission. All-In-One Cables are molded together for a clean and organized setup; are double-shielded to reduce EMI/RFI interference; have strain-relief construction for added durability; come with a ferrite bead for noise immunity; and include PC99 color-coded connectors for easy identification and connection. The PRO Series Plus Cables include an industry-standard, 14-pin, coaxial VGA cable and nickel-plated connectors for high-resolution applications. The Gold Series Cables have a custom, 15-pin, coaxial VGA cable and gold-plated connectors for superior clarity, connectivity, and error-free data transmission. OmniView Cables are

# OVERVIEW

available in both USB and PS/2 connector types. The following cables are recommended for your PRO2:

## OmniView All-In-One PRO Series Plus

F3X1105-XX (PS/2 Style)

F3X1962-XX (USB Style)



USB Style

## OmniView All-In-One Gold Series

F3X1835-XX-GLD (PS/2 Style)

F3X1895-XX-GLD (USB Style)



PS/2 Style

(-XX denotes length in feet)

## Operating Systems

---

OmniView PRO2 Series KVM Switches are for use on CPUs using:

### Platforms:

- Windows® 95/98/2000/Me/NT®/XP
- DOS
- Turbolinux® and all Linux® distributions
- Novell® NetWare® 4.x/5.x
- Mac (with USB support)
- Sun (with USB support)

### Keyboards:

- Supports 101-/102-/104-key keyboards

### Mice:

- Microsoft® system-compatible PS/2 or PS/2 & USB combo mice (with PS/2 adapter) having 2, 3, 4, or 5 buttons
- Microsoft system-compatible PS/2 wireless or optical mice

### Monitor:

- VGA
- SVGA
- MultiSync®

# OVERVIEW

## Side View of the PRO2:

---

F1DA108T

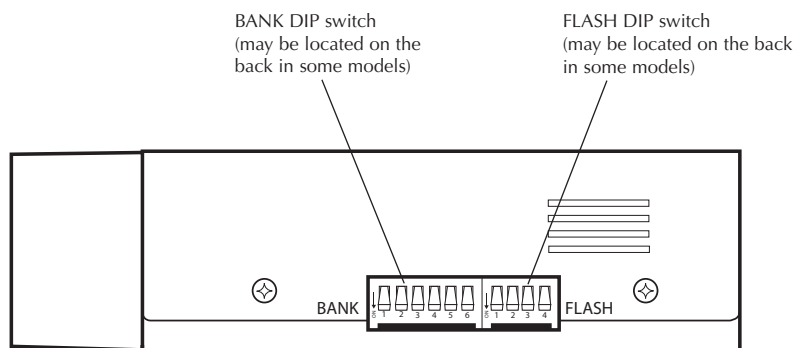

# OVERVIEW

## Front View of the PRO2:

F1DA108T

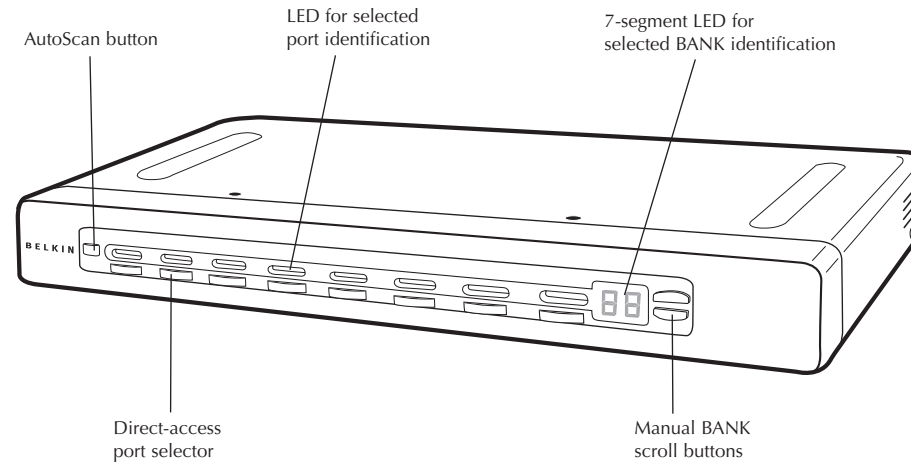

## Back View of the PRO2:

F1DA108T

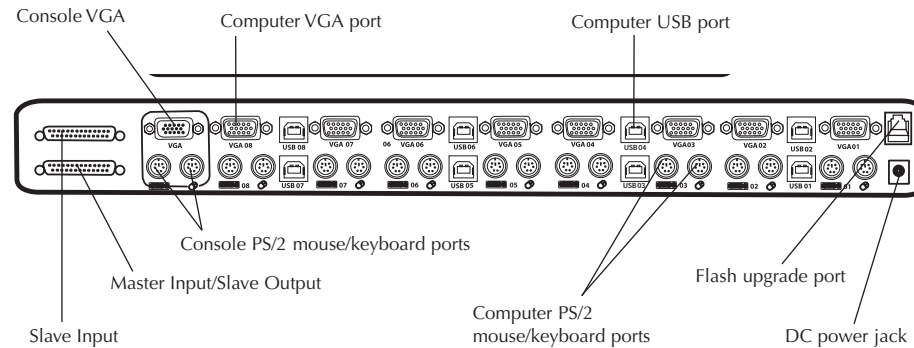



# OVERVIEW

## Specifications

---

**Part No.:** F1DA104T, F1DA108T & F1DA116T

**Power:** 12-Volt DC, 1-Amp power adapter with center-pin positive polarity

**Daisy-Chain:** Maximum of 16 KVM Switches

**Computer Connections Supported:**

4 (F1DA104T)

8 (F1DA108T)

16 (F1DA116T)

**Keyboard Emulation:** PS/2

**Mouse Emulation:** PS/2

**Monitors Supported:** VGA, SVGA, MultiSync, and LCD (optional adapter may be required)

**Max. Resolution:** 2048x1536@85Hz

**Bandwidth:** 400MHz

**Keyboard Input:** 6-pin miniDIN (PS/2)

**Mouse Input:** 6-pin miniDIN (PS/2)

**VGA Port:** 15-pin HDDB type

**Port LED Indicators:** 4 (F1DA104T)

8 (F1DA108T)

16 (F1DA116T)

**Enclosure:** Metal enclosure with high-impact plastic faceplate

**Dimensions:**

(F1DA104T) 11 x 1.75 x 6 inch (279mm x 44.5mm x 150mm)

(F1DA108T) 17.25 x 1.75 x 7.5 inch (438mm x 44.5mm x 190mm)

(F1DA116T) 17.25 x 3.5 x 7.5 inch (438mm x 89mm x 190mm)

**Weight:**

(F1DA104T) 5.3 lbs. (2414.5 grams)

(F1DA108T) 9.2 lbs. (4181.5 grams)

(F1DA116T) 12 lbs. (5472.5 grams)

**Operating Temp.:** 32° to 104° F (0~40° C)

**Storage Temp.:** -4° to 140° F (20~60° C)

**Humidity:** 0-80% RH, non-condensing

**Warranty:** 5 years

*Note: Specifications are subject to change without notice.*

# INSTALLATION

## Pre-Configuration

---

### Where to Place the PRO2:

The enclosure of the PRO2 is designed for standalone or rack-mount configuration. The 8- and 16-port PRO2s are natively rack-mountable in standard 19-inch server racks. Rack-mount hardware is included with these switches for a study rack installation. An optional rack-mount kit (F1D005) is available for use with the 4-Port PRO2.

### Consider the following when deciding where to place the PRO2:

- whether or not you intend to use the direct-access port selectors;
- the lengths of the cables attached to your keyboard, monitor, and mouse;
- the location of your CPUs in relation to your console;
- and the lengths of the cables you use to connect your computers to the PRO2.

### Cable Distance Requirements:

#### For PS/2 computers:

VGA signals transmit best up to 25 feet. Beyond that length, the probability of video degradation increases. For this reason, we recommend that the length of the cables between the PRO2 and the connected computers does not exceed 25 feet.

*Note:*

*If you need your console to reside further than 25 feet from the PRO2, we recommend using the Belkin CAT5 Extender (F1D084) with a standard CAT5 UPT cable. By using this device, you may increase the distance between your PRO2 and your keyboard, mouse, and monitor by as much as 500 feet without risking signal degradation.*

#### For USB computers:

USB signals can be transmitted up to 15 feet between the PRO2 and the CPU. Beyond 15 feet, the probability of signal failure is likely, and this may cause the device to fail.

### Cautions and Warnings:

Avoid placing cables near fluorescent lights, air conditioning equipment, or machines that create electrical noise (e.g., vacuum cleaners).

# INSTALLATION

## Step-by-Step Installation Guide

---

### Cautions and Warnings:

Before attempting to connect anything to the PRO2 or your computer(s), please ensure that everything is powered off. Plugging and unplugging cables while computer(s) are powered on may cause irreversible damage to the computer(s) and/or the PRO2(s). Belkin Components is not responsible for damage caused in this way.

### Installing the PRO2 into a Server Rack:

#### Bracket Installation (F1DA108T and F1DA116T only)

Eight- or 16-Port PRO2s include adjustable mounting brackets ideal for installation in 19-inch racks. The mounting brackets feature three adjustment positions to allow the faceplate of the PRO2 to mount flush to your rack-mounted servers, or to the rack. Please follow these simple steps to achieve the desired adjustment. The 4-Port PRO2 requires an optional mounting kit (F1D005).

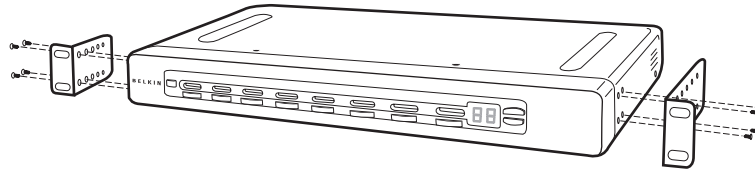

1. Remove the adjustable brackets from the box. (The adjustable brackets allow you to set the PRO2's face flush with the ends of the rails or to extend the PRO2 past the front of the rails).
2. Determine how far you would like the PRO2 to protrude from the rack. Select a bracket-hole scheme.
3. Attach the bracket to the side of your PRO2 using the Phillips screws provided. (Refer to diagram above).
4. Mount the PRO2 to the rack rail assembly.

*Note: If this PRO2 will be daisy-chained to another PRO2, set the BANK address prior to installing on a rack. Refer to the section in this user manual labeled "Connecting Multiple PRO2s (Daisy-Chaining)".*

# INSTALLATION

Your PRO2 is now mounted securely into the bracket and you are ready to connect cables to the back of the unit.

*Note for Belkin PRO Series owners (F1D104-OSD, F1D108-OSD, F1D116-OSD): Installation for the PRO has changed. Please follow this installation manual completely to assure proper installation. Failure to do so may result in keyboard or mouse errors, and/or faulty operation.*

## Single PRO2 Installation

This section provides complete instructions for the hardware setup of a single PRO2. (F1DA104T, F1DA108T, and F1DA116T)

### PS/2 Installation: Keyboard, Video, and Mouse Connections

#### Connect the Console:

1. Connect the monitor to the PRO2. Attach your monitor cable to the HDDB15 female port on the back of the PRO2 labeled "Console VGA".
2. Connect the PS/2 keyboard cable to the keyboard port on the back of the PRO2 in the "Console" section.
3. Connect the PS/2 mouse cable to the mouse port on the back of the PRO2 in the "Console" section.

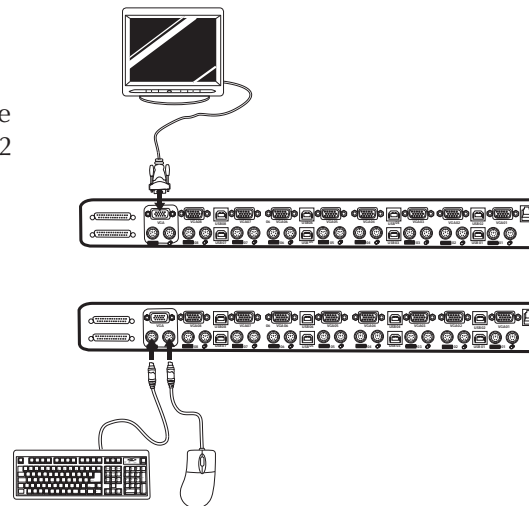

Attach the power supply to the DC power jack labeled "DC 12V, 1A" located on the rear of the PRO2. Once the power is connected to a power source, the LED for port 01 will begin flashing. Sequentially push the direct-access port selectors for ports 01 through 08 (04 for F1DA104T and 16 for F1DA116T). The corresponding LED should flash as each button is pressed, indicating that the port is ready for connecting your servers (computer connection).

# INSTALLATION

## Connect the Computer:

### PS/2 Installation

1. Using an OmniView KVM Cable (Belkin part# F3X1105-XX or F3X1835-XX-GLD), plug in the male VGA connector to the VGA port on the computer. Connect the other end (the female connector) of the VGA cable to the back of the PRO2 labeled "VGA 01".
2. Connect the PS/2 keyboard and PS/2 mouse connectors of the cable to the keyboard and mouse ports on the computer. Connect the other ends of the cables to the keyboard and mouse ports located directly underneath VGA 01 on the PRO2 (Belkin part # F3X1105-XX or F3X1835-XX-GLD).

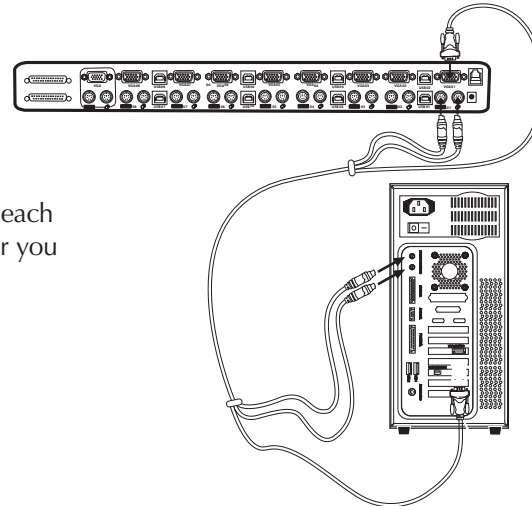

3. Repeat steps 1 and 2 for each additional PS/2 computer you wish to connect.

### USB Installation:

Boot the computer you wish to connect via USB as you would normally with the keyboard, monitor, and mouse connected directly to the computer. After the operating system finishes loading, connect the PRO2 to the USB computer using the USB A-to-B cable that is part of your USB KVM Cable (Belkin part# F3X1962-XX or F3X1895-XX-GLD). Your computer should recognize your PRO2 and automatically install the HID USB driver if necessary. Once your computer finishes installing the USB driver, you can power down your computer to connect it to the PRO2.

# INSTALLATION

1. Using a USB KVM Cable (Belkin part# F3X1962-XX or F3X1895-XX-GLD), plug the male VGA connector into the VGA port on the computer. Connect the other end (the female connector) of the VGA cable to the back of the PRO2 for the appropriate port you wish to connect to (for example, "VGA 02").

2. Connect the USB cable's "A-type"

connector to an available USB port on your USB computer. Connect the other end of the USB cable (with the "B-type" connector) to the corresponding port on the back of the PRO2 (for example, "USB 02").

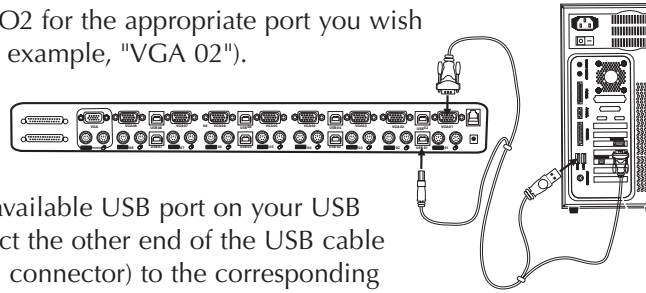

*NOTE: We recommend you attach the KVM cable directly to a free USB port on your computer.*

Repeat steps 1 and 2 above for each additional USB computer you wish to connect.

## Connecting Multiple PRO2s (Daisy-Chaining)

You can daisy-chain up to 16 PRO2s together, giving a server administrator control over a maximum of 256 computers. When daisy-chained together, each unit is referred to as a "BANK" and assigned an address. The Console keyboard, mouse, and monitor connects to BANK 00 and is referred to as the "Master" switch. BANKs 01 through 15 are referred to as "Slave" switches.

*Note: A daisy-chain cable (F1D108-CBL) is required to daisy-chain each PRO2 and is available through your Belkin reseller or online at [belkin.com](http://belkin.com).*

All PRO2s feature a "BANK DIP" switch. The BANK DIP switch is used for proper identification and use of PRO2s in a single-unit or daisy-chain configuration.

- For a single-unit configuration, set the BANK DIP switch on the PRO2 to the "Master" (BANK address 00) setting. This is the factory default setting.
- For multi-unit configuration, the BANK DIP switch on the Master unit must be set to "BANK address 00". Slave units must be set to a unique BANK address (from 01 through 15). Refer to the chart below for BANK DIP switch settings.

# INSTALLATION

## BANK DIP Switch Configuration Chart

DIP SWITCH#						BANK ADDRESS
1	2	3	4	5	6	
ON	ON	ON	ON	ON	ON	BANK 00 MASTER (default)
ON	ON	OFF	ON	ON	ON	BANK 01 SLAVE
ON	ON	ON	OFF	ON	ON	BANK 02 SLAVE
ON	ON	OFF	OFF	ON	ON	BANK 03 SLAVE
ON	ON	ON	ON	OFF	ON	BANK 04 SLAVE
ON	ON	OFF	ON	OFF	ON	BANK 05 SLAVE
ON	ON	ON	OFF	OFF	ON	BANK 06 SLAVE
ON	ON	OFF	OFF	OFF	ON	BANK 07 SLAVE
ON	ON	ON	ON	ON	OFF	BANK 08 SLAVE
ON	ON	OFF	ON	ON	OFF	BANK 09 SLAVE
ON	ON	ON	OFF	ON	OFF	BANK 10 SLAVE
ON	ON	OFF	OFF	ON	OFF	BANK 11 SLAVE
ON	ON	ON	ON	OFF	OFF	BANK 12 SLAVE
ON	ON	OFF	ON	OFF	OFF	BANK 13 SLAVE
ON	ON	ON	OFF	OFF	OFF	BANK 14 SLAVE
ON	ON	OFF	OFF	OFF	OFF	BANK 15 SLAVE

Note: "On" is the down position.

### Example:

Four 8-Port PRO2s (F1DA108T) are daisy-chained together for controlling up to 32 computers. The DIP switch on the Master unit is set to "BANK 00" (factory default) and the Slave units are each set to a unique BANK (between 01 and 15).

# INSTALLATION

## Installation

---

### Before You Begin:

1. Make sure that all computers are powered off and that each PRO2 has been assigned a unique BANK address.
2. Place Master and Slave switches in the desired location. Make sure all are turned off and unplugged from the power source.
3. Connect the Console monitor, keyboard, and mouse to the Console ports of the Master switch or Bank 00, as described previously in this installation guide.

### Connecting the Master Switch to the First Slave Switch:

4. Using the daisy-chain cable (F1D108-CBL), connect one end of the cable to the "Master Input/Slave Output" port on the Master switch (BANK 00).
5. Connect the other end of the daisy-chain cable to the "Master Input/Slave Output" port of the first Slave switch (BANK 01).

### Adding Additional Slave Units:

6. Using the daisy-chain cable (F1D108-CBL), connect one end of the cable to the available daisy-chain port labeled "Slave Input" on the Slave switch (for example, BANK 01).
7. Connect the other end of the daisy-chain cable to the "Master Input/Slave Output" port of the Slave switch that you are adding (for example, BANK 02).
8. Repeat steps 6 and 7 for additional PRO2s you wish to daisy-chain together.



# INSTALLATION

## Example of Daisy-Chain Configuration:

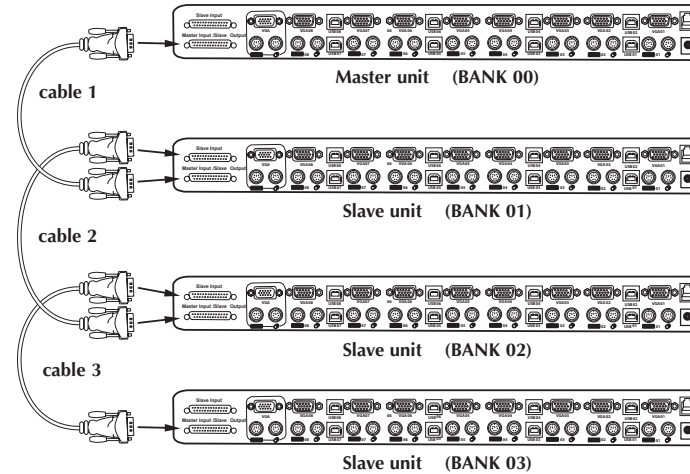

### Connecting the Computers:

9. Connect all computers to the Master and Slave switches. Refer to “Single PRO2 Installation” on page 10 for instruction on how to connect the Console and the computers to the PRO2.
10. Connect the power supply to the Master switch. Power up the Master switch. You should see the Master switch light up and display the digits “00”, indicating its BANK address.
11. Power up the Slave switches sequentially, beginning with Bank 01, by connecting each unit’s power supply. Each switch should display its corresponding BANK address number as it is powered up.

*Note: If the PRO2s do not enumerate correctly, reset the Master switch (BANK 00) by simultaneously pressing the “BANK +” and “BANK -” buttons. You can also reset the Master switch to detect newly added Slave switches. If the switches still do not enumerate correctly, check that all switches have the correct BANK address assigned to them and that all daisy-chain cables are connected properly.*

12. Verify that the Master unit has detected all Slave switches by scrolling through the BANKS using the BANK up and BANK down buttons. If all Slave switches are detected properly, the LED display on the Master switch will register and display the attached Slave switch’s BANK address.

## USING YOUR PRO2

### Powering up the Systems

---

Once all cables have been connected, power up the computers that are attached to the PRO2. All computers can be powered on simultaneously. The PRO2 emulates both a mouse and keyboard on each port and allows your computer to boot normally.

The computer connected to port "1" will be displayed on the monitor. Check to see that the keyboard, monitor, and mouse are working normally. Proceed to do this with all occupied ports to verify that all computers are connected and responding correctly. If you encounter an error, check your cable connections for that computer and reboot. If the problem persists, please refer to the Troubleshooting section in this manual.

### Using Your PRO2:

---

Now that you have connected your Console and computers to your PRO2, it is ready for use.

Select connected computers by either the direct-access port selectors, located on the front panel of the PRO2, using the On-Screen Display, or by using hot key commands through the Console keyboard. It takes approximately 1-2 seconds for the video signal to refresh after switching computers. Re-synchronization of the mouse and keyboard signals also occurs. This is normal operation and ensures that proper synchronization is established between the Console and the connected computers.

## USING YOUR PRO2

### Selecting a Computer Using Keyboard Hot Key Commands:

Switch to the next or previous port with simple keyboard key sequences using the “Scroll Lock” key and either the up or down arrow keys. To send commands to the PRO2, the “Scroll Lock” key must be pressed twice within two seconds. The PRO2 will beep, confirming that it is in hot key mode. Next, press the up or down arrow keys, and the PRO2 will switch to either the prior port or the next port.

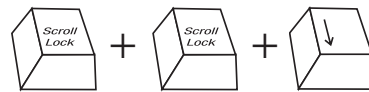

Switch to next active port—Down arrow

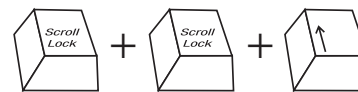

Switch to previous active port—Up arrow

With a single-switch configuration (no daisy-chained switches), you can switch directly to any port by entering the two-digit number of the port you wish to access. For example, if you press “Scroll Lock”, “Scroll Lock”, “02”, the PRO2 will switch to the computer on port 2 located on BANK 00.

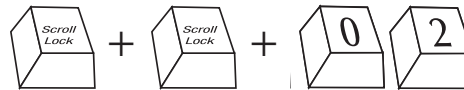

Switch to BANK 00, Port 2—(02)

*Note: You will have approximately five seconds to complete each hot key sequence.*

With daisy-chain switch configuration, you can switch between BANKs by pressing “Scroll Lock”, “Scroll Lock”, “Page Up”, to switch to the previous BANK. Press “Scroll Lock”, “Scroll Lock”, “Page Down”, to switch to the next BANK.

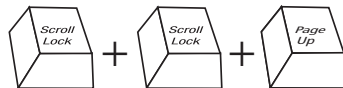

Switch to previous BANK—Page Up

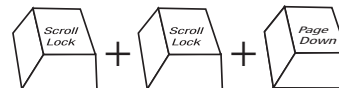

Switch to next BANK—Page Down

## USING YOUR KVM SWITCH

With a daisy-chain switch configuration, you can switch directly to any port on any BANK by pressing “Scroll Lock”, “Scroll Lock”, BANK address, and port number. For example, if you press “Scroll Lock”, “Scroll Lock”, “03”, “05”, the computer on BANK 03, Port 5 will become active.

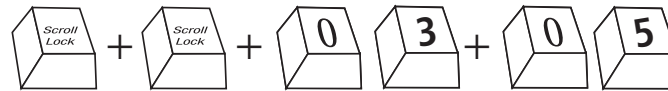

### AutoScan Mode:

---

Pressing the AutoScan button on the PRO2 will activate the AutoScan function. In AutoScan mode, the PRO2 remains on one port for a pre-set number of seconds, before switching to the next computer. This time interval can be adjusted via the On-Screen Display menu.

*Note: There is no mouse or keyboard control in AutoScan mode. This is necessary to prevent data and synchronization errors. If the user is using the mouse or keyboard when the PRO2 is switching between ports, data flow may become interrupted and could result in erratic mouse movement and/or wrong-character input when using the keyboard.*

Press any button on the front panel or any key on the keyboard to disable AutoScan.

### Selecting a Computer Using Direct-Access Port Selectors:

---

You can directly select which computer you wish to control by pressing the direct-access port selector next to the corresponding port. The LED will illuminate to indicate the port is currently selected. If you are installing multiple PRO2s that are daisy-chained, use the BANK scroll keys located on the front panel of the Master switch to access other computers that are connected to the Slave switches.

### BANK Up and BANK Down Scroll Buttons:

Pressing the BANK + and BANK – scroll buttons on the Master switch will allow you to switch between the daisy-chained PRO2s. Pressing both buttons simultaneously will reset the PRO2.

The BANK + button will take you to the next BANK. For example, when you are at the Master switch (BANK 00) and want to check computers on BANK 02, pressing the BANK + button will take you to BANK 02. As a default, the

## USING YOUR PRO2

first active computer will be displayed on the Console monitor. Use the direct-access port selectors to go to the desired computer on BANK 02.

The “BANK –” button will take you to the previous BANK. For example, when you are at BANK 02 and want to check computers in BANK 01. Pressing the “BANK –” button will take you to BANK 01. As default, the first active computer will be displayed on the Console monitor. Use the direct-access port selectors to go to the desired computer on BANK 01.

### Keyboard Hot Key Commands:

Conveniently command the PRO2 to switch ports through simple keyboard key sequences. To send commands to the PRO2, the “Scroll Lock” key must be pressed twice within two seconds. You will hear a beep for confirmation. Below is a complete list of hot key commands:

*Note: you will have approximately five seconds to complete each hot key sequence.*

SL	SL	Up Arrow	Switch to PREVIOUS ACTIVE port
SL	SL	Down Arrow	Switch to NEXT ACTIVE port
SL	SL	Page Up	Switch to PREVIOUS BANK (By default, selects first active port on the BANK)
SL	SL	Page Down	Switch to NEXT BANK (By default, selects first active port on the BANK)
SL	SL	Y	Directly switches to PORT Y on BANK 00 (Single-Switch Configuration) Y=01 to 16
SL	SL	X Y	Directly switches to PORT Y on BANK X (Daisy-Chain Configuration) (X=00 to 15) (Y=01 to 04 for F1DA104T) (X=00 to 15) (Y=01 to 08 for F1DA108T) (X=00 to 15) (Y=01 to 16 for F1DA116T)
SL	SL	Delete	Reset On-Screen Display menu
SL	SL	S	Disable sound in AutoScan mode
SL	SL	Space Bar	Activate On-Screen Display
SL	SL	A	Enable AutoScan mode (Refer to AutoScan button)

# USING YOUR PRO2

## On-Screen Display Menu Control:

To access the On-Screen Display (OSD) menu, press “Scroll Lock”, “Scroll Lock”, and the space bar. Immediately, the OSD overlay screen will appear. The superimposed menu screen is generated by the PRO2, and does not affect your computers or software function in any way.

The main OSD menu is shown below. It displays the current selected BANK. If you have only one PRO2, it will display “BANK 00”.



Main Menu



Setup Menu

A “\*” symbol indicates that the computer is powered.

If a computer is connected and is powered up, but the OSD menu does not display a \* symbol, you will have to reset the PRO2 to re-detect the powered computer. This is done by simultaneously pressing the “BANK +” and “BANK -” buttons on the front panel.

(↑↓): SELECT: Navigate to different computers in the same BANK.

(PGUP/DN): BANK: Select previous BANK by pressing the “Page Up” key and next BANK by pressing the “Page Down” key.

(Insert): RENAME: Name each computer (up to 15 characters).

(ENTER): SAVE: Save the content input.

(TAB): SETUP: Open “Setup” menu.

(ESC): EXIT: Exit the On-Screen Display.

## USING YOUR PRO2

### **AutoScan Time:**

Specifies the amount of time the PRO2 remains on a port before switching to the next port while in AutoScan mode. You may select different time intervals—7, 15, 30, or 60 seconds. Use the OSD to set the AutoScan time interval.

### **OSD Display Time:**

Specifies the amount of time the OSD menu is displayed. Also specifies the amount of time the “Port Identification” tag displays on-screen after making a port selection. You may choose 7, 15, 30, or 60 seconds.

For both settings, you may use the arrow keys to navigate. After you have selected the desired time intervals, push “Enter” key to save the entry.

Press the “ESC” key to go back to the original OSD menu screen.

Press the “ESC” key again to exit the On-Screen Display completely.

Once you have selected a computer on the menu, press “Enter” to switch to that port.

*Note: If there are Slave units connected, and the AutoScan time and OSD display time settings are set on the Master unit, the settings will also apply to all slave units.*

### **Updating Firmware:**

To update your firmware, download the appropriate firmware file and utility from **belkin.com**. The utility automatically guides you through the process of updating the firmware on your PRO2.

### **Cautions and Warnings:**

We strongly recommend that you update your firmware only if you are currently experiencing mouse and keyboard problems with your PRO2, as reconfiguring software may lead to unexpected operational problems. Please contact Belkin Tech Support if you need assistance.

### **To update the firmware, you will need the following items:**

1. A separate computer running Windows 95, 98, or Me. This computer must not be connected to the CPU ports on the PRO2.
2. An available parallel port on the computer.
3. A custom flash cable (DB25 Male-to-RJ45; included with purchase) that connects between the PRO2 and the computer.
4. Firmware update files available at [belkin.com](http://belkin.com).

## USING YOUR PRO2

### Connecting Computers:

1. Connect a keyboard, monitor, and mouse to the computer you prepared for firmware update. It must run Windows 95, 98, or Me.
2. Connect the power adapter to the PRO2. Be sure that all connected computers are powered off at this moment.
3. Connect the custom flash cable (DB25 Male-to-RJ45; included with purchase). Connect one end of DB25 to your computer's parallel port and the other end of RJ45 to the PRO2 flash upgrade jack.

### Setting the PRO2 into Flash Mode:

The PRO2 has four Flash DIP switches:

DIP Switch				Firmware
1	2	3	4	
ON	OFF	OFF	OFF	Main
OFF	ON	OFF	OFF	OSD
ON	ON	OFF	OFF	Keyboard 1
OFF	OFF	ON	OFF	Mouse 1
ON	OFF	ON	OFF	(F1DA116T Only) Keyboard 2
OFF	ON	ON	OFF	(F1DA116T Only) Mouse 2

The DIP switch should be set to the specified settings when you are attempting to update a particular firmware. For example, set DIP switch 1 to "ON" to flash update the main firmware of the switch.

*Note: F1DA116T requires that you flash update two firmwares for the mouse and keyboard, separately.*

1. Once the above steps have been completed, run the Flash software executable. Make sure that the appropriate Flash DIP switch is set to the "on" position. Only one firmware can be flashed at one time.
2. After the Flash update has been completed unplug the power supply from the PRO2.
3. Set all DIP switches to the Off position.
4. You are now ready to use your PRO2 or continue flashing a different component if necessary.



# BELKIN KVM SWITCHES AND ACCESSORIES

## OmniView KVM Switches

---

**OmniView E Series.** This series of desktop OmniView KVM Switches allows you to control two or four PS/2 computers from one Console and makes switching between computers more convenient. Designed for compatibility with your PS/2 platform, it reduces desktop clutter and provides a simple, reliable solution at a lower price point.

The E Series KVM Switch supports high-quality resolution of up to 2048x1536@85Hz through a 400MHz bandwidth when used with coaxial VGA cabling. This means that Belkin OmniView products offer the highest resolution without compromising the quality of the display. Power for the KVM Switch draws off the keyboard, so that the Switch requires no additional power supply and fewer cables. Standard E Series features include: hot key functionality; keyboard and PS/2 emulations for error-free boot up; and a Belkin Two-Year Warranty.

F1DB102P E Series 2-Port KVM Switch PS/2 Only

F1DB104P E Series 4-Port KVM Switch PS/2 Only

**OmniView SOHO Series with Audio.** This innovative design provides built-in cable management and saves space, while adding a whole new sculpted look to your desktop. The SOHO Series Switches allow you to control two or four PS/2 computers from one Console. You'll enjoy the greatest interface flexibility with PS/2 and USB combination Switches. They offer you expanded compatibility with either interface, or both, along with the additional convenience of manual push-button port selection on the face of the device. Switch between speakers and microphones without having to unplug and re-plug them when switching computers. The flash feature allows users to download firmware updates and ensure compatibility with the latest computers and devices. The enclosure design builds in cable management and the Switches are self-powered, so they require no external power supply and work with fewer cables. High-quality resolution of up to 2048x1536@85Hz is supported through a 400MHz bandwidth by the OmniView SOHO Series with Audio KVM Switch when used with coaxial VGA cabling, offering the highest resolution without compromising the quality of the display. Other standard features found on this unit include: hot key functionality; keyboard and PS/2 emulations for error-free boot up; and a Belkin Five-Year Warranty.

## BELKIN KVM SWITCHES AND ACCESSORIES

F1DS102P SOHO Series 2-Port KVM Switch with Audio PS/2 Only  
F1DS104P SOHO Series 4-Port KVM Switch with Audio PS/2 Only  
F1DS102T SOHO Series 2-Port KVM Switch with Audio PS/2 & USB  
F1DS104T SOHO Series 4-Port KVM Switch with Audio PS/2 & USB

**OmniView PRO2 Series.** The OmniView PRO2 Series KVM Switches deliver reliability, performance, and centralized control necessary for today's enterprise environment. This series of KVM Switches enables you to control multiple platform servers from a single Console. Available in the desktop-style, 4-port, and the 19-inch rack-mountable 8- and 16-port models, the OmniView PRO2 Series KVM Switch expands easily for full control of as many as 256 CPUs through dedicated daisy-chain ports. Video resolutions of up to 1600x1200@65Hz are supported through a 400MHz bandwidth. On-Screen Display allows you to name and select attached servers using an on-screen interface. Switch between ports by using hot key commands or direct-access port selectors. The Omniview PRO2 Series KVM Switches use standard cables for easy installation; include a 12-Volt DC, 1-Amp power supply; and are backed by a Belkin Five-Year Warranty.

F1DA104T PRO2 Series 4-Port KVM Switch PS/2 & USB  
F1DA108T PRO2 Series 8-Port KVM Switch PS/2 & USB  
F1DA116T PRO2 Series 16-Port KVM Switch PS/2 & USB

**OmniView MATRIX2 Series.** The OmniView MATRIX2 Series 2x8- and 2x16-Port KVM Switches enable two administrators to control up eight or 16 PS/2 and USB platform servers, separately or simultaneously. Each user operates a separate console following a different bus path for complete independence from the other console. The OmniView MATRIX2 Series KVM Switch expands easily for full control of as many as 256 computers through dedicated daisy-chain ports and is natively rack-mountable for server room environments. Video resolutions of up to 2048x1536@85Hz are supported through a 400MHz bandwidth. On-Screen Display allows you to name and select attached servers using an on-screen interface. Switch between ports by using hot key commands or direct-access port selectors. The OmniView MATRIX2 Series KVM Switches use standard cables for easy installation; include a 12-Volt DC, 1-Amp power supply; and are backed by a Belkin Five-Year Warranty.

F1DM208T MATRIX2 Series 2x8-Port KVM Switch PS/2 & USB  
F1DM216T MATRIX2 Series 2x16-Port KVM Switch PS/2 & USB

# BELKIN KVM SWITCHES AND ACCESSORIES

## OmniView All-In-One KVM Cables

---

OmniView All-In-One KVM Cables provide you with the quality connections necessary to set up your KVM solution. Each kit provides the proper cables and connectors to complete the installation of a Belkin OmniView KVM Switch.

OmniView All-In-One KVM Cables feature sturdy construction, with strain-relief construction and PVC overmolding to prevent data loss. Use of 20-gauge wire delivers the high-performance cable that users have come to identify with the Belkin name. A ferrite bead reduces electromagnetic and radio frequency interference (EMI/RFI). PC99 color-coded connectors and modified thumbscrews have been added for easier installation.

**Gold Series.** These cables are known for their 24k gold-plated connectors and black Flextec™ jackets, and offer the highest-performance possible. The 24k gold-plated connectors maximize longevity and signal integrity, and offer corrosion resistance. The Gold Series includes a custom 15-pin, coaxial VGA cable to support image clarity for the highest-resolution applications. The Gold Series is available in PS/2 and USB styles.

F3X1835-XX-GLD PS/2 (available in lengths of 6, 10, 15, and 25 feet)  
F3X1895-XX-GLD USB (available in lengths of 6, 10, and 15 feet)

**PRO Series Plus.** The PRO Series Plus Cables are high-performance cables built to exacting standards. They receive and transmit data through nickel-plated connectors. The industry-standard 14-pin, coaxial VGA cabling was designed to support image clarity for high-resolution applications. The gray jacket bends into even the tightest crawl spaces for an excellent fit. The PRO2 Series Plus Cable is available in PS/2- and USB-style cable kits.

F3X1105-XX PS/2 (available in lengths of 6, 10, 15, and 25 feet)  
F3X1962-XX USB (available in lengths of 6, 10, and 15 feet)

(-XX denotes length in feet)

# BELKIN KVM SWITCHES AND ACCESSORIES

## OmniView Accessories and Adapters

---

Belkin KVM technology includes various accessories and adapters to complete your KVM solution. The Adapter Series converts Mac, Sun, or USB keyboards, video, and mouse signals into PS/2 and VGA.

- F1D080—The **OmniView PS/2 Mac Adapter™** converts a Macintosh® computer with a 4-pin ADB™ (Apple® Desktop Bus) and DB15 connector into a PS/2 keyboard, HDB15 VGA monitor, and PS/2 mouse.
- F1D082—The **OmniView PS/2 Sun Adapter™** converts a Sun 8-pin keyboard/mouse and 13W3 video into a PS/2 keyboard, PS/2 mouse, and HDB15 VGA monitor.
- F1D084—The **OmniView CAT5 Extender** enables you to control a PC or KVM Switch up to 500 feet away using standard UTP CAT5 cabling.
- F1D087—The **OmniView Keyboard Extender** allows you to extend your keyboard up to 250 feet away.
- F1D088—The **OmniView VGA Monitor Extender** bridges up to 250 feet of distance between your PC and monitor.
- F1D089—The **OmniView Keyboard Splitter** allows you to work with two kinds of PS/2 keyboards and pointing devices without swapping cables or rebooting the computer.
- F1D090—The **OmniView Mouse Splitter** allows you to work with two kinds of PS/2 mice or trackballs without swapping cables or rebooting the computer.
- F1D201—The **OmniView 2-Port Reverse KVM Switch** gives two users central control of one PC from two sets of keyboards, monitors, and mice.
- F2N017—The **OmniView PRO2 Series AT-to-PS/2 Keyboard Adapter** allows you to connect a keyboard with an AT-style connector to a computer with a PS/2-style connector.

## PRO2 SERIES FAQs

**Q:** What operating systems does the PRO2 support?

**A:** The PRO2 will support any operating system that runs on a PS/2 and USB platform. It will also work with non-USB Sun and Mac operating systems using the appropriate adapters (OmniView PS/2 Sun Adapter [F1D082], OmniView PS/2 Mac Adapter [F1D080]). Operating systems include, but are not limited to, DOS, Windows 95/98/2000/Me/NT/XP, Linux, and Mac OS.

**Q:** What does flash upgradeable mean?

**A:** With flash upgrade capability, you can update your PRO2 firmware at any time through a simple parallel connection. Internet upgrade capability ensures that your PRO2 is always the most current version on the market with the latest features and enhancements. See the section on firmware updates in this manual (page 21) and when to use them.

**Q:** Does the PRO2 support Microsoft IntelliMouse®?

**A:** The PRO2 supports mice from Microsoft, Logitech®, Kensington®, etc., and Belkin. Please contact Belkin Technical Support for compatibility issues you may experience.

**Q:** How does the PRO2 allow the user to switch between ports?

**A:** The PRO2 supports three methods of port selection. The user can select computers using specially designated keyboard hot keys, through On-Screen Display, or can independently access the desired port by pushing the direct-access port selectors.

## PRO2 SERIES FAQs

**Q:** How far can the computer be from the PRO2?

**A:** When using PS/2 connections, the PRO2 can be up to 25 feet away from your computer. If your computer needs to be more than 25 feet (7.5 meters) from the PRO2, you can use the Belkin CAT5 Extender to extend your PS/2 keyboard, PS/2 mouse, and monitor up to 500 feet away using a standard CAT5 UTP cable. When using USB connection between your PRO2 and computer, we recommend that your computer be no more than 15 feet (5 meters) from the PRO2.

**Q:** What is the maximum video resolution that the PRO2 supports?

**A:** The advanced video circuit in the PRO2 supports a maximum resolution of 2048x1536@85Hz.

**Q:** What video bandwidth does the PRO2 support?

**A:** The PRO2 supports 400MHz of video bandwidth.

**Q:** Can PS/2 and USB connections be used simultaneously on the same port?

**A:** No. You must use one or the other for each CPU's dedicated port on the PRO2.

**Q:** Do I have to install any software to use the PRO2?

**A:** No, the PRO2 does not require any drivers or software to be installed in your computers. Simply connect all your computers to the PC ports on the PRO2, then attach one keyboard, monitor, and mouse to the Console port and it is ready for use.

## PRO2 SERIES FAQs

**Q:** Does the PRO2 require an AC adapter?

**A:** Yes, the PRO2 requires a 12-Volt DC, 1-Amp power adapter in order to function properly.

**Q:** Can I use the PRO2 to switch video signals only?

**A:** Yes, you may use the PRO2 to switch between video signals only without having to connect the keyboard and mouse. The keyboard and mouse should be connected directly to the computer that the video signal is taken from to ensure that your computer functions properly.

**Q:** Can I use the PRO2 on my Sun computer that supports USB?

**A:** Yes, the PRO2 works with any USB-capable computer.

**Q:** Does the PRO2 support Linux?

**A:** Yes, the PRO2 works with all Linux kernels configured for USB support.

**Q:** How long is the warranty for the PRO2?

**A:** The PRO2 comes with a five-year limited warranty.

# TROUBLESHOOTING

## General

*My computer does not boot when connected to the PRO2 but works fine when I connect the keyboard, video, and mouse directly to the computer.*

- Make sure that the keyboard and mouse cables are connected tightly between the PRO2 and the computer.
- Check that the keyboard and mouse cables are not crossed.

## Video

*I am getting ghosting, shadowing, or fuzzy images on my monitor.*

- Check that all video cables are inserted properly.
- Check that the monitor you are using supports the resolution and refresh-rate setting on your computer.
- Check that the graphics card you are using supports the resolution and refresh-rate setting on your computer.
- Connect the monitor directly into the computer you are having trouble with to see if the problem still appears.

*I am getting a black screen on my monitor.*

- Check that all video cables are inserted properly.
- If you are not using a power adapter, check that the keyboard cable is connected and inserted properly between the computer and PRO2 for the appropriate port.
- If you are using the PRO2 only for video switching and have no keyboard and mouse connection between the PRO2 and PC, you will need to purchase the optional 9V DC, 600mA power adapter (F1D065-PWR for your appropriate country).
- Connect your monitor directly to the computer to verify that your monitor is functioning properly.



# TROUBLESHOOTING

## Keyboard

***The computer does not detect a keyboard and I get a keyboard error reported at boot up.***

- Check that the keyboard cable between the PRO2 and the computer is completely connected. Tighten any loose connections.
- Try using a different keyboard.
- Try connecting the computer to a different port.
- If you are using the keyboard software that was included with your keyboard, uninstall it and then reinstall the standard Microsoft keyboard driver.

## Mouse

***The mouse is lost when I switch to a different port.***

- Check that the mouse you are using is connected properly to the Console of the PRO2.
- If you are using a mouse driver that was included with your mouse, uninstall it and install the standard Microsoft mouse driver.
- Disconnect and reconnect the mouse cable attached to the channel with which you are experiencing problems to re-synchronize the mouse connection.
- Make sure the mouse works when directly plugged into the computer.
- If the computer is coming out of standby mode, allow up to one minute to regain mouse function.
- De-activate power-management schemes on the PC with which you are experiencing problems.
- Try a different mouse.

## TROUBLESHOOTING

### ***The mouse is not detected at boot-up.***

- Check the cables and make sure that they are inserted correctly.

### ***The computer boots up, but the mouse does not work.***

- Make sure the mouse is plugged in properly.
- Make sure the mouse works when directly plugged into the computer. Rebooting may be necessary when trying this.
- Try a different mouse.

### ***When I switch from one port to another, mouse movement is completely erratic.***

- Make sure you do not have more than one mouse driver installed. Make sure that the driver is either for a standard PS/2 mouse or a Microsoft computer-compatible PS/2 mouse.
- Make sure you do not have any mouse drivers loaded in your CONFIG.SYS or AUTOEXEC.BAT files.
- Avoid moving the mouse or pressing the mouse button when switching ports on the PRO2.
- You can reset the mouse and resume proper mouse movement simply by unplugging the mouse from the front of the PRO2 for about 2-3 seconds, and then plugging it in again.

## TROUBLESHOOTING

### USB

***I am connecting my computer to the USB PRO2 via USB and my keyboard and mouse do not work.***

- Prior to connecting the USB PRO2, make sure that the HID USB driver is installed on each computer. (To install the HID USB driver, connect a USB mouse and USB keyboard to the computer. A Windows operating system should automatically install the drivers.)

***Some of the keys on my keyboard are not functioning properly when I use a Mac computer.***

- Because you are using a PC keyboard on a Mac system, a few of the option keys on your PC keyboard may be reversed. All major keys will function as labeled.

# WARRANTY, FCC, CE, ICES STATEMENT

## FCC Statement

### DECLARATION OF CONFORMITY WITH FCC RULES FOR ELECTROMAGNETIC COMPATIBILITY

We, Belkin Components, of 501 West Walnut Street, Compton CA 90220, declare under our sole responsibility that the products:

**F1DA104T, F1DA108T, F1DA116T**

to which this declaration relates:

Comply with Part 15 of the FCC Rules. Operation is subject to the following two conditions: (1) this device may not cause harmful interference, and (2) this device must accept any interference received, including interference that may cause undesired operation.

## CE Declaration of Conformity

We, Belkin Components, declare under our sole responsibility that the F1DA104T, F1DA108T, and F1DA116T to which this declaration relates, are in conformity with Emissions Standard EN55022 and with Immunity Standard EN55024, LVP EN61000-3-2, and EN61000-3-3.

## ICES

This Class B digital apparatus complies with Canadian ICES-003. Cet appareil numérique de la classe B est conforme à la norme NMB-003 du Canada.

## Belkin Components Limited Five-Year Product Warranty

Belkin Components warrants this product against defects in materials and workmanship for its warranty period. If a defect is discovered, Belkin will, at its option, repair or replace the product at no charge provided it is returned during the warranty period, with transportation charges prepaid, to the authorized Belkin dealer from whom you purchased the product. Proof of purchase may be required. This warranty does not apply if the product has been damaged by accident, abuse, misuse, or misapplication; if the product has been modified without the written permission of Belkin; or if any Belkin serial number has been removed or defaced.

THE WARRANTY AND REMEDIES SET FORTH ABOVE ARE EXCLUSIVE IN LIEU OF ALL OTHERS, WHETHER ORAL OR WRITTEN, EXPRESSED OR IMPLIED. BELKIN SPECIFICALLY DISCLAIMS ANY AND ALL IMPLIED WARRANTIES, INCLUDING, WITHOUT LIMITATION, WARRANTIES OF MERCHANTABILITY AND FITNESS FOR A PARTICULAR PURPOSE.

No Belkin dealer, agent, or employee is authorized to make any modification, extension, or addition to this warranty.

BELKIN IS NOT RESPONSIBLE FOR SPECIAL, INCIDENTAL, OR CONSEQUENTIAL DAMAGES RESULTING FROM ANY BREACH OF WARRANTY, OR UNDER ANY OTHER LEGAL THEORY, INCLUDING BUT NOT LIMITED TO, LOST PROFITS, DOWNTIME, GOODWILL, DAMAGE TO OR REPROGRAMMING, OR REPRODUCING ANY PROGRAM OR DATA STORED IN OR USED WITH BELKIN PRODUCTS.

Some states do not allow the exclusion or limitation of incidental or consequential damages or exclusions of implied warranties, so the above limitations of exclusions may not apply to you. This warranty gives you specific legal rights, and you may also have other rights that vary from state to state.



belkin.com

**Belkin Components**

501 West Walnut Street  
Compton • CA • 90220 • USA  
Tel: 310.898.1100  
Fax: 310.898.1111

**Belkin Components, Ltd.**

Unit 13 • Gatelodge Close • Round Spinney  
Northampton • Northants • NN3 8RX • United Kingdom  
Tel: +44 (0) 1604678300  
Fax: +44 (0) 1604678330

**Belkin Components B.V.**

Starparc Building • Boeing Avenue 333  
1119 PH Schiphol-Rijk • The Netherlands  
Tel: +31 (0) 20 654 7300  
Fax: +31 (0) 20 654 7349

**Belkin Components, Ltd.**

7 Bowen Crescent • West Gosford  
NSW 2250 • Australia  
Tel: +61 (2) 4372 8600  
Fax: +61 (2) 4325 4277

P73782-A

© 2002 Belkin Components. All rights reserved. All trade names are registered trademarks of respective manufacturers listed. Apple, Mac, and Macintosh are trademarks of Apple Computer, Inc., registered in the U.S. and other countries.

## Free Manuals Download Website

<http://myh66.com>

<http://usermanuals.us>

<http://www.somanuals.com>

<http://www.4manuals.cc>

<http://www.manual-lib.com>

<http://www.404manual.com>

<http://www.luxmanual.com>

<http://aubethermostatmanual.com>

Golf course search by state

<http://golfingnear.com>

Email search by domain

<http://emailbydomain.com>

Auto manuals search

<http://auto.somanuals.com>

TV manuals search

<http://tv.somanuals.com>