

# Panasonic

DECT Portable Station

## Operating Instructions

Model No. KX-TCA256



**Thank you for purchasing the Panasonic KX-TCA256, DECT Portable Station. Please read this manual carefully before using this product and save this manual for future use.**

This manual is designed to be used with the KX-TCA256 DECT Portable Station and a Panasonic KX-TDA series/KX-TD816/KX-TD1232 Business Telephone System.

**Please use only a Panasonic battery and charge the battery for more than 5.5 hours before initial use.**

# ***Table of Contents***

---

<b>Before Initial Use</b> .....	<b>4</b>
<b>Before Operating the PS</b> .....	<b>5</b>
Location of Controls .....	5
Connection .....	6
Battery Installation.....	7
Battery Charge .....	7
Power On/Off .....	8
Display Icons.....	8
Operation Outline .....	9
Function Menu Display.....	10
PBX Feature Menu.....	11
Flexible Key Display.....	12
Soft Key Display .....	13
Ringer Volume Adjustment .....	14
Receiver/Speaker Volume Adjustment .....	14
Key Lock .....	15
Selecting the Display Language.....	15
<b>Making Calls</b> .....	<b>16</b>
Calling Another Extension.....	16
Calling an Outside Party .....	16
Hot Key Dial .....	17
Using the Call Log.....	17
Using the Phonebook.....	19
<b>Receiving Calls</b> .....	<b>21</b>
Intercom Calls/Outside Calls/Group Calls .....	21
Temporary Ringer Volume Adjustment .....	21
Caller ID .....	22
<b>During a Conversation</b> .....	<b>23</b>
Transferring a Call.....	23
Holding .....	23
Hands-free Conversation .....	25
Turning the Microphone On/Off.....	25
<b>Using the Phonebook</b> .....	<b>26</b>
Handset Phonebook.....	26
Storing an item in the Handset Phonebook.....	28
Hot Key Dial .....	30
Entering Characters .....	31
<b>Feature List</b> .....	<b>33</b>
<b>Programming</b> .....	<b>37</b>
Changing the Initial Settings .....	37
<b>Others</b> .....	<b>45</b>

# *Table of Contents*

---

Walkie-Talkie.....	45
Using the Belt Clip.....	47
Wall Mounting .....	47
<b>Troubleshooting .....</b>	<b>48</b>
Troubleshooting .....	48
<b>Important Information .....</b>	<b>49</b>
Battery Information.....	49
Safety Instructions.....	51
Disposal Information .....	54



# Before Initial Use

Please read "Important Information" on page 49 before use. Read and understand all instructions.

## ◆ Registration

Your PS (Portable Station) must be registered in the Business Telephone System and you have to determine the extension number before initial use.

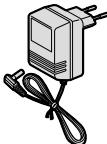
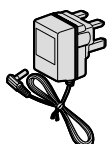
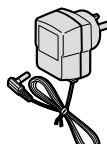
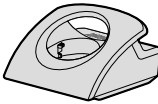
## ◆ Accessories ( -included/ -optional)

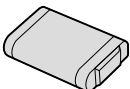
<input type="checkbox"/> AC adaptor For KX-TCA256CE users: KX-TCA1CE 	For KX-TCA256E users: KX-TCA1E 	For KX-TCA256AL users: KX-TCA1AL  One
<input type="checkbox"/> Charger  One	<input type="checkbox"/> Belt Clip  One	<input type="checkbox"/> Battery Cover  One
<input type="checkbox"/> Battery (N4HHGMB00007 or HHR-P103)  One	<input type="checkbox"/> CD-ROM..... One <input type="checkbox"/> Quick Guide..... One	<input checked="" type="checkbox"/> Leather Carrying Case* KX-A289CE Optional



- In this manual, the suffix of each model number is omitted.
- \* Consult your dealer for more details.

The following features described in this manual are not available when the PS is used with a Panasonic KX-TD816/KX-TD1232 Business Telephone System:

- Incoming Call Distribution Group (ICD-Group) - Incoming Call Log Group, Group Calls, etc.
- 12 flexible keys (3 flexible keys are available.)

# Before Operating the PS

## ◆◆ Location of Controls

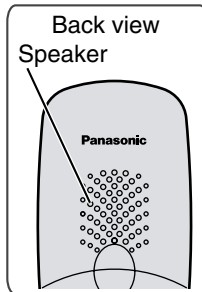
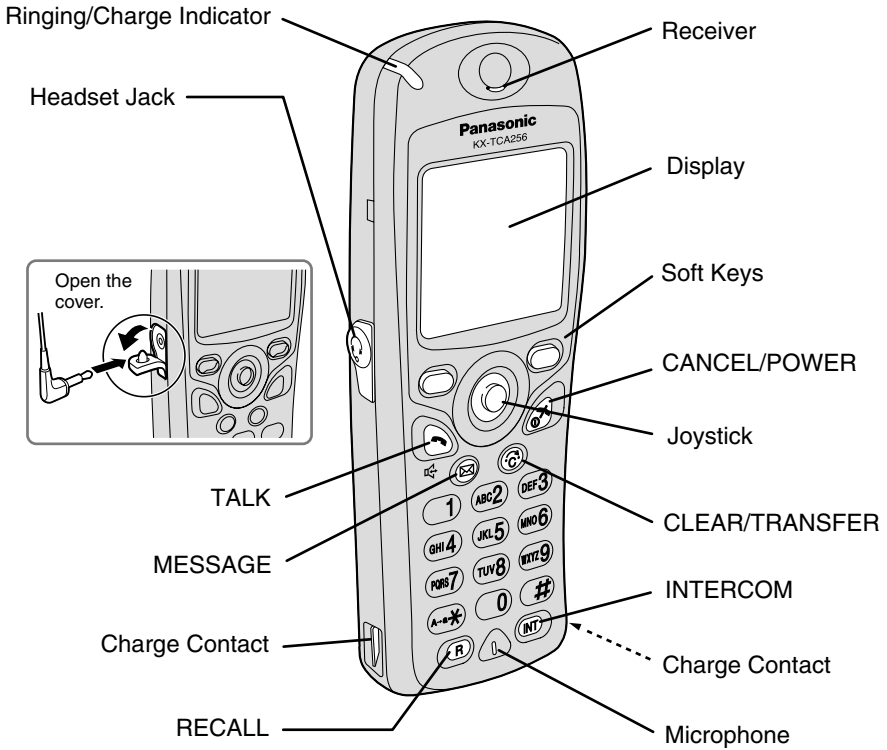

# Before Operating the PS



**TALK:**  
Used to make or receive calls, or to establish a hands-free conversation.



**Joystick:**  
Used to adjust the ringer/receiver volume, select the Function mode and the function displayed directly above, and move the cursor to select a desired item.



**MESSAGE:**  
Used to leave a message waiting indication or call back the party who left the message waiting indication.



**RECALL:**  
Used to disconnect the current call and make another call without hanging up, or answer Call Waiting from the telephone company.



**INTERCOM:**  
Used to make or receive intercom calls.



**CLEAR/TRANSFER:**  
Used to clear digits or characters, or transfer a call to another party.



**CANCEL/POWER:**  
Used to end calls, exit the Phonebook or Function mode, or turn on/off the PS.



**Soft Keys:**  
Used to select the function displayed directly above each key. Functions displayed depend on the state of use.

## ◆◆ Connection

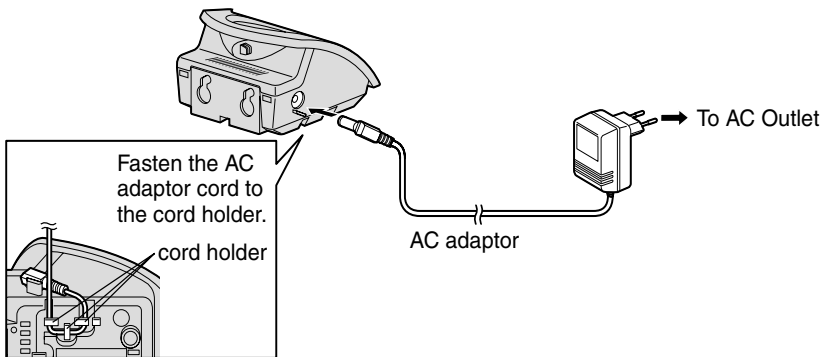

- Use only the included charger.
- Use only the included Panasonic AC adaptor.  
For KX-TCA 256CE users: model no. KX-TCA1CE  
For KX-TCA 256E users: model no. KX-TCA1E  
For KX-TCA 256AL users: model no. KX-TCA1AL

## ◆◆ Battery Installation

Insert the battery as shown. Close the cover as indicated by the arrow.

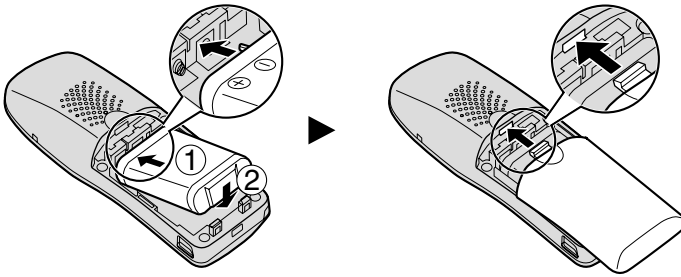

## ◆◆ Battery Charge

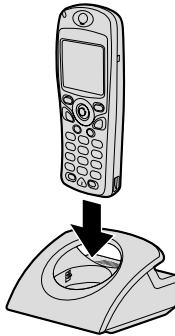

At the time of shipment, the battery is not charged. **Please charge the battery for more than 5.5 hours before initial use.**



- When the battery has been completely charged, the charge indicator will change from red to green. Refer to “Battery Information” on page 49.
- It is normal for the PS and charger to feel warm while the battery is charging.
- Keep devices sensitive to magnetic fields away from the charger.

# Before Operating the PS

## ◆◆ Power On/Off













<p><b>Power On</b></p>  <p>Press <b>POWER</b> for about 2 seconds.</p>	<p><b>Power Off</b></p>  <p>Press <b>POWER</b> for about 2 seconds. The display will go blank.</p>
---	---



- When the PS is turned on, it will be in standby mode. Standby mode is the state of the PS when it is not performing any operations and is awaiting calls.

## ◆◆ Display Icons



-  Within range of a Cell Station
-  Out of range, No registration
-  Intercom Indicator
-  Off-hook Status
-  Message Waiting
-  Phonebook Mode
-  Battery Strength
-  Hot Line ON
-  Ringer Volume OFF
-  Vibration
-  Meeting Mode
-  Call Forwarding
-  Do Not Disturb



## ◆◆ Operation Outline

Functions of the PS are accessed through the display menu, and selected with the joystick and soft keys. The guidance display is shown in standby mode for easy operation.

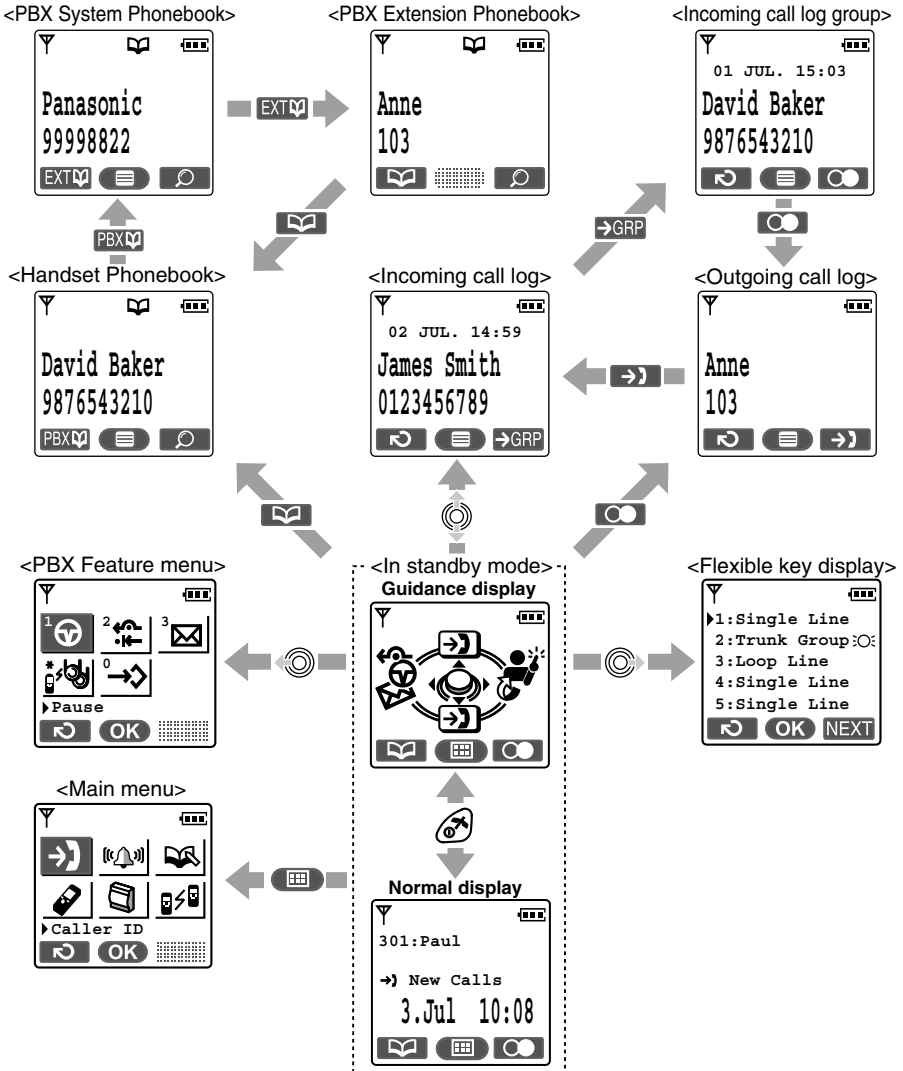

- You cannot toggle the displays while in key lock mode or while the PS is charging.
- You can select whether the guidance display is shown or not. (See page 40.)

# Before Operating the PS

---

## ◆◆ **Function Menu Display**

Press the joystick to display the function menu.

### ◆ **Main menu – while in standby mode**



#### **Caller ID:**

Displays the incoming call log.



#### **Ringer Option:**

Displays the “**Ringer Option**” menu.



#### **New Phonebook:**

Creates a new item in the Handset Phonebook.



#### **Setting Handset:**

Displays the “**Setting Handset**” menu.



#### **PBX Program:**

Enters PBX programming mode.



#### **Walkie-Talkie:**

Displays the Walkie-Talkie menu. (See page 45.)

### ◆ **Sub menu – while in off-hook/during a conversation**

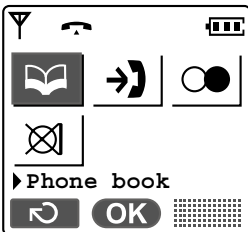

#### **Phone book:**

Opens the Handset Phonebook.



#### **Caller ID:**

Displays the incoming call log.



#### **Redial:**

Redials the last dialed number.



#### **Mute:**

Turns the microphone on/off.

## ◆◆ PBX Feature Menu

Functions of the PS can be activated through the display key list.  
Move the joystick left to display the key list.

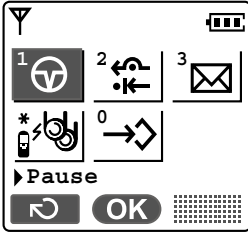
**Pause:**

Inserts a dialling pause.

**FWD/DND:**

Used to change Call Forwarding or Do Not Disturb settings.

**Message:**

Used to leave a message waiting indication or call back the party who left you a message waiting indication.

**Search Wave:**

Searches for the strongest radio signal coming from the Cell Station.

**PBX Program:**

Enters the PBX programming mode.  
Has the same function as “ **PBX Program**” found in the main menu.

# Before Operating the PS

## ◆◆ Flexible Key Display

A flexible key can be used either to seize a line in order to make or receive an outside call (F-CO key), or used as a function key. Move the joystick right to display the flexible key list. Here you can access the 12 flexible keys. The icon shown beside each F-CO key indicates line status similarly to the LED indicators on a Proprietary Telephone; ● means the same thing as a green LED, and ○ means the same thing as a red LED.

Example:

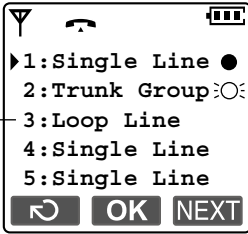

### Understanding the Icons for the F-CO key\*





























- (on): You are currently using this line.
- ⤴● (flashing rapidly): You have an incoming call on this line.
- ⤴○ (flashing slowly): You have a call on hold on this line.
- (on): This line is in use by someone else.
- ⤴○ (flashing rapidly): There is an incoming call received by an incoming call distribution group to which "Ring" is set as the group call distribution method.
- ⤴○ (flashing slowly): Someone has a call on hold on this line.
- (no icon): This line is idle.



- \* The meanings of these icons vary depending on the status of the CO line.
- For further information, refer to "LED Indication" in the KX-TDA series/ KX-TD816/KX-TD1232 Business Telephone System Feature Guide.
- To select a key, press its key number, or move the joystick up or down to select the desired key then press .
- To assign a function to a flexible key, see page 43.

## ◆◆ Soft Key Display

Icons and information shown on the display will vary depending on the state of use. To select an item shown on the display, press the corresponding soft key.

- |  |   |   |  |
|--|---|---|--|
|    | Opens the Handset Phonebook.  |    | Used to clear the memo alarm display setting, or enter an X when storing the "Line Access CD". |
|    | Opens the main menu.  |    | Used to select an item when in setting mode.   |
|    | Opens the function menu.  |    | Displayed when in ABC (Alphabetic) character entry mode.                                       |
|    | Displays the outgoing call log.   |    | Displayed when in 0-9 (Numeric) character entry mode.  |
|    | Used to confirm the entry.  |    | Displayed when in ABΓ (Greek) character entry mode.  |
|    | Turns the ringer off.   |    | Displayed when in AÄÄ (Extended 1) character entry mode.                                       |
|    | Opens the PBX System Phonebook.   |    | Displayed when in SSŠ (Extended 2) character entry mode.                                       |
|    | Opens the PBX Extension Phonebook.  |    | Displayed when key lock is turned on.  |
|    | Opens the incoming call log.  |  | Used to search for an item in the Phonebook alphabetically.                                    |
|    | Opens the incoming call log group.  |  | Used to place a call on hold.  |
|    | Displays the next screen.   |  | Used to establish a multiple-party conversation.   |
|    | Clears digits or characters.  |   |  |
|    | Inserts a dialling pause.   |   |  |
|    | Returns to the previous screen.   |   |  |
|  | Used to set the time for memo alarm.  |   |  |
|  | Displays the caller information stored in the Handset Phonebook while receiving a call. |   |  |
|  | Displays the caller information stored in the system while receiving a call.            |   |  |

# Before Operating the PS

## ◆◆ Ringer Volume Adjustment

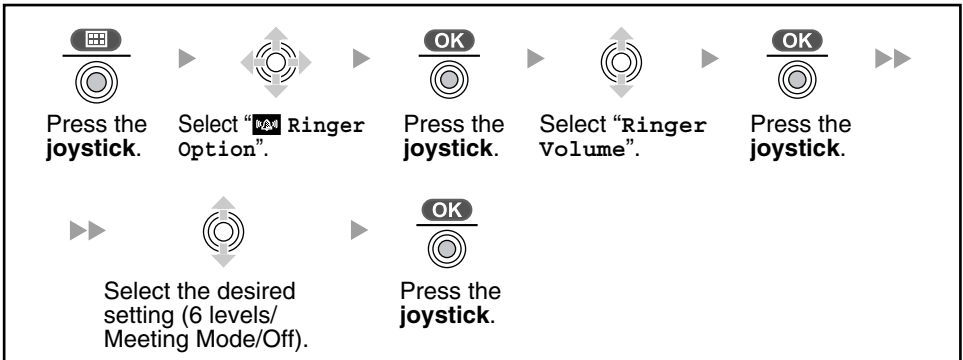

- In Meeting Mode: Vibration only/Key tone off/Microphone volume high
- You can select whether the PS will vibrate while receiving a call.

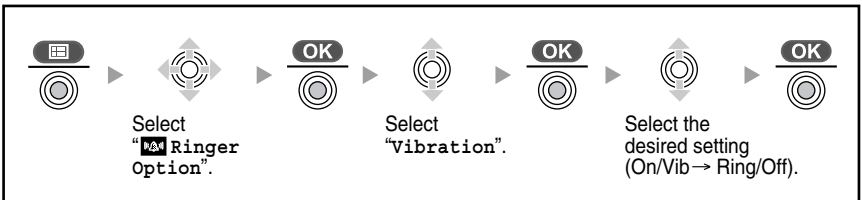

## ◆◆ Receiver/Speaker Volume Adjustment

*During a conversation*



Move the **joystick UP** or **DOWN** to adjust the volume.  
(Receiver Volume - 3 levels, Speaker Volume - 6 levels)

## ◆◆ Key Lock

You can lock the dialling buttons while the PS is in idle status.

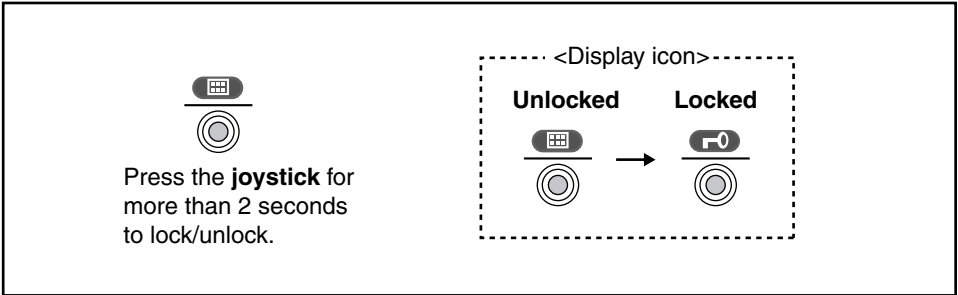

## ◆◆ Selecting the Display Language

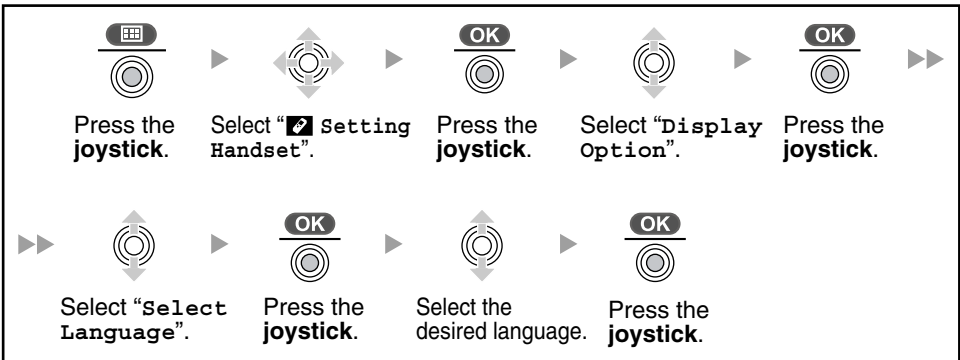

- You can select "**Auto**" or one of the 16 languages below:  
Deutsch, English, Español, FRANCAIS, Italiano, Dansk, Nederlands, Svenska, Suomi, ΕΛΛΗΝΙΚΑ, Magyar, Português, Polski, slovensky, čeština, Hrvatski.
- When set to "**Auto**", the language settings of the Business Telephone System will be used automatically.
- The display language of both the PS and Business Telephone System can be selected, and both should be set to the same language. Refer to the Business Telephone System User manual for more details.

# Making Calls

## ◆◆ Calling Another Extension

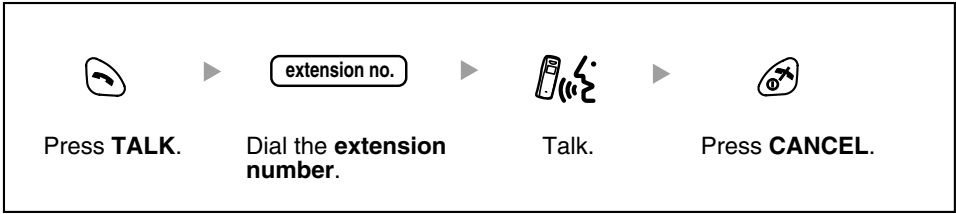



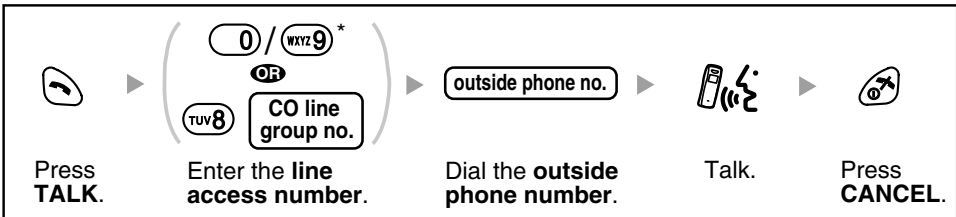

## ◆◆ Calling an Outside Party

### ◆ Using the line access numbers

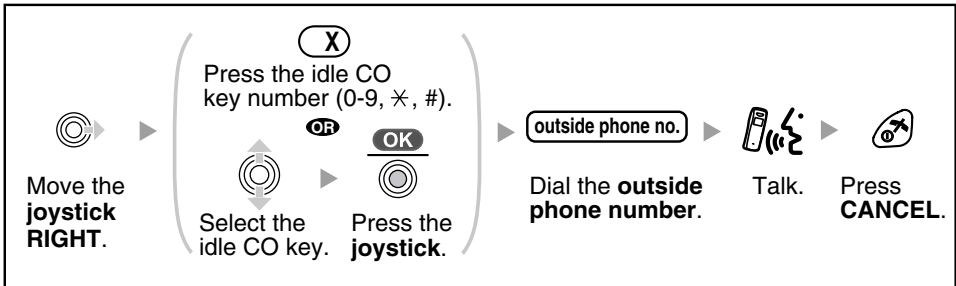

### ◆ Using Flexible CO keys



- \* The line access number (default) varies depending upon country/area. Consult your dealer for more details.
- You can confirm a number was dialed correctly before calling (**Predialling**) by entering the number, then pressing .
- To clear an entire number while predialling, press and hold .
- If “Y” flashes, move closer to the Cell Station and dial again.
- To cancel dialling, press .



## ◆◆ Hot Key Dial

You can make a call by simply pressing the assigned number as hot key.

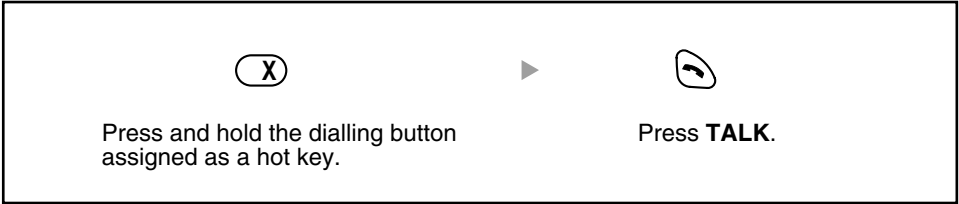

- To assign a phone number as hot key, see page 30.

## ◆◆ Using the Call Log

Feature	Display Icon	Description
<b>Outgoing Call Log</b>		You can make a call using the phone numbers you have dialled previously.
<b>Incoming Call Log</b>		You can make a call using the phone numbers of calls you have received.
<b>Incoming Call Log Group</b>		You can make a call using the phone numbers of calls that incoming call distribution groups have received.

## ◆ Using the Outgoing Call Log

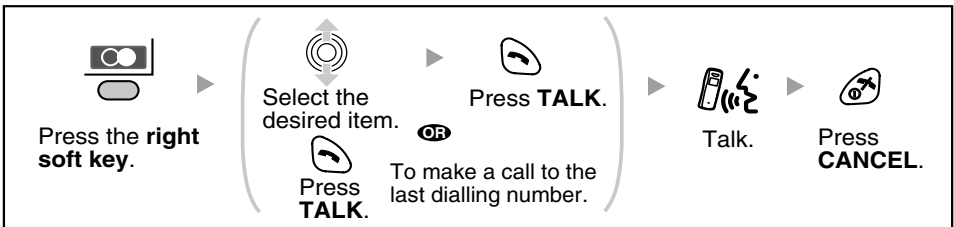

# Making Calls

## ◆ Using the Incoming Call Log



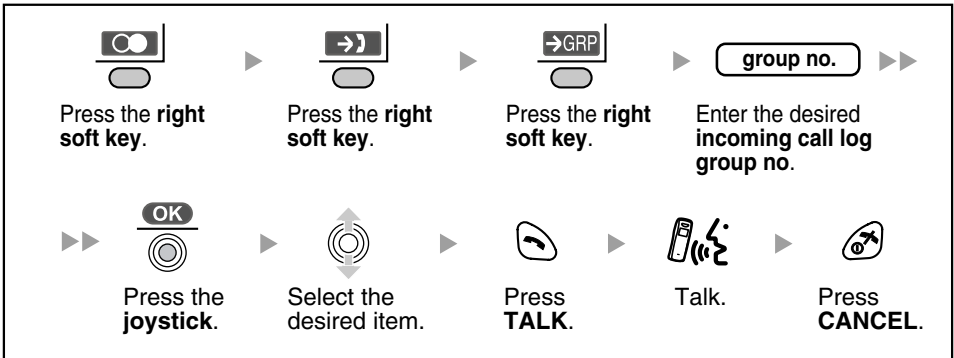

## ◆ Using the Incoming Call Log Group



- If an outside call is received from a phone number stored in the Handset Phonebook, the number and name of the caller will be displayed in the call log.
- When a call is made using the PBX System Phonebook, the called party's name is not stored in the Outgoing Call Log. To log the name as well as the number, copy the item into the Handset Phonebook before dialling it. (See page 29.)

## ◆◆ Using the Phonebook

Feature	Display Icon	Description
<b>Handset Phonebook</b>		You can make a call using the numbers stored in the Handset Phonebook. (See page 26.)
<b>PBX System Phonebook</b>		You can make a call using the numbers stored in the Business Telephone System.
<b>PBX Extension Phonebook</b>		You can make a call using the extension numbers stored in the Business Telephone System.

## ◆ Using the Handset Phonebook

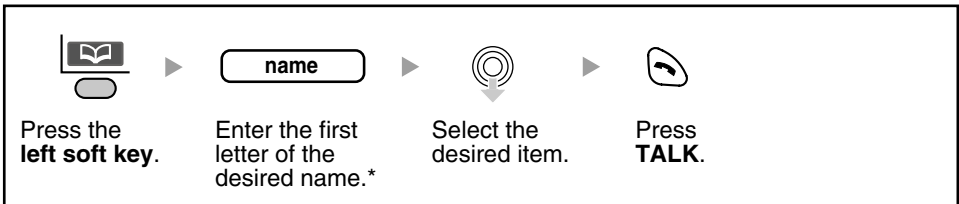

## ◆ Using the PBX System Phonebook

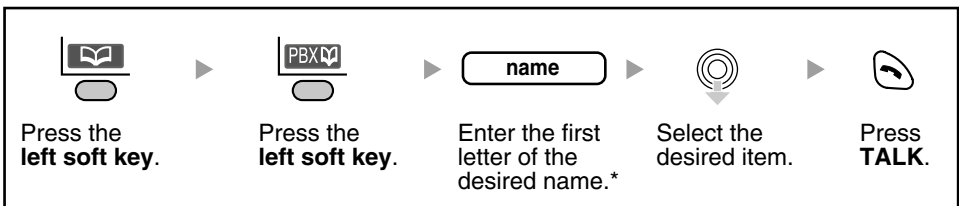

## ◆ Using the PBX Extension Phonebook

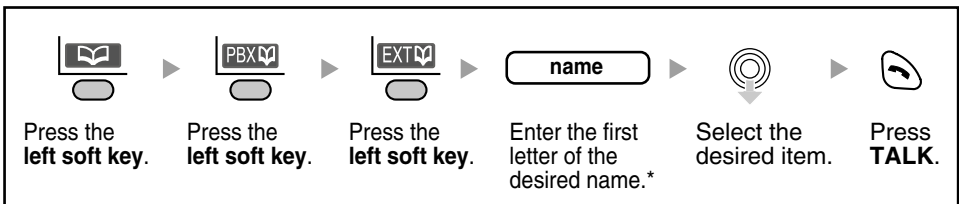

# Making Calls



- \* Press the dialling button (0-9) that corresponds to the letter you are searching for. Press the dialling button repeatedly until the desired key is displayed.
- You can search for an item stored in the Phonebook, as shown below:

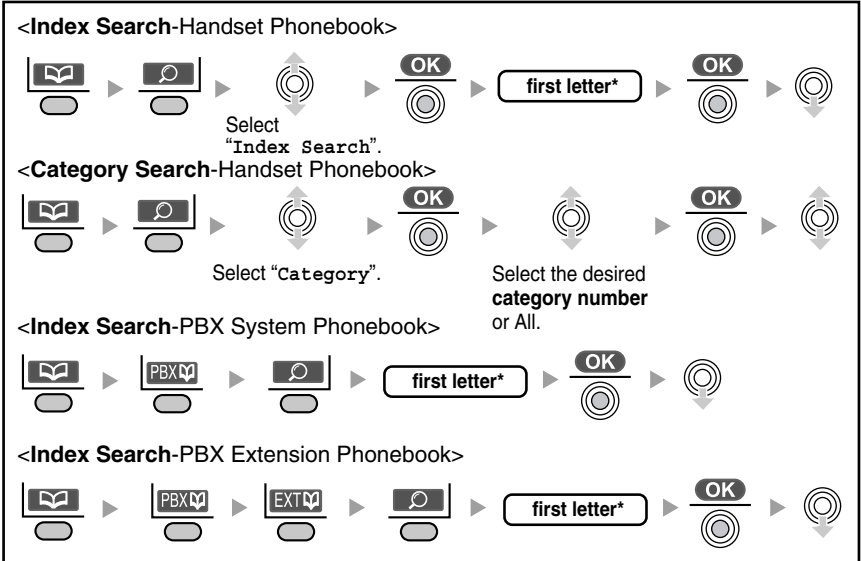

\* To enter characters:

1. Press the right soft key repeatedly to select the desired character entry mode.

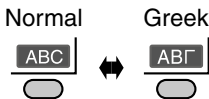

2. Press the dialling button (0-9) that corresponds to the letter you are searching for. Press the dialling button repeatedly until the desired key is displayed.

## ◆◆ Intercom Calls/Outside Calls/Group Calls

While receiving a call

### Intercom Calls/Outside Calls/Group Calls

To answer a call when the PS is ringing



### Intercom Calls

To answer a call when the PS is ringing



### Outside Calls

To answer a call on a specific line

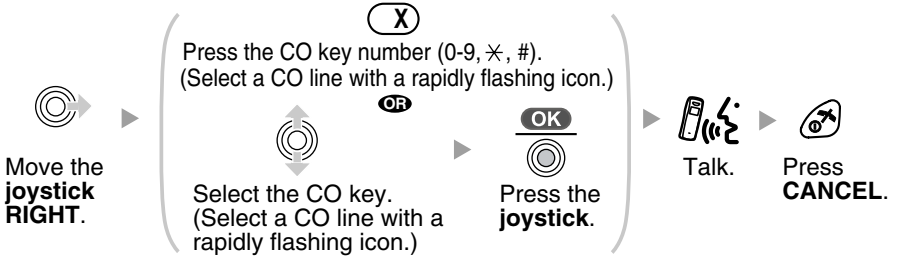

• You can also answer a call as follows:

- **Auto Talk** (See page 41.)
- **Any Key Answer** (See page 41.)
- **Auto Answer** (See page 41.)

## ◆◆ Temporary Ringer Volume Adjustment

While receiving a call



**OR**



# Receiving Calls

## ◆◆ Caller ID

If an outside call which contains Caller ID information is received, this information will be logged in the incoming call log.

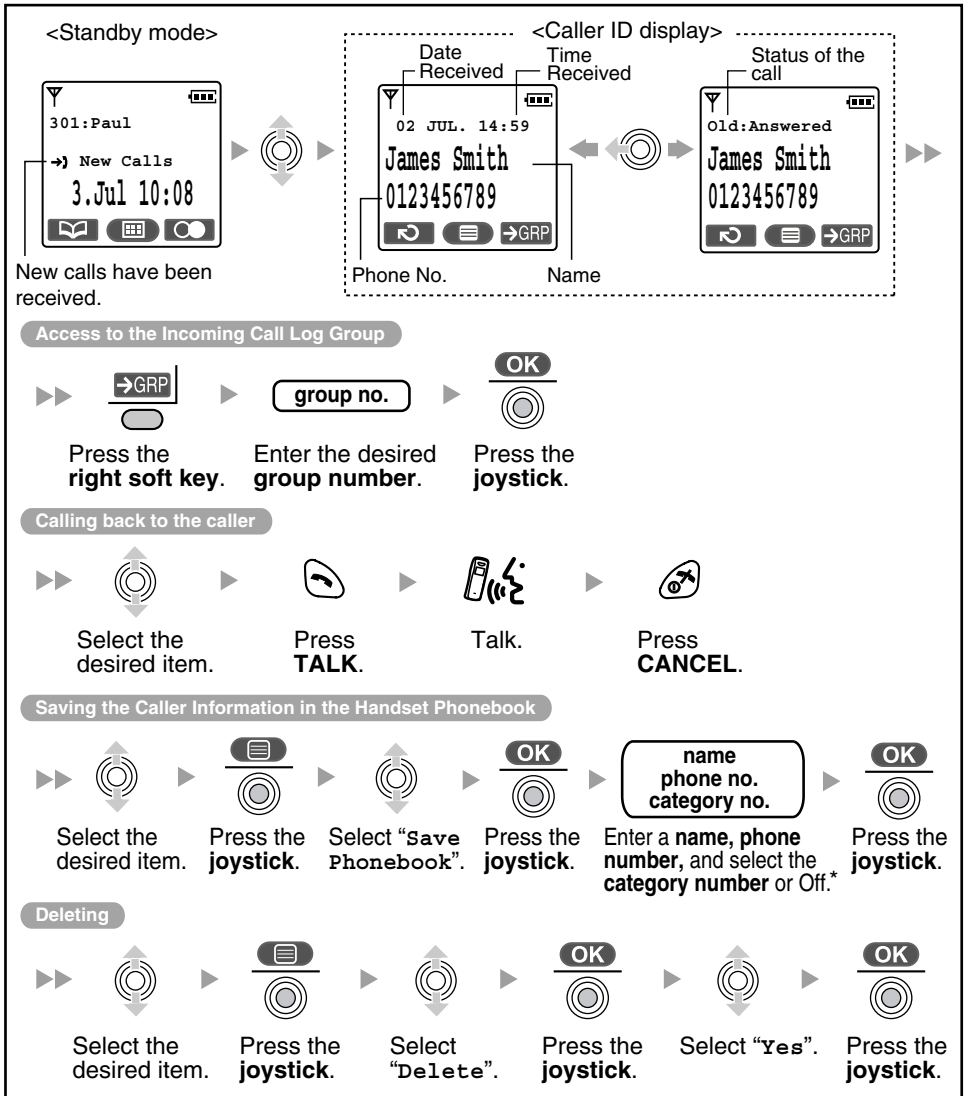

- \* Press to confirm each entries. (See page 29.)  
(name - max. 16 characters/phone no. - max. 32 digits)

## ◆◆ Transferring a Call

### ◆ Transferring to an extension

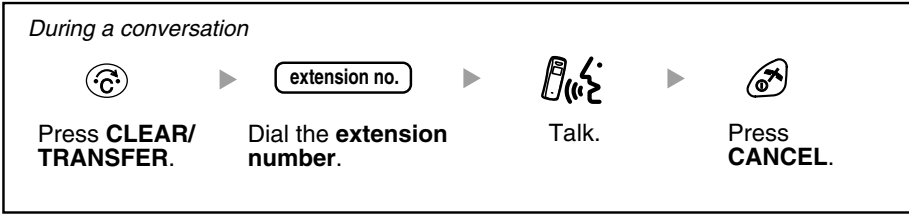

### ◆ Transferring to an outside party

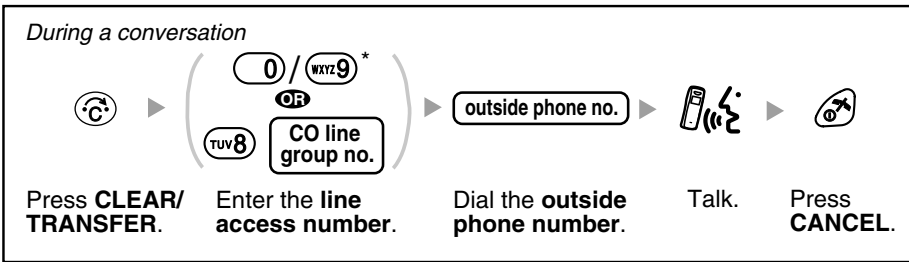

- \* The line access number (default) varies depending upon country/area. Consult your dealer for more details.
- To return to the call before the transfer destination answers, press .

## ◆◆ Holding

### ◆ To hold (Regular Hold)

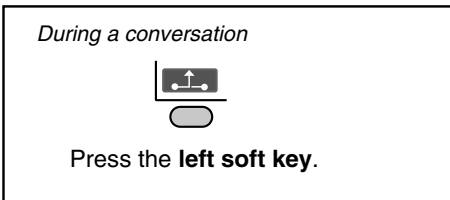

# During a Conversation

## ◆ To hold (Exclusive Call Hold)

You can hold a call exclusively so that only you can retrieve the call.

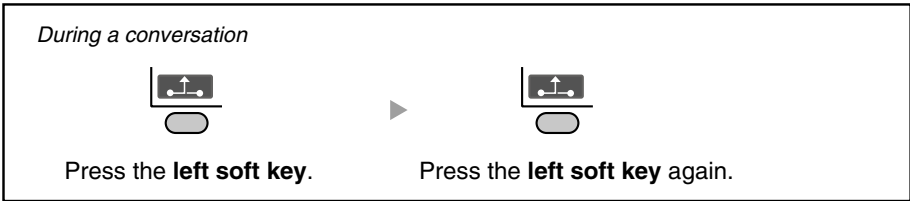

- The method used to hold a call depends on the Call Hold mode (Regular Hold/ Exclusive Call Hold). Ask your manager what the current mode is.
- In order to hold several outside line calls, you need to assign the CO keys (Single Line/Trunk Group/Loop Line/ICD Group) to flexible keys beforehand, as necessary.

## ◆ To retrieve a call

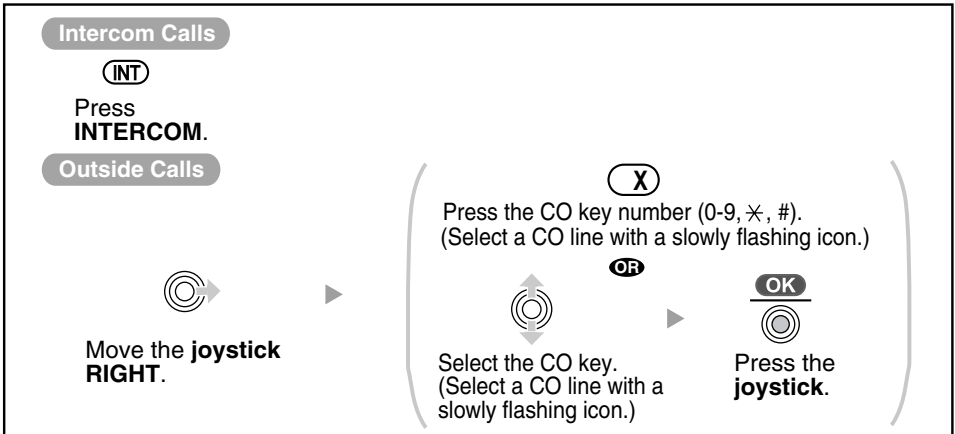



## ◆◆ Hands-free Conversation

You can talk with the calling party alternately through the speaker without holding the PS.

*During a conversation*



Press **TALK** to toggle between the two modes  
(Hands-free/Receiver).



- If you put the PS on the charger during a conversation, the call will be disconnected.

## ◆◆ Turning the Microphone On/Off

*During a conversation*



Press the  
**joystick**.



Select “ Mute”.



Press the  
**joystick**.

# Using the Phonebook

## ◆◆ Handset Phonebook

You can store up to 200 phone numbers in the Handset Phonebook. Each phone number can be assigned a name and category number for easy access. All phonebook items are stored in alphabetical order.

## ◆ Incoming Call Identification

You can organise entries in the Handset Phonebook into one of 9 categories. A call from someone stored in one of these categories will be indicated by the ringer type and the LED colour pattern that is assigned to the category.

Item	Setting
Ringer type	15 ringer type (See page 39.)
LED colour pattern	3 patterns (See page 40.)

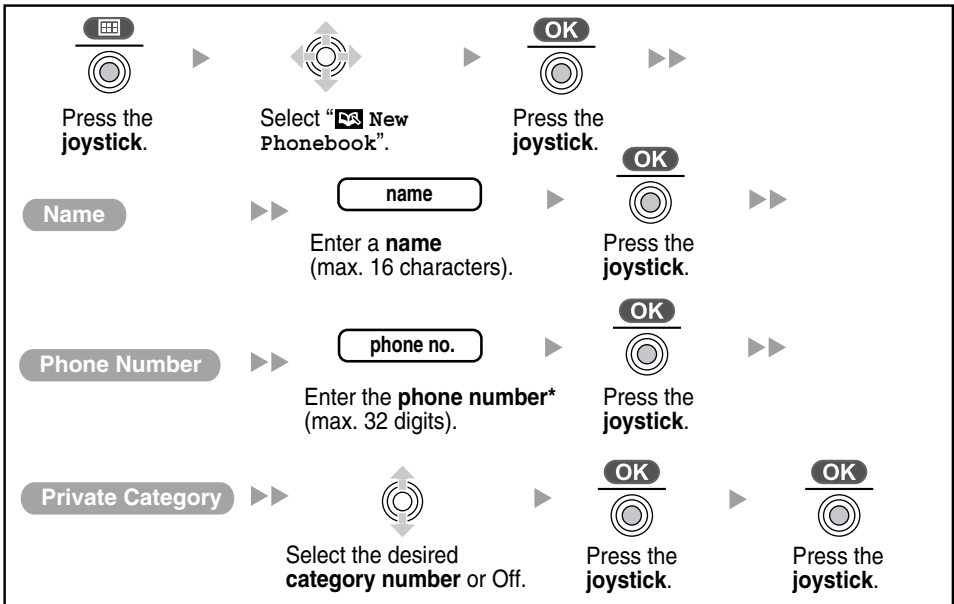

## ◆ Storing a new item

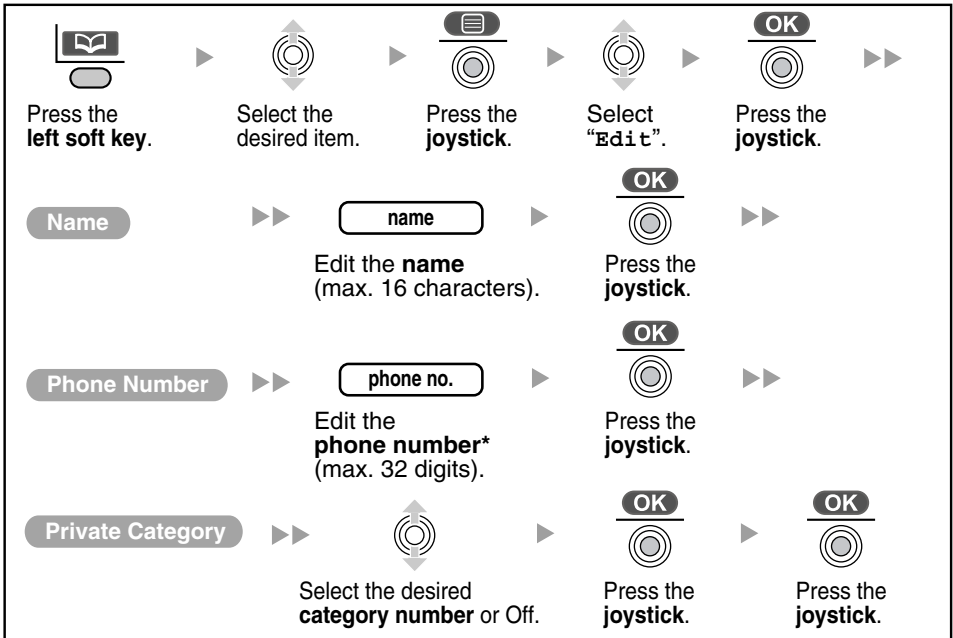

- To enter characters, see page 31.
- \* The valid digits are 0-9, " \* ", "#", PAUSE.
- \* Although up to 200 Phonebook items can be stored, each phone number stored in the Phonebook that contains over 24 digits counts as two Phonebook items.
- \* If there is only one Phonebook memory location available, you cannot store a phone number that is over 24 digits long.
- When storing numbers for outside parties, you should store the line access number with each number.

## ◆ Editing



- To enter characters, see page 31.
- \* The valid digits are 0-9, "×", "#", PAUSE.
- \* Although up to 200 Phonebook items can be stored, each phone number stored in the Phonebook that contains over 24 digits counts as two Phonebook items.
- \* If there is only one Phonebook memory location available, you cannot store a phone number that is over 24 digits long.
- To change a character or digit, move the joystick left or right to highlight it, press  to delete it, then enter the new character or digit.
- To clear an entire line, press and hold .
- To move the cursor to the left or right, move the joystick left or right, respectively.

# Using the Phonebook

## ◆ Deleting

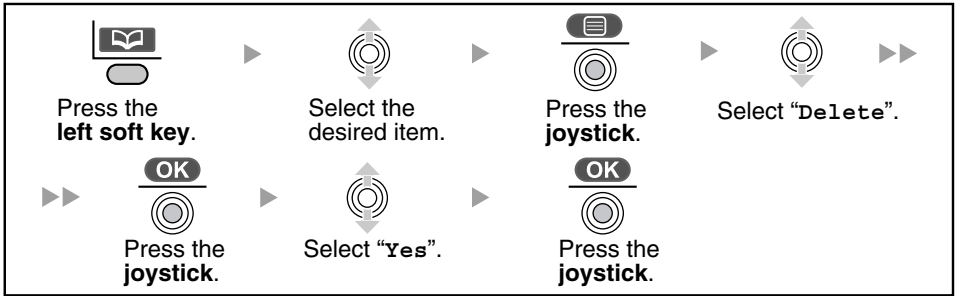

## ◆◆ Storing an item in the Handset Phonebook

### ◆ Using the Outgoing Call Log

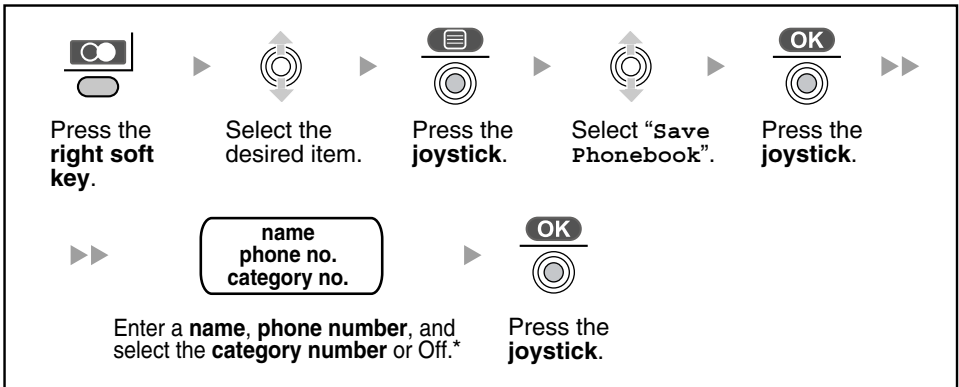

### ◆ Using the Incoming Call Log

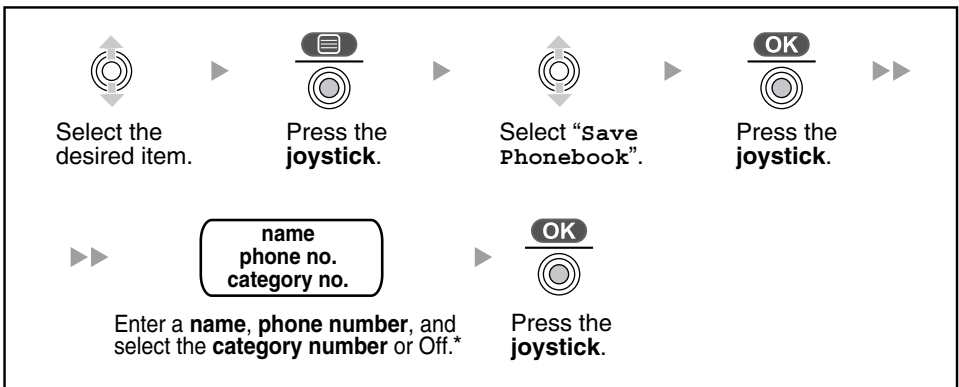

## ◆ Using the Incoming Call Log Group

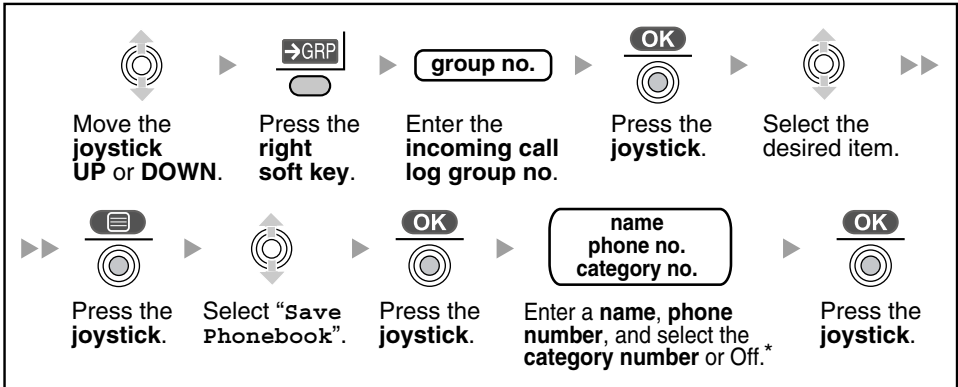

## ◆ Using the PBX System Phonebook

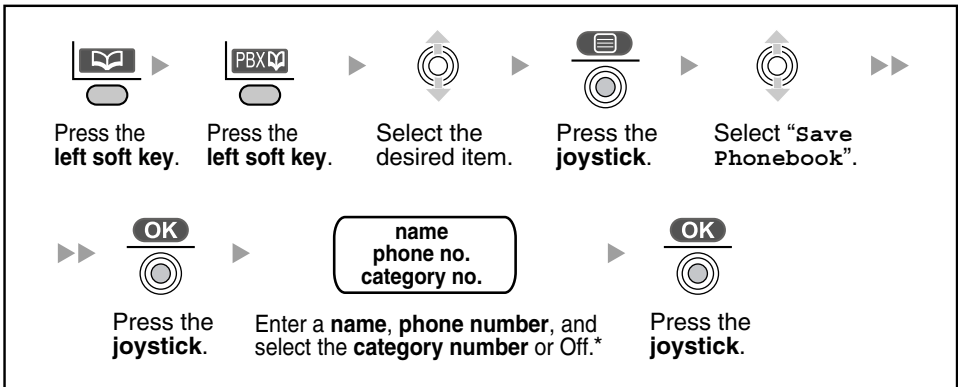

- \* Press  to confirm each entries.  
(**name** - max. 16 characters/**phone no.** - max. 32 digits)
  - Although up to 200 Phonebook items can be stored, each phone number stored in the Phonebook that contains over 24 digits counts as two Phonebook items.
  - If there is only one Phonebook memory location available, you cannot store a phone number that is over 24 digits long.
- When storing an outside phone number, the line access number will be stored automatically. The line access number must be identical to the PS's "**Line Access CD**" setting (**Call Option**). (See page 40.)

# Using the Phonebook

---

## ◆◆ Hot Key Dial

The phone numbers stored in the Handset Phonebook can be assigned as hot key.

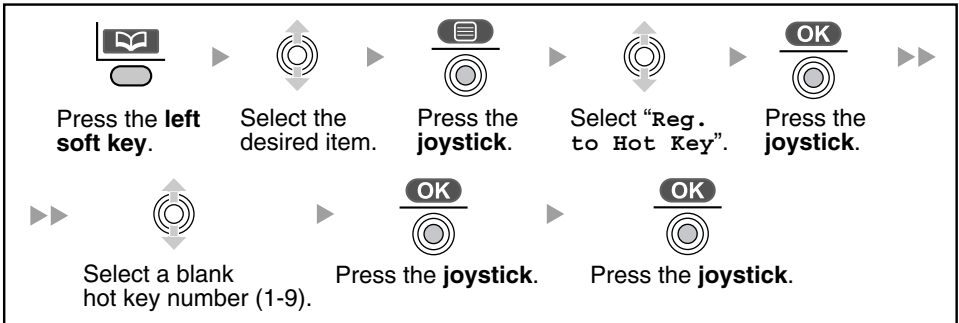

- A "✓" will be displayed next to hot key numbers which have a phonebook item registered to them.

## ◆◆ Entering Characters

You can enter characters and digits using the dialling buttons.

You can select one of 5 character modes by pressing the **right soft key** while entering a name. The function icon above the soft key displays the current character mode.

See “Character Mode Table” (page 32) for available characters.

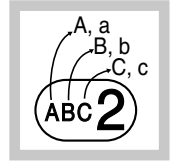

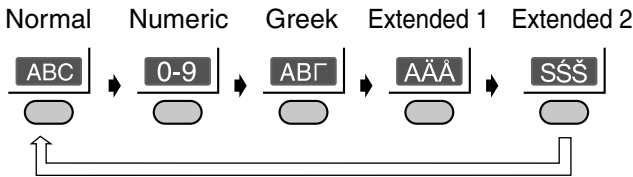

To change the character mode while editing a name in the phonebook, press the **right soft key**.

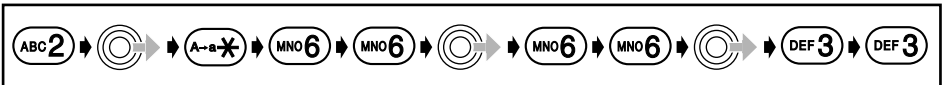

**Example:** To enter “**Anne**” in Normal Mode.



- To enter a character located on the same dialling button as the previous character, move the cursor by moving the joystick right, then enter the desired character.
- If you enter a different character by mistake, move the joystick left or right to highlight the character, press  to delete it, then enter the correct character.
- To clear an entire line, press and hold .
- To move the cursor, move the joystick in the desired direction.

# Using the Phonebook

## ◆ Character Mode Table

Buttons	ABC (Alphabet)	0-9 (Numeric)	ABΓ (Greek)	AÄÅ (Extended 1)	SŠŠ (Extended 2)
1	Space # & ' ( ) * , - . / 1	1	Space # & ' ( ) * , - . / 1	AÄÅ	SŠŠ
2	ABC 2	2	ABΓ 2	AÄÅ	AÄÅ
	abc 2			ÄÅ	ÄÅ
3	DEF 3	3	ΔEZ 3	DE	D
	def 3			E	E
4	GHI 4	4	HΘI 4	GHI	GHI
	ghi 4			I	I
5	JKL 5	5	KΛM 5	JKL	JKL
	jkl 5			L	L
6	MNO 6	6	NΞO 6	MNO	MNO
	mno 6			O	O
7	PQRS 7	7	ΠΡΣ 7	PQR	PQR
	pqrs 7			S	S
8	TUV 8	8	ΤΥΦ 8	TUV	TUV
	tuv 8			V	V
9	WXYZ 9	9	ΧΨΩ Ξ 9	WXY	WXY
	wxyz 9			Z	Z
0	Space 0	0	Space 0		

• The following letters are not available. They will be replaced by the uppercase (or lowercase) version of the same letter.

ą ć d'ę ł i l' n' Ń r ś s š t w Ÿ Y z z ž

• Press **(\*)** to change between uppercase and lowercase.







# Feature List

This feature list applies only when your PS is connected to a KX-TDA series Business Telephone System. For further information, refer to the KX-TDA series/KX-TD816/ KX-TD1232 Business Telephone System User Manual or consult your dealer.



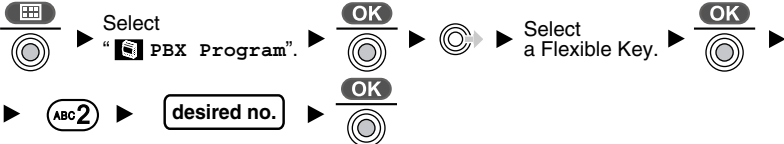
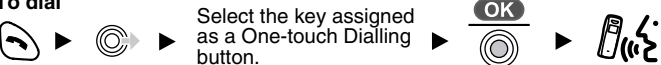

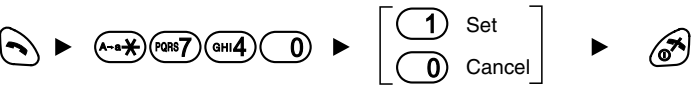
R.B. Tone: Ringback Tone

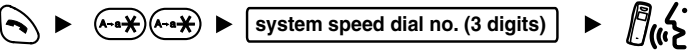
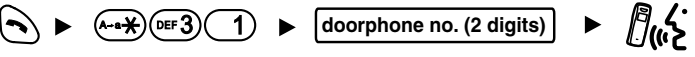



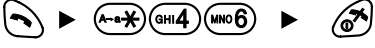

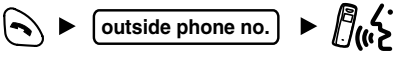
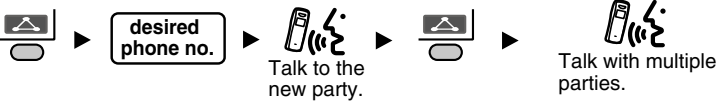

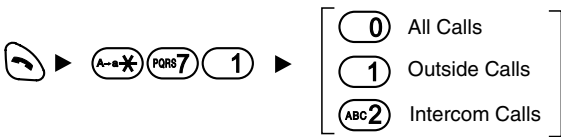
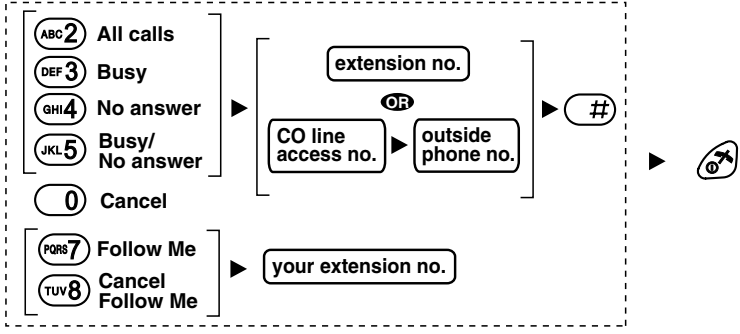





















































































ICD Group: Incoming Call Distribution Group

PIN: Personal Identification Number

Feature	Operation
<b>Making Calls</b>	
One-touch Dialling	<p><b>To store</b></p>  <p><b>To dial</b></p> 
Hot Line* <sup>1</sup>	<p><b>To store</b></p>  <p><b>To set/cancel</b></p>  <p><b>To dial</b></p> 
Operator Call	
System Speed Dialling	<p><b>To dial</b></p> 
Doorphone Call	

# Feature List

Feature	Operation
<b>Making Calls</b>	
Automatic Callback Busy	<p><b>To set</b> While hearing a busy tone</p> 
	<p><b>To cancel</b></p> 
	<p><b>To answer from an idle extension</b> While hearing a callback ring</p> 
	<p><b>To answer from an idle outside line</b> While hearing a callback ring</p> 
<b>During a Conversation</b>	
Multiple Party Conversation	<p><b>To add another party during a conversation</b></p> 
	<p><b>To leave a conference</b></p> 
<b>Useful Features</b>	
Call Forwarding	
	

Feature	Operation														
<b>Useful Features</b>															
Do Not Disturb	 ▶    ▶ <table border="1" data-bbox="537 279 739 406"> <tr><td> All Calls</td></tr> <tr><td> Outside Calls</td></tr> <tr><td> Intercom Calls</td></tr> </table> ▶ <table border="1" data-bbox="778 295 935 383"> <tr><td> Set</td></tr> <tr><td> Cancel</td></tr> </table> ▶ 	 All Calls	 Outside Calls	 Intercom Calls	 Set	 Cancel									
 All Calls															
 Outside Calls															
 Intercom Calls															
 Set															
 Cancel															
Call Pickup	 ▶ <table border="1" data-bbox="347 430 767 574" style="border-style: dashed;"> <tr> <td><b>Directed</b></td> <td>   ▶ <input type="text" value="extension no."/></td> </tr> <tr> <td><b>Group</b></td> <td>   ▶ <input type="text" value="group no. (2 digits)"/></td> </tr> </table> ▶ 	<b>Directed</b>	   ▶ <input type="text" value="extension no."/>	<b>Group</b>	   ▶ <input type="text" value="group no. (2 digits)"/>										
<b>Directed</b>	   ▶ <input type="text" value="extension no."/>														
<b>Group</b>	   ▶ <input type="text" value="group no. (2 digits)"/>														
Sending a Call Waiting Tone*2	<i>While hearing a busy tone</i>  ▶ Wait for an answer. ▶ 														
Call Waiting	<b>To set/cancel for intercom calls</b>  ▶     ▶ <table border="1" data-bbox="621 742 856 829"> <tr><td> No call</td></tr> <tr><td> Set</td></tr> </table> ▶ 	 No call	 Set												
	 No call														
	 Set														
<b>To set/cancel for outside calls</b>  ▶     ▶ <table border="1" data-bbox="638 869 812 973"> <tr><td> No tone</td></tr> <tr><td> Tone</td></tr> </table> ▶ 	 No tone	 Tone													
 No tone															
 Tone															
<b>To hold the current call and then talk to the new party</b> <i>While hearing a call waiting tone</i>  ▶ <table border="1" data-bbox="386 1053 890 1244" style="border-style: dashed;"> <tr> <td></td> <td>▶</td> <td></td> <td>▶</td> <td></td> </tr> <tr> <td></td> <td></td> <td></td> <td></td> <td></td> </tr> <tr> <td></td> <td></td> <td></td> <td></td> <td></td> </tr> </table> ▶  (Disregard this step if both parties are extensions.)		▶		▶											
	▶		▶												
															
															
Paging	<b>To page</b>  ▶    ▶ <input type="text" value="paging group no. (2 digits)"/> ▶  ▶ Announce. ▶ Wait for an answer. ▶ 														
	<b>To answer</b>  ▶    ▶ 														

# Feature List

Feature	Operation	
<b>Useful Features</b>		
Absent Message	<b>To set</b> ►     ► <b>message no. (1-9)</b> ► <b>parameter (if required)</b> ►  ►	
	<b>To cancel</b> ►      ►	
Log-in/ Log-out	► [      For Log-in    ►	
Extension Setting Clear	►     ►	
Message Waiting	Caller	<b>To leave a message waiting indication</b> <i>When the called extension is busy or does not answer</i> ►
		<b>To cancel a message waiting indication</b> ►     ► <b>extension no.</b> ►
	Called extension	<b>To call back</b> ►       ►
Extension Lock* <sup>3</sup>	<b>To lock</b> ►     ►	
	<b>To unlock</b> ►     ► <b>extension PIN (max. 10 digits)</b> ►	





- \*1 When the Hot Line feature is set using this method, the “Hot Line” icon will not be displayed. This icon is only displayed when the Hot Line feature is set using the method on page 40.
- \*2 You cannot send a call waiting tone when:
  - the called party has not set the Call Waiting feature.
  - the called party has set the Data Line Security feature.
- \*3 If an extension PIN has not been set for the PS, the extension cannot be locked.

## ◆◆ Changing the Initial Settings

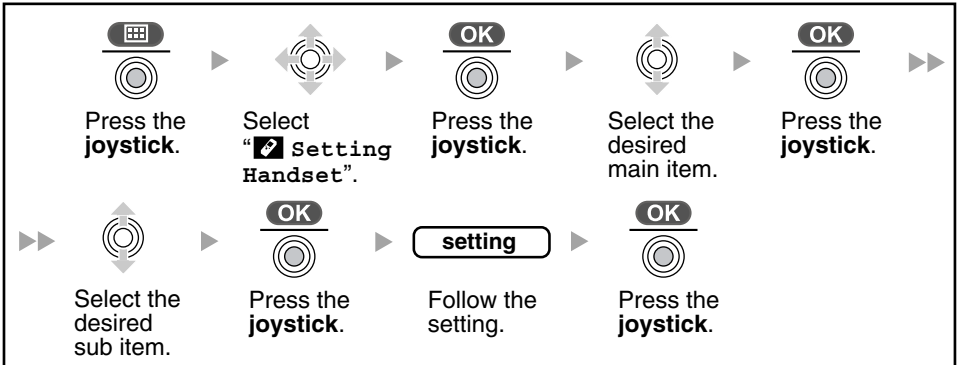
You can customise the handset by editing the settings found under “**Setting Handset**” in the menu list, as follows:



- To return to the previous menu, press .
- To cancel, press  at any time.
- The unit will beep to indicate that the new settings have been saved.

# Programming

## ◆ Handset setting menu layout

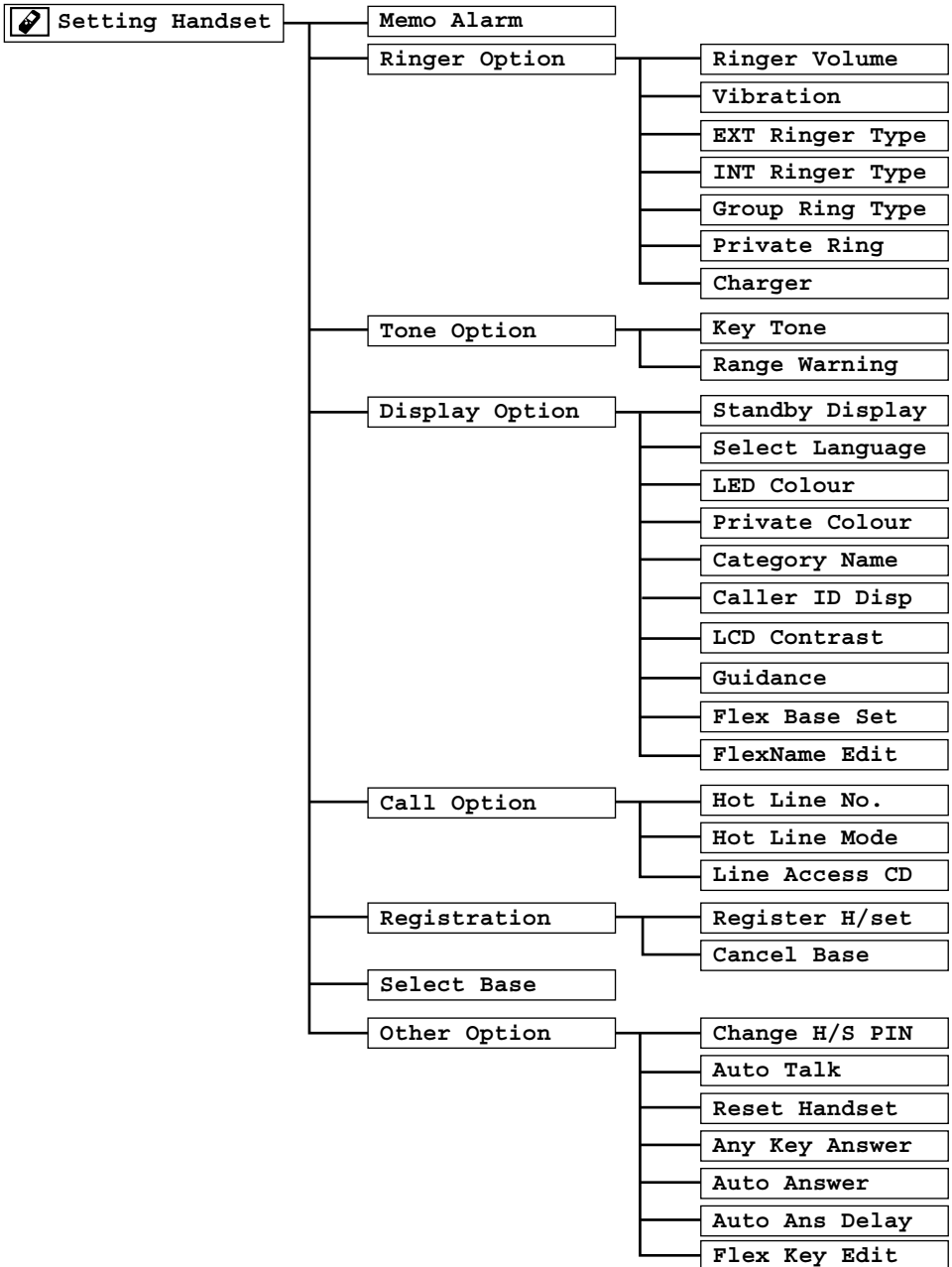

Main Item	Sub Item	Description	Setting	Default
Memo Alarm		An alarm will sound at the set time. A memo can also be displayed. (See page 42.)	<input type="checkbox"/> Alarm no. <input type="checkbox"/> Alarm mode (Off/Once /Daily) <input type="checkbox"/> Alarm time <input type="checkbox"/> Enter memo. <input type="checkbox"/> 15 Ringer Type	Not Stored
Ringer Option	Ringer Volume	Adjusts the ringer volume.	<input type="checkbox"/> 6 levels/ Meeting Mode/ Off	Level 3
	Vibration	Selects whether the PS vibrates while receiving a call.	<input type="checkbox"/> On/ Vib→Ring/Off	Off
	EXT Ringer Type	Selects the ringer type for each type of call (intercom call, outside call, group call).	<input type="checkbox"/> 15 Ringer Types	Ringer 1
	INT Ringer Type			
	Group Ring Type			
	Private Ring	Selects the ringer type for calls in each category.	<input type="checkbox"/> Select a Category. <input type="checkbox"/> 15 Ringer Types	
	Charger	Selects whether the PS on a charger rings or not.	<input type="checkbox"/> Ringer Setting/ Ringer Off	Ringer Setting
Tone Option	Key Tone	Turns the key tone off or on.	<input type="checkbox"/> On/Off	On
	Range Warning	Selects whether the warning tone is heard when you are close to out of range.	<input type="checkbox"/> On/Off	On
Display Option	Standby Display	Selects the display in standby mode.	<input type="checkbox"/> 4 Display Type (Base Number/ Handset Number/ Handset Name/ Base & H/S No.)/ Off	Base & H/S No.
	Select Language	Selects the display language.	<input type="checkbox"/> Auto/ 16 Languages	Auto
	LED Colour	Selects the LED colour for each type of call (intercom call, outside call, group call).	<input type="checkbox"/> Call Type (Ext Ring/ Int Ring/ Group Ring) <input type="checkbox"/> Colour (Green/Red/ Orange)	INT Ring-Green, EXT Ring-Red, Group Ring-Orange

# Programming

Main Item	Sub Item	Description	Setting	Default
Display Option	Private Colour	Selects the LED colour for calls in each category. "Private Colour" setting has priority the "LED Colour" setting.	<input type="checkbox"/> Select a Category. <input type="checkbox"/> Colour (Green/Red/Orange)	Green
	Category Name	Edits the category name.	<input type="checkbox"/> Select a Category.	Category 1-9
	Caller ID Disp	Selects which caller information is displayed when a call is received. Either the Handset Phonebook information or the information stored in the Business Telephone System can be displayed.	<input type="checkbox"/> H/S Phonebook/ PBX Setting	PBX Setting
	LCD Contrast	Adjusts the LCD contrast.	<input type="checkbox"/> 6 levels	Level 4
	Guidance	Selects whether the guidance display is shown or not in standby mode.	<input type="checkbox"/> On/Off	On
	Flex Base Set	Allows you to select a base unit to enable "FlexName Edit". When a handset is registered with only one base unit, this menu is not displayed.	<input type="checkbox"/> Base no.	
	FlexName Edit	Allows you to edit the name of flexible keys. (max. 12 characters)	<input type="checkbox"/> Select a flexible key, then edit the name.	Not stored
Call Option	Hot Line No.	Allows you to store a phone number as the hot line number. This number is automatically dialed when you press TALK.	<input type="checkbox"/> Enter Phone no.	Not stored
	Hot Line Mode	When set to ON, you can make a call to the stored phone no. in "Hot Line No." by pressing TALK. You cannot make calls to other phone numbers.	<input type="checkbox"/> On/Off	Off
	Line Access CD	Enters the trunk access code (line access code) that matches the setting of your Business Telephone System. Three trunk line codes can be stored.	<input type="checkbox"/> Select a number, then enter the code.	No.1 0 No.2 8XX* No.3 Not stored



Main Item	Sub Item	Description	Setting	Default
Registration	Register H/set	Registers a handset to a base unit.	<input type="checkbox"/> Base no. <input type="checkbox"/> Base PIN [Personal Identification Number]	Not stored
	Cancel Base	Cancels the registration of a handset.	<input type="checkbox"/> H/set PIN (Default: 0000) <input type="checkbox"/> Base no.	Not stored
Select Base		Selects a base unit.	<input type="checkbox"/> Auto/Base no.	Auto
Other Option	Change H/S PIN	Changes the handset PIN.	<input type="checkbox"/> Enter old PIN, new PIN, then enter new PIN again.	0000
	Auto Talk	When set to ON, allows you to answer a call by just lifting up the handset from the charger.	<input type="checkbox"/> On/Off	On
	Reset Handset	Returns the handset settings (except Registration) to the default settings.	<input type="checkbox"/> Enter H/set PIN, then select "Yes".	
	Any Key Answer	When set to ON, allows you to answer a call by pressing any dial button.	<input type="checkbox"/> On/Off	Off
	Auto Answer	Determines the types of calls that can be answered by AUTO ANSWER.	<input type="checkbox"/> 2 Call Types (Internal Only/ Int&External)/Off	Off
	Auto Ans Delay	Selects the number of seconds before a call is automatically answered when Auto Answer is turned on.	<input type="checkbox"/> 5 s-20 s	6 s
	Flex Key Edit	Allows you to assign a function to a flexible key, and use the key as a shortcut key.	<input type="checkbox"/> See page 43.	PBX setting



- \* XX is identical to the CO line group number and 8XX represents any 3-digit code starting with "8".

# Programming

## ◆ Memo alarm setting

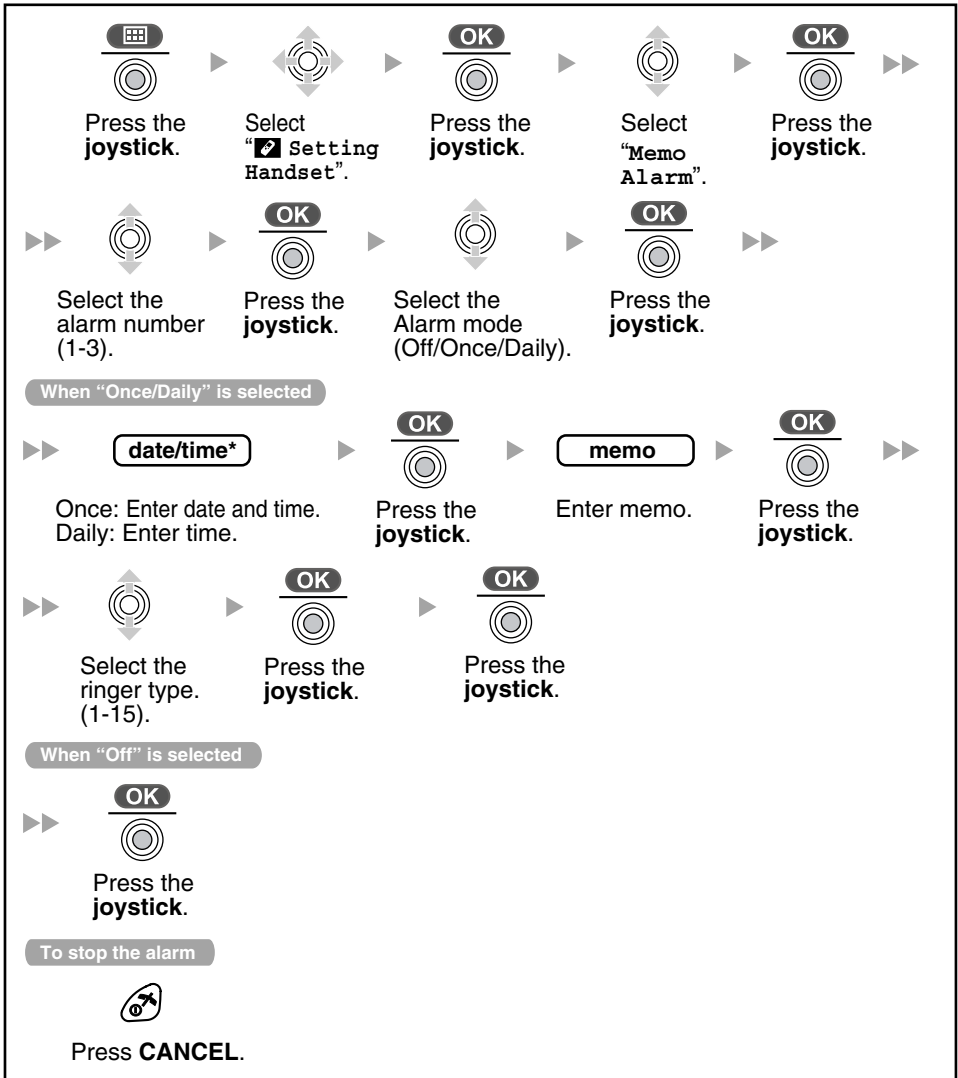

- \* You can choose either 12-hour format (AM/PM) or 24-hour format by pressing .
- To clear the displayed memo alarm, press and then select "Yes".
- If you are on a call at the time that the alarm is set to sound, it will sound after you have ended the call.



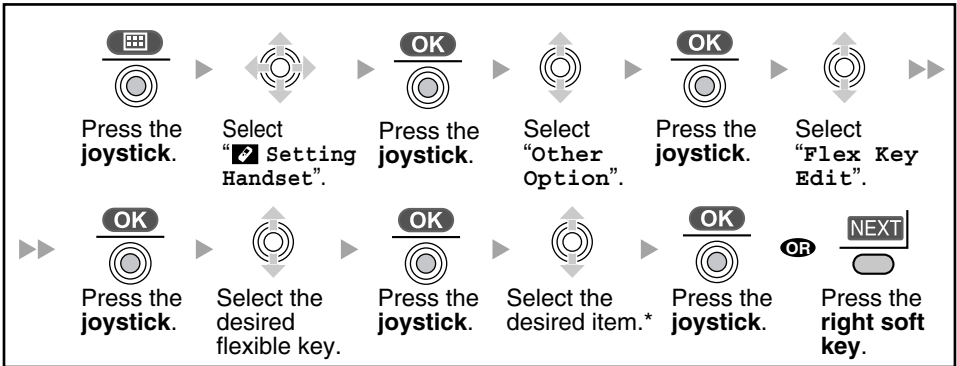

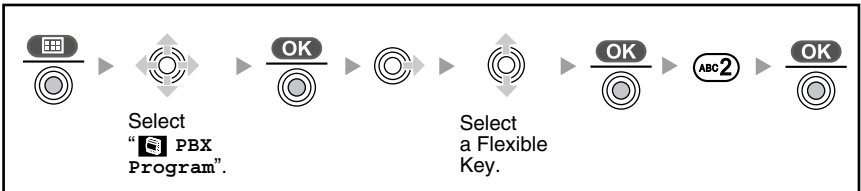

## ◆ Flexible key edit



- \* Items on page 44 can be assigned, and accessed through the display operation.
- To assign an item other than "PBX setting" to a flexible key which has already been used, first set the key to "Not stored".



# Programming

Main Item	Sub-Items			
PBX setting				
Menu	 Caller ID			
	 Ringer Option	Ringer Volume Vibration EXT Ringer Type INT Ringer Type Group Ring Type Private Ring Charger		
	 New Phonebook			
	 Setting Handset	Memo Alarm		
		Ringer Option	Ringer Volume Vibration EXT Ringer Type INT Ringer Type Group Ring Type Private Ring Charger	
		Tone Option	Key Tone Range Warning	
		Display Option	Standby Display Select Language LED Colour Private Colour Category Name Caller ID Disp LCD Contrast Guidance Flex Base Set FlexName Edit	
		Call Option	Hot Line No. Hot Line Mode Line Access CD	
		Registration		
		Select Base		
Other Option	Change H/S PIN Auto Talk Reset Handset Any Key Answer Auto Answer Auto Ans Delay Flex Key Edit			
 PBX Program				
 Walkie-Talkie				
Dialing	H/set Phonebook PBX Sys Dialing PBX EXT Dialing			
Call log	Redial Incoming Log Incoming LogGrp			



• To access sub-items, press .



## ◆◆ Walkie-Talkie

Using Walkie-Talkie mode, you can communicate with another handset even when out of range of a base unit. Only a Panasonic DECT Portable Station which supports Walkie-Talkie can be used. Handsets have to be in Walkie-Talkie mode, and have the same Walkie-Talkie group number. In Walkie-Talkie mode, you cannot make or receive a call through the PBX.

### ◆ Turning the Walkie-Talkie mode on

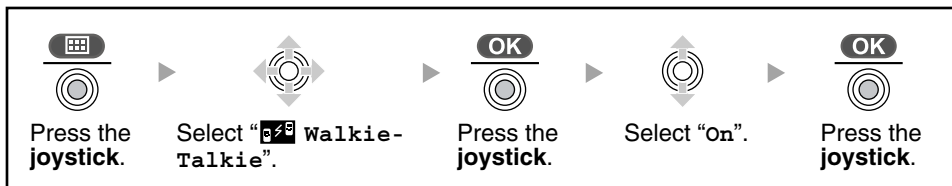

### ◆ Turning the Walkie-Talkie mode off



- To exit the operation, press  any time.
- When the Walkie-Talkie mode is ON, the handset number is displayed followed by "Walkie-Talkie".

# Others

## ◆ Setting the Walkie-Talkie mode

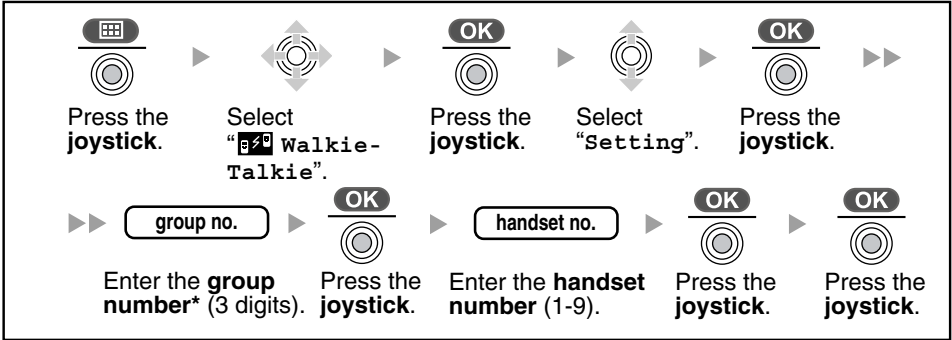

- To exit the operation, press any time.
- \* Any 3 digits can be used. Make a note of the group number you set here.
- Each handset should have its own unique handset number.

## ◆ Talking in Walkie-Talkie mode

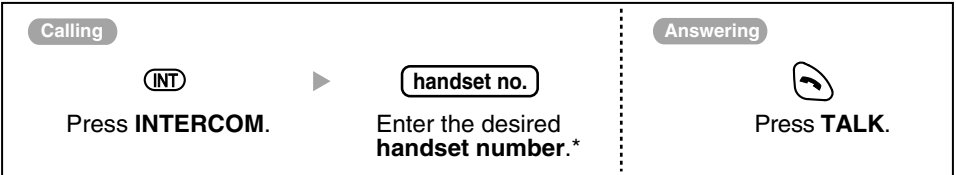

- To exit the operation, press any time.
- \* A caller can press to call all handsets in the same Walkie-Talkie mode.

## ◆◆ Using the Belt Clip

You can hang the handset on your belt.

Allows phone straps and similar objects to be connected.

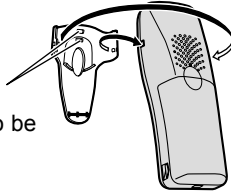

To remove the belt clip.



## ◆◆ Wall Mounting

- 1 Connect the AC adaptor to the charger.
- 2 Drive the screws into the wall using the wall template below.

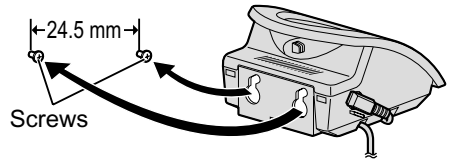
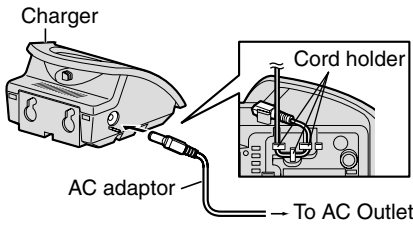

- 3 Mount the charger securely on the screws.

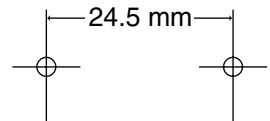

# Troubleshooting

## ◆◆ Troubleshooting

Problem	Description and Solution
<b>The PS does not work.</b>	<ul style="list-style-type: none"><li>• <b>The battery is drained.</b> → Charge the battery fully. (See “Battery Charge” on page 7.)</li><li>• <b>The PS has been cancelled or the PS has not been registered.</b> → Consult your dealer.</li><li>• <b>The power is OFF.</b> → Turn it ON. (See “Power On/Off” on page 8.)</li></ul>
<b>The PS does not ring.</b>	<ul style="list-style-type: none"><li>• <b>Ringer volume is set to “OFF”.</b> → Adjust the ringer volume level. (See “Ringer Volume Adjustment” on page 14.)</li></ul>
<b>You cannot make/receive a call.</b>	<ul style="list-style-type: none"><li>• <b>The PS is out of range or the Cell Station (CS) is busy.</b> → Move closer to the CS or try again later.</li><li>• <b>The radio channel is busy or a radio communication error occurred.</b> → Try again later.</li></ul>
<b>You cannot dial.</b>	<ul style="list-style-type: none"><li>• <b>The number which you dialled is restricted by the Business Telephone System.</b> → Consult your dealer.</li><li>• <b>The key lock mode is ON.</b> → To cancel the mode, press the joystick for about 2 seconds. (See “Key Lock” on page 15.)</li><li>• <b>The radio channel is busy or a radio communication error occurred.</b> → Try again later.</li></ul>
<b>Noise is frequently heard.</b>	<ul style="list-style-type: none"><li>→ Set the PS and CS away from other electrical appliances.</li><li>→ Move closer to the CS.</li></ul>
<b>“CS Busy” is displayed.</b>	<ul style="list-style-type: none"><li>• <b>The Cell Station is busy.</b> → Try again later.</li></ul>
<b>“PS Not Connected” is displayed.</b>	<ul style="list-style-type: none"><li>• <b>The called PS is out of range or is not turned on.</b> → Try again later.</li></ul>
<b>The PS stops working during operation.</b>	<ul style="list-style-type: none"><li>→ Turn the PS off, then turn it back on. (See “Power On/Off” on page 8.)</li><li>→ Reinsert the battery and try again. (See “Battery Installation” on page 7.)</li></ul>
<b>Two short beeps are heard during a conversation.</b>	<ul style="list-style-type: none"><li>• <b>The radio signal is weak.</b> → Move closer to the CS.</li></ul>



## ◆◆ Battery Information

After your Panasonic battery is fully charged [at 25 °C]:

Operation	Operating Time
While in use (TALK)	17 hrs approx.
While not in use (Standby)	270 hrs approx.

- Battery charge may be shortened depending on usage conditions and ambient temperature.
- The battery cannot be overcharged.
- The battery will drain even while the unit is turned off.
- The PS can receive calls while charging.
- Battery consumption increases when the PS is out of range. If “**Y**” flashes, turn off the PS.
- **Clean the handset and the charger contacts with a soft, dry cloth once a month. Clean more often if the unit is subject to grease, dust or high humidity.** Otherwise the battery may not charge properly.
- Read “Important Notice Concerning the Correct Use and Charging of Ni-MH Batteries.”

## ◆ Low Battery Warning

The battery needs to be charged when “**□**” flashes, or the alarm sounds every one minute during a conversation.\*

\* If the low battery warning occurs during a conversation, you can continue the call for a few minutes, after which the call will be automatically disconnected.

## ◆ Replacing the Battery

If “**□**” flashes after a few telephone calls even when the battery has been fully charged, it is time to replace the battery with new one.

- 1) Turn the power off to prevent memory loss.
- 2) Press the notch on the cover firmly and slide it as indicated by the arrow.

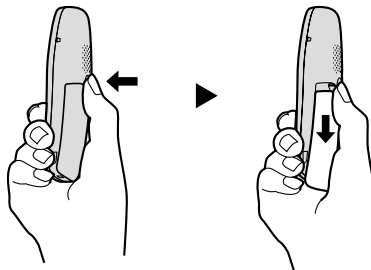

- 3) Open the cover and replace the battery.
- 4) Close the cover and charge the handset for more than 5.5 hours.

# Important Information

---

## **Please replace with Panasonic battery only.**

- Please order part number N4HHGMB00007 or HHR-P103.

If you replace the battery before the low battery warning appears, the battery strength icon may display an incorrect reading. In this case, use the PS as normal with the new battery installed. When the low battery warning is displayed, charge the battery for more than 5.5 hours. The battery strength icon will then display a correct reading.

### ◆ **Caution**

To reduce the risk of fire or injury to persons, read and follow these instructions.

- 1) Use only the battery specified.
- 2) Do not use non-rechargeable batteries.
- 3) Do not dispose of batteries in a fire. They may explode. Check with local waste management codes for special disposal instructions.
- 4) Do not open or mutilate the battery. Released electrolyte is corrosive and may cause burns or injury to the eyes or skin. The electrolyte may be toxic if swallowed.
- 5) Exercise care in handling the battery in order not to short the battery with conductive materials such as rings, bracelets, and keys. The battery and/or conductor may overheat and cause burns.
- 6) Charge the battery provided with or identified for use with this product only in accordance with the instructions and limitations specified in this manual.

### ◆ **Important Notice Concerning the Correct Use and Charging of Ni-MH Batteries**

Batteries, due to their construction, undergo some wear and tear. The lifetime of a battery also depends on correct maintenance. Charging and discharging are the most important factors. You should take notice of the following to maintain the life of the battery as long as possible.

Ni-MH batteries have a kind of memory, the “memory effect.” If fully charged batteries are used several times only for 15 minutes in the handset and then recharged, the capacity of the batteries will be reduced to 15 minutes due to the memory effect. Therefore you should discharge the batteries completely, i.e. use them in the handset until “” on the display starts flashing. Then recharge them as described in the manual. After the memory effect has occurred, it is possible to achieve almost complete capacity of the Ni-MH batteries by charging and discharging several times one after another.

Ni-MH batteries can also self-discharge. This self-discharge depends on the ambient temperature. At temperatures under 0 °C, the self-discharge will be the lowest. High humidity and high temperatures support the self-discharge. Also long-term storage will lead to self-discharge. A dead Ni-MH battery should not be disposed of normally. They contain toxic heavy metal hydride and therefore should be recycled.

## CAUTION

**RISK OF EXPLOSION IF BATTERY IS REPLACED  
BY AN INCORRECT TYPE.  
DISPOSE OF USED BATTERIES ACCORDING  
TO THE INSTRUCTIONS.**

### ◆◆ **Safety Instructions**

Pay special attention to the safety suggestions listed below.

#### ◆ **Safety**

To reduce the risk of fire or injury to persons, read and follow these instructions.

- 1) Use only the AC adaptor, battery and charger indicated in this manual.
- 2) Power source: The AC adaptor should be connected to a power supply only of the type as marked on the AC adaptor. The AC adaptor is used as the main disconnect device, ensure that the AC outlet is located/installed near the unit and is easily accessible.
- 3) Non use periods: When the PS is not being used, turn the power off. When left unused for a long period of time, the charger should be unplugged from the AC outlet.
- 4) Do not place metal items such as coins or rings on the charger. As they become hot, you might get burned if you touch them.
- 5) This product should not be used near emergency/intensive care medical equipment and should not be used by people with pacemakers.

#### ◆ **Installation**

##### **Environment**

- 1) Water and moisture: Do not use the PS and the charger near water — for example, near a bathtub, washbowl, sink, etc. Damp basements should also be avoided.
- 2) Heat: The PS and the charger should be kept away from heat sources such as radiators, kitchen ranges, etc. They also should not be placed in rooms where the temperature is less than 5 °C or greater than 40 °C.
- 3) The apparatus is designed to be installed and operated under controlled conditions of ambient temperature and a relative humidity.

##### **Placement**

- 1) Stacking: Do not place heavy objects on top of the PS and charger.
- 2) Foreign material: Care should be taken so that objects do not fall onto and liquids are not spilled into the PS and charger. Do not subject the PS and charger to excessive smoke, dust, mechanical vibration, or shock.
- 3) Surface: Place the charger on a flat surface. If the charger is mounted on the wall, install it straight.

# Important Information

---

## ◆ For best performance

### Operating Range

- 1) The range of operation depends on the topography of your office, weather or usage conditions, because signals are transmitted between the Cell Station (CS) and the PS by radio waves.
- 2) Normally, you get greater range outdoors than indoors. If there are obstacles such as walls, noise may interfere with your telephone calls. In particular, high metal shelves or reinforced concrete walls will restrict your operating range.
- 3) A PS may not work when it is too far from the CS depending on the structure of the building.

### Noise

Occasional noise or interference may occur due to electromagnetic radiation from objects such as refrigerators, microwave ovens, faxes, TVs, radios, or personal computers. If noise disturbs your telephone calls, keep the PS away from these electrical appliances.

We strongly suggest you hold the bottom half of the PS (as shown below) to ensure better call quality. Because, the antenna is located in the upper half of the PS.

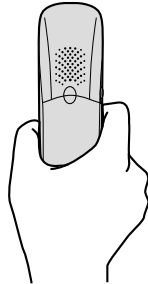

### **WARNING:**

UNPLUG THIS UNIT FROM THE AC OUTLET IF IT EMITS SMOKE, AN ABNORMAL SMELL OR MAKES UNUSUAL NOISE. THESE CONDITIONS CAN CAUSE FIRE OR ELECTRIC SHOCK. CONFIRM THAT SMOKE HAS STOPPED AND CONTACT AN AUTHORISED PANASONIC FACTORY SERVICE CENTRE.

TO PREVENT FIRE OR SHOCK HAZARD, DO NOT EXPOSE THIS PRODUCT TO RAIN OR ANY TYPE OF MOISTURE. TO REDUCE THE RISK OF ELECTRIC SHOCK, DO NOT DISASSEMBLE THIS UNIT. TAKE THE UNIT TO AN AUTHORISED SERVICE CENTRE WHEN SERVICE IS REQUIRED.

THE HANDSET IS MAGNETISED AND MAY RETAIN SMALL FERROUS OBJECTS.

## IMPORTANT NOTICE:

Under power failure conditions, this wireless telephone may not operate. Please ensure that a separate telephone, not dependent on local power, is available for emergency use in emergencies.

When a failure occurs which results in the internal parts becoming accessible, disconnect the AC adaptor immediately and return this unit to the place of purchase or service centre.

- This apparatus is designed to aid the visually handicapped to locate dial keys and buttons.
- 999 and 112 can be dialled on the apparatus after accessing the CO line for the purpose of making outgoing calls to the BT emergency (999) and (112) services.\*1
- This equipment shall not be set to make automatic calls to the Telecom '111' Emergency Service.\*2

\*1 The regulation applied in the United Kingdom only.

\*2 The regulation applied in New Zealand only.

## ◆ RF Specifications

Item	Description
Radio Access Method	Multi Carrier TDMA-TDD
Frequency Band	1880 MHz - 1900 MHz
Number of Carriers	10
Carrier Spacing	1728 kHz
Bit Rate	1152 kbps
Carrier Multiplex	TDMA, 24 (T×12, R×12) slots per frame
Frame Length	10 ms
Modulation	GFSK
Voice Coding	32 kbps ADPCM (CCITT G.721)
Transmission Output	Max. 250 mW

- Specifications are subject to change.
- The illustrations used in this manual may slightly differ from the original device.

# Important Information

---

## ◆◆ **Disposal Information**

### ◆ **Information on Disposal for Users of Waste Electrical & Electronic Equipment (private households)**



This symbol on the products and/or accompanying documents means that used electrical and electronic products should not be mixed with general household waste.

For proper treatment, recovery and recycling, please take these products to designated collection points, where they will be accepted on a free of charge basis. Alternatively, in some countries you may be able to return your products to your local retailer upon the purchase of an equivalent new product.

Disposing of this product correctly will help to save valuable resources and prevent any potential negative effects on human health and the environment which could otherwise arise from inappropriate waste handling. Please contact your local authority for further details of your nearest designated collection point. Penalties may be applicable for incorrect disposal of this waste, in accordance with national legislation.

### ◆ **For business users in the European Union**

If you wish to discard electrical and electronic equipment, please contact your dealer or supplier for further information.

### ◆ **Information on Disposal in other Countries outside the European Union**

This symbol is only valid in the European Union.

If you wish to discard this product, please contact your local authorities or dealer and ask for the correct method of disposal.



### **PTC200 General Warning**

1. The grant of a Telepermit for any item of terminal equipment indicates only that Telecom has accepted that the item complies with minimum conditions for connection to its network. It indicates no endorsement of the product by Telecom, nor does it provide any sort of warranty. Above all, it provides no assurance that any item will work correctly in all respects with another item of Telepermitted equipment of a different make or model, nor does it imply that any product is compatible with all of Telecom's network services.

### **PTC200 4.12 (2) (b) Handset Instability**

2. When attached to some longer lines this Panasonic KX-TCA256AL DECT Cordless Handset may display instability immediately after dialling if the handset is placed facedown on a hard surface. This is a temporary condition that will revert to a normal level after a short duration. Please do not report it to the Telecom Fault Service.

### **PTC200 6.11.1 (3) All Customer Equipment (fail safe requirements)**

3. Under power failure conditions this appliance may not operate. Please ensure that a separate telephone, not dependent on local power, is available for emergency use.

Following declaration is applicable to KX-TCA256CE/KX-TCA256E only

# CE 1321

This device is a DECT Portable station operating in the frequency band of 1880 MHz to 1900 MHz. The usage of this device is generally allowed in all the EU countries.

We, Panasonic Communications Company (U.K.) Ltd., declare that this equipment is in compliance with the essential requirements and other relevant provisions of Directive 1999/5/EC. If you want to get a copy of the original Declaration of Conformity of our products which relates to the R&TTE, please contact to our web address:

<http://www.doc.panasonic.de>

Contact:

Panasonic Services Europe  
a Division of Panasonic Marketing Europe GmbH  
Panasonic Testing Centre  
Winsbergring 15, 22525 Hamburg, Germany

### **Copyright:**

This material is copyrighted by Panasonic Communications Co., Ltd., and may be reproduced for internal use only. All other reproduction, in whole or in part, is prohibited without the written consent of Panasonic Communications Co., Ltd.

© 2006 Panasonic Communications Co., Ltd. All Rights Reserved.

**Panasonic Communications Company (U.K.) Ltd.**

Pencarn Way, Duffryn, Newport, South Wales, NP10 8YE, United Kingdom



## Free Manuals Download Website

<http://myh66.com>

<http://usermanuals.us>

<http://www.somanuals.com>

<http://www.4manuals.cc>

<http://www.manual-lib.com>

<http://www.404manual.com>

<http://www.luxmanual.com>

<http://aubethermostatmanual.com>

Golf course search by state

<http://golfingnear.com>

Email search by domain

<http://emailbydomain.com>

Auto manuals search

<http://auto.somanuals.com>

TV manuals search

<http://tv.somanuals.com>