

# DIGITAL-LOGIC

smart embedded computers

Detailed USER MANUAL FOR:

---

# MICROSPACE<sup>®</sup>

EBX

smartModule800/900

# MSEBX800/900



Nordstrasse 11/F  
CH - 4542 Luterbach  
Tel.: ++41 (0)32 681 58 00  
Fax: ++41 (0)32 681 58 01  
Email: [support@digitallogic.com](mailto:support@digitallogic.com)  
Homepage: <http://www.digitallogic.com>



*For internal use only:*

File: MSEBX800-900\_Detailed\_V1.0.doc

Path: R:\HANDBUCH\MSEBX\MSEBX800\MSEBX800-900\_Detailed\_V1.0.doc

## **COPYRIGHT © 2008 BY DIGITAL-LOGIC AG**

This publication is protected by copyright and all rights are reserved. No part of this document may be reproduced, transmitted, transcribed or stored in a retrieval system, in any form or by any means, electronic, mechanical, optical, manual, or otherwise, without the prior written permission of DIGITAL-LOGIC AG.

The software described herein, together with this document, are furnished under a license agreement and may be used or copied only in accordance with the terms of that agreement.

## **About this Manual and How to Use It**

This manual is written for the original equipment manufacturer (OEM) who plans to build computer systems based on the single board MICROSPACE-PC. It is for integrators and programmers of systems based on the MICROSPACE-Computer family. This manual provides instructions for installing and configuring the board, and describes the system and setup requirements. This document contains information on hardware requirements, interconnections, and details of how to program the system. Please check the Product CD for further information and manuals.

## **REVISION HISTORY:**

<b>Product Version</b>	<b>Document Version</b>	<b>Date/Initials:</b>	<b>Modification: Remarks, News, Attention:</b>
<i>V0.3</i>	<i>V1.0</i>	<i>05.2008 WAS</i>	<i>Initial Version</i>

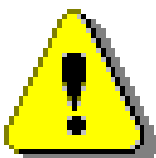

### ***Attention!***

1. All information in this manual, and the product, are subject to change without prior notice.
2. Read this manual prior to installation of the product.
3. Read the security information carefully prior to installation of the product.

## Table of Contents

<b>1. PREFACE .....</b>	<b>5</b>
1.1. Trademarks .....	5
1.2. Disclaimer .....	5
1.3. Environmental Protection Statement .....	5
1.4. Who should use this Product .....	5
1.5. Recycling Information.....	6
1.6. Technical Support .....	6
1.7. Limited Two Year Warranty .....	6
1.8. Explanation of Symbols.....	7
1.9. Applicable Documents and Standards .....	8
1.10. For Your Safety.....	9
1.11. RoHS Commitment.....	9
1.11.1. RoHS Compatible Product Design .....	10
1.11.2. RoHS Compliant Production Process .....	10
1.11.3. WEEE Application.....	10
1.12. Swiss Quality .....	11
1.13. The Swiss Association for Quality and Management Systems.....	11
<b>2. OVERVIEW .....</b>	<b>12</b>
2.1. Standard Features.....	12
2.2. Unique Features .....	12
2.3. Standards.....	12
2.4. Block Diagrams .....	13
2.4.1. MSEBX800 .....	13
2.4.2. SM800 .....	14
2.5. MSEBX800/900 Specifications .....	15
2.6. Examples of Ordering Codes.....	18
2.7. Dimensions & Diagrams.....	19
2.8. Incompatibilities to a Standard PC/AT .....	22
2.9. MSEBX800/900 Related Application Notes.....	22
2.10. High Frequency Radiation (to meet EN55022/EN61000) .....	22
2.11. Thermoscan .....	23
2.12. RTC Battery Lifetime.....	23
<b>3. PREPARATION.....</b>	<b>24</b>
3.1. Important Information .....	24
3.2. Mounting the smartModule .....	25
3.3. RAM Assembly/Disassembly .....	26
3.4. Power & Reset Buttons.....	28
<b>4. BUS SIGNALS .....</b>	<b>29</b>
4.1. PC104 Bus.....	29
4.2. Addressing PCI Devices on the MSEBX800:.....	31
<b>5. DETAILED SYSTEM DESCRIPTION.....</b>	<b>32</b>
5.1. Boot Time.....	32
5.2. Interfaces .....	33
5.2.1. PS/2 Keyboard (AT Compatible) and PS/2 Mouse .....	33
5.2.2. Line Printer Port LPT1 .....	33
5.2.3. Serial Ports COM1 - COM2 .....	33
5.2.4. Floppy Disk Interface.....	34
5.3. Controllers .....	35
5.3.1. Interrupt Controllers.....	35
5.3.2. Timers and Counters .....	35
5.3.3. Core BIOS Download .....	35
5.4. BIOS Recovery .....	36
<b>6. DESCRIPTION AND LOCATION OF THE CONNECTORS .....</b>	<b>37</b>
6.1. Connector Plan.....	38
6.2. Connector Descriptions.....	39
<b>7. JUMPER LOCATIONS ON THE BOARD.....</b>	<b>50</b>
7.1. The 2pin Jumpers.....	50

7.2. The 3pin Jumpers..... 50  
7.3. Jumpers on the MSEBX800..... 51  
8. INDEX .....52

# 1. PREFACE

The information contained in this manual has been carefully checked and is believed to be accurate; it is subject to change without notice. Product advances mean that some specifications may have changed. DIGITAL-LOGIC AG assumes no responsibility for any inaccuracies, or the consequences thereof, that may appear in this manual. Furthermore, DIGITAL-LOGIC AG does not accept any liability arising from the use or application of any circuit or product described herein.

## 1.1. Trademarks

DIGITAL-LOGIC, DIGITAL-LOGIC-Logo, MICROSPACE, and smartModule are registered trademarks owned worldwide by DIGITAL-LOGIC AG, Luterbach (Switzerland). In addition, this document may include names, company logos, and registered trademarks which are, therefore, proprietary to their respective owners.

## 1.2. Disclaimer

DIGITAL-LOGIC AG makes no representations or warranties with respect to the contents of this manual, and specifically disclaims any implied warranty of merchantability or fitness, for any particular purpose. DIGITAL-LOGIC AG shall, under no circumstances, be liable for incidental or consequential damages or related expenses resulting from the use of this product, even if it has been notified of the possibility of such damage.

## 1.3. Environmental Protection Statement

This product has been manufactured to satisfy environmental protection requirements wherever possible. Many of the components used (structural parts, printed circuit boards, connectors, batteries, etc.) are capable of being recycled. Final disposal of this product after its service life must be accomplished in accordance with applicable country, state, or local laws or regulations.

## 1.4. Who should use this Product

- Electrical engineers with know-how in PC-technology.
- Because of the complexity and the variability of PC-technology, we cannot guarantee that the product will work in any particular situation or set-up. Our technical support will try to help you find a solution.
- Pay attention to electrostatic discharges; use a CMOS protected workplace.
- Power supply must be OFF when working on the board or connecting any cables or devices.

## 1.5. Recycling Information

All components within this product fulfill the requirements of the RoHS (Restriction of Hazardous Substances Directive). The product is soldered with a lead free process.

## 1.6. Technical Support

1. Contact your local DIGITAL-LOGIC Technical Support, in your country.
2. Use the Internet Support Request form at <http://support.digitallogic.ch/> → embedded products → New Support Request

***Support requests are only accepted with detailed information about the product (i.e., BIOS-, Board-version)!***

## 1.7. Limited Two Year Warranty

DIGITAL-LOGIC AG guarantees the hardware and software products it manufactures and produces to be free from defects in materials and workmanship for two years following the date of shipment from DIGITAL-LOGIC AG, Switzerland. This warranty is limited to the original purchaser of the product and is not transferable.

During the two year warranty period, DIGITAL-LOGIC AG will repair or replace, at its discretion, any defective product or part at no additional charge, provided that the product is returned, shipping prepaid, to DIGITAL-LOGIC AG. All replaced parts and products become property of DIGITAL-LOGIC AG.

**Before returning any product for repair, direct customers of DIGITAL-LOGIC AG, Switzerland are required to register a RMA (Return Material Authorization) number in the Support Center at <http://support.digitallogic.ch/>**

**All other customers must contact their local distributors for returning defective materials.**

This limited warranty does not extend to any product which has been damaged as a result of accident, misuse, abuse (such as use of incorrect input voltages, wrong cabling, wrong polarity, improper or insufficient ventilation, failure to follow the operating instructions that are provided by DIGITAL-LOGIC AG or other contingencies beyond the control of DIGITAL-LOGIC AG), wrong connection, wrong information or as a result of service or modification by anyone other than DIGITAL-LOGIC AG. Nor if the user has insufficient knowledge of these technologies or has not consulted the product manuals or the technical support of DIGITAL-LOGIC AG and therefore the product has been damaged.

Empty batteries (external and onboard), as well as all other battery failures, are not covered by this manufacturer's limited warranty.

Except, as directly set forth above, no other warranties are expressed or implied, including, but not limited to, any implied warranty of merchantability and fitness for a particular purpose, and DIGITAL-LOGIC AG expressly disclaims all warranties not stated herein. Under no circumstances will DIGITAL-LOGIC AG be liable to the purchaser or any user for any damage, including any incidental or consequential damage, expenses, lost profits, lost savings, or other damages arising out of the use or inability to use the product.

## 1.8. Explanation of Symbols



### **CE Conformity**

*This symbol indicates that the product described in this manual is in compliance with all applied CE standards.*



### **Caution, Electric Shock!**

*This symbol and title warn of hazards due to electrical shocks (> 60V) when touching products or parts of them. Failure to observe the precautions indicated and/or prescribed by the law may endanger your life/health and/or result in damage to your equipment.*

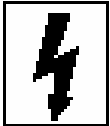

### **Caution, Electric Shock!**

*This symbol and title warn of hazards due to electrical shocks (> 32V) when touching products or parts of them. Failure to observe the precautions indicated and/or prescribed by the law may endanger your life/health and/or result in damage to your equipment.*



### **Warning, ESD Sensitive Device!**

*This symbol and title inform that electronic boards and their components are sensitive to Electro Static Discharge (ESD). In order to ensure product integrity at all times, care must always be taken while handling and examining this product.*



### **Attention!**

*This symbol and title emphasize points which, if not fully understood and taken into consideration by the reader, may endanger your health and/or result in damage to your equipment.*



### **Note...**

*This symbol and title emphasize aspects the user should read through carefully for his, or her, own advantage.*



### **Warning, Heat Sensitive Device!**

*This symbol indicates a heat sensitive component.*



### **Safety Instructions**

*This symbol shows safety instructions for the operator to follow.*



*This symbol warns of general hazards from mechanical, electrical, and/or chemical failure. This may endanger your life/health and/or result in damage to your equipment.*

## 1.9. Applicable Documents and Standards

The following publications are used in conjunction with this manual. When any of the referenced specifications are superseded by an approved revision, that revision shall apply. All documents may be obtained from their respective organizations.

- Advanced Configuration and Power Interface Specification Revision 2.0c, August 25, 2003 Copyright © 1996-2003 Compaq Computer Corporation, Intel Corporation, Microsoft Corporation, Phoenix Technologies Ltd., Toshiba Corporation. All rights reserved. <http://www.acpi.info/>
- ANSI/TIA/EIA-644-A-2001: Electrical Characteristics of Low Voltage Differential Signaling (LVDS) Interface Circuits, January 1, 2001. <http://www.ansi.org/>
- ANSI INCITS 361-2002: AT Attachment with Packet Interface - 6 (ATA/ATAPI-6), November 1, 2002. <http://www.ansi.org/>
- ANSI INCITS 376-2003: American National Standard for Information Technology – Serial Attached SCSI (SAS), October 30, 2003. <http://www.ansi.org/>
- Audio Codec '97 Revision 2.3 Revision 1.0, April 2002 Copyright © 2002 Intel Corporation. All rights reserved. <http://www.intel.com/labs/media/audio/>
- Display Data Channel Command Interface (DDC/CI) Standard (formerly DDC2Bi) Version 1, August 14, 1998 Copyright © 1998 Video Electronics Standards Association. All rights reserved. <http://www.vesa.org/summary/sumddcci.htm>
- ExpressCard Standard Release 1.0, December 2003 Copyright © 2003 PCMCIA. All rights reserved. <http://www.expresscard.org/>
- IEEE 802.3-2002, IEEE Standard for Information technology, Telecommunications and information exchange between systems–Local and metropolitan area networks–Specific requirements – Part 3: Carrier Sense Multiple Access with Collision Detection (CSMA/CD) Access Method and Physical Layer Specifications. <http://www.ieee.org>
- IEEE 802.3ae (Amendment to IEEE 802.3-2002), Part 3: Carrier Sense Multiple Access with Collision Detection (CSMA/CD) Access Method and Physical Layer Specifications, Amendment: Media Access Control (MAC) Parameters, Physical Layers, and Management Parameters for 10 GB/s Operation. <http://www.ieee.org>
- Intel Low Pin Count (LPC) Interface Specification Revision 1.1, August 2002 Copyright © 2002 Intel Corporation. All rights reserved. <http://developer.intel.com/design/chipsets/industry/lpc.htm>
- PCI Express Base Specification Revision 1.1, March 28, 2005, Copyright © 2002-2005 PCI Special Interest Group. All rights reserved. <http://www.pcisig.com/>
- PCI Express Card Electromechanical Specification Revision 1.1, March 28, 2005, Copyright © 2002-2005 PCI Special Interest Group. All rights reserved. <http://www.pcisig.com/>
- PCI Local Bus Specification Revision 2.3, March 29, 2002 Copyright © 1992, 1993, 1995, 1998, 2002 PCI Special Interest Group. All rights reserved. <http://www.pcisig.com/>
- PCI-104 Specification, Version V1.0, November 2003. All rights reserved. <http://www.pc104.org>
- PICMG® Policies and Procedures for Specification Development, Revision 2.0, September 14, 2004, PCI Industrial Computer Manufacturers Group (PICMG®), 401 Edgewater Place, Suite 500, Wakefield, MA 01880, USA, Tel: 781.224.1100, Fax: 781.224.1239. <http://www.picmg.org/>
- Serial ATA: High Speed Serialized AT Attachment Revision 1.0a January 7, 2003 Copyright © 2000-2003, APT Technologies, Inc, Dell Computer Corporation, Intel Corporation, Maxtor Corporation, Seagate Technology LLC. All rights reserved. <http://www.sata-io.org/>



- Smart Battery Data Specification Revision 1.1, December 11, 1998. [www.sbs-forum.org](http://www.sbs-forum.org)
- System Management Bus (SMBus) Specification Version 2.0, August 3, 2000 Copyright © 1994, 1995, 1998, 2000 Duracell, Inc., Energizer Power Systems, Inc., Fujitsu, Ltd., Intel Corporation, Linear Technology Inc., Maxim Integrated Products, Mitsubishi Electric Semiconductor Company, Power-Smart, Inc., Toshiba Battery Co. Ltd., Unitrode Corporation, USAR Systems, Inc. All rights reserved. <http://www.smbus.org/>
- Universal Serial Bus Specification Revision 2.0, April 27, 2000 Copyright © 2000 Compaq Computer Corporation, Hewlett-Packard Company, Intel Corporation, Lucent Technologies Inc., Microsoft Corporation, NEC Corporation, Koninklijke Philips Electronics N.V. All rights reserved. <http://www.usb.org/>

## 1.10. For Your Safety

Your new DIGITAL-LOGIC product was developed and tested carefully to provide all features necessary to ensure its compliance with electrical safety requirements. It was also designed for a long, fault-free life. However, this life expectancy can be drastically reduced by improper treatment during unpacking and installation. Therefore, in the interest of your own safety and for the correct operation of your new DIGITAL-LOGIC product, please comply with the following guidelines.



### ***Attention!***

All work on this device must only be carried out by sufficiently skilled personnel.



### ***Caution, Electric Shock!***

Before installing your new DIGITAL-LOGIC product, always ensure that your mains power is switched off. This applies also to the installation of piggybacks or peripherals. Serious electrical shock hazards can exist during all installation, repair and maintenance operations with this product. Therefore, always unplug the power cable and any other cables which provide external voltage before performing work.



### ***Warning, ESD Sensitive Device!***

Electronic boards and their components are sensitive to static electricity. In order to ensure product integrity at all times, be careful during all handling and examinations of this product.

## 1.11. RoHS Commitment

DIGITAL-LOGIC AG is committed to develop and produce environmentally friendly products according to the Restriction of Hazardous Substances (RoHS) Directive (2002/95/EC) and the Waste Electrical and Electronic Equipment (WEEE) Directive (2002/96/EC) established by the European Union. The RoHS directive was adopted in February 2003 by the European Union and came into effect on July 1, 2006. It is not a law but a directive, which restricts the use of six hazardous materials in the manufacturing of various types of electronic and electrical equipment. It is closely linked with the Waste Electrical and Electronic Equipment Directive (WEEE) 2002/96/EC, which has set targets for collection, recycling and recovery of electrical goods and is part of a legislative initiative to solve the problem of huge amounts of toxic e-waste.

Each European Union member state is adopting its own enforcement and implementation policies using the directive as a guide. Therefore, there could be as many different versions of the law as there are states in the EU. Additionally, non-EU countries like China, Japan, or states in the U.S. such as California may have their own regulations for green products, which are similar, but not identical, to the RoHS directive.

RoHS is often referred to as the "lead-free" directive but it restricts the use of the following substances:

- Lead
- Mercury
- Cadmium
- Chromium VI
- PBB and PBDE

The maximum allowable concentration of any of the above mentioned substances is 0.1% (except for Cadmium, which is limited to 0.01%) by weight of homogeneous material. This means that the limits do not apply to the weight of the finished product, or even to a component but to any single substance that could (theoretically) be separated mechanically.

### **1.11.1. RoHS Compatible Product Design**

All DIGITAL-LOGIC standard products comply with RoHS legislation.

Since July 1, 2006, there has been a strict adherence to the use of RoHS compliant electronic and mechanical components during the design-in phase of all DIGITAL-LOGIC standard products.

### **1.11.2. RoHS Compliant Production Process**

DIGITAL-LOGIC selects external suppliers that are capable of producing RoHS compliant devices. These capabilities are verified by:

1. A confirmation from the supplier indicating that their production processes and resulting devices are RoHS compliant.
2. If there is any doubt of the RoHS compliancy, the concentration of the previously mentioned substances in a produced device will be measured. These measurements are carried out by an accredited laboratory.

### **1.11.3. WEEE Application**

The WEEE directive is closely related to the RoHS directive and applies to the following devices:

- Large and small household appliances
- IT equipment
- Telecommunications equipment (although infrastructure equipment is exempt in some countries)
- Consumer equipment
- Lighting equipment – including light bulbs
- Electronic and electrical tools
- Toys, leisure and sports equipment
- Automatic dispensers

It does not apply to fixed industrial plants and tools. The compliance is the responsibility of the company that brings the product to market, as defined in the directive. Components and sub-assemblies are not subject to product compliance. In other words, since DIGITAL-LOGIC does not deliver ready-made products to end users the WEEE directive is not applicable for DIGITAL-LOGIC. Users are nevertheless encouraged to properly recycle all electronic products that have reached the end of their life cycle.

## 1.12. Swiss Quality

- 100% Made in Switzerland
- DIGITAL-LOGIC is a member of "Swiss-Label"
- This product was **not** manufactured by employees earning piecework wages
- This product was manufactured in humane work conditions
- All employees who worked on this product are paid customary Swiss market wages and are insured
- ISO 9000:2001 (quality management system)

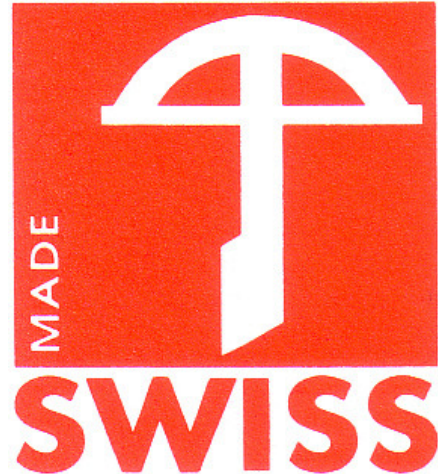

## 1.13. The Swiss Association for Quality and Management Systems

The Swiss Association for Quality and Management Systems (SQS) provides certification and assessment services for all types of industries and services. SQS certificates are accepted worldwide thanks to accreditation by the Swiss Accreditation Service (SAS), active membership in the International Certification Network, IQNet, and co-operation contracts/agreements with accredited partners.

[www.sqs.ch](http://www.sqs.ch)

The SQS Certificate ISO 9001:2000 has been issued to DIGITAL-LOGIC AG, the entire company, in the field of development, manufacturing and sales of embedded computer boards, embedded computer modules and computer systems. The certification is valid for three years at which time an audit is performed for recertification.

## 2. OVERVIEW

### 2.1. Standard Features

The MICROSPACE EBX is a miniaturized modular device incorporating the major elements of a PC/AT compatible computer. It includes standard PC/AT compatible elements, such as:

- Powerful GEODE LX800/900 with 500/600MHz
- DDRAM 128-1024MByte SODIMM 200pin
- Real-time clock with CMOS-RAM and 10-year battery buffer
- LPT1 parallel port
- COM1-, COM2- RS232 serial port 16C550 comp.
- Speaker interface
- PS/2-keyboard and mouse interface
- Floppy disk interface
- AT-IDE hard disk interface
- VGA video interface, LCD, LVDS
- 6-channel sound interface AC97-V2.3
- 100/10-Base-T LAN
- PC/104 (ISA) BUS optional
- 4 Ports USB V2.0
- PC/104plus (PCI) BUS optional

### 2.2. Unique Features

The MICROSPACE MSEBX800 includes all standard PC/AT functions plus unique DIGITAL-LOGIC AG enhancements, such as:

- Single 8V to 30V supply
- Watchdog
- EEPROM for setup and configuration
- 2<sup>nd</sup> LAN Port 100Base-T
- PATA ports optional
- UL approved parts
- Console redirection

### 2.3. Standards

The MICROSPACE product meet all standards for personal computer architecture.

Standard	Contact to the organisation	Remarks
PC/104BUS	<a href="http://www.pc104.org">www.pc104.org</a>	
USB	<a href="http://www.usb.org">www.usb.org</a>	
PCI	<a href="http://www.pcisig.com">www.pcisig.com</a>	
SMB	<a href="http://www.smbus.org">www.smbus.org</a>	
WfM	<a href="http://www.intel.com/labs/manage/wfm">www.intel.com/labs/manage/wfm</a>	Wired for management baseline
AC97	<a href="http://www.developer.intel.com/ial/scalableplatforms/audio">www.developer.intel.com/ial/scalableplatforms/audio</a>	
LPC	<a href="http://www.developer.intel.com/design/chipsets/industry/lpc.htm">www.developer.intel.com/design/chipsets/industry/lpc.htm</a>	
ATA/ATAPI-6	<a href="http://www.t13.org">www.t13.org</a>	
ACPI	<a href="http://www.acpi.info">www.acpi.info</a>	Power management

## 2.4. Block Diagrams

### 2.4.1. MSEBX800

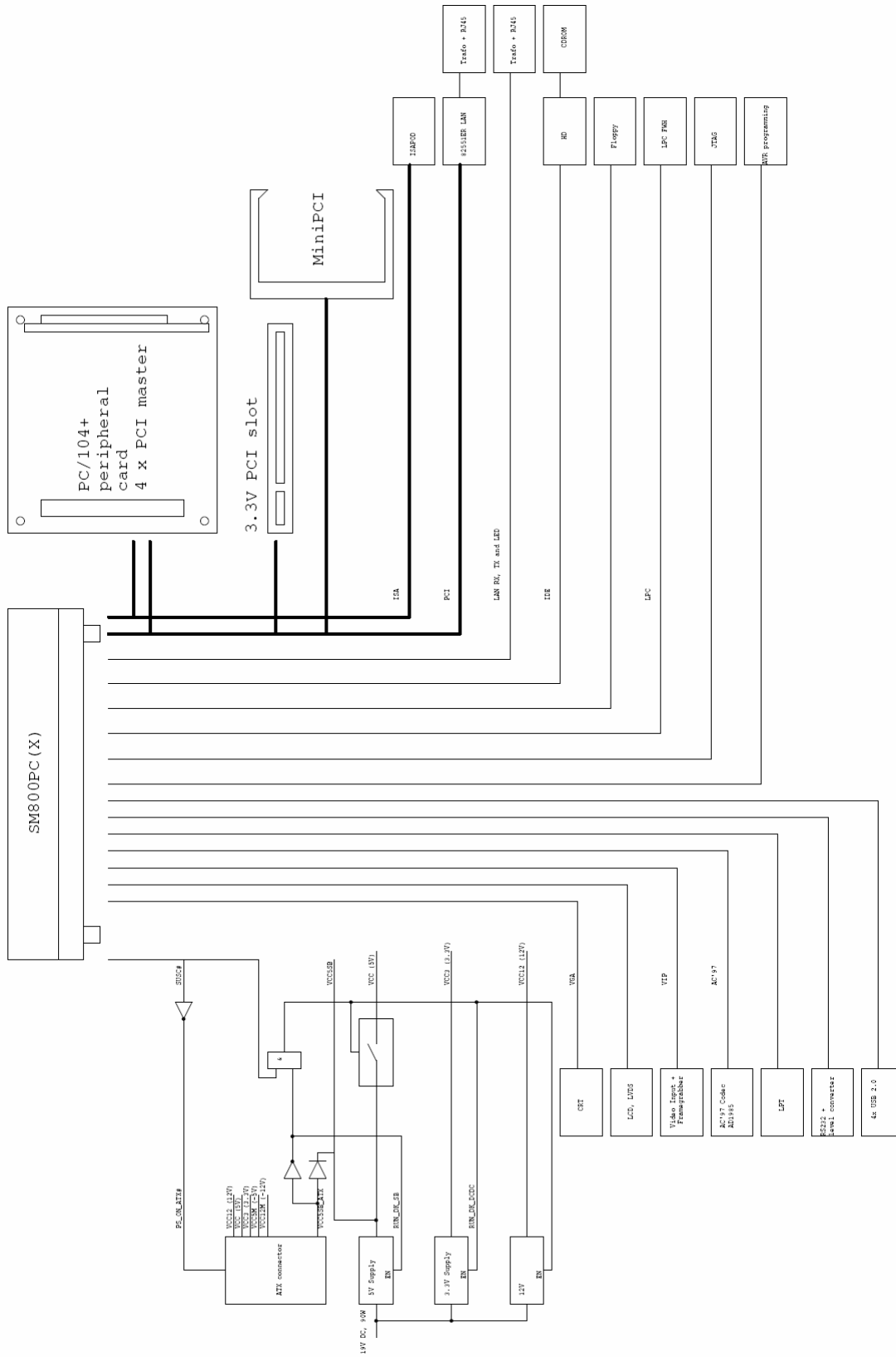

2.4.2. **SM800**

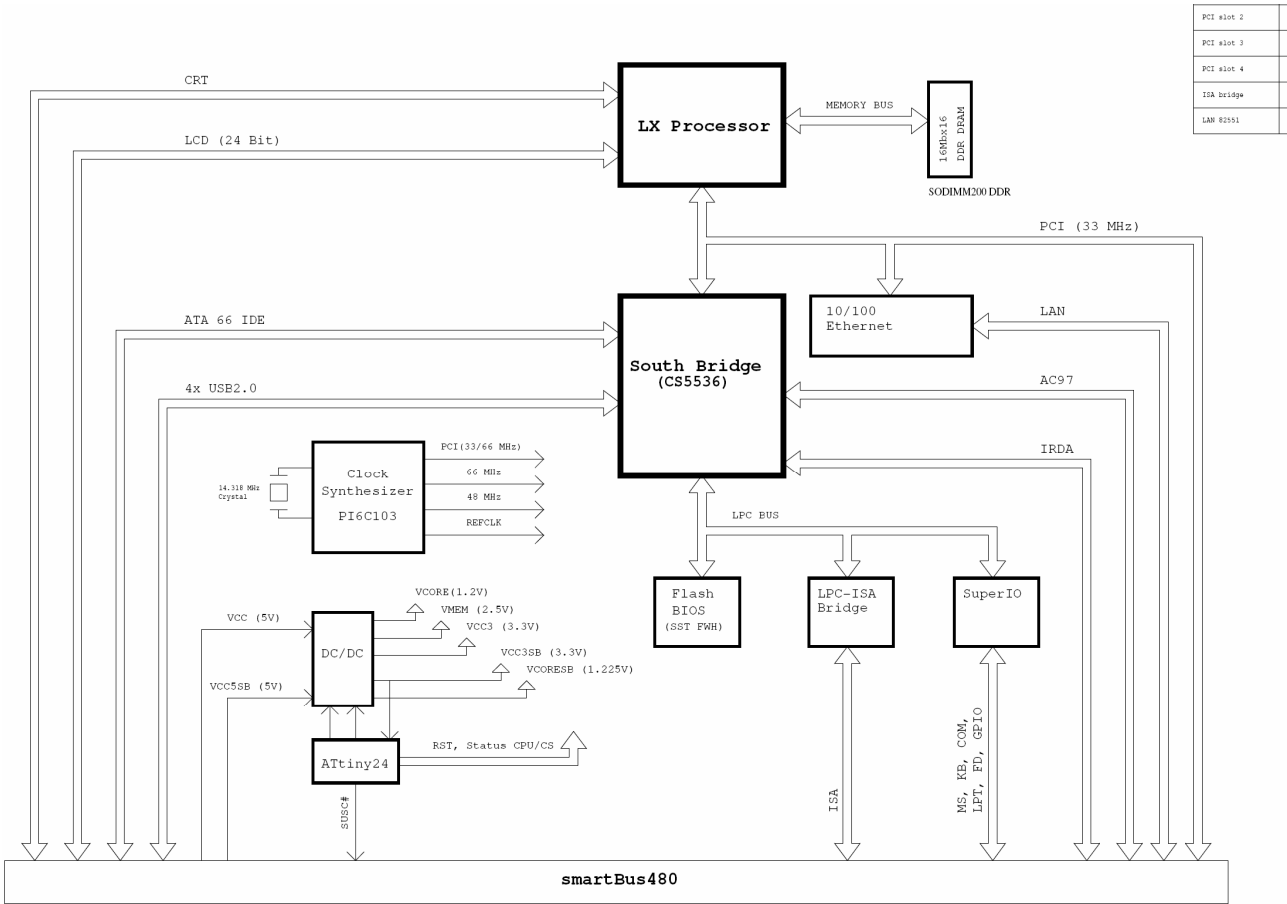

## 2.5. MSEBX800/900 Specifications

CPU	Specification
CPU SM800	AMD GEODE LX800/900 located in the smartModule800/900
CPU Core Supply	1.25V very low powered
1 <sup>st</sup> Level Cache	32k data and 32k code
2 <sup>nd</sup> Level Cache	128kByte
Performance SM800PCX SM900PCX	P2 Equivalent Performance: 500MHz 600MHz
Clock SM800PCX SM900PCX	The CPU Clock is defined with the ordered SM800/900-xxx 500MHz 600MHz

Chipset	Specification
Northbridge	AMD LX800/900
Southbridge	AMD CS5536
LAN	2x 10/100Mbit Intel 82551ER (LAN A), Intel 82551ER (LAN B)
Audio	Stereo In and Stereo Line-Out
Codec	AD1985 up to 96kHz sampling rate, 16bit (Analog Devices)
Firewire IEEE1394	Not on board
Video	16MByte Video-DDRAM

Memory	Specification
SODIMM	SODIMM200pin DDR PC2700 333MHz 256-1024MByte
Flash-BIOS	8MByte Flash
Setup EEPROM	2kByte for CMOS-backup in battery-less applications
Flash-Video BIOS	Combined in the core BIOS
Video RAM	16MByte to 64MByte DDRAM

Video Controller	Specification
Controller	AMD graphics integrated in the LX800/900 chipset
Video Memory	16MB
Channel 1	CRT VGA up to 2048x1600 pixels
Channel 2	LVDS, TV-Out, CRT
Bootup-Resolution	640x480 / 800x600 / 1024x768
2D-Graphics	Integrated accelerator
3D-Graphics	None
Direct-X Version	-
PnP	Integrated

External Interfaces	Specification
Video Interfaces	CRT1, DVO
USB V1.1/2.0	4 Ports
LPT	IEEE1293 Printer
COM1	RS232
COM2	RS232
COM3	-
COM4	-
Keyboard	PS/2
Mouse	PS/2
Floppy	26pin FCC Interface for TEAC Mini-Floppy
Parallel-Hard disk 2.5"	2 x 44pin RM2.0mm ATAIDE-cable
Parallel-Hard disk 3.5"	2 x 40pin RM2.5mm PATA-IDE cable
Speaker	0.1Watt Speaker
ISA-Bus	PC/104
PCI-Bus	PC/104plus
PCI-Riser-Bus	PCI-Slot

Power Supply	Specification
Input voltage	Nominal 8V-30V, maximum Ripple=200mVpp
Input inrush current	t.b.d.
Protection	EMI filtered
Spec.	None
3.3Volt Power Output	Not available

Power Consumption	Specification
With 256MByte	Typical (10W) at 500MHz Typical (11W) at 600MHz
Standby	Typical 0.5 Amp.
Power off (if VCC 12V)	Typical 7.3mA
Power off (if VCC 19V)	Typical 8.6mA
Power off (if VCC 24V)	Typical 9.6mA

Physical Characteristics	Specification PC/104plus
Dimensions	Length: 203mm Depth: 146mm Height: 33mm
Weight	300gr

Operating Environment	Specification
Relative Humidity	5 - 90% non-condensing IEC68-2-30 at -20° to +50°C operating
Vibration operating	IEC68-2-6 10-50Hz, 0.075mm and 55-500Hz, 1.0G
Vibration non-operating	IEC68-2-6 10-50Hz, 0.15mm and 55-500Hz, 2.0G
Shock operating	IEC68-2-27 10G, 11ms ½ sine
Shock non-operating	IEC68-2-27 50G, 11ms, ½ sine
Altitude	IEC68-2-13 4571meter operating
Temperature operating	IEC68-2-1,2,14: MSEBX800 Standard -20°C to +60°C
Extended Temp. option	MIL-810-501/502 see separate table below
Temperature storage	IEC68-2-1,2,14-65°C to +125°C ★

★ The backup battery is limited on -40°C to +80°C operating and storage temperature!



<b>Operating Temperature</b>	<b>Specification:</b> <b>MIL-810-501</b> <b>MIL-810-502</b>
Extended temperature range: SM800PCX (500MHz)	-40 °C to +70 °C

<b>Security</b>	
e1	Not planned
UL	Not planned
ETS 301	Not planned
CE/SEV	Yes
Safety	AR385-16

If all signals are externally filtered and assembled into an enclosed metallic case!

<b>EMI / EMC Tests</b>	<b>Specification</b>
EMC emission EN61000-6-2:2001	
Conducted disturbance	EN55022 Class B
Radiated disturbance	EN55022 Class B
EMC immunity EN61000-6-2	
Electrostatic discharge (ESD)	EN61000-4-2 Voltage = 4kV contact / 8kV air, Criteria A
Radiated RF-Field	EN61000-4-3 Level = 10V/m, Criteria A
Electrical fast transients (Burst)	EN61000-4-4 Grade 2: DC-Power lines = 1000V (5/50ns) Grade 2: AC-Power lines = 2000V (5/50ns) Grade 2: Signal lines = 500V (5/50ns) Criteria B
Surge	EN61000-4-5 Grade 2: DC-Power lines = 1kV, (1.2/50us) Grade 2: AC-Power lines = 2kV, (1.2/50us) Criteria B
Conducted disturbances	EN61000-4-6 Voltage = 10V coupled by case, Criteria A

**All information is subject to change without notice.**

## 2.6. Examples of Ordering Codes

The MSEBX800 system is combined from:

Baseboard MSEBX800

smartModule 800/900-xxx *(must be ordered separately)*

Memory: SODIMM200-DDRAM *(must be ordered separately)*

Article	Part No.	Description
MSEBX800	811060	EBX board without SM800/900-xxx, 0MB RAM, no PC/104-Plus connector
SM800PCX	805212	LX800
SM900PCX	805242	LX900
Accessories	Part No.	Description
MSFloppy	891001	3.5" Micro-Floppy drive (26Pin)
MSFDCK	802600	Micro-Floppy cable (26Pin)
MSEBX800-DK	811210	Aluminium housing with 20GB HDD, FDD, CD-R, PSU
Options	Part No.	Description
Option L+	807006	PC/104- Plus, connector long (without option CF)
DDRAM256M	890670	DDR-SODIMM Module 256MB
DDRAM512M	890671	DDR-SODIMM Module 512MB
DDRAM1G	890672	DDR-SODIMM Module 1GB

*These are only examples; for current ordering codes, please see the current price list.*

## 2.7. Dimensions & Diagrams

### MSEBX800

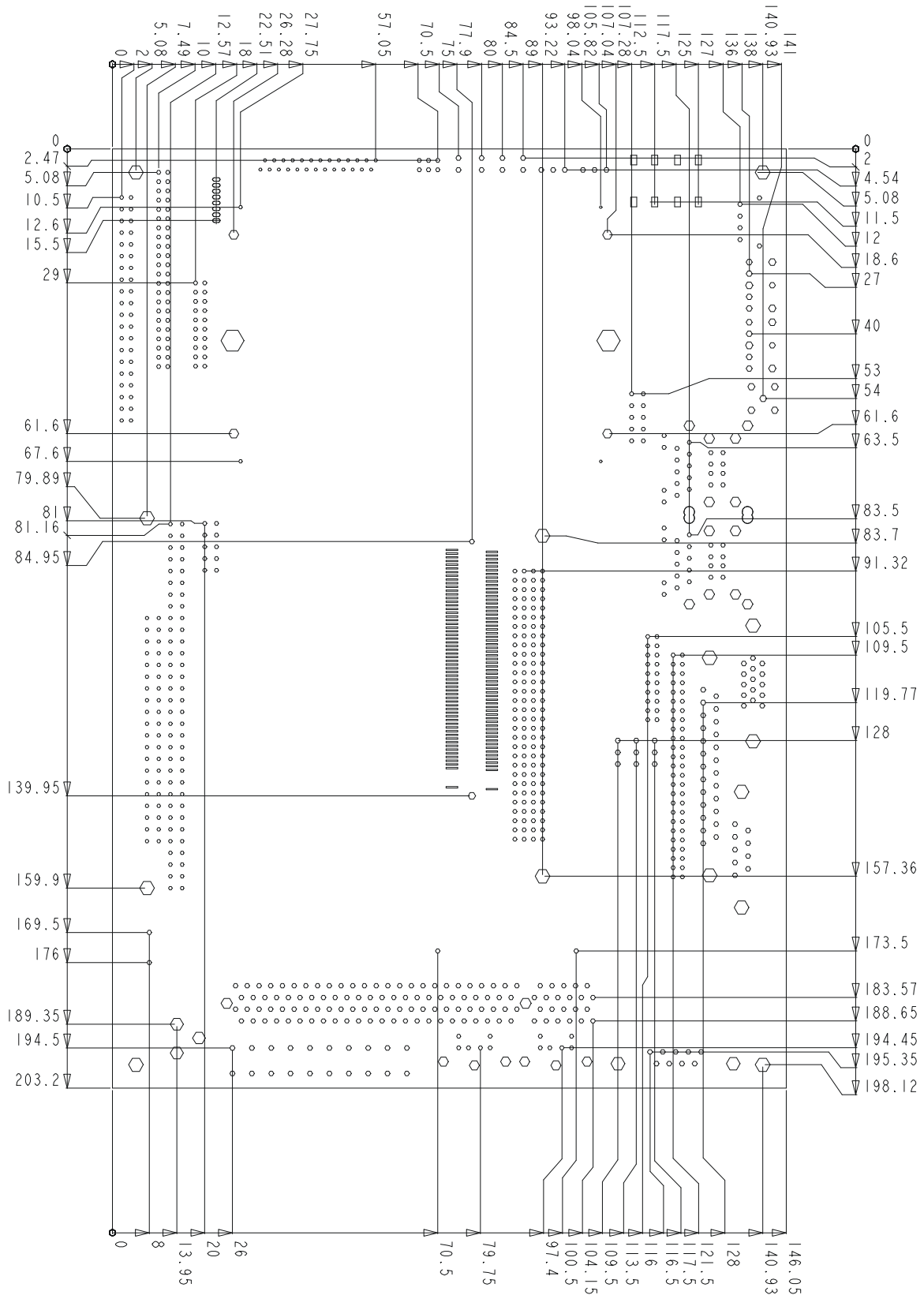

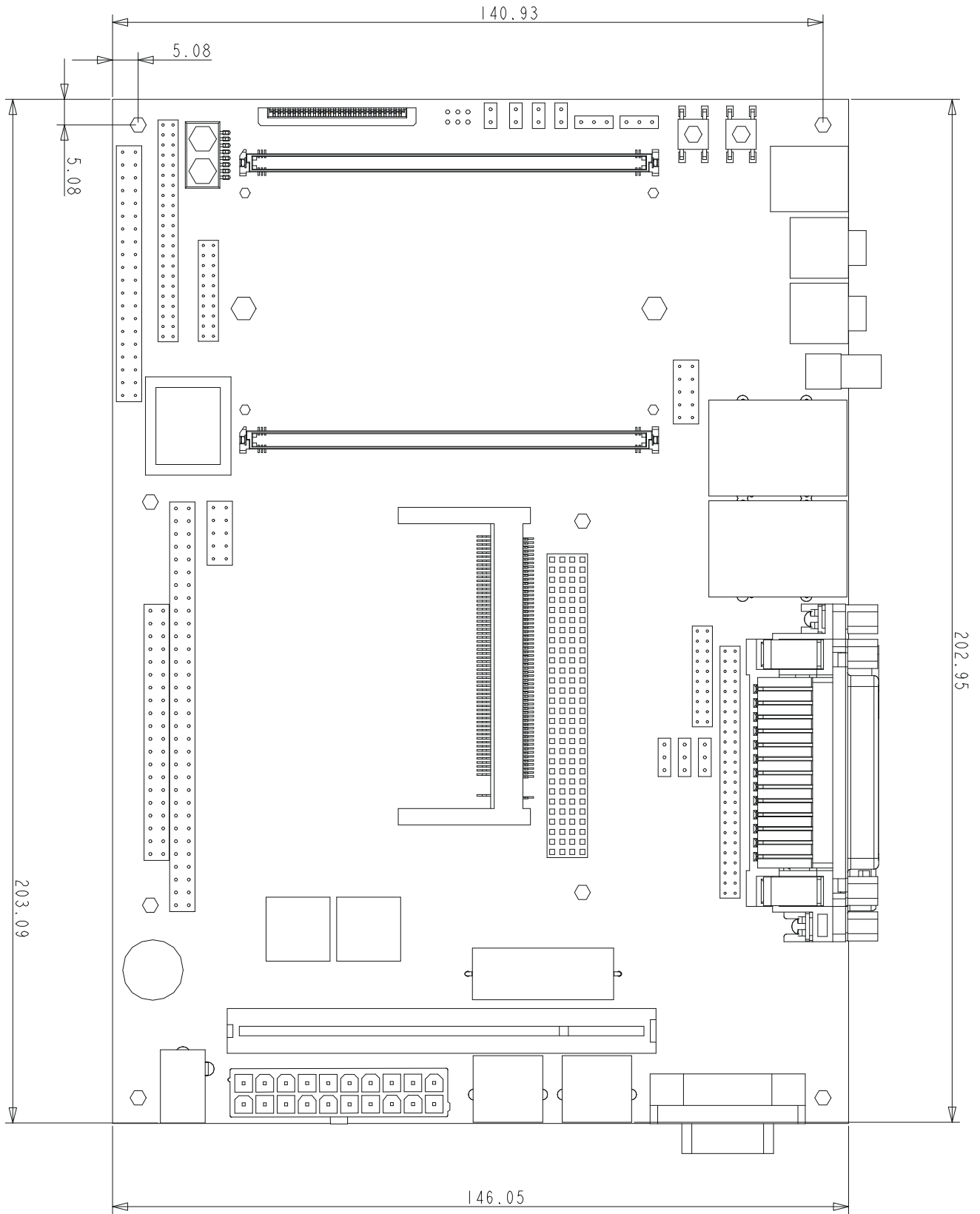

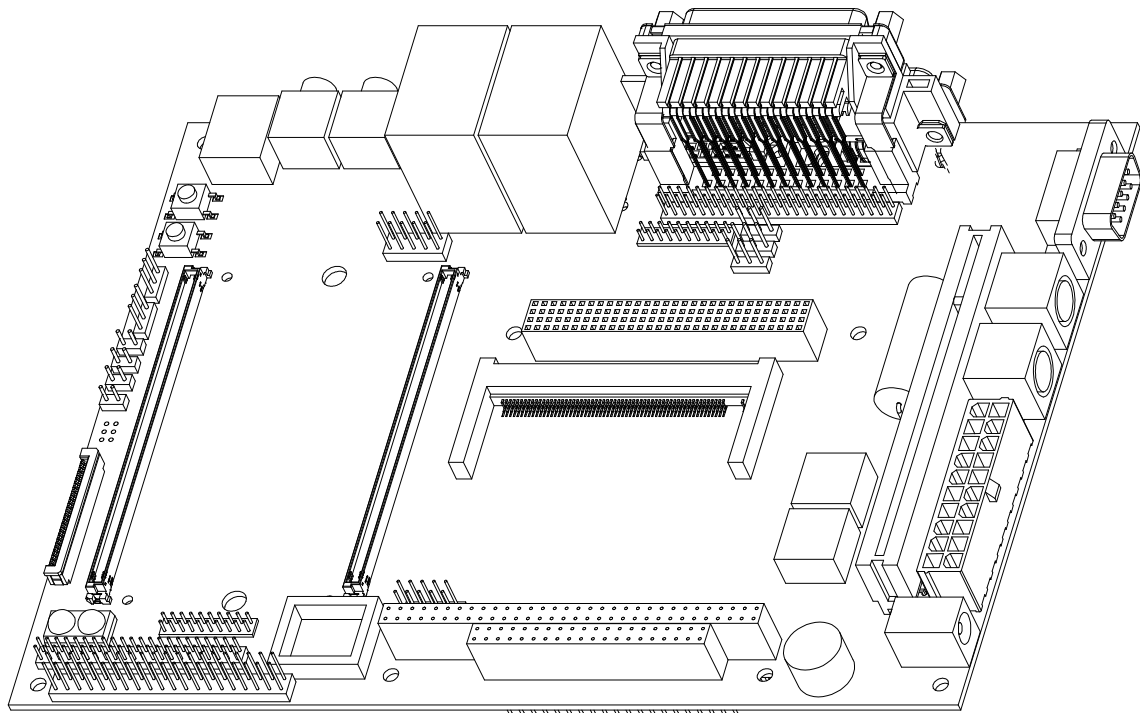
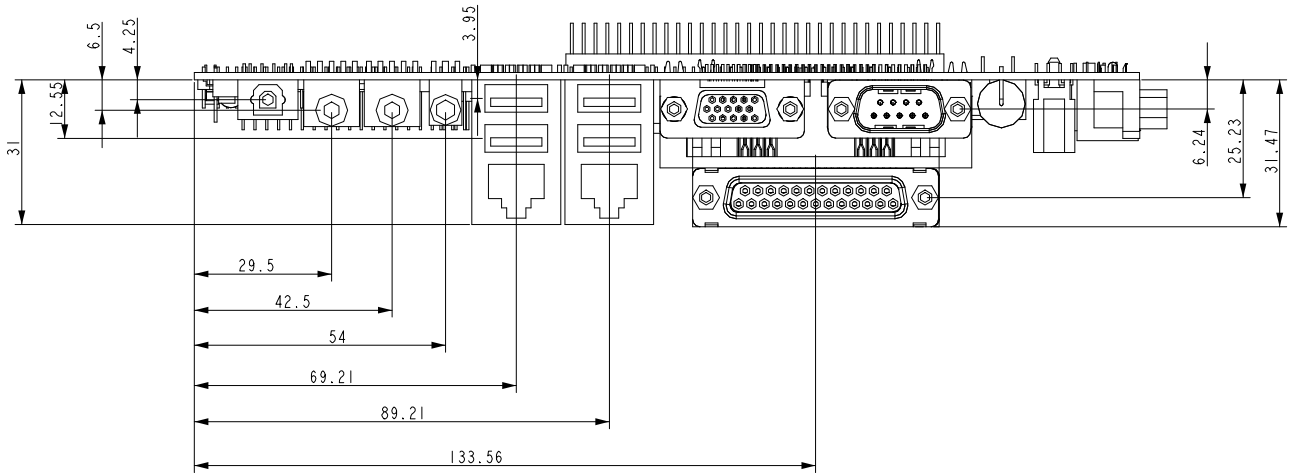
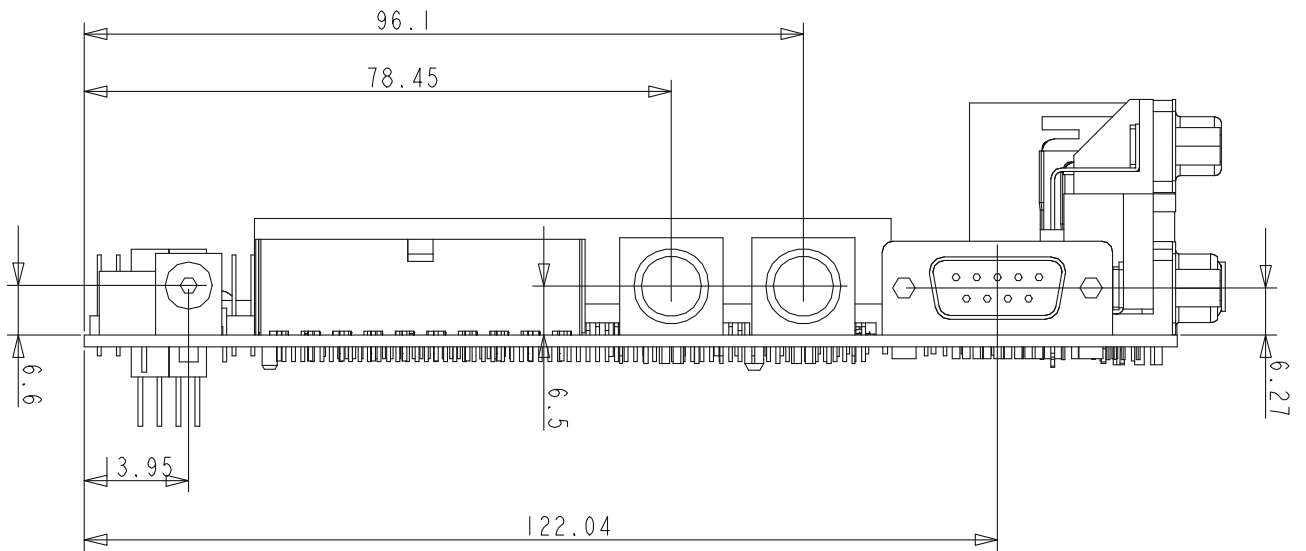

## 2.8. Incompatibilities to a Standard PC/AT

None.

## 2.9. MSEBX800/900 Related Application Notes

#	Description
80	High frequency Radiation (to meet EN55022)

→ *Application Notes are available at <http://www.digitallogic.com> → support, or on any Application CD from DIGITAL-LOGIC.*

## 2.10. High Frequency Radiation (to meet EN55022/EN61000)

All peripheral interfaces are filtered to meet the EMI/EMC standards EN55022.

## 2.11. Thermoscan

Product	Part Number	Serial Number	Version
MSEBX800	811202	45320210010	0.2
SM800PCX	805164	45316410032	2.1
SODIMM DDR 1GB	870672	-	-
Software	Windows XP SP2 running desktop		

Top view, passive cooled:

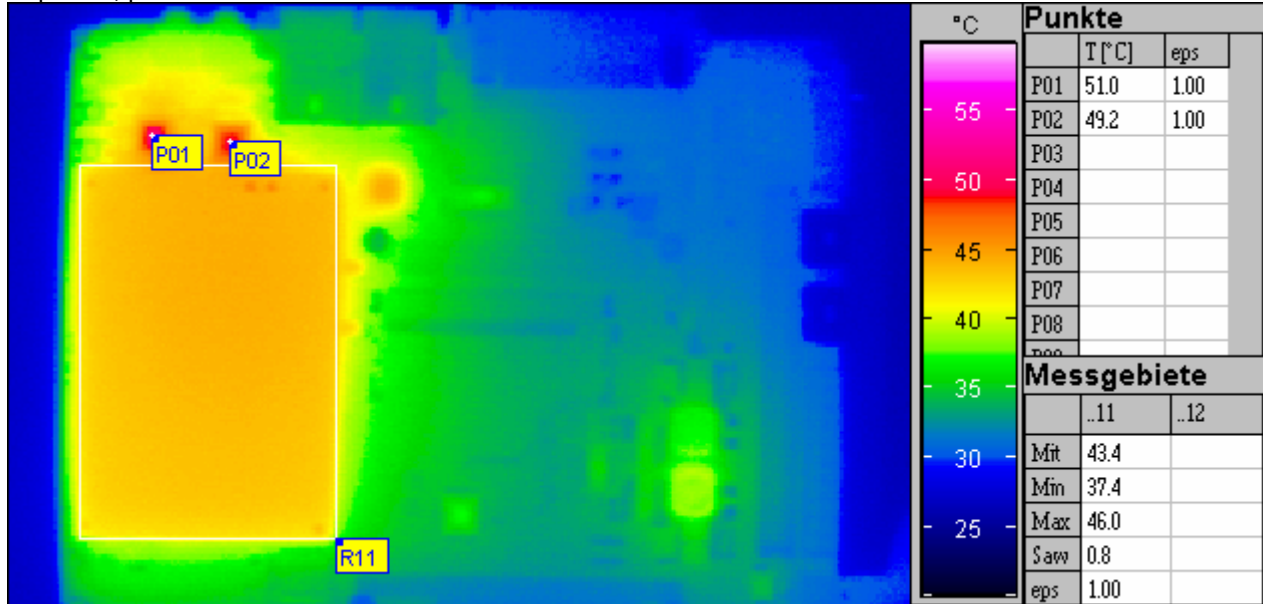

t [min]	fCPU [MHz]	I [A]	P [W]
60	500	0.5	9.5

## 2.12. RTC Battery Lifetime

Battery Specifications		Lowest Temp. -40°C	Nominal Temp. +20°C	Highest Temp. +85°C
Manufacturer	pbq			
Type	ER10280			
Capacity versus Temp.	8uA	850mAh	910mAh	850mAh
Voltage versus Temp.	8uA	3.5V	3.6V	Ca. 3.6V
Nominal Values	3.6V / 450mAh / -40°C...~+85°C			

Information is taken from the data sheet of the pbq ER10280.

Product	Temperature °C	Battery Voltage V	VCC (+12V) switched ON µA	VCC (+12V) switched off µA
MSEBX800				
Battery Current	+25°C	3.6	15	18
	-40°C	3.5	15	14
	+85°C	3.8	15	30
Battery Lifetime	+25°C		>10 years	>10 years
	-40°C		>10 years	>10 years
	+85°C		>10 years	Ca. 6 years

## 3. PREPARATION

### 3.1. Important Information



***Warning, ESD Sensitive Device!***

Place the embedded computer board on an isolated, ESD-protected surface. Also ensure that all equipment, tools and people are fully protected against ESD.



***Attention!***

**The smartModule must be firmly attached to the board with screws.** Do *not* attempt to power-up the system without taking this step or the system may not work and you risk damaging the equipment! See Section 3.2 for assembly instructions.



## 3.2. Mounting the smartModule

Line up the holes in the smartModule on the MSEBX board (top side). Then on the reverse side, attach the smartModule using 4 Phillips head screws (circled in red, within the red frame marking the approximate location of the smartModule). The screws are delivered with the smartModule but if lost may be ordered: Part Nr. 502528, description: M2x 5 galvanized machine screw.

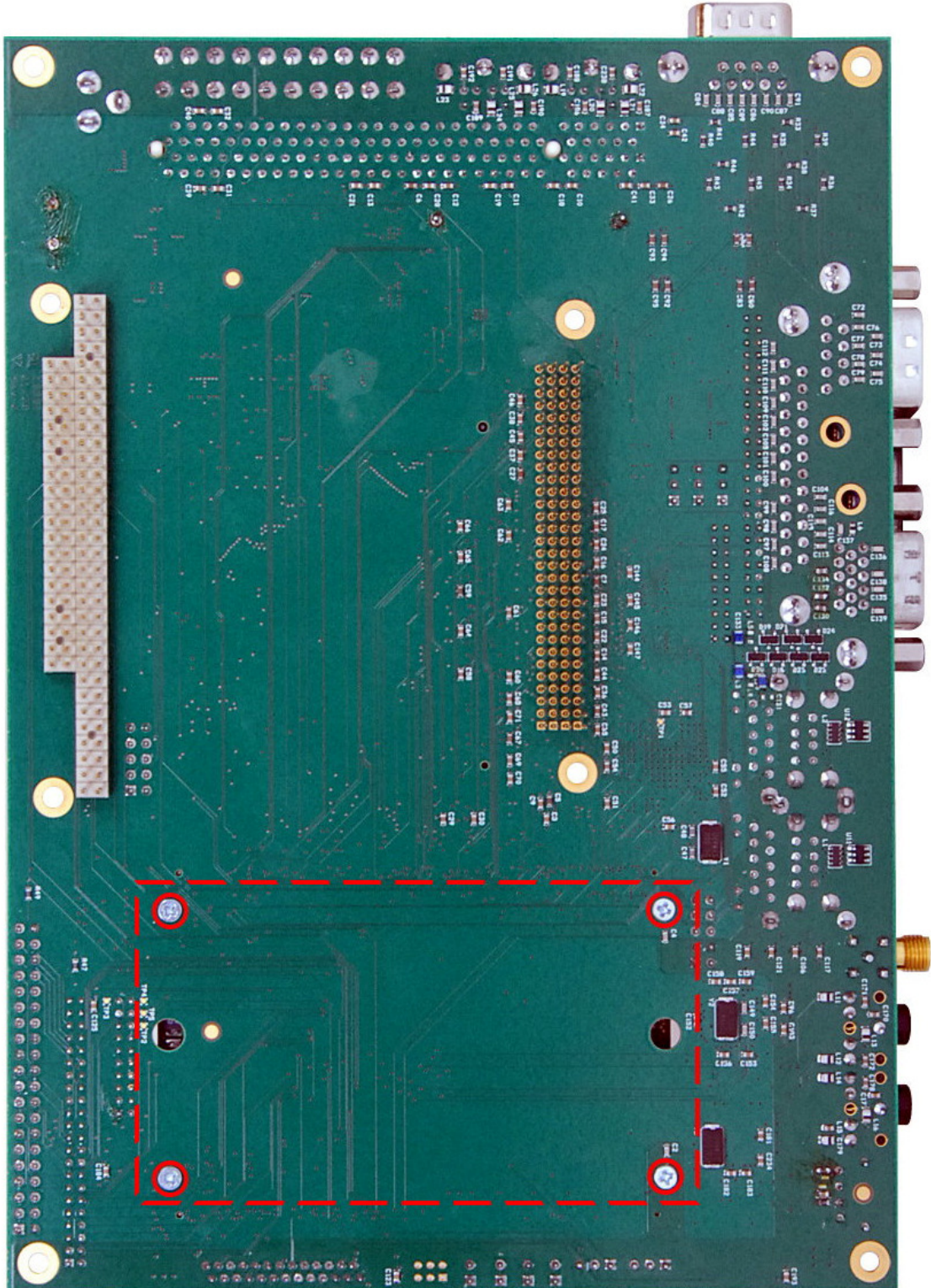

### 3.3. RAM Assembly/Disassembly

To install or change the RAM, follow these steps:

1. Unmount the smartModule by removing the 4 screws marked in red (see the photo from the previous page).
2. To change the RAM:
  - a. Using your thumbnails, gently push the clips holding the RAM module in place toward the outside (Photo 1, marked "A").

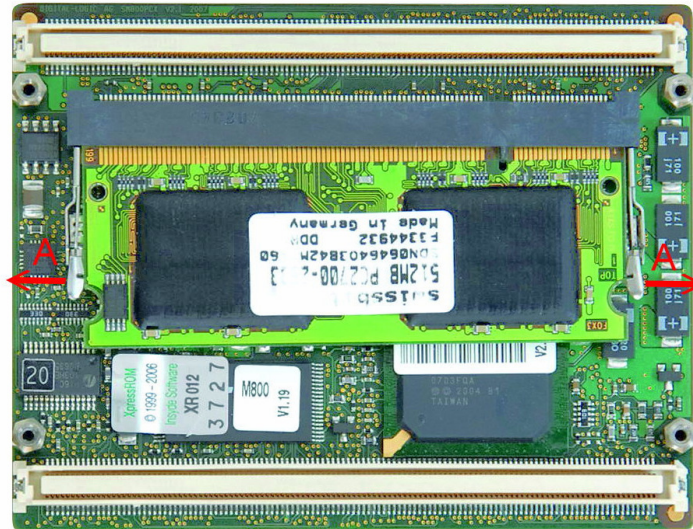

Photo 1

- b. There will be a slight "click" and the RAM will flip up at an angle (Photo 2).



Photo 2

- c. Remove the original RAM.
    - d. With the new RAM, carefully place the side with the connectors into the slot. There is only one correct way to place the RAM in the slot due to a notch between the connectors which matches up to a tab in the slot. Do **not** force the RAM into the slot, it should fit very easily.



- e. Slowly push the RAM down until the clips "click" into place (Photo 3).

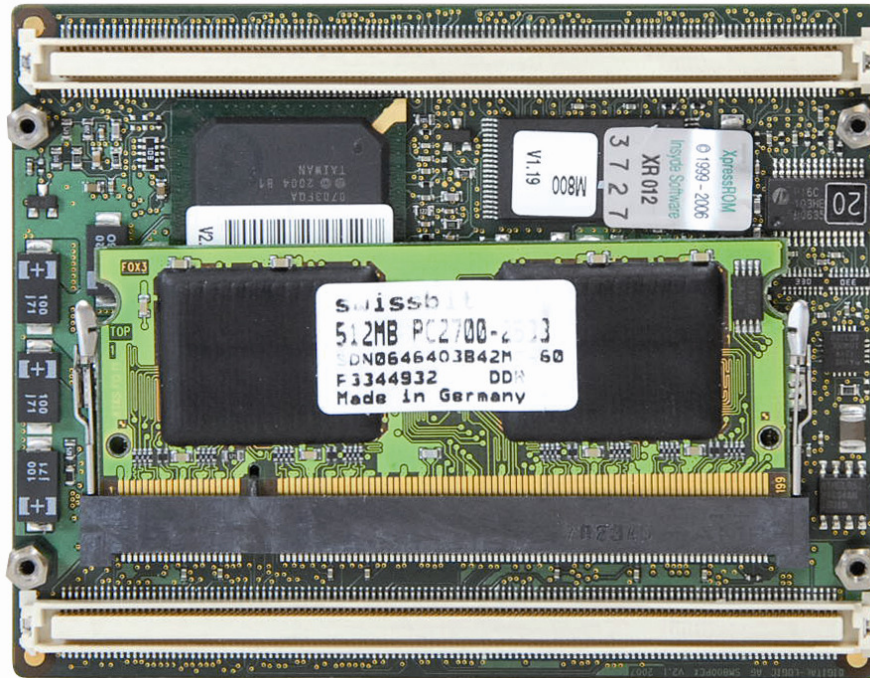
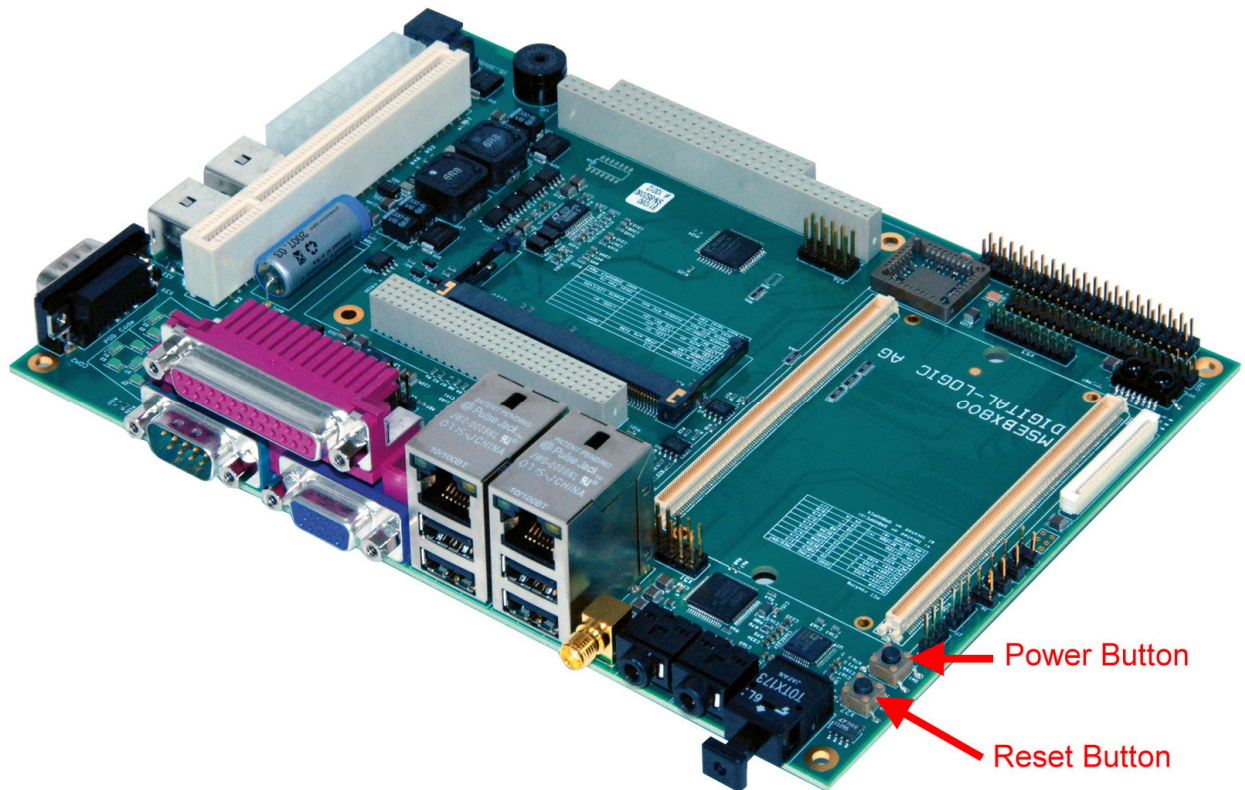

Photo 3

3. To install a RAM:
  - a. Carefully place the side of the RAM with the connectors into the slot. There is only one correct way to place the RAM in the slot due to a notch between the connectors which matches up to a tab in the slot. Do **not** force the RAM into the slot, it should fit very easily.
  - b. Slowly push the RAM down until the clips "click" into place (Photo 3).

### 3.4. Power & Reset Buttons



**Power Button:** Push the Power Button for 2 seconds to start up the system.

**Reset Button:** Should the system hang, press the Reset Button.

## 4. BUS SIGNALS

### 4.1. PC104 Bus



**Note...**

The ISA-Bus may have some minor incompatibilities, see Chapter 6.

**AEN, output**

Address Enable: used to degate the microprocessor and other devices from the I/O channel to allow DMA transfers to take place. **low = CPU Cycle, high = DMA Cycle**

**BALE, output**

Address Latch Enable: provided by the bus controller and used on the system board to latch valid addresses and memory decodes from the microprocessor. This signal is used so that devices on the bus can latch LA17-23. The SA0-19 address lines latch internally according to this signal. BALE is forced high during DMA cycles.

**/DACK[0-3, 5-7], output**

DMA Acknowledge: 0 to 3 and 5 to 7 are used to acknowledge DMA requests (DRQ0 through DRQ7). They are **active low**. This signal indicates that the DMA operation can begin.

**DRQ[0-3, 5-7], input**

DMA Requests: 0 through 3 and 5 through 7 are asynchronous channel requests used by peripheral devices and the I/O channel microprocessors to gain DMA service (or control of the system). A request is generated by bringing a DRQ line to an active level. A DRQ line must be held high until the corresponding DMA Request Acknowledge (DACK/) line goes active. DRQ0 through DRQ3 will perform 8bit DMA transfers; DRQ5-7 are used for 16 accesses.

**/IOCHCK, input**

IOCHCK/: provides the system board with parity (error) information about memory or devices on the I/O channel. **low = parity error, high = normal operation**

**IOCHRDY, input**

I/O Channel Ready: pulled low (not ready) by a memory or I/O device to lengthen I/O or memory cycles. Any slow device using this line should drive it low immediately upon detecting its valid address and a Read or Write command. Machine cycles are extended by an integral number of one clock cycle (67 nanoseconds). This signal should be held in the range of 125-15600nS. **low = wait, high = normal operation**

**/IOCS16, input**

I/O 16 Bit Chip Select: signals the system board that the present data transfer is a 16bit, 1 wait-state, I/O cycle. It is derived from an address decode. /IOCS16 is **active low** and should be driven with an open collector (300 Ohm pull-up) or tri-state driver capable of sinking 20mA. The signal is driven based only on SA15-SAO (not /IOR or /IOW) when AEN is not asserted. In the 8bit I/O transfer, the default transfers a 4 wait-state cycle.

**/IOR, input/output**

I/O Read: instructs an I/O device to drive its data onto the data bus. It may be driven by the system microprocessor or DMA controller, or by a microprocessor or DMA controller resident on the I/O channel. This signal is active low.

**/IOW, input/output**

I/O Write: instructs an I/O device to read the data on the data bus. It may be driven by any microprocessor or DMA controller in the system. This signal is **active low**.

**IRQ [3-7, 9-12, 14, 15], input**

These signals are used to tell the microprocessor that an I/O device needs attention. An interrupt request is generated when an IRQ line is **raised from low to high**. The line must be held high until the microprocessor acknowledges the interrupt request.

**/Master, input**

This signal is used with a DRQ line to gain control of the system. A processor or DMA controller on the I/O channel may issue a DRQ to a DMA channel in cascade mode and receive a /DACK.

**/MEMCS16, input**

MEMCS16 Chip Select: signals the system board if the present data transfer is a 1 wait-state, 16bit, memory cycle. It must be derived from the decode of LA17 through LA23. /MEMCS16 should be driven with an open collector (300 Ohm pull-up) or tri-state driver capable of sinking 20mA.

**/MEMR, input/output**

These signals instruct the memory devices to drive data onto the data bus. /MEMR is active on all memory read cycles. /MEMR may be driven by any microprocessor or DMA controller in the system. When a microprocessor on the I/O channel wishes to drive /MEMR, it must have the address lines valid on the bus for one system clock period before driving /MEMR active. These signals are **active low**.

**/MEMW, input/output**

These signals instruct the memory devices to store the data present on the data bus. /MEMW is active in all memory read cycles. /MEMW may be driven by any microprocessor or DMA controller in the system. When a microprocessor on the I/O channel wishes to drive /MEMW, it must have the address lines valid on the bus for one system clock period before driving /MEMW active. Both signals are **active low**.

**OSC, output**

Oscillator (OSC): a high-speed clock with a 70 nanosecond period (14.31818 MHz). This signal is not synchronous with the system clock. It has a 50% duty cycle. OSC starts 100µs after reset is inactive.

**RESETDRV, output**

Reset Drive: used to reset or initiate system logic at power-up time or during a low line-voltage outage. This signal is **active high**. When the signal is active all adapters should turn off or tri-state all drivers connected to the I/O channel. This signal is driven by the permanent Master.

**/REFRESH, input/output**

These signals are used to indicate a refresh cycle and can be driven by a microprocessor on the I/O channel. These signals are **active low**.

**SA0-SA19, LA17 - LA23 input/output**

Address bits 0 through 19 are used to address memory and I/O devices within the system. These 20 address lines allow access of up to 1MByte of memory. SA0 through SA19 are gated on the system bus when BALE is high and are latched on the falling edge of BALE. LA17 to LA23 are not latched and addresses the full 16MByte range. These signals are generated by the microprocessors or DMA controllers. They may also be driven by other microprocessor or DMA controllers that reside on the I/O channel. The SA17-SA23 are always LA17-LA23 address timings for use with the MSCS16 signal. This is advanced AT96 design. The timing is selectable with jumpers L<sub>Axx</sub> or S<sub>Axx</sub>.

**/SBHE, input/output**

Bus High Enable (system): indicates a transfer of data on the upper byte of the data bus, XD8 through XD15. Sixteen-bit devices use /SBHE to condition data-bus buffers tied to XD8 through XD15.

**SD[0-15], input/output**

These signals provide bus bits 0 through 15 for the microprocessor, memory, and I/O devices. D0 is the least significant bit and D15 is the most significant bit. All 8bit devices on the I/O channel should use D0 through D7 for communications to the microprocessor. The 16bit devices will use D0 through D15. To support 8bit devices, the data on D8 through D15 will be gated to D0 through D7 during 8bit transfers to these devices; 16bit microprocessor transfers to 8bit devices will be converted to two 8bit transfers.

**/SMEMR, input/output**

These signals instruct the memory devices to drive data onto the data bus for the first MByte. /SMEMR is active on all memory read cycles. /SMEMR may be driven by any microprocessor or DMA controller in the system. When a microprocessor on the I/O channel wishes to drive /SMEMR, it must have the address lines valid on the bus for one system clock period before driving /SMEMR active. The signal is **active low**.

**/SMEMW, input/output**

These signals instruct the memory devices to store the data present on the data bus for the first MByte. /SMEMW is active in all memory read cycles. /SMEMW may be driven by any microprocessor or DMA controller in the system. When a microprocessor on the I/O channel wishes to drive /SMEMW, it must have the address lines valid on the bus for one system clock period before driving /SMEMW active. Both signals are **active low**.

**SYSCLK, output**

This is an 8MHz system clock. It is a synchronous microprocessor cycle clock with a cycle time of 167 nanoseconds. The clock has a 66% duty cycle. This signal should only be used for synchronization.

**TC, output**

Terminal Count: provides a pulse when the terminal count for any DMA channel is reached. The TC completes a DMA-Transfer. This signal is expected by the onboard floppy disk controller. Do not use this signal because it is internally connected to the floppy controller.

**/OWS, input**

The Zero Wait State (/OWS) signal tells the microprocessor that it can complete the present bus cycle without inserting any additional wait cycles. In order to run a memory cycle to a 16bit device without wait cycles, /OWS is derived from an address decode gated with a Read or Write command. In order to run a memory cycle to an 8bit device with a minimum of one-wait states, /OWS should be driven active one system clock after the Read or Write command is active, gated with the address decode for the device. Memory Read and Write commands to an 8bit device are active on the falling edge of the system clock. /OWS is **active low** and should be driven with an open collector or tri-state driver capable of sinking 20mA.

**12V, +/- 5%**

This signal is used only for the flat panel supply.

**GROUND = 0V**

This is used for the entire system.

**VCC, +5V +/- 0.25V**

This is used to supply other PC/104 peripheral cards. Maximum current is 2Amp.

**For further information about PC/104 and PC/104plus, please refer to the PC/104 Specification Manual which is available on the internet: <http://www.digitallogic.com> (manuals).**

## 4.2. Addressing PCI Devices on the MSEBX800:

### PCI Slot Assignment

The following definitions for the peripherals correspond with the BIOS:

Device	IDSEL	PIRQ	REQ#	GNT#	Comments
SLOT 1	AD20	A, B, C, D	3	3	
SLOT 2	AD21	B, C, D, A	4	4	
SLOT 3	AD22	C, D, A, B	5	5	
SLOT 4	AD23	D, A, B, C	6	6	
LAN Controller	AD29	A	7	7	
ISA-Bridge	AD24	--	8	8	
CS5536	AD25	---	2	2	For VGA, IDE and USB
Arbiter 0	---	---	0	0	
Arbiter 1	---	---	1	1	

## 5. DETAILED SYSTEM DESCRIPTION

### 5.1. Boot Time

#### System Boot Times

Definitions/Boot-Medium	Quick Boot*	Normal Boot
MSEBX800-500MHz with RTC-Backup Battery Memory 256MB shared 8MB for Video	time [s]	
From Floppy disk		
Boot from Setup-Disk1 MS-DOS v6.22 to "Starting MS-DOS"-Prompt.	10	26
Boot from Setup-Disk1 MS-DOS v6.22 to "Welcome Setup Screen"-Prompt.	30	45
Boot from "(Sys a:)-Disk" to "A:/>"-Prompt.	18	33
From Hard disk-Toshiba MK2110MAF		
Boot from Hard disk to "Starting MS-DOS"-Prompt.	10	26
Boot from Hard disk to "Win2000: Windows-Login"-Prompt.	80	95
From CompactFlash SanDisk SDCFB-64-101-00 64MB		
Boot from CF to "Starting MS-DOS"-Prompt.	10	26
Boot from CF to "C:\>"-Prompt.	13	29



## 5.2. Interfaces

### 5.2.1. PS/2 Keyboard (AT Compatible) and PS/2 Mouse

#### X31 Keyboard

Pin	Signal	Pin	Signal
1	KB_Data	2	-
3	GND	5	+5Volt / 100mA
6	KB_Clk	8	-

#### X32 Mouse

Pin	Signal	Pin	Signal
1	MB_Data	2	-
3	GND	5	+5Volt / 100mA
6	MB_Clk	8	-

### 5.2.2. Line Printer Port LPT1

A standard bi-directional LPT port is integrated into the MICROSPACE PC.

Further information about these signals is available in numerous publications, including the IBM technical reference manuals for the PC and AT computers and from other reference documents.

The current is: IOH = 12mA IOL = 24mA

The SMC 37C672 may be programmed via software commands.

*In the new BIOS version, this selection may be controlled with the BIOS setup screen.*

### 5.2.3. Serial Ports COM1 - COM2

The serial channels are fully compatible with 16C550 UARTS.

#### X30B / X39 Serial Port Connectors COM1, COM2

Pin	Signal Name	Function	in/out	DB25 Pin	DB9 Pin
1	CD	Data Carrier Detect	in	8	1
2	RXD	Data Receive Data	in	6	6
3	TXD	Transmit Data	out	3	2
4	DTR	Data Terminal Ready	out	4	7
5	GND	System Ground	-	2	3
6	DSR	Data Set Ready	In	5	8
7	RTS	Request to Send	out	20	4
8	CTS	Clear to Send	in	22	9
9	RI	Ring Indicator	in	7	5

## 5.2.4. Floppy Disk Interface

### Supported Floppy Formats

Capacity	Drive size	Tracks	Data rate	DOS version
1.2 MB	5-1/4"	80	500 KHz	3.0 - 6.22
720 K	3-1/2"	80	250 KHz	3.2 - 6.22
1.44 M	3-1/2"	80	500 KHz	3.3 - 6.22

### Floppy Interface Configuration

The desired configuration of floppy drives (number and type) must be properly initialized in the board's CMOS – configuration memory. This is generally done by using **DEL** or **F2** at bootup time.

### Floppy Interface Connector

The table shows the pin-out and signal definitions of the board's floppy disk interface connector. It is identical in pin-out to the floppy connector of a standard AT. Note that, as in a standard PC or AT, both floppy drives are jumpered to the same drive select: as the 'second' drive. The drives are uniquely selected as a result of a swapping of a group of seven wires (conductors 10-16) that must be in the cable between the two drives. The seven-wire swap goes between the computer board and drive 'A'; the wires to drive 'B' are unswapped (or swapped a second time). The 26pin high density (1mm pitch FCC) connector has only one drive and motor select. The onboard jumper defines the drive A: or B:. Default is always A:.

### Floppy Disk Interface Technology

Only CMOS drives are supported. This means the termination resistors are 1 KOhm and 5 1/4"-drives are not recommended (TTL interface).

The 26pin connector: FFC/FPC 0.3mm thick 1.0mm (0.039") pitch (MOLEX 52030 Series)

### Floppy Disk Interface Connector

FD26: Pin	Signal Name	Function	in/out
1	VCC	+5Volt	
2	IDX	Index Pulse	in
3	VCC	+5Volt	
4	DS2	Drive Select 2	out
5	VCC	+5Volt	
6	DCHG	Disk Change	in
10	MO2	Motor On 2	out
12	DIRC	Direction Select	out
14	STEP	Step	out
16	WD	Write Data	out
17	GND	Signal grounds	
18	WE	Write Enable	out
19	GND	Signal grounds	
20	TRKO	Track 0	in
21	GND	Signal grounds	
22	WP	Write Protect	in
23	GND	Signal grounds	
24	RDD	Read Data	in
25	GND	Signal grounds	
26	HS	Head Select	out

## 5.3. Controllers

### 5.3.1. Interrupt Controllers

An 8259A compatible interrupt controller, within the chipset, provides seven prioritized interrupt levels. Of these, several are normally associated with the board's onboard device interfaces and controllers, and several are available on the AT expansion bus.

Interrupt	Sources	Used Onboard
IRQ0	ROM-BIOS clock tick function, from timer 0	Yes
IRQ1	Keyboard controller output buffer full	Yes
IRQ2	Used for cascade 2. 8259	Yes
IRQ3	COM2 serial port	Yes
IRQ4	COM1 serial port	Yes
IRQ5	LPT2 parallel printer (if present)	No *
IRQ6	Floppy controller	Yes
IRQ7	LPT1 parallel printer	Yes
IRQ8	Battery backed clock	Yes
IRQ9	Free for user	No *
IRQ10	Free for user	No *
IRQ11	Free for user	No *
IRQ12	PS/2 mouse	Yes
IRQ13	Math. coprocessor	Yes
IRQ14	Hard disk IDE / SCSI	Yes
IRQ15	Free for user	No **

\* It may depend on the LAN configuration.

\*\* IRQ 15 = if option CF is not assembled, then free for user.

### 5.3.2. Timers and Counters

#### 5.3.2.1. Programmable Timers

An 8253 compatible timer/counter device is also included in the board's ASIC device. This device is utilized in precisely the same manner as in a standard AT implementation. Each channel of the 8253 is driven by a 1.190MHz clock, derived from a 14.318MHz oscillator, which can be internally divided in order to provide a variety of frequencies.

Timer 2 can also be used as a general purpose timer if the speaker function is not required.

#### Timer Assignment

Timer	Function
0	ROM-BIOS clock tick (18.2Hz)
1	DRAM refresh request timing (15 $\mu$ s)
2	Speaker tone generation time base

#### 5.3.2.2. Watchdog

The watchdog timer detects a system crash and performs a hardware reset. After power up, the watchdog is always disabled as the BIOS does not send strobes to the watchdog. In case the user wants to take advantage of the watchdog, the application must produce a strobe at least every 800ms. If no strobe occurs within the 800ms, the watchdog resets the system.

### 5.3.3. Core BIOS Download

See the separate driver/software/BIOS manual, GEODE\_LX800-900.

## 5.4. BIOS Recovery

In case the BIOS needs to be recovered:

1. Set Jumper **J9**.
2. Start the MSEBX800/900.
3. Open the BIOS.
4. Remove Jumper **J9**.
5. Load the default BIOS settings.
6. Save the settings.
7. Restart the MSEBX800/900.

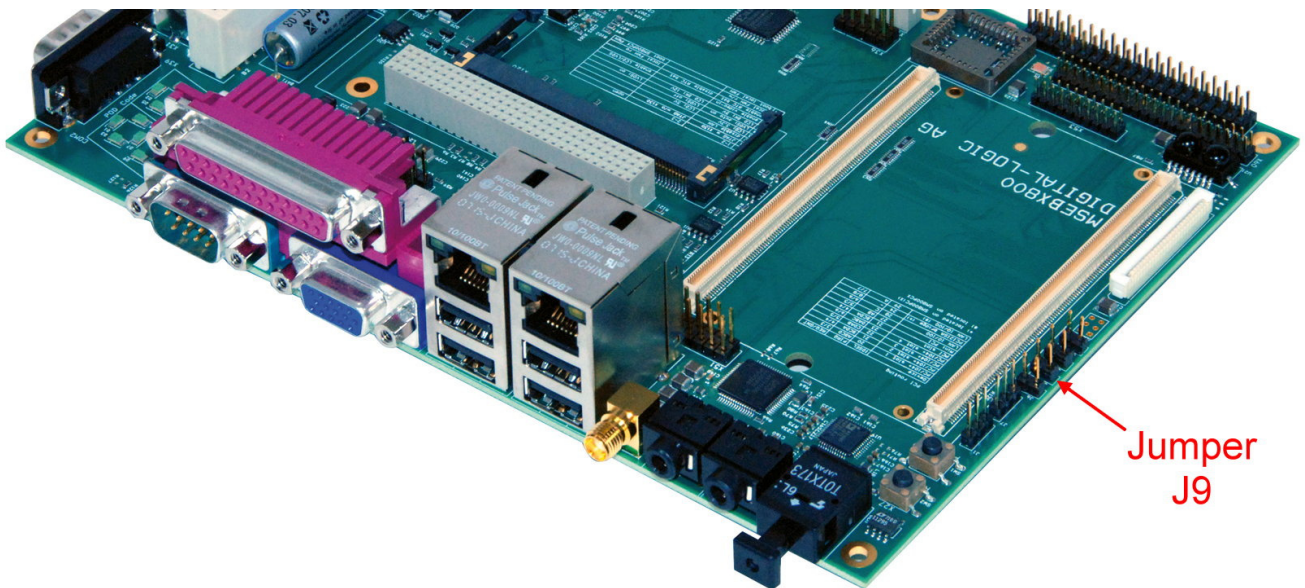

Jumper J9

## 6. DESCRIPTION AND LOCATION OF THE CONNECTORS

Connector	Structure	Pin	Remarks
X1	Power Input	2	Power Jack
X2	ATX Power Connector	20	
X11	LVDS	2x 10	RM2.54
X14	Video IN	2	SMA
X15	LCD	2x 25	RM2.54
X20	MIC IN	-	Phone Jack
X22	Line Out Front	-	Phone Jack
X27	SPDIF OUT	-	SPDIF
X30A	LPT	25	D-Sub25
X30B	COM 1	9	D-Sub 9
X30C	VGA	15	HDsub 15
X31	Keyboard	-	PS/2
X32	Mouse	-	PS/2
X33A	LAN A (LAN interface of SM800PCX)	8	RJ45
X33B	USB 0	4	-
X33C	USB 1	4	-
X34A	LAN B (82551ER – SM800DK)	8	RJ45
X34B	USB 2	4	-
X34C	USB 3	4	-
X36	ISA POD CPLD	2x 5	RM2.54
X39	COM 2	9	D-Sub 9
X51	JTAG	2x 5	RM2.54
X52	AVR Programming	2x 3	RM2.54
X53	Utility / Extension	2x 10	RM2.54
X60	HDD 2.5"	2x 22	RM2.54
X62	HDD 3.5"	2x 20	RM2.54
X70	Floppy	26	FCC
X100	PC/104	PC/104	PC/104
X101	PC/104+	PC/104+	PC/104+
X120	Mini PCI	Mini PCI	Mini PCI
X130	PCI Slot (standard PCI slot)	-	PCI

Special Connectors			
LS1	Buzzer	-	-

Onboard Switches			
SW1	Main Switch / Power Button (Pwrbtn)		
SW2	Reset Switch		

# 6.1. Connector Plan

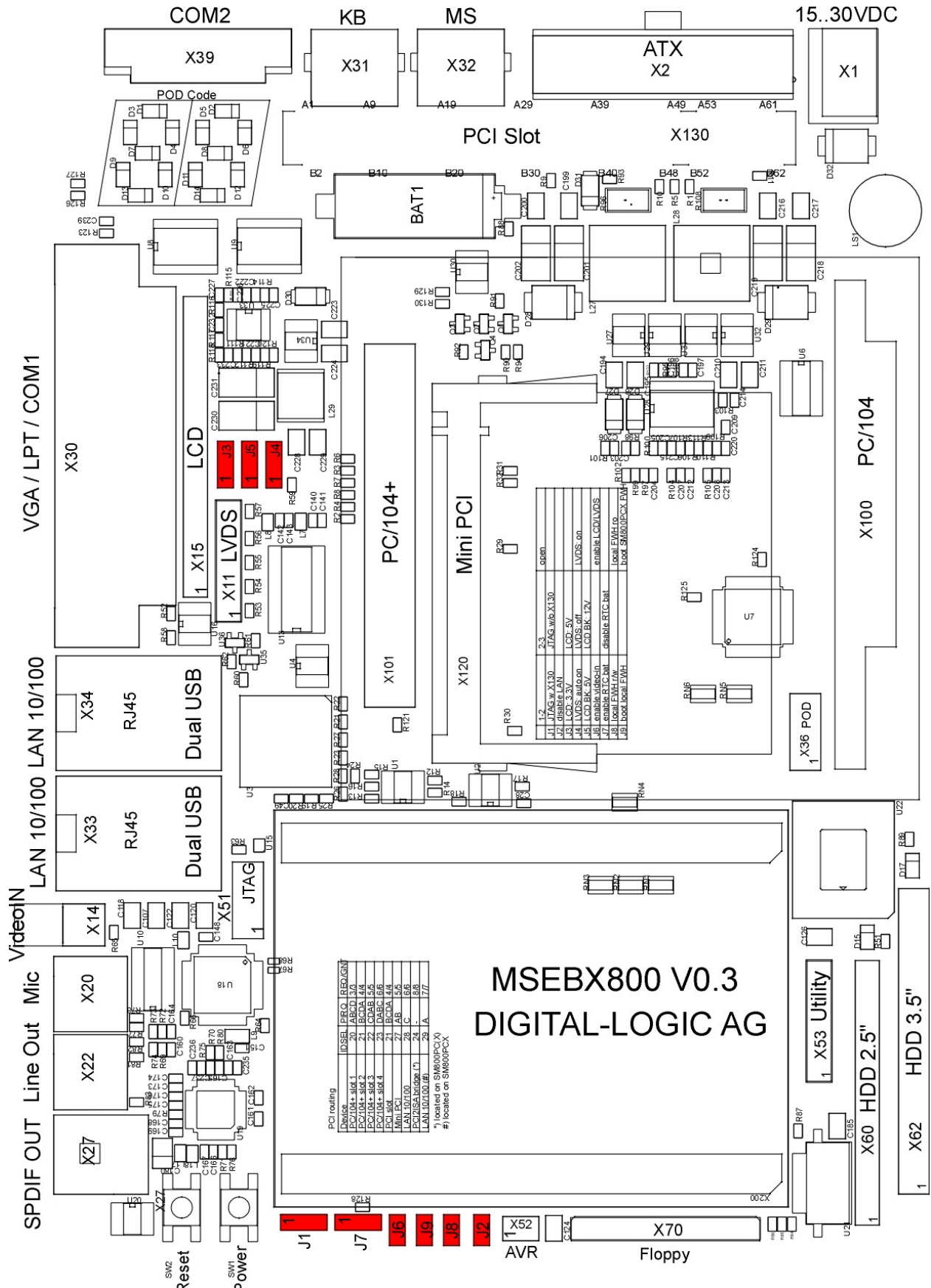

## 6.2. Connector Descriptions

### X1 Power Input

Pin	Signal	Pin	Signal
1	8-30V DC-Input	2	Ground

### X2 ATX Connector

Pin	Signal	Pin	Signal
1	+3.3V	2	+3.3V
3	GND	4	+5V
5	GND	6	+5V
7	GND	8	PWR-OK
9	+5VSB	10	+12V
11	+3.3V	12	-12V
13	GND	14	PS-ON#
15	GND	16	GND
17	GND	18	-5V
19	+5V	20	+5V

### X11 LVDS

Pin	Signal	Pin	Signal
1	LVDS_A0-	2	LVDS_A0+
3	GND	4	GND
5	LVDS_A1-	6	LVDS_A1+
7	LCD BKL (dep. J5)	8	LCD BKL (dep. J5)
9	LVDS_A2-	10	LVDS_A2+
11	LCD VDD (dep 3)	12	LCD VDD (dep 3)
13	LVDS_A3-	14	LVDS_A3+
15	NC	16	NC
17	NC	18	NC
19	LVDS_Clock-	20	LVDS_Clock+

The LVDS interface works only if the **J6** Jumper is *not* installed.

### X14 Video Input Channel

Pin	Signal Name	Function	in/out
1	Video Signal	CVBS	In
2	Ground		

The Video IN interface works only if the **J6** Jumper *is* installed.

**X15 LCD Connector**

Pin	Signal	Pin	Signal
1	DE_SPLIT	2	VSYNC
3	BLK	4	HSYNC
5	VCCLCD_SB	6	Ground
7	<b>NC</b>	8	SHFCLK
9	VDD	10	D0
11	D1	12	D2
13	D3	14	D4
15	D5	16	D6
17	D7	18	D8
19	D9	20	D10
21	D11	22	D12
23	D13	24	D14
25	D15	26	Ground
27	D16	28	D17
29	D18	30	D19
31	D20	32	<b>NC</b>
33	D21	34	D22
35	D23	36	<b>NC</b>
37	<b>NC</b>	38	<b>NC</b>
39	<b>NC</b>	40	<b>NC</b>
41	<b>NC</b>	42	<b>NC</b>
43	<b>NC</b>	44	Ground
45	<b>NC</b>	46	<b>NC</b>
47	<b>NC</b>	48	<b>NC</b>
49	VCC	50	<b>NC</b>

The LCD interface works only if the **J6** Jumper is *not* installed.

**X20 Microphone Input Audio Connector**

Pin	Signal	Pin	Signal
1	<b>NC</b>	2	Sense
3	Audio Ground	4	Channel R
5	Channel L	6	<b>NC</b>

**X22 Front (Stereo Output) Audio Connector**

Pin	Signal	Pin	Signal
1	<b>NC</b>	2	Sense
3	Audio Ground	4	Channel R
5	Channel L	6	<b>NC</b>

**X27 SPDif Connector**

Pin	Signal	Pin	Signal
1	Digital Audio Data Out	2	GND



**X30A Printer Port (Centronics, EMI-Filtered)**

D-SUB Connector:	Signal
Pin 1	Strobe
Pin 2	Data 0
Pin 3	Data 1
Pin 4	Data 2
Pin 5	Data 3
Pin 6	Data 4
Pin 7	Data 5
Pin 8	Data 6
Pin 9	Data 7
Pin 10	Acknowledge
Pin 11	Busy
Pin 12	paper end
Pin 13	select
Pin 14	autofeed
Pin 15	error
Pin 16	init printer
Pin 17	shift in (SI)
Pins 18-25	GND

**X30B Serial Port COM1 RS232 (EMI-Filtered)**

D-SUB connector:	Signal
Pin 1	DCD
Pin 2	RXD
Pin 3	TXD
Pin 4	DTR
Pin 5	GND
Pin 6	DSR
Pin 7	RTS
Pin 8	CTS
Pin 9	RI

**X30C VGA**

Pin	Signal
1	Red
2	Green
3	Blue
13	H-Synch
14	V-Synch
5, 6, 7, 8, 10	GND
4, 9, 11, 12, 15	<b>NC</b>

**X31 PS/2Keyboard (AT Compatible)**

Pin	Signal	Pin	Signal
1	KB_Data	2	-
3	GND	5	+5Volt / 100mA
6	KB_Clk	8	-

**X32 PS/2Mouse**

Pin	Signal	Pin	Signal
1	MB_Data	2	-
3	GND	5	+5Volt / 100mA
6	MB_Clk	8	-

**X33A Ethernet LAN**

RJ-45 Pin	Signal	RJ-45 Pin	Signal
1	TX+	2	TX-
3	RX+	4	GND
5	GND	6	RX-
7	GND	8	GND

**X33B / X33C USB 0/1**

Pin	Signal	Pin	Signal
1	VCC	5	VCC
2	USB-Px-	6	USB-Px-
3	USB-Px+	7	USB-Px+
4	GND	8	GND

**X34A Ethernet LAN**

RJ-45 Pin	Signal	RJ-45 Pin	Signal
1	TX+	2	TX-
3	RX+	4	GND
5	GND	6	RX-
7	GND	8	GND

**X34B / X34C USB 2/3**

Pin	Signal	Pin	Signal
1	VCC	5	VCC
2	USB-Px-	6	USB-Px-
3	USB-Px+	7	USB-Px+
4	GND	8	GND

**RJ45 Connector 10BaseT (IEEE 802.3i), 100BaseTX (IEEE 802.3u):**

MDI-Pin	EIA/TIA 568A colors (wire/line)	Pin	Twisted Pair
TX+	White / Green	1	3
TX-	Green	2	3
RX+	White / Orange	3	2
GND ..		4	1
GND ..		5	1
RX-	Orange	6	2
GND ..		7	4
GND ..		8	4

Cabling: Do not exceed 100m (328 feet); minimum quality of CAT5, preferably S/FTP or STP CAT6. Be careful to have a well balanced shield/ground concept.

**X36 CPLD**

Pin	Signal	Pin	Signal
1	CPLD TCK	2	GND
3	CPLD TDO	4	VCC5SB
5	CPLD TMS	6	NC
7	SYS RST#	8	NC
9	CPLD TDI	10	GND

Only for internal use.

**X39 Serial Port**

D-SUB connector:	Signal
Pin 1	DCD
Pin 2	RXD
Pin 3	TXD
Pin 4	DTR
Pin 5	GND
Pin 6	DSR
Pin 7	RTS
Pin 8	CTS
Pin 9	RI

**X51 JTAG**

Pin	Signal	Pin	Signal
1	TCK	6	NC
2	GND	7	RESET_IN (RST)
3	TDO	8	NC
4	VCCSUS	9	TDI
5	TMS	10	GND

**X52 AVR**

Pin	Signal	Pin	Signal
1	AVR VCC	2	GND
3	AVR SCL	4	AVR RST
5	AVR MISO	6	AVR MOSI

Only for internal use

**X53 Utility**

Pin	Signal	Pin	Signal
1	SUSC	2	VCCBat TP
3	PS ON ATX	4	VCC5SB TP
5	System Reset	6	VCC3 TP
7	PWRBTN	8	VCC TP
9	GPIO 30	10	VCC12 TP
11	GPIO 31	12	GND
13	GPIO 34	14	GND
15	SMB SDA	16	<b>NC</b>
17	SMB SCL	18	<b>NC</b>
19	<b>NC</b>	20	<b>NC</b>

**X60 2.5" Hard Disk**

Pin	Signal	Pin	Signal
1	Reset (active low)	2	<b>NC</b>
3	D7	4	D8
5	D6	6	D9
7	D5	8	D10
9	D4	10	D11
11	D3	12	D12
13	D2	14	D13
15	D1	16	D14
17	D0	18	D15
19	GND	20	(keypin) <b>NC</b>
21	DRQ	22	GND
23	IOW(active low)	24	GND
25	IOR(active low)	26	GND
27	IOCHRDY	28	ALE / Master-Slave <b>NC</b>
29	DACK	30	GND
31	IRQ14 (pri) IRQ15 (sec)	32	IOCS16 (active low)
33	ADR1	34	DIAG
35	ADR0	36	ADR2
37	CS0 (active low)	38	CS1 (active low)
39	LED (active low)	40	GND
41	VCC Logic	42	VCC Motor
43	GND	44	<b>NC</b>

**X62 3.5" Hard Disk**

Pin	Signal	Pin	Signal
1	Reset (active low)	2	GND
3	D7	4	D8
5	D6	6	D9
7	D5	8	D10
9	D4	10	D11
11	D3	12	D12
13	D2	14	D13
15	D1	16	D14
17	D0	18	D15
19	GND	20	(keypin) <b>NC</b>
21	DRQ	22	GND
23	IOW(active low)	24	GND
25	IOR(active low)	26	GND
27	IOCHRDY	28	ALE / Master-Slave <b>NC</b>
29	DACK	30	GND
31	IRQ14 (pri) IRQ15 (sec)	32	IOCS16 (active low)
33	ADR1	34	DIAG
35	ADR0	36	ADR2
37	CS0 (active low)	38	CS1 (active low)
39	LED (active low)	40	GND

**X70 Floppy Disk**

FD26: Pin	Signal Name	Function	in/out
1	VCC	+5Volt	
2	IDX	Index Pulse	in
3	VCC	+5Volt	
4	DS2	Drive Select *	out
5	VCC	+5Volt	
6	DCHG	Disk Change	in
10	M02	Motor on *	out
12	DIRC	Direction Select	out
14	STEP	Step	out
16	WD	Write Data	out
17	GND	Signal grounds	
18	WE	Write Enable	out
19	GND	Signal grounds	
20	TRKO	Track 0	in
21	GND	Signal grounds	
22	WP	Write Protect	in
23	GND	Signal grounds	
24	RDD	Read Data	in
25	GND	Signal grounds	
26	HS	Head Select	out

**X100 PC/104 Connector (ISA)**

Pin	A:	B:	C:	D:
0			Ground	Ground
1	IOCHCK	Ground	SBHE	MEMCS16
2	SD7	RESET	LA23	IOCS16
3	SD6	+5V	LA22	IRQ10
4	SD5	IRQ9	LA21	IRQ11
5	SD4	<b>NC</b>	LA20	IRQ12
6	SD3	DRQ2	LA19	IRQ15
7	SD2	(-12V) <b>NC</b>	LA18	IRQ14
8	SD1	0WS	LA17	DACK0
9	SD0	+12V	MEMR	DRQ0
10	IOCHRDY	Ground <b>NC</b>	MEMW	DACK5
11	AEN	SMEMW	SD8	DRQ5
12	SA19	SMEMR	SD9	DACK6
13	SA18	SIOW	SD10	DRQ6
14	SA17	SIOR	SD11	DACK7
15	SA16	DACK3	SD12	DRQ7
16	SA15	DRQ3	SD13	+5 Volt
17	SA14	DACK1	SD14	MASTER
18	SA13	DRQ1	SD15	Ground
19	SA12	REF	Ground	Ground
20	SA11	SYSCLK		
21	SA10	IRQ7		
22	SA9	IRQ6		
23	SA8	IRQ5		
24	SA7	IRQ4		
25	SA6	IRQ3		
26	SA5	DACK2		
27	SA4	TC		
28	SA3	ALE		
29	SA2	+5 Volt		
30	SA1	OSC		
31	SA0	Ground		
32	Ground	Ground		

**X101 PC/104+ Connector (PCI)**

Pin	A:	B:	C:	D:
1	GND/5.0V KEY2	Reserved	+5	AD00
2	VI/O	AD02	AD01	+5V
3	AD05	GND	AD04	AD03
4	C/BE0*	AD07	GND	AD06
5	GND	AD09	AD08	GND
6	AD11	VI/O	AD10	M66EN
7	AD14	AD13	GND	AD12
8	+3.3V	C/BE1*	AD15	+3.3V
9	SERR*	GND	SB0*	PAR
10	GND	PERR*	+3.3V	SDONE
11	STOP*	+3.3V	LOCK*	GND
12	+3.3V	TRDY*	GND	DEVSEL*
13	FRAME*	GND	IRDY*	+3.3V
14	GND	AD16	+3.3V	C/BE2*
15	AD18	+3.3V	AD17	GND
16	AD21	AD20	GND	AD19
17	+3.3V	AD23	AD22	+3.3V
18	IDSEL0	GND	IDSEL1	IDSEL2
19	AD24	C/BE3*	VI/O	IDSEL3
20	GND	AD26	AD25	GND
21	AD29	+5V	AD28	AD27
22	+5V	AD30	GND	AD31
23	REQ0*	GND	REQ1*	VI/O
24	GND	REQ2*	+5V	GNT0*
25	GNT1*	VI/O	GNT2*	GND
26	+5V	CLK0	GND	CLK1
27	CLK2	+5V	CLK3	GND
28	GND	INTD*	+5V	RST*
29	+12V	INTA*	INTB*	INTC*
30	-12V	Reserved	Reserved	GND/3.3V KEY2

**X120 MiniPCI Interface**

Pin	Signal	Pin	Signal	Pin	Signal	Pin	Signal
1	TIP	2	RING	63	3.3V	64	FRAME#
3	8PMJ-3	4	8PMJ-1	65	CLKRUN#	66	TRDY#
5	8PMJ-6	6	8PMJ-2	67	SERR#	68	STOP#
7	8PMJ-7	8	8PMJ-4	69	GROUND	70	3.3V
9	8PMJ-8	10	8PMJ-5	71	PERR#	72	DEVSEL#
11	LED1_GRNP	12	LED2_YELP	73	C/BE[1]#	74	GROUND
13	LED1_GRNN	14	LED2_YELN	75	AD[14]	76	AD[15]
15	CHSGND	16	RESERVED	77	GROUND	78	AD[13]
17	INTB#	18	5V	79	AD[12]	80	AD[11]
19	3.3V	20	INTA#	81	AD[10]	82	GROUND
21	RESERVED	22	RESERVED	83	GROUND	84	AD[09]
23	GROUND	24	3.3VAUX	85	AD[08]	86	C/BE[0]#
25	CLK	26	RST#	87	AD[07]	88	3.3V
27	GROUND	28	3.3V	89	3.3V	90	AD[06]
29	REQ#	30	GNT#	91	AD[05]	92	AD[04]
31	3.3V	32	GROUND	93	RESERVED	94	AD[02]
33	AD[31]	34	PME#	95	AD[03]	96	AD[00]
35	AD[29]	36	RESERVED	97	5V	98	RESERVED_WIP5
37	GROUND	38	AD[30]	99	AD[01]	100	RESERVED_WIP5
39	AD[27]	40	3.3V	101	GROUND	102	GROUND
41	AD[25]	42	AD[28]	103	AC_SYNC	104	M66EN
43	RESERVED	44	AD[26]	105	AC_SDATA_IN	106	AC_SDATA_OUT
45	C/BE[3]#	46	AD[24]	107	AC_BIT_CLK	108	AC_CODEC_ID0#
47	AD[23]	48	IDSEL	109	AC_CODEC_ID1#	110	AC_RESET#
49	GROUND	50	GROUND	111	MOD_AUDIO_MON	112	RESERVED
51	AD[21]	52	AD[22]	113	AUDIO_GND	114	GROUND
53	AD[19]	54	AD[20]	115	SYS_AUDIO_OUT	116	SYS_AUDIO_IN
55	GROUND	56	PAR	117	SYS_AUDIO_OUT GND	118	SYS_AUDIO_IN GND
57	AD[17]	58	AD[18]	119	AUDIO_GND	120	AUDIO_GND
59	C/BE[2]#	60	AD[16]	121	RESERVED	122	MPCIACT#
61	IRDY#	62	GROUND	123	VCC5VA	124	3.3VAUX



**X130 PCI Slot (Standard PCI Slot)**

Pin	Name	PCI Pin Description	Pin	Name	PCI Pin Description
A1	TRST	Test Logic Reset	B1	-12V	-12 VDC
A2	+12V	+12 VDC	B2	TCK	Test Clock
A3	TMS	Test Mde Select	B3	GND	Ground
A4	TDI	Test Data Input	B4	TDO	Test Data Output
A5	+5V	+5 VDC	B5	+5V	+5 VDC
A6	INTA	Interrupt A	B6	+5V	+5 VDC
A7	INTC	Interrupt C	B7	INTB	Interrupt B
A8	+5V	+5 VDC	B8	INTD	Interrupt D
A9	-----	Reserved	B9	PRSNT1	Present
A10	+5V	Power (+5 V or +3.3 V)	B10	-----	Reserved
A11	-----	Reserved	B11	PRSNT2	Present
A12	GND03	Ground or Keyway for 3.3/Universal PWB	B12	GND	Ground or Keyway for 3.3/Universal PWB
A13	GND05	Ground or Keyway for 3.3/Universal PWB	B13	GND	Ground or Open (Key) for 3.3/Universal PWB
A14	3.3Vaux	-----	B14	RES	Reserved
A15	RESET	Reset	B15	GND	Ground
A16	+5V	Power (+5 V or +3.3 V)	B16	CLK	Clock
A17	GNT	Grant PCI use	B17	GND	Ground
A18	GND08	Ground	B18	REQ	Request
A19	PME#	Power Managment Event	B19	+5V	Power (+5 V or +3.3 V)
A20	AD30	Address/Data 30	B20	AD31	Address/Data 31
A21	+3.3V01	+3.3 VDC	B21	AD29	Address/Data 29
A22	AD28	Address/Data 28	B22	GND	Ground
A23	AD26	Address/Data 26	B23	AD27	Address/Data 27
A24	GND10	Ground	B24	AD25	Address/Data 25
A25	AD24	Address/Data 24	B25	+3.3V	+3.3VDC
A26	IDSEL	Initialization Device Select	B26	C/BE3	Command, Byte Enable 3
A27	+3.3V03	+3.3 VDC	B27	AD23	Address/Data 23
A28	AD22	Address/Data 22	B28	GND	Ground
A29	AD20	Address/Data 20	B29	AD21	Address/Data 21
A30	GND12	Ground	B30	AD19	Address/Data 19
A31	AD18	Address/Data 18	B31	+3.3V	+3.3 VDC
A32	AD16	Address/Data 16	B32	AD17	Address/Data 17
A33	+3.3V05	+3.3 VDC	B33	C/BE2	Command, Byte Enable 2
A34	FRAME	Address or Data phase	B34	GND13	Ground
A35	GND14	Ground	B35	IRDY#	Initiator Ready
A36	TRDY#	Target Ready	B36	+3.3V06	+3.3 VDC
A37	GND15	Ground	B37	DEVSEL	Device Select
A38	STOP	Stop Transfer Cycle	B38	GND16	Ground
A39	+3.3V07	+3.3 VDC	B39	LOCK#	Lock bus
A40	-----	Reserved	B40	PERR#	Parity Error
A41	-----	Reserved	B41	+3.3V08	+3.3 VDC
A42	GND17	Ground	B42	SERR#	System Error
A43	PAR	Parity	B43	+3.3V09	+3.3 VDC
A44	AD15	Address/Data 15	B44	C/BE1	Command, Byte Enable 1
A45	+3.3V10	+3.3 VDC	B45	AD14	Address/Data 14
A46	AD13	Address/Data 13	B46	GND18	Ground
A47	AD11	Address/Data 11	B47	AD12	Address/Data 12
A48	GND19	Ground	B48	AD10	Address/Data 10
A49	AD9	Address/Data 9	B49	GND20	Ground
A50	Keyway	Open or Ground for 3.3V PWB	B50	Keyway	Open or Ground for 3.3V PWB
A51	Keyway	Open or Ground for 3.3V PWB	B51	Keyway	Open or Ground for 3.3V PWB
A52	C/BE0	Command, Byte Enable 0	B52	AD8	Address/Data 8
A53	+3.3V11	+3.3 VDC	B53	AD7	Address/Data 7
A54	AD6	Address/Data 6	B54	+3.3V12	+3.3 VDC
A55	AD4	Address/Data 4	B55	AD5	Address/Data 5
A56	GND21	Ground	B56	AD3	Address/Data 3
A57	AD2	Address/Data 2	B57	GND22	Ground
A58	AD0	Address/Data 0	B58	AD1	Address/Data 1
A59	+5V	Power (+5 V or +3.3 V)	B59	VCC08	Power (+5 V or +3.3 V)
A60	REQ64	Request 64 bit	B60	ACK64	Acknowledge 64 bit
A61	VCC11	+5 VDC	B61	VCC10	+5 VDC
A62	VCC13	+5 VDC	B62	VCC12	+5 VDC

## 7. JUMPER LOCATIONS ON THE BOARD

The following tables show the location of the jumper blocks on the MSEBX800/900 board. The numbers shown in these tables are silk screened on the board so that the pins can be easily located. This chapter refers to the individual pins for these jumpers.

**Be careful:** some jumpers are soldering bridges; you will need a miniature soldering station with a vacuum pump.

**Settings written in bold are defaults!**

### 7.1. The 2pin Jumpers

Jumper	Structure	Open	Closed 1 - 2
<b>J2</b>	LAN B (SM800DK LAN) isolate	<b>Enable LAN B</b>	Disable LAN B
<b>J6</b>	Select Video Out- or Input	Enable LCD/LVDS	<b>Enable Video-In</b>
<b>J8</b>	Disable write protection of local FWH (FirmWareHub)	<b>FWH read only</b>	FWH read / write
<b>J9</b>	Boot FWH from SM800PCX or from the MSEBX800-Board	<b>Boot SM800PCX FWH</b>	Boot local FWH

### 7.2. The 3pin Jumpers

Jumper	Structure	Open	Closed 1 - 2	Closed 2 - 3
<b>J1</b>	PCI X130 slot in JTAG chain		<b>JTAG w/</b>	JTAG w/o
<b>J3</b>	LCD VDD voltage		<b>+3.3V</b>	+5V
<b>J4</b>	LVDS transmitter	LVDS on	LVDS auto on	LVDS off
<b>J5</b>	LCD Backlight voltage		+5V	<b>+12V<sup>1)</sup></b>
<b>J7</b>	RTC enable / disable		<b>Enable RTC batt</b>	Disable RTC batt <sup>2)</sup>

1.) The 12V are only available if an ATX-Supply is connected.

2.) It's possible to connect an external RTC back-up battery to pin 2-3 of **J7**.

### 7.3. Jumpers on the MSEBX800

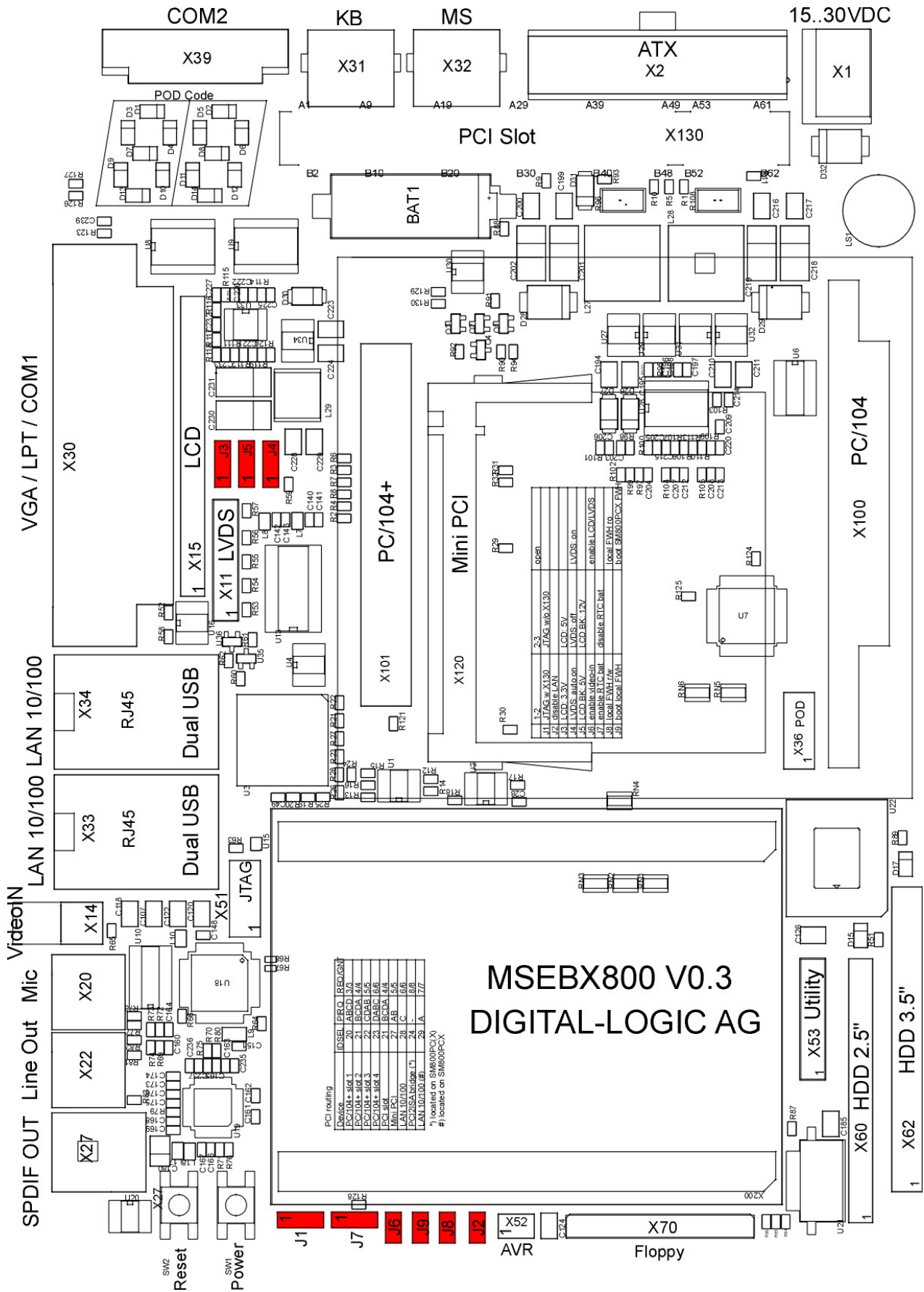

## 8. INDEX

### A

Addressing PCI Devices..... 31

### B

BIOS Recovery ..... 36  
 Block Diagrams ..... 13  
 Boot Time..... 32  
 Bus Signals ..... 29

### C

Connector Descriptions ..... 39  
 Connector Plan ..... 38  
 Connectors ..... 37  
   2.5" Hard Disk ..... 44  
   3.5" Hard Disk ..... 45  
   ATX ..... 39  
   Ethernet LAN..... 42  
   Floppy Disk..... 45  
   JTAG ..... 43  
   Keyboard PS/2 ..... 42  
   LCD ..... 40  
   LVDS ..... 39  
   Microphone..... 40  
   MiniPCI Interface ..... 48  
   Mouse PS/2 ..... 42  
   PC/104 ..... 46  
   PC/104+ Slot ..... 47  
   PCI Slot ..... 49  
   Power Input ..... 39  
   Printer Port ..... 41  
   RJ45 ..... 43  
   Serial Port..... 41, 43  
   SPDif ..... 40  
   Stereo Output ..... 40  
   USB ..... 42  
   Utility..... 44  
   VGA..... 41  
   Video Input Channel ..... 39  
 Controllers..... 35  
 Core BIOS Download..... 35

### D

Dimensions & Diagrams ..... 19  
 Disclaimer ..... 5

### E

Environmental Protection Statement ..... 5

### F

Features, Standard ..... 12  
 Features, Unique..... 12  
 Floppy Disk ..... 34  
 Floppy Disk Interface Connector ..... 34

### H

High Frequency Radiation ..... 22

### I

Important Information ..... 24  
 Interfaces..... 33  
 ISO 9001:2000 ..... 11

### J

Jumper Locations ..... 50  
 Jumpers..... 51  
   2pin..... 50  
   3pin..... 50

### K

Keyboard ..... 33

### L

LPT1 ..... 33

### M

Manual, How to Use It ..... 2  
 Mouse..... 33

### O

Ordering Codes ..... 18

### P

PC104 Bus ..... 29  
 PCI Slot Assignment..... 31  
 Power & Reset Buttons ..... 28  
 Preparation..... 24  
 Printer..... 33  
 Programmable Timers ..... 35

### R

RAM Assembly/Disassembly ..... 26  
 Recycling Information ..... 6  
 Related Application Notes ..... 22  
 RoHS Commitment..... 9  
 RTC Battery Lifetime ..... 23

### S

Safety Precautions ..... 9  
 Security ..... 17  
 Serial Ports..... 33  
 smartModule

Mounting..... 25  
Specifications..... 15  
SQS..... 11  
Standards..... 8  
Swiss Association for Quality and Management  
Systems..... 11  
Swiss Quality..... 11  
Symbols ..... 7

**T**

Technical Support ..... 6

Thermoscan ..... 23  
Timers and Counters ..... 35  
Trademarks ..... 5

**W**

Warranty ..... 6  
Watchdog ..... 35

## Free Manuals Download Website

<http://myh66.com>

<http://usermanuals.us>

<http://www.somanuals.com>

<http://www.4manuals.cc>

<http://www.manual-lib.com>

<http://www.404manual.com>

<http://www.luxmanual.com>

<http://aubethermostatmanual.com>

Golf course search by state

<http://golfingnear.com>

Email search by domain

<http://emailbydomain.com>

Auto manuals search

<http://auto.somanuals.com>

TV manuals search

<http://tv.somanuals.com>