

Thank you for purchasing this Factory Service Manual CD/DVD from [servicemanuals4u.com](http://servicemanuals4u.com).

Please check out our eBay auctions for more great deals on Factory Service Manuals:

[servicemanuals4u](http://servicemanuals4u)

COMPAQ

[STORE](#) | [PRODUCTS](#) | [SERVICES](#) | [SUPPORT](#) | [CONTACT US](#) | [SEARCH](#)

## Maintenance & Service Guide for Presario 1600 Series (Models 1683-1694)

[Home Page](#) | [Notice](#) | [Preface](#) | [Product Description](#) | [Troubleshooting](#) | [Illustrated Parts Catalog](#) | [Removal & Replacement Procedures](#) | [Specifications](#) | [Pin Assignments](#) | [Battery Pack Operations](#)

---



**[Download](#) to this Maintenance and Service Guide (MSG) to your hard drive.**

Welcome to the Maintenance & Service Guide (MSG). This online guide is designed to serve the needs of those whose job it is to repair Compaq products. The [Notice](#), contains the copyright and trademark information. The [Preface](#) shows symbol conventions, Technician Notes and Serial Number locations on the unit.

This MSG will be periodically maintained and updated online as needed.

For content comments or questions, contact the [Editor](#).

To report a technical problem, contact your Regional Support Center or IM Help Center.

**1.800.AT.COMPAQ**

[privacy and legal statement](#)

COMPAQ

[STORE](#) | [PRODUCTS](#) | [SERVICES](#) | [SUPPORT](#) | [CONTACT US](#) |  
[SEARCH](#)

## Maintenance & Service Guide for Presario 1600 Series (Models 1683-1694)

| [Home Page](#) | [Notice](#) | [Preface](#) | [Product Description](#) | [Troubleshooting](#) |  
[Illustrated Parts Catalog](#) |  
[Removal & Replacement Procedures](#) | [Specifications](#) | [Pin Assignments](#) |  
[Battery Pack Operations](#)

---

### Notice

The information in this guide is subject to change without notice.

COMPAQ COMPUTER CORPORATION SHALL NOT BE LIABLE FOR TECHNICAL OR EDITORIAL ERRORS OR OMISSIONS CONTAINED HEREIN, NOR FOR INCIDENTAL OR CONSEQUENTIAL DAMAGES RESULTING FROM THE FURNISHING, PERFORMANCE, OR USE OF THIS MATERIAL.

This guide contains information protected by copyright. No part of this guide may be photocopied or reproduced in any form without prior written consent from Compaq Computer Corporation.

1998 Compaq Computer Corporation.  
All rights reserved. Printed in the U.S.A.

Compaq, Presario Series Registered U. S. Patent and Trademark Office.

Microsoft, MS-DOS, and Windows are registered trademarks of Microsoft Corporation.  
Windows 98 is a trademark of Microsoft Corporation.

The software described in this guide is furnished under a license agreement or nondisclosure agreement. The software may be used or copied only in accordance with the terms of the agreement.

Product names mentioned herein may be trademarks and/or registered trademarks of their respective companies.

Maintenance and Service Guide

Compaq Presario Series Portable Computer

First Edition (March 1999)  
Compaq Computer Corporation

1.800.AT.COMPAQ

[privacy and legal statement](#)

COMPAQ

[STORE](#) | [PRODUCTS](#) | [SERVICES](#) | [SUPPORT](#) | [CONTACT US](#) |  
[SEARCH](#)

## Maintenance & Service Guide for Presario 1600 Series (Models 1683-1694)

| [Home Page](#) | [Notice](#) | [Preface](#) | [Product Description](#) | [Troubleshooting](#) |  
[Illustrated Parts Catalog](#) |  
[Removal & Replacement Procedures](#) | [Specifications](#) | [Pin Assignments](#) | [Battery  
Pack Operations](#)

### Preface

This *Maintenance and Service Guide* is a troubleshooting guide that can be used for reference when servicing the Compaq Presario Series Portable Computers.

Compaq Computer Corporation reserves the right to make changes to the Compaq Presario Series Portable Computers without notice.

### Symbols

The following words and symbols mark special messages throughout this guide.



**WARNING:** Text set off in this manner indicates that failure to follow directions in the warning could result in bodily harm or loss of life.



**CAUTION:** Text set off in this manner indicates that failure to follow directions could result in damage to equipment or loss of data.

**IMPORTANT:**

Text set off in this manner presents clarifying information or specific instructions.

**NOTE:** Text set off in this manner presents commentary, sidelights, or interesting points of information.

## Technician Notes



**WARNING:** Only authorized technicians trained by Compaq should repair this equipment. All troubleshooting and repair procedures are detailed to allow only subassembly/module level repair. Because of the complexity of the individual boards and subassemblies, the user should not attempt to make repairs at the component level or to make modifications to any printed circuit board. Improper repairs can create a safety hazard. Any indications of component replacement or printed circuit board modifications may void any warranty.

## Serial Number

When requesting information or ordering spare parts, the computer serial number should be provided to Compaq. The serial number is located on the bottom of the computer.

## Locating Additional Information

The following documentation is available to support this product:

- Compaq Presario Series Portable Computer documentation set
- *Introducing Windows 98 Guide*
- Service Training Guides
- Compaq Service Advisories and Bulletins
- *Compaq QuickFind*
- *Compaq Service Quick Reference Guide*

1.800.AT.COMPAQ

[privacy and legal statement](#)

COMPAQ

[STORE](#) | [PRODUCTS](#) | [SERVICES](#) | [SUPPORT](#) | [CONTACT US](#) | [SEARCH](#)

## Maintenance & Service Guide for Presario 1600 Series (Models 1683-1694)

[Home Page](#) | [Notice](#) | [Preface](#) | [Product Description](#) | [Troubleshooting](#) |

[Illustrated Parts Catalog](#) |

[Removal & Replacement Procedures](#) | [Specifications](#) | [Pin Assignments](#) | [Battery Pack Operations](#)

### Product Description

[Models and Features](#)

[Controls and Lights](#)

[Front Bezel Lights](#)

[Front Bezel Buttons](#)

[Left Side Components](#)

[Right Side Components](#)

[Underside of Unit](#)

[Rear Connectors](#)

[Power Management for Windows 98](#)



The Compaq Presario Series Portable Computer is a continuation of the new generation of multimedia portable computers with an innovative and integrated design, outstanding audio and video, advanced core features, and attractive styling. This full-function, AMD-K6-based portable computer allows full desktop functionality.



1.800.AT.COMPAQ



[privacy and legal statement](#)

COMPAQ

[STORE](#) | [PRODUCTS](#) | [SERVICES](#) | [SUPPORT](#) | [CONTACT US](#) | [SEARCH](#)

## Maintenance & Service Guide for Presario 1600 Series (Models 1683-1694)

[Home Page](#) | [Notice](#) | [Preface](#) | [Product Description](#) | [Troubleshooting](#) | [Illustrated Parts Catalog](#) | [Removal & Replacement Procedures](#) | [Specifications](#) | [Pin Assignments](#) | [Battery Pack Operations](#)

### Troubleshooting

[Preliminary Steps](#)
[Clearing the Power-On Password](#)
[Power-On Self Test \(POST\)](#)
[Compaq Diagnostics](#)
[Diagnostic Error Codes](#)
[Troubleshooting Without Diagnostics](#)
[Solving Minor Problems](#)
[Contacting Compaq Support](#)

This section covers troubleshooting information for the Compaq Presario Series Portable Computers. The basic steps in troubleshooting include:

1. Follow the [Preliminary Steps](#).
2. Run the [Power-On Self-Test](#) (POST).
3. Follow the recommended actions described in the diagnostic tables, if you are unable to run POST or if POST displays an error message.

When following the recommended actions in the Sections on POST and [Diagnostic Error Codes](#) perform them in the order listed. Rerun POST after each recommended action until the problem is solved and no error message occurs. Once the problem is solved, do not complete the remaining recommended actions.

**Note:** If the problem is intermittent, check the computer several times to verify that the problem is solved.

1.800.AT.COMPAQ

[privacy and legal statement](#)

COMPAQ

[STORE](#) | [PRODUCTS](#) | [SERVICES](#) | [SUPPORT](#) | [CONTACT US](#) | [SEARCH](#)

## Maintenance & Service Guide for Presario 1600 Series (Models 1683-1694)

| [Home Page](#) | [Notice](#) | [Preface](#) | [Product Description](#) | [Troubleshooting](#) |

[Illustrated Parts Catalog](#) |

[Removal & Replacement Procedures](#) | [Specifications](#) | [Pin Assignments](#) | [Battery Pack Operations](#)

---

### Illustrated Parts Catalog

[System Unit](#)

[Boards](#)

[Display Assembly](#)

[Mass Storage Devices](#)

[Miscellaneous Cable Kit](#)

[Miscellaneous Hardware Kit](#)

[Miscellaneous Plastics Kit](#)

[Miscellaneous Parts](#)

[Documentation and Software](#)

This section provides an breakdown and identifies the spare parts ordering number associated with each item(s) for the Compaq Presario Series Portable Computers.



[privacy and legal statement](#)

## Maintenance & Service Guide for Presario 1600 Series (Models 1683-1694)

| [Home Page](#) | [Notice](#) | [Preface](#) | [Product Description](#) | [Troubleshooting](#) | [Illustrated Parts Catalog](#) |

[Removal & Replacement Procedures](#) | [Specifications](#) | [Pin Assignments](#) | [Battery Pack Operations](#)

### Removal and Replacement Procedures

This section explains the removal and replacement procedures for the computer.

#### Serial Number Location

|  |
|--|
| <b>Removal sequence</b>                                |
| <a href="#">Electrostatic Discharge</a>                |
| <a href="#">Service Considerations</a>                 |
| <a href="#">Cables and Connectors</a>                  |
| <a href="#">Preparing the Computer for Disassembly</a> |
| <a href="#">Battery Pack</a>                           |
| <a href="#">Palmrest Cover with Touch Pad</a>          |
| <a href="#">Heatspreader</a>                           |
| <a href="#">Keyboard</a>                               |
| <a href="#">Processor</a>                              |

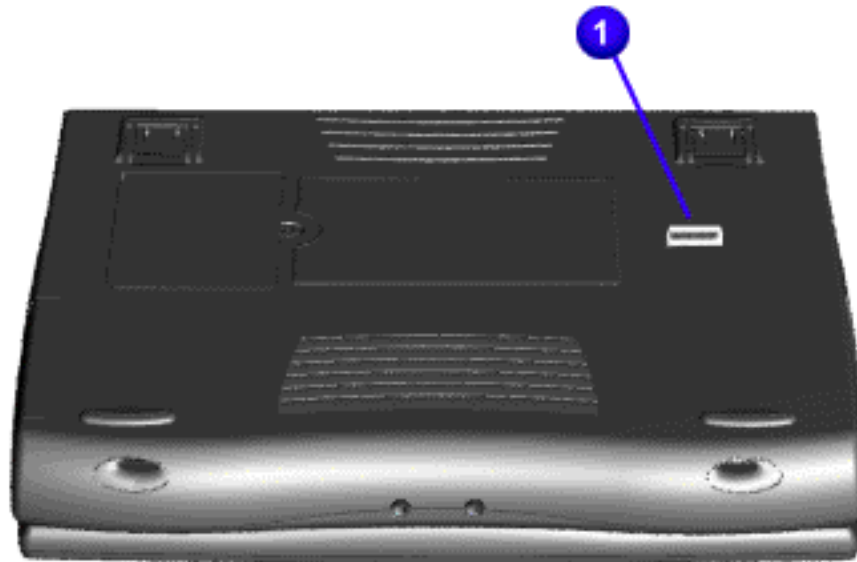

Report the computer **1** serial number to Compaq when requesting information or ordering spare parts.

[Hard Drive](#)

[DVD or  
CD Drive](#)

[Battery Charger  
Board](#)

[Modem](#)

[Display Panel  
Assembly](#)

[Upper CPU  
Cover](#)

[Network  
Interface Card](#)

[Speaker  
Assembly](#)

[Diskette Drive](#)

[Fan Assembly](#)

[System Board](#)

[Dip Switch  
Settings](#)

[Memory Module](#)

[1.800.AT.COMPAQ](tel:1800.AT.COMPAQ)

[privacy and legal statement](#)

COMPAQ

STORE | PRODUCTS | SERVICES | SUPPORT | CONTACT US |  
SEARCH

## Maintenance & Service Guide for Presario 1600 Series (Models 1683-1694)

| [Home Page](#) | [Notice](#) | [Preface](#) | [Product Description](#) | [Troubleshooting](#) | [Illustrated Parts Catalog](#) |  
[Removal & Replacement Procedures](#) | [Specifications](#) | [Pin Assignments](#) | [Battery Pack Operations](#)

---

### Specifications

This chapter covers the following specifications of Compaq Presario Series Portable Computers:

- [Computer models](#)
- [Physical and environmental](#)
- [System Interrupts](#)
- [System DMA](#)
- [System I/O Address](#)
- [System Memory Catalog](#)
- [Display](#)
- [Memory expansion](#)
- [Diskette drive](#)
- [Hard drive](#)
- [DVD or CD drive](#)
- [Battery pack](#)



## Physical and Environmental

| Computer Specifications                              |                             |                      |
|--|-----------------------------|----------------------|
|  | U.S.                        | Metric               |
| <b>Dimensions</b>                                    |                             |                      |
| Height   | 1.97 in                     | 5.0 cm               |
| Depth  | 12.32 in                    | 31.3 cm              |
| Width  | 10.12 in                    | 25.7 cm              |
| <b>Weight</b>  |                             |                      |
| Model 1683   | (Data not available)        | (Data not available) |
| Model 1685   | 7.19lbs                     | 3260 g               |
| Model 1687   | 7.19 lbs                    | 3260 g               |
| Model 1688   | 7.36 lbs                    | 3340 g               |
| Model 1690   | 7.76 lbs                    | 3520 g               |
| <b>Stand-Alone (Battery Pack) Power Requirements</b> | <b>Li Ion</b>               |                      |
| Nominal Operating Voltage                            | W @ 14.8 VDC                |                      |
| Maximum Operating Power                              | W @ 56.5 W                  |                      |
| Peak Operating Power                                 | W @ 58.5 W                  |                      |
| <b>AC Power Requirements</b>                         | (Information not available) |                      |
| Operating Voltage                                    |                             |                      |
| Operating Current                                    |                             |                      |
| Operating Frequency                                  |                             |                      |
| Maximum Transient                                    |                             |                      |
| <b>Temperature</b>                                   |                             |                      |
| Operating  | 41° to 95 °F                | 5° to 35 °C          |
| Nonoperating   | -4° to 140 °F               | -20° to 60 °C        |
| <b>Relative Humidity (Non-condensing)</b>            |                             |                      |
| Operating  | 10 to 90%                   | 35°C to 90%          |
| Nonoperating (tw = 38.7°C max)                       | 5 to 95%                    | 60°C to 95%          |
| <b>Altitude</b>                                      |                             |                      |
| Operating  | 0 to 10,000 ft              | 0 to 3.15 km         |
| Nonoperating   | 0 to 30,000 ft              | 0 to 10.14 km        |
| <b>Shock</b>   |                             |                      |
| Operating  | 10 G, 11 ms, half sine      |                      |
| Non operating  | 240 G, 2 ms, half sine      |                      |
| <b>Vibration</b>                                     |                             |                      |

|              |                                    |
|--------------|------------------------------------|
| Operating    | 0.55 G, 0.25 Oct/Min<br>sweep rate |
| Nonoperating | 1.5 G, 0.25 Oct/Min<br>sweep rate  |

**NOTE:** Applicable product safety standards specify thermal limits for plastic surfaces. Compaq Presario Series Portable Computers operate well within this range of temperatures.

## System Interrupts

| System Interrupts |  |
|-------------------|--|
| Hardware IRQ      | System Function                                    |
| IRQ0              | System Timer                                       |
| IRQ1              | Standard 101/102-Key or Microsoft Natural Keyboard |
| IRQ2              | Programmable interrupt controller                  |
| IRQ3              | IRQ Holder for PCI Steering                        |
| IRQ3              | ALi PCI to USB Open Host Controller                |
| IRQ4              | Communications Port (COM1)                         |
| IRQ5              | IRQ Holder for PCI Steering                        |
| IRQ5              | PCI Fast Ethernet DEC 21143 Based Adapter          |
| IRQ5              | ESS SOLO-1 PCI AudioDrive                          |
| IRQ5              | IRQ Holder for PCI Steering                        |
| IRQ6              | Standard Floppy Disk Controller                    |
| IRQ7              | Printer Port (LPT1)                                |
| IRQ8              | System CMOS / real-time clock                      |
| IRQ9              | RAGE LT PRO AGP 2X (English)                       |
| IRQ9              | IRQ Holder for PCI Steering                        |
| IRQ10             | Texas Instruments PCI-1211 CardBus Controller      |
| IRQ10             | IRQ Holder for PCI Steering                        |
| IRQ10             | Lucent 56K V.90 PCI DF Modem                       |
| IRQ12             | Synaptics PS/2 TouchPad                            |
| IRQ13             | Numeric data processor                             |
| IRQ14             | ALi M5229 PCI Bus Master IDE Controller            |

|       |   |
|-------|---|
| IRQ14 | Primary IDE controller (dual fifo)      |
| IRQ15 | ALi M5229 PCI Bus Master IDE Controller |
| IRQ15 | Secondary IDE controller (dual fifo)    |

## System DMA

| System DMA   |                                 |
|--------------|---------------------------------|
| Hardware DMA | System Function                 |
| 0            | (free)                          |
| 1            | ESS SOLO-1 DOS Emulation        |
| 2            | Standard Floppy Disk Controller |
| 3            | (free)                          |
| 4            | Direct memory access controller |
| 5            | (free)                          |

## System I/O Address

| System I/O Address |  |
|--------------------|--|
| I/O Address (Hex)  | System Function (Shipping Configuration)           |
| 0000 - 000Fh       | Direct memory access controller                    |
| 0020h - 0021h      | Programmable interrupt controller                  |
| 0040h - 0043h      | System timer                                       |
| 0060h - x0060h     | Standard 101/102-Key or Microsoft Natural Keyboard |
| 0061h - x0061h     | System speaker                                     |
| 0064h - x0064h     | Standard 101/102-Key or Microsoft Natural Keyboard |
| 0070h - 0071h      | System CMOS/real time clock                        |
| 0080h - 0080h      | Motherboard resources                              |
| 0081h - 008Fh      | Direct memory access controller                    |
| 0092h - 0092h      | Motherboard resources                              |
| 00A0h - 00A1h      | Programmable interrupt controller                  |

|                |   |
|----------------|---|
| 00B1h - 00B3h  | Motherboard Resources                     |
| 00C0h - 00DFh  | Direct memory access controller           |
| 00EAh - 00EBh  | Motherboard resources                     |
| 00F0h - 00FFh  | Numeric data processor                    |
| 0100h - 010Fh  | Motherboard resources                     |
| 0170h - 0177h  | ALi M5229 PCI Bus Master IDE Controller   |
| 0170h - 0177h  | Secondary IDE controller (dual fifo)      |
| 01F0h - 01F7h  | ALi M5229 PCI Bus Master IDE Controller   |
| 0200h - 0203h  | Gameport Joystick                         |
| 0220h - 022Fh  | ESS SOLO-1 DOS Emulation                  |
| 0330h - 0331h  | ESS SOLO-1 DOS Emulation                  |
| 0376h - 0376h  | Secondary IDE controller (dual fifo)      |
| 0376h - 0376h  | ALi M5229 PCI Bus Master IDE Controller   |
| 0378h - 037Fh  | Printer Port (Ltp1)                       |
| 0388h - 038Bh  | ESS SOLO-1 DOS Emulation                  |
| 03B0h - 03BBh  | RAGE LT PRO AGP 2X (English)              |
| 03C0h - 03DFh  | RAGE LT PRO AGP 2X (English)              |
| 03F0h - 03F5h  | Standard Floppy Disk Controller           |
| 03F6h - 03F6h  | Primary IDE controller (dual fifo)        |
| 03F6h - 03F6h  | ALi M5229 PCI Bus Master IDE Controller   |
| 03F7h - 03Fh7  | Standard Floppy Disk Controller           |
| 03F8h - 03FFh  | Communication Port (COM1)                 |
| 040Bh - 040Bh  | Motherboard Resources                     |
| 040D0h - 04D1h | Motherboard Resources                     |
| 04D6h - 04D6h  | Motherboard Resources                     |
| 0CF8h - 0CFFh  | PCI Bus                                   |
| 1000h - 103Fh  | Motherboard Resources                     |
| 1040h - 105Fh  | Motherboard Resources                     |
| 1060h - 106Fh  | ESS SOLO-1 PCI AudioDrive                 |
| 1070h - 107Fh  | ESS SOLO-1 PCI AudioDrive                 |
| 1080h - 10FFh  | PCI Fast Ethernet DEC 21143 Based Adapter |
| 1400h - 14FFh  | Lucent 56K V.90 PCI DF Modem              |
| 1800h - 183Fh  | ESS SOLO-1 PCI AudioDrive                 |

|               |   |
|---------------|---|
| 1840h - 1847h | Primary IDE controller (dual fifo)      |
| 1840h - 184Fh | ALi M5229 PCI Bus Master IDE Controller |
| 1848h - 184Fh | Secondary IDE controller (dual fifo)    |
| 1850h - 1853h | ESS SOLO-1 PCI AudioDrive               |
| 1854h - 1857h | ESS SOLO-1 PCI AudioDrive               |
| 1858h - 185Fh | Lucent 56K V.90 PCI DF Modem            |
| 2000h - 2FFFh | PCI standard PCI-to-PCI bridge          |
| 2000h - 20FFh | RAGE LT PRO AGP 2X (English)            |

### System Memory Catalog

| System Memory Catalog |   |
|-----------------------|---|
| Memory Address        | System Function                               |
| 00000000h - 0009FFFFh | System board extension for PnP BIOS           |
| 000A0000h - 000AFFFFh | RAGE LT PRO AGP 2X (English)                  |
| 000B0000h - 000BFFFFh | RAGE LT PRO AGP 2X (English)                  |
| 000C0000h - 000CBFFFh | RAGE LT PRO AGP 2X (English)                  |
| 000DC000h - 000DFFFFh | Motherboard Resources                         |
| 000E0000h - 000FFFFFh | System board extension for PnP BIOS           |
| 00100000h - 01FFFFFFh | System board extension for PnP BIOS           |
| 0C000000h - 0C000FFFh | Texas Instruments PCI-1211 CardBus Controller |
| E0000000h - E3FFFFFFh | ALi M1541 AGP System Controller               |
| FC000000h - FCFFFFFFh | ALi PCI to USB Open Host Controller           |
| FC001000h - FC0010FFh | Lucent 56K V.90 PCI DF Modem                  |
| FC001400h - FC0017FFh | PCI Fast Ethernet DEC 21143 Based Adapter     |
| FC100000h - FDFFFFFFh | PCI standard PCI-to-PCI bridge                |

|                        |                              |
|------------------------|------------------------------|
| FC100000h - FC100FFFh  | RAGE LT PRO AGP 2X (English) |
| FC120000h - FC13FFFFh  | RAGE LT PRO AGP 2X (English) |
| FD000000h - FDFFFFFFFh | RAGE LT PRO AGP 2X (English) |
| FFFC0000h - FFFFFFFFh  | Motherboard Resources        |

**Display**

| 12.1" (Diagonal) TFT Display with LVDS |                  |         |
|--|------------------|---------|
|  | U.S.             | Metric  |
| <b>Dimensions</b>                      |                  |         |
| Height                                 | 7.83"            | 19.9 cm |
| Width                                  | 10.8"            | 25.7 cm |
| <b>Diagonal Size</b>                   | 12.1"            | 30.7 cm |
| <b>Mounting</b>                        | Internal         |         |
| <b>Number of Colors</b>                | 16 M             |         |
| <b>Contrast Ratio</b>                  | Typical 150:1    |         |
| <b>Brightness</b>                      | Over 120 cd/m~3  |         |
| <b>Pixel Resolution</b>                |                  |         |
| Pitch                                  | 0.30 x 0.30 mm   |         |
| Format                                 | 800 x 600        |         |
| Configuration                          | RGB Stripe       |         |
| <b>Backlight</b>                       | Edge Light       |         |
| <b>Character Display</b>               | 80 x 25, 80 x 50 |         |
| <b>Total Power Consumption</b>         | 5.4 W (max)      |         |

**(Information not available)**

| 13.3" (Diagonal) TFT Display with LVDS |      |        |
|--|------|--------|
|  | U.S. | Metric |
| <b>Dimensions</b>                      |      |        |
| Height                                 |      |        |
| Width                                  |      |        |
| <b>Diagonal Size</b>                   |      |        |
| <b>Mounting</b>                        |      |        |

|   |  |
|---|--|
| Number of Colors  |  |
| Contrast Ratio  |  |
| Brightness  |  |
| <b>Pixel Resolution</b><br>Pitch<br>Format<br>Configuration |  |
| <b>Backlight</b>  |  |
| <b>Character Display</b>                                    |  |
| Total Power Consumption                                     |  |

| 14.1" (Diagonal) TFT Display with LVDS                      |  |          |
|---|--|----------|
|   | U.S.   | Metric   |
| Dimensions  |  |          |
| Height  | 8.43"  | 21.42 cm |
| Width   | 11.2"  | 28.56 cm |
| Diagonal Size   | 14.1"  | 35.8 cm  |
| Mounting  | Internal                                     |          |
| Number of Colors  | 64 K   |          |
| Contrast Ratio  | Typical 150: 1                               |          |
| Brightness  | Over 120 cd/m~3                              |          |
| <b>Pixel Resolution</b><br>Pitch<br>Format<br>Configuration | 0.279 x 0.279 mm<br>1024 x 768<br>RGB Stripe |          |
| <b>Backlight</b>  | Edge Light                                   |          |
| <b>Character Display</b>                                    | 80 x 25                                      |          |
| Total Power Consumption                                     | 6.6 W (max)                                  |          |

### Memory Expansion

| Base System Memory | Expansion Board Memory | Total Memory |
|--------------------|------------------------|--------------|
| 32-MB              | 32-MB                  | 64-MB        |
| 32-MB              | 64-MB                  | 96-MB        |

|       |        |        |
|-------|--------|--------|
| 32-MB | 128-MB | 160-MB |
| 64-MB | 32-MB  | 96-MB  |
| 64-MB | 64-MB  | 128-MB |
| 64-MB | 128-MB | 192-MB |

### Diskette Drive

| Diskette Drive                    |                            |
|-----------------------------------|----------------------------|
| <b>Diskette Size</b>              | 3.5 in                     |
| <b>Light</b>                      | None                       |
| <b>Height</b>                     | .5" / 1.27 cm              |
| <b>Bytes per Sector:</b>          | 512                        |
| Sectors per Track                 |                            |
| High Density                      | 18 (1.44-MB) / 15 (1.2-MB) |
| Low Density                       | 9                          |
| <b>Tracks per Side</b>            |                            |
| High Density                      | 80 (1.44-MB) / 80 (1.2-MB) |
| Low Density                       | 80                         |
| <b>Access Times</b>               |                            |
| Track-to-Track (high/low)         | 3 ms/6 ms                  |
| Average (ms)                      | 94 ms/174 ms               |
| Setting Time (ms)                 | 15 ms                      |
| Latency Average                   | 100                        |
| <b>Number of Read/Write Heads</b> | 2                          |

### Hard Drive

| Hard Drives                   |         |         |
|-------------------------------|---------|---------|
|                               | 6.4-GB  | 4.8-GB  |
| <b>Capacity Per Drive</b>     | 6.4-GB  | 4.8-GB  |
| <b>Drive Type</b>             | 65      | 65      |
| <b>Physical Configuration</b> |         |         |
| Cylinders                     | 8647    | 8647    |
| Heads                         | 6       | 6       |
| Sectors per track             | 240-250 | 240-250 |
| Bytes per sector              | 512     | 512     |



|  |                    |                    |
|--|--------------------|--------------------|
| <b>Logical Configuration</b>                             |                    |                    |
| Cylinders  | 13424              | 7944               |
| Heads  | 15                 | 15                 |
| Sectors per track  | 63                 | 63                 |
| Bytes per sector   | 512                | 512                |
| <b>Seek Times</b><br>(Typical, Including settling in ms) | 2.5 ms             | 2.5 ms             |
| Track to Track   | 13 ms              | 13 ms (read)       |
| Average Maximum  | 23 ms              | 23 ms              |
| Rotational Speed   | 4200 rpm           | 4200 rpm           |
| <b>Transfer Rate</b>                                     |                    |                    |
| Media  | 60.8 to 107.2 Mb/s | 60.8 to 107.2 Mb/s |
| At interface   | 33.3 MB/s          | 33.3 MB/s          |
| <b>Sector Interleave</b>                                 | 1:1                | 1:1                |
| <b>Buffer Size</b>                                       | 512 KB             | 512 KB             |

*DVD or CD Drive*

| CD Drive  |  |
|---|--|
|   | <b>24x CD Drive</b>  |
| <b>Applicable Disk</b>                                    | CD-DA, CD-ROM, CD-ROM XA, CD-1, Photo CD (multisession), Video CD, CD-R, CD-Extra (CD+), CD-G, CD-RW |
| <b>Center Hole Diameter</b>                               | .6" / 15 mm  |
| <b>Disc Diameter</b>                                      | 12 cm, 8 cm  |
| <b>Disc Thickness</b>                                     | 1.2 mm   |
| <b>Track Pitch</b>  | 1.6 um   |
| <b>Access Time</b><br>(typical, including setting)        | 110 ms   |
| <b>Audio Output Level</b><br>Line out<br>Headphone        | +/- 0.27 Vrms<br>none  |
| <b>Cache Buffer</b>                                       | 128 KB   |
| <b>Data Transfer Rate</b><br>(typical, including setting) | 3600 KB/s<br>150 KB/s<br>16.66 MB/sec  |
| <b>Startup Time</b>                                       | < 8 sec  |
| <b>Stop time</b>  | < 4 sec  |

| <b>DVD Drive</b>  |  |
|---|--|
| <b>Applicable Disk</b>                                    | DVD-ROM, CD-ROM, CD-XA, CD-I, Photo CD, Multisession, Audio, CD-R, CD-RW |
| <b>Center Hole Diameter</b>                               | 6" / 15mm  |
| <b>Access Time</b><br>(typical, including setting)        | < 100 ms (CD)<br>< 150 ms (DVD)  |
| <b>Disc Thickness</b>                                     | 4.7", 3.15" / 12cm, 8cm  |
| <b>Track Pitch</b>  | 0.74um (DVD)   |
| <b>Laser</b><br>Beam Divergence                           | .05" / 1.2cm   |
| <b>Audio Output Level</b><br>Line out<br>Headphone        | 1.0 volts RMS<br>0 - 0.6 volts RMS                                       |
| <b>Cache Buffer</b>                                       | 512 KB/s (CD)  |
| <b>Data Transfer Rate</b><br>(typical, including setting) | 12,000 - 3,000 KB/s (CD)<br>2705 KB/s (DVD)                              |
| <b>Startup Time</b>                                       | < 5 sec  |
| <b>Stop time</b>  | < 3 sec  |

### Battery Pack

| <b>Battery Pack</b>                |                               |               |
|------------------------------------|-------------------------------|---------------|
|                                    | <b>Lithium Ion (Li ion) *</b> |               |
|                                    | <b>US</b>                     | <b>Metric</b> |
| <b>Dimensions</b>                  |                               |               |
| Height                             | .81 in                        | 2.05 cm       |
| Length                             | 3.05 in                       | 7.75 cm       |
| Width                              | 5.69 in                       | 14.45 cm      |
| <b>Weight</b>                      | 0.85 lb                       | .39 kg        |
| <b>Battery Pack Operating Time</b> | 3:00 hr                       |               |

|   |                                    |
|---|------------------------------------|
| <b>Energy</b><br>Voltage<br>Amp-hour capacity<br>Watt-hour capacity                     | 14.8 V<br>3.0 Ah<br>44.4 Wh        |
| <b>Environmental Requirements</b><br>Operating Temperature<br>Non-operating Temperature | 32° F to 113 F<br>-4° F to 140 ° F |
|   | 0° to 45° C<br>-20° to 60° C       |

| Modem                   |  |
|-------------------------|--|
| <b>Compliance</b>       | ITU v.90~6 standard<br>Full ITU-T V.34 compliance<br>Full compliance with: V.21, V.22, V.22bis, V.23, V.32, V.32bis, Bell 103, Bell 212A |
| <b>Data Compression</b> | V.42bis/MNP 5  |
| <b>Fax Modulation</b>   | V. 17<br>V. 21 (Group III Compatible)<br>V.29<br>V.27Ter   |
| <b>Command Set</b>      | Hayes AT<br>Class 1 Fax  |
| <b>Cable</b>            | 6 Ft. RJ-11 telephone cable  |

[Top of Page](#)

**1.800.AT.COMPAQ**

[privacy and legal statement](#)

## Maintenance & Service Guide for Presario 1600 Series (Models 1683-1694)

[Home Page](#) | [Notice](#) | [Preface](#) | [Product Description](#) | [Troubleshooting](#) | [Illustrated Parts Catalog](#) | [Removal & Replacement Procedures](#) | [Specifications](#) | [Pin Assignments](#) | [Battery Pack Operations](#)

### Connector Pin Assignments

This appendix provides connector pin assignment tables for Compaq Presario Series Portable Computers. For more information on connectors, refer to the section on [Rear Connectors](#).

**NOTE:** The signals in all tables of this appendix are considered active high unless otherwise indicated by an asterisk (\*).

Parallel Connector



| Pin | Signal     | Pin   | Signal              |
|-----|------------|-------|---------------------|
| 1   | Strobe*    | 10    | Acknowledge*        |
| 2   | Data Bit 0 | 11    | Busy                |
| 3   | Data Bit 1 | 12    | Paper Out           |
| 4   | Data Bit 2 | 13    | Select              |
| 5   | Data Bit 3 | 14    | Auto Linefeed*      |
| 6   | Data Bit 4 | 15    | Error*              |
| 7   | Data Bit 5 | 16    | Initialize Printer* |
| 8   | Data Bit 6 | 17    | Select In*          |
| 9   | Data Bit 7 | 18-25 | Signal Ground       |

\* = Active low

### Serial Connector

| Connector  | Pin | Signal              |
|--|-----|---------------------|
|  | 1   | Carrier Detect      |
|  | 2   | Receive Data        |
|  | 3   | Transmit Data       |
|  | 4   | Data Terminal Ready |
|  | 5   | Signal Ground       |
|  | 6   | Data Set Ready      |
|  | 7   | Ready to Send       |
|  | 8   | Clear to Send       |
|  | 9   | Ring Indicator      |

### Keyboard/Mouse

| Connector  | Pin | Signal  |
|--|-----|---------|
|  | 1   | Data 1  |
|  | 2   | Data 2  |
|  | 3   | Ground  |
|  | 4   | +5 V    |
|  | 5   | Clock 1 |
|  | 6   | Clock 2 |

### External VGA Monitor

| Connector  | Pin | Signal          |
|--|-----|-----------------|
|  | 1   | Red Analog      |
|  | 2   | Green Analog    |
|  | 3   | Blue Analog     |
|  | 4   | Not connected   |
|  | 5   | Ground          |
|  | 6   | Ground Analog   |
|  | 7   | Ground Analog   |
|  | 8   | Ground Analog   |
|  | 9   | Not connected   |
|  | 10  | Ground          |
|  | 11  | Monitor Detect  |
|  | 12  | DDC2B Data      |
|  | 13  | Horizontal Sync |
|  | 14  | Vertical Sync   |
|  | 15  | DDC2B Clock     |

### Universal Serial Bus

| Connector | Pin | Signal |
|-----------|-----|--------|
|-----------|-----|--------|

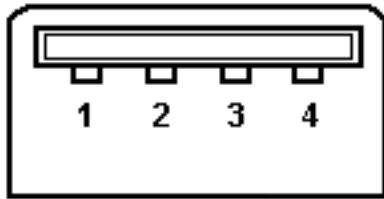

|   |        |
|---|--------|
| 1 | +5V    |
| 2 | Data - |
| 3 | Data + |
| 4 | Ground |

### Modem

#### Connector

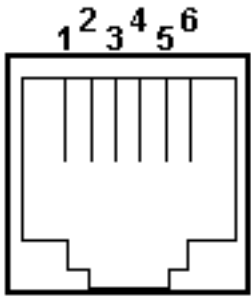

| Pin | Signal |
|-----|--------|
| 1   | Unused |
| 2   | Unused |
| 3   | Tip    |
| 4   | Ring   |
| 5   | Unused |
| 6   | Unused |

1.800.AT.COMPAQ

[privacy and legal statement](#)

## Maintenance & Service Guide for Presario 1600 Series (Models 1683-1694)

[Home Page](#) | [Notice](#) | [Preface](#) | [Product Description](#) | [Troubleshooting](#) | [Illustrated Parts Catalog](#) | [Removal & Replacement Procedures](#) | [Specifications](#) | [Pin Assignments](#) | [Battery Pack Operations](#)

### Battery Pack Operating Time

This appendix covers the following information concerning battery pack operating time:

- Increase battery pack operating time
- Conditioning a battery pack
- Disposal of a used battery pack

#### *Increasing Battery Pack Operating Time*

Battery pack operating time differs depending on several variables. To avoid unnecessary replacement, consider the following variables when determining how long a charged battery pack should last:

- Power management settings
- Hardware configuration
- Software applications
- Installed options
- Display brightness
- Hard drive usage
- Changes in operating temperature
- Type and number of installed PC Cards

**NOTE:** The power consumption requirements for PC Cards vary widely. Some cards drain the battery pack very rapidly.

Battery pack operating time can be increased by as much as 50 percent by controlling the energy required by the computer and the energy stored in the battery pack.

#### *Minimizing the Energy Required*

To minimize the energy required by the computer, follow these steps:

- Set the power conservation levels in the Power Management utility to **Maximum**.
- Customize the timeout value to work more efficiently with the applications. The amount of battery life depends on the values selected.



## Maximizing the Energy Stored

To maximize the energy stored in the battery pack, follow these guidelines:

- Condition the battery pack at least every 30 days to improve overall battery performance.
- Keep a battery pack in the computer when using it with AC power to supply the battery pack with a constant trickle charge.
- Store the battery pack in a cool, dry place when not in use.

## Conditioning a Battery Pack

**CAUTION:** To avoid a loss of data, ensure that all data is saved before discharging a battery pack.



To condition a battery pack, complete the following steps:

1. Plug in the AC adapter and allow the battery to charge until the LED light on the display stops blinking. Your battery gauge may read 100 percent for a period of time before LED light on the display stops blinking. Do not unplug the AC adapter until the arrow disappears.
2. Unplug the AC adapter and allow the battery to drain until the computer reaches hibernation and turns itself off. **Do not plug in the AC adapter during this process or you will need to restart with Step No. 1.** You may use the computer while the battery is draining.
3. Your battery is re- conditioned.
4. Plug in the AC adapter and begin using the computer.

The table below shows the approximate battery pack charge times.

| Approximate Battery Charge Time |                                 |          |
|---------------------------------|---------------------------------|----------|
| Computer                        | On Line                         | Off Line |
| NiMH Battery Pack               | 4.0 hours premature termination | 2:00 hrs |
| Li ion Battery Pack             | 4.5 hours premature termination | 2:50 hrs |

## Disposal of a Used Battery Pack

In the interest of safeguarding our environment. Compaq Computer Corporation recommends that nickel metal

hydride (NiMH) and lithium ion (Li ion) battery packs be recycled. Battery packs should be handled in accordance with country, state, province, or local regulations.



**CAUTION:** Never attempt to open or service a battery pack. Opening a battery pack not only damages the pack and makes it unusable, but also expose potentially harmful battery components.

[Top of Page](#)

1.800.AT.COMPAQ

[privacy and legal statement](#)

COMPAQ [STORE](#) | [PRODUCTS](#) | [SERVICES](#) | [SUPPORT](#) | [CONTACT US](#) | [SEARCH](#)

## Maintenance & Service Guide for Presario 1600 Series (Models 1683-1694)

[Home Page](#) | [Notice](#) | [Preface](#) | [Product Description](#) | [Troubleshooting](#) | [Illustrated Parts Catalog](#) | [Removal & Replacement Procedures](#) | [Specifications](#) | [Pin Assignments](#) | [Battery Pack Operations](#)

### Product Description

| <a href="#">Models and Features</a>             | <i>Models and Features</i> |                             |  |
|---|----------------------------|-----------------------------|--|
| <a href="#">Controls and Lights</a>             | Model 1683                 | Model 1685                  |  |
| <a href="#">Front Bezel Lights</a>              | Display                    | 12.1" TFT                   | 12.1" TFT  |
| <a href="#">Front Bezel Buttons</a>             | Processor                  | AMD-K6 350-MHz MMX          | <ul style="list-style-type: none"> <li>• AMD-K6 380-MHz MMX</li> <li>• AMD-K6 400-MHz MMX</li> </ul> |
| <a href="#">Left Side Components</a>            | Hard Drive                 | 3.2-GB                      | 4.3-GB, 4.8-GB, 6.4-GB   |
| <a href="#">Right Side Components</a>           | DVD or CD Drive            | 24x CD                      | 24x CD, 4x DVD   |
| <a href="#">Bottom of Unit</a>                  | Modem                      | 56.0 Kbps Data/Fax with PCI | 56.0 Kbps Data/Fax with PCI  |
| <a href="#">Rear Connectors</a>                 | System Memory              | 32-MB                       | 32-MB, 64-MB   |
| <a href="#">Power Management for Windows 98</a> | Model 1687                 | Model 1688                  |  |
|   | Display                    | 14.1" TFT                   | 13.3" TFT  |
|   | Processor                  | AMD-K6 380-MHz MMX          | <ul style="list-style-type: none"> <li>• AMD-K6 380-MHz MMX</li> <li>• AMD-K6 400-MHz MMX</li> </ul> |
|   | Hard Drive                 | 6.4-GB                      | 4.8-GB   |

|                        |                                 |                                      |
|------------------------|---------------------------------|--------------------------------------|
| <b>DVD or CD Drive</b> | 4x DVD                          | 24x CD                               |
| <b>Modem</b>           | 56.0 Kbps Data/Fax with PCI     | 56.0 Kbps Data/Fax with PCI          |
| <b>System Memory</b>   | 64-MB                           | 64-MB                                |
|                        | <b>Model 1690</b>               | <b>Model 1692</b>                    |
| <b>Display</b>         | 14.1" TFT                       | 12.1" TFT                            |
| <b>Processor</b>       | AMD-K6 400 MHz                  | AMD-K6II 433 MHz, AMD K6II 450 MHz   |
| <b>Hard Drive</b>      | 6.4-GB                          | 4.8-GB, 6.4-GB                       |
| <b>DVD or CD Drive</b> | 24x CD, 4x DVD                  | 24x CD, 4x DVD                       |
| <b>Modem</b>           | 56.0 Kbps Data/Fax with PCI     | 56.0 Kbps Data/Fax with PCI          |
| <b>System Memory</b>   | 64 MB                           | 64 MB                                |
|                        | <b>Model 1693</b>               | <b>Model 1694</b>                    |
| <b>Display</b>         | 14.1" TFT                       | 14.1" TFT                            |
| <b>Processor</b>       | AMD K6II 433 MHz                | AMD K6II 400-MHz<br>AMD K6II 450-MHz |
| <b>Hard Drive</b>      | 6.4-GB                          | 4.8-GB, 6.4-GB                       |
| <b>DVD or CD Drive</b> | 4x DVD                          | 4x DVD                               |
| <b>Modem</b>           | 56.0 Kbps Data/Fax with PCI     | 56.0 Kbps Data/Fax with PCI          |
| <b>System Memory</b>   | 64 MB                           | 64-MB                                |
|                        | <b>CTO (Configure to Order)</b> |                                      |
| <b>Display</b>         | 14.1" TFT                       |                                      |
| <b>Processor</b>       |                                 |                                      |
| <b>Hard Drive</b>      |                                 |                                      |
| <b>DVD or CD Drive</b> |                                 |                                      |
| <b>Modem</b>           | 56.0 Kbps Data/Fax with PCI     |                                      |
| <b>System Memory</b>   |                                 |                                      |

1.800.AT.COMPAQ



[privacy and legal statement](#)

# Maintenance & Service Guide for Presario 1600 Series (Models 1683-1694)

- [Home Page](#) | [Notice](#) | [Preface](#) | [Product Description](#) | [Troubleshooting](#) | [Illustrated Parts Catalog](#) | [Removal & Replacement Procedures](#) | [Specifications](#) | [Pin Assignments](#) | [Battery Pack Operations](#)

## Product Description

[Models and Features](#)

**[Controls and Lights](#)**

[Front Bezel Lights](#)

[Front Bezel Buttons](#)

[Left Side Components](#)

[Right Side Components](#)

[Underside of Unit](#)

[Rear Connectors](#)

[Power Management for Windows 98](#)

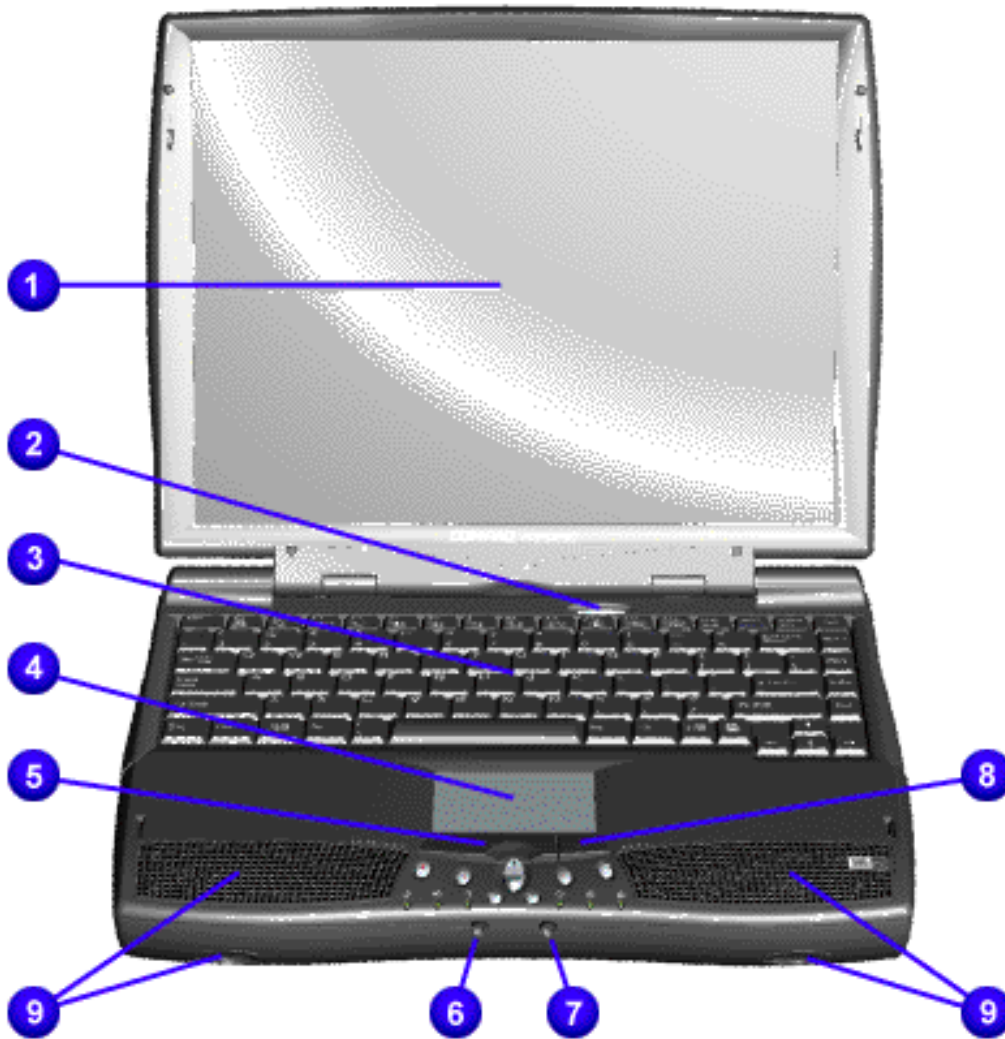

### *Controls and Lights*

1. Display
2. Power (On/Off) Button
3. Keyboard
4. Touch Pad
5. Touch Pad Button (Left)
6. Headphone Jack
7. Microphone Jack
8. Touch Pad Button (Right)
9. Front Bezel Lights

## 9. Integrated Speakers and Ports

1.800.AT.COMPAQ

[privacy and legal statement](#)

COMPAQ

[STORE](#) | [PRODUCTS](#) | [SERVICES](#) | [SUPPORT](#) | [CONTACT US](#) | [SEARCH](#)

## Maintenance & Service Guide for Presario 1600 Series (Models 1683-1694)

| [Home Page](#) | [Notice](#) | [Preface](#) | [Product Description](#) | [Troubleshooting](#) |

[Illustrated Parts Catalog](#) |

[Removal & Replacement Procedures](#) | [Specifications](#) | [Pin Assignments](#) | [Battery Pack Operations](#)

### Product Description

[Models and Features](#)

[Controls and Lights](#)

[Front Bezel Lights](#)

[Front Bezel Buttons](#)

[Left Side Components](#)

[Right Side Components](#)

[Underside of Unit](#)

[Rear Connectors](#)

[Power Management for Windows 98](#)

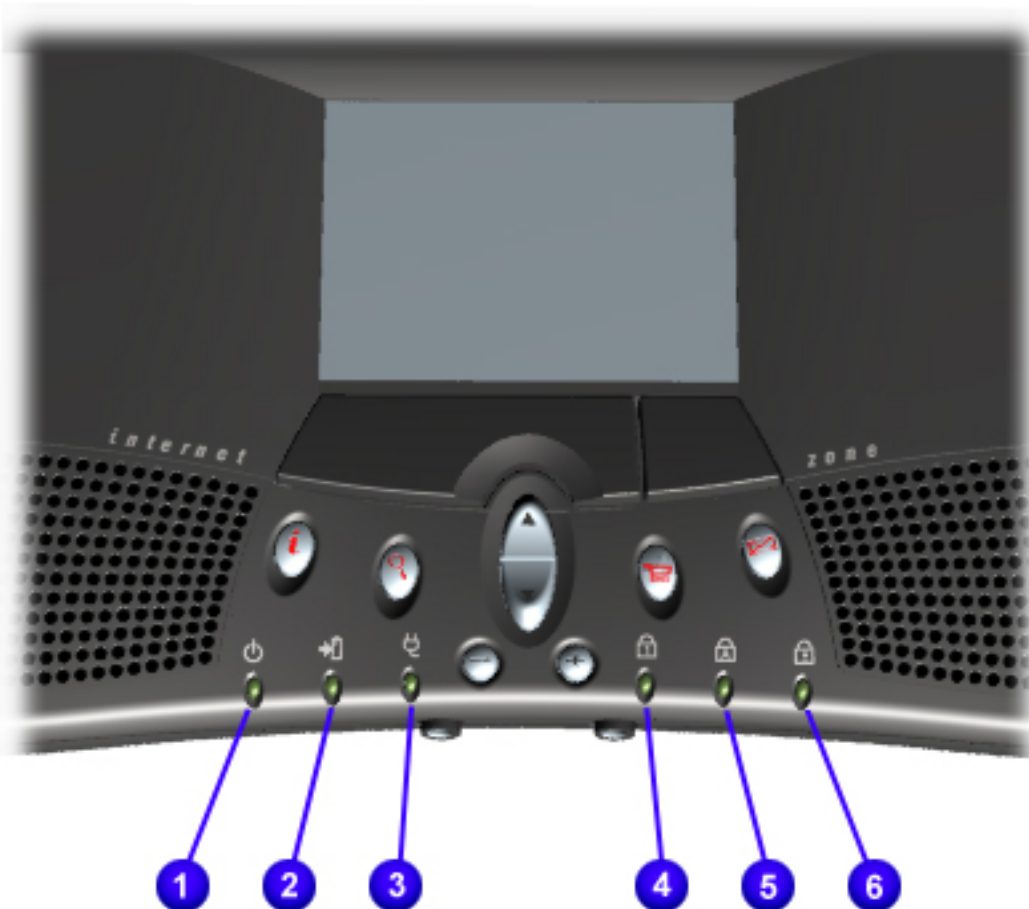

#### Front Bezel Lights

1. Power Light
2. Battery Charge Light
3. Power Cord Light
4. Num Lock Light
5. Cap Lock Light
6. Scroll Lock Light



1.800.AT.COMPAQ

[privacy and legal statement](#)

# Maintenance & Service Guide for Presario 1600 Series (Models 1683-1694)

[Home Page](#) | [Notice](#) | [Preface](#) | [Product Description](#) | [Troubleshooting](#) | [Illustrated Parts Catalog](#) |

[Removal & Replacement Procedures](#) | [Specifications](#) | [Pin Assignments](#) | [Battery Pack Operations](#)

## Product Description

[Models and Features](#)

[Controls and Lights](#)

[Front Bezel Lights](#)

**Front Bezel Buttons**

[Left Side Components](#)

[Right Side Components](#)

[Underside of Unit](#)

[Rear Connectors](#)

[Power Management for Windows 98](#)

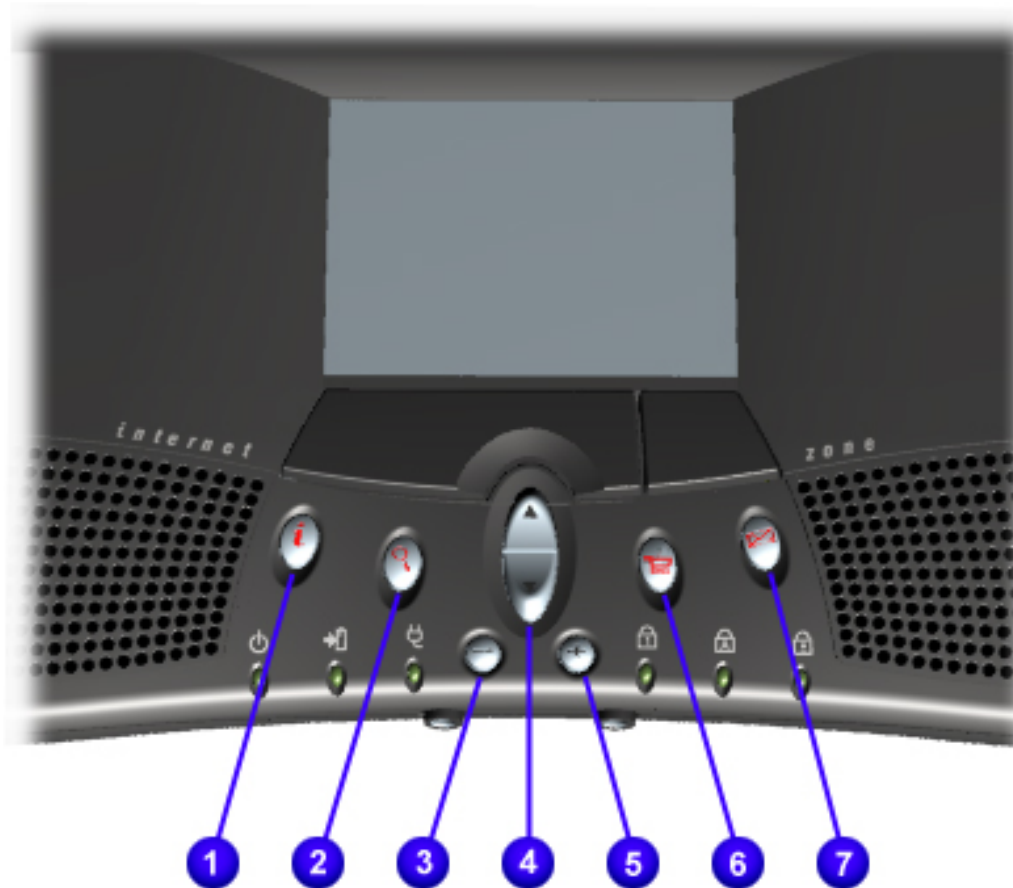

### Front Bezel Buttons

1. Instant Internet Access Button
2. Instant Search Button
3. Volume Down Button
4. Scroll Up/Down Button
5. Volume Up Button
6. Secure E-Commerce Button (or favorite Web site)

**7. Instant  
E-Mail  
Button**



[privacy and legal statement](#)

COMPAQ

[STORE](#) | [PRODUCTS](#) | [SERVICES](#) | [SUPPORT](#) | [CONTACT US](#) | [SEARCH](#)

## Maintenance & Service Guide for Presario 1600 Series (Models 1683-1694)

[Home Page](#) | [Notice](#) | [Preface](#) | [Product Description](#) | [Troubleshooting](#) | [Illustrated Parts Catalog](#) | [Removal & Replacement Procedures](#) | [Specifications](#) | [Pin Assignments](#) | [Battery Pack Operations](#)

### Product Description

[Models and Features](#)

[Controls and Lights](#)

[Front Bezel Lights](#)

[Front Bezel Buttons](#)

[Left Side Components](#)

[Right Side Components](#)

[Underside of Unit](#)

[Rear Connectors](#)

[Power Management for Windows 98](#)



#### *Left Side Components*

1. PC Card Eject Lever
2. PC Card Slot
3. Diskette Drive Slot
4. Diskette Eject Button

1.800.AT.COMPAQ

[privacy and legal statement](#)

COMPAQ

[STORE](#) | [PRODUCTS](#) | [SERVICES](#) | [SUPPORT](#) | [CONTACT US](#) | [SEARCH](#)

## Maintenance & Service Guide for Presario 1600 Series (Models 1683-1694)

[Home Page](#) | [Notice](#) | [Preface](#) | [Product Description](#) | [Troubleshooting](#) | [Illustrated Parts Catalog](#) | [Removal & Replacement Procedures](#) | [Specifications](#) | [Pin Assignments](#) | [Battery Pack Operations](#)

### Illustrated Parts Catalog

[Models and Features](#)

[Controls and Lights](#)

[Front Bezel Lights](#)

[Front Bezel Buttons](#)

[Left Side Components](#)

[Right Side Components](#)

[Underside of Unit](#)

[Rear Connectors](#)

[Power Management for Windows 98](#)



#### *Right-Side Components*

1. Battery Compartment
2. DVD or CD Drive Eject Button
3. DVD or CD Drive Manual Eject Hole

1.800.AT.COMPAQ



[privacy and legal statement](#)

COMPAQ

[STORE](#) | [PRODUCTS](#) | [SERVICES](#) | [SUPPORT](#) | [CONTACT US](#) | [SEARCH](#)

## Maintenance & Service Guide for Presario 1600 Series (Models 1683-1694)

[Home Page](#) | [Notice](#) | [Preface](#) | [Product Description](#) | [Troubleshooting](#) | [Illustrated Parts Catalog](#) | [Removal & Replacement Procedures](#) | [Specifications](#) | [Pin Assignments](#) | [Battery Pack Operations](#)

### Product Description

[Models and Features](#)

[Controls and Lights](#)

[Front Bezel Lights](#)

[Front Bezel Buttons](#)

[Left Side Components](#)

[Right Side Components](#)

[Underside of Unit](#)

[Rear Connectors](#)

[Power Management for Windows 98](#)

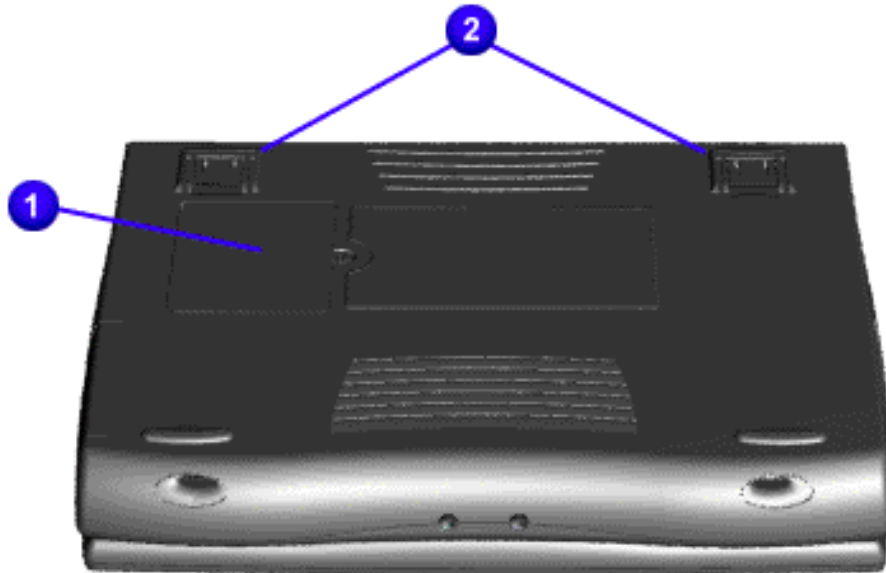

*Underside of Unit*

- 1. Memory Compartment Door
- 2. Stand Feet



1.800.AT.COMPAQ

[privacy and legal statement](#)

# Maintenance & Service Guide for Presario 1600 Series (Models 1683-1694)

| [Home Page](#) | [Notice](#) | [Preface](#) | [Product Description](#) | [Troubleshooting](#) | [Illustrated Parts Catalog](#) |

[Removal & Replacement Procedures](#) | [Specifications](#) | [Pin Assignments](#) | [Battery Pack Operations](#)

## Product Description

[Models and Features](#)

[Controls and Lights](#)

[Front Bezel Lights](#)

[Front Bezel Buttons](#)

[Left Side Components](#)

[Right Side Components](#)

[Underside of Unit](#)

[Rear Connectors](#)

[Power Management for Windows 98](#)

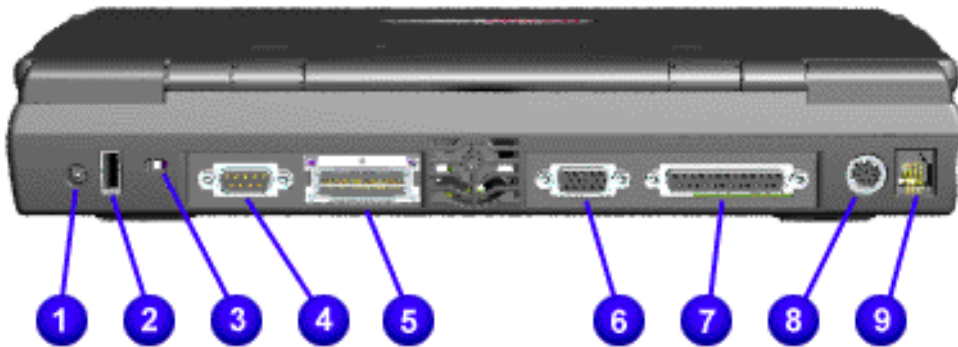

### Rear Connectors

- 1. AC Adapter
- 2. Universal Serial Bus
- 3. Security Slot
- 4. Serial Port
- 5. Port Replicator
- 6. External Monitor Port
- 7. Parallel Printer Port
- 8. Keyboard/Mouse Port
- 9. Modem Jack

1.800.AT.COMPAQ



[privacy and legal statement](#)

## Maintenance & Service Guide for Presario 1600 Series (Models 1683-1694)

[Home Page](#) | [Notice](#) | [Preface](#) | [Product Description](#) | [Troubleshooting](#) | [Illustrated Parts Catalog](#) | [Removal & Replacement Procedures](#) | [Specifications](#) | [Pin Assignments](#) | [Battery Pack Operations](#)

### Product Description

#### *Power Management for Windows 98*

The following power management features are available for conserving AC power and extending battery operating time:

- [Power Management Settings](#)
- [Sleep](#)
- [Hibernation](#)
- [Battery operating time](#)
- [Rebooting After a Lockup](#)
- [Servicing Your Computer - Full Off Mode](#)

#### *Power Management Settings*

#### *Power Management Settings*

Depending on your patterns of computer use, you can set different levels of power management. These different power management levels can be activated based on the amount of time passed since the last system activity. System activity examples include keyboard or mouse movement, CD or DVD playback (while under program control that monitors Sleep), and modem use.

You can select different conditions or power schemes through Power Management. The optional settings are **Home/Office Desk**, **Portable/ Laptop**, and **Always On**. From the default settings, you can change the following settings:

- the System goes to Sleep (Standby) mode
- the screen times out and goes blank

- the hard drive spins down

Each of these system components will go to sleep after the selected or default periods of inactivity.

(The setting for hard drive must be less than or equal to the setting for System.)

**IMPORTANT:** If you're on a network, it's recommended that you set **System Standby** to **Never**.

There are five categories of power management settings under the Control Panel. The default setting for each feature is listed below in the tables.

### *Power Management Properties*

|                                  |                  |                      |
|----------------------------------|------------------|----------------------|
| <b>Tab: Power Schemes:</b>       | Plugged in       | Running on Batteries |
| <b>Always on System Standby:</b> | Never            | 15 minutes           |
| <b>Turn OFF Monitor</b>          | After 3 hours    | Never                |
| <b>Always on System Standby:</b> | After 15 minutes | After 10 minutes     |

### *Power Management Properties*

|                               |   |
|-------------------------------|---|
| <b>Tab: Alarms: :</b>         |   |
| <b>Low Battery Alarm:</b>     | 10%   |
| <b>Critical Battery Alarm</b> | 0%  |
| <b>Alarm Actions:</b>         | X Display Message Notification                |
|                               | <b>Text Action                  No Action</b> |

### *Power Management Properties*

|                          |         |
|--------------------------|---------|
| <b>Tab: Power Meter:</b> | Default |
| <b>Tab: Advanced</b>     | Default |

### *Display Properties*

**Tab: Monitor:** Laptop Display (Maximum resolution according to unit display size)

## Sleep

You can select Sleep mode instead of turning off the computer when you have finished using it. This allows the computer to wake up faster than turning it completely off and saves power over the active (On) mode. Compaq Presario Series Notebook computers have two levels of sleep, Hibernation and Sleep.

**Hibernation** - by pushing the power button once your computer will perform a save to disk followed by a shut down of the computer into Off mode.

**Sleep** - is a low power mode, also referred to as Standby mode. While in Sleep mode, your computer will maintain system information and open files. Unsaved information will be lost if you turn off your system prior to system wake-up, or if you lose power while using the AC adapter.

|  |  |
|--|--|
|  | <b>CAUTION:</b> While in Sleep mode, your computer will maintain system information and open files. Unsaved information will be lost if you turn off your system prior to system wake-up, or if you lose power while using the AC adapter. |
|--|--|

## Hibernation Mode

Hibernation helps conserve battery life and protects your data. Hibernation can be a routine power saving event, or can be the result of a low battery condition. As it enters Hibernation your computer will display a progress screen, as it automatically saves the machine state before it shuts down and turns itself off. Your computer will automatically go into Hibernation, when the battery has little power left, or when the system (operating on battery power) has been in Sleep mode for more than an hour. You can also manually initiate Hibernation by pressing the power button once while the system is active. To restore the computer's previous state, simply press the power button once again. While waking up, the computer will display a progress screen.

The following table shows the conditions and indicators for getting in and out of the various power management modes, Sleep, Hibernation, and Off.

| Mode  | To Initiate                               | To End        | Indicators               |
|-------|---|---------------|--------------------------|
| Sleep | Manual keys combination<br>- <b>Fn+F4</b> | Press any key | Flashing green Power LED |

|                  |   |                                |                            |
|------------------|---|--------------------------------|----------------------------|
|                  | <u>Time Out Default</u><br>15 minutes. If on Battery power (system will not go to Sleep if on AC power)       |                                |                            |
| <b>Hibernate</b> | <u>Manual</u> - Press Power button once   | Press <b>Power</b> button once | No Power LED, blank screen |
|                  | <u>Time Out Default</u><br>If low battery or after 1 hour of sleep (system will not Hibernate if on AC power) |                                |                            |
| <b>Off</b>       | Perform normal Windows shutdown via the start button, or press and hold down the power button for 4 seconds   | Press <b>Power</b> button once | No Power LED, blank screen |

### **Service Your Computer - Full Off Mode**

If you need to install or replace components in your system, you must turn the computer off *completely*. Follow the instructions above for properly putting the computer into Off mode, unplug from the outlet, and remove the battery (see battery section for [instruction on removing battery](#)).

### **Rebooting After a Lockup**

Occasionally you may encounter a frozen keyboard or a locked screen. To reboot your computer (as if from a cold start) press and hold down the Power Button for at least four seconds, which will cause a manual shutdown. Then, restart it with a single press of the Power Button. If it still doesn't recover, press the Power Button and hold it for four seconds to shut it down, then, remove the battery or unplug the AC power for at least 30 seconds. Reinsert the battery or reconnect AC power and press the Power Button once to reboot.

## ***Battery Operating Time***

Battery operating time is affected by variables, such as the following:

- Power conservation settings
- Hardware configuration
- Software applications
- Installed options
- Display brightness
- Hard drive usage
- Power button
- Changes in operating temperature
- Type and number of installed PC Cards

For more information on increasing battery pack operating time, conditioning the battery pack, and disposing of a used battery pack, refer to the [Battery Pack Operations](#).

[Top of Page](#)

1.800.AT.COMPAQ

[privacy and legal statement](#)



## Maintenance & Service Guide for Presario 1600 Series (Models 1683-1694)

| [Home Page](#) | [Notice](#) | [Preface](#) | [Product Description](#) | [Troubleshooting](#) | [Illustrated Parts Catalog](#) | [Removal & Replacement Procedures](#) | [Specifications](#) | [Pin Assignments](#) | [Battery Pack Operations](#)

### Troubleshooting

#### *Preliminary Steps*

Before running [POST](#), complete the following preliminary steps:

1. If a power-on password has been established, type the password and press the **Enter** key. If the password is not known, [clear the password](#).
2. Run [Computer Checkup](#).
3. Turn off the computer and its external devices.
4. Disconnect any external devices that you do not want to test. Do not disconnect the printer if you want to test it or use it to log error messages.

#### **IMPORTANT:**

If the problem only occurs when an external device is connected to the computer, the problem may be related to the external device or its cable. Verify this by running POST with and without the external device connected.

5. Install loopback plugs in the serial and parallel connectors if you would like to test these ports.
6. Ensure the hard drive is installed in the computer.
7. Ensure that the battery pack is inserted in the computer and the computer is connected to an external AC power source.

When the preliminary steps are completed, you are ready to run [POST](#).

1.800.AT.COMPAQ

[privacy and legal statement](#)

## Maintenance & Service Guide for Presario 1600 Series (Models 1683-1694)

| [Home Page](#) | [Notice](#) | [Preface](#) | [Product Description](#) | [Troubleshooting](#) |  
[Illustrated Parts Catalog](#) |  
[Removal & Replacement Procedures](#) | [Specifications](#) | [Pin Assignments](#) | [Battery  
Pack Operations](#)

### Troubleshooting

#### *Clearing the CMOS Password*

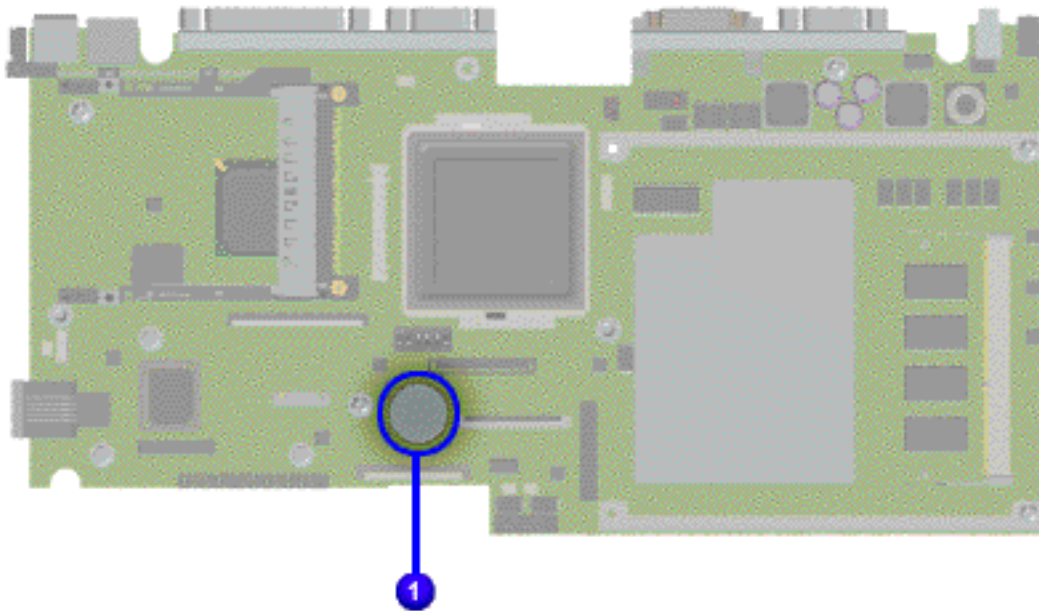

Clearing the power-on password requires removing all Setup attributes that are programmed in the CMOS. The **1** RTC battery is located on the system board.

If the password is not known, clear it by performing the following steps:

1. Turn off the computer.
2. Disconnect the power cord.
3. Remove the [battery pack](#).
4. Remove the [Palmrest](#)

[Cover with Touch Pad.](#)

5. Remove the [heatspreader.](#)

6. Remove the [keyboard.](#)

7. Remove RTC battery for 30 seconds and replace it .

8. Reassemble the computer.

9. Turn on the computer to verify that the power-on password has been cleared. If it has not been cleared, repeat Steps 1 through 9.

1.800.AT.COMPAQ

[privacy and legal statement](#)

COMPAQ

[STORE](#) | [PRODUCTS](#) | [SERVICES](#) | [SUPPORT](#) | [CONTACT US](#) | [SEARCH](#)

## Maintenance & Service Guide for Presario 1600 Series (Models 1683-1694)

[Home Page](#) | [Notice](#) | [Preface](#) | [Product Description](#) | [Troubleshooting](#) | [Illustrated Parts Catalog](#) | [Removal & Replacement Procedures](#) | [Specifications](#) | [Pin Assignments](#) | [Battery Pack Operations](#)

## Troubleshooting

### Running POST

To run POST, complete the following steps:

Turn off the computer, then turn on the computer.

If POST does not detect any errors, the computer will not beep. This indicates successful completion of POST test. POST has run successfully and boots from the hard drive (or from a bootable diskette if one is installed in the diskette drive).

If POST detects errors, the errors are indicated by screen and/or audible messages. Refer to "Power-On Self-Test (POST) Codes" in the tables for a list of POST codes and their relevant descriptions.

**NOTE:** If the system is not functioning well enough to run POST, or if the display is not functioning well enough to show POST error messages, refer to the Troubleshooting tables.

**NOTE:** The following routines are sorted by their test point numbers assigned in the BIOS code. Their actual orders as executed during POST can be quite different.

| Code | Beeps | POST Routine Description            |
|------|-------|-------------------------------------|
| 02h  |       | Verify Real Mode                    |
| 03h  |       | Disable Non-Maskable Interrupt (NM) |
| 04h  |       | Get CPU type                        |
| 06h  |       | Initialize system hardware          |

|      |         |  |
|------|---------|--|
| 08h  |         | Initialize chipset with Initial POST values              |
| 09h  |         | Set IN POST flag   |
| 0Ah  |         | Initialize CPU registers                                 |
| 0Bh  |         | Enable CPU cache   |
| 0Ch  |         | Initialize caches to initial POST values                 |
| 0Eh  |         | Initialize I/O component                                 |
| 0Fh  |         | Initialize the local bus IDE                             |
| 10h  |         | Initialize Power Management                              |
| 11h  |         | Load alternate registers with initial POST values        |
| 12h  |         | Restore CPU control word during warm boost               |
| 13h  |         | Initialize PCI Bus Mastering devices                     |
| 14h  |         | Initialize keyboard controller                           |
| 16h  | 1-2-2-3 | BIOS ROM Checksum  |
| 17h  |         | Initialize cache before memory autosize                  |
| 18h  |         | 8254 timer initialization                                |
| 1Ah  |         | 8237 DMA controller initialization                       |
| 1Ch  |         | Reset Programmable Interrupt Controller                  |
| 20h  | 1-3-1-1 | Test DRAM refresh  |
| 22h  | 1-3-1-3 | Test 8742 Keyboard Controller                            |
| 24h  |         | Set ES segment register to 4 GB                          |
| 26h  |         | Enable A20 line  |
| 28h  |         | Autosize DRAM  |
| 29h  |         | Initialize POST Memory Manager                           |
| 2Ah  |         | Clear 512 KB base RAM                                    |
| 2Ch  | 1-3-4-2 | RAM failure on address line xxxx*                        |
| 2Eh  | 1-3-4-3 | RAM failure on data bits xxxx* of low byte of memory bus |
| 2Fh  |         | Enable cache before system BIOS shadow                   |
| 30th | 1-4-1-1 | RAM failure on data bits xxxx*of high byte memory bus    |
| 32h  |         | Test CPU bus-clock frequency                             |
| 33h  |         | Initialize Phoenix Dispatch Manager                      |

|      |         |   |
|------|---------|---|
| 36h  |         | Warm start shut down                        |
| 38h  |         | Shadow system BIOS ROM                      |
| 3Ah  |         | Autosize cache                              |
| 3Ch  |         | Advanced configuration of chipset registers |
| 3Dh  |         | Load alternate registers with CMOS values   |
| 42h  |         | Initialize interrupt vectors                |
| 45h  |         | POST device initialization                  |
| 46h  | 2-1-2-3 | Check ROM copyright notice                  |
| 48h  |         | Check Video configuration against CMOS      |
| 49h  |         | Initialize PCI bus and devices              |
| 4Ah  |         | Initialize all video adapters in system     |
| 4Bh  |         | QuietBoot start (optional)                  |
| 4Ch  |         | Shadow video BIOS ROM                       |
| 4Eh  |         | Display BIOS copyright notice               |
| 50Eh |         | Display CPU type and speed                  |
| 51h  |         | Initialize EISA board                       |
| 52h  |         | Test keyboard                               |
| 54h  |         | Set key click if enabled                    |
| 58h  | 2-2-3-1 | Test for unexpected interrupts              |
| 59h  |         | Initialize POST display service             |
| 5Ah  |         | Display prompt "Press F2 to enter SetUP"    |
| 5Bh  |         | Disable CPU cache                           |
| 5Ch  |         | Test RAM between 512 and 640 KB             |
| 60h  |         | Test extended memory                        |
| 62h  |         | Test extended memory address lines          |
| 64h  |         | Jump to UserPatch1                          |
| 66h  |         | Configure advanced cache registers          |
| 67h  |         | Initialize Multi Processor APIC             |
| 68h  |         | Enable external and CPU cache               |
| 69h  |         | Setup System Management Mode (SMM) area     |
| 6Ah  |         | Display external L2 cache size              |

|     |     |   |
|-----|-----|---|
| 6Bh |     | Load custom defaults (optional)                                       |
| 6Ch |     | Display shadow-area message   |
| 6Eh |     | Display possible high address for UMB recovery                        |
| 70h |     | Display error messages  |
| 72h |     | Check for configuration errors  |
| 76h |     | Check for keyboard errors   |
| 7Ch |     | Set up hardware interrupt vectors                                     |
| 7Eh |     | Initialize coprocessor if present                                     |
| 80h |     | Disable onboard Super I/O ports and IRQs                              |
| 81h |     | Late POST device initialization                                       |
| 82h |     | Detect and install external RS232 ports                               |
| 83h |     | Configure non-MCD IDE controllers                                     |
| 84h |     | Detect and install external parallel ports                            |
| 85h |     | Initialize PC-compatible PnP ISA devices                              |
| 86h |     | Reinitialize onboard I/O ports  |
| 87h |     | Configure Motherboard Configurable Devices (optional)                 |
| 88h |     | Initialize BIOS Data Area   |
| 89h |     | Enable Non-Maskable Interrupts (NMIs)                                 |
| 8Ah |     | Initialize Extended BIOS Data Area                                    |
| 8Bh |     | Test and initialize PS/2 mouse  |
| 8Ch |     | Initialize floppy controller  |
| 81h |     | Determine number of ATA drives (optional)                             |
| 90h |     | Initialize hard disk controllers                                      |
| 91h |     | Initialize local-bus hard disk controllers                            |
| 92h |     | Jump to UserPatch2  |
| 93h |     | Build MPTABLE for multi-processor boards                              |
| 95h |     | Install CD ROM for boot   |
| 96h |     | Clear huge ES segment register  |
| 97h |     | Fixup Multi Processor table   |
| 98h | 1-2 | Search for option ROMs. One long, two short beeps on checksum failure |



|      |   |  |
|------|---|--|
| 99h  |   | Check for SMART drive (optional)             |
| 9Ah  |   | Shadow option ROMs                           |
| 9Ch  |   | Set up Power Management                      |
| 9Dh  |   | Initialize security engine (optional)        |
| 9Eh  |   | Enable hardware interrupts                   |
| 9Fh  |   | Determine number of ATA and SCSI drives      |
| A0h  |   | Set time of day                              |
| A2h  |   | Check key lock                               |
| A4h  |   | Initialize Typematic rate                    |
| A8h  |   | Erase F2 prompt                              |
| AAh  |   | Scan for F2 key stroke                       |
| ACh  |   | Enter Setup                                  |
| A Eh |   | Clear Boot flag                              |
| B0h  |   | Check for errors                             |
| B2h  |   | POST done - prepare to boot operating system |
| B4h  | 1 | One shot beep before boot                    |
| B5h  |   | Terminate QuietBoot (optional)               |
| B6h  |   | Check password (optional)                    |
| B9h  |   | Prepare Boot                                 |
| BAh  |   | Initialize DMI Parameters                    |
| BBh  |   | Initialize PnP Option ROMs                   |
| BCh  |   | Clear parity checkers                        |
| BDh  |   | Display MultiBoot menu                       |
| BEh  |   | Clear screen (optional)                      |
| BFh  |   | check virus and back up reminders            |
| C0h  |   | Try to boot with INT 19                      |
| C1h  |   | Initialize POST Error Manager (PEM)          |
| C2h  |   | Initialize error logging                     |
| C3h  |   | Initialize error display function            |
| C4h  |   | Initialize system error handler              |
| C5h  |   | PnPnd dual CMOS (optional)                   |

|     |  |
|-----|--|
| C6h | Initialize notebook docking (optional) |
| C7h | Initialize notebook docking late       |
| C8h | Force check (optional)                 |
| C9h | Extended checksum (optional)           |
| D2h | Unknown interrupts                     |

| <b>Code</b> | <b>Beeps</b> | <b>For Boost Block in Flash ROM</b> |
|-------------|--------------|-------------------------------------|
| E0h         |              | Initialize the chipset              |
| E1h         |              | Initialize the bridge               |
| E2h         |              | Initialize the CPU                  |
| E3h         |              | Initialize system timer             |
| E4h         |              | Initialize system I/O               |
| E5h         |              | Check force recovery boot           |
| E6h         |              | Checksum BIOS ROM                   |
| E7h         |              | Go to BIOS                          |
| E8h         |              | Set Huge Segment                    |
| E9h         |              | Initialize Multi Processor          |
| EAh         |              | Initialize OEM Special code         |
| EBh         |              | Initialize PIC and DMA              |
| ECh         |              | Initialize Memory type              |
| EDh         |              | Initialize Memory size              |
| EEh         |              | Shadow Boot Block                   |
| EFh         |              | System memory test                  |
| F0h         |              | Initialize interrupts vectors       |
| F1h         |              | Initialize Run Time Clock           |
| F2h         |              | Initialize Video                    |
| F3h         |              | Initialize beeper                   |
| F4h         |              | Initialize boot                     |
| F5h         |              | Clear Huge segment                  |
| F6h         |              | Boot to Mini DOS                    |
| F7h         |              | Boot to Full DOS                    |



[privacy and legal statement](#)

## Maintenance & Service Guide for Presario 1600 Series (Models 1683-1694)

| [Home Page](#) | [Notice](#) | [Preface](#) | [Product Description](#) | [Troubleshooting](#) |  
[Illustrated Parts Catalog](#) |  
[Removal & Replacement Procedures](#) | [Specifications](#) | [Pin Assignments](#) | [Battery  
Pack Operations](#)

---

### Troubleshooting

#### Compaq Diagnostics

Compaq Diagnostics is installed on the hard drive of the computer. Run the Diagnostics utilities when you want to view or test system information and if you have installed or connected devices. If you run Compaq Diagnostics from a diskette, ensure that it is version 10.11 or later.

The Diagnostics menu includes the following utilities:

- [Computer Checkup \(TEST\)](#)
- [View System Information \(INSPECT\)](#)
- [Prepare Computer for a Compaq Service Call \(RemotePaq\)](#)

If you have a problem you cannot solve, run the Diagnostics utilities before you call for support. Run Computer Checkup and select to save the device list to a file and to print or to save the log of errors. Run the View System Information (INSPECT) utility and select to print or to save that information. Have the files or the printed information available when you call for support.

#### Computer Checkup (TEST)

Computer Checkup (TEST) determines whether the various computer components and devices are recognized by the system and are functioning properly. You can display, print, or save the information generated by Computer Checkup.

Follow these steps to run Computer Checkup:

1. Plug the computer into an external power source. (A low battery condition could interrupt the program.)
2. Turn on the external devices that you want to test. Connect the printer if you want to print a log of error messages.
3. Insert the Compaq Diagnostics diskette in drive A.
4. Turn on or restart the computer. The computer starts from drive A, and the **Diagnostics Welcome** screen appears.
5. Press **Enter** to continue. The **Diagnostics** menu appears.
6. Select Computer Checkup from the **Diagnostics** menu. A **Test Option** menu appears.
7. Select **View the Device List** from the **Test Option** menu. A list of the installed Compaq devices appears.
8. If the list of installed devices is correct, select **OK**. The **Test Option** menu appears.

**NOTE:** If the list is incorrect, ensure that any new devices are installed properly.

9. Select one of the following from the **Test Option** menu:
  - Quick Check Diagnostics. Runs a quick, general test on each device with a minimal number of prompts. If errors occur, they display when the testing is complete. You cannot print or save the error messages.
  - Automatic Diagnostics. Runs unattended, maximum testing of each device with minimal prompts. You can choose how many times to run the tests, to stop on errors, or to print or save a log of errors.
  - Prompted Diagnostics. Allows maximum control over testing the devices. You can choose attended or unattended testing, decide to stop on errors, or choose to print or save a log of errors.
10. Follow the instructions on the screen as the devices are tested. When testing is complete, the **Test Option** menu appears.
11. Exit the **Test Option** menu.
12. Exit the **Diagnostics** menu.

## View System Information (INSPECT)

The View System Information (INSPECT) utility provides information about the computer and installed or connected devices. You can display, print, or save the information.

Follow these steps to run View System Information (INSPECT) from the Compaq Diagnostics diskette:

1. Turn on the external devices that you want to test. Connect the printer if you want to print the information.
2. Insert the Compaq Diagnostics diskette in drive A.
3. Turn on or restart the computer. The computer starts from drive A, and the **Diagnostics Welcome** screen appears.
4. Press **Enter** to continue. The Diagnostics menu appears.
5. Select **View System Information (INSPECT)** from the **Diagnostics** menu.
6. Select the item you want to view from the following list:

|                |                  |
|----------------|------------------|
| System         | Memory           |
| ROM            | Audio            |
| Keyboard       | Operating system |
| System ports   | System files     |
| System storage | Windows files    |
| Graphics       |                  |

7. Follow the instructions on the screen to cycle through the screens, to return to the list and choose another item, or to print the information.

1.800.AT.COMPAQ

[privacy and legal statement](#)

COMPAQ

[STORE](#) | [PRODUCTS](#) | [SERVICES](#) | [SUPPORT](#) | [CONTACT US](#) | [SEARCH](#)

## Maintenance & Service Guide for Presario 1600 Series (Models 1683-1694)

| [Home Page](#) | [Notice](#) | [Preface](#) | [Product Description](#) | [Troubleshooting](#) | [Illustrated Parts Catalog](#) | [Removal & Replacement Procedures](#) | [Specifications](#) | [Pin Assignments](#) | [Battery Pack Operations](#)

### Troubleshooting

#### Diagnostic Error Codes

Diagnostic error codes occur if the system recognizes a problem while running the Compaq Diagnostic program. These error codes help identify possibly defective subassemblies.

The following tables list error codes, a description of the error condition, and the action required to resolve the error condition.

**IMPORTANT:** Retest the system after completing each step. If the problem has been resolved, do not proceed with the remaining steps.

For the removal and replacement of a particular subassembly, see [Removal and Replacement Procedures](#).

Select error codes by number or type:

[101 through 114](#)

[Processor Test](#)

[200 through 215](#)

[Memory Test](#)

[300 through 304](#)

[Keyboard Test](#)

[401 through 403](#)

[Parallel Printer Test](#)

[600 through 699](#)

[Diskette Drive Test](#)

[1101](#)

[Serial Test](#)

[1701 through 1736](#)

[Hard Drive Test](#)

[501 through 516](#)

[Video Test](#)

[2402 through 2456](#)

[Audio Test](#)

[2458 through 2480](#)

[Touch Pad Pointing Device Test](#)

[3206](#)

[CD Test](#)

[8601 through 8602](#)

[3301 through 6623](#)

### Processor Test Error Codes

| Error Code | Description                              | Recommended Action  |
|------------|--|---|
| 101-xx     | CPU test failed                          | Replace the processor and retest.   |
| 102-xx     | Coprocessor or Weitek Error              | 1. Run the Configuration and Diagnostics Utilities.<br>2. Replace the processor board and retest. |
| 103-xx     | DMA page registers test failed           | Replace the system board and retest.  |
| 104-xx     | Interrupt controller master test failed  |   |
| 105-xx     | Port 61 error                            |   |
| 106-xx     | Keyboard controller self-test failed     |   |
| 107-xx     | CMOS RAM test failed                     |   |
| 108-xx     | CMOS interrupt test failed               |   |
| 109-xx     | CMOS clock test failed                   |   |
| 110-xx     | Programmable timer load data test failed |   |
| 113-xx     | Protected mode test failed               |   |
| 114-01     | Speaker test failed                      |   |

### Memory Test Error Codes

|        |                                   |   |
|--------|-----------------------------------|---|
| 200-xx | Memory machine ID test failed     | 1. Flash the system ROM and retest.<br>2. Replace the system board and retest.        |
| 202-xx | Memory system ROM checksum failed |   |
| 203-xx | Write/Read test failed            | 1. Remove the memory module and retest.<br>2. Install a new memory module and retest. |
| 204-xx | Address test failed               |   |



|        |                            |
|--------|----------------------------|
| 211-xx | Random pattern test failed |
| 214-xx | Noise test failed          |
| 215-xx | Random address test failed |

### Keyboard Test Error Codes

|        |                                |  |
|--------|--------------------------------|--|
| 300-xx | Failed ID Test                 | <ol style="list-style-type: none"> <li>1. Check the keyboard connection. If disconnected, turn off the computer and connect the keyboard.</li> <li>2. Replace the keyboard and retest.</li> <li>3. Replace the system board and retest.</li> </ol> |
| 301-xx | Failed Selftest/Interface Test |  |
| 302-xx | Failed Individual Key Test     |  |
| 304-xx | Failed Keyboard Repeat Test    |  |

### Parallel Printer Test Error Codes

|        |                                 |  |
|--------|---------------------------------|--|
| 401-xx | Printer failed or not connected | <ol style="list-style-type: none"> <li>1. Connect the printer.</li> <li>2. Check power to the printer.</li> <li>3. Install the loop-back connector and retest.</li> <li>4. Check port and IRQ configuration.</li> <li>5. Replace the system board and retest.</li> </ol> |
| 402-xx | Failed Port Test                |  |
| 403-xx | Printer pattern test failed     |  |

### Diskette Drive Test

|        |   |   |  |
|--------|---|---|--|
| 600-xx | Diskette ID drive types test failed       | <ol style="list-style-type: none"> <li>1. Replace the diskette media and retest.</li> <li>2. Check and/or replace the diskette power and signal cables and retest.</li> <li>3. Replace the diskette drive and retest.</li> <li>4. Replace the system board and retest.</li> </ol> |  |
| 601-xx | Diskette format failed                    |   |  |
| 602-xx | Diskette read test failed                 |   |  |
| 603-xx | Diskette write, read, compare test failed |   |  |
| 604-xx | Diskette random read test failed          |   |  |
| 605-xx | Diskette ID media failed                  |   |  |
| 606-xx | Diskette speed test failed                |   |  |
| 609-xx | Diskette reset controller test failed     |   |  |
| 610-xx | Diskette change line test failed          |   |  |
| 697-xx | Diskette type error                       |   |  |
| 698-xx | Diskette drive speed not within limits    |   |  |
| 699-xx | Diskette drive/media ID error             |   | <ol style="list-style-type: none"> <li>1. Replace media.</li> <li>2. Run the Configuration and Diagnostics Utilities.</li> </ol> |

### Serial Test Error Codes

|         |                         |  |
|---------|-------------------------|--|
| 1101-xx | Serial port test failed | <ol style="list-style-type: none"> <li>1. Check port configuration</li> <li>2. Replace the system board and retest.</li> </ol> |
|---------|-------------------------|--|

### Hard Drive Test Error Codes

|         |   |   |
|---------|---|---|
| 1701-xx | Hard drive format test failed             | <ol style="list-style-type: none"> <li>1. Run the Configuration and Diagnostics Utilities and verify drive type.</li> <li>2. Verify that all secondary drives have secondary drive capability.</li> <li>3. Replace the hard drive and retest.</li> <li>4. Replace the system board and retest.</li> </ol> |
| 1702-xx | Hard drive read test failed               |   |
| 1703-xx | Hard drive write/read/compare test failed |   |
| 1704-xx | Hard drive random seek test failed        |   |
| 1705-xx | Hard drive controller test failed         |   |
| 1706-xx | Hard drive ready test failed              |   |
| 1707-xx | Hard drive recalibration test failed      |   |
| 1708-xx | Hard drive format bad track test failed   |   |
| 1709-xx | Hard drive reset controller test failed   |   |
| 1710-xx | Hard drive park head test failed          |   |
| 1715-xx | Hard drive head select test failed        |   |
| 1716-xx | Hard drive conditional format test failed |   |
| 1717-xx | Hard drive ECC* test failed               |   |
| 1719-xx | Hard drive power mode test failed         |   |
| 1724-xx | Network preparation test failed           |   |
| 1736-xx | Drive monitoring test failed              |   |

\* ECC = Error Correction Code

### Video Test Error Codes

|        |  |   |
|--------|--|---|
| 501-xx | Video controller test failed                         | <p>The following apply to error codes 501-xx through 516-xx:</p> <ol style="list-style-type: none"> <li>1. Disconnect external monitor and test with internal LCD display.</li> <li>2. Replace the display assembly and retest.</li> <li>3. Replace the system board and retest.</li> </ol> |
| 502-xx | Video memory test failed                             |   |
| 503-xx | Video attribute test failed                          |   |
| 504-xx | Video character set test failed                      |   |
| 505-xx | Video 80 x 25 mode 9 x 14 character cell test failed |   |
| 506-xx | Video 80 x 25 mode 8 x 8 character cell test failed  |   |

|         |  |  |
|---------|--|--|
| 507-xx  | Video 40 x 25 mode test failed                       |  |
| 508-xx  | Video 320 x 200 mode color set 0 test failed         |  |
| 509-xx  | Video 320 x 200 mode color set 1 test failed         |  |
| 510-xx  | Video 640 x 200 mode test failed                     |  |
| 511-xx  | Video screen memory page test failed                 |  |
| 512-xx  | Video gray scale test failed                         |  |
| 514-xx  | Video white screen test failed                       |  |
| 516-xx  | Video noise pattern test failed                      |  |
| 2402-xx | Video memory test failed                             | <p>The following steps apply to error codes 2402-xx through 2456-xx:</p> <ol style="list-style-type: none"> <li>1. Run the Configuration and Diagnostics Utilities.</li> <li>2. Replace the display assembly and retest.</li> <li>3. Replace the system board and retest.</li> </ol> |
| 2403-xx | Video attribute test failed                          |  |
| 2404-xx | Video character set test failed                      |  |
| 2405-xx | Video 80 x 25 mode 9 x 14 character cell test failed |  |
| 2406-xx | Video 80 x 25 mode 8 x 8 character cell test failed  |  |
| 2408-xx | Video 320 x 200 mode color set 0 test failed         |  |
| 2409-xx | Video 320 x 200 mode color set 1 test failed         |  |
| 2410-xx | Video 640 x 200 mode test failed                     |  |
| 2411-xx | Video screen memory page test failed                 |  |
| 2412-xx | Video gray scale test failed                         |  |
| 2414-xx | Video white screen test failed                       |  |
| 2416-xx | Video noise pattern test failed                      |  |
| 2418-xx | ECG/VGC memory test failed                           |  |
| 2419-xx | ECG/VGC ROM checksum test failed                     |  |
| 2421-xx | ECG/VGC 640 x 200 graphics mode test failed          |  |

|         |  |  |
|---------|--|--|
| 2422-xx | ECG/VGC 640 x 350 16 color set test failed       | retest.<br>4. Replace the system board and retest. |
| 2423-xx | ECG/VGC 640 x 350 64 color set test failed       |  |
| 2424-xx | ECG/VGC monochrome text mode test failed         |  |
| 2425-xx | ECG/VGC monochrome graphics mode test failed     |  |
| 2431-xx | 640 x 480 graphics test failure                  |  |
| 2432-xx | 320 x 200 graphics (256 color mode) test failure |  |
| 2448-xx | Advanced VGA Controller test failed              |  |
| 2451-xx | 132-column Advanced VGA test failed              |  |
| 2456-xx | Advanced VGA 256 Color test failed               |  |
| 2458-xx | Advanced VGA BitBLT test                         |  |
| 2468-xx | Advanced VGA DAC test                            |  |
| 2477-xx | Advanced VGA data path test                      |  |
| 2478-xx | Advanced VGA BitBLT test                         |  |
| 2480-xx | Advanced VGA LineDraw test                       |  |

**Audio Test Error Codes**

|         |                             |                                      |
|---------|-----------------------------|--------------------------------------|
| 3206-xx | Audio System Internal Error | Replace the system board and retest. |
|---------|-----------------------------|--------------------------------------|

**TouchPad/Pointing Device Interface Test Error Codes**

|         |                       |  |
|---------|-----------------------|--|
| 8601-xx | Mouse test failed     | 1. Replace the TouchPad and retest.<br>2. Replace the system board and retest. |
| 8602-xx | Interface test failed |  |

**CD Drive Test Error Codes**

|         |                           |  |
|---------|---------------------------|--|
| 3301-xx | CD drive read test failed | <ol style="list-style-type: none"><li>1. Replace the CD and retest.</li><li>2. Verify that the speakers are connected.</li><li>3. Verify that drivers are loaded and properly installed.</li><li>4. Replace the CD drive and retest.</li><li>5. Replace the system board and retest.</li></ol> |
| 3305-xx | CD drive seek test failed |  |
| 6600-xx | ID test failed            |  |
| 6605-xx | Read test failed          |  |
| 6608-xx | Controller test failed    |  |
| 6623-xx | Random read test failed   |  |

[\*\*\*Back to top\*\*\*](#)

**1.800.AT.COMPAQ**

[privacy and legal statement](#)

## Maintenance & Service Guide for Presario 1600 Series (Models 1683-1694)

[Home Page](#) | [Notice](#) | [Preface](#) | [Product Description](#) | [Troubleshooting](#) | [Illustrated Parts Catalog](#) | [Removal & Replacement Procedures](#) | [Specifications](#) | [Pin Assignments](#) | [Battery Pack Operations](#)

### Troubleshooting Without Diagnostics

This section provides information about how to identify and correct some common hardware, memory, and software problems. It also explains several types of common messages that may be displayed on the screen. The following pages contain troubleshooting information on:

|   |
|---|
| <a href="#">Audio</a>                   |
| <a href="#">Battery/Battery gauge</a>   |
| <a href="#">CD drive</a>                |
| <a href="#">Diskette/Diskette drive</a> |
| <a href="#">Display</a>                 |
| <a href="#">Hard drive</a>              |
| <a href="#">Hardware Installation</a>   |
| <a href="#">Memory</a>                  |
| <a href="#">PC Card</a>                 |
| <a href="#">Power</a>                   |
| <a href="#">Printer</a>                 |
| <a href="#">Touch Pad</a>               |
| <a href="#">Keyboard/Numeric Keypad</a> |

Since symptoms can appear to be similar, carefully match the symptoms of the computer malfunction against the problem description in the Troubleshooting tables to avoid a misdiagnosis.



**WARNING:** To avoid a potential shock hazard during troubleshooting procedures, disconnect all power sources before removing the keyboard cover or the display bezel.

### Before Replacing Parts

Verify that cables are connected properly to the suspected defective parts.

- Run Computer Setup after connecting external devices.
- Verify that all required device drivers are installed.
- Verify that all required changes have been made to the *CONFIG.SYS* file.
- Verify that all required changes have been made to the *AUTOEXEC.BAT* file.
- Verify that all printer drivers have been installed for each application.

1.800.AT.COMPAQ

[privacy and legal statement](#)

|        |   |
|--------|---|
| COMPAQ | STORE   PRODUCTS   SERVICES   SUPPORT   CONTACT US   SEARCH |
|--------|---|

## Maintenance & Service Guide for Presario 1600 Series (Models 1683-1694)

- [Home Page](#) | 
 [Notice](#) | 
 [Preface](#) | 
 [Product Description](#) | 
 [Troubleshooting](#) | 
 [Illustrated Parts Catalog](#) | 
 [Removal & Replacement Procedures](#) | 
 [Specifications](#) | 
 [Pin Assignments](#) | 
 [Battery Pack Operations](#)

### Troubleshooting

Some minor problems and possible solutions are outlined in the following tables. If the problem appears related to a software application, check the documentation provided with the software.

#### Solving Audio Problems

Some common audio problems and solutions are listed in the following table.

| Solving Audio Problems                                      |   |                        |
|---|---|------------------------|
| Problem   | Probable Cause  | Solution(s)            |
| Computer does not beep after the Power-On Self-Test (POST). | This is typical; it indicates successful completion of the Power-On Self-Test (POST). | No action is required. |

#### Solving Battery Pack and Battery Gauge Problems

Some common causes and solutions for battery pack problems are listed in the following table. The "Solving Power Problems" section in this chapter may also be applicable.

| Solving Battery Pack and Battery Gauge Problems                                   |                             |   |
|---|-----------------------------|---|
| Problem   | Probable Cause              | Solution(s)   |
| Computer won't turn on when battery pack is inserted and power cord is unplugged. | Battery pack is discharged. | Connect the computer to an external power source and charge the battery pack.<br><br>Replace the battery pack with a fully charged battery pack.<br><br>Check the battery connectors on the system board to verify they are evenly spaced and that they are not bent or broken. |



|   |   |  |
|---|---|--|
| Computer is beeping and battery LED icon is blinking.   | Battery charge is low.                            | Immediately save any open file(s). Then do any one of the following: <ul style="list-style-type: none"> <li>• Connect the computer to an external power source to charge the battery pack.</li> <li>• Turn off the computer or initiate Hibernation until you can find another power source or charge the battery pack.</li> </ul> |
| Computer battery LED icon (front on the unit) blinks to indicate low battery condition, but computer does not beep. | Volume is turned down too low.                    | Adjust the volume.   |
| Battery LED icon doesn't light and battery pack won't fast charge.  | Battery pack is already charged.                  | No action is necessary.  |
|   | Battery pack was exposed to temperature extremes. | Allow time for the battery pack to return to room temperature.   |
|   | Battery pack is at end of its life.               | Replace battery pack.  |
| You have to set the date and time every time you turn on the computer.  | RTC battery is dead.                              | Replace the RTC battery.   |

| Problem   | Probable Cause  | Solution(s)  |
|---|---|--|
| Battery charge does not last as long as expected.                                   | Battery is being exposed to high temperatures or extremely cold temperatures. | Keep the battery pack within the recommended operating temperature range 50° F to 104° F (10° C to 40° C) or recommended storage range -4° F to 86° F (-20° C to 30° C ). Recharge the battery pack. |
|   | Battery has partially self-discharged.  | Recharge the battery. Discharge the battery completely and then recharge it.   |
|   | Power management is disabled.   | Set a power management level in Computer Setup.  |
|   | An external device or PC Card is draining the battery.                        | Turn off or disconnect external devices when not using them.   |
| Battery pack is warm to the touch after charging.                                   | Normal warming has occurred due to charging.                                  | No action is required.   |
| Battery pack operating time is far less than the documented average operating time. | Power management is turned off or disabled.                                   | Enable power management in Computer Setup and in Windows Power Properties.   |
|   | An external device or PC Card is draining the battery.                        | Turn off or disconnect external devices when not using them.   |

|   |   |
|---|---|
| <p>Battery pack has partially self-discharged.</p>  | <p>Condition the battery pack by fully charging, fully discharging, then fully recharging it.</p> <p>To maintain the charge, leave battery packs in the computer when it is connected to external power.</p> <p>If the computer is disconnected from external power for more than two weeks, remove battery packs from the computer to reduce the discharge rate.</p> |
| <p>Battery pack is being exposed to high temperatures or extremely cold temperatures.</p> | <p>Keep the battery pack within the recommended temperature ranges.<br/>                     Operating: 50° F to 104° F (10° C to 40° C)<br/>                     Storage: -4° F to 86° F (-20° C to 30° C)</p> <p>Recharge the battery pack.</p>   |

### Solving CD Drive Problems

Some common causes and solutions for CD drive problems are listed in the following table.

| Solving CD Drive Problems                   |   |   |
|---|---|---|
| Problem                                     | Probable Cause  | Solution(s)   |
| <p>CD drive cannot read a compact disc.</p> | <p>Compact disc is upside down or is improperly inserted in the CD drive.</p> | <p>Open the CD loading tray, lay the compact disc in it (label side up), then close the tray.</p> |
|   | <p>CD is CD Plus or Pregap/Track 0 type.</p>                                  | <p>Cannot read these type CDs in 24x. Remove the CD.</p>  |

### Solving Diskette and Diskette Drive Problems

Some common causes and solutions for diskette and diskette drive problems are listed in the following table.

| Solving Diskette and Diskette Drive Problems      |  |  |
|---|--|--|
| Problem   | Probable Cause                                   | Solution(s)  |
| <p>Diskette drive cannot write to a diskette.</p> | <p>Diskette is write-protected.</p>              | <p>Disable the diskette's write-protect feature or use a diskette that is not write-protected.</p> |
|   | <p>Computer is writing to the wrong drive.</p>   | <p>Check the drive letter in the path statement.</p>   |
|   | <p>Not enough space is left on the diskette.</p> | <p>Use another diskette.</p>   |

|  |  |  |
|--|--|--|
|  | Drive error has occurred.                              | Run Computer Checkup from the Compaq Diagnostics diskette.         |
|  | Diskette is not formatted.                             | Format the diskette. At the system prompt, enter <b>FORMAT A:</b>  |
| Diskette drive cannot read a diskette. | The wrong type of diskette is being used.              | Use the type of diskette required by the drive.                    |
|  | Diskette has a bad sector.                             | Copy files to hard drive or another diskette. Reformat bad floppy. |
|  | Drive error has occurred.                              | Run Computer Checkup from the Compaq Diagnostics diskette.         |
|  | Diskette is not formatted.                             | Format the diskette. At the system prompt, enter <b>FORMAT A:</b>  |
| Cannot boot from diskette.             | Bootable diskette is not in drive A.                   | Put the bootable diskette in drive A.                              |
|  | Diskette Boot has incorrect setting in Computer Setup. | Run Computer Setup and set diskette as first to boot.              |





**Solving Display Problems**

This section lists some common causes and solutions for computer display and external monitor problems.





You can perform a monitor self-test on an external VGA color or monochrome monitor by disconnecting the monitor from the computer. To do so, complete the following steps:

1. Turn off the monitor.
2. Turn off the computer.
3. Disconnect the monitor signal cable from the computer.
4. Turn on the monitor and allow it to warm up for one minute.

The display should be white. A narrow black border may also appear on the left and right sides of the display. Either of these displays indicates that the monitor is working properly.

| Solving Display Problems |   |  |
|--------------------------|---|--|
| Problem                  | Probable Cause  | Solution(s)  |
| Screen is dim.           | Control for brightness or contrast (if applicable) is not set properly.     | Adjust the Brightness of the display by using <b>Fn + F7</b> (  ) or <b>Fn + F8</b> (  ).<br><br>Adjust the Contrast of the display by using <b>Fn + F5</b> (  ) or <b>Fn + F6</b> (  ). |
|                          | Computer screen is in direct light.   | Tilt display or move computer.   |
| Screen is blank.         | Screen save was initiated by Power Management due to lack of user activity. | Press any key or touch the Touch Pad.  |

|   |  |  |
|---|--|--|
|   | Display has overheated.                                | If computer is in direct sunlight, move it and allow it to cool off. |
| Display is blank and the Suspend icon is flashing.                                    | System is in Suspend mode.                             | Press any key or touch the Touch Pad.                                |
| Internal display is blank and the screen on an external monitor displays information. | Display function was switched to the external monitor. | Use <b>Fn + F2</b> to switch between <b>LCD</b> or <b>CRT</b> .      |

| Problem   | Probable Cause   | Solution(s)  |
|---|--|--|
| Internal display flashes or has garbled characters when computer is connected to external monitor.  | Using 1024 x 768 or higher resolution on external monitor and have toggled back to internal display, which supports up to 800 x 600. | Restart the computer.  |
| The light tubes on the edge of the display panel do not light up at all and Power-On Self-Test (POST) completes when the unit is powered up.**  | Improper backlight or display cable connections  | Replace the display assembly.  |
|   | Defective inverter board.  | Replace the display assembly.  |
|   | Defective display cable.   | Replace the display assembly.  |
|   | Defective display panel.   | Replace the display assembly.  |
| The light tubes on the edge of the display panel do not light up at all and Power-On Self-Test (POST) does not complete when the unit is powered up.**  | Defective system board.  | Replace the system board.  |
|   |  |  |
| Backlight (brightness) cannot be adjusted with <b>Fn + F7</b> (  ) or <b>Fn + F8</b> (  ).*** | Improper display cable connections.  | 1. Reseat the display cable to the system board.<br><br>2. Replace the display assembly. |
|   | Defective inverter board.  | Replace the display assembly.  |
|   | Defective display cable.   | Replace the display assembly.  |
|   | Defective system board.  | Replace the system board.  |
| Contrast cannot be adjusted with <b>Fn + F5</b> (  ) or <b>Fn + F6</b> (  ).                  | Improper display cable connections.  | 1. Reseat the display cable to the system board.<br><br>2. Replace the display assembly. |
|   | Defective inverter board.  | Replace the display assembly.  |
|   | Defective display cable.   | Replace the display assembly.  |
|   | Defective system board.  | Replace the system board.  |

\*\* This problem indicates that the backlight or its power circuitry has failed. Since you cannot observe the POST result on the display panel when the backlight is not functioning, connect the unit to an external monitor before powering the unit up. If an external monitor is not available, verify that POST completes by opening and closing the display, listening for the single or double beep, and watching for the LEDs turn on at the front of the computer.

| Problem  | Probable Cause                         | Solution(s)  |
|--|--|--|
| This display panel has a continuous pattern across it (e.g., a "jailbars" pattern), has a single color on it, or has garbled graphics across the entire panel. This failure is for patterns across the entire panel (not just on one section). | Improper display cable connections     | Reseat the display cable to the following until the problem is solved:<br><br>1. System board<br><br>2. Display assembly                         |
|  | Defective display cable.               | Replace the display assembly.  |
|  | Defective inverter board.              | Replace the display assembly.  |
|  | Defective system board.                | Replace the system board.  |
| Ghost bars extending from graphics on the display.   | Common characteristic of STN displays. | 1. Change the background colors.<br><br>2. Adjust the Contrast of the display by using <b>Fn + F5</b> ( $\bar{\quad}$ ) or <b>Fn + F6</b> ( - ). |
| A single line, small group of lines, or block appears on the display panel. This failure occurs in only a section of the display panel.  | Defective display panel.               | Replace the display assembly.  |

**NOTE:** To perform a "self-test" on an external VGA color or monochrome monitor, complete the following steps: The screen should be white. A narrow black border may also appear on the left and right sides of the display. Either of these displays indicates that the monitor is working properly.

### Solving Hard Drive Problems

Some common causes and solutions for hard drive problems are listed in the following table.

|  |  |
|--|--|
|  | <b>CAUTION:</b> To prevent loss of information, always maintain an up-to-date backup of your hard drive at all times, in case of errors or failures. |
|--|--|

| Solving Hard Drive Problems |                |             |
|-----------------------------|----------------|-------------|
| Problem                     | Probable Cause | Solution(s) |
|                             |                |             |

|  |   |  |
|--|---|--|
| Reading hard drive takes an unusually long time after restarting the computer. | System entered Hibernation due to low battery condition and is now exiting from it. | Give the system time to restore the previously saved data to its exact state before Hibernation.         |
| Hard drive error occurs.   | Hard drive has bad sectors or has failed.   | Run Computer Checkup.  |
| Hard drive does not work.  | Hard drive is not seated properly.  | Turn off and unplug the computer, remove the battery pack, and remove and then reinstall the hard drive. |

### Solving Hardware Installation Problems

Some common causes and solutions for hardware installation problems are listed in the following table.

| Solving Hardware Installation Problems                         |  |   |
|--|--|---|
| Problem  | Probable Cause   | Solutions(s)  |
| A new device is not recognized as part of the computer system. | Cable(s) of new external device are loose or power cables are unplugged. | Ensure that all cables are properly and securely connected.   |
|  | Power switch of new external device is not turned on.                    | Turn off the computer, turn on the external device, then turn on the computer to integrate the device with the computer system. |
|  | Device is not seated properly.   | Turn off the computer and reinsert the device.  |

### Solving Keyboard/Numeric Keypad Problems

Some common causes and solutions for keyboard/numeric keypad problems are listed in the following table.

| Solving Keyboard/Numeric Keypad Problems                         |   |  |
|--|---|--|
| Problem  | Probable Cause  | Solution(s)  |
| Embedded numeric keypad on computer keyboard is disabled.        | Num Lock function is not enabled.                     | Press the <b>Shift+NumLk</b> keys to enable the Num Lock function and embedded numeric keypad. The Num Lock icon on the status panel turns on. |
| Embedded numeric keypad is disabled and Num Lock function is on. | External numeric keypad is connected to the computer. | Disconnect the external numeric keypad from the computer.  |

### Solving Memory Problems

Some common causes and solutions for memory problems are listed in the following table.

| Solving Memory Problems |                |             |
|-------------------------|----------------|-------------|
| Problem                 | Probable Cause | Solution(s) |
|                         |                |             |

|  |  |  |
|--|--|--|
| Memory count during Power-On Self-Test (POST) is incorrect.  | Optional memory expansion card is installed incorrectly, is incompatible with the computer, or is defective. | Ensure that the optional memory expansion card is installed correctly.                         |
| "Out of Memory" message is displayed on the screen or insufficient memory error occurs during operation. | System ran out of memory for the application.  | Check the application documentation for memory requirements.<br><br>Install additional memory. |
|  | Too many TSR (terminate-and stay-resident) applications are running.   | Remove from memory any TSR applications that you do not need.                                  |

[Solving Minor Problems \(continued\)](#)

1.800.AT.COMPAQ

[privacy and legal statement](#)

COMPAQ

[STORE](#) | [PRODUCTS](#) | [SERVICES](#) | [SUPPORT](#) | [CONTACT US](#) | [SEARCH](#)

## Maintenance & Service Guide for Presario 1600 Series (Models 1683-1694)

| [Home Page](#) | [Notice](#) | [Preface](#) | [Product Description](#) | [Troubleshooting](#) | [Illustrated Parts Catalog](#) | [Removal & Replacement Procedures](#) | [Specifications](#) | [Pin Assignments](#) | [Battery Pack Operations](#)

---

### Troubleshooting

#### Contacting Compaq Support

Obtain the following information before contacting Compaq Reseller Support:

- Product name
- Product serial number
- Purchase date
- Conditions under which the problem occurred
- Any error messages that have occurred
- Hardware configuration
- Type of printer connected
- Hardware/software being used
- Printed result of Computer Checkup (TEST)
- Printed copies of *CONFIG.SYS* and *AUTOEXEC.BAT* files, if possible

#### Shipping Preparation

To ship the computer, complete the following steps:

1. Back up the critical hard drive files. Ensure that backup tapes/diskette are not exposed to electrical or magnetic fields while stored in transit.
2. Turn off the computer and external devices.
3. Disconnect the external devices from their power sources, then from the computer.



**IMPORTANT:**

Ensure that there is no diskette in the diskette drive and that there are no PC Cards in the PC slots.

4. Close the display and all exterior doors of the computer.
5. Pack the computer with sufficient packing material to protect it. Use the original packing box or similar packaging.

1.800.AT.COMPAQ

[privacy and legal statement](#)

STOR

## Maintenance & Service Guide for Presario 1600 Series (Models 1683-1694)

[Home Page](#) | [Notice](#) | [Preface](#) | [Product Description](#) | [Troubleshooting](#) | [Illustrated Parts Catalog](#) | [Removal & Replacement Procedures](#) | [Specifications](#) | [Pin Assignments](#) | [Battery Pack Operations](#)

### Illustrated Parts Catalog

|  |
|--|
| <b>System Unit</b>                         |
| <a href="#">Boards</a>                     |
| <a href="#">Display Assembly</a>           |
| <a href="#">Mass Storage Devices</a>       |
| <a href="#">Miscellaneous Cable Kit</a>    |
| <a href="#">Miscellaneous Hardware Kit</a> |
| <a href="#">Miscellaneous Plastics Kit</a> |
| <a href="#">Miscellaneous Parts</a>        |
| <a href="#">Documentation and Software</a> |

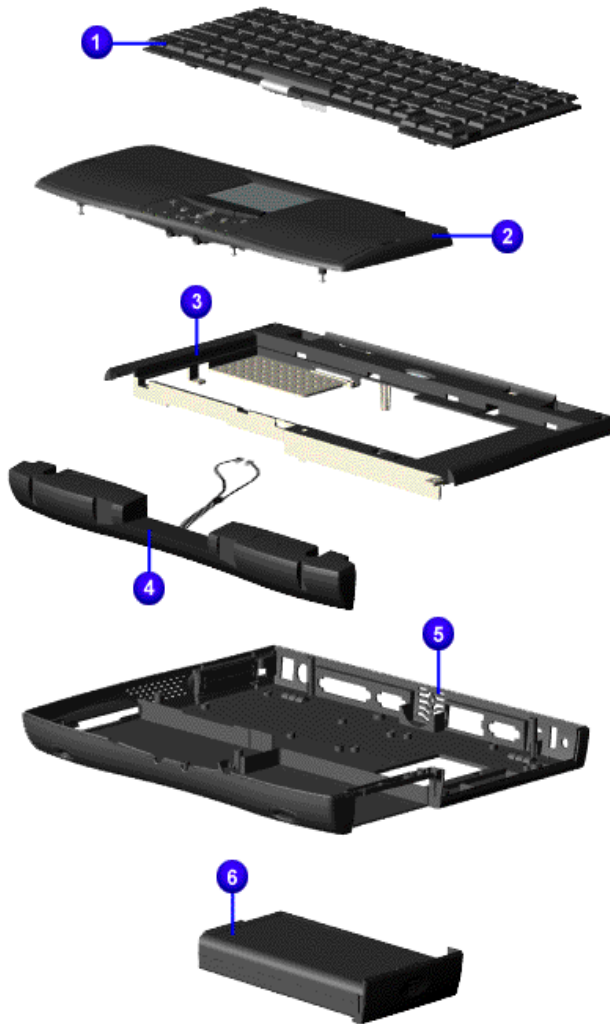

| <i>System Unit</i>  |                   |
|---|-------------------|
| Part Description  | Spare Part Number |
| 1. Keyboard   |                   |
| 2. Palmrest Cover w/ TouchPad and Button Board (Models: 1687, 1688, 1690, 1693, 1694) | 142654-001        |
| 2. Palmrest Cover w/ TouchPad and Button Board (Models: 1683, 1685, 1688, 1692)       | 142653-001        |
| 3. Upper CPU Cover w/Power Switch   | 141846-001        |
| 4. Speaker Assembly w/ Cables   | 148108-001        |
| 5. Base Enclosure   | 141845-001        |
| 6. Battery Pack L ion Enhancement (Models: 1683, 1685, 1687, 1688, 1690)              | 388647-001        |
| 6. Battery Pack L ion Enhancement (Models: 1692, 1693, 1694)                          | 138-184-001       |
| 1600 Series CTO Description   | Spare Part Number |
| 1. Keyboard   | EAB               |
| 2. Palmrest Cover w/ TouchPad and Button Board  | 142654-001        |
| 3. Battery  | sLiON             |
| 4. Port Replicator  | 400384-001        |

1.800.AT.COMPAQ

[privacy and legal statement](#)

## Maintenance & Service Guide for Presario 1600 Series (Models 1683-1694)

[Home Page](#) | [Notice](#) | [Preface](#) | [Product Description](#) | [Troubleshooting](#) | [Illustrated Parts Catalog](#) | [Removal & Replacement Procedures](#) | [Specifications](#) | [Pin Assignments](#) | [Battery Pack Operations](#)

### Illustrated Parts - Boards

|  |
|--|
| <a href="#">System Unit</a>                |
| <b>Boards</b>                              |
| <a href="#">Display Assembly</a>           |
| <a href="#">Mass Storage Devices</a>       |
| <a href="#">Miscellaneous Cable Kit</a>    |
| <a href="#">Miscellaneous Hardware Kit</a> |
| <a href="#">Miscellaneous Plastics Kit</a> |
| <a href="#">Miscellaneous Parts</a>        |
| <a href="#">Documentation and Software</a> |

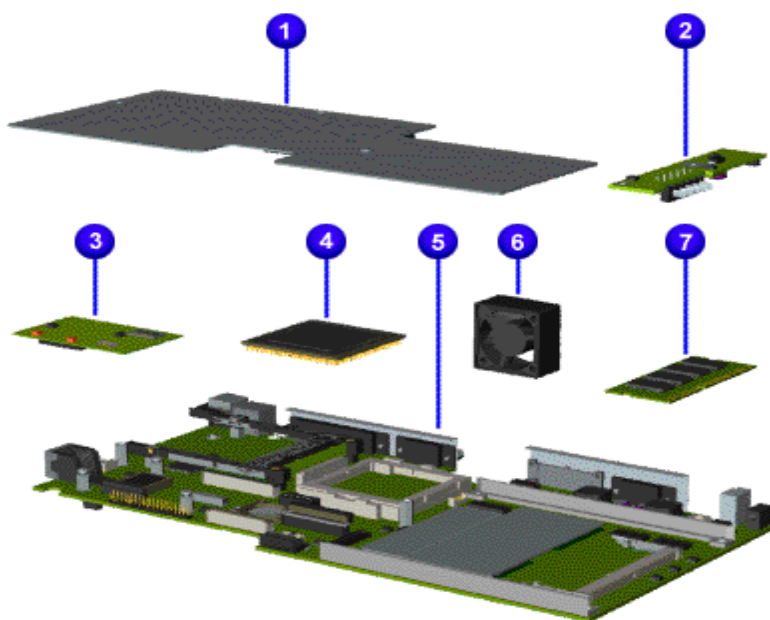

| Description                         | Spare Part Number             |
|-------------------------------------|-------------------------------|
| 1. Heatsreader                      | 122702-001                    |
| 2. Voltage Converter Board          | 352891-001                    |
| 3. Modem 56K Data/Fax w/o SRAM      | 400445-001                    |
| 3. Modem 56K Data/Fax w/o SRAM-Intl | 143848-001                    |
| 4. Processor AMD K6                 |                               |
| 5. System Board w/512K Cache        | 144018-001 (models 1683-1690) |
|                                     | 158848-001 (models 1692-1694) |
| 6. Fan Assembly                     | 400444-001                    |
| 7. System Memory                    |                               |

[privacy and legal statement](#)

COMPAQ

[STORE](#) | [PRODUCTS](#) | [SERVICES](#) | [SUPPORT](#) | [CONTACT US](#) | [SEARCH](#)

## Maintenance & Service Guide for Presario 1600 Series (Models 1683-1694)

| [Home Page](#) | [Notice](#) | [Preface](#) | [Product Description](#) | [Troubleshooting](#) | [Illustrated Parts Catalog](#) | [Removal & Replacement Procedures](#) | [Specifications](#) | [Pin Assignments](#) | [Battery Pack Operations](#)

### Illustrated Parts

[System Unit](#)

[Boards](#)

[Display Assembly](#)

[Mass Storage Devices](#)

[Miscellaneous Cable Kit](#)

[Miscellaneous Hardware Kit](#)

[Miscellaneous Plastics Kit](#)

[Miscellaneous Parts](#)

[Documentation and Software](#)



### Display Assembly

| Description  | Spare Part Number |
|--|-------------------|
| 1. Display<br>12.1 TFT<br>(Models:<br><b>1683,</b><br><b>1685,</b><br><b>1687,</b><br><b>1692)</b> | 142304-001        |
| 2. Display<br>13.3 TFT<br>w/LVDS<br>(Model:<br><b>1688)</b>  | 142305-001        |
| 3. Display<br>14.1 TFT w/<br>LVDS<br>(Model:<br><b>1690,</b><br><b>1693,</b><br><b>1694)</b>       | 142306-001        |

1.800.AT.COMPAQ

[privacy and legal statement](#)

COMPAQ

[STORE](#) | [PRODUCTS](#) | [SERVICES](#) | [SUPPORT](#) | [CONTACT US](#) | [SEARCH](#)

## Maintenance & Service Guide for Presario 1600 Series (Models 1683-1694)

[Home Page](#) | [Notice](#) | [Preface](#) | [Product Description](#) | [Troubleshooting](#) | [Illustrated Parts Catalog](#) |

[Removal & Replacement Procedures](#) | [Specifications](#) | [Pin Assignments](#) | [Battery Pack Operations](#)

### Illustrated Parts

[System Unit](#)

[Boards](#)

[Display Assembly](#)

[Mass Storage Devices](#)

[Miscellaneous Cable Kit](#)

[Miscellaneous Hardware Kit](#)

[Miscellaneous Plastics Kit](#)

[Miscellaneous Parts](#)

[Documentation and Software](#)

#### Mass Storage Devices

Use the scroll down menu for the description and spare part number.

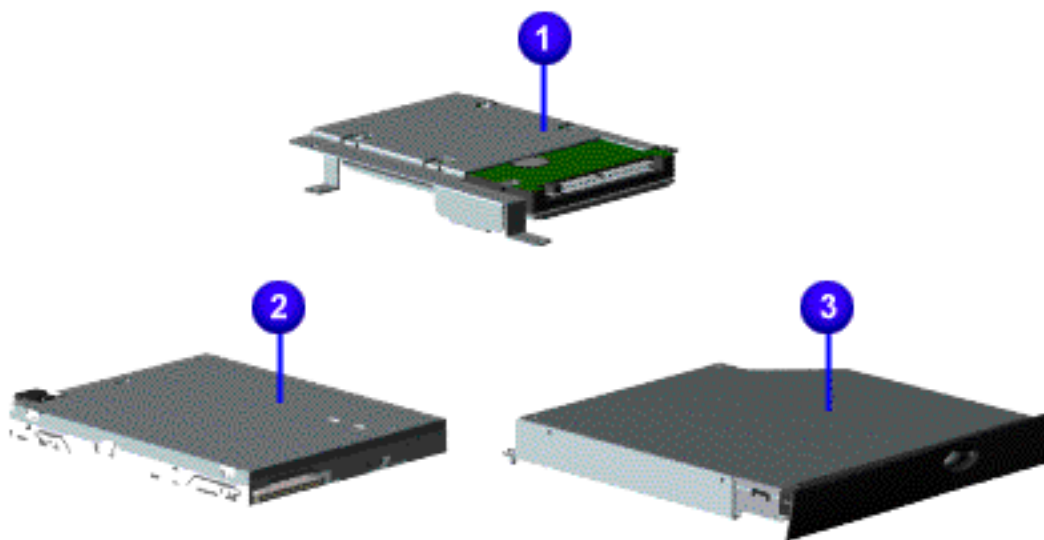

1.800.AT.COMPAQ



[privacy and legal statement](#)

COMPAQ

[STORE](#) | [PRODUCTS](#) | [SERVICES](#) | [SUPPORT](#) | [CONTACT US](#) | [SEARCH](#)

## Maintenance & Service Guide for Presario 1600 Series (Models 1683-1694)

| [Home Page](#) | [Notice](#) | [Preface](#) | [Product Description](#) | [Troubleshooting](#) | **Illustrated Parts Catalog** | [Removal & Replacement Procedures](#) | [Specifications](#) | [Pin Assignments](#) | [Battery Pack Operations](#)

### Illustrated Parts

|  |
|--|
| <a href="#">System Unit</a>                |
| <a href="#">Boards</a>                     |
| <a href="#">Display Assembly</a>           |
| <a href="#">Mass Storage Devices</a>       |
| <b>Miscellaneous Cables Kit</b>            |
| <a href="#">Miscellaneous Hardware Kit</a> |
| <a href="#">Miscellaneous Plastics Kit</a> |
| <a href="#">Miscellaneous Parts</a>        |
| <a href="#">Documentation and Software</a> |

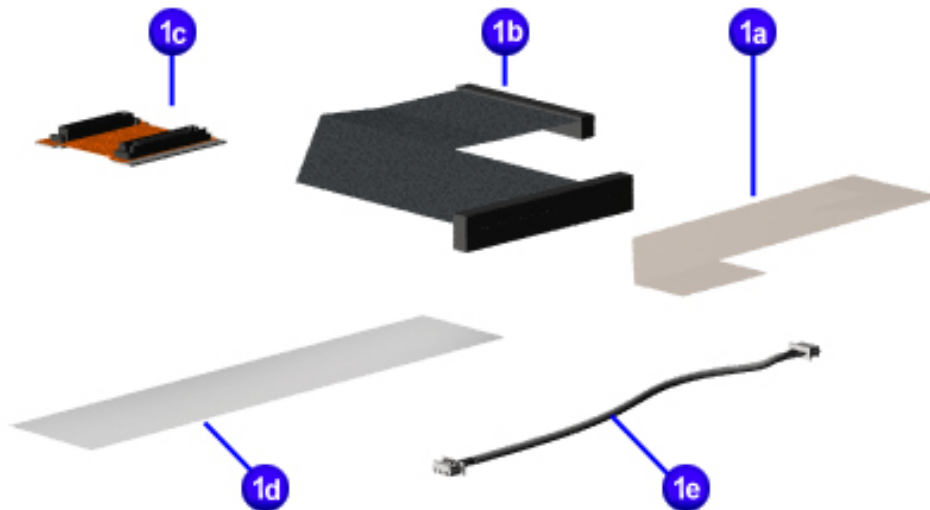

#### Miscellaneous Cables Kit

Miscellaneous Cable Kit Spare Part Number: 330946-001

- 1a.** 1 Diskette Drive Cable each
- 1b.** Hard Drive Cable each
- 1c.** CD or DVD Drive Cable each
- 1d.** 1 Touchpad Cable each
- 1e.** 1 Modem Cable each

1.800.AT.COMPAQ

[privacy and legal statement](#)

COMPAQ

[STORE](#) | [PRODUCTS](#) | [SERVICES](#) | [SUPPORT](#) | [CONTACT US](#) | [SEARCH](#)

# Maintenance & Service Guide for Presario 1600 Series (Models 1683-1694)

[Home Page](#) | [Notice](#) | [Preface](#) | [Product Description](#) | [Troubleshooting](#) | [Illustrated Parts Catalog](#) | [Removal & Replacement Procedures](#) | [Specifications](#) | [Pin Assignments](#) | [Battery Pack Operations](#)

## Illustrated Parts

|  |
|--|
| <a href="#">System Unit</a>                |
| <a href="#">Boards</a>                     |
| <a href="#">Display Assembly</a>           |
| <a href="#">Mass Storage Devices</a>       |
| <a href="#">Miscellaneous Cable Kit</a>    |
| <a href="#">Miscellaneous Hardware Kit</a> |
| <a href="#">Miscellaneous Plastics Kit</a> |
| <a href="#">Miscellaneous Parts</a>        |
| <a href="#">Documentation and Software</a> |

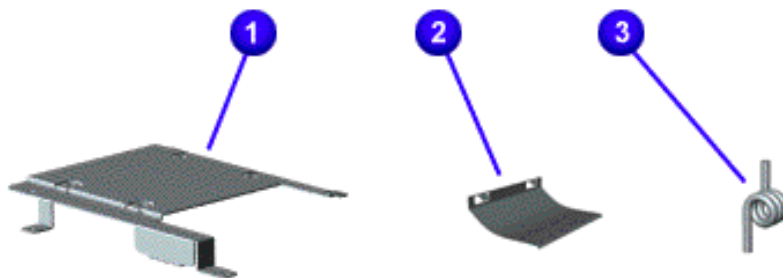

### Miscellaneous Hardware Kit

**Miscellaneous Hardware Kit  
Spare Part Number:  
346853-001**

| Description                    | Quantity |
|--------------------------------|----------|
| 1. Hard Drive Mounting Bracket | 1 each   |
| 2. LCD Guide FPC               | 1 each   |
| 3. Spring Torsion PCMCIA       | 4 each   |

1.800.AT.COMPAQ

[privacy and legal statement](#)

# Maintenance & Service Guide for Presario 1600 Series (Models 1683-1694)

- [Home Page](#) | [Notice](#) | [Preface](#) | [Product Description](#) | [Troubleshooting](#) | [Illustrated Parts Catalog](#) | [Removal & Replacement Procedures](#) | [Specifications](#) | [Pin Assignments](#) | [Battery Pack Operations](#)

## Illustrated Parts

|  |
|--|
| <a href="#">System Unit</a>                |
| <a href="#">Boards</a>                     |
| <a href="#">Display Assembly</a>           |
| <a href="#">Mass Storage Devices</a>       |
| <a href="#">Miscellaneous Cable Kit</a>    |
| <a href="#">Miscellaneous Hardware Kit</a> |
| <a href="#">Miscellaneous Plastics Kit</a> |
| <a href="#">Miscellaneous Parts</a>        |
| <a href="#">Documentation and Software</a> |

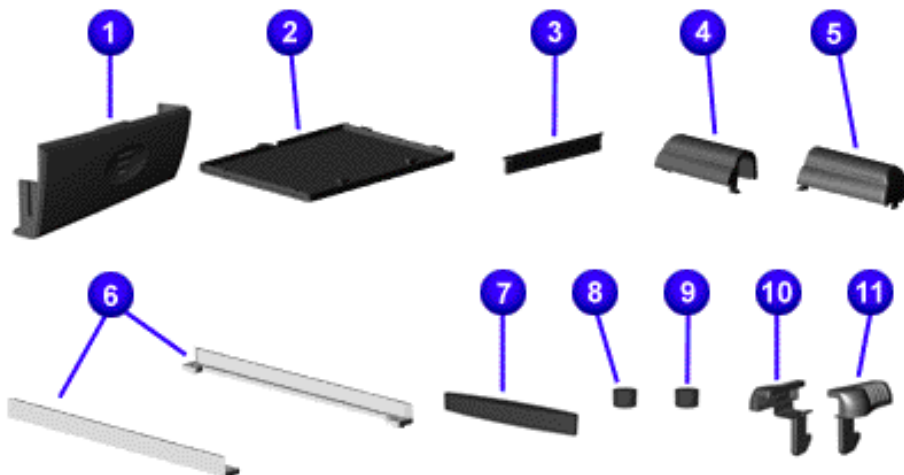

### Miscellaneous Plastics Kit

Miscellaneous Plastics Kit Spare Part Number: 142657-001

| Description                     | Quantity |
|---------------------------------|----------|
| 1. Door, Battery Pack           | 1 each   |
| 2. Cover, Memory Module         | 1 each   |
| 3. Door, PCMCIA                 | 1 each   |
| 4. Display Hinge Cover, (Left)  | 1 each   |
| 5. Display Hinge Cover, (Right) | 1 each   |
| 6. CD Drive Guide               | 1 each   |
| 7. Rubber Plug (A)              | 4 each   |
| 8. Rubber Plug (B)              | 4 each   |
| 9. Rubber Foot                  | 8 each   |

**10.** Latch (Right) 2 each

**11.** Latch (Left) 2 each



1.800.AT.COMPAQ

[privacy and legal statement](#)

## Maintenance & Service Guide for Presario 1600 Series (Models 1683-1694)

[Home Page](#) | [Notice](#) | [Preface](#) | [Product Description](#) | [Troubleshooting](#) | [Illustrated Parts Catalog](#) | [Removal & Replacement Procedures](#) | [Specifications](#) | [Pin Assignments](#) | [Battery Pack Operations](#)

### Illustrated Parts

|  |
|--|
| <a href="#">System Unit</a>                |
| <a href="#">Boards</a>                     |
| <a href="#">Display Assembly</a>           |
| <a href="#">Mass Storage Devices</a>       |
| <a href="#">Miscellaneous Cable Kit</a>    |
| <a href="#">Miscellaneous Hardware Kit</a> |
| <a href="#">Miscellaneous Plastics Kit</a> |
| <a href="#">Miscellaneous Parts</a>        |
| <a href="#">Documentation and Software</a> |

Use the scroll down menu for the description and spare part number of spare parts **Not Shown**.

#### Miscellaneous Parts

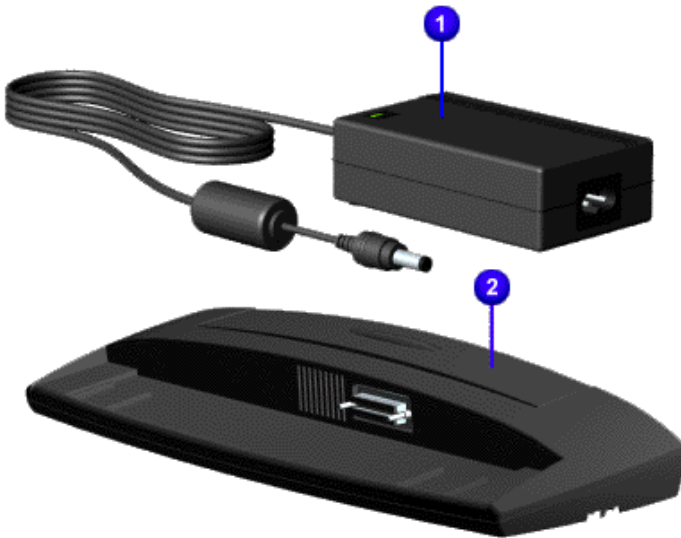

- |                    |            |
|--------------------|------------|
| 2. Port Replicator | 102270-001 |
| 3. Return Kit      | 293799-001 |
| 4. Logo Kit        | 141848-001 |

|        |   |
|--------|---|
| COMPAQ | STORE   PRODUCTS   SERVICES   SUPPORT   CONTACT US   SEARCH |
|--------|---|

## Maintenance & Service Guide for Presario 1600 Series (Models 1683-1694)

| [Home Page](#) | [Notice](#) | [Preface](#) | [Product Description](#) | [Troubleshooting](#) |

**[Illustrated Parts Catalog](#)** |

[Removal & Replacement Procedures](#) | [Specifications](#) | [Pin Assignments](#) | [Battery Pack Operations](#)

### Illustrated Parts

|   |
|---|
| <a href="#">System Unit</a>                       |
| <a href="#">Boards</a>                            |
| <a href="#">Display Assembly</a>                  |
| <a href="#">Mass Storage Devices</a>              |
| <a href="#">Miscellaneous Cable Kit</a>           |
| <a href="#">Miscellaneous Hardware Kit</a>        |
| <a href="#">Miscellaneous Plastics Kit</a>        |
| <a href="#">Miscellaneous Parts</a>               |
| <b><a href="#">Documentation and Software</a></b> |

| <i>Documentation and Software</i>  |                     |        |           |
|--|---------------------|--------|-----------|
| Description  | Spare Part Number   |        |           |
| Quick Restore CD   |                     |        |           |
| Reference Guide  | Info. Not Available |        |           |
| QuickFind for Windows, North America, Latin America, Asia Pacific  | Info. Not Available |        |           |
| QuickFind for Windows, Europe, Middle East, Africa   | Info. Not Available |        |           |
| <p>*QuickFind is updated monthly. To complete the QuickFind part number, add the suffix from the table below for the desired month. If you do not specify the 3-digit suffix, the default is the current month in which the order is placed.</p> |                     |        |           |
| QuickFind Part Number Suffix   |                     |        |           |
| Suffix   | Month               | Suffix | Month     |
| -001   | January             | -007   | July      |
| -002   | February            | -008   | August    |
| -003   | March               | -009   | September |
| -004   | April               | -010   | October   |
| -005   | May                 | -011   | November  |

|      |      |      |          |
|------|------|------|----------|
| -006 | June | -012 | December |
|------|------|------|----------|

---

1.800.AT.COMPAQ

[privacy and legal statement](#)



COMPAQ

[STORE](#) | [PRODUCTS](#) | [SERVICES](#) | [SUPPORT](#) | [CONTACT US](#) | [SEARCH](#)

## Maintenance & Service Guide for Presario 1600 Series (Models 1683-1694)

| [Home Page](#) | [Notice](#) | [Preface](#) | [Product Description](#) | [Troubleshooting](#) | [Illustrated Parts Catalog](#) |

[Removal & Replacement Procedures](#) | [Specifications](#) | [Pin Assignments](#) | [Battery Pack Operations](#)

## Removal and Replacement Procedures

### *Electrostatic Discharge*

A sudden discharge of static electricity from a finger or other conductor can destroy static-sensitive devices or microcircuitry. Often the spark is neither felt nor heard, but damage occurs. An electronic device exposed to electrostatic discharge (ESD) may not be affected at all and will work perfectly throughout a normal cycle. Although, it may function normally for a while, then degrade in the internal layers, reducing its life expectancy.

Networks built into many integrated circuits provide some protection, but in many cases, the discharge contains enough power to alter device parameters or melt silicon junctions.

### *Generating Static*

The table shows how different activities generate static electricity and at different electrostatic voltage levels.

**Typical Electrostatic Voltages**

| Event                      | Relative Humidity |          |         |
|----------------------------|-------------------|----------|---------|
|                            | 10%               | 40%      | 55%     |
| Walking across carpet      | 35,000 V          | 15,000 V | 7,500 V |
| Walking across vinyl floor | 12,000 V          | 5,000 V  | 3,000 V |
| Motions of bench worker    | 6,000 V           | 800 V    | 400 V   |

|   |          |          |         |
|---|----------|----------|---------|
| Removing DIPS from plastic tubes              | 2,000 V  | 700 V    | 400 V   |
| Removing DIPS from vinyl trays                | 11,500 V | 4,000 V  | 2,000 V |
| Removing DIPS from Styrofoam                  | 14,500 V | 5,000 V  | 3,500 V |
| Removing bubble pack from PCBs                | 26,000 V | 20,000 V | 7,000 V |
| Packing PCBs in foam-lined box                | 21,000 V | 11,000 V | 5,000 V |
| <b>NOTE:</b> 700 volts can degrade a product. |          |          |         |

[Return to Removal & Replacement Procedures](#)

1.800.AT.COMPAQ

[privacy and legal statement](#)

COMPAQ

[STORE](#) | [PRODUCTS](#) | [SERVICES](#) | [SUPPORT](#) | [CONTACT US](#) | [SEARCH](#)

## Maintenance & Service Guide for Presario 1600 Series (Models 1683-1694)

| [Home Page](#) | [Notice](#) | [Preface](#) | [Product Description](#) | [Troubleshooting](#) | [Illustrated Parts Catalog](#) |

[Removal & Replacement Procedures](#) | [Specifications](#) | [Pin Assignments](#) | [Battery Pack Operations](#)

---

## Removal and Replacement Procedures

### *Service Considerations*

Listed below are some of the considerations that you should keep in mind during the disassembly and assembly of the computer.

### *Tool and Software Requirements*

To service the computer, you need the following:

- Compaq screwdriver kit (Spare Part No. 161946-001)
- Torx T-9 screwdriver
- 3/16-inch and 5mm nut drivers (for screwlocks and standoffs)
- Small, standard screwdriver
- Small, Phillips screwdriver
- Diagnostics software

### *Screws*

The screws used in the computer are not interchangeable. If an incorrect screw is used during the reassembly process, it can damage the unit. Compaq strongly recommends that all screws removed during disassembly be kept with the part that was removed, then returned to their proper locations.

**IMPORTANT:** As each subassembly is removed from the computer, it should be placed away from the work area to prevent damage.

## [Return to Removal & Replacement Procedures](#)

**1.800.AT.COMPAQ**

[privacy and legal statement](#)

## Maintenance & Service Guide for Presario 1600 Series (Models 1683-1694)

[Home Page](#) | [Notice](#) | [Preface](#) | [Product Description](#) | [Troubleshooting](#) | [Illustrated Parts Catalog](#) | [Removal & Replacement Procedures](#) | [Specifications](#) | [Pin Assignments](#) | [Battery Pack Operations](#)

### Removal & Replacement Procedures

#### *Cables and Connectors*

Most cables used throughout the unit are ribbon cables. Cables must be handled with extreme care to avoid damage. Apply only the tension required to seat or unseat the cables during insertion or removal from the connector. Handle cables by the connector whenever possible. In all cases, avoid bending, twisting, or tearing the cables, and ensure that the cables are routed in such a way that they cannot be caught or snagged by parts being removed or replaced.

#### *Cables*

Use the following precautions when handling cables to avoid damage to the cable or computer:

- Always handle cables by their connectors.
- Avoid bending, twisting, or pulling on the cables.
- Apply minimum required force when seating or unseating the cables from their connectors.
- Place the cables in such a manner that they cannot be caught or snagged by parts being removed or replaced.
- Handle flex cables with extreme care; they can tear easily.



**CAUTION:** When servicing these computers, ensure that cables are placed in their proper location during the reassembly process. Improper cable placement can cause severe damage to the unit.

#### *Select the desired illustration*

Removing a Cable from a [ZIF Connector](#).

The ribbon cable position for the [4.3-GB and 6.4-GB hard drive](#).

The ribbon cable position for the [CD or DVD drive](#).

The ribbon cable position for the [diskette drive](#).

The cable position for the [speaker assembly](#).

## ***Plastic Parts***

Plastic parts can be damaged by the use of excessive force during disassembly and reassembly. When handling the plastic parts, use care. Apply pressure only at the points designated in the maintenance instructions.

## ***Return to Removal & Replacement Procedures***

**1.800.AT.COMPAQ**

[privacy and legal statement](#)

|        |   |
|--------|---|
| COMPAQ | <a href="#">STORE</a>   <a href="#">PRODUCTS</a>   <a href="#">SERVICES</a>   <a href="#">SUPPORT</a>   <a href="#">CONTACT US</a>   <a href="#">SEARCH</a> |
|--------|---|

## Maintenance & Service Guide for Presario 1600 Series (Models 1683-1694)

[Home Page](#) | [Notice](#) | [Preface](#) | [Product Description](#) | [Troubleshooting](#) | [Illustrated Parts Catalog](#) |

[Removal & Replacement Procedures](#) | [Specifications](#) | [Pin Assignments](#) | [Battery Pack Operations](#)

### Removal and Replacement Procedures

|   |
|---|
| <b>Removal sequence</b>                                       |
| <a href="#">Electrostatic Discharge</a>                       |
| <a href="#">Service Considerations</a>                        |
| <a href="#">Cables and Connectors</a>                         |
| <b><a href="#">Preparing the Computer for Disassembly</a></b> |
| <a href="#">Battery Pack</a>                                  |
| <a href="#">Palmrest Cover with Touch Pad</a>                 |
| <a href="#">Keyboard</a>                                      |
| <a href="#">Heatsreader</a>                                   |
| <a href="#">Processor</a>                                     |
| <a href="#">Hard Drive</a>                                    |
| <a href="#">DVD or CD Drive</a>                               |

#### *Preparing the Computer for Disassembly*

1. Disconnect AC power and any external devices.
2. Remove the battery pack.
3. Remove any PC Cards.

**IMPORTANT:** The battery pack should be removed before performing any internal maintenance on the computer.



**WARNING:** Metal objects can damage the battery pack as well as the battery contacts in the battery compartment. To prevent damage, do not allow metal objects to touch the battery contacts. Place only the battery pack for the Compaq Presario Series Portable Computers into the battery compartment. Do not force the battery pack into the bay if insertion does not occur easily.

[Battery](#)

[Charger Board](#)

[Modem](#)

[Display Panel  
Assembly](#)

[Upper CPU  
Cover](#)

[Speaker  
Assembly](#)

[Diskette Drive](#)

[Fan Assembly](#)

[System Board](#)

[Dip Switch  
Settings](#)

[Memory  
Module](#)



**CAUTION:** Do not crush, puncture, or incinerate the battery pack. Do not open a battery pack, as this damages the pack, makes it unusable, and exposes potentially harmful battery components. There are no field-serviceable parts located inside the battery pack.

**NOTE:**

The Compaq Presario Series Portable Computers have several screws of various sizes which are **not** interchangeable. Care must be taken during reassembly to ensure that the correct screws are used in their correct location. During removal please keep respective screws with their associated sub-assembly.

1.800.AT.COMPAQ

[privacy and legal statement](#)



COMPAQ

[STORE](#) | [PRODUCTS](#) | [SERVICES](#) | [SUPPORT](#) | [CONTACT US](#) | [SEARCH](#)

## Maintenance & Service Guide for Presario 1600 Series (Models 1683-1694)

- [Home Page](#) | [Notice](#) | [Preface](#) | [Product Description](#) | [Troubleshooting](#) | [Illustrated Parts Catalog](#) | [Removal & Replacement Procedures](#) | [Specifications](#) | [Pin Assignments](#) | [Battery Pack Operations](#)

### Removal and Replacement Procedures

**Removal sequence**

[Electrostatic Discharge](#)

[Service Considerations](#)

[Cables and Connectors](#)

[Preparing the Computer for Disassembly](#)

**Battery Pack**

[Palmrest Cover with Touch Pad](#)

[Heatspreader](#)

[Keyboard](#)

[Processor](#)

[Hard Drive](#)

[DVD or CD Drive](#)

[Battery Charger Board](#)



**Removing the Battery Pack**

1. Slide the battery pack compartment door down and remove it from the battery pack.

**Next Step**

[Modem](#)

[Display Panel  
Assembly](#)

[Upper CPU  
Cover](#)

[Speaker  
Assembly](#)

[Diskette Drive](#)

[Fan Assembly](#)

[System Board](#)

[Dip Switch  
Settings](#)

[Memory  
Module](#)

[1.800.AT.COMPAQ](#)

[privacy and legal statement](#)

## Maintenance & Service Guide for Presario 1600 Series (Models 1683-1694)

- [Home Page](#) | [Notice](#) | [Preface](#) | [Product Description](#) | [Troubleshooting](#) | [Illustrated Parts Catalog](#) | [Removal & Replacement Procedures](#) | [Specifications](#) | [Pin Assignments](#) | [Battery Pack Operations](#)

### Removal & Replacement Procedures

|  |
|--|
| <b>Removal sequence</b>                                |
| <a href="#">Electrostatic Discharge</a>                |
| <a href="#">Service Considerations</a>                 |
| <a href="#">Cables and Connectors</a>                  |
| <a href="#">Preparing the Computer for Disassembly</a> |
| <a href="#">Battery Pack</a>                           |
| <b><a href="#">Palmrest Cover with Touch Pad</a></b>   |
| <a href="#">Heatspreader</a>                           |
| <a href="#">Keyboard</a>                               |
| <a href="#">Processor</a>                              |
| <a href="#">Hard Drive</a>                             |
| <a href="#">DVD or CD Drive</a>                        |
| <a href="#">Battery Charger Board</a>                  |
| <a href="#">Modem</a>                                  |
| <a href="#">Display Panel Assembly</a>                 |

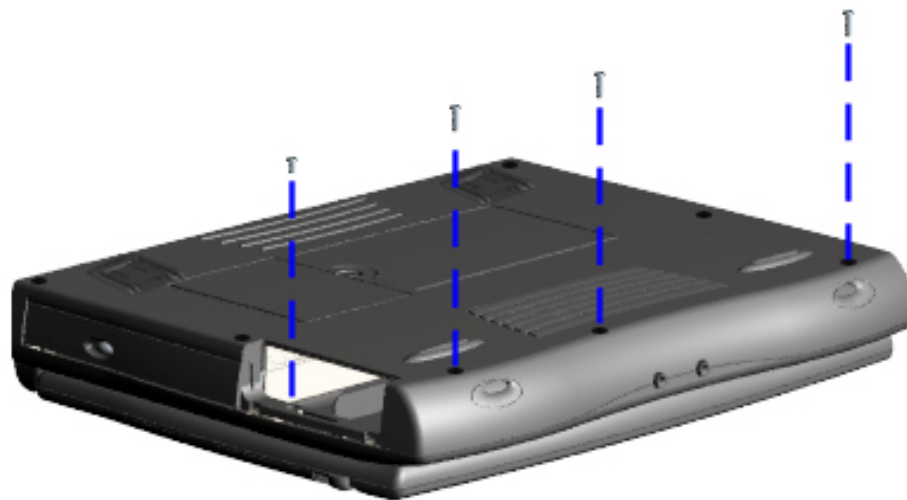

#### *Removing the Palmrest Cover with TouchPad*

You must remove the palmrest cover with touchpad to gain access to the interior components, and it is the first step in the sequence of removal and replacement.

**NOTE:** It is not necessary to remove the display panel assembly to access the interior components of the computer.

To remove the palmrest cover with touch pad, complete the following steps:

1. [Prepare the](#)

|                                     |
|-------------------------------------|
| <a href="#">Upper CPU Cover</a>     |
| <a href="#">Speaker Assembly</a>    |
| <a href="#">Diskette Drive</a>      |
| <a href="#">Fan Assembly</a>        |
| <a href="#">System Board</a>        |
| <a href="#">Dip Switch Settings</a> |
| <a href="#">Memory Module</a>       |

[computer for disassembly.](#)

**2.** Close the computer and turn the computer upside down.

**3.** Remove four screws from the underside of the computer.

***Next Step***

1.800.AT.COMPAQ

[privacy and legal statement](#)

## Maintenance & Service Guide for Presario 1600 Series (Models 1683-1694)

[Home Page](#) | [Notice](#) | [Preface](#) | [Product Description](#) | [Troubleshooting](#) | [Illustrated Parts Catalog](#) |

[Removal & Replacement Procedures](#) | [Specifications](#) | [Pin Assignments](#) | [Battery Pack Operations](#)

### Removal and Replacement Procedures

#### Removal sequence

[Electrostatic Discharge](#)

[Service Considerations](#)

[Cables and Connectors](#)

[Preparing the Computer for Disassembly](#)

[Battery Pack](#)

[Palmrest Cover with Touch Pad](#)

**[Heatspreader](#)**

[Keyboard](#)

[Processor](#)

[Hard Drive](#)

[DVD or CD Drive](#)

[Battery Charger Board](#)

[Modem](#)

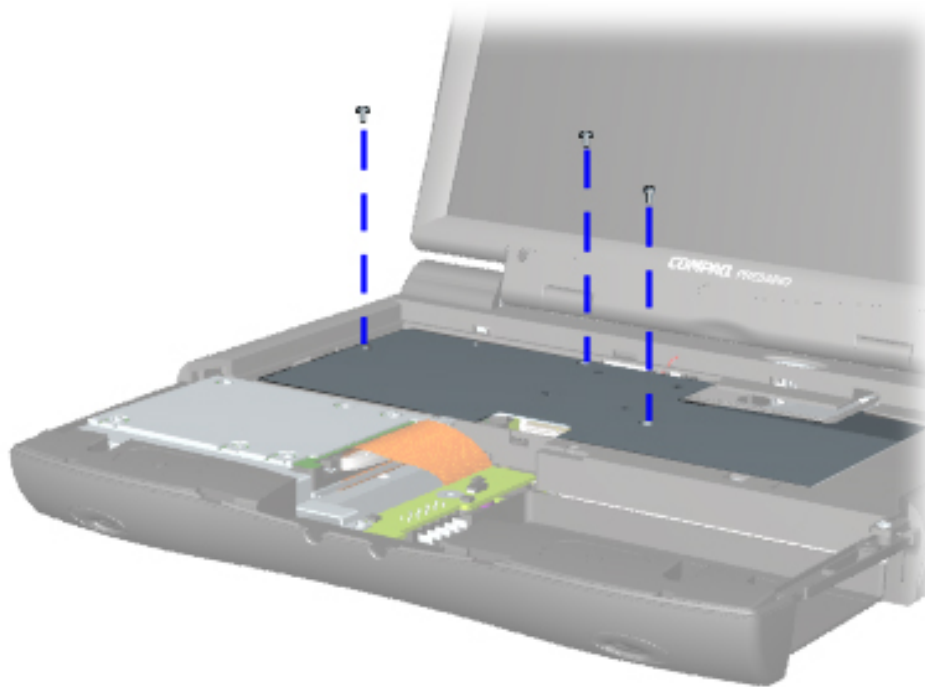

#### Removing the Heatspreader

1. Prepare [the computer for disassembly](#).

2. Remove the [palmrest cover with touch pad](#).

3. Gently lift and turn the keyboard over allowing it to rest on top of the [palmrest cover with touchpad slot opening](#).

4. Remove three screws from the heatspreader and lift out of the chassis.

To replace the heatspreader,

[Display Panel  
Assembly](#)

[Upper CPU  
Cover](#)

[Speaker  
Assembly](#)

[Diskette Drive](#)

[Fan Assembly](#)

[System Board](#)

[Dip Switch  
Settings](#)

[Memory  
Module](#)

reverse the  
previous  
procedures.

[1.800.AT.COMPAQ](#)

[privacy and legal statement](#)

# Maintenance & Service Guide for Presario 1600 Series (Models 1683-1694)

- [Home Page](#) | [Notice](#) | [Preface](#) | [Product Description](#) | [Troubleshooting](#) | [Illustrated Parts Catalog](#) | [Removal & Replacement Procedures](#) | [Specifications](#) | [Pin Assignments](#) | [Battery Pack Operations](#)

## Removal and Replacement Procedures

### Removal sequence

[Electrostatic Discharge](#)

[Service Considerations](#)

[Cables and Connectors](#)

[Preparing the Computer for Disassembly](#)

[Battery Pack](#)

[Palmrest Cover with Touch Pad](#)

[Heatspreader](#)

[Keyboard](#)

[Processor](#)

[Hard Drive](#)

[DVD or CD Drive](#)

[Battery Charger Board](#)

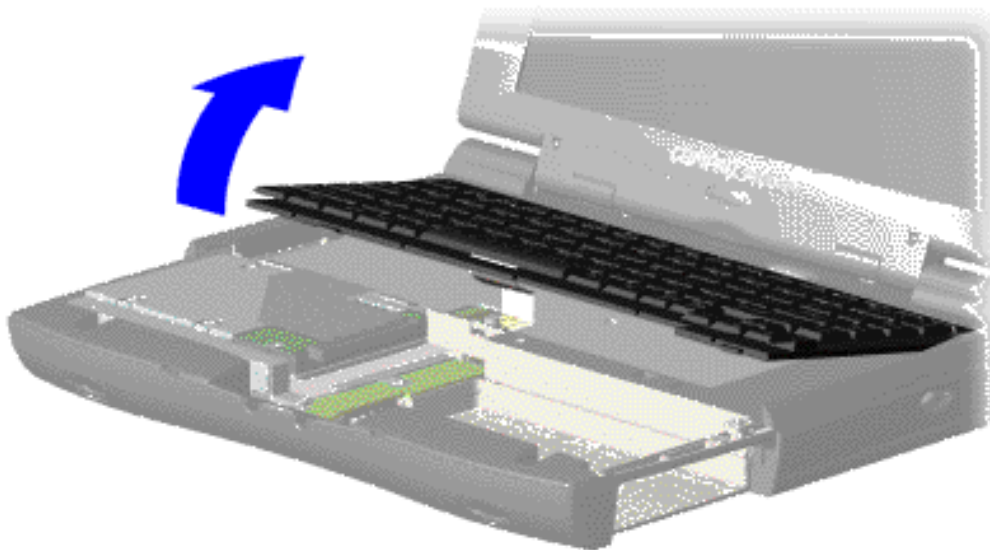

### Removing the Keyboard

1. [Prepare the computer for disassembly.](#)
2. Remove the [palmrest cover with touch pad.](#)
3. Gently lift and turn the keyboard over allowing it to rest on top of the palmrest cover with touchpad slot opening.
4. Remove the

[Modem](#)

[Display Panel  
Assembly](#)

[Upper CPU  
Cover](#)

[Speaker  
Assembly](#)

[Diskette Drive](#)

[Fan Assembly](#)

[System Board](#)

[Dip Switch  
Settings](#)

[Memory  
Module](#)

[heatspreader.](#)

[Next Step](#)

1.800.AT.COMPAQ

[privacy and legal statement](#)



COMPAQ

STORE | PRODUCTS | SERVICES | SUPPORT | CONTACT US | SEARCH

# Maintenance & Service Guide for Presario 1600 Series (Models 1683-1694)

- [Home Page](#) | [Notice](#) | [Preface](#) | [Product Description](#) | [Troubleshooting](#) | [Illustrated Parts Catalog](#) | [Removal & Replacement Procedures](#) | [Specifications](#) | [Pin Assignments](#) | [Battery Pack Operations](#)

## Removal and Replacement Procedures

|  |
|--|
| <b>Removal sequence</b>                                |
| <a href="#">Electrostatic Discharge</a>                |
| <a href="#">Service Considerations</a>                 |
| <a href="#">Cables and Connectors</a>                  |
| <a href="#">Preparing the Computer for Disassembly</a> |
| <a href="#">Battery Pack</a>                           |
| <a href="#">Palmrest Cover with Touch Pad</a>          |
| <a href="#">Heatspreader</a>                           |
| <a href="#">Keyboard</a>                               |
| <b>Processor</b>                                       |
| <a href="#">Hard Drive</a>                             |
| <a href="#">DVD or CD Drive</a>                        |
| <a href="#">Battery Charger Board</a>                  |

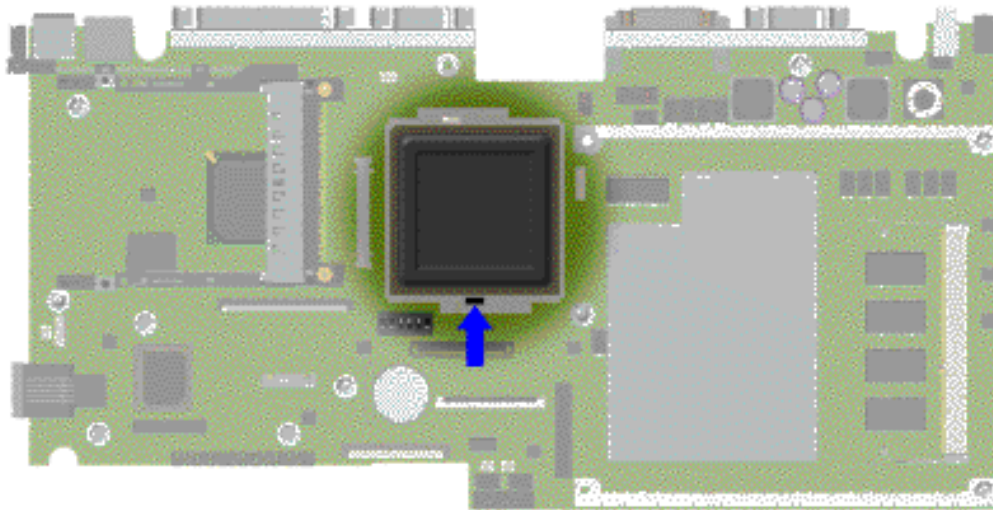

### Removing the Processor

1. Prepare the [computer for disassembly](#).
2. Remove the [palmrest cover with touch pad](#).
3. Remove the [keyboard](#).
4. Remove the [heatspreader](#).
5. Insert a small blade screw driver into the top slot opening on the processor

[Modem](#)

[Display Panel  
Assembly](#)

[Upper CPU  
Cover](#)

[Speaker  
Assembly](#)

[Diskette Drive](#)

[Fan Assembly](#)

[System Board](#)

[Dip Switch  
Settings](#)

[Memory  
Module](#)

and push away from the display to release the processor from the chassis slot.

**6.** Lift the processor out of the processor chassis slot.

***[Next Step](#)***

1.800.AT.COMPAQ

[privacy and legal statement](#)

# Maintenance & Service Guide for Presario 1600 Series (Models 1683-1694)

[Home Page](#) | [Notice](#) | [Preface](#) | [Product Description](#) | [Troubleshooting](#) | [Illustrated Parts Catalog](#) |

[Removal & Replacement Procedures](#) | [Specifications](#) | [Pin Assignments](#) | [Battery Pack Operations](#)

## Removal and Replacement Procedures

**Removal sequence**

[Electrostatic Discharge](#)

[Service Considerations](#)

[Cables and Connectors](#)

[Preparing the Computer for Disassembly](#)

[Battery Pack](#)

[Palmrest Cover with Touch Pad](#)

[Heatspreader](#)

[Keyboard](#)

[Processor](#)

[Hard Drive](#)

[DVD or CD Drive](#)

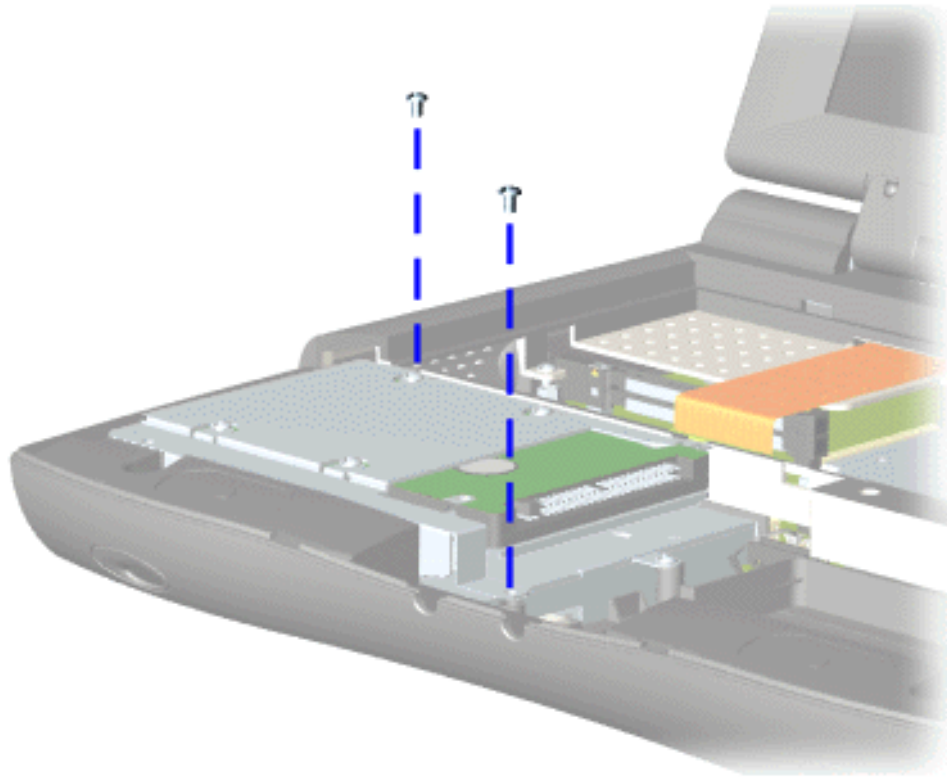

### Removing the Hard Drive

1. Prepare the [computer for disassembly](#).
2. Remove the [palmrest cover with touch pad](#).
3. Remove the [keyboard](#).
4. Remove two screws from the hard drive mounting bracket and lift out the hard drive

[Battery  
Charger Board](#)

[Modem](#)

[Display Panel  
Assembly](#)

[Upper CPU  
Cover](#)

[Speaker  
Assembly](#)

[Diskette Drive](#)

[Fan Assembly](#)

[System Board](#)

[Dip Switch  
Settings](#)

[Memory  
Module](#)

with drive  
mounting  
bracket  
attached.

***[Next Step](#)***

**1.800.AT.COMPAQ**

[privacy and legal statement](#)

# Maintenance & Service Guide for Presario 1600 Series (Models 1683-1694)

- [Home Page](#) | [Notice](#) | [Preface](#) | [Product Description](#) | [Troubleshooting](#) | [Illustrated Parts Catalog](#) | [Removal & Replacement Procedures](#) | [Specifications](#) | [Pin Assignments](#) | [Battery Pack Operations](#)

## Removal and Replacement Procedures

### Removal sequence

[Electrostatic Discharge](#)

[Service Considerations](#)

[Cables and Connectors](#)

[Preparing the Computer for Disassembly](#)

[Battery Pack](#)

[Palmrest Cover with Touch Pad](#)

[Heatspreader](#)

[Keyboard](#)

[Processor](#)

[Hard Drive](#)

[DVD or CD Drive](#)

[Battery Charger Board](#)

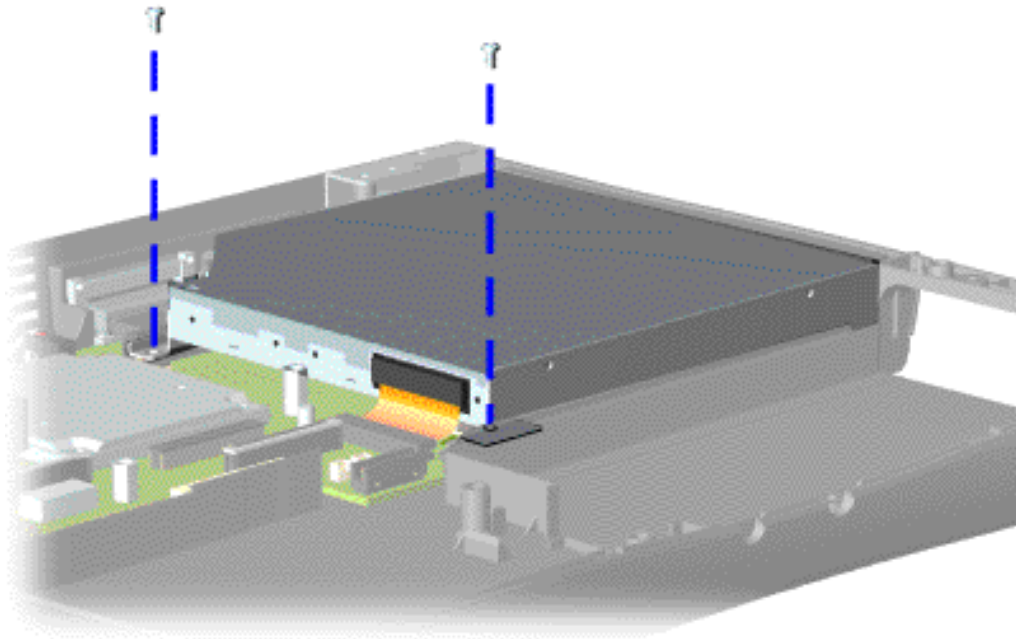

### Removing the DVD or CD Drive

1. Prepare the [computer for disassembly](#).
2. Remove the [palmrest cover with touch pad](#).
3. Remove the [keyboard](#).
4. Remove the [heatspreader](#).
5. Remove two screws located at the back DVD or CD drive.

**[Next Step](#)**

**[Modem](#)**

**[Display Panel  
Assembly](#)**

**[Upper CPU  
Cover](#)**

**[Speaker  
Assembly](#)**

**[Diskette Drive](#)**

**[Fan Assembly](#)**

**[System Board](#)**

**[Dip Switch  
Settings](#)**

**[Memory  
Module](#)**

**1.800.AT.COMPAQ**

[privacy and legal statement](#)

## Maintenance & Service Guide for Presario 1600 Series (Models 1683-1694)

- [Home Page](#) | [Notice](#) | [Preface](#) | [Product Description](#) | [Troubleshooting](#) | [Illustrated Parts Catalog](#) | [Removal & Replacement Procedures](#) | [Specifications](#) | [Pin Assignments](#) | [Battery Pack Operations](#)

### Removal and Replacement Procedures

#### Removal sequence

[Electrostatic Discharge](#)

[Service Considerations](#)

[Cables and Connectors](#)

[Preparing the Computer for Disassembly](#)

[Battery Pack](#)

[Palmrest Cover with Touch Pad](#)

[Heatspreader](#)

[Keyboard](#)

[Processor](#)

[Hard Drive](#)

[DVD or CD Drive](#)

[Battery Charger Board](#)

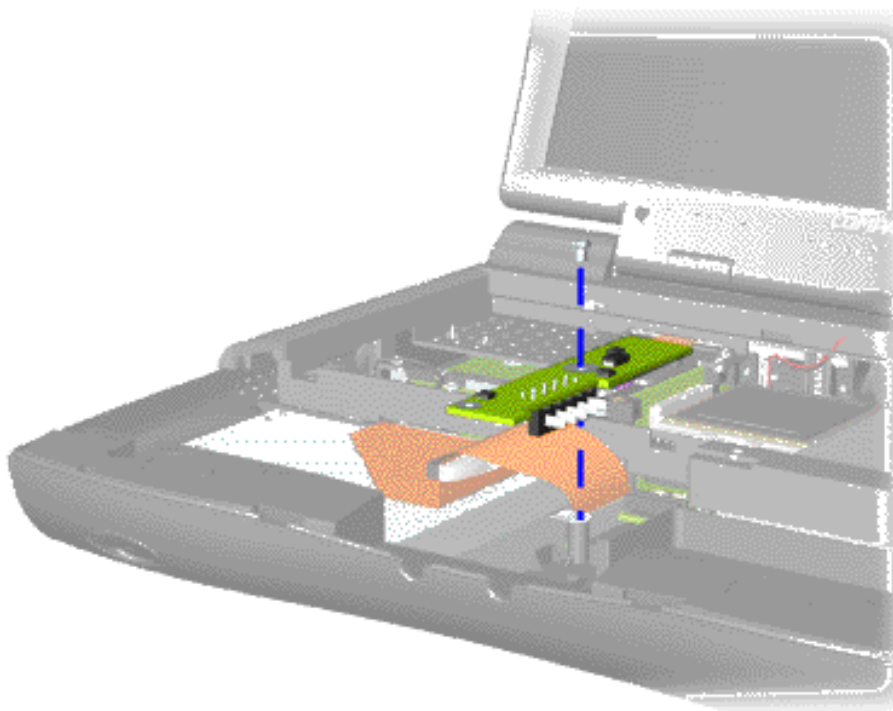

#### Removing the Battery Charger Board

1. Prepare the [computer for disassembly](#).
2. Remove the [palmrest cover with touch pad](#).
3. Remove the [keyboard](#).
4. Remove the [heatspreader](#).
5. Remove the [hard drive](#).
6. Remove one screw from the battery charger board, unplug the board from the connector on the system board, and lift out of the chassis.

[Modem](#)

[Display Panel  
Assembly](#)

[Upper CPU  
Cover](#)

[Speaker  
Assembly](#)

[Diskette Drive](#)

[Fan Assembly](#)

[System Board](#)

[Dip Switch  
Settings](#)

[Memory  
Module](#)

To replace the battery charger board, reverse the previous procedures.

**NOTE:** When replacing the battery charger board, ensure the pins are aligned with the connector on the system board.

1.800.AT.COMPAQ

[privacy and legal statement](#)



COMPAQ

STORE | PRODUCTS | SERVICES | SUPPORT | CONTACT US | SEARCH

# Maintenance & Service Guide Presario Series

## Models: 1683, 1685, 1687, 1688, 1690, 1692, 1693, and 1694

- [Home Page](#) | [Notice](#) | [Preface](#) | [Product Description](#) | [Troubleshooting](#) | [Illustrated Parts Catalog](#) | [Removal & Replacement Procedures](#) | [Specifications](#) | [Pin Assignments](#) | [Battery Pack Operations](#)

## Removal and Replacement Procedures

### Removal sequence

[Electrostatic Discharge](#)

[Service Considerations](#)

[Cables and Connectors](#)

[Preparing the Computer for Disassembly](#)

[Battery Pack](#)

[Palmrest Cover with Touch Pad](#)

[Heatspreader](#)

[Keyboard](#)

[Processor](#)

[Hard Drive](#)

[DVD or CD Drive](#)

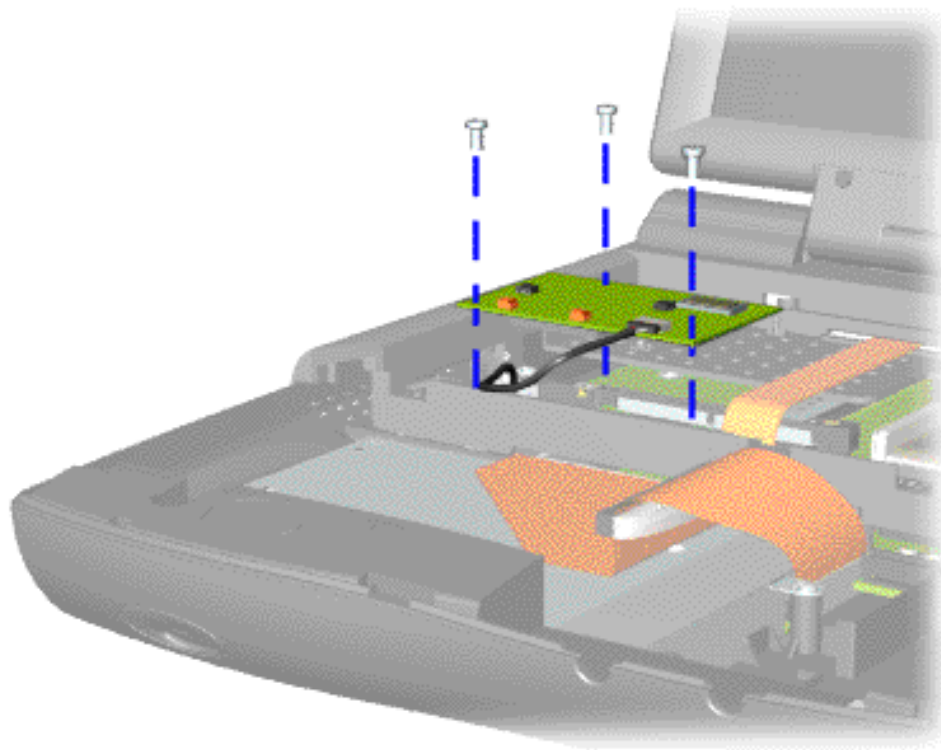

### Removing the Modem

1. Prepare the [computer for disassembly](#).
2. Remove the [palmrest cover with touch pad](#).
3. Remove the [keyboard](#).
4. Remove the [heatspreader](#).
5. Remove three screws securing modem and pull the modem off

[Battery](#)

[Charger Board](#)

[Modem](#)

[Display Panel](#)

[Assembly](#)

[Upper CPU](#)

[Cover](#)

[Speaker](#)

[Assembly](#)

[Diskette Drive](#)

[Fan Assembly](#)

[System Board](#)

[Dip Switch](#)

[Settings](#)

[Memory](#)

[Module](#)

the  
connector on  
the system  
board.

[\*\*\*Next Step\*\*\*](#)

1.800.AT.COMPAQ

[privacy and legal statement](#)

# Maintenance & Service Guide for Presario 1600 Series (Models 1683-1694)

- [Home Page](#) | [Notice](#) | [Preface](#) | [Product Description](#) | [Troubleshooting](#) | [Illustrated Parts Catalog](#) | [Removal & Replacement Procedures](#) | [Specifications](#) | [Pin Assignments](#) | [Battery Pack Operations](#)

## Removal and Replacement Procedures

|  |
|--|
| <b>Removal sequence</b>                                |
| <a href="#">Electrostatic Discharge</a>                |
| <a href="#">Service Considerations</a>                 |
| <a href="#">Cables and Connectors</a>                  |
| <a href="#">Preparing the Computer for Disassembly</a> |
| <a href="#">Battery Pack</a>                           |
| <a href="#">Palmrest Cover with Touch Pad</a>          |
| <a href="#">Heatspreader</a>                           |
| <a href="#">Keyboard</a>                               |
| <a href="#">Processor</a>                              |
| <a href="#">Hard Drive</a>                             |
| <a href="#">DVD or CD Drive</a>                        |
| <a href="#">Battery Charger Board</a>                  |

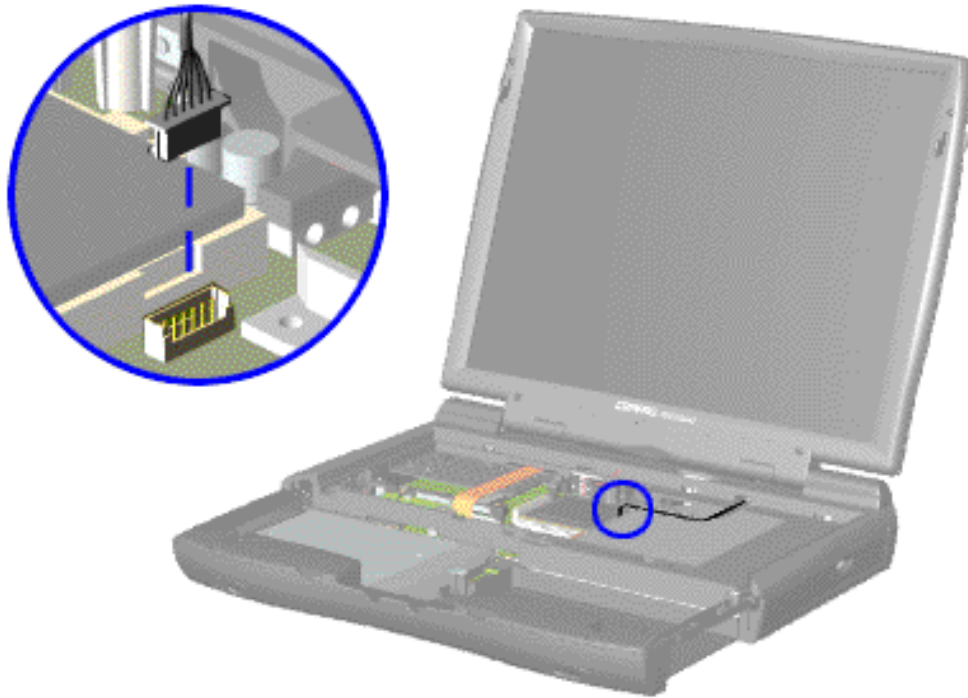

### Removing the Display Panel Assembly

1. Prepare the [computer for disassembly](#).
2. Remove the [palmrest cover with touch pad](#).
3. Remove the [keyboard](#).
4. Remove the [heatspreader](#).
5. Remove the [modem](#).
6. Disconnect the backlight

[Modem](#)

[Display Panel Assembly](#)

[Upper CPU Cover](#)

[Speaker Assembly](#)

[Diskette Drive](#)

[Fan Assembly](#)

[System Board](#)

[Dip Switch Settings](#)

[Memory Module](#)

cable attached to the display panel assembly from the connector on the system board.

**[Next Step](#)**

1.800.AT.COMPAQ

[privacy and legal statement](#)

## Maintenance & Service Guide Presario 1600 Series

[Home Page](#) | [Notice](#) | [Preface](#) | [Product Description](#) |

[Troubleshooting](#) | [Illustrated Parts Catalog](#) |

[Removal & Replacement Procedures](#) | [Specifications](#) | [Pin Assignments](#) | [Battery Pack Operations](#)

### Removal and Replacement Procedures

#### Removal sequence

[Electrostatic Discharge](#)

[Service Considerations](#)

[Cables and Connectors](#)

[Preparing the Computer for Disassembly](#)

[Battery Pack](#)

[Palmrest Cover with Touch Pad](#)

[Heatspreader](#)

[Keyboard](#)

[Processor](#)

[Hard Drive](#)

[DVD or CD Drive](#)

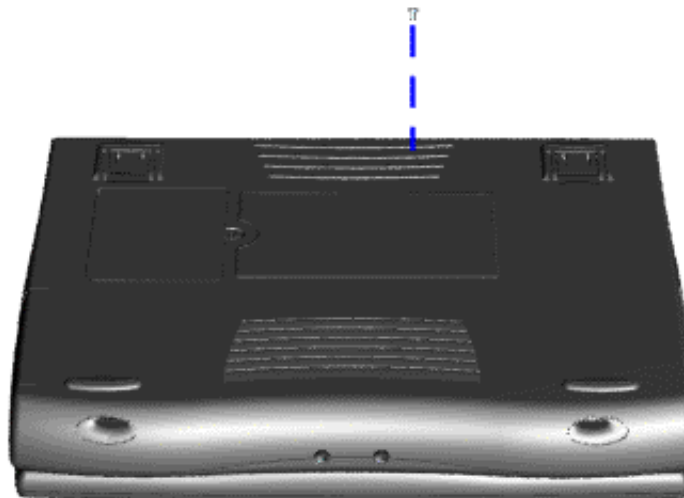

#### Removing the Upper CPU Cover

1. Prepare the [computer for disassembly](#).
2. Remove the [palmrest cover with touch pad](#).
3. Remove the [keyboard](#).
4. Remove the [heatspreader](#).
5. Remove the [hard drive](#).
6. Remove the [display panel assembly](#).
7. Remove the screw located under the bottom of the unit (rear) which secures

[Battery](#)  
[Charger Board](#)

[Modem](#)

[Display Panel](#)  
[Assembly](#)

[Upper CPU](#)  
[Cover](#)

[Speaker](#)  
[Assembly](#)

[Diskette Drive](#)

[Fan Assembly](#)

[System Board](#)

[Dip Switch](#)  
[Settings](#)

[Memory](#)  
[Module](#)

the Upper CPU cover  
to the chassis.

[\*\*Next Step\*\*](#)

1.800.AT.COMPAQ

[privacy and legal statement](#)

## Maintenance & Service Guide for Presario 1600 Series (Models 1683-1694)

| [Home Page](#) | [Notice](#) | [Preface](#) | [Product Description](#) | [Troubleshooting](#) | [Illustrated Parts Catalog](#) |

[Removal & Replacement Procedures](#) | [Specifications](#) | [Pin Assignments](#) | [Battery Pack Operations](#)

### Removal and Replacement Procedures

#### Removal sequence

[Electrostatic Discharge](#)

[Service Considerations](#)

[Cables and Connectors](#)

[Preparing the Computer for Disassembly](#)

[Battery Pack](#)

[Palmrest Cover with Touch Pad](#)

[Keyboard](#)

[Heatspreader](#)

[Processor](#)

[Hard Drive](#)

[DVD or CD Drive](#)

Need CAD here!!

#### *Removing the Network Interface Card*

To remove the Network Interface Card complete the following steps:

1. Prepare the [computer for disassembly](#).
2. Remove the [palmrest cover with touch pad](#).
3. Remove the [keyboard](#).
4. Remove the [heatspreader](#).
5. Remove the [hard drive](#).
6. Remove the [display panel assembly](#).

[Battery  
Charger Board](#)

[Modem](#)

[Display Panel  
Assembly](#)

[Upper CPU  
Cover](#)

[Speaker  
Assembly](#)

[Diskette Drive](#)

[Fan Assembly](#)

[System Board](#)

[Dip Switch  
Settings](#)

[Memory  
Module](#)

[1.800.AT.COMPAQ](tel:1800.AT.COMPAQ)

[privacy and legal statement](#)



## Maintenance & Service Guide for Presario 1600 Series (Models 1683-1694)

[Home Page](#) | [Notice](#) | [Preface](#) | [Product Description](#) | [Troubleshooting](#) | [Illustrated Parts Catalog](#) | [Removal & Replacement Procedures](#) | [Specifications](#) | [Pin Assignments](#) | [Battery Pack Operations](#)

### Removal and Replacement Procedures

#### Removal Sequence

[Electrostatic Discharge](#)

[Service Considerations](#)

[Cables and Connectors](#)

[Preparing the Computer for Disassembly](#)

[Battery Pack](#)

[Palmrest Cover with Touch Pad](#)

[Heatspreader](#)

[Keyboard](#)

[Processor](#)

[Hard Drive](#)

[DVD or CD Drive](#)

[Battery Charger Board](#)

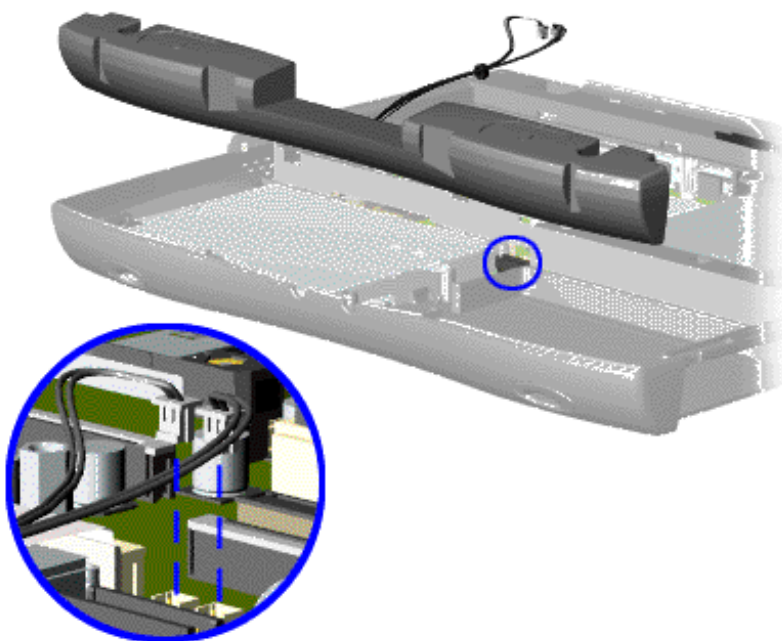

#### Removing the Speaker Assembly

1. Prepare the computer for disassembly.
2. Remove the [palmrest cover with touch pad](#).
3. Remove the [keyboard](#).
4. Remove the [heatspreader](#).
5. Remove the [hard drive](#).
6. Remove the [display panel assembly](#).
7. Remove the [Upper CPU cover](#).
8. Remove the [charger board](#).
9. Disconnect the speaker cables from the [system board](#) and remove the speaker assembly from the chassis.

To replace the [speaker assembly](#), reverse the previous procedures.

|  |
|--|
| <a href="#">Modem</a>                  |
| <a href="#">Display Panel Assembly</a> |
| <a href="#">Upper CPU Cover</a>        |
| <a href="#">Speaker Assembly</a>       |
| <a href="#">Diskette Drive</a>         |
| <a href="#">Fan Assembly</a>           |
| <a href="#">System Board</a>           |
| <a href="#">Dip Switch Settings</a>    |
| <a href="#">Memory Module</a>          |

[1.800.AT.COMPAQ](#)

[privacy and legal statement](#)

## Maintenance & Service Guide Presario 1600 Series

- [Home Page](#) | [Notice](#) | [Preface](#) | [Product Description](#) | [Troubleshooting](#) | [Illustrated Parts Catalog](#) | [Removal & Replacement Procedures](#) | [Specifications](#) | [Pin Assignments](#) | [Battery Pack Operations](#)

### Removal and Replacement Procedures

#### **Removal sequence**

[Electrostatic Discharge](#)

[Service Considerations](#)

[Cables and Connectors](#)

[Preparing the Computer for Disassembly](#)

[Battery Pack](#)

[Palmrest Cover with Touch Pad](#)

[Heatspreader](#)

[Keyboard](#)

[Processor](#)

[Hard Drive](#)

[DVD or CD Drive](#)

[Battery Charger Board](#)

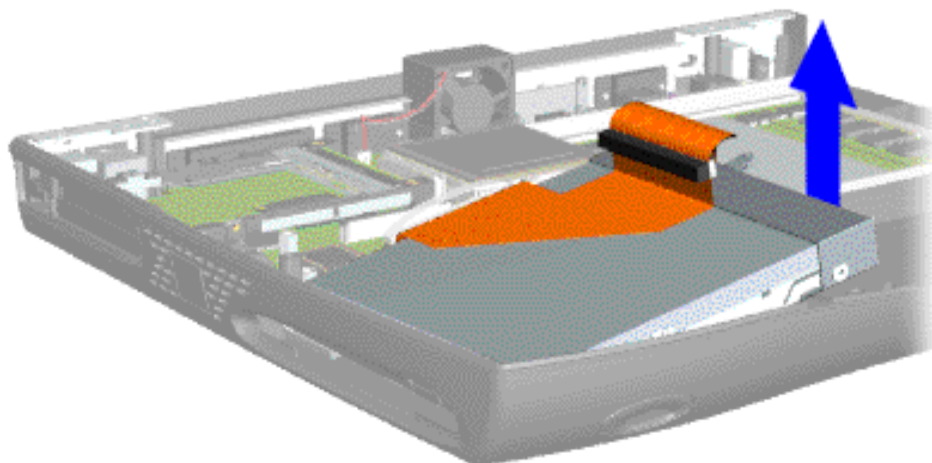

#### **Removing the Diskette Drive**

1. [Prepare the computer for disassembly.](#)
2. Remove the [palmrest cover with touch pad.](#)
3. Remove the [keyboard.](#)
4. Remove the [heatspreader.](#)
5. Remove the [hard drive.](#)
6. Remove the [display panel assembly.](#)
7. Remove the [upper CPU cover.](#)
8. Remove the

[Modem](#)

[Display Panel Assembly](#)

[Upper CPU Cover](#)

[Speaker Assembly](#)

[Diskette Drive](#)

[Fan Assembly](#)

[System Board](#)

[Dip Switch Settings](#)

[Memory Module](#)

[battery charger board](#).

**9.** Remove the [speaker assembly](#).

**10.** Disconnect the diskette drive data cable from the system board.

To replace the diskette drive, reverse the previous procedures.

**NOTE:**

Ensure the diskette drive eject lever is properly inserted in the chassis slot, when replacing the diskette drive.

1.800.AT.COMPAQ

[privacy and legal statement](#)

COMPAQ

[STORE](#) | [PRODUCTS](#) | [SERVICES](#) | [SUPPORT](#) | [CONTACT US](#) | [SEARCH](#)

## Maintenance & Service Guide for Presario 1600 Series (Models 1683-1694)

| [Home Page](#) | [Notice](#) | [Preface](#) | [Product Description](#) | [Troubleshooting](#) | [Illustrated Parts Catalog](#) |

[Removal & Replacement Procedures](#) | [Specifications](#) | [Pin Assignments](#) | [Battery Pack Operations](#)

### Removal and Replacement Procedures

#### Removal sequence

[Electrostatic Discharge](#)

[Service Considerations](#)

[Cables and Connectors](#)

[Preparing the Computer for Disassembly](#)

[Battery Pack](#)

[Palmrest Cover with Touch Pad](#)

[Heatspreader](#)

[Keyboard](#)

[Processor](#)

[Hard Drive](#)

[DVD or CD Drive](#)

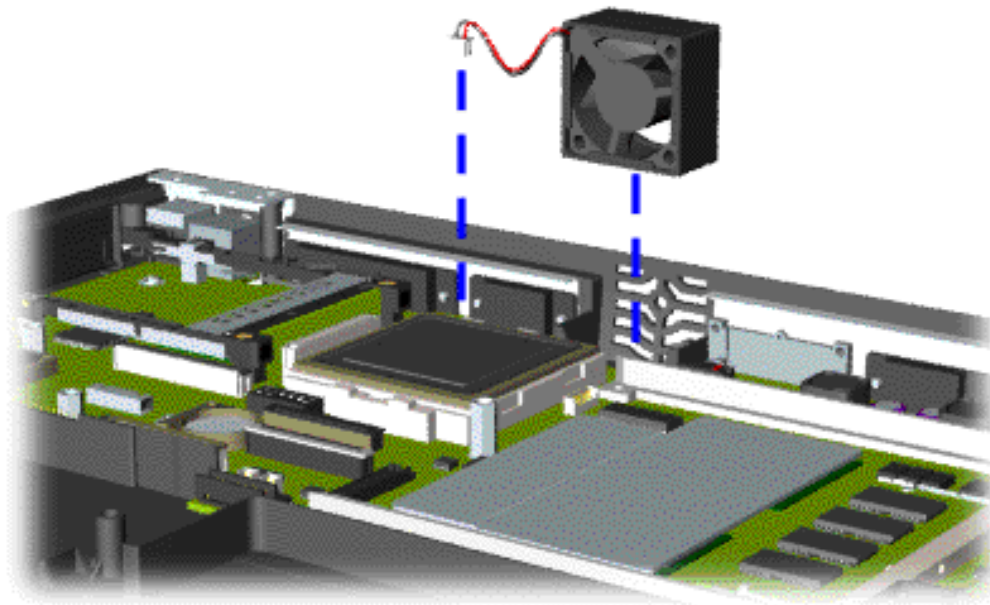

#### Removing the Fan Assembly

1. Prepare the [computer for disassembly](#).
2. Remove the [palmrest cover with touch pad](#).
3. Remove the [keyboard](#).
4. Remove the [heatspreader](#).
5. Remove the [display panel assembly](#).
6. Remove

[Battery](#)  
[Charger Board](#)

[Modem](#)

[Display Panel](#)  
[Assembly](#)

[Upper CPU](#)  
[Cover](#)

[Speaker](#)  
[Assembly](#)

[Diskette Drive](#)

[Fan Assembly](#)

[System Board](#)

[Dip Switch](#)  
[Settings](#)

[Memory](#)  
[Module](#)

the [hard](#)  
[drive](#).

**7.** Remove  
the [Upper](#)  
[CPU cover](#).

**8.** Lift the  
fan assembly  
from the  
chassis slot  
and  
disconnect  
the fan cable  
from the  
connector on  
the system  
board.

**[Next Step](#)**

1.800.AT.COMPAQ

[privacy and legal statement](#)

COMPAQ

[STORE](#) | [PRODUCTS](#) | [SERVICES](#) | [SUPPORT](#) | [CONTACT US](#) | [SEARCH](#)

## Maintenance & Service Guide for Presario 1600 Series (Models 1683-1694)

[Home Page](#) | [Notice](#) | [Preface](#) | [Product Description](#) |

[Troubleshooting](#) | [Illustrated Parts Catalog](#) |

[Removal & Replacement Procedures](#) | [Specifications](#) | [Pin Assignments](#) | [Battery Pack Operations](#)

### Removal and Replacement Procedures

#### Removal sequence

#### [Electrostatic Discharge](#)

#### [Service Considerations](#)

#### [Cables and Connectors](#)

#### [Preparing the Computer for Disassembly](#)

#### [Battery Pack](#)

#### [Palmrest Cover with Touch Pad](#)

#### [Heatspreader](#)

#### [Keyboard](#)

#### [Processor](#)

#### [Hard Drive](#)

#### [DVD or CD Drive](#)

#### *Removing the System Board*

1. Prepare the [computer for disassembly](#).
2. Remove the [palmrest cover with touch pad](#).
3. Remove the [keyboard](#).
4. Remove the [heatspreader](#).
5. Remove the [processor](#).
6. Remove the [modem](#).
7. Remove the [hard drive](#).
8. Remove the [display panel assembly](#).
9. Remove the [Upper CPU Cover](#).
10. Remove the [battery charger board](#).
11. Remove the [speaker assembly](#).

[Battery](#)

[Charger Board](#)

[Modem](#)

[Display Panel  
Assembly](#)

[Upper CPU  
Cover](#)

[Speaker  
Assembly](#)

[Diskette Drive](#)

[Fan Assembly](#)

[System Board](#)

[Dip Switch  
Settings](#)

[Memory  
Module](#)

12. Remove the [diskette drive](#).

13. Remove the [CD or DVD drive](#).

14. Remove the [fan assembly](#).

**IMPORTANT:**

When replacing the system board remove the memory module on the system board.

*[Next Step](#)*

1.800.AT.COMPAQ

[privacy and legal statement](#)



## Maintenance & Service Guide for Presario 1600 Series (Models 1683-1694)

[Home Page](#) | [Notice](#) | [Preface](#) | [Product Description](#) | [Troubleshooting](#) | [Illustrated Parts Catalog](#) | [Removal & Replacement Procedures](#) | [Specifications](#) | [Pin Assignments](#) | [Battery Pack Operations](#)

### Removal and Replacement Procedures

#### Dip Switch Settings for models 1683-1690

[Click here for other models \(1692-1694\)](#)



**CAUTION:** Only change settings **1-5** on SW1 **1**. Settings **6-10** vary by model and should not be changed when replacing the system board. Ensure the dip switch voltage settings (SW1 **1** and SW3 **3**) on the system board are correct for the computer model and processor voltage marked on the processor chip. If the system board dip switch voltage settings are not correct, damage may occur to the computer and/or system board.

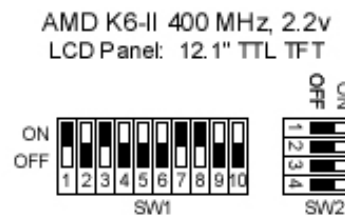
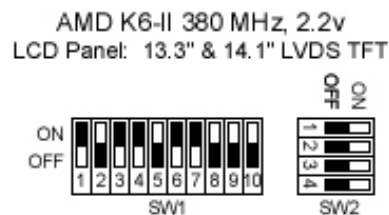
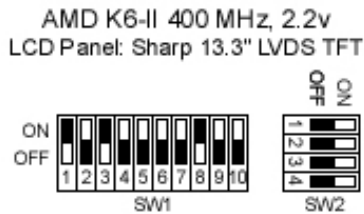
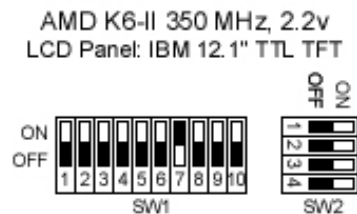
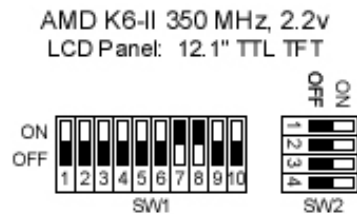

AMD K6-II 380 MHz, 2.2v

AMD K6-II 400 MHz, 2.2v

AMD K6-II 380 MHz, 2.2v  
LCD Panel: Sharp 13.3" LVDS TFT



AMD K6-II 400 MHz, 2.2v  
LCD Panel: 12.1" LVDS TFT



AMD K6-II 380 MHz, 2.2v  
LCD Panel: 12.1" TTL TFT



AMD K6-II 400 MHz, 2.2v  
LCD Panel: IBM 12.1" TTL TFT



AMD K6-II 380 MHz, 2.2v  
LCD Panel: 12.1" LVDF TFT

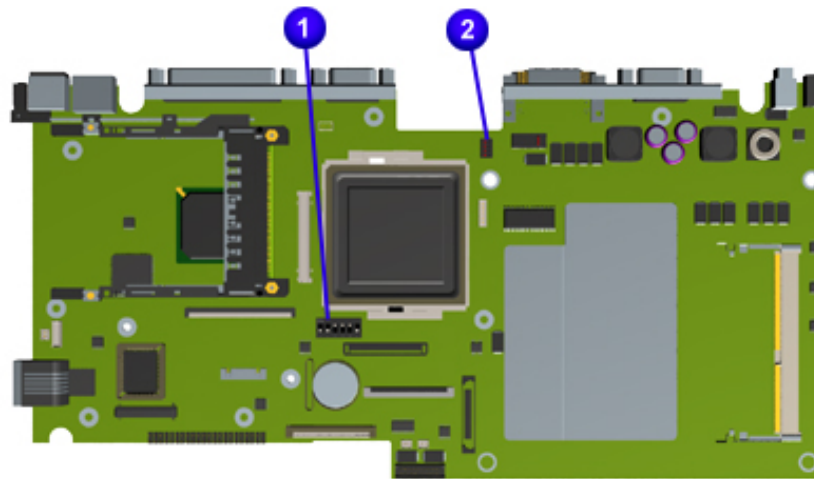

**NOTE:** The black area on the dip switch indicates the position of the switch.

[Return to Removal & Replacement Procedures](#)

1.800.AT.COMPAQ

[privacy and legal statement](#)

# Maintenance & Service Guide for Presario 1600 Series (Models 1683-1694)

- [Home Page](#) | [Notice](#) | [Preface](#) | [Product Description](#) | [Troubleshooting](#) | [Illustrated Parts Catalog](#) | [Removal & Replacement Procedures](#) | [Specifications](#) | [Pin Assignments](#) | [Battery Pack Operations](#)

## Removal and Replacement Procedures

|  |
|--|
| <b>Removal sequence</b>                                |
| <a href="#">Electrostatic Discharge</a>                |
| <a href="#">Service Considerations</a>                 |
| <a href="#">Cables and Connectors</a>                  |
| <a href="#">Preparing the Computer for Disassembly</a> |
| <a href="#">Battery Pack</a>                           |
| <a href="#">Palmrest Cover with Touch Pad</a>          |
| <a href="#">Heatspreader</a>                           |
| <a href="#">Keyboard</a>                               |
| <a href="#">Processor</a>                              |
| <a href="#">Hard Drive</a>                             |
| <a href="#">DVD or CD Drive</a>                        |
| <a href="#">Battery Charger Board</a>                  |
| <a href="#">Modem</a>                                  |

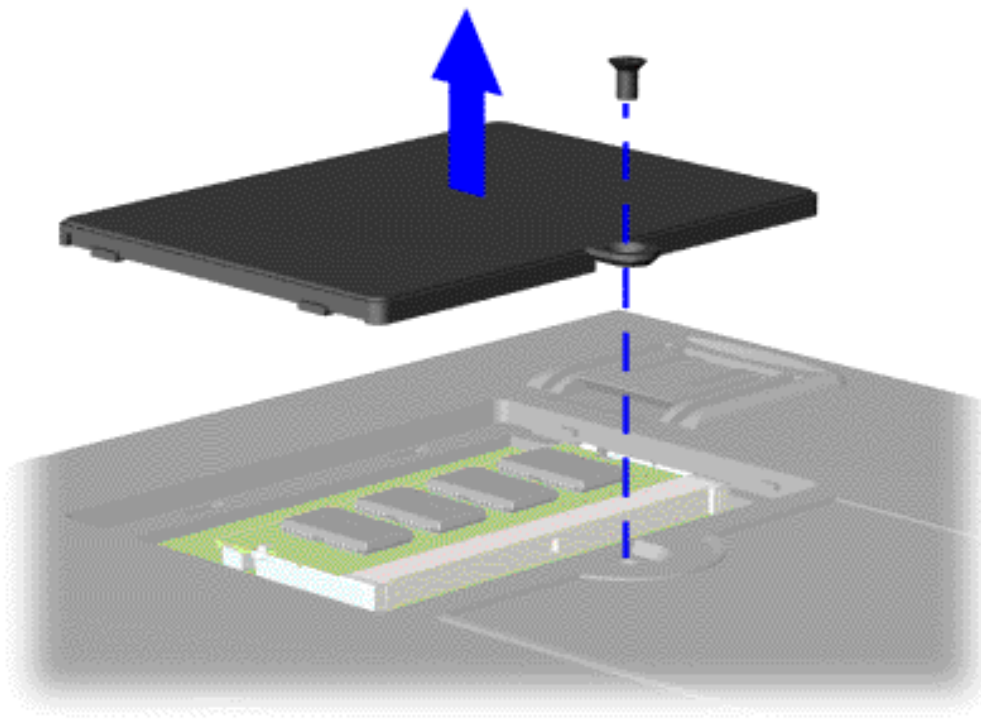

### Removing the Memory Module

To remove the memory module, complete the following steps:

1. Prepare the [computer for disassembly](#).
2. Close the computer and turn the computer upside down.
3. Remove the screw from the memory module door, and slide the

[Display Panel  
Assembly](#)

[Upper CPU  
Cover](#)

[Speaker  
Assembly](#)

[Diskette Drive](#)

[Fan Assembly](#)

[System Board](#)

[Dip Switch  
Settings](#)

[Memory  
Module](#)

memory  
module door  
to the right.

**[Next Step](#)**

1.800.AT.COMPAQ

[privacy and legal statement](#)

## Free Manuals Download Website

<http://myh66.com>

<http://usermanuals.us>

<http://www.somanuals.com>

<http://www.4manuals.cc>

<http://www.manual-lib.com>

<http://www.404manual.com>

<http://www.luxmanual.com>

<http://aubethermostatmanual.com>

Golf course search by state

<http://golfingnear.com>

Email search by domain

<http://emailbydomain.com>

Auto manuals search

<http://auto.somanuals.com>

TV manuals search

<http://tv.somanuals.com>