

maintenance & service guide

Presario 1600 Series

Models: 1683, 1685, 1687, 1688, 1690, 1692, 1693, and 1694

Before You Begin	Specifications	Parts Catalog
Removal Sequence	Troubleshooting	Battery Operations
Product Description	Pin Assignments	Index



Compaq Presario 1600 System

Welcome to the Maintenance & Service Guide (MSG). This online guide is designed to serve the needs of those whose job it is to repair Compaq products. The [Notice](#), contains the copyright and trademark information. The [Preface](#) shows symbol conventions, Technician Notes and [Serial Number locations](#) on the unit. This MSG will be periodically maintained and updated online as needed.

For content comments or questions, contact [Tech Support](#).

To report a technical problem, contact your Regional Support Center or IM Help Center.

maintenance & service guide

Presario 1600 Series

Models: 1683, 1685, 1687, 1688, 1690, 1692, 1693, and 1694

Before You Begin	Specifications	Parts Catalog
Removal Sequence	Troubleshooting	Battery Operations
Product Description	Pin Assignments	Index

Notice

The information in this guide is subject to change without notice.

COMPAQ COMPUTER CORPORATION SHALL NOT BE LIABLE FOR TECHNICAL OR EDITORIAL ERRORS OR OMISSIONS CONTAINED HEREIN, NOR FOR INCIDENTAL OR CONSEQUENTIAL DAMAGES RESULTING FROM THE FURNISHING, PERFORMANCE, OR USE OF THIS MATERIAL.

This guide contains information protected by copyright. No part of this guide may be photocopied or reproduced in any form without prior written consent from Compaq Computer Corporation.

1998 Compaq Computer Corporation.
All rights reserved. Printed in the U.S.A.

Compaq, Presario Series Registered U. S. Patent and Trademark Office.

Microsoft, MS-DOS, and Windows are registered trademarks of Microsoft Corporation. Windows 98 is a trademark of Microsoft Corporation.

The software described in this guide is furnished under a license agreement or nondisclosure agreement. The software may be used or copied only in accordance with the terms of the agreement.

Product names mentioned herein may be trademarks and/or registered trademarks of their respective companies.

Maintenance and Service Guide

Compaq Presario Series Portable Computer

First Edition (March 1999)
Compaq Computer Corporation

maintenance & service guide

Presario 1600 Series

Models: 1683, 1685, 1687, 1688, 1690, 1692, 1693, and 1694

Before You Begin	Specifications	Parts Catalog
Removal Sequence	Troubleshooting	Battery Operations
Product Description	Pin Assignments	Index

Preface

This *Maintenance and Service Guide* is a troubleshooting guide that can be used for reference when servicing the Compaq Presario Series Portable Computers.

Compaq Computer Corporation reserves the right to make changes to the Compaq Presario Series Portable Computers without notice.

Symbols

The following words and symbols mark special messages throughout this guide.



WARNING: Text set off in this manner indicates that failure to follow directions in the warning could result in bodily harm or loss of life.



CAUTION: Text set off in this manner indicates that failure to follow directions could result in damage to equipment or loss of data.

IMPORTANT: Text set off in this manner presents clarifying information or specific instructions.

NOTE: Text set off in this manner presents commentary, sidelights, or interesting points of information.

Technician Notes



WARNING: Only authorized technicians trained by Compaq should repair this equipment. All troubleshooting and repair procedures are detailed to allow only subassembly/module level repair. Because of the complexity of the individual boards and subassemblies, the user should not attempt to make repairs at the component level or to make modifications to any printed circuit board. Improper repairs can create a safety hazard. Any indications of component replacement or printed circuit board modifications may void any warranty.

Serial Number

When requesting information or ordering spare parts, the computer serial number should be provided to Compaq. The serial number is located on the bottom of the computer.

Locating Additional Information

The following documentation is available to support this product:

- Compaq Presario Series Portable Computer documentation set
- *Introducing Windows 98 Guide*
- Service Training Guides
- Compaq Service Advisories and Bulletins
- *Compaq QuickFind*
- *Compaq Service Quick Reference Guide*

maintenance & service guide

Presario 1600 Series

Models: 1683, 1685, 1687, 1688, 1690, 1692, 1693, and 1694

Before You Begin	Specifications	Parts Catalog
Removal Sequence	Troubleshooting	Battery Operations
Product Description	Pin Assignments	Index

Specifications

This chapter covers the following specifications of Compaq Presario Series Portable Computers:

- Physical and Environmental
- System Interrupts
- System DMA
- System I/O Address
- System Memory Catalog
- Display
- Memory Expansion
- Diskette Drive
- Hard Drive
- DVD or CD Drive
- Battery Pack

Physical and Environmental

Computer Specifications		
	U.S.	Metric
Dimensions		
Height	1.97 in	5.0 cm
Depth	12.32 in	31.3 cm
Width	10.12 in	25.7 cm
Weight		
Model 1683	(Data not available)	(Data not available)
Model 1685	7.19lbs	3260 g
Model 1687	7.19 lbs	3340 g
Model 1688	7.36 lbs	3520 g
Model 1690	7.76 lbs	
Stand-Alone (Battery Pack) Power Requirements	Li Ion	
Nominal Operating Voltage	W @ 14.8 VDC	
Maximum Operating Power	W @ 56.5 W	
Peak Operating Power	W @ 58.5 W	
AC Power Requirements	(Information not available)	
Operating Voltage		
Operating Current		
Operating Frequency		
Maximum Transient		
Temperature		
Operating	41° to 95 °F	5° to 35 °C
Nonoperating	-4° to 140 °F	-20° to 60 °C
Relative Humidity (Non-condensing)		
Operating	10 to 90%	35°C to 90%
Nonoperating (tw = 38.7°C max)	5 to 95%	60°C to 95%
Altitude		
Operating	0 to 10,000 ft	0 to 3.15 km
Nonoperating	0 to 30,000 ft	0 to 10.14 km
Shock		
Operating	10 G, 11 ms, half sine	
Non operating	240 G, 2 ms, half sine	
Vibration		
Operating	0.55 G, 0.25 Oct/Min sweep rate	
Nonoperating	1.5 G, 0.25 Oct/Min sweep rate	

NOTE: Applicable product safety standards specify thermal limits for plastic surfaces. Compaq Presario Series Portable Computers operate well within this range of temperatures.

System Interrupts

System Interrupts	
Hardware IRQ	System Function
IRQ0	System Timer
IRQ1	Standard 101/102-Key or Microsoft Natural Keyboard
IRQ2	Programmable interrupt controller
IRQ3	IRQ Holder for PCI Steering
IRQ3	Ali PCI to USB Open Host Controller
IRQ4	Communications Port (COM1)
IRQ5	IRQ Holder for PCI Steering
IRQ5	ESS SOLO-1 PCI AudioDrive
IRQ5	IRQ Holder for PCI Steering
IRQ6	Standard Floppy Disk Controller
IRQ7	Printer Port (LPT1)
IRQ8	System CMOS / real-time clock
IRQ9	RAGE LT PRO AGP 2X (English)
IRQ9	IRQ Holder for PCI Steering
IRQ10	Texas Instruments PCI-1211 CardBus Controller
IRQ10	IRQ Holder for PCI Steering
IRQ10	Lucent 56K V.90 PCI DF Modem
IRQ12	Synaptics PS/2 TouchPad
IRQ13	Numeric Data Processor
IRQ14	Ali M5229 PCI Bus Master IDE Controller
IRQ14	Primary IDE controller (dual fifo)
IRQ15	Ali M5229 PCI Bus Master IDE Controller
IRQ15	Secondary IDE controller (dual fifo)

System DMA

System DMA	
Hardware DMA	System Function
0	(free)
1	ESS SOLO-1 DOS Emulation
2	Standard Floppy Disk Controller
3	(free)
4	Direct memory access controller
5	(free)

System I/O Address

System I/O Address	
I/O Address (Hex)	System Function (Shipping Configuration)
0000 - 000Fh	Direct Memory Access Controller
0020h - 0021h	Programmable Interrupt Controller
0040h - 0043h	System Timer
0060h - x0060h	Standard 101/102-Key or Microsoft Natural Keyboard
0061h - x0061h	System Speaker
0064h - x0064h	Standard 101/102-Key or Microsoft Natural Keyboard
0070h - 0071h	System CMOS/Real Time Clock
0080h - 0080h	Motherboard Resources
0081h - 008Fh	Direct Memory Access controller
0092h - 0092h	Motherboard Resources
00A0h - 00A1h	Programmable Interrupt Controller
00B1h - 00B3h	Motherboard Resources
00C0h - 00DFh	Direct Memory Access controller
00EAh - 00EBh	Motherboard Resources
00F0h - 00FFh	Numeric Data Processor
0100h - 010Fh	Motherboard Resources
0170h - 0177h	Ali M5229 PCI Bus Master IDE Controller
0170h - 0177h	Secondary IDE Controller (dual fifo)
01F0h - 01F7h	Ali M5229 PCI Bus Master IDE Controller
0200h - 0203h	Gameport Joystick
0220h - 022Fh	ESS SOLO-1 DOS Emulation
0330h - 0331h	ESS SOLO-1 DOS Emulation
0376h - 0376h	Secondary IDE Controller (dual fifo)
0376h - 0376h	Ali M5229 PCI Bus Master IDE Controller
0378h - 037Fh	Printer Port (Lp1)
0388h - 038Bh	ESS SOLO-1 Dp1 Emulation
03B0h - 03BBh	RAGE LT PRO AGP 2X (English)
03C0h - 03DFh	RAGE LT PRO AGP 2X (English)
03F0h - 03F5h	Standard Floppy Disk Controller
03F6h - 03F6h	Primary IDE Controller (dual fifo)
03F6h - 03F6h	Ali M5229 PCI Bus Master IDE Controller
03F7h - 03F7h	Standard Floppy Disk Controller
03F8h - 03FFh	Communication Port (COM1)
040Bh - 040Bh	Motherboard Resources
040D0h - 04D1h	Motherboard Resources
04D6h - 04D6h	Motherboard Resources
0CF8h - 0CFh	PCI Bus
1000h - 103Fh	Motherboard Resources
1040h - 105Fh	Motherboard Resources
1060h - 106Fh	ESS SOLO-1 PCI AudioDrive
1070h - 107Fh	ESS SOLO-1 PCI AudioDrive
1400h - 14FFh	Lucent 56K V.90 PCI DF Modem
1800h - 183Fh	ESS SOLO-1 PCI AudioDrive
1840h - 184Fh	Primary IDE Controller (dual fifo)
1840h - 184Fh	Ali M5229 PCI Bus Master IDE Controller
1848h - 184Fh	Secondary IDE Controller (dual fifo)
1850h - 1853h	ESS SOLO-1 PCI AudioDrive
1854h - 1857h	ESS SOLO-1 PCI AudioDrive
1858h - 185Fh	Lucent 56K V.90 PCI DF Modem
2000h - 2FFFh	PCI Standard PCI-to-PCI Bridge
2000h - 20FFh	RAGE LT PRO AGP 2X (English)

System Memory Catalog

System Memory Catalog	
Memory Address	System Function
00000000h - 0009FFFFh	System Board Extension for PnP BIOS
000A0000h - 000BFFFFh	RAGE LT PRO AGP 2X (English)
000B0000h - 000BFFFFh	RAGE LT PRO AGP 2X (English)
000C0000h - 000CFFFFh	RAGE LT PRO AGP 2X (English)
000DC000h - 000DFFFFh	Motherboard Resources
000E0000h - 000EFFFFh	System Board Extension for PnP BIOS
00100000h - 01FFFFFFh	System Board Extension for PnP BIOS
0C000000h - 0C000FFFh	Texas Instruments PCI-1211 CardBus Controller
E0000000h - E3FFFFFFh	ALI M1541 AGP System Controller
FC000000h - FCFFFFFFh	Ali PCI to USB Open Host Controller
FC001000h - FC0010FFh	Lucent 56K V.90 PCI DF Modem
FC100000h - FDFFFFFFh	PCI Standard PCI-to-PCI bridge
FC100000h - FC100FFFh	RAGE LT PRO AGP 2X (English)
FC120000h - FC13FFFFh	RAGE LT PRO AGP 2X (English)
FD000000h - FDFFFFFFh	RAGE LT PRO AGP 2X (English)
FFFC0000h - FFFFFFFFh	Motherboard Resources

Display

12.1" (Diagonal) TFT Display with LVDS		
	U.S.	Metric
Dimensions		
Height	7.83"	19.9 cm
Width	10.8"	25.7 cm
Diagonal Size	12.1"	30.7 cm
Mounting	Internal	
Number of Colors	16 M	
Contrast Ratio	Typical 150:1	
Brightness	Over 120 cd/m ² -3	
Pixel Resolution		
Pitch	0.30 x 0.30 mm	
Format	800 x 600	
Configuration	RGB Stripe	
Backlight	Edge Light	
Character Display	80 x 25, 80 x 50	
Total Power Consumption	5.4 W (max)	

(Information not available)

13.3" (Diagonal) TFT Display with LVDS		
	U.S.	Metric
Dimensions		
Height		
Width		
Diagonal Size		
Mounting		
Number of Colors		
Contrast Ratio		
Brightness		
Pixel Resolution		
Pitch		
Format		
Configuration		
Backlight		
Character Display		
Total Power Consumption		

14.1" (Diagonal) TFT Display with LVDS		
	U.S.	Metric
Dimensions		
Height	8.43"	21.42 cm
Width	11.2"	28.56 cm
Diagonal Size	14.1"	35.8 cm
Mounting	Internal	
Number of Colors	64 K	
Contrast Ratio	Typical 150:1	
Brightness	Over 120 cd/m ² -3	
Pixel Resolution		
Pitch	0.279 x 0.279 mm	
Format	1024 x 768	
Configuration	RGB Stripe	
Backlight	Edge Light	
Character Display	80 x 25	
Total Power Consumption	6.6 W (max)	

Memory Expansion

Base System Memory	Expansion Board Memory	Total Memory
32-MB	32-MB	64-MB
32-MB	64-MB	96-MB
32-MB	128-MB	160-MB
64-MB	32-MB	96-MB
64-MB	64-MB	128-MB
64-MB	128-MB	192-MB

Diskette Drive

Diskette Drive	
Diskette Size	3.5 in
Light Height	None .5" / 1.27 cm
Bytes per Sector:	512
Sectors per Track	18 (1.44-MB) / 15 (1.2-MB)
High Density	9
Low Density	
Tracks per Side	80 (1.44-MB) / 80 (1.2-MB)
High Density	80
Low Density	
Access Times	
Track-to-Track (high/low)	3 ms/6 ms
Average (ms)	94 ms/174 ms
Setting Time (ms)	15 ms
Latency Average	100
Number of Read/Write Heads	2

Hard Drive

Hard Drives		
	6.4-GB	4.8-GB
		Not Available
Capacity Per Drive	6.4-GB	4.8-GB
Drive Type	65	65
Physical Configuration		
Cylinders	8647	8647
Heads	6	6
Sectors per track	240-250	240-250
Bytes per sector	512	512
Logical Configuration		
Cylinders	13424	7944
Heads	15	15
Sectors per track	63	63
Bytes per sector	512	512
Seek Times		
(Typical, including settling in ms)	2.5 ms	2.5 ms
Track to Track	13 ms	13 ms (read)
Average Maximum	23 ms	23 ms
Rotational Speed	4200 rpm	4200 rpm
Transfer Rate		
Media	60.8 to 107.2 Mb/s	60.8 to 107.2 Mb/s
At Interface	33.3 Mb/s	33.3 Mb/s
Sector Interleave	1:1	1:1
Buffer Size	512 KB	512 KB

DVD or CD Drive

CD Drive	
	24x CD Drive
Applicable Disk	CD-DA, CD-ROM, CD-ROM XA, CD-I, Photo CD (multisession), Video CD, CD-R, CD-Extra (CD+), CD-G, CD-RW
Center Hole Diameter	.6" / 15 mm
Disc Diameter	12 cm, 8 cm
Disc Thickness	1.2 mm
Track Pitch	1.6 um
Access Time	
(typical, including setting)	110 ms
Audio Output Level	
Line out	+/- 0.27 Vrms
Headphone	none
Cache Buffer	128 KB
Data Transfer Rate	
(typical, including setting)	3600 KB/s 150 KB/s 16.66 MB/sec
Startup Time	< 8 sec
Stop time	< 4 sec

DVD Drive	
Applicable Disk	DVD-ROM, CD-ROM, CD-XA, CD-I, Photo CD, Multisession, Audio, CD-R, CD-RW
Center Hole Diameter	6" / 15mm
Access Time	
(typical, including setting)	< 100 ms (CD) < 150 ms (DVD)
Disc Thickness	4.7", 3.15" / 12cm, 8cm
Track Pitch	0.74um (DVD)
Laser	
Beam Divergence	.05° / 1.2cm
Audio Output Level	
Line out	1.0 volts RMS
Headphone	0 - 0.6 volts RMS
Cache Buffer	512 KB/s (CD)
Data Transfer Rate	
(typical, including setting)	12,000 - 3,000 KB/s (CD) 2705 KB/s (DVD)
Startup Time	< 5 sec
Stop time	< 3 sec

Battery Pack

Battery Pack		
	Lithium Ion (Li ion) *	
	US	Metric
Dimensions		
Height	.81 in	2.05 cm
Length	3.05 in	7.75 cm
Width	5.69 in	14.45 cm
Weight	0.85 lb	.39 kg
Battery Pack Operating Time	2 to 3 hours	
Energy		
Voltage	14.8 V	
Amp-hour capacity	3.0 Ah	
Watt-hour capacity	44.4 Wh	
Environmental Requirements		
Operating Temperature	32° F to 113 F	0° to 45° C
Non-operating Temperature	-4° F to 140 ° F	-20° to 60° C

Modem	
Compliance	ITU v.90-6 standard Full ITU-T V.34 compliance
	Full compliance with: V.21, V.22, V.22bis, V.23, V.32, V.32bis, Bell 103, Bell 212A
Data Compression	V.42bis/MNP 5
Fax Modulation	V.17 V.21 (Group III Compatible) V.29 V.27Ter
Command Set	Hayes AT Class 1 Fax
Cable	6 Ft. RJ-11 telephone cable

Top of Page

maintenance & service guide

Presario 1600 Series

Models: 1683, 1685, 1687, 1688, 1690, 1692, 1693, and 1694

Before You Begin	Specifications	Parts Catalog
Removal Sequence	Troubleshooting	Battery Operations
Product Description	Pin Assignments	Index

Parts Catalog

[System Unit](#)

[System Boards](#)

[Display
Assembly](#)

[Mass Storage
Devices](#)

[Miscellaneous
Cable Kit](#)

[Miscellaneous
Hardware Kit](#)

[Miscellaneous
Plastics Kit](#)

[Miscellaneous
Parts](#)

[Documentation
and Software](#)

For the Compaq Presario 1600 Series of Portable Computers listed above, this section of the Maintenance and Service Guide provides the following information:

- An illustrated breakdown of components
- Identification of spare parts and the ordering number associated with each item(s)

Click on the appropriate categories listed to the left.

maintenance & service guide

Presario 1600 Series

Models: 1683, 1685, 1687, 1688, 1690, 1692, 1693, and 1694

Before You Begin	Specifications	Parts Catalog
Removal Sequence	Troubleshooting	Battery Operations
Product Description	Pin Assignments	Index

Removal and Replacement

Introduction

Removal Sequence

[Cables and Connectors](#)

[Battery Pack](#)

[Palmrest Cover with Touch Pad](#)

[Heatspreader](#)

[Keyboard](#)

[Processor](#)

[Hard Drive](#)

[DVD or CD Drive](#)

[Battery Charger Board](#)

[Modem](#)

[Display Panel Assembly](#)

[Upper CPU Cover](#)

[Network Interface Card](#)

[Speaker Assembly](#)

[Diskette Drive](#)

[Fan Assembly](#)

[System Board](#)

[Dip Switch Settings](#)

[Memory Module](#)

IMPORTANT: Prior to conducting any removal and/or replacement procedures, you should review and fully understand the section titled "[Before You Begin](#)".

Note:

The Internal Ethernet Card is **Not Available** for computer models: 1683, 1685, 1687, 1688, 1690, 1692, 1693, and 1694. The Ethernet Plug was removed on later models.

maintenance & service guide

Presario 1600 Series

Models: 1683, 1685, 1687, 1688, 1690, 1692, 1693, and 1694

Before You Begin	Specifications	Parts Catalog
Removal Sequence	Troubleshooting	Battery Operations
Product Description	Pin Assignments	Index

[Preliminary Steps](#)

[Clearing the Power-On Password](#)

[Power-On Self Test \(POST\)](#)

[Compaq Diagnostics](#)

[Diagnostic Error Codes](#)

[Solving Minor Problems](#)

[Contacting Compaq Support](#)

Introduction

This section covers troubleshooting information for the above listed Compaq Presario 1600 Series Portable Computers. The basic steps in troubleshooting include:

1. Follow the Preliminary Steps.
2. Run the Power-On Self-Test (POST).
3. Follow the recommended actions described in the diagnostic tables, if you are unable to run POST or if POST displays an error message.

When following the recommended actions in the Sections on POST and Diagnostic Error Codes perform them in the order listed. Rerun POST after each recommended action until the problem is solved and no error message occurs. Once the problem is solved, do not complete the remaining recommended actions.

NOTE:

If the problem is intermittent, check the computer several times to verify that the problem is solved

maintenance & service guide

Presario 1600 Series

Models: 1683, 1685, 1687, 1688, 1690, 1692, 1693, and 1694

Before You Begin	Specifications	Parts Catalog
Removal Sequence	Troubleshooting	Battery Operations
Product Description	Pin Assignments	Index

Battery Pack Operating Time

This appendix covers the following information concerning battery pack operating time:

- Increase battery pack operating time
- Conditioning a battery pack
- Disposal of a used battery pack

Increasing Battery Pack Operating Time

Battery pack operating time differs depending on several variables. To avoid unnecessary replacement, consider the following variables when determining how long a charged battery pack should last:

- Power management settings
- Hardware configuration
- Software applications
- Installed options
- Display brightness
- Hard drive usage
- Changes in operating temperature
- Type and number of installed PC Cards

NOTE: The power consumption requirements for PC Cards vary widely. Some cards drain the battery pack very rapidly.

Minimizing the Energy Required

Battery pack operating time can be increased by as much as 50 percent by controlling the energy required by the computer and the energy stored in the battery pack.

To minimize the energy required by the computer, follow these steps:

- Set the power conservation levels in the Power Management utility to **Maximum**.
- Customize the timeout value to work more efficiently with the applications. The amount of battery life depends on the values selected.

Maximizing the Energy Stored

To maximize the energy stored in the battery pack, follow these guidelines:

- Condition the battery pack at least every 30 days to improve overall battery performance.
- Keep a battery pack in the computer when using it with AC power to supply the battery pack with a constant trickle charge.
- Store the battery pack in a cool, dry place when not in use.

Conditioning a Battery Pack



CAUTION: To avoid a loss of data, ensure that all data is saved before discharging a battery pack.

To condition a battery pack, complete the following steps:

1. Plug in the AC adapter and allow the battery to charge until the LED light on the display stops blinking. Your battery gauge may read 100 percent for a period of time before LED light on the display stops blinking. Do not unplug the AC adapter until the arrow disappears.
2. Unplug the AC adapter and allow the battery to drain until the computer reaches hibernation and turns itself off. **Do not plug in the AC adapter during this process or you will need to restart with Step No. 1.** You may use the computer while the battery is draining.
3. Your battery is re-conditioned.
4. Plug in the AC adapter and begin using the computer.

The table below shows the approximate battery pack charge times.

Approximate Battery Charge Time		
Computer	On Line	Off Line
NiMH Battery Pack	4.0 hours premature termination	2:00 hrs
Li ion Battery Pack	4.5 hours premature termination	2:50 hrs

Disposal of a Used Battery Pack

In the interest of safeguarding our environment, Compaq Computer Corporation recommends that nickel metal hydride (NiMH) and lithium ion (Li ion) battery packs be recycled. Battery packs should be handled in accordance with country, state, province, or local regulations.



CAUTION: Never attempt to open or service a battery pack. Opening a battery pack not only damages the pack and makes it unusable, but also expose potentially harmful battery components.

maintenance & service guide

Presario 1600 Series

Models: 1683, 1685, 1687, 1688, 1690, 1692, 1693, and 1694

Before You Begin	Specifications	Parts Catalog
Removal Sequence	Troubleshooting	Battery Operations
Product Description	Pin Assignments	Index

Product Description

[Models and Features](#)

[Controls and Lights](#)

[Front Bezel Lights](#)

[Front Bezel Buttons](#)

[Left Side Components](#)

[Right Side Components](#)

[Underside of Unit](#)

[Rear Connectors](#)

[Power Management for Windows 98](#)



The Compaq Presario 1600 Series Computers, the new generation of multimedia portables, present an innovative and integrated design, outstanding audio and video, advanced core features, and attractive styles. This fully functional AMD-K6-based portable computer allows full desktop versatility.

maintenance & service guide

Presario 1600 Series

Models: 1683, 1685, 1687, 1688, 1690, 1692, 1693, and 1694

Before You Begin	Specifications	Parts Catalog
Removal Sequence	Troubleshooting	Battery Operations
Product Description	Pin Assignments	Index

Connector Pin Assignments

This appendix provides connector pin assignment tables for Compaq Presario Series Portable Computers. For more information on connectors, refer to the section on [Blue Connectors](#).

NOTE: The signals in all tables of this appendix are considered "active high" unless otherwise indicated by an asterisk (*).

- [Parallel Connector](#)
- [Serial Connector](#)
- [Keyboard/Mouse](#)
- [External VGA Monitor](#)
- [Universal Serial Bus](#)
- [Modem](#)

Parallel Connector			
			
Pin	Signal	Pin	Signal
1	Strobe*	10	Acknowledge*
2	Data Bit 0	11	Busy
3	Data Bit 1	12	Paper Out
4	Data Bit 2	13	Select
5	Data Bit 3	14	Auto Linefeed*
6	Data Bit 4	15	Error*
7	Data Bit 5	16	Initialize Printer*
8	Data Bit 6	17	Select In*
9	Data Bit 7	18-25	Signal Ground
* = Active low			

Serial Connector		
Connector	Pin	Signal
	1	Carrier Detect
	2	Receive Data
	3	Transmit Data
	4	Data Terminal Ready
	5	Signal Ground
	6	Data Set Ready
	7	Ready to Send
	8	Clear to Send
	9	Ring Indicator

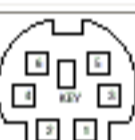
Keyboard/Mouse		
Connector	Pin	Signal
	1	Data 1
	2	Data 2
	3	Ground
	4	+ 5 V
	5	Clock 1
	6	Clock 2

External VGA Monitor		
Connector	Pin	Signal
	1	Red Analog
	2	Green Analog
	3	Blue Analog
	4	Not connected
	5	Ground
	6	Ground Analog
	7	Ground Analog
	8	Ground Analog
	9	Not connected
	10	Ground
	11	Monitor Detect
	12	DDC2B Data
	13	Horizontal Sync
	14	Vertical Sync
	15	DDC2B Clock

Universal Serial Bus		
Connector	Pin	Signal
	1	+5V
	2	Data -
	3	Data +
	4	Ground

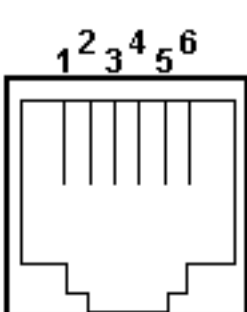
Modem		
Connector	Pin	Signal
	1	Unused
	2	Unused
	3	Tip
	4	Ring
	5	Unused
	6	Unused

maintenance & service guide

Presario 1600 Series

Models: 1683, 1685, 1687, 1688, 1690, 1692, 1693, and 1694

Before You Begin	Specifications	Parts Catalog
Removal Sequence	Troubleshooting	Battery Operations
Product Description	Pin Assignments	Index

Before You Begin

[Electrostatic
Discharge](#)

[Service
Considerations](#)

[Preparation
for
Disassembly](#)

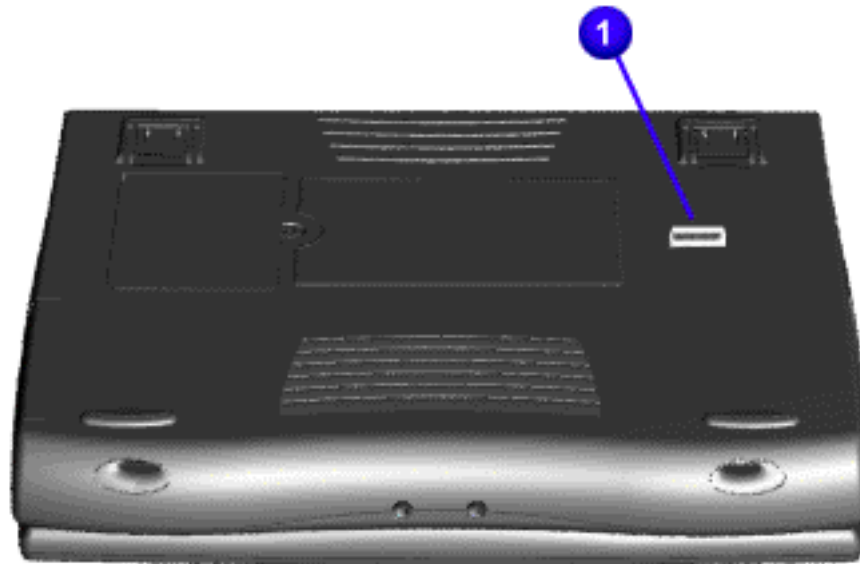

Report the computer serial number **1** to Compaq when requesting information or ordering spare parts.

maintenance & service guide

Presario 1600 Series

Models: 1683, 1685, 1687, 1688, 1690, 1692, 1693, and 1694

Before You Begin	Specifications	Parts Catalog
Removal Sequence	Troubleshooting	Battery Operations
Product Description	Pin Assignments	Index

Before You Begin

Electrostatic Discharge

Service Considerations

Preparation for Disassembly

Electrostatic Discharge

A sudden discharge of static electricity from a finger or other conductor can destroy static-sensitive devices or microcircuitry. Often the spark is neither felt nor heard, but damage occurs. An electronic device exposed to electrostatic discharge (ESD) may not be affected at all and will work perfectly throughout a normal cycle. Although, it may function normally for a while, then degrade in the internal layers, reducing its life expectancy.

Networks built into many integrated circuits provide some protection, but in many cases, the discharge contains enough power to alter device parameters or melt silicon junctions.

Generating Static

The table shows how different activities generate static electricity and at different electrostatic voltage levels.

Typical Electrostatic Voltages			
	Relative Humidity		
Event	10%	40%	55%
Walking across carpet	35,000 V	15,000 V	7,500 V
Walking across vinyl floor	12,000 V	5,000 V	3,000 V
Motions of bench worker	6,000 V	800 V	400 V
Removing DIPS from plastic tubes	2,000 V	700 V	400 V
Removing DIPS from vinyl trays	11,500 V	4,000 V	2,000 V
Removing DIPS from Styrofoam	14,500 V	5,000 V	3,500 V
Removing bubble pack from PCBs	26,000 V	20,000 V	7,000 V
Packing PCBs in foam-lined box	21,000 V	11,000 V	5,000 V
NOTE: 700 volts can degrade a product.			

maintenance & service guide

Presario 1600 Series

Models: 1683, 1685, 1687, 1688, 1690, 1692, 1693, and 1694

Before You Begin	Specifications	Parts Catalog
Removal Sequence	Troubleshooting	Battery Operations
Product Description	Pin Assignments	Index

Before You Begin

[Electrostatic
Discharge](#)

[Service
Considerations](#)

[Preparation
for
Disassembly](#)

Service Considerations

Listed below are some of the considerations that you should keep in mind during the disassembly and assembly of the computer.

Tool and Software Requirements

To service the computer, you need the following:

- Compaq screwdriver kit (Spare Part No. 161946-001)
- Torx T-9 screwdriver
- 3/16-inch and 5mm nut drivers (for screwlocks and standoffs)
- Small, standard screwdriver
- Small, Phillips screwdriver
- Diagnostics software

Screws

The screws used in the computer are not interchangeable. If an incorrect screw is used during the reassembly process, it can damage the unit. Compaq strongly recommends that all screws removed during disassembly be kept with the part that was removed, then returned to their proper locations.

IMPORTANT:

As each subassembly is removed from the computer, it should be placed away from the work area to prevent damage.

maintenance & service guide

Presario 1600 Series

Models: 1683, 1685, 1687, 1688, 1690, 1692, 1693, and 1694

Before You Begin	Specifications	Parts Catalog
Removal Sequence	Troubleshooting	Battery Operations
Product Description	Pin Assignments	Index

Before You Begin

Electrostatic Discharge

Service Considerations

Preparation for Disassembly

Preparing the Computer for Disassembly

1. Disconnect AC power and any external devices.
2. Remove the battery pack.
3. Remove any PC Cards.

IMPORTANT:

The battery pack should be removed before performing any internal maintenance on the computer.



WARNING: Metal objects can damage the battery pack as well as the battery contacts in the battery compartment. To prevent damage, do not allow metal objects to touch the battery contacts. Place only the battery pack for the Compaq Presario Series Portable Computers into the battery compartment. Do not force the battery pack into the bay if insertion does not occur easily.



CAUTION: Do not crush, puncture, or incinerate the battery pack. Do not open a battery pack, as this damages the pack, makes it unusable, and exposes potentially harmful battery components. There are no field-serviceable parts located inside the battery pack.

NOTE:

The Compaq Presario Series Portable Computers have several screws of various sizes which are **not** interchangeable. Care must be taken during reassembly to ensure that the correct screws are used in their correct location. During removal please keep respective screws with their associated sub-assembly.

maintenance & service guide

Presario 1600 Series

Models: 1683, 1685, 1687, 1688, 1690, 1692, 1693, and 1694

Before You Begin	Specifications	Parts Catalog
Removal Sequence	Troubleshooting	Battery Operations
Product Description	Pin Assignments	Index

Parts Catalog

System Unit

System Unit

[System Boards](#)

[Display Assembly](#)

[Mass Storage Devices](#)

[Miscellaneous Cable Kit](#)

[Miscellaneous Hardware Kit](#)

[Miscellaneous Plastics Kit](#)

[Miscellaneous Parts](#)

[Documentation and Software](#)

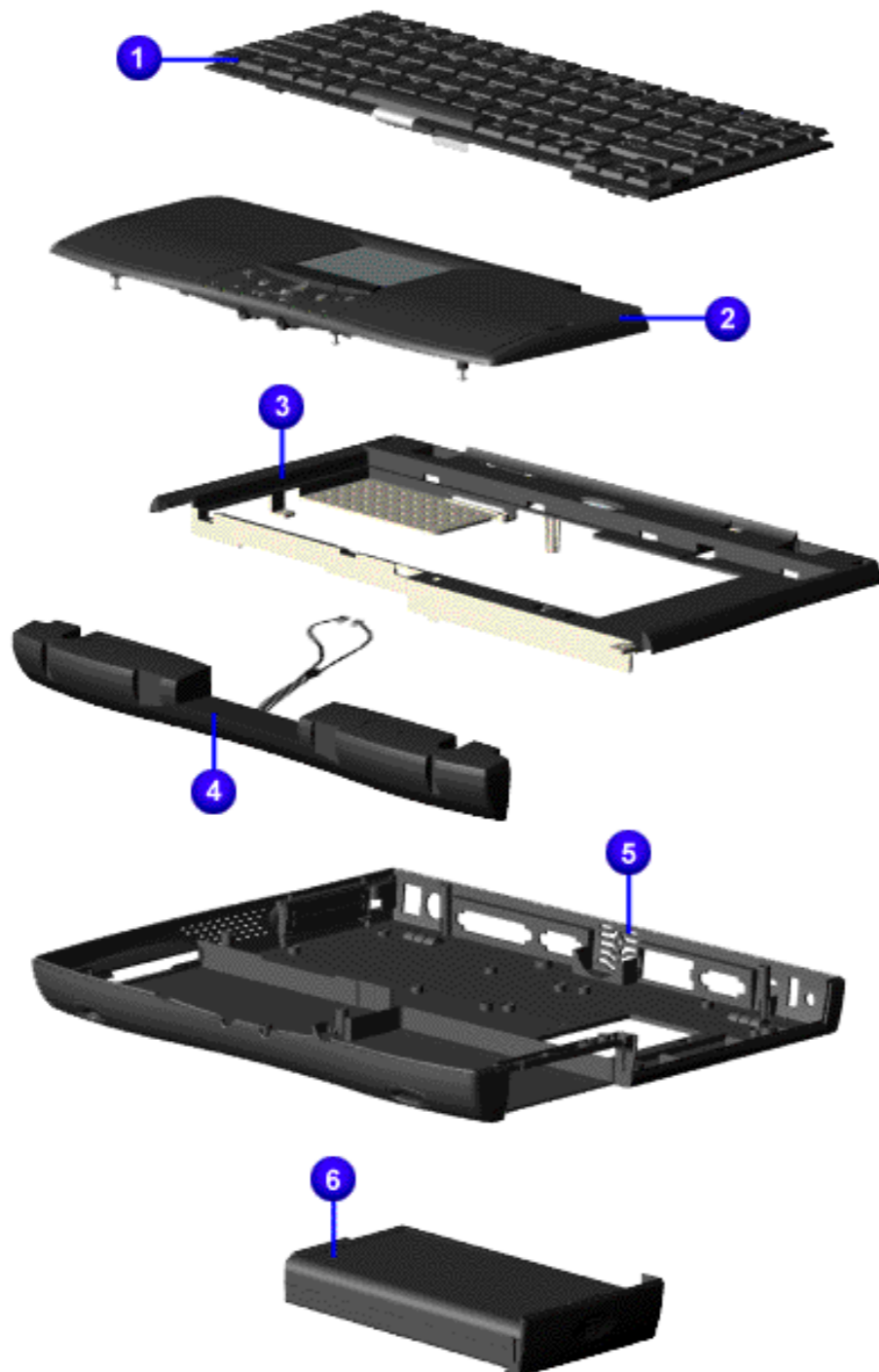

Part Description	Spare Part Number
1. Keyboard	
2. Palmrest Cover w/TouchPad and Button Board (Models: 1687, 1688, 1690, 1693, 1694)	142654-001
2. Palmrest Cover w/TouchPad and Button Board (Models: 1683, 1685, 1688, 1692)	142653-001
3. Upper CPU Cover w/Power Switch	141846-001
4. Speaker Assembly w/Cables	148108-001
5. Base Enclosure	141845-001
6. Battery Pack L ion Enhancement (Models: 1683, 1685, 1687, 1688, 1690)	388647-001
6. Battery Pack L ion Enhancement (Models: 1692, 1693, 1694)	138-184-001
1600 Series CTO Description	Spare Part Number
1. Keyboard	EAB
2. Palmrest Cover w/TouchPad and Button Board	142654-001
3. Battery	sLiON
4. Port Replicator	400384-001

maintenance & service guide

Presario 1600 Series

Models: 1683, 1685, 1687, 1688, 1690, 1692, 1693, and 1694

Before You Begin	Specifications	Parts Catalog
Removal Sequence	Troubleshooting	Battery Operations
Product Description	Pin Assignments	Index

Parts Catalog

[System Unit](#)

[System Boards](#)

[Display Assembly](#)

[Mass Storage Devices](#)

[Miscellaneous Cable Kit](#)

[Miscellaneous Hardware Kit](#)

[Miscellaneous Plastics Kit](#)

[Miscellaneous Parts](#)

[Documentation and Software](#)

System Boards

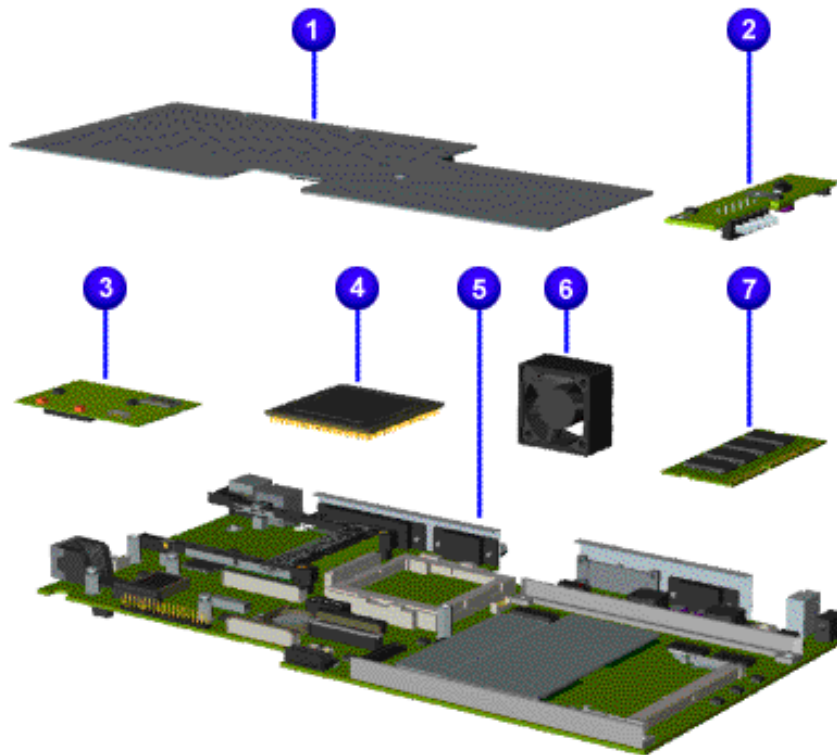

Description	Spare Part Number
1. Heatspreader	122702-001
2. Voltage Converter Board	352891-001
3. Modem 56K Data/Fax w/o SRAM	400445-001
3. Modem 56K Data/Fax w/o SRAM-Intl	143848-001
4. Processor AMD K6	
5. System Board w/512K Cache	144018-001 (models 1683-1690) 158848-001 (models 1692-1694)
6. Fan Assembly	400444-001
7. System Memory	

maintenance & service guide

Presario 1600 Series

Models: 1683, 1685, 1687, 1688, 1690, 1692, 1693, and 1694

Before You Begin	Specifications	Parts Catalog
Removal Sequence	Troubleshooting	Battery Operations
Product Description	Pin Assignments	Index

Parts Catalog

[System Unit](#)

[System Boards](#)

[Display
Assembly](#)

[Mass Storage
Devices](#)

[Miscellaneous
Cable Kit](#)

[Miscellaneous
Hardware Kit](#)

[Miscellaneous
Plastics Kit](#)

[Miscellaneous
Parts](#)

[Documentation
and Software](#)

Display Assembly



Description	Spare Part Number
1. Display 12.1 TFT (Models: 1683, 1685, 1687, 1692)	142304-001
2. Display 13.3 TFT w/LVDS (Model: 1688)	142305-001
3. Display 14.1 TFT w/LVDS (Model: 1690, 1693, 1694)	142306-001

maintenance & service guide

Presario 1600 Series

Models: 1683, 1685, 1687, 1688, 1690, 1692, 1693, and 1694

Before You Begin	Specifications	Parts Catalog
Removal Sequence	Troubleshooting	Battery Operations
Product Description	Pin Assignments	Index

Parts Catalog

[System Unit](#)

[System Boards](#)

[Display
Assembly](#)

**[Mass Storage
Devices](#)**

[Miscellaneous
Cable Kit](#)

[Miscellaneous
Hardware Kit](#)

[Miscellaneous
Plastics Kit](#)

[Miscellaneous
Parts](#)

[Documentation
and Software](#)

Mass Storage Devices

Use the scroll down menu for the description and spare part number.

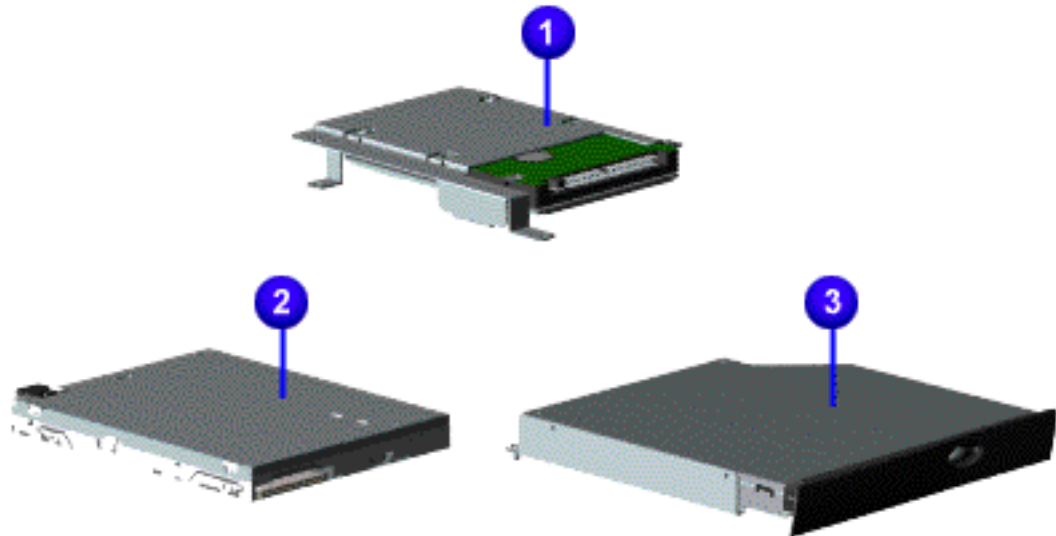

maintenance & service guide

Presario 1600 Series

Models: 1683, 1685, 1687, 1688, 1690, 1692, 1693, and 1694

Before You Begin	Specifications	Parts Catalog
Removal Sequence	Troubleshooting	Battery Operations
Product Description	Pin Assignments	Index

Parts Catalog

[System Unit](#)

[System Boards](#)

[Display
Assembly](#)

[Mass Storage
Devices](#)

**[Miscellaneous
Cable Kit](#)**

[Miscellaneous
Hardware Kit](#)

[Miscellaneous
Plastics Kit](#)

[Miscellaneous
Parts](#)

[Documentation
and Software](#)

Miscellaneous Cable Kit

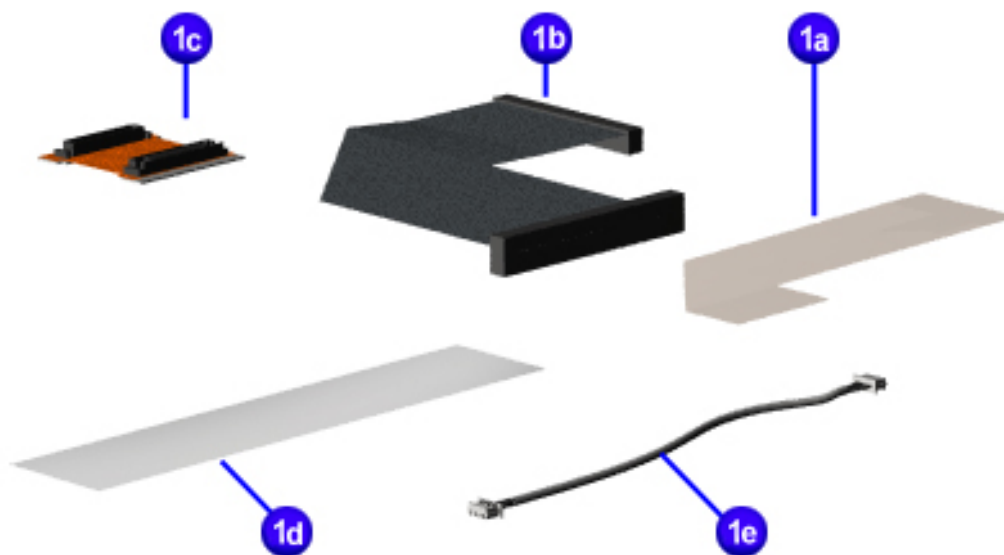

**Miscellaneous
Cable Kit
Spare Part
Number:
330946-001**

1a.	1
Diskette	each
Drive Cable	
1b.	1
Hard Drive Cable	each
1c.	1
CD or DVD Drive Cable	each
1d.	1
Touchpad Cable	each
1e.	1
Modem Cable	each

maintenance & service guide

Presario 1600 Series

Models: 1683, 1685, 1687, 1688, 1690, 1692, 1693, and 1694

Before You Begin	Specifications	Parts Catalog
Removal Sequence	Troubleshooting	Battery Operations
Product Description	Pin Assignments	Index

Parts Catalog

[System Unit](#)

[System Boards](#)

[Display
Assembly](#)

[Mass Storage
Devices](#)

[Miscellaneous
Cable Kit](#)

**Miscellaneous
Hardware Kit**

[Miscellaneous
Plastics Kit](#)

[Miscellaneous
Parts](#)

[Documentation
and Software](#)

Miscellaneous Hardware Kit

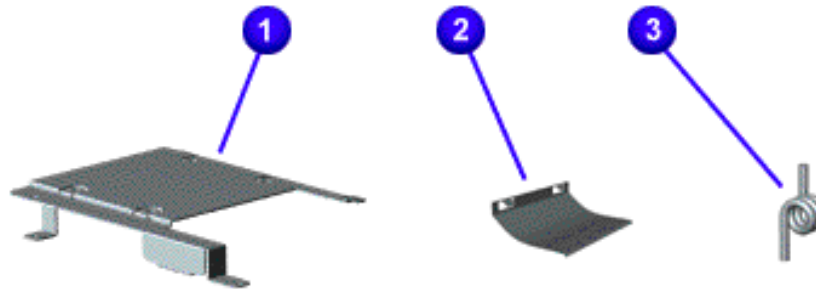

**Miscellaneous
Hardware Kit**
Spare Part Number:
346853-001

Description	Quantity
1. Hard Drive Mounting Bracket	1 each
2. LCD Guide FPC	1 each
3. Spring Torsion PCMCIA	4 each

maintenance & service guide

Presario 1600 Series

Models: 1683, 1685, 1687, 1688, 1690, 1692, 1693, and 1694

Before You Begin	Specifications	Parts Catalog
Removal Sequence	Troubleshooting	Battery Operations
Product Description	Pin Assignments	Index

Parts Catalog

[System Unit](#)

[System Boards](#)

[Display
Assembly](#)

[Mass Storage
Devices](#)

[Miscellaneous
Cable Kit](#)

[Miscellaneous
Hardware Kit](#)

**[Miscellaneous
Plastics Kit](#)**

[Miscellaneous
Parts](#)

[Documentation
and Software](#)

Miscellaneous Plastics Kit

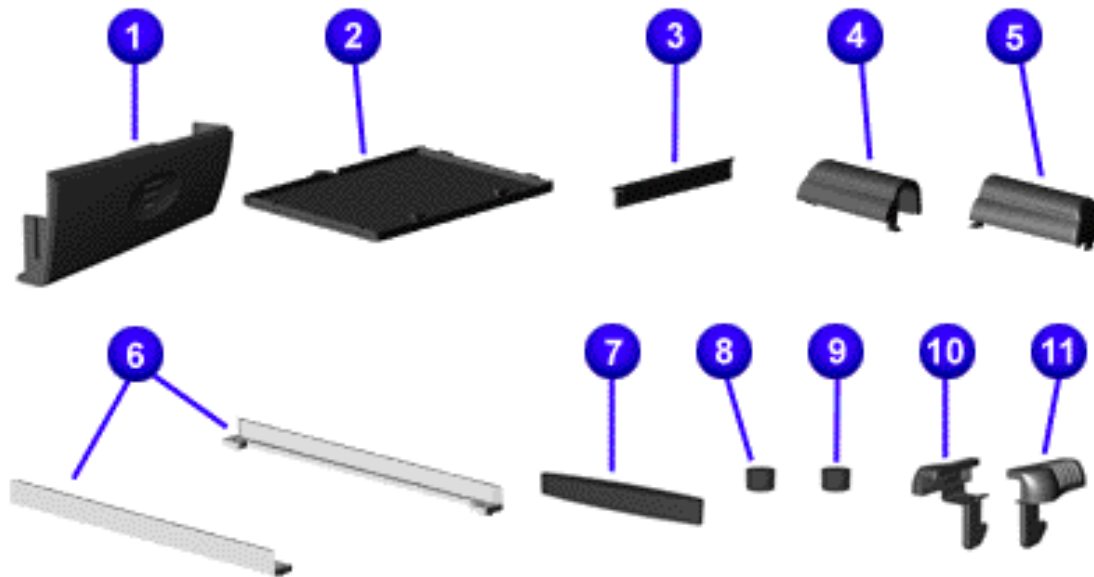

Miscellaneous Plastics Kit Spare Part Number: 142657-001

Description	Quantity
1. Door, Battery Pack	1 each
2. Cover, Memory Module	1 each
3. Door, PCMCIA	1 each
4. Display Hinge Cover, (Left)	1 each
5. Display Hinge Cover, (Right)	1 each
6. CD Drive Guide	1 each
7. Rubber Plug (A)	4 each
8. Rubber Plug (B)	4 each
9. Rubber Foot	8 each
10. Latch (Right)	2 each
11. Latch (Left)	2 each

maintenance & service guide

Presario 1600 Series

Models: 1683, 1685, 1687, 1688, 1690, 1692, 1693, and 1694

Before You Begin	Specifications	Parts Catalog
Removal Sequence	Troubleshooting	Battery Operations
Product Description	Pin Assignments	Index

Parts Catalog

[System Unit](#)

[System Boards](#)

[Display
Assembly](#)

[Mass Storage
Devices](#)

[Miscellaneous
Cable Kit](#)

[Miscellaneous
Hardware Kit](#)

[Miscellaneous
Plastics Kit](#)

**[Miscellaneous
Parts](#)**

[Documentation
and Software](#)

Miscellaneous Parts

- | | |
|--------------------|------------|
| 2. Port Replicator | 102270-001 |
| 3. Return Kit | 293799-001 |
| 4. Logo Kit | 141848-001 |

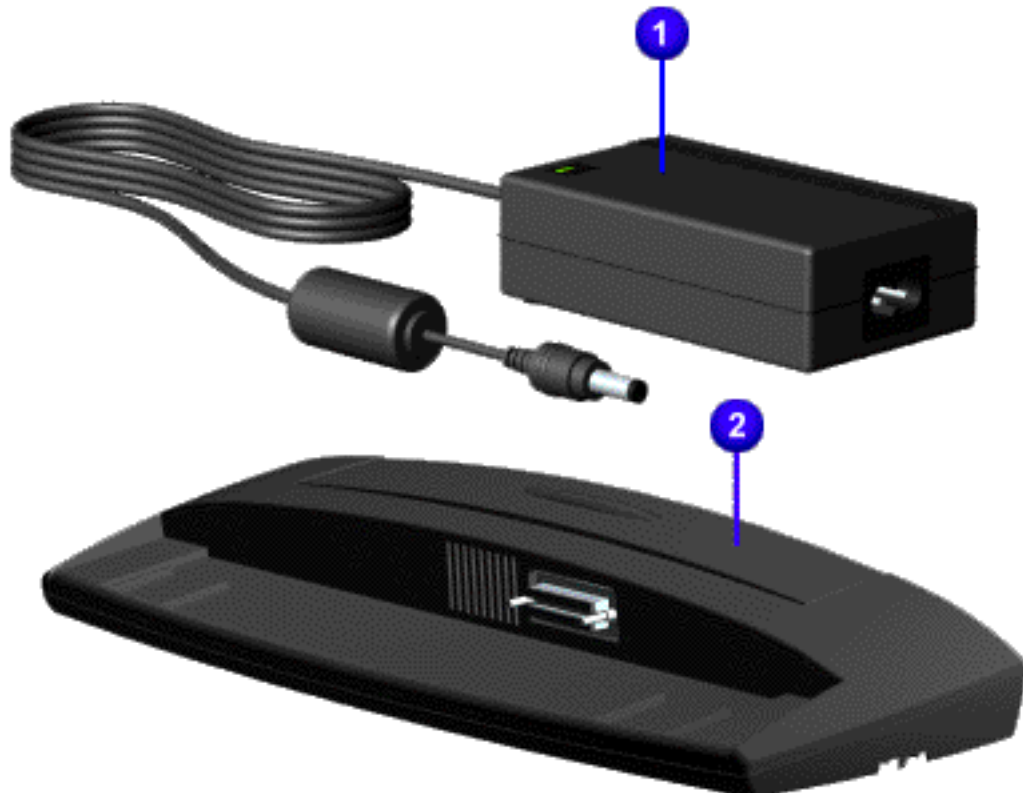

maintenance & service guide

Presario 1600 Series

Models: 1683, 1685, 1687, 1688, 1690, 1692, 1693, and 1694

Before You Begin	Specifications	Parts Catalog
Removal Sequence	Troubleshooting	Battery Operations
Product Description	Pin Assignments	Index

Parts Catalog

[System Unit](#)[System Boards](#)[Display
Assembly](#)[Mass Storage
Devices](#)[Miscellaneous
Cable Kit](#)[Miscellaneous
Hardware Kit](#)[Miscellaneous
Plastics Kit](#)[Miscellaneous
Parts](#)[Documentation
and Software](#)

Documentation and Software

Description	Spare Part Number		
Quick Restore CD [FrontPage Save Results Component]			
Reference Guide	Info. Not Available		
QuickFind for Windows, North America, Latin America, Asia Pacific	Info. Not Available		
QuickFind for Windows, Europe, Middle East, Africa	Info. Not Available		
* QuickFind is updated monthly. To complete the QuickFind part number, add the suffix from the table below for the desired month. If you do not specify the 3-digit suffix, the default is the current month in which the order is placed.			
QuickFind Part Number Suffix			
Suffix	Month	Suffix	Month
-001	January	-007	July
-002	February	-008	August
-003	March	-009	September
-004	April	-010	October
-005	May	-011	November
-006	June	-012	December

maintenance & service guide

Presario 1600 Series

Models: 1683, 1685, 1687, 1688, 1690, 1692, 1693, and 1694

Before You Begin	Specifications	Parts Catalog
Removal Sequence	Troubleshooting	Battery Operations
Product Description	Pin Assignments	Index

Removal and Replacement

IMPORTANT:

Prior to conducting any removal and/or replacement procedures, you should review and fully understand the section titled "[Before You Begin](#)".

[Cables and Connectors \(main page\)](#)

Most cables used throughout the unit are ribbon cables. Cables must be handled with extreme care to avoid damage. Apply only the tension required to seat or unseat the cables during insertion or removal from the connector. Handle cables by the connector whenever possible. In all cases, avoid bending, twisting, or tearing the cables, and ensure that the cables are routed in such a way that they cannot be caught or snagged by parts being removed or replaced.

[Cables](#)

NOTE:

In order to gain access to the cables, you must first remove the Battery Pack and the Palmrest Cover with Touch Pad. Those steps are covered in the Removal Sequence listed to the left.

Use the following precautions when handling cables to avoid damage to the cable or computer:

- Always handle cables by their connectors.
- Avoid bending, twisting, or pulling on the cables.
- Apply minimum required force when seating or unseating the cables from their connectors.
- Place the cables in such a manner that they cannot be caught or snagged by parts being removed or replaced.
- Handle flex cables with extreme care, they can tear easily.



CAUTION: When servicing these computers, ensure that cables are placed in their proper location during the reassembly process. Improper cable placement can cause severe damage to the unit.

[Select the Desired Illustration](#)

- Removing a Cable from a [ZIF Connector](#).
- The ribbon cable position for the [4.3-GB and 6.4-GB hard drive](#).
- The ribbon cable position for the [CD or DVD drive](#).
- The ribbon cable position for the [diskette drive](#).
- The cable position for the [speaker assembly](#).

[Plastic Parts](#)

Plastic parts can be damaged by the use of excessive force during disassembly and reassembly. When handling the plastic parts, use care. Apply pressure only at the points designated in the maintenance instructions.

[Removal Sequence](#)

[Cables and Connectors](#)

[Battery Pack](#)

[Palmrest Cover with Touch Pad](#)

[Heatsreader](#)

[Keyboard](#)

[Processor](#)

[Hard Drive](#)

[DVD or CD Drive](#)

[Battery Charger Board](#)

[Modem](#)

[Display Panel Assembly](#)

[Upper CPU Cover](#)

[Speaker Assembly](#)

[Diskette Drive](#)

[Fan Assembly](#)

[System Board](#)

[Dip Switch Settings](#)

[Memory Module](#)

Compaq Presario 1600 Series

Models 1683, 1685 & 1692, 1687 & 1694, 1688, 1690 & 1693,
CTO

[Before You Begin](#)

[Specifications](#)

[Parts Catalog](#)

[Removal Sequence](#)

[Troubleshooting](#)

[Battery Operation](#)

[Product Description](#)

[Pin Assignments](#)

[Index](#)

Removal and Replacement

IMPORTANT:

Prior to conducting any removal and/or replacement procedures, you should review and fully understand the section titled "[Before You Begin](#)".

Removal Sequence

Cables and Connectors

[Battery Pack](#)

[Palmrest Cover with Touch Pad](#)

[Heatspreader](#)

[Keyboard](#)

[Processor](#)

[Hard Drive](#)

[DVD or CD Drive](#)

[Battery Charger Board](#)

[Modem](#)

[Display Panel Assembly](#)

[Upper CPU Cover](#)

[Network Interface Card](#)

[Speaker Assembly](#)

[Diskette Drive](#)

[Fan Assembly](#)

[System Board](#)

[Dip Switch Settings](#)

[Memory Module](#)

ZIF Connectors

[zif-cable.gif \(10259 bytes\)](#)

Removing a ZIF Cable

The computer uses a zero insertion force (ZIF) connector for the keyboard cable to the system board. To remove a cable from a ZIF connector, lift both corners of the ZIF connector and slide simultaneously with constant light force.



A ZIF connector and its attached cable can be easily damaged. Handle only the connector slide when removing or replacing a cable. Never pull or twist on the cable while it is connected.

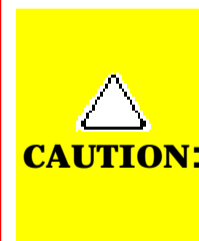

When servicing this computer, ensure that cables are placed in their proper location during the reassembly process. Improper cable placement can damage the computer.

Back to [Cables and Connectors](#) main page.

Compaq Presario 1600 Series

**Models 1683, 1685 & 1692, 1687 & 1694, 1688, 1690 & 1693,
CTO**

[Before You Begin](#)

[Specifications](#)

[Parts Catalog](#)

[Removal Sequence](#)

[Troubleshooting](#)

[Battery Operation](#)

[Product Description](#)

[Pin Assignments](#)

[Index](#)

Removal and Replacement

IMPORTANT:

Prior to conducting any removal and/or replacement procedures, you should review and fully understand the section titled "[Before You Begin](#)".

Removal Sequence

Cables and Connectors

[Battery Pack](#)

[Palmrest Cover with Touch Pad](#)

[Heatspreader](#)

[Keyboard](#)

[Processor](#)

[Hard Drive](#)

[DVD or
CD Drive](#)

[Battery Charger Board](#)

[Modem](#)

[Display Panel Assembly](#)

[Upper CPU Cover](#)

[Network Interface Card](#)

[Speaker Assembly](#)

[Diskette Drive](#)

[Fan Assembly](#)

[System Board](#)

[Dip Switch Settings](#)

[Memory Module](#)

Hard Drive Ribbon

- 1 The ribbon cable position for the 4.3-GB and 6.4-GB hard drive

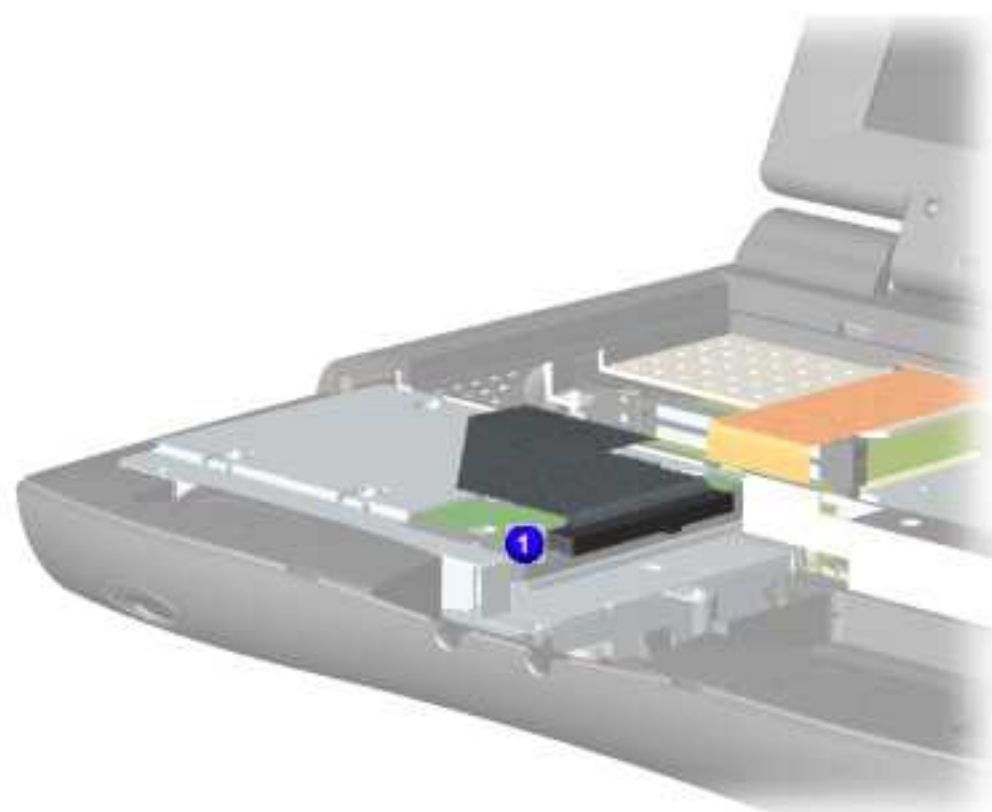

Back to [Cables and Connectors](#) main page.

Compaq Presario 1600 Series

Models 1683, 1685 & 1692, 1687 & 1694, 1688, 1690 & 1693, CTO

[Before You Begin](#)

[Specifications](#)

[Parts Catalog](#)

[Removal Sequence](#)

[Troubleshooting](#)

[Battery Operation](#)

[Product Description](#)

[Pin Assignments](#)

[Index](#)

Removal and Replacement

IMPORTANT:

Prior to conducting any removal and/or replacement procedures, you should review and fully understand the section titled "[Before You Begin](#)".

DVD or CD Drive Ribbon

- 1 The ribbon cable position for the DVD or CD drive ribbon.

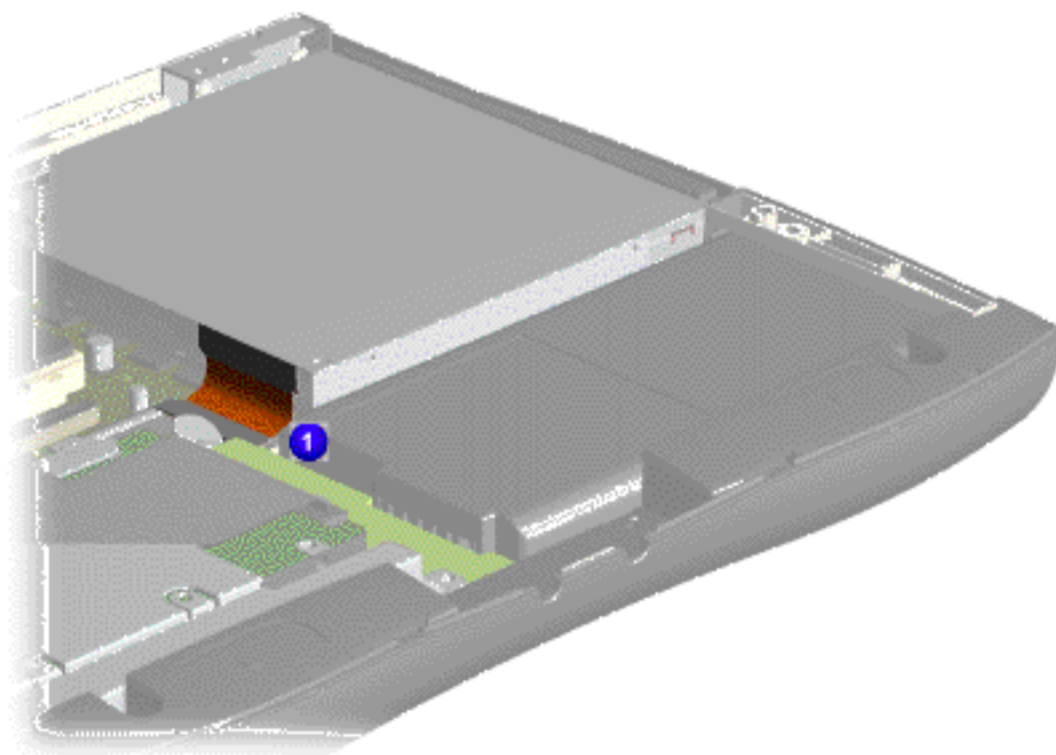

Back to [Cables and Connectors](#) main page.

Removal Sequence

Cables and Connectors

[Battery Pack](#)

[Palmrest Cover with Touch Pad](#)

[Heatspreader](#)

[Keyboard](#)

[Processor](#)

[Hard Drive](#)

[DVD or CD Drive](#)

[Battery Charger Board](#)

[Modem](#)

[Display Panel Assembly](#)

[Upper CPU Cover](#)

[Network Interface Card](#)

[Speaker Assembly](#)

[Diskette Drive](#)

[Fan Assembly](#)

[System Board](#)

[Dip Switch Settings](#)

[Memory Module](#)

Compaq Presario 1600 Series

Models 1683, 1685 & 1692, 1687 & 1694, 1688, 1690 & 1693, CTO

[Before You Begin](#)

[Specifications](#)

[Parts Catalog](#)

[Removal Sequence](#)

[Troubleshooting](#)

[Battery Operations](#)

[Product Description](#)

[Pin Assignments](#)

[Index](#)

Removal and Replacement

IMPORTANT:

Prior to conducting any removal and/or replacement procedures, you should review and fully understand the section titled "[Before You Begin](#)".

Removal Sequence

Cables and Connectors

[Battery Pack](#)

[Palmrest Cover with Touch Pad](#)

[Heatspreader](#)

[Keyboard](#)

[Processor](#)

[Hard Drive](#)

[DVD or CD Drive](#)

[Battery Charger Board](#)

[Modem](#)

[Display Panel Assembly](#)

[Upper CPU Cover](#)

[Network Interface Card](#)

[Speaker Assembly](#)

[Diskette Drive](#)

[Fan Assembly](#)

[System Board](#)

[Dip Switch Settings](#)

[Memory Module](#)

Diskette Drive Ribbon

The ribbon cable position for the diskette drive.

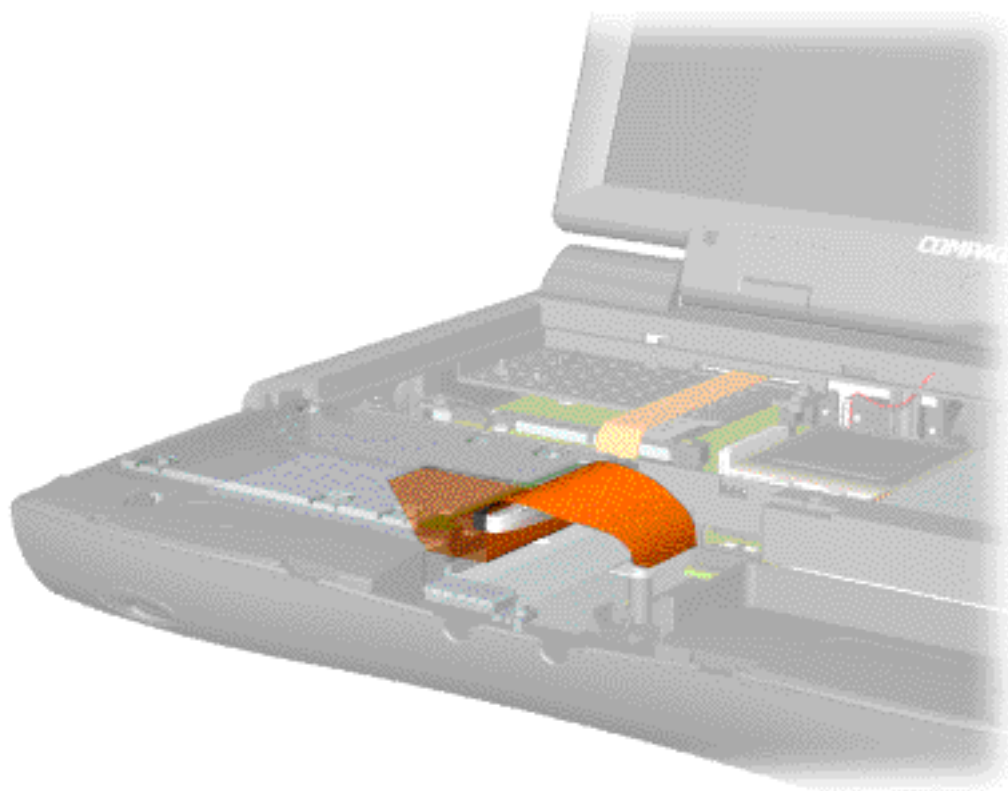

Back to [Cables and Connectors](#) main page.

Compaq Presario 1600 Series

**Models 1683, 1685 & 1692, 1687 & 1694, 1688, 1690 & 1693,
CTO**

[Before You Begin](#)

[Specifications](#)

[Parts Catalog](#)

[Removal Sequence](#)

[Troubleshooting](#)

[Battery Operation](#)

[Product Description](#)

[Pin Assignments](#)

[Index](#)

Removal and Replacement

IMPORTANT:

Prior to conducting any removal and/or replacement procedures, you should review and fully understand the section titled "[Before You Begin](#)".

Removal Sequence

Cables and Connectors

[Battery Pack](#)

[Palmrest Cover with Touch Pad](#)

[Heatspreader](#)

[Keyboard](#)

[Processor](#)

[Hard Drive](#)

[DVD or
CD Drive](#)

[Battery Charger Board](#)

[Modem](#)

[Display Panel Assembly](#)

[Upper CPU Cover](#)

[Network Interface Card](#)

[Speaker Assembly](#)

[Diskette Drive](#)

[Fan Assembly](#)

[System Board](#)

[Dip Switch Settings](#)

[Memory Module](#)

Speaker Cable Assembly

The cable position for the speaker assembly.

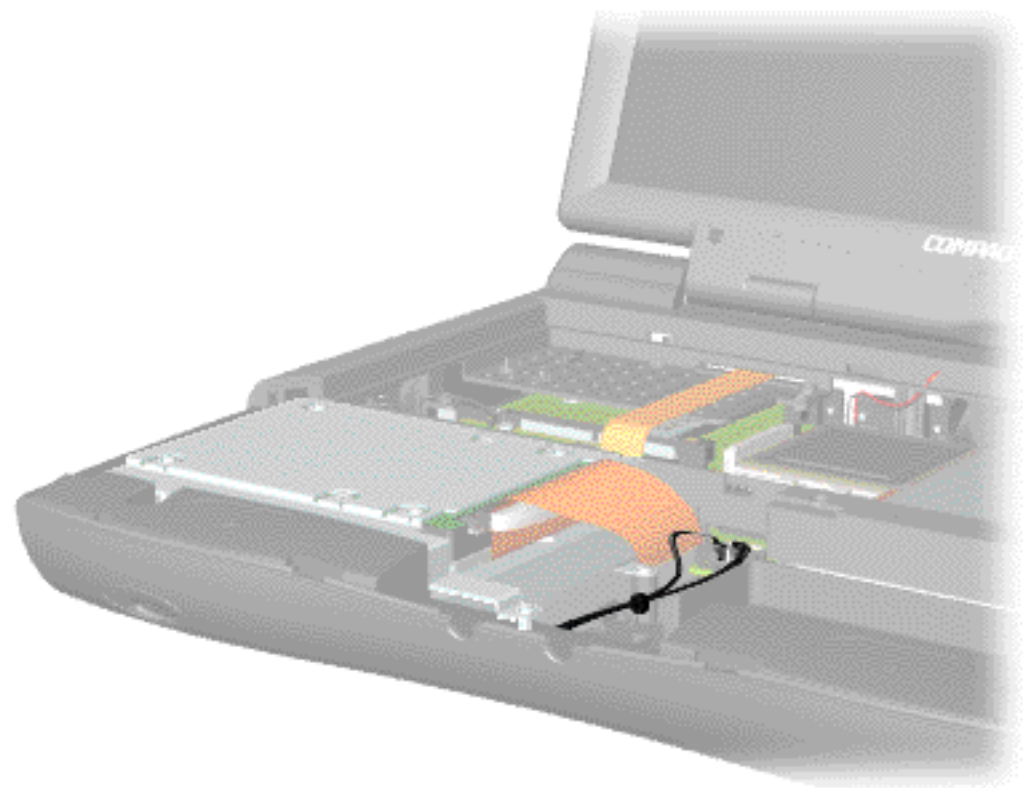

Back to [Cables and Connectors](#) main page.

maintenance & service guide

Presario 1600 Series

Models: 1683, 1685, 1687, 1688, 1690, 1692, 1693, and 1694

Before You Begin	Specifications	Parts Catalog
Removal Sequence	Troubleshooting	Battery Operations
Product Description	Pin Assignments	Index

Removal and Replacement

IMPORTANT:

Prior to conducting any removal and/or replacement procedures, you should review and fully understand the section titled "[Before You Begin](#)".

Removal Sequence

[Cables and Connectors](#)

Battery Pack

[Palmrest Cover with Touch Pad](#)

[Heatspreader](#)

[Keyboard](#)

[Processor](#)

[Hard Drive](#)

[DVD or CD Drive](#)

[Battery Charger Board](#)

[Modem](#)

[Display Panel Assembly](#)

[Upper CPU Cover](#)

[Speaker Assembly](#)

[Diskette Drive](#)

[Fan Assembly](#)

[System Board](#)

[Dip Switch Settings](#)

[Memory Module](#)

Removing the Battery Pack (step 1)



1. Slide the battery pack compartment door down and remove it from the battery pack.

[Next Step](#)

maintenance & service guide

Presario 1600 Series

Models: 1683, 1685, 1687, 1688, 1690, 1692, 1693, and 1694

Before You Begin	Specifications	Parts Catalog
Removal Sequence	Troubleshooting	Battery Operations
Product Description	Pin Assignments	Index

Removal and Replacement

IMPORTANT:

Prior to conducting any removal and/or replacement procedures, you should review and fully understand the section titled "[Before You Begin](#)".

Removal Sequence

[Cables and Connectors](#)

Battery Pack

[Palmrest Cover with Touch Pad](#)

[Heatspreader](#)

[Keyboard](#)

[Processor](#)

[Hard Drive](#)

[DVD or CD Drive](#)

[Battery Charger Board](#)

[Modem](#)

[Display Panel Assembly](#)

[Upper CPU Cover](#)

[Network Interface Card](#)

[Speaker Assembly](#)

[Diskette Drive](#)

[Fan Assembly](#)

[System Board](#)

[Dip Switch Settings](#)

[Memory Module](#)

Removing the Battery Pack (step 2)

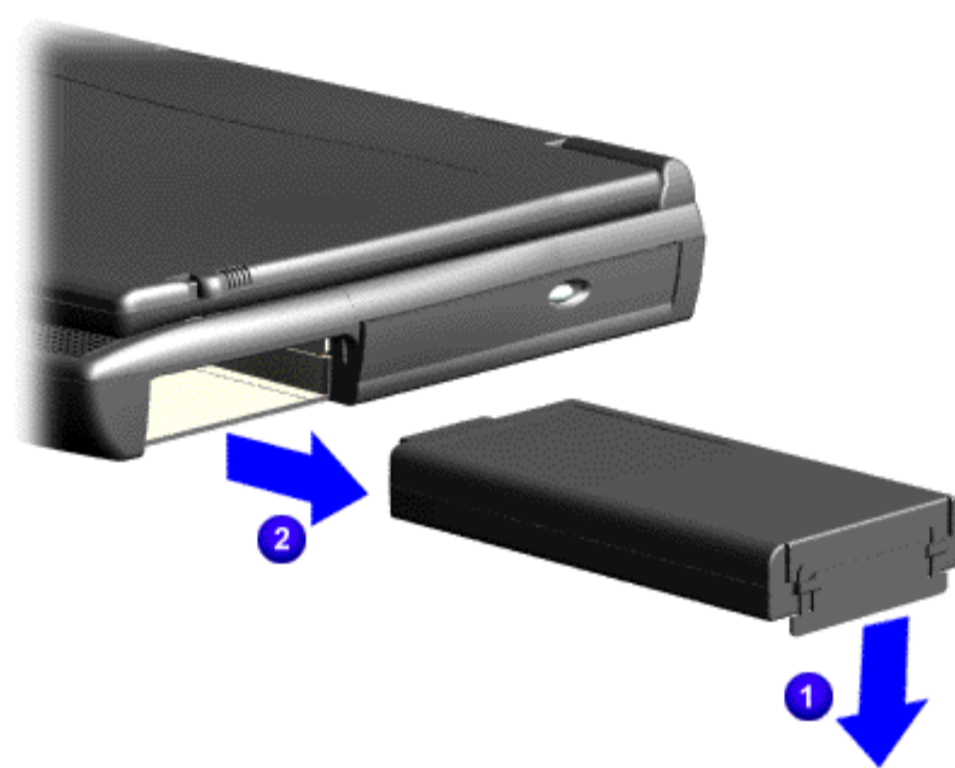

Pull down on the battery pack tab **1** and **2** pull the battery pack from the chassis.

To replace the battery pack, reverse the previous procedures.

maintenance & service guide

Presario 1600 Series

Models: 1683, 1685, 1687, 1688, 1690, 1692, 1693, and 1694

Before You Begin	Specifications	Parts Catalog
Removal Sequence	Troubleshooting	Battery Operations
Product Description	Pin Assignments	Index

Removal and Replacement

IMPORTANT:

Prior to conducting any removal and/or replacement procedures, you should review and fully understand the section titled "[Before You Begin](#)".

Removal Sequence

[Cables and Connectors](#)

[Battery Pack](#)

[Palmrest Cover with Touch Pad](#)

[Heatspreader](#)

[Keyboard](#)

[Processor](#)

[Hard Drive](#)

[DVD or CD Drive](#)

[Battery Charger Board](#)

[Modem](#)

[Display Panel Assembly](#)

[Upper CPU Cover](#)

[Speaker Assembly](#)

[Diskette Drive](#)

[Fan Assembly](#)

[System Board](#)

[Dip Switch Settings](#)

[Memory Module](#)

Removing the Palmrest Cover with Touch Pad

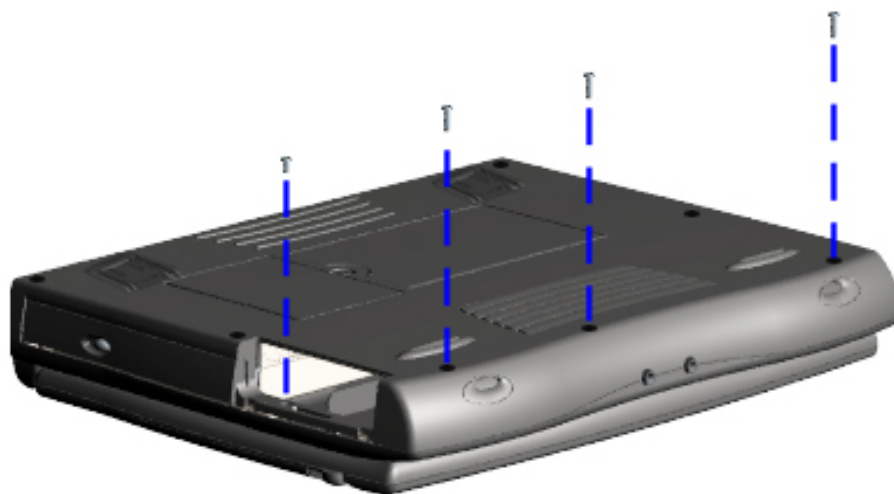

You must remove the palmrest cover with touchpad to gain access to the interior components, and it is the first step in the sequence of removal and replacement.

NOTE:

It is not necessary to remove the display panel assembly to access the interior components of the computer.

To remove the palmrest cover with touchpad, complete the following steps:

1. [Prepare the computer for disassembly.](#)
2. Close the computer and turn the computer upside down.
3. Remove four screws from the underside of the computer.

[Next Step](#)

maintenance & service guide

Presario 1600 Series

Models: 1683, 1685, 1687, 1688, 1690, 1692, 1693, and 1694

Before You Begin	Specifications	Parts Catalog
Removal Sequence	Troubleshooting	Battery Operations
Product Description	Pin Assignments	Index

Removal and Replacement

IMPORTANT: Prior to conducting any removal and/or replacement procedures, you should review and fully understand the section titled "[Before You Begin](#)".

Removal Sequence

[Cables and Connectors](#)

[Battery Pack](#)

[Palmrest Cover with Touch Pad](#)

[Heatspreader](#)

[Keyboard](#)

[Processor](#)

[Hard Drive](#)

[DVD or CD Drive](#)

[Battery Charger Board](#)

[Modem](#)

[Display Panel Assembly](#)

[Upper CPU Cover](#)

[Speaker Assembly](#)

[Diskette Drive](#)

[Fan Assembly](#)

[System Board](#)

[Dip Switch Settings](#)

[Memory Module](#)

Removing the Palmrest Cover with Touch Pad (steps 4 & 5)



[Previous Step](#)

4. Turn the computer over (right side up), pull forward on the display latches to release and open the display assembly.
5. Lift up front end of the palmrest cover with touch pad and remove it from the groove in the chassis.

[Next Step](#)

maintenance & service guide

Presario 1600 Series

Models: 1683, 1685, 1687, 1688, 1690, 1692, 1693, and 1694

Before You Begin	Specifications	Parts Catalog
Removal Sequence	Troubleshooting	Battery Operations
Product Description	Pin Assignments	Index

Removal and Replacement

IMPORTANT: Prior to conducting any removal and/or replacement procedures, you should review and fully understand the section titled "[Before You Begin](#)".

Removal Sequence
Cables and Connectors
Battery Pack
Palmrest Cover with Touch Pad
Heatspreader
Keyboard
Processor
Hard Drive
DVD or CD Drive
Battery Charger Board
Modem
Display Panel Assembly
Upper CPU Cover
Speaker Assembly
Diskette Drive
Fan Assembly
System Board
Dip Switch Settings
Memory Module

Removing the Palmrest Cover with Touch Pad (step 6)

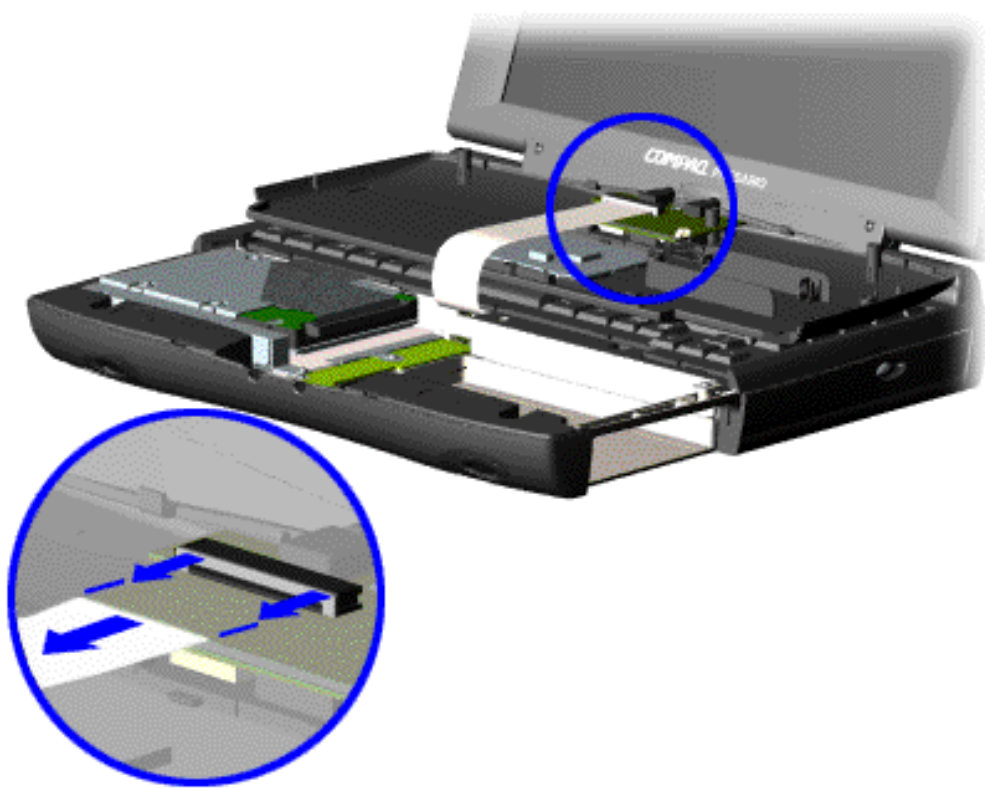

[Previous Steps](#)

6. Tilt the palmrest cover with touch pad, allowing it to rest on top of the keyboard, and disconnect the flex cable from the LIF connector on the palmrest cover.

CAUTION: When replacing the palmrest cover with touch pad, ensure that the cable is fully inserted into the LIF connector on the system board. If the metal end should come in contact with the keyboard, damage may occur to the computer.

To replace the palmrest cover with touch pad, reverse the previous procedures.

NOTE: When replacing the palm rest cover ensure the cable is properly routed through the slot on the Upper CPU cover.

maintenance & service guide

Presario 1600 Series

Models: 1683, 1685, 1687, 1688, 1690, 1692, 1693, and 1694

Before You Begin	Specifications	Parts Catalog
Removal Sequence	Troubleshooting	Battery Operations
Product Description	Pin Assignments	Index

Removal and Replacement

IMPORTANT:

Prior to conducting any removal and/or replacement procedures, you should review and fully understand the section titled "[Before You Begin](#)".

Heatspreader Removal (steps 1 - 3)

Removal Sequence
Cables and Connectors
Battery Pack
Palmrest Cover with Touch Pad
Heatspreader
Keyboard
Processor
Hard Drive
DVD or CD Drive
Battery Charger Board
Modem
Display Panel Assembly
Upper CPU Cover
Speaker Assembly
Diskette Drive
Fan Assembly
System Board
Dip Switch Settings
Memory Module

1. [Prepare the computer for disassembly.](#)
2. Remove the [palmrest cover with touch pad](#).
3. Gently lift and turn the keyboard over allowing it to rest on top of the [Palmrest Cover with Touchpad](#) slot opening.

[Next Step](#)

maintenance & service guide

Presario 1600 Series

Models: 1683, 1685, 1687, 1688, 1690, 1692, 1693, and 1694

Before You Begin	Specifications	Parts Catalog
Removal Sequence	Troubleshooting	Battery Operations
Product Description	Pin Assignments	Index

Removal and Replacement

IMPORTANT:

Prior to conducting any removal and/or replacement procedures, you should review and fully understand the section titled "[Before You Begin](#)".

Removal Sequence

[Cables and Connectors](#)

[Battery Pack](#)

[Palmrest Cover with Touch Pad](#)

[Heatspreader](#)

[Keyboard](#)

[Processor](#)

[Hard Drive](#)

[DVD or CD Drive](#)

[Battery Charger Board](#)

[Modem](#)

[Display Panel Assembly](#)

[Upper CPU Cover](#)

[Network Interface Card](#)

[Speaker Assembly](#)

[Diskette Drive](#)

[Fan Assembly](#)

[System Board](#)

[Dip Switch Settings](#)

[Memory Module](#)

Heatspreader Removal (step 4)

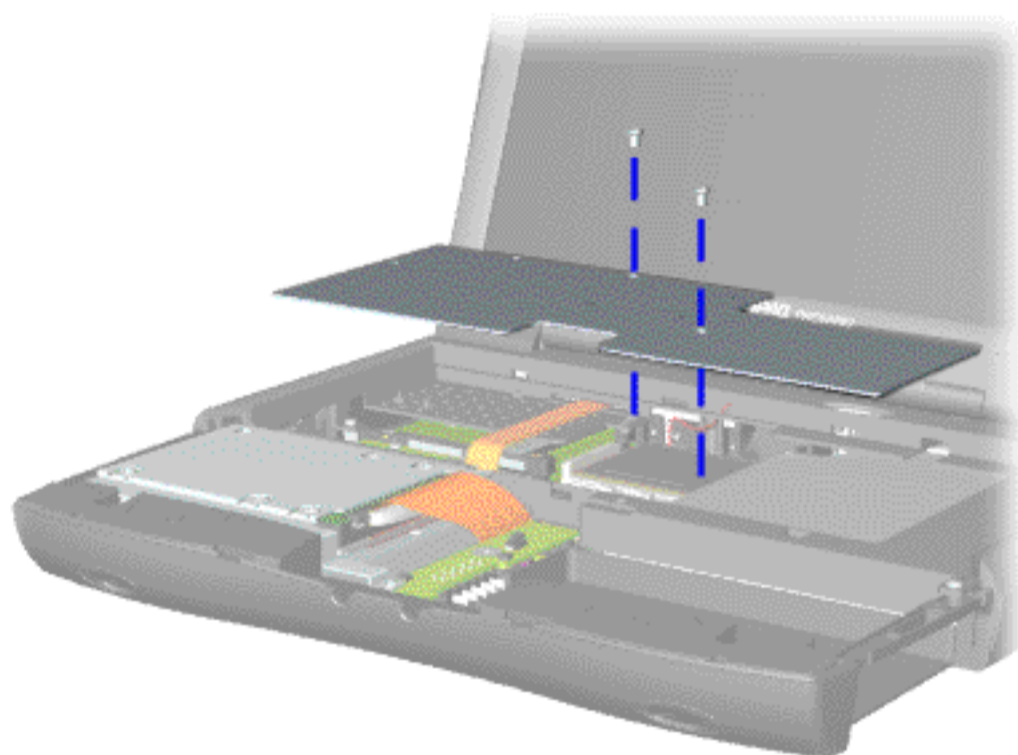

[Previous Steps](#)

4. Remove the screws from the heatspreader and lift out of the chassis.

To replace the heatspreader, reverse the previous procedures.

maintenance & service guide

Presario 1600 Series

Models: 1683, 1685, 1687, 1688, 1690, 1692, 1693, and 1694

Before You Begin	Specifications	Parts Catalog
Removal Sequence	Troubleshooting	Battery Operations
Product Description	Pin Assignments	Index

Removal and Replacement

IMPORTANT: Prior to conducting any removal and/or replacement procedures, you should review and fully understand the section titled "[Before You Begin](#)".

Removing the Keyboard

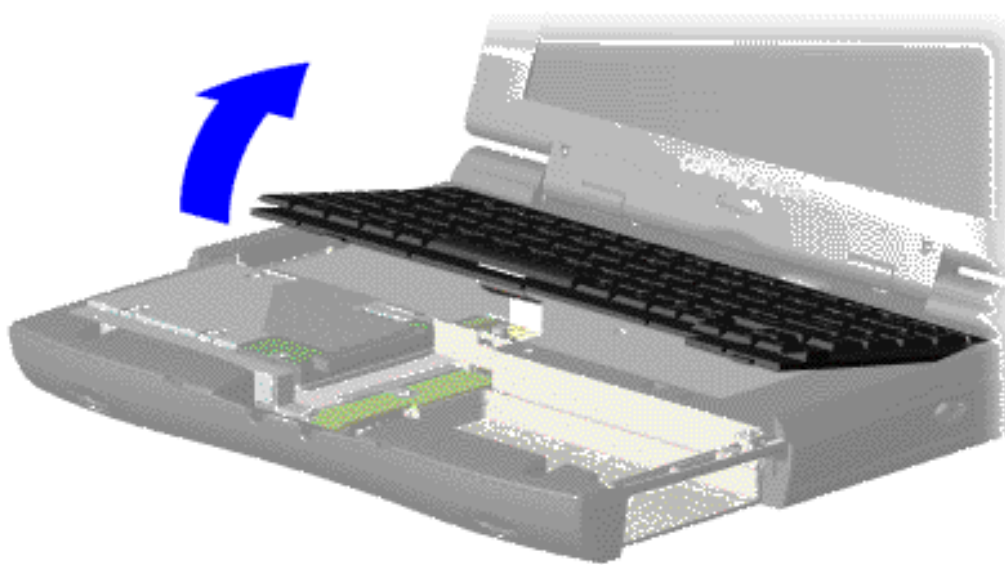

1. [Prepare the computer for disassembly.](#)
2. Remove the [palmrest cover with touch pad.](#)
3. Gently lift Zif Socket and remove keyboard.

Removal Sequence

[Cables and Connectors](#)

[Battery Pack](#)

[Palmrest Cover with Touch Pad](#)

[Heatspreader](#)

[Keyboard](#)

[Processor](#)

[Hard Drive](#)

[DVD or CD Drive](#)

[Battery Charger Board](#)

[Modem](#)

[Display Panel Assembly](#)

[Upper CPU Cover](#)

[Speaker Assembly](#)

[Diskette Drive](#)

[Fan Assembly](#)

[System Board](#)

[Dip Switch Settings](#)

[Memory Module](#)

maintenance & service guide

Presario 1600 Series

Models: 1683, 1685, 1687, 1688, 1690, 1692, 1693, and 1694

Before You Begin	Specifications	Parts Catalog
Removal Sequence	Troubleshooting	Battery Operations
Product Description	Pin Assignments	Index

Removal and Replacement

IMPORTANT:

Prior to conducting any removal and/or replacement procedures, you should review and fully understand the section titled "[Before You Begin](#)".

Removal Sequence

[Cables and Connectors](#)

[Battery Pack](#)

[Palmrest Cover with Touch Pad](#)

[Heatspreader](#)

[Keyboard](#)

Processor

[Hard Drive](#)

[DVD or CD Drive](#)

[Battery Charger Board](#)

[Modem](#)

[Display Panel Assembly](#)

[Upper CPU Cover](#)

[Speaker Assembly](#)

[Diskette Drive](#)

[Fan Assembly](#)

[System Board](#)

[Dip Switch Settings](#)

[Memory Module](#)

Removing the Processor

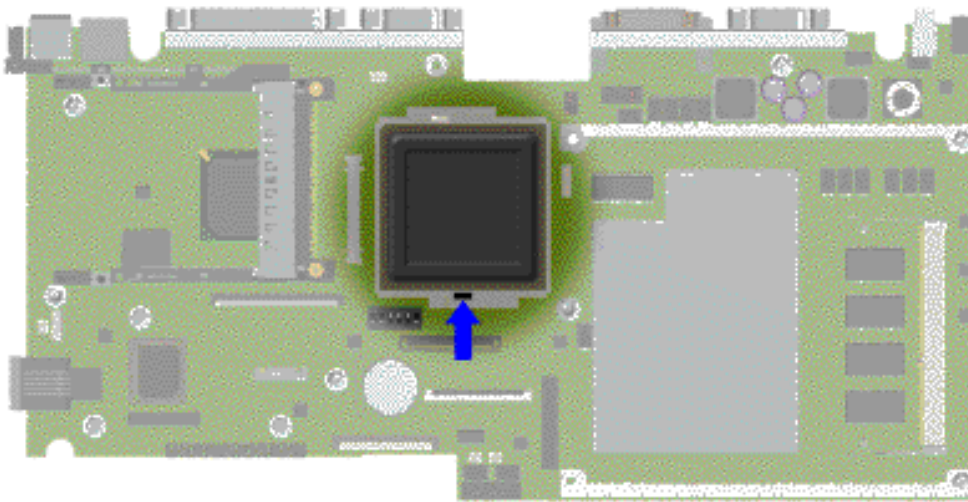

1. Prepare the [computer for disassembly](#).
2. Remove the [palmrest cover with touch pad](#).
3. Remove the [keyboard](#).
4. Remove the [heatspreader](#).
5. Insert a small blade screw driver into the top slot opening on the processor and push away from the display to release the processor from the chassis slot.
6. Lift the processor out of the processor chassis slot.

[Next Step](#) (Replacing the Processor)

maintenance & service guide

Presario 1600 Series

Models: 1683, 1685, 1687, 1688, 1690, 1692, 1693, and 1694

Before You Begin	Specifications	Parts Catalog
Removal Sequence	Troubleshooting	Battery Operations
Product Description	Pin Assignments	Index

Removal and Replacement

IMPORTANT: Prior to conducting any removal and/or replacement procedures, you should review and fully understand the section titled "[Before You Begin](#)".

Replacing the Processor

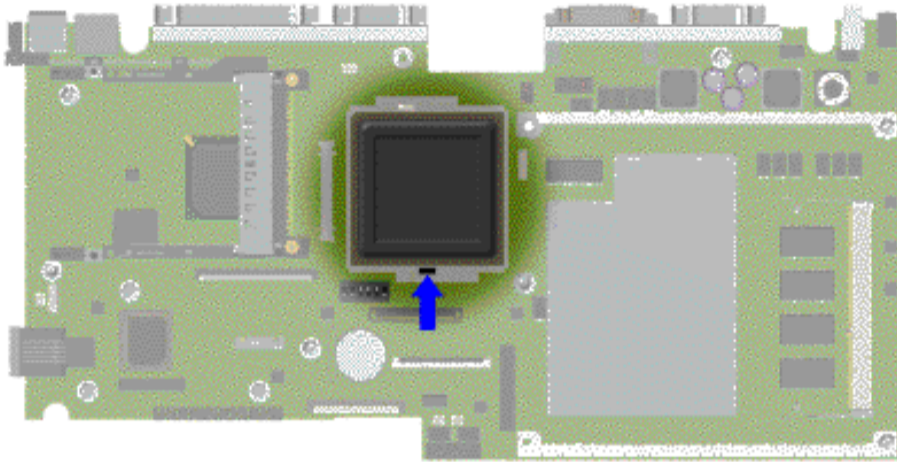

[Previous Step](#) (Removing the Processor)

The notch on the upper left corner of the processor serves as an orientation indicator.

IMPORTANT:

Align the notch on the left corner of the processor with the notch on the left corner of the processor chassis slot.

1. Insert the processor into the slot on the system board.

NOTE:

When installing the processor into the chassis slot, be sure that the hole pattern on the chassis slot lines up with the pins on the processor.

The processor should drop into the socket without any force.

2. Insert a small blade screw driver into the bottom slot opening on the processor and push toward the display to lock the processor.

[Return](#)

Removal Sequence

[Cables and Connectors](#)

[Battery Pack](#)

[Palmrest Cover with Touch Pad](#)

[Heatspreader](#)

[Keyboard](#)

Processor

[Hard Drive](#)

[DVD or CD Drive](#)

[Battery Charger Board](#)

[Modem](#)

[Display Panel Assembly](#)

[Upper CPU Cover](#)

[Network Interface Card](#)

[Speaker Assembly](#)

[Diskette Drive](#)

[Fan Assembly](#)

[System Board](#)

[Dip Switch Settings](#)

[Memory Module](#)

maintenance & service guide

Presario 1600 Series

Models: 1683, 1685, 1687, 1688, 1690, 1692, 1693, and 1694

Before You Begin	Specifications	Parts Catalog
Removal Sequence	Troubleshooting	Battery Operations
Product Description	Pin Assignments	Index

Removal and Replacement

IMPORTANT: Prior to conducting any removal and/or replacement procedures, you should review and fully understand the section titled "[Before You Begin](#)".

Removing the Hard Drive (steps 1 - 4)

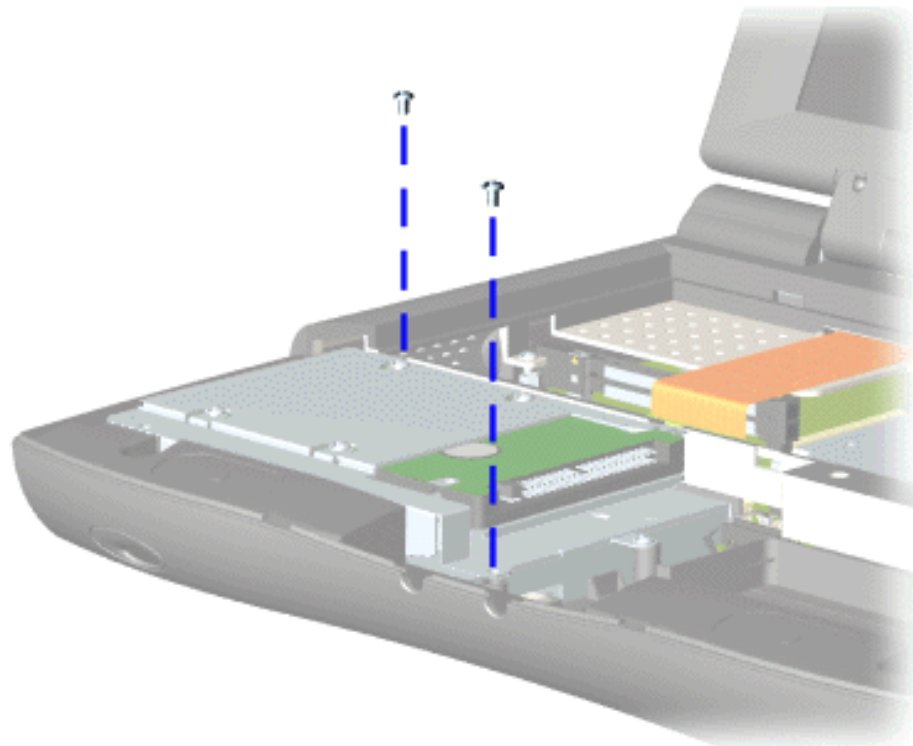

1. Prepare the [computer for disassembly](#).
2. Remove the [palmrest cover with touch pad](#).
3. Remove the [keyboard](#).
4. Remove two screws from the hard drive mounting bracket and lift out the hard drive with drive mounting bracket attached.

[Next Step](#)

Removal Sequence

[Cables and Connectors](#)

[Battery Pack](#)

[Palmrest Cover with Touch Pad](#)

[Heatspreader](#)

[Keyboard](#)

[Processor](#)

Hard Drive

[DVD or CD Drive](#)

[Battery Charger Board](#)

[Modem](#)

[Display Panel Assembly](#)

[Upper CPU Cover](#)

[Speaker Assembly](#)

[Diskette Drive](#)

[Fan Assembly](#)

[System Board](#)

[Dip Switch Settings](#)

[Memory Module](#)

maintenance & service guide

Presario 1600 Series

Models: 1683, 1685, 1687, 1688, 1690, 1692, 1693, and 1694

Before You Begin	Specifications	Parts Catalog
Removal Sequence	Troubleshooting	Battery Operations
Product Description	Pin Assignments	Index

Removal and Replacement

IMPORTANT:

Prior to conducting any removal and/or replacement procedures, you should review and fully understand the section titled "[Before You Begin](#)".

Removal Sequence

[Cables and Connectors](#)

[Battery Pack](#)

[Palmrest Cover with Touch Pad](#)

[Heatspreader](#)

[Keyboard](#)

[Processor](#)

[Hard Drive](#)

[DVD or CD Drive](#)

[Battery Charger Board](#)

[Modem](#)

[Display Panel Assembly](#)

[Upper CPU Cover](#)

[Speaker Assembly](#)

[Diskette Drive](#)

[Fan Assembly](#)

[System Board](#)

[Dip Switch Settings](#)

[Memory Module](#)

Removing the Hard Drive (step 5)

[Previous Steps](#)

5. Disconnect the hard drive data cable from the hard drive and remove from the chassis.

[Next Step](#)

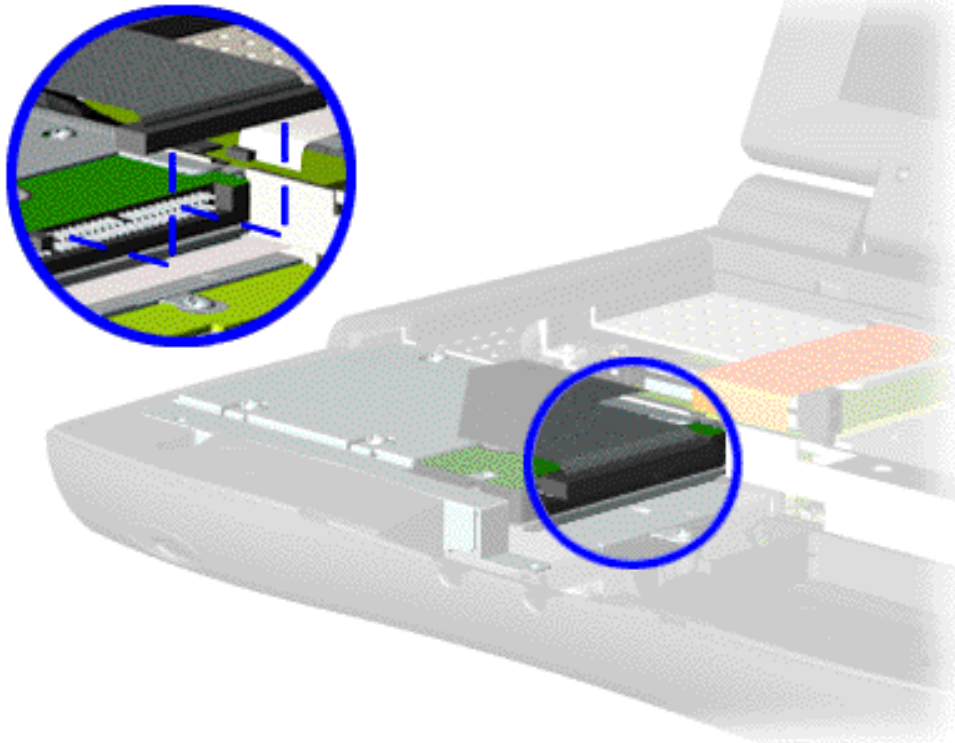

maintenance & service guide

Presario 1600 Series

Models: 1683, 1685, 1687, 1688, 1690, 1692, 1693, and 1694

Before You Begin	Specifications	Parts Catalog
Removal Sequence	Troubleshooting	Battery Operations
Product Description	Pin Assignments	Index

Removal and Replacement

IMPORTANT:

Prior to conducting any removal and/or replacement procedures, you should review and fully understand the section titled "[Before You Begin](#)".

Removal Sequence

[Cables and Connectors](#)

[Battery Pack](#)

[Palmrest Cover with Touch Pad](#)

[Heatspreader](#)

[Keyboard](#)

[Processor](#)

Hard Drive

[DVD or CD Drive](#)

[Battery Charger Board](#)

[Modem](#)

[Display Panel Assembly](#)

[Upper CPU Cover](#)

[Speaker Assembly](#)

[Diskette Drive](#)

[Fan Assembly](#)

[System Board](#)

[Dip Switch Settings](#)

[Memory Module](#)

Removing the Hard Drive (step 6)

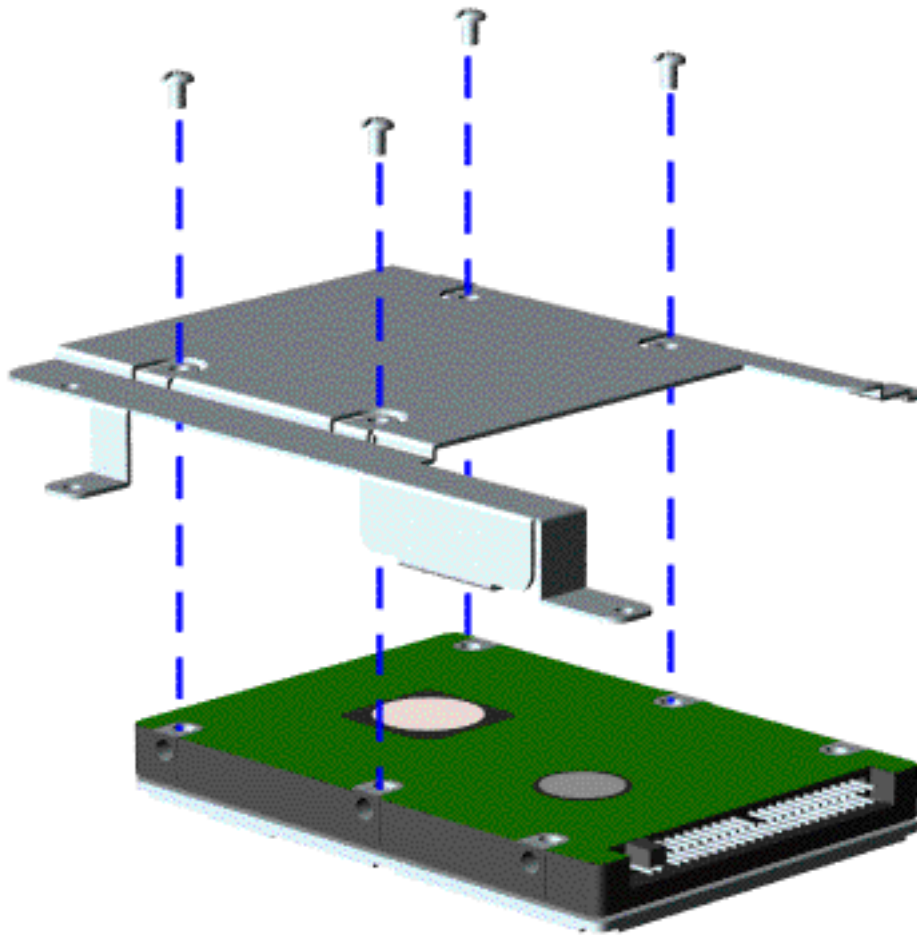

[Previous Steps](#)

6. Remove four screws from the hard drive mounting bracket.

To replace the hard drive and hard drive mounting bracket, reverse the previous procedures.

[Return](#)

maintenance & service guide

Presario 1600 Series

Models: 1683, 1685, 1687, 1688, 1690, 1692, 1693, and 1694

Before You Begin	Specifications	Parts Catalog
Removal Sequence	Troubleshooting	Battery Operations
Product Description	Pin Assignments	Index

Removal and Replacement

IMPORTANT: Prior to conducting any removal and/or replacement procedures, you should review and fully understand the section titled "[Before You Begin](#)".

Removal of DVD or CD Drive

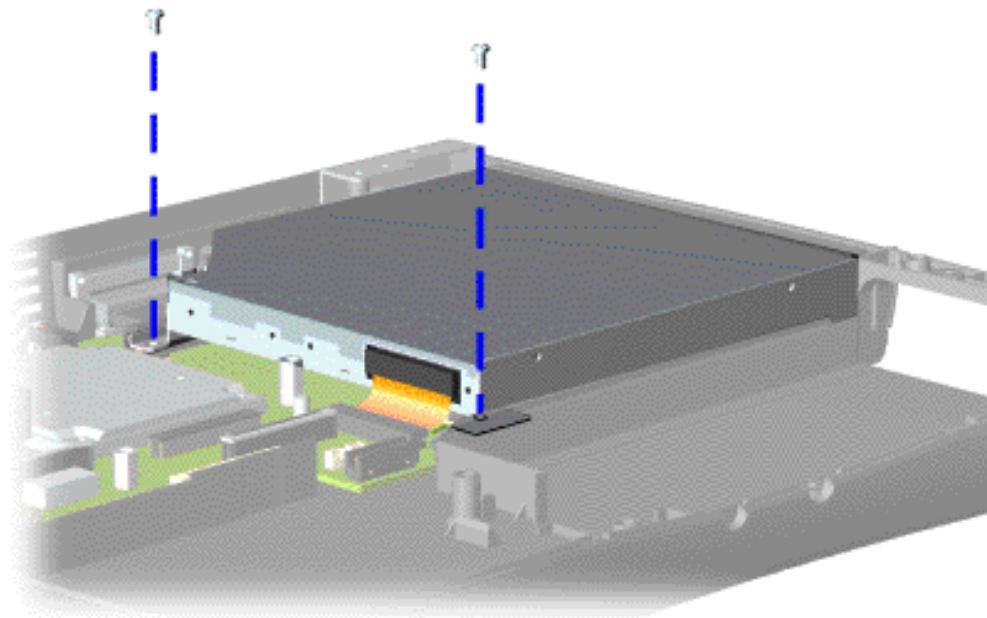

1. Prepare the [computer for disassembly](#).
2. Remove the [palmrest cover with touch pad](#).
3. Remove the [keyboard](#).
4. Remove the [heatspreader](#).
5. Remove two screws located at the back of the DVD or CD drive.

[Next Step](#)

Removal Sequence

[Cables and Connectors](#)

[Battery Pack](#)

[Palmrest Cover with Touch Pad](#)

[Heatspreader](#)

[Keyboard](#)

[Processor](#)

[Hard Drive](#)

[DVD or CD Drive](#)

[Battery Charger Board](#)

[Modem](#)

[Display Panel Assembly](#)

[Upper CPU Cover](#)

[Speaker Assembly](#)

[Diskette Drive](#)

[Fan Assembly](#)

[System Board](#)

[Dip Switch Settings](#)

[Memory Module](#)

maintenance & service guide

Presario 1600 Series

Models: 1683, 1685, 1687, 1688, 1690, 1692, 1693, and 1694

Before You Begin	Specifications	Parts Catalog
Removal Sequence	Troubleshooting	Battery Operations
Product Description	Pin Assignments	Index

Removal and Replacement

IMPORTANT: Prior to conducting any removal and/or replacement procedures, you should review and fully understand the section titled "[Before You Begin](#)".

Removal of DVD or CD Drive (step 6)

[Previous Steps](#)

6. Remove two screws from the base enclosure which secures the DVD or CD drive to the chassis.

[Next Step](#)

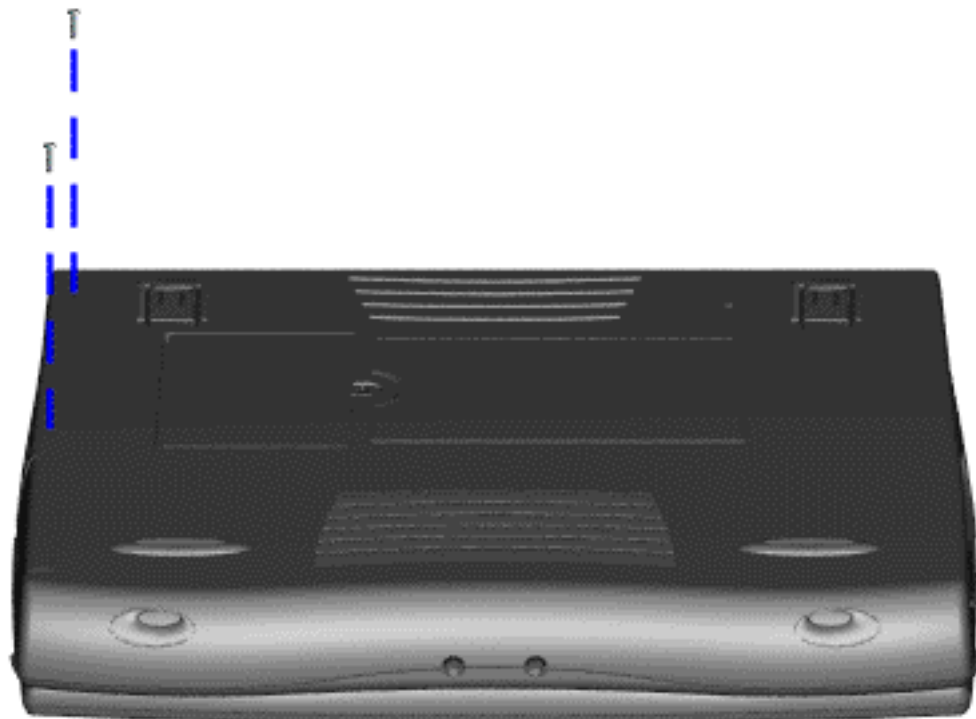

Removal Sequence

[Cables and Connectors](#)

[Battery Pack](#)

[Palmrest Cover with Touch Pad](#)

[Heatspreader](#)

[Keyboard](#)

[Processor](#)

[Hard Drive](#)

[DVD or CD Drive](#)

[Battery Charger Board](#)

[Modem](#)

[Display Panel Assembly](#)

[Upper CPU Cover](#)

[Speaker Assembly](#)

[Diskette Drive](#)

[Fan Assembly](#)

[System Board](#)

[Dip Switch Settings](#)

[Memory Module](#)

maintenance & service guide

Presario 1600 Series

Models: 1683, 1685, 1687, 1688, 1690, 1692, 1693, and 1694

Before You Begin	Specifications	Parts Catalog
Removal Sequence	Troubleshooting	Battery Operations
Product Description	Pin Assignments	Index

Removal and Replacement

IMPORTANT: Prior to conducting any removal and/or replacement procedures, you should review and fully understand the section titled "[Before You Begin](#)".

[Removal of DVD or CD Drive \(step 7\)](#) [Previous Steps](#)

7. Disconnect the DVD or CD drive cable from the DVD or CD drive and remove the DVD or CD drive from the chassis.

To replace the DVD or CD drive, reverse the previous procedures.

[Return](#)

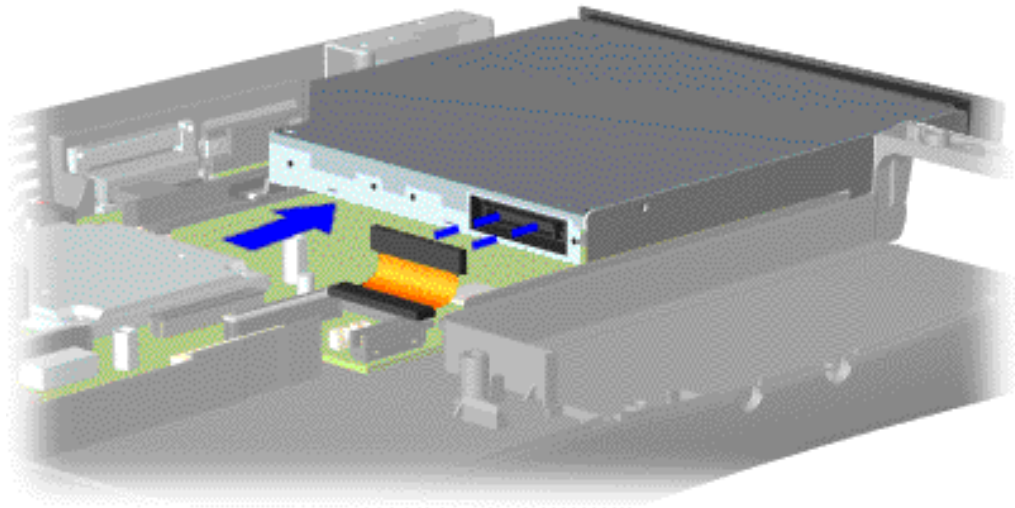

Removal Sequence
Cables and Connectors
Battery Pack
Palmrest Cover with Touch Pad
Heatspreader
Keyboard
Processor
Hard Drive
DVD or CD Drive
Battery Charger Board
Modem
Display Panel Assembly
Upper CPU Cover
Speaker Assembly
Diskette Drive
Fan Assembly
System Board
Dip Switch Settings
Memory Module

maintenance & service guide

Presario 1600 Series

Models: 1683, 1685, 1687, 1688, 1690, 1692, 1693, and 1694

Before You Begin	Specifications	Parts Catalog
Removal Sequence	Troubleshooting	Battery Operations
Product Description	Pin Assignments	Index

Removal and Replacement

IMPORTANT: Prior to conducting any removal and/or replacement procedures, you should review and fully understand the section titled "[Before You Begin](#)".

Removal Sequence

[Cables and Connectors](#)

[Battery Pack](#)

[Palmrest Cover with Touch Pad](#)

[Heatspreader](#)

[Keyboard](#)

[Processor](#)

[Hard Drive](#)

[DVD or CD Drive](#)

Battery Charger Board

[Modem](#)

[Display Panel Assembly](#)

[Upper CPU Cover](#)

[Speaker Assembly](#)

[Diskette Drive](#)

[Fan Assembly](#)

[System Board](#)

[Dip Switch Settings](#)

[Memory Module](#)

Removing the Battery Charger Board

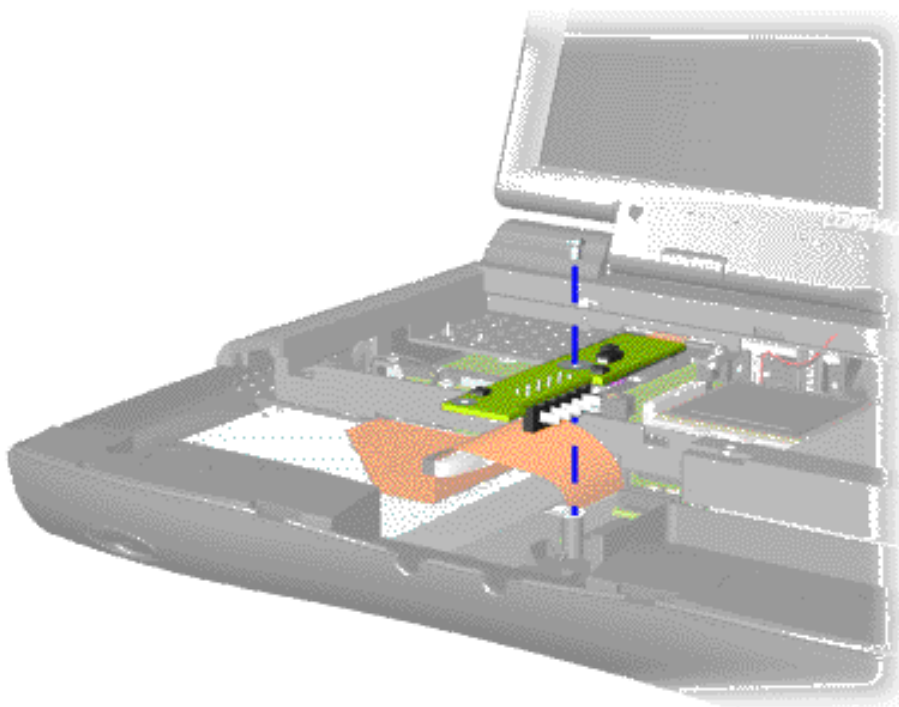

1. Prepare the [computer for disassembly](#).
2. Remove the [palmrest cover with touch pad](#).
3. Remove the [keyboard](#).
4. Remove the [heatspreader](#).
5. Remove the hard drive.
6. Remove one screw from the battery charger board, unplug the board from the connector on the system board, and lift out the chassis.

To replace the battery charger board, reverse the previous procedures.

NOTE: When replacing the battery charger board, ensure the pins are aligned with the connector on the system board.

maintenance & service guide

Presario 1600 Series

Models: 1683, 1685, 1687, 1688, 1690, 1692, 1693, and 1694

Before You Begin	Specifications	Parts Catalog
Removal Sequence	Troubleshooting	Battery Operations
Product Description	Pin Assignments	Index

Removal and Replacement

IMPORTANT: Prior to conducting any removal and/or replacement procedures, you should review and fully understand the section titled "[Before You Begin](#)".

Removal Sequence

[Cables and Connectors](#)

[Battery Pack](#)

[Palmrest Cover with Touch Pad](#)

[Heatspreader](#)

[Keyboard](#)

[Processor](#)

[Hard Drive](#)

[DVD or CD Drive](#)

[Battery Charger Board](#)

Modem

[Display Panel Assembly](#)

[Upper CPU Cover](#)

[Speaker Assembly](#)

[Diskette Drive](#)

[Fan Assembly](#)

[System Board](#)

[Dip Switch Settings](#)

[Memory Module](#)

Removing the Modem (steps 1 - 5)

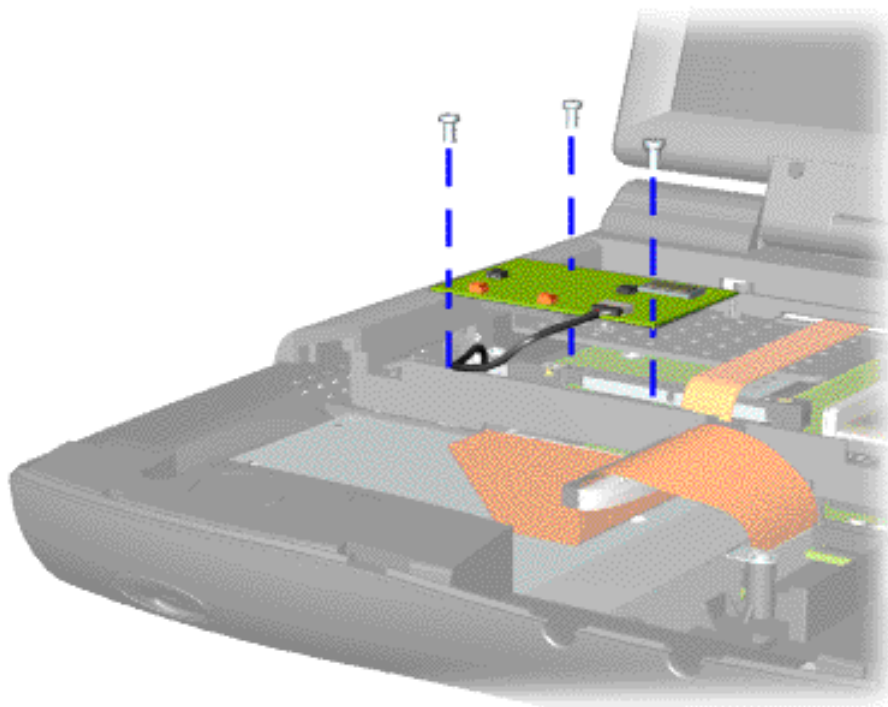

1. Prepare the [computer for disassembly](#).
2. Remove the [palmrest cover with touch pad](#).
3. Remove the [keyboard](#).
4. Remove the [heatspreader](#).
5. Remove three screws securing modem and pull the modem off the connector on the system board.

[Next Step](#)

maintenance & service guide

Presario 1600 Series

Models: 1683, 1685, 1687, 1688, 1690, 1692, 1693, and 1694

Before You Begin	Specifications	Parts Catalog
Removal Sequence	Troubleshooting	Battery Operations
Product Description	Pin Assignments	Index

Removal and Replacement

IMPORTANT: Prior to conducting any removal and/or replacement procedures, you should review and fully understand the section titled "[Before You Begin](#)".

Removal Sequence
Cables and Connectors
Battery Pack
Palmrest Cover with Touch Pad
Heatspreader
Keyboard
Processor
Hard Drive
DVD or CD Drive
Battery Charger Board
Modem
Display Panel Assembly
Upper CPU Cover
Speaker Assembly
Diskette Drive
Fan Assembly
System Board
Dip Switch Settings
Memory Module

Removing the Modem (step 6)

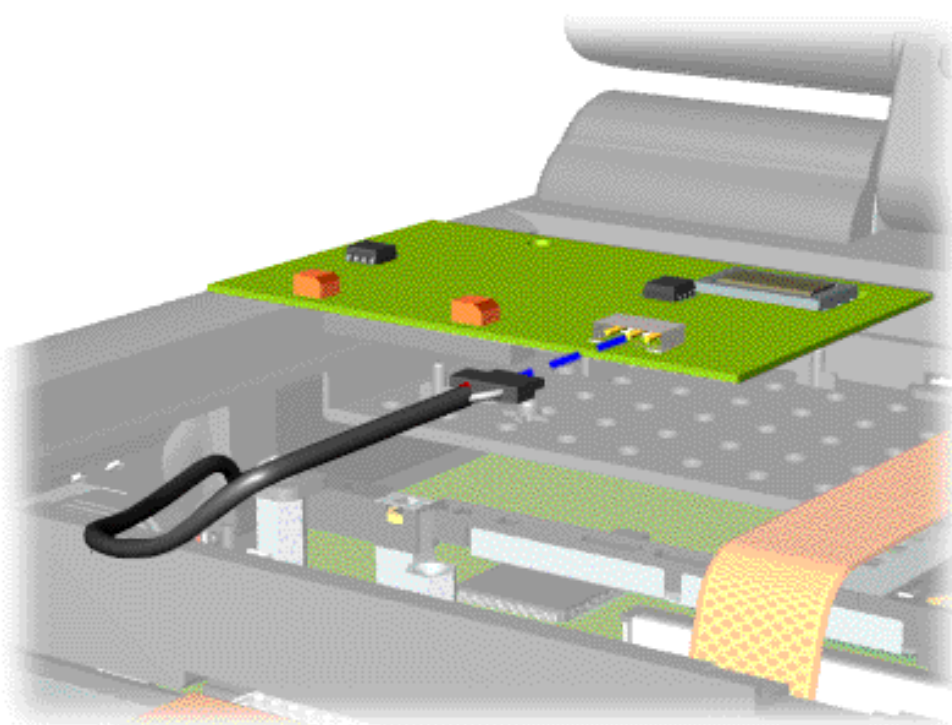

[Previous Steps](#)

6. Disconnect the modem cable from the modem.

To replace the modem, reverse the previous procedures.

[Return](#)

maintenance & service guide

Presario 1600 Series

Models: 1683, 1685, 1687, 1688, 1690, 1692, 1693, and 1694

Before You Begin	Specifications	Parts Catalog
Removal Sequence	Troubleshooting	Battery Operations
Product Description	Pin Assignments	Index

Removal and Replacement

IMPORTANT: Prior to conducting any removal and/or replacement procedures, you should review and fully understand the section titled "[Before You Begin](#)".

Removing the Display Panel Assembly

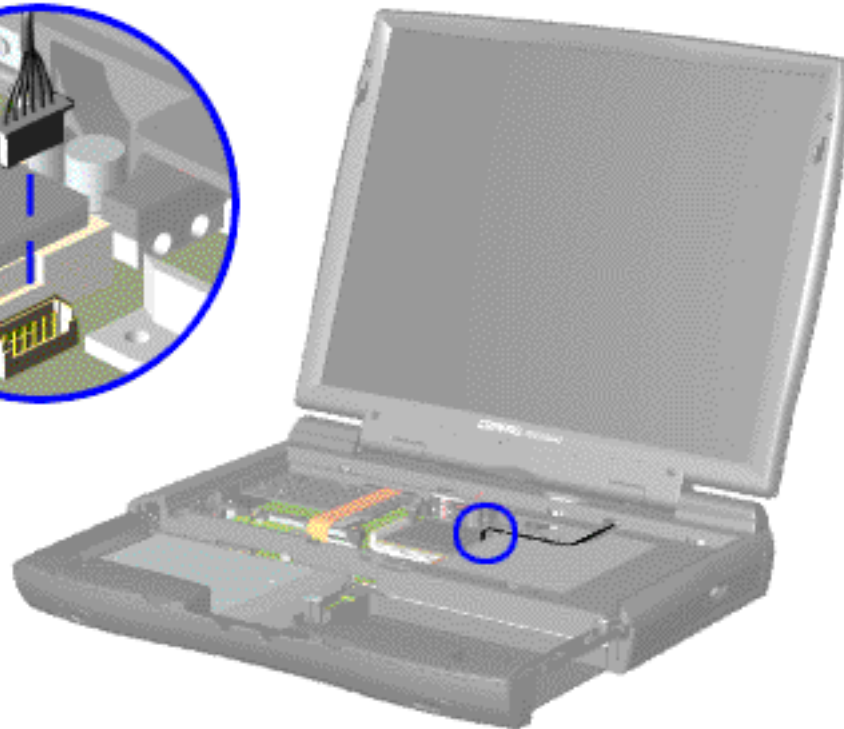
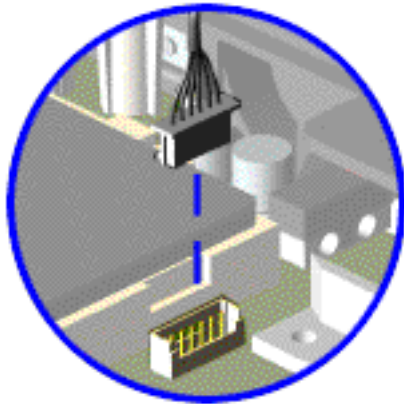

1. Prepare the [computer for disassembly](#).
2. Remove the [palmrest cover with touch pad](#).
3. Remove the [keyboard](#).
4. Remove the [heatspreader](#).
5. Remove the [modem](#).
6. Disconnect the backlight cable attached to the display panel assembly from the connector on the system board.

[Next Step](#)

Removal Sequence

[Cables and Connectors](#)

[Battery Pack](#)

[Palmrest Cover with Touch Pad](#)

[Heatspreader](#)

[Keyboard](#)

[Processor](#)

[Hard Drive](#)

[DVD or CD Drive](#)

[Battery Charger Board](#)

[Modem](#)

[Display Panel Assembly](#)

[Upper CPU Cover](#)

[Speaker Assembly](#)

[Diskette Drive](#)

[Fan Assembly](#)

[System Board](#)

[Dip Switch Settings](#)

[Memory Module](#)

maintenance & service guide

Presario 1600 Series

Models: 1683, 1685, 1687, 1688, 1690, 1692, 1693, and 1694

Before You Begin	Specifications	Parts Catalog
Removal Sequence	Troubleshooting	Battery Operations
Product Description	Pin Assignments	Index

Removal and Replacement

IMPORTANT: Prior to conducting any removal and/or replacement procedures, you should review and fully understand the section titled "[Before You Begin](#)".

Removal Sequence

[Cables and Connectors](#)

[Battery Pack](#)

[Palmrest Cover with Touch Pad](#)

[Heatspreader](#)

[Keyboard](#)

[Processor](#)

[Hard Drive](#)

[DVD or CD Drive](#)

[Battery Charger Board](#)

[Modem](#)

[Display Panel Assembly](#)

[Upper CPU Cover](#)

[Speaker Assembly](#)

[Diskette Drive](#)

[Fan Assembly](#)

[System Board](#)

[Dip Switch Settings](#)

[Memory Module](#)

Removing the Display Panel Assembly (step 7)

[Previous Step](#)

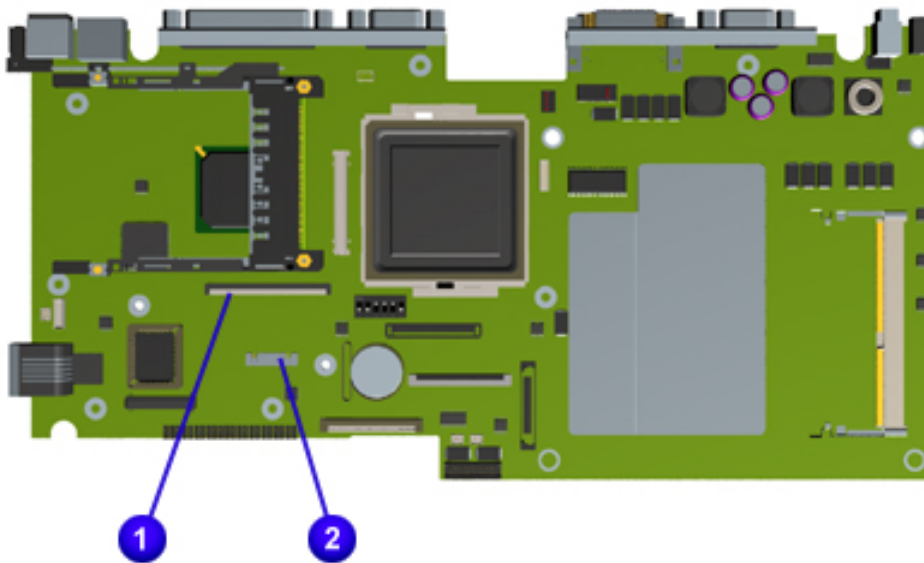

7. Disconnect the flex data cable attached to the display panel assembly from either the TFT connector **1** or the Low Voltage Differential Signal (LVDS) **2** connector on the system board.

[Next Step](#)

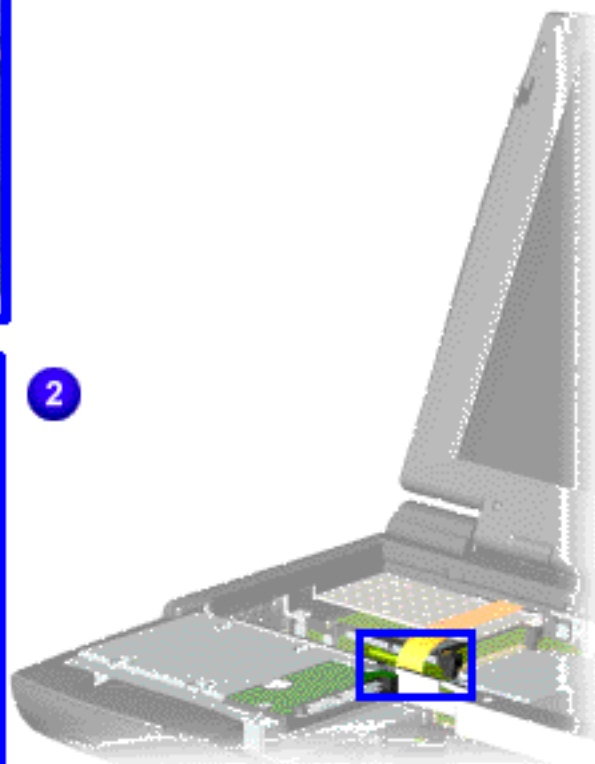
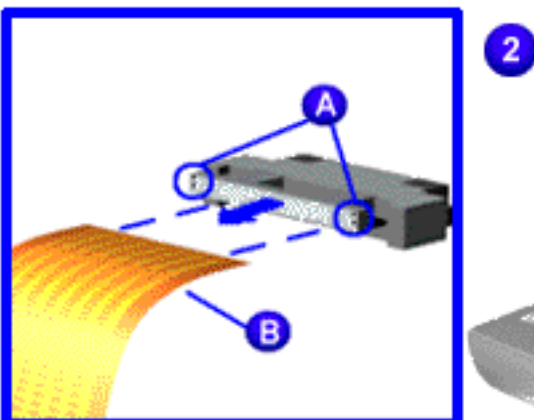
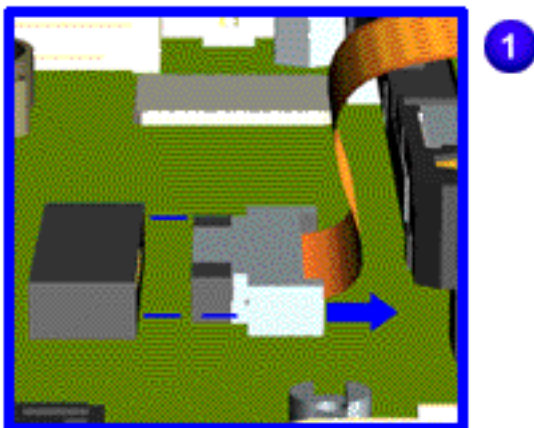

maintenance & service guide

Presario 1600 Series

Models: 1683, 1685, 1687, 1688, 1690, 1692, 1693, and 1694

Before You Begin	Specifications	Parts Catalog
Removal Sequence	Troubleshooting	Battery Operations
Product Description	Pin Assignments	Index

Removal and Replacement

IMPORTANT:

Prior to conducting any removal and/or replacement procedures, you should review and fully understand the section titled "[Before You Begin](#)".

Removal Sequence

[Cables and Connectors](#)

[Battery Pack](#)

[Palmrest Cover with Touch Pad](#)

[Heatspreader](#)

[Keyboard](#)

[Processor](#)

[Hard Drive](#)

[DVD or CD Drive](#)

[Battery Charger Board](#)

[Modem](#)

[Display Panel Assembly](#)

[Upper CPU Cover](#)

[Speaker Assembly](#)

[Diskette Drive](#)

[Fan Assembly](#)

[System Board](#)

[Dip Switch Settings](#)

[Memory Module](#)

Removing the Display Panel Assembly (step 8)

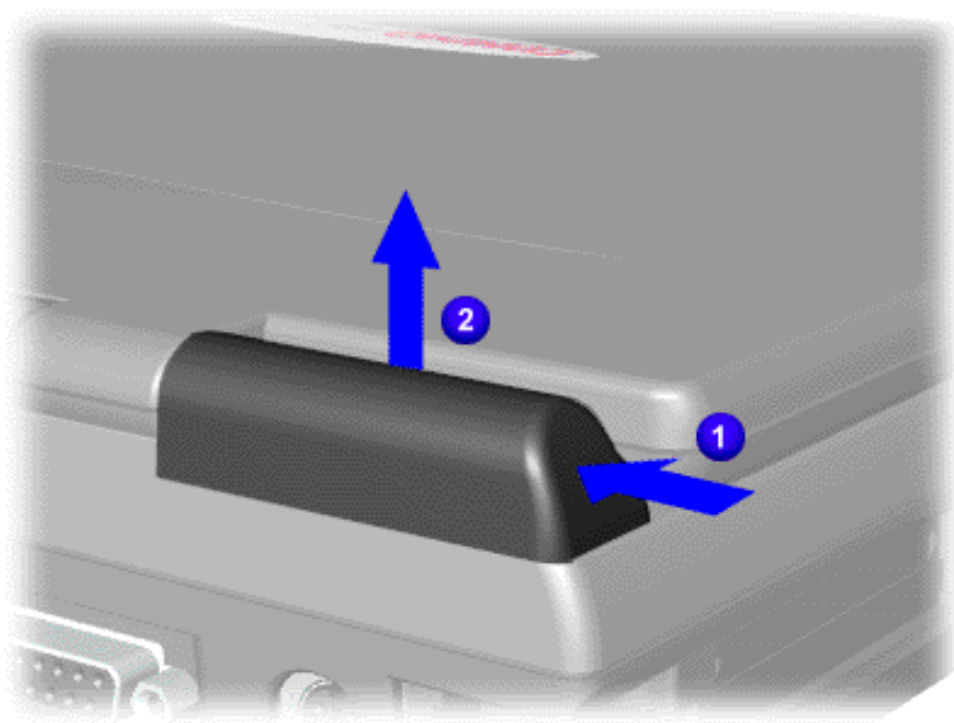

[Previous Step](#)

8. Close the display panel assembly and **1** push back on top of the hinge covers and **2** lift up from the bottom edge of the hinge covers to remove the covers off the chassis.

IMPORTANT:

Carefully remove the display panel assembly hinge covers.

[Next Step](#)

maintenance & service guide

Presario 1600 Series

Models: 1683, 1685, 1687, 1688, 1690, 1692, 1693, and 1694

Before You Begin	Specifications	Parts Catalog
Removal Sequence	Troubleshooting	Battery Operations
Product Description	Pin Assignments	Index

Removal and Replacement

IMPORTANT: Prior to conducting any removal and/or replacement procedures, you should review and fully understand the section titled "[Before You Begin](#)".

Removing the Display Panel Assembly (step 9)

[Previous Step](#)

9. Support the back of the display panel assembly and remove two screws from each of the display panel hinges.

[Next Step](#)

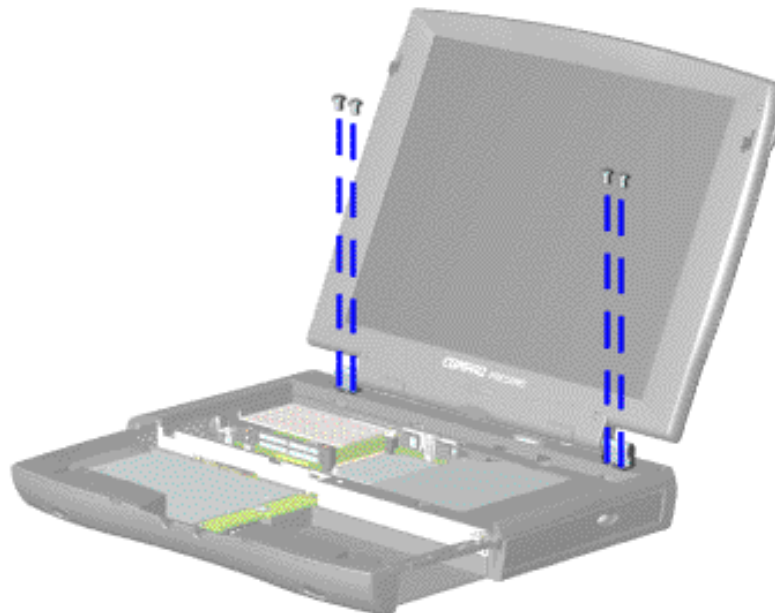

Removal Sequence
Cables and Connectors
Battery Pack
Palmrest Cover with Touch Pad
Heatspreader
Keyboard
Processor
Hard Drive
DVD or CD Drive
Battery Charger Board
Modem
Display Panel Assembly
Upper CPU Cover
Speaker Assembly
Diskette Drive
Fan Assembly
System Board
Dip Switch Settings
Memory Module

maintenance & service guide

Presario 1600 Series

Models: 1683, 1685, 1687, 1688, 1690, 1692, 1693, and 1694

Before You Begin	Specifications	Parts Catalog
Removal Sequence	Troubleshooting	Battery Operations
Product Description	Pin Assignments	Index

Removal and Replacement

IMPORTANT:

Prior to conducting any removal and/or replacement procedures, you should review and fully understand the section titled "[Before You Begin](#)".

Removal Sequence

[Cables and Connectors](#)

[Battery Pack](#)

[Palmrest Cover with Touch Pad](#)

[Heatspreader](#)

[Keyboard](#)

[Processor](#)

[Hard Drive](#)

[DVD or CD Drive](#)

[Battery Charger Board](#)

[Modem](#)

Display Panel Assembly

[Upper CPU Cover](#)

[Speaker Assembly](#)

[Diskette Drive](#)

[Fan Assembly](#)

[System Board](#)

[Dip Switch Settings](#)

[Memory Module](#)

Removing the Display Panel Assembly (steps 10 - 11)

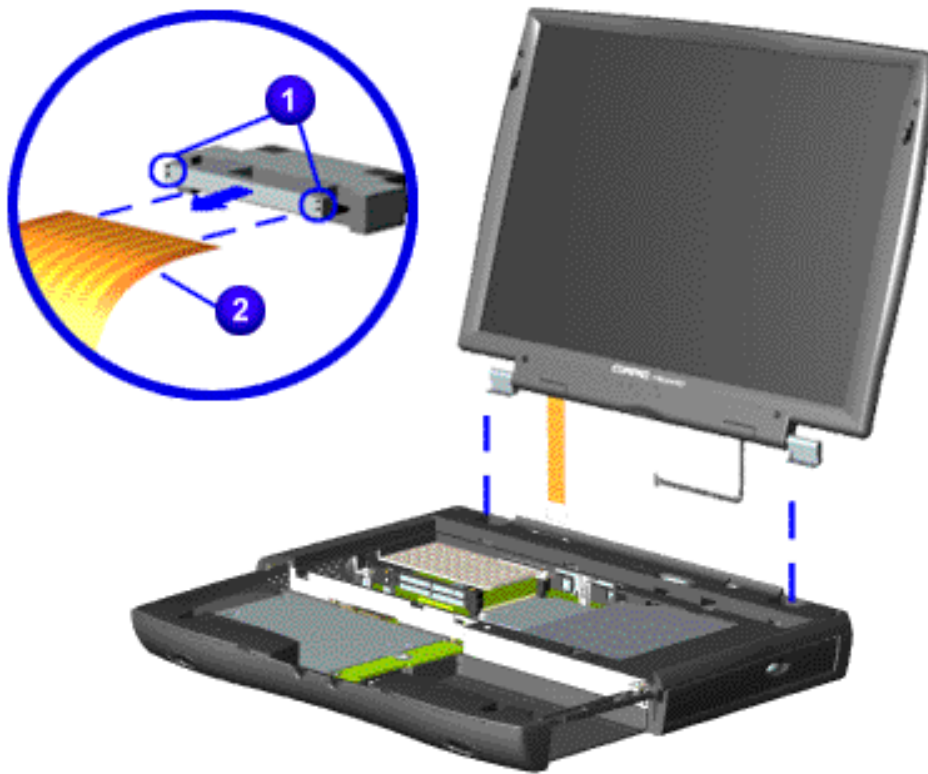

Previous Step

10. Remove the **1** connector on the end of the display flex **2** data cable.

IMPORTANT:

Compaq recommends replacing the LVDS interface connector on the display flex data cable after removing.



CAUTION: The connector on the end of the flex cable must be removed before the cable can be routed through the slot on the Upper CPU cover.

11. Gently pull the flex data cable and backlight cable attached to the display panel assembly through the slot on the Upper CPU cover and remove the display panel assembly with flex data and backlight cable attached.

NOTE:

When removing the display panel assembly, observe the display panel assembly flex cable routing and position.

To replace the display panel assembly, reverse the previous procedures.

[Return](#)

maintenance & service guide

Presario 1600 Series

Models: 1683, 1685, 1687, 1688, 1690, 1692, 1693, and 1694

Before You Begin	Specifications	Parts Catalog
Removal Sequence	Troubleshooting	Battery Operations
Product Description	Pin Assignments	Index

Removal and Replacement

IMPORTANT:

Prior to conducting any removal and/or replacement procedures, you should review and fully understand the section titled "[Before You Begin](#)".

Removal Sequence

[Cables and Connectors](#)

[Battery Pack](#)

[Palmrest Cover with Touch Pad](#)

[Heatspreader](#)

[Keyboard](#)

[Processor](#)

[Hard Drive](#)

[DVD or CD Drive](#)

[Battery Charger Board](#)

[Modem](#)

[Display Panel Assembly](#)

[Upper CPU Cover](#)

[Speaker Assembly](#)

[Diskette Drive](#)

[Fan Assembly](#)

[System Board](#)

[Dip Switch Settings](#)

[Memory Module](#)

Removing the Upper CPU Cover

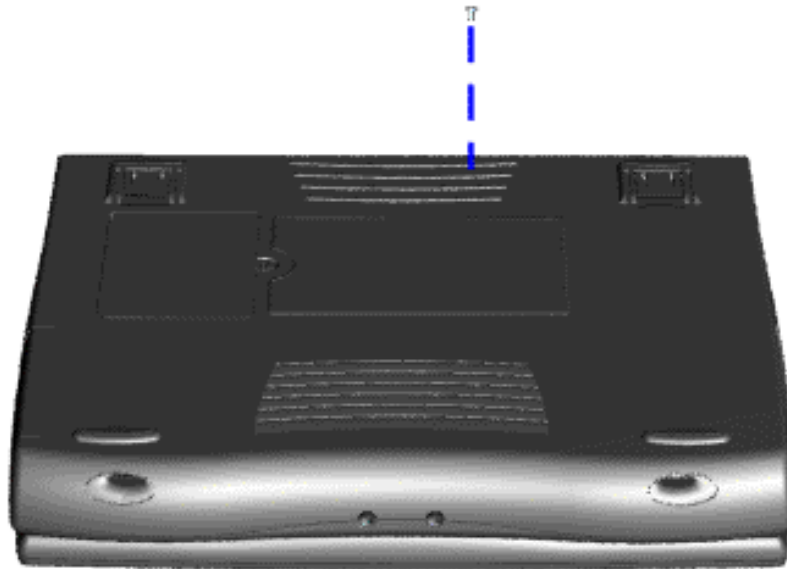

1. Prepare the [computer for disassembly](#).
2. Remove the [palmrest cover with touch pad](#).
3. Remove the [keyboard](#).
4. Remove the [heatspreader](#).
5. Remove the [hard drive](#).
6. Remove the [display panel assembly](#).
7. Remove the screw located under the bottom of the unit (rear) which secures the Upper CPU cover to the chassis.

[Next Step](#)

maintenance & service guide

Presario 1600 Series

Models: 1683, 1685, 1687, 1688, 1690, 1692, 1693, and 1694

Before You Begin	Specifications	Parts Catalog
Removal Sequence	Troubleshooting	Battery Operations
Product Description	Pin Assignments	Index

Removal and Replacement

IMPORTANT:

Prior to conducting any removal and/or replacement procedures, you should review and fully understand the section titled "[Before You Begin](#)".

Removal Sequence

[Cables and Connectors](#)

[Battery Pack](#)

[Palmrest Cover with Touch Pad](#)

[Heatspreader](#)

[Keyboard](#)

[Processor](#)

[Hard Drive](#)

[DVD or CD Drive](#)

[Battery Charger Board](#)

[Modem](#)

[Display Panel Assembly](#)

[Upper CPU Cover](#)

[Speaker Assembly](#)

[Diskette Drive](#)

[Fan Assembly](#)

[System Board](#)

[Dip Switch Settings](#)

[Memory Module](#)

Removing the Upper CPU Cover (steps 8 - 9)

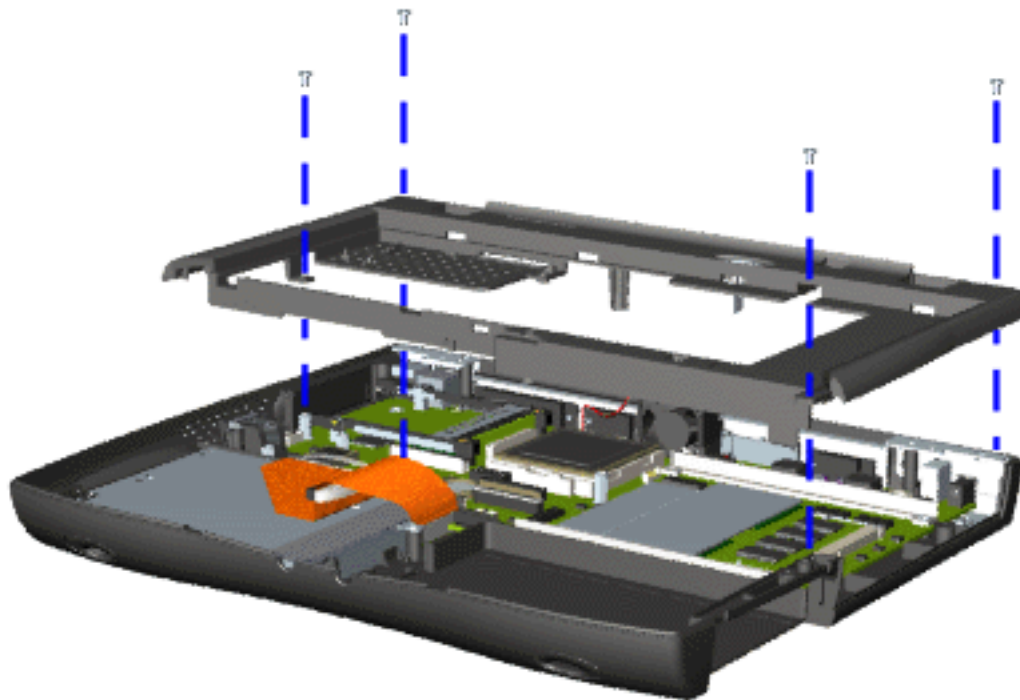

[Previous Step](#)

8. Remove four screws located on the top of the Upper CPU cover.
9. Lift the Upper CPU cover off the snaps on the chassis which will disconnect the power switch from the connector on the system board.

To replace the Upper CPU cover, reverse the previous procedures.

[Return](#)

maintenance & service guide

Presario 1600 Series

Models: 1683, 1685, 1687, 1688, 1690, 1692, 1693, and 1694

Before You Begin	Specifications	Parts Catalog
Removal Sequence	Troubleshooting	Battery Operations
Product Description	Pin Assignments	Index

Removal and Replacement

IMPORTANT: Prior to conducting any removal and/or replacement procedures, you should review and fully understand the section titled "[Before You Begin](#)".

Removing the Speaker Assembly

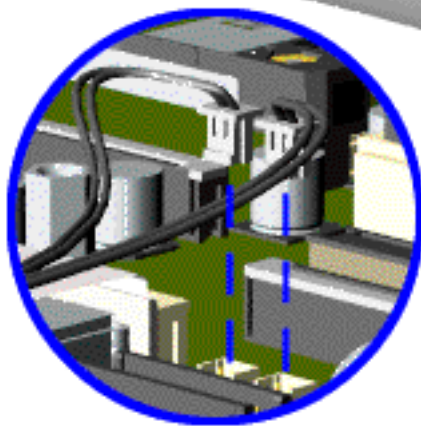
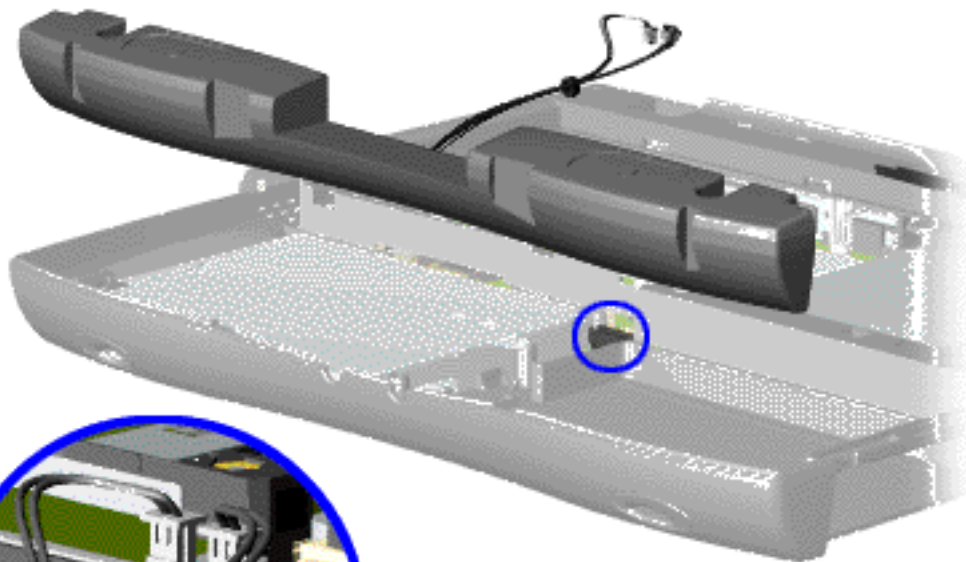

1. Prepare the [computer for disassembly](#).
2. Remove the [palmrest cover with touch pad](#).
3. Remove the [keyboard](#).
4. Remove the [heatsreader](#).
5. Remove the [hard drive](#).
6. Remove the [display panel assembly](#).
7. Remove the [upper CPU cover](#).
8. Remove the [battery charger board](#).
9. Disconnect the speaker cables from the [system board](#) and remove the speaker assembly from the chassis.

To replace the speaker assembly, reverse the previous procedures.

Removal Sequence

[Cables and Connectors](#)

[Battery Pack](#)

[Palmrest Cover with Touch Pad](#)

[Heatsreader](#)

[Keyboard](#)

[Processor](#)

[Hard Drive](#)

[DVD or CD Drive](#)

[Battery Charger Board](#)

[Modem](#)

[Display Panel Assembly](#)

[Upper CPU Cover](#)

[Speaker Assembly](#)

[Diskette Drive](#)

[Fan Assembly](#)

[System Board](#)

[Dip Switch Settings](#)

[Memory Module](#)

maintenance & service guide

Presario 1600 Series

Models: 1683, 1685, 1687, 1688, 1690, 1692, 1693, and 1694

Before You Begin	Specifications	Parts Catalog
Removal Sequence	Troubleshooting	Battery Operations
Product Description	Pin Assignments	Index

Removal and Replacement

IMPORTANT:

Prior to conducting any removal and/or replacement procedures, you should review and fully understand the section titled "[Before You Begin](#)".

Removal Sequence

[Cables and Connectors](#)

[Battery Pack](#)

[Palmrest Cover with Touch Pad](#)

[Heatspreader](#)

[Keyboard](#)

[Processor](#)

[Hard Drive](#)

[DVD or CD Drive](#)

[Battery Charger Board](#)

[Modem](#)

[Display Panel Assembly](#)

[Upper CPU Cover](#)

[Speaker Assembly](#)

Diskette Drive

[Fan Assembly](#)

[System Board](#)

[Dip Switch Settings](#)

[Memory Module](#)

Removing the Diskette Drive

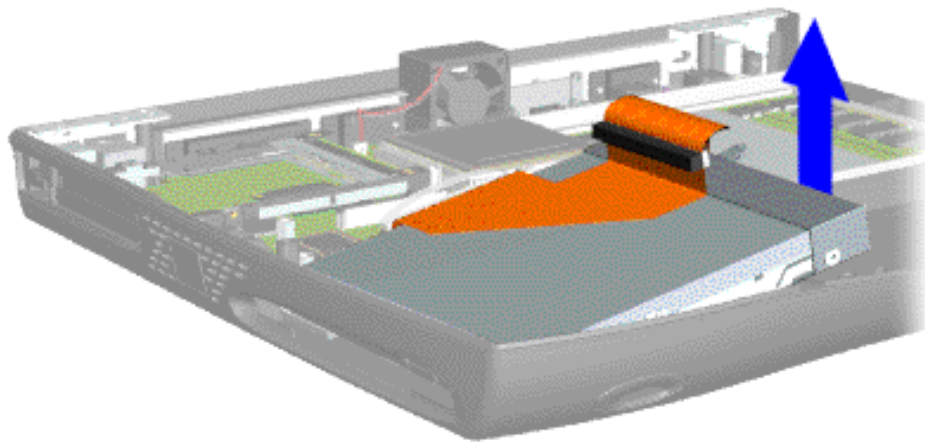

1. Prepare the [computer for disassembly](#).
2. Remove the [palmrest cover with touch pad](#).
3. Remove the [keyboard](#).
4. Remove the [heatspreader](#).
5. Remove the [hard drive](#).
6. Remove the [display panel assembly](#).
7. Remove the [upper CPU cover](#).
8. Remove the [battery charger board](#).
9. Remove the [speaker assembly](#).
10. Disconnect the diskette drive data cable from the system board.

To replace the diskette drive, reverse the previous procedures.

NOTE:

Ensure the diskette drive eject lever is properly inserted in the chassis slot, when replacing the diskette drive.

maintenance & service guide

Presario 1600 Series

Models: 1683, 1685, 1687, 1688, 1690, 1692, 1693, and 1694

Before You Begin	Specifications	Parts Catalog
Removal Sequence	Troubleshooting	Battery Operations
Product Description	Pin Assignments	Index

Removal and Replacement

IMPORTANT:

Prior to conducting any removal and/or replacement procedures, you should review and fully understand the section titled "[Before You Begin](#)".

Fan Assembly

Removal Sequence
Cables and Connectors
Battery Pack
Palmrest Cover with Touch Pad
Heatspreader
Keyboard
Processor
Hard Drive
DVD or CD Drive
Battery Charger Board
Modem
Display Panel Assembly
Upper CPU Cover
Speaker Assembly
Diskette Drive
Fan Assembly
System Board
Dip Switch Settings
Memory Module

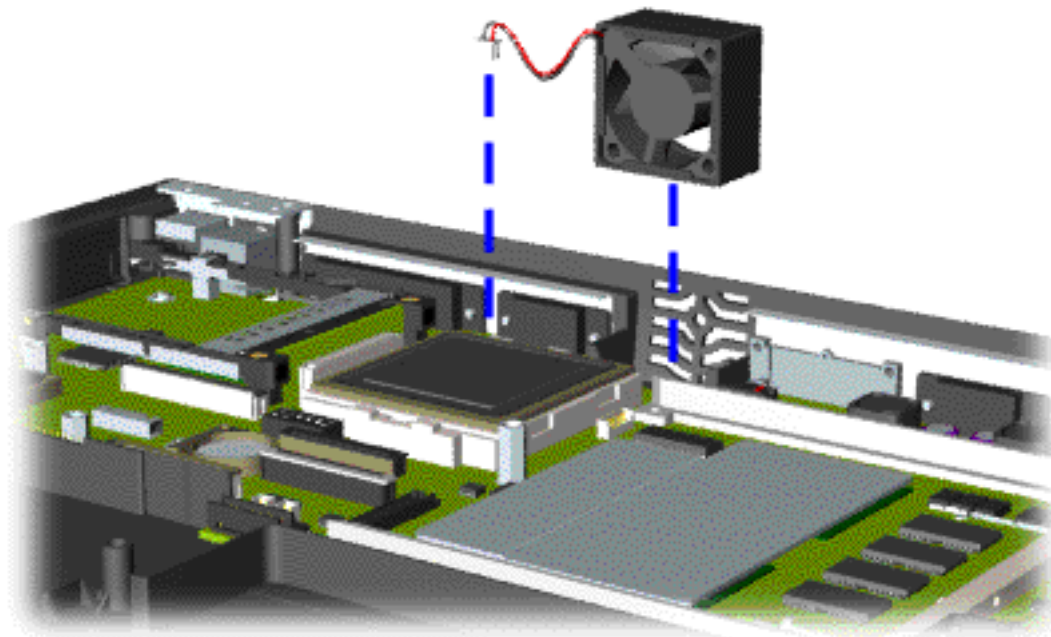

1. Prepare the [computer for disassembly](#).
2. Remove the [palmrest cover with touch pad](#).
3. Remove the [keyboard](#).
4. Remove the [heatspreader](#).
5. Remove the [hard drive](#).
6. Remove the [display panel assembly](#).
7. Remove the [Upper CPU cover](#).
8. Lift the fan assembly from the chassis slot and disconnect the fan cable from the connector on the system board.

[Next Step](#)

maintenance & service guide

Presario 1600 Series

Models: 1683, 1685, 1687, 1688, 1690, 1692, 1693, and 1694

Before You Begin	Specifications	Parts Catalog
Removal Sequence	Troubleshooting	Battery Operations
Product Description	Pin Assignments	Index

Removal and Replacement

IMPORTANT: Prior to conducting any removal and/or replacement procedures, you should review and fully understand the section titled "[Before You Begin](#)".

Fan Assembly

Removal Sequence
Cables and Connectors
Battery Pack
Palmrest Cover with Touch Pad
Heatspreader
Keyboard
Processor
Hard Drive
DVD or CD Drive
Battery Charger Board
Modem
Display Panel Assembly
Upper CPU Cover
Speaker Assembly
Diskette Drive
Fan Assembly
System Board
Dip Switch Settings
Memory Module

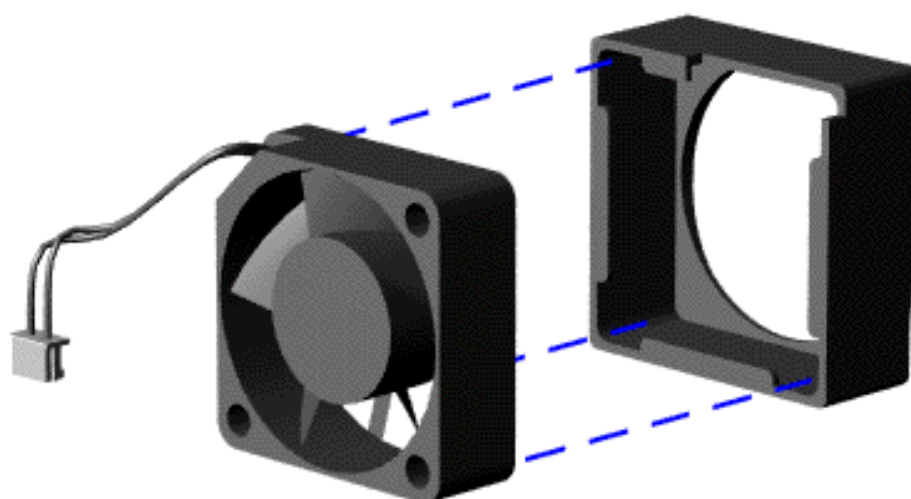

[Previous Steps](#)

9. Pull the gasket from the fan.

IMPORTANT: When replacing the fan assembly ensure the arrow (located on the top of the fan gasket) is pointing inward.

To replace the fan assembly and gasket, reverse the previous procedures.

[Return](#)

maintenance & service guide

Presario 1600 Series

Models: 1683, 1685, 1687, 1688, 1690, 1692, 1693, and 1694

Before You Begin	Specifications	Parts Catalog
Removal Sequence	Troubleshooting	Battery Operations
Product Description	Pin Assignments	Index

Removal and Replacement

IMPORTANT:

Prior to conducting any removal and/or replacement procedures, you should review and fully understand the section titled "[Before You Begin](#)".

Removal Sequence

[Cables and Connectors](#)

[Battery Pack](#)

[Palmrest Cover with Touch Pad](#)

[Heatspreader](#)

[Keyboard](#)

[Processor](#)

[Hard Drive](#)

[DVD or CD Drive](#)

[Battery Charger Board](#)

[Modem](#)

[Display Panel Assembly](#)

[Upper CPU Cover](#)

[Speaker Assembly](#)

[Diskette Drive](#)

[Fan Assembly](#)

System Board

[Dip Switch Settings](#)

[Memory Module](#)

System Board

1. Prepare the [computer for disassembly](#).
2. Remove the [palmrest cover with touch pad](#).
3. Remove the [keyboard](#).
4. Remove the [heatspreader](#).
5. Remove the [processor](#).
6. Remove the [modem](#).
7. Remove the [hard drive](#).
8. Remove the [display panel assembly](#).
9. Remove the [Upper CPU cover](#).
10. Remove the [battery charger board](#).
11. Remove the [speaker assembly](#).
12. Remove the [diskette drive](#).
13. Remove the [CD or DVD drive](#).
14. Remove the [fan assembly](#).

IMPORTANT:

When replacing the system board remove the memory module on the system board.

[Next Step](#)

maintenance & service guide

Presario 1600 Series

Models: 1683, 1685, 1687, 1688, 1690, 1692, 1693, and 1694

Before You Begin	Specifications	Parts Catalog
Removal Sequence	Troubleshooting	Battery Operations
Product Description	Pin Assignments	Index

Removal and Replacement

IMPORTANT:

Prior to conducting any removal and/or replacement procedures, you should review and fully understand the section titled "[Before You Begin](#)".

Removal Sequence

[Cables and Connectors](#)

[Battery Pack](#)

[Palmrest Cover with Touch Pad](#)

[Heatspreader](#)

[Keyboard](#)

[Processor](#)

[Hard Drive](#)

[DVD or CD Drive](#)

[Battery Charger Board](#)

[Modem](#)

[Display Panel Assembly](#)

[Upper CPU Cover](#)

[Speaker Assembly](#)

[Diskette Drive](#)

[Fan Assembly](#)

System Board

[Dip Switch Settings](#)

[Memory Module](#)

Removing the System Board (step 15)

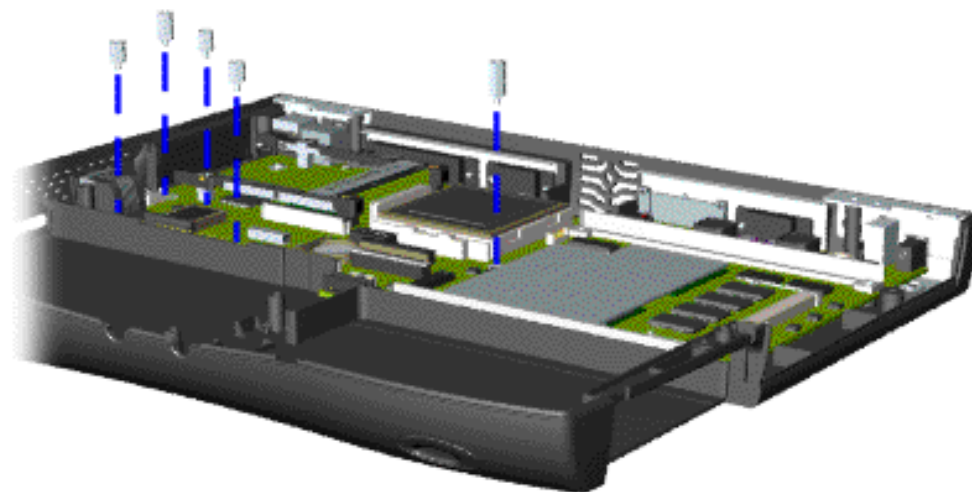

[Previous Steps](#)

15. Remove five standoffs from the system board.

[Next Step](#)

maintenance & service guide

Presario 1600 Series

Models: 1683, 1685, 1687, 1688, 1690, 1692, 1693, and 1694

Before You Begin	Specifications	Parts Catalog
Removal Sequence	Troubleshooting	Battery Operations
Product Description	Pin Assignments	Index

Removal and Replacement

IMPORTANT:

Prior to conducting any removal and/or replacement procedures, you should review and fully understand the section titled "[Before You Begin](#)".

Removal Sequence

[Cables and Connectors](#)

[Battery Pack](#)

[Palmrest Cover with Touch Pad](#)

[Heatspreader](#)

[Keyboard](#)

[Processor](#)

[Hard Drive](#)

[DVD or CD Drive](#)

[Battery Charger Board](#)

[Modem](#)

[Display Panel Assembly](#)

[Upper CPU Cover](#)

[Speaker Assembly](#)

[Diskette Drive](#)

[Fan Assembly](#)

System Board

[Dip Switch Settings](#)

[Memory Module](#)

Removing the System Board (step 16)

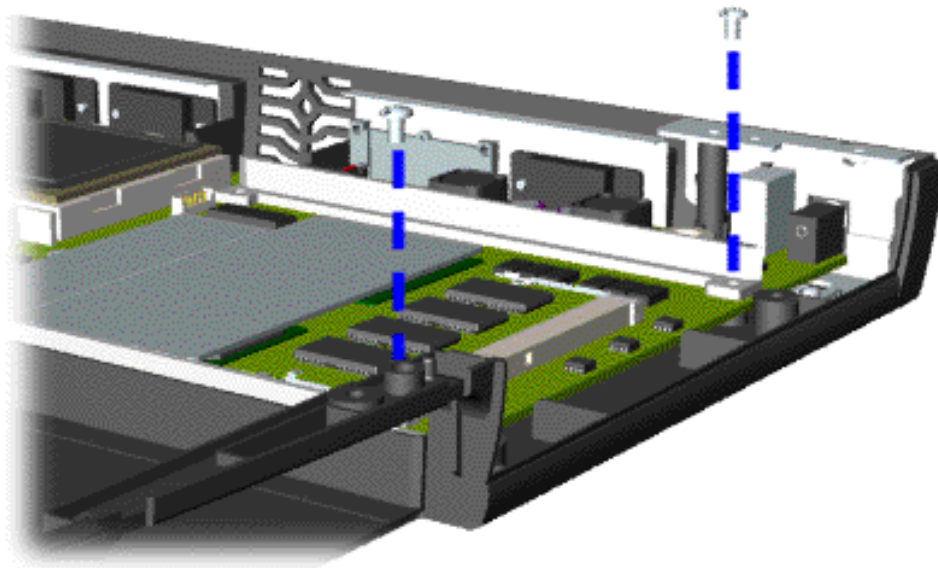

[Previous Step](#)

16. Remove two screws from the DVD or CD Drive mounting rails and remove the mounting rails from the system board.

[Next Step](#)

maintenance & service guide

Presario 1600 Series

Models: 1683, 1685, 1687, 1688, 1690, 1692, 1693, and 1694

Before You Begin	Specifications	Parts Catalog
Removal Sequence	Troubleshooting	Battery Operations
Product Description	Pin Assignments	Index

Removal and Replacement

IMPORTANT: Prior to conducting any removal and/or replacement procedures, you should review and fully understand the section titled "[Before You Begin](#)".

Removal Sequence

[Cables and Connectors](#)

[Battery Pack](#)

[Palmrest Cover with Touch Pad](#)

[Heatspreader](#)

[Keyboard](#)

[Processor](#)

[Hard Drive](#)

[DVD or CD Drive](#)

[Battery Charger Board](#)

[Modem](#)

[Display Panel Assembly](#)

[Upper CPU Cover](#)

[Speaker Assembly](#)

[Diskette Drive](#)

[Fan Assembly](#)

System Board

[Dip Switch Settings](#)

[Memory Module](#)

Removing the System Board (step 17)

[Previous Step](#)

17. Remove three screws from the system board.

[Next Step](#)

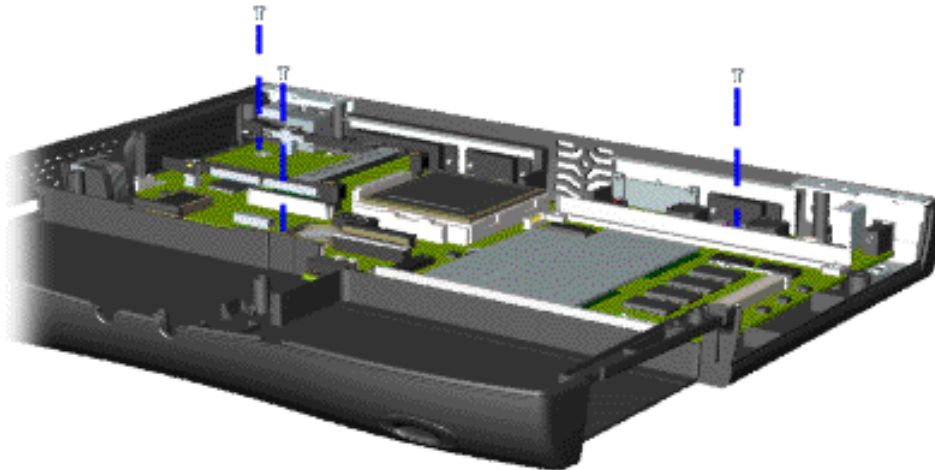

maintenance & service guide

Presario 1600 Series

Models: 1683, 1685, 1687, 1688, 1690, 1692, 1693, and 1694

Before You Begin	Specifications	Parts Catalog
Removal Sequence	Troubleshooting	Battery Operations
Product Description	Pin Assignments	Index

Removal and Replacement

IMPORTANT:

Prior to conducting any removal and/or replacement procedures, you should review and fully understand the section titled "[Before You Begin](#)".

Removal Sequence

[Cables and Connectors](#)

[Battery Pack](#)

[Palmrest Cover with Touch Pad](#)

[Heatspreader](#)

[Keyboard](#)

[Processor](#)

[Hard Drive](#)

[DVD or CD Drive](#)

[Battery Charger Board](#)

[Modem](#)

[Display Panel Assembly](#)

[Upper CPU Cover](#)

[Speaker Assembly](#)

[Diskette Drive](#)

[Fan Assembly](#)

System Board

[Dip Switch Settings](#)

[Memory Module](#)

Removing the System Board (step 18)

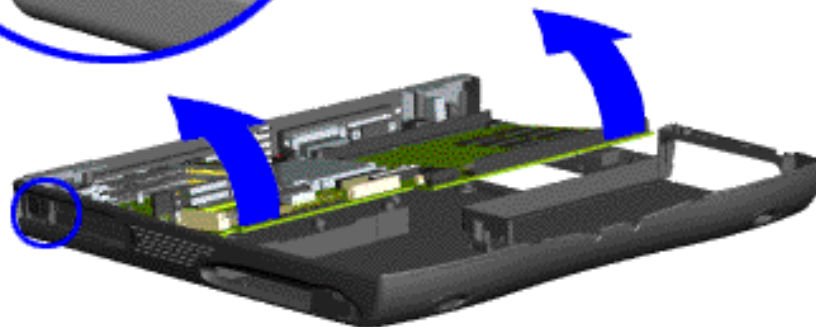
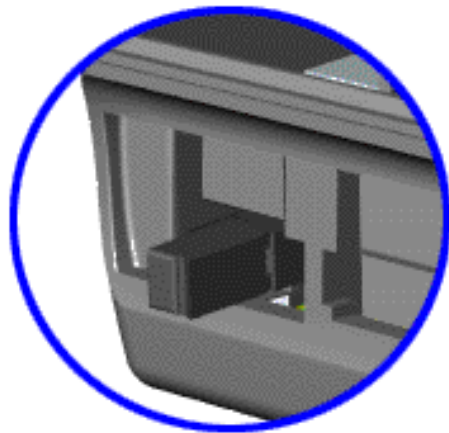

[Previous Step](#)

18. Pull the PCMCIA eject lever out (straight), lift up the right side of the system board and pull forward to remove the system board from the chassis.

To replace the system board, reverse the previous procedures.

IMPORTANT:

Remove all cables from the system board.

[Dip Switch System Board Settings](#)

[Return](#)

maintenance & service guide

Presario 1600 Series

Models: 1683, 1685, 1687, 1688, 1690, 1692, 1693, and 1694

Before You Begin	Specifications	Parts Catalog
Removal Sequence	Troubleshooting	Battery Operations
Product Description	Pin Assignments	Index

Removal and Replacement

IMPORTANT: Prior to conducting any removal and/or replacement procedures, you should review and fully understand the section titled "[Before You Begin](#)".

Removal Sequence
Cables and Connectors
Battery Pack
Palmrest Cover with Touch Pad
Heatspreader
Keyboard
Processor
Hard Drive
DVD or CD Drive
Battery Charger Board
Modem
Display Panel Assembly
Upper CPU Cover
Speaker Assembly
Diskette Drive
Fan Assembly
System Board
Dip Switch Settings
Memory Module

Dip Switch Settings

[Click here for more dip switch settings.](#)

CAUTION: Only change settings 1-5 on SW1 **1**. Settings 6-10 vary by model and should not be changed when replacing the system board. Ensure the dip switch voltage settings (SW1 **1** and SW3 **3**) on the system board are correct for the computer model and processor voltage marked on the processor chip. If the system board dip switch voltage settings are not correct, damage may occur to the computer and/or system board.

NOTE: The black area on the dip switch indicates the position of the switch.

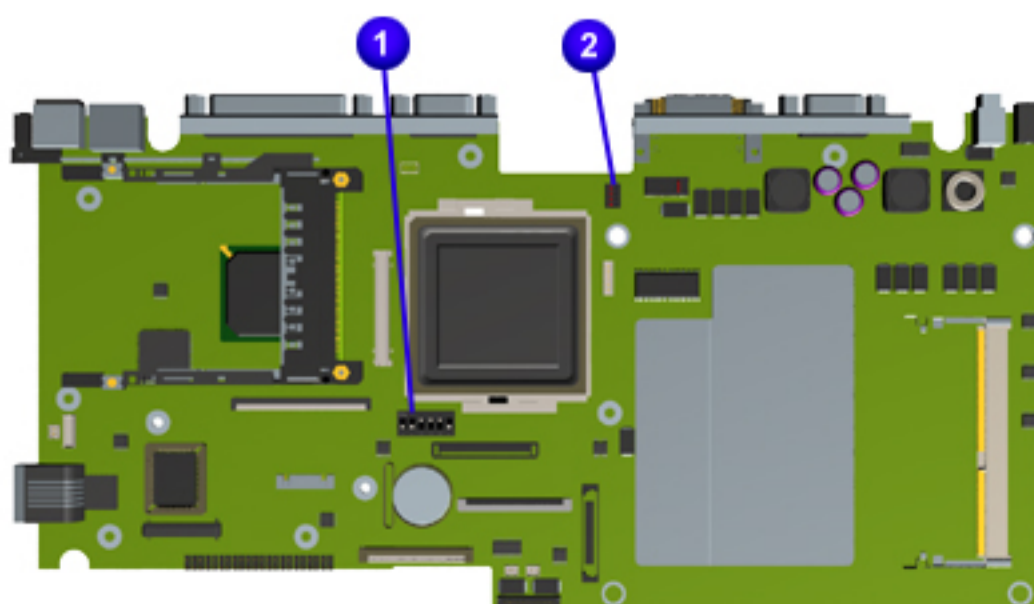
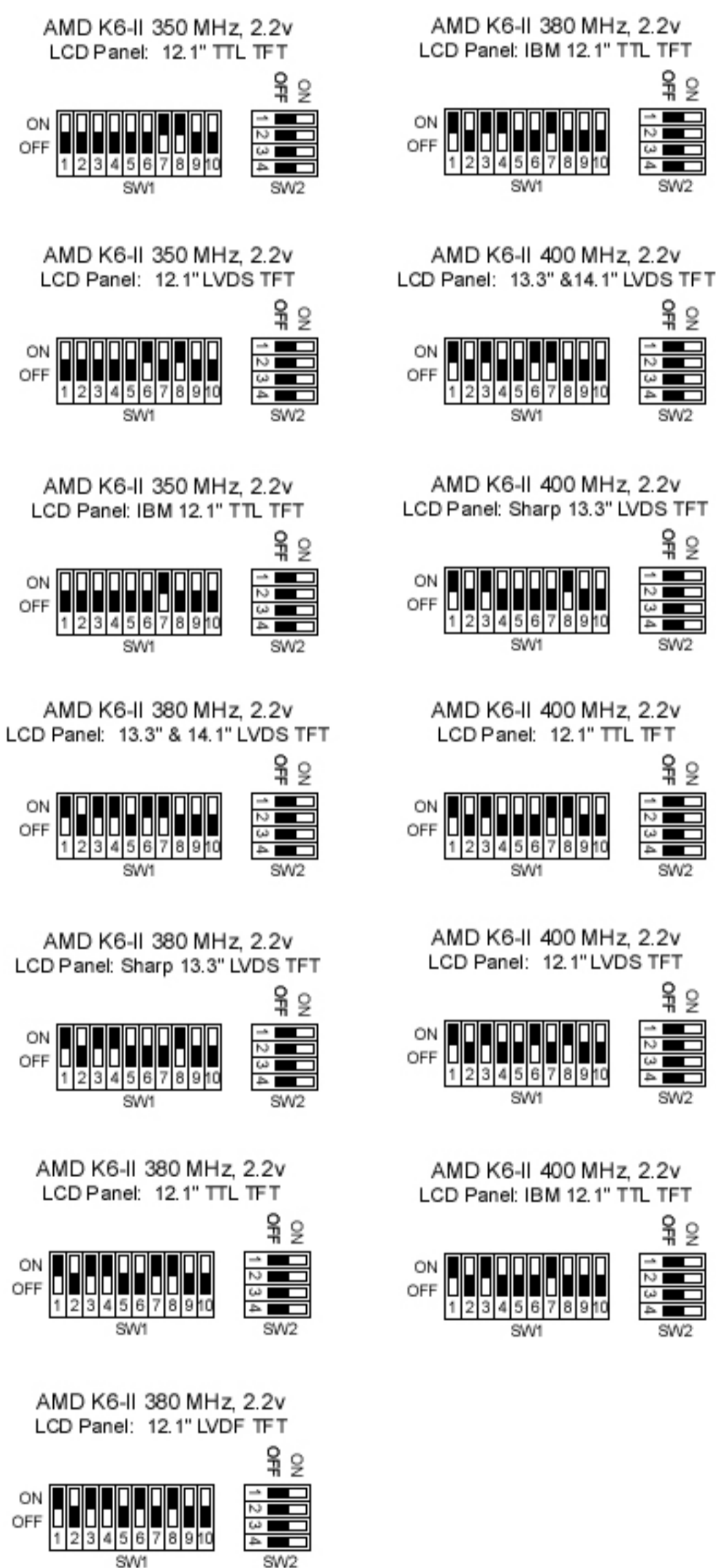

maintenance & service guide

Presario 1600 Series

Models: 1683, 1685, 1687, 1688, 1690, 1692, 1693, and 1694

Before You Begin	Specifications	Parts Catalog
Removal Sequence	Troubleshooting	Battery Operations
Product Description	Pin Assignments	Index

Removal and Replacement

IMPORTANT: Prior to conducting any removal and/or replacement procedures, you should review and fully understand the section titled "[Before You Begin](#)".

Removal Sequence
Cables and Connectors
Battery Pack
Palmrest Cover with Touch Pad
Heatspreader
Keyboard
Processor
Hard Drive
DVD or CD Drive
Battery Charger Board
Modem
Display Panel Assembly
Upper CPU Cover
Network Interface Card
Speaker Assembly
Diskette Drive
Fan Assembly
System Board
Dip Switch Settings
Memory Module

Dip Switch Settings

[Click here for more dip switch settings.](#)

CAUTION: Only change settings 1-5 on SW1 ¹. Settings 6-10 vary by model and should not be changed when replacing the system board. Ensure the dip switch voltage settings (SW1 ¹ and SW3 ³) on the system board are correct for the computer model and processor voltage marked on the processor chip. If the system board dip switch voltage settings are not correct, damage may occur to the computer and/or system board.

NOTE: The black area on the dip switch indicates the position of the switch.

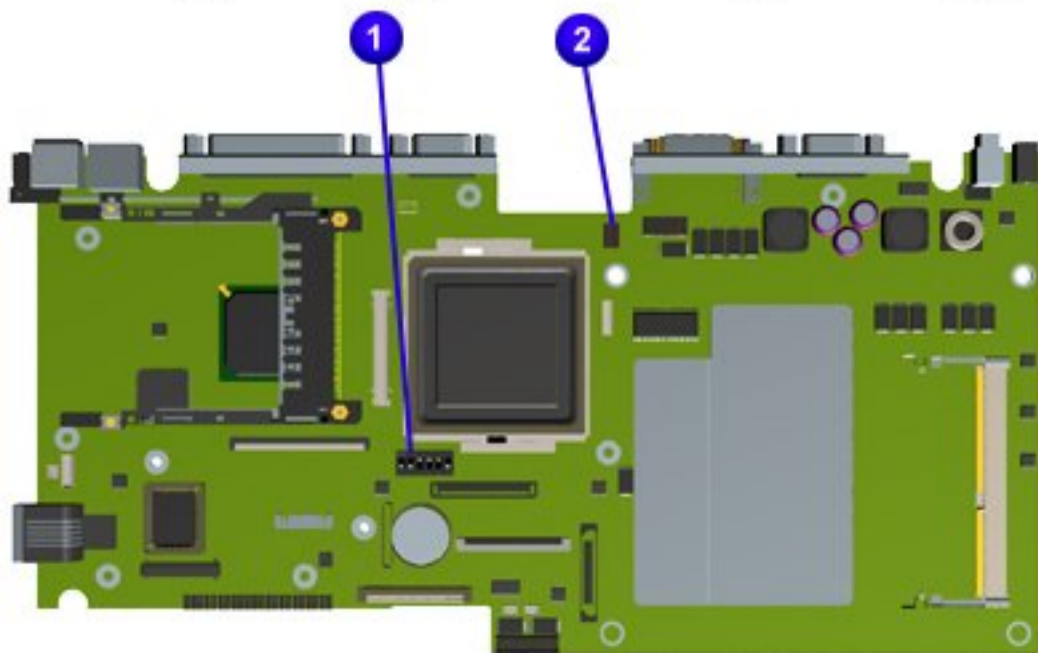
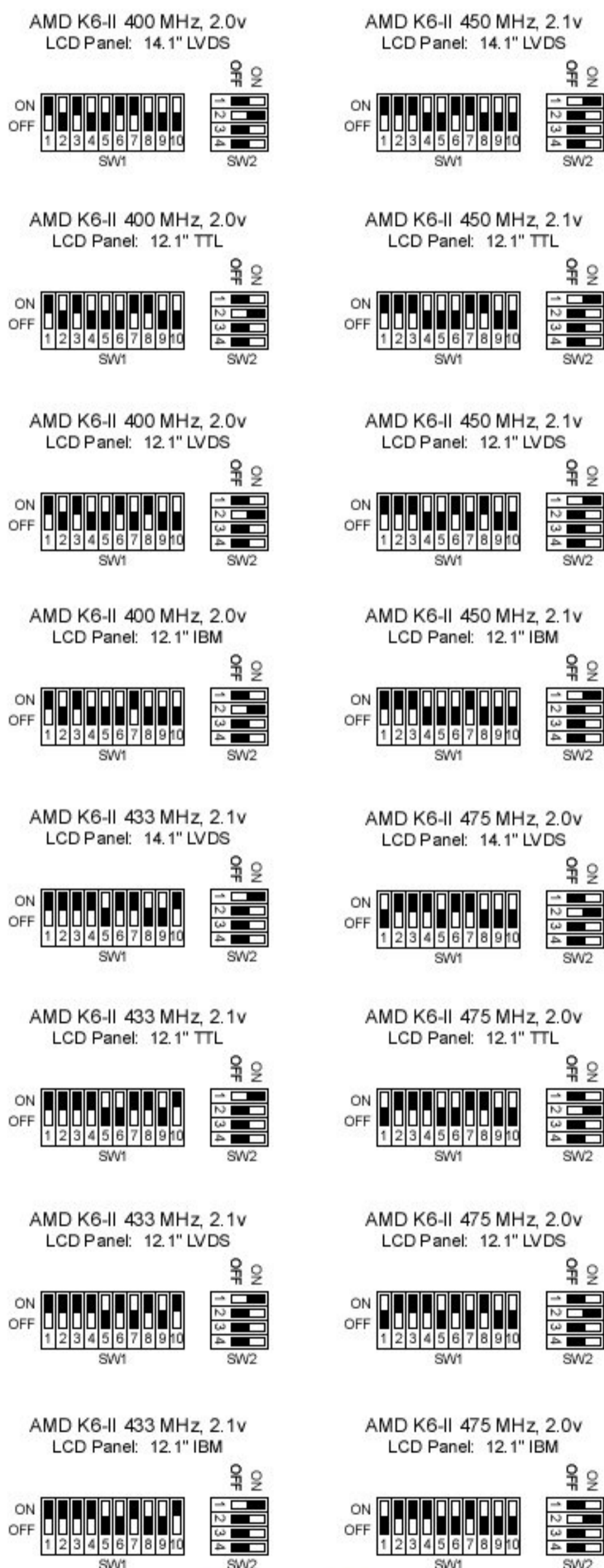

maintenance & service guide

Presario 1600 Series

Models: 1683, 1685, 1687, 1688, 1690, 1692, 1693, and 1694

Before You Begin	Specifications	Parts Catalog
Removal Sequence	Troubleshooting	Battery Operations
Product Description	Pin Assignments	Index

Removal and Replacement

IMPORTANT: Prior to conducting any removal and/or replacement procedures, you should review and fully understand the section titled "[Before You Begin](#)".

Memory Module

Removal Sequence
Cables and Connectors
Battery Pack
Palmrest Cover with Touch Pad
Heatspreader
Keyboard
Processor
Hard Drive
DVD or CD Drive
Battery Charger Board
Modem
Display Panel Assembly
Upper CPU Cover
Speaker Assembly
Diskette Drive
Fan Assembly
System Board
Dip Switch Settings
Memory Module

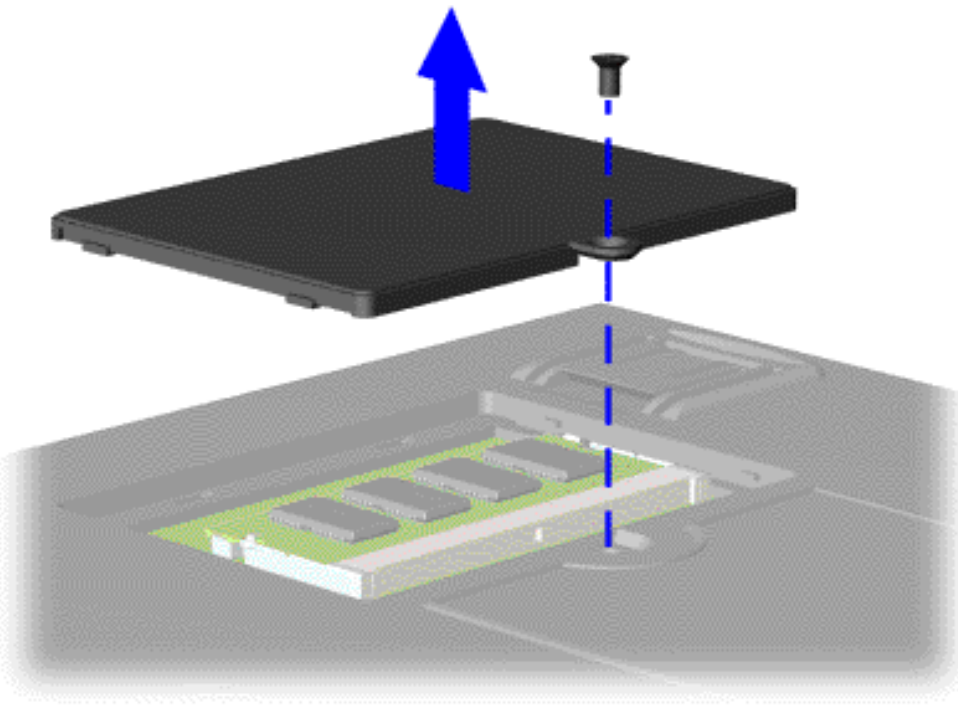

To remove the memory module, complete the following steps:

1. Prepare the [computer for disassembly](#).
2. Close the computer and turn the computer upside down.
3. Remove the screw from the memory module door, and slide the memory module door to the right.

[Next Step](#)

maintenance & service guide

Presario 1600 Series

Models: 1683, 1685, 1687, 1688, 1690, 1692, 1693, and 1694

Before You Begin	Specifications	Parts Catalog
Removal Sequence	Troubleshooting	Battery Operations
Product Description	Pin Assignments	Index

Removal and Replacement

IMPORTANT: Prior to conducting any removal and/or replacement procedures, you should review and fully understand the section titled "[Before You Begin](#)".

Removal Sequence
Cables and Connectors
Battery Pack
Palmrest Cover with Touch Pad
Heatspreader
Keyboard
Processor
Hard Drive
DVD or CD Drive
Battery Charger Board
Modem
Display Panel Assembly
Upper CPU Cover
Speaker Assembly
Diskette Drive
Fan Assembly
System Board
Dip Switch Settings
Memory Module

Removing the Memory Module (step 4)

[Previous Steps](#)

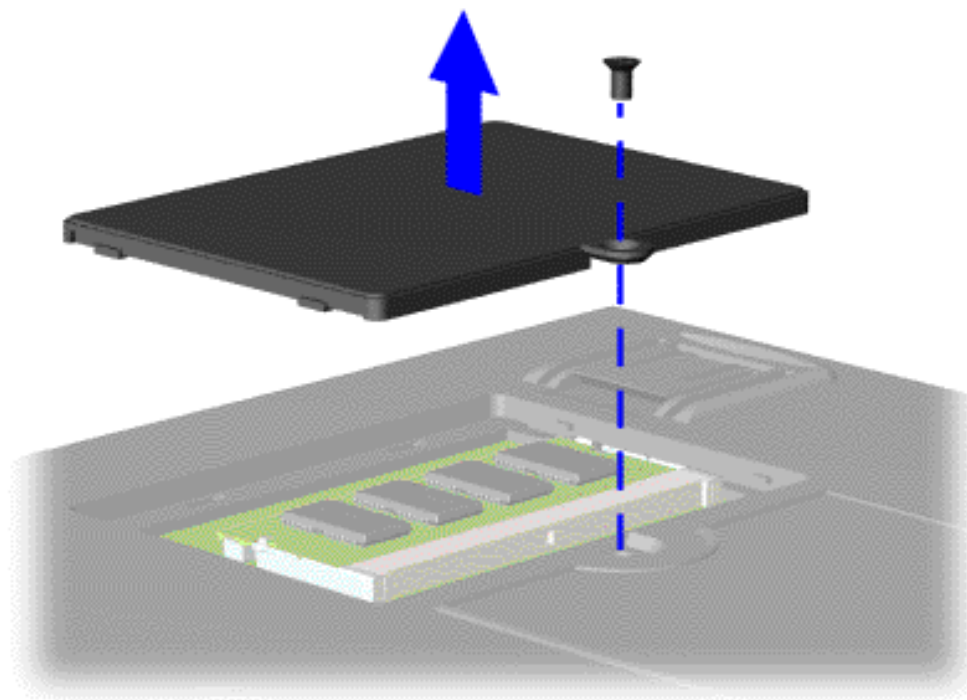

4. Pull side levers to release the memory module and unplug the memory module from the system board.

To replace the memory module, reverse the previous procedures.

[Return](#)

maintenance & service guide

Presario 1600 Series

Models: 1683, 1685, 1687, 1688, 1690, 1692, 1693, and 1694

Before You Begin	Specifications	Parts Catalog
Removal Sequence	Troubleshooting	Battery Operations
Product Description	Pin Assignments	Index

Preliminary Steps

[Clearing the Power-On Password](#)

[Power-On Self Test \(POST\)](#)

[Compaq Diagnostics](#)

[Diagnostic Error Codes](#)

[Solving Minor Problems](#)

[Contacting Compaq Support](#)

Preliminary Steps

This section covers troubleshooting information for the Compaq Presario Series Portable Computers. The basic steps in troubleshooting include:

1. Follow the [Preliminary Steps](#).
2. Run the [Power-On Self-Test](#) (POST).
3. Follow the recommended actions described in the diagnostic tables, if you are unable to run POST or if POST displays an error message.

When following the recommended actions in the Sections on [POST](#) and [Diagnostic Error Codes](#) perform them in the order listed. Rerun POST after each recommended action until the problem is solved and no error message occurs. Once the problem is solved, do not complete the remaining recommended actions.

Note:

If the problem is intermittent, check the computer several times to verify that the problem is solved.

maintenance & service guide

Presario 1600 Series

Models: 1683, 1685, 1687, 1688, 1690, 1692, 1693, and 1694

Before You Begin	Specifications	Parts Catalog
Removal Sequence	Troubleshooting	Battery Operations
Product Description	Pin Assignments	Index

Preliminary Steps
Clearing the Power-On Password
Power-On Self Test (POST)
Compaq Diagnostics
Diagnostic Error Codes
Solving Minor Problems
Contacting Compaq Support

Running POST

To run POST, complete the following steps:

- Turn off the computer, then turn on the computer.
- If POST does not detect any errors, the computer will not beep. This indicates successful completion of POST test. POST has run successfully and boots from the hard drive (or from a bootable diskette if one is installed in the diskette drive).
- If POST detects errors, the errors are indicated by screen and/or audible messages. Refer to "Power-On Self-Test (POST) Codes" in the tables for a list of POST codes and their relevant descriptions.

NOTE: If the system is not functioning well enough to run POST, or if the display is not functioning well enough to show POST error messages, refer to the Troubleshooting tables.

NOTE: The following routines are sorted by their test point numbers assigned in the BIOS code. Their actual orders as executed during POST can be quite different.

Code	Beeps	POST Routine Description
02h		Verify Real Mode
03h		Disable Non-Maskable Interrupt (NM)
04h		Get CPU type
06h		Initialize system hardware
08h		Initialize chipset with Initial POST values
09h		Set IN POST flag
0Ah		Initialize CPU registers
0Bh		Enable CPU cache
0Ch		Initialize caches to initial POST values
0Eh		Initialize I/O component
0Fh		Initialize the local bus IDE
10h		Initialize Power Management
11h		Load alternate registers with initial POST values
12h		Restore CPU control word during warm boot
13h		Initialize PCI Bus Mastering devices
14h		Initialize keyboard controller
16h	1-2-2-3	BIOS ROM Checksum
17h		Initialize cache before memory autosize
18h		8254 timer initialization
1Ah		8237 DMA controller initialization
1Ch		Reset Programmable Interrupt Controller
20h	1-3-1-1	Test DRAM refresh
22h	1-3-1-3	Test 8742 Keyboard Controller
24h		Set ES segment register to 4 GB
26h		Enable A20 line
28h		Autosize DRAM
29h		Initialize POST Memory Manager
2Ah		Clear 512 KB base RAM
2Ch	1-3-4-2	RAM failure on address line xxxx*
2Eh	1-3-4-3	RAM failure on data bits xxxx* of low byte of memory bus
2Fh		Enable cache before system BIOS shadow
30th	1-4-1-1	RAM failure on data bits xxxx* of high byte memory bus
32h		Test CPU bus-clock frequency
33h		Initialize Phoenix Dispatch Manager
36h		Warm start shut down
38h		Shadow system BIOS ROM
3Ah		Autosize cache
3Ch		Advanced configuration of chipset registers
3Dh		Load alternate registers with CMOS values
42h		Initialize interrupt vectors
45h		POST device initialization
46h	2-1-2-3	Check ROM copyright notice
48h		Check Video configuration against CMOS
49h		Initialize PCI bus and devices
4Ah		Initialize all video adapters in system
4Bh		QuietBoot start (optional)
4Ch		Shadow video BIOS ROM
4Eh		Display BIOS copyright notice
50Eh		Display CPU type and speed
51h		Initialize EISA board
52h		Test keyboard
54h		Set key click if enabled
58h	2-2-3-1	Test for unexpected interrupts
59h		Initialize POST display service
5Ah		Display prompt "Press F2 to enter SetUP"
5Bh		Disable CPU cache
5Ch		Test RAM between 512 and 640 KB
60h		Test extended memory
62h		Test extended memory address lines
64h		Jump to UserPatchI
66h		Configure advanced cache registers
67h		Initialize Multi Processor APIC
68h		Enable external and CPU cache
69h		Setup System Management Mode (SMM) area
6Ah		Display external L2 cache size
6Bh		Load custom defaults (optional)
6Ch		Display shadow-area message
6Eh		Display possible high address for UMB recovery
70h		Display error messages
72h		Check for configuration errors
76h		Check for keyboard errors
7Ch		Set up hardware interrupt vectors
7Eh		Initialize coprocessor if present
80h		Disable onboard Super I/O ports and IRQs
81h		Late POST device initialization
82h		Detect and install external RS232 ports
83h		Configure non-MCD IDE controllers
84h		Detect and install external parallel ports
85h		Initialize PC-compatible PnP ISA devices
86h		Reinitialize onboard I/O ports
87h		Configure Motherboard Configurable Devices (optional)
88h		Initialize BIOS Data Area
89h		Enable Non-Maskable Interrupts (NMIs)
8Ah		Initialize Extended BIOS Data Area
8Bh		Test and initialize PS/2 mouse
8Ch		Initialize floppy controller
81h		Determine number of ATA drives (optional)
90h		Initialize hard disk controllers
91h		Initialize local-bus hard disk controllers
92h		Jump to UserPatch2
93h		Build MPTABLE for multi-processor boards
95h		Install CD ROM for boot
96h		Clear huge ES segment register
97h		Fixup Multi Processor table
98h	1-2	Search for option ROMs. One long, two short beeps on checksum failure
99h		Check for SMART drive (optional)
9Ah		Shadow option ROMs
9Ch		Set up Power Management
9Dh		Initialize security engine (optional)
9Eh		Enable hardware interrupts
9Fh		Determine number of ATA and SCSI drives
A0h		Set time of day
A2h		Check key lock
A4h		Initialize Typematic rate
A8h		Erase F2 prompt
AAh		Scan for F2 key stroke
ACh		Enter Setup
A Eh		Clear Boot flag
B0h		Check for errors
B2h		POST done - prepare to boot operating system
B4h	1	One shot beep before boot
B5h		Terminate QuietBoot (optional)
B6h		Check password (optional)
B9h		Prepare Boot
BAh		Initialize DMI Parameters
BBh		Initialize PnP Option ROMs
BCh		Clear parity checkers
BDh		Display MultiBoot menu
BEh		Clear screen (optional)
BFh		check virus and back up reminders
C0h		Try to boot with INT 19
C1h		Initialize POST Error Manager (PEM)
C2h		Initialize error logging
C3h		Initialize error display function
C4h		Initialize system error handler
C5h		PnPnd dual CMOS (optional)
C6h		Initialize notebook docking (optional)
C7h		Initialize notebook docking late
C8h		Force check (optional)
C9h		Extended checksum (optional)
D2h		Unknown interrupts

Code	Beeps	For Boost Block in Flash ROM
E0h		Initialize the chipset
E1h		Initialize the bridge
E2h		Initialize the CPU
E3h		Initialize system timer
E4h		Initialize system I/O
E5h		Check force recovery boot
E6h		Checksum BIOS ROM
E7h		Go to BIOS
E8h		Set Huge Segment
E9h		Initialize Multi Processor
EAh		Initialize OEM Special code
EBh		Initialize PIC and DMA
ECh		Initialize Memory type
EDh		Initialize Memory size
EEh		Shadow Boot Block
EFh		System memory test
F0h		Initialize interrupts vectors
F1h		Initialize Run Time Clock
F2h		Initialize Video
F3h		Initialize beeper
F4h		Initialize boot
F5h		Clear Huge segment
F6h		Boot to Mini DOS
F7h		Boot to Full DOS

maintenance & service guide

Presario 1600 Series

Models: 1683, 1685, 1687, 1688, 1690, 1692, 1693, and 1694

Before You Begin	Specifications	Parts Catalog
Removal Sequence	Troubleshooting	Battery Operations
Product Description	Pin Assignments	Index

Preliminary Steps
Clearing the Power-On Password
Power-On Test (POST)
Compaq Diagnostics
Diagnostic Error Codes
Solving Minor Problems
Contacting Compaq Support

Compaq Diagnostics

Compaq Diagnostics is installed on the hard drive of the computer. Run the Diagnostics utilities when you want to view or test system information and if you have installed or connected devices.

If you run Compaq Diagnostics from a diskette, ensure that it is version 10.11 or later.

The Diagnostics menu includes the following utilities:

- [Computer Checkup \(TEST\)](#)
- [View System Information \(INSPECT\)](#)
- [Prepare Computer for a Compaq Service Call \(RemotePaq\)](#)

If you have a problem you cannot solve, run the Diagnostics utilities before you call for support. Run Computer Checkup and select to save the device list to a file and to print or to save the log of errors. Run the View System Information (INSPECT) utility and select to print or to save that information. Have the files or the printed information available when you call for support.

Computer Checkup (TEST)

Computer Checkup (TEST) determines whether the various computer components and devices are recognized by the system and are functioning properly. You can display, print, or save the information generated by Computer Checkup.

Follow these steps to run Computer Checkup:

1. Plug the computer into an external power source. (A low battery condition could interrupt the program.)
2. Turn on the external devices that you want to test. Connect the printer if you want to print a log of error messages.
3. Insert the Compaq Diagnostics diskette in drive A.
4. Turn on or restart the computer. The computer starts from drive A, and the **Diagnostics Welcome** screen appears.
5. Press **Enter** to continue. The **Diagnostics** menu appears.
6. Select Computer Checkup from the **Diagnostics** menu. A **Test Option** menu appears.
7. Select **View the Device List** from the **Test Option** menu. A list of the installed Compaq devices appears.
8. If the list of installed devices is correct, select **OK**. The **Test Option** menu appears.

NOTE: If the list is incorrect, ensure that any new devices are installed properly.

9. Select one of the following from the **Test Option** menu:
 - Quick Check Diagnostics. Runs a quick, general test on each device with a minimal number of prompts. If errors occur, they display when the testing is complete. You cannot print or save the error messages.
 - Automatic Diagnostics. Runs unattended, maximum testing of each device with minimal prompts. You can choose how many times to run the tests, to stop on errors, or to print or save a log of errors.
 - Prompted Diagnostics. Allows maximum control over testing the devices. You can choose attended or unattended testing, decide to stop on errors, or choose to print or save a log of errors.
10. Follow the instructions on the screen as the devices are tested. When testing is complete, the **Test Option** menu appears.
11. Exit the **Test Option** menu.
12. Exit the **Diagnostics** menu.

[Top of Page](#)

View System Information (INSPECT)

The View System Information (INSPECT) utility provides information about the computer and installed or connected devices. You can display, print, or save the information.

Follow these steps to run View System Information (INSPECT) from the Compaq Diagnostics diskette:

1. Turn on the external devices that you want to test. Connect the printer if you want to print the information.
2. The Compaq Diskette diskette is **Not Available**.
3. Turn on or restart the computer. The computer starts from drive A, and the **Diagnostics Welcome** screen appears.
4. Press **Enter** to continue. The Diagnostics menu appears.
5. Select **View System Information (INSPECT)** from the **Diagnostics** menu.
6. From the **Diagnostics** Menu, select the item you want to view from the following list:

System	Memory
ROM	Audio
Keyboard	Operating system
System ports	System files
System storage	Windows files
Graphics	

7. Follow the instructions on the screen to cycle through the screens, to return to the list and choose another item, or to print the information.

[Top of Page](#)

maintenance & service guide

Presario 1600 Series

Models: 1683, 1685, 1687, 1688, 1690, 1692, 1693, and 1694

Before You Begin	Specifications	Parts Catalog
Removal Sequence	Troubleshooting	Battery Operations
Product Description	Pin Assignments	Index

[Preliminary Steps](#)

[Clearing the Power-On Password](#)

[Power-On Test \(POST\)](#)

[Compaq Diagnostics](#)

[Diagnostic Error Codes](#)

[Solving Minor Problems](#)

Contacting Compaq Support

Contacting Compaq Support

Obtain the following information before contacting Compaq Reseller Support:

- Product name
- Product serial number
- Purchase date
- Conditions under which the problem occurred
- Any error messages that have occurred
- Hardware configuration
- Type of printer connected
- Hardware/software being used
- Printed result of Computer Checkup (TEST)
- Printed copies of *CONFIG.SYS* and *AUTOEXEC.BAT* files, if possible

Shipping Preparation

To ship the computer, complete the following steps:

1. Back up the critical hard drive files. Ensure that backup tapes/diskette are not exposed to electrical or magnetic fields while stored in transit.
2. Turn off the computer and external devices.
3. Disconnect the external devices from their power sources, then from the computer.

IMPORTANT:

Ensure that there is no diskette in the diskette drive and that there are no PC Cards in the PC slots.

4. Close the display and all exterior doors of the computer.
5. Pack the computer with sufficient packing material to protect it. Use the original packing box or similar packaging.

maintenance & service guide

Presario 1600 Series

Models: 1683, 1685, 1687, 1688, 1690, 1692, 1693, and 1694

Before You Begin	Specifications	Parts Catalog
Removal Sequence	Troubleshooting	Battery Operations
Product Description	Pin Assignments	Index

Preliminary Steps
Clearing the Power-On Password
Power-On Test (POST)
Compaq Diagnostics
Diagnostic Error Codes
Solving Minor Problems
Contacting Compaq Support

Diagnostic Error Codes

Diagnostic error codes occur if the system recognizes a problem while running the Compaq Diagnostic program. These error codes help identify possibly defective subassemblies.

The following tables list error codes, a description of the error condition, and the action required to resolve the error condition.

IMPORTANT: Retest the system after completing each step. If the problem has been resolved, do not proceed with the remaining steps.

For the removal and replacement of a particular subassembly, see [Removal and Replacement Procedures](#).

Select error codes by number or type:

101 through 114	Processor Test
200 through 215	Memory Test
300 through 304	Keyboard Test
401 through 403	Parallel Printer Test
600 through 699	Diskette Drive Test
1101	Serial Test
1701 through 1736	Hard Drive Test
501 through 516	Video Test
2402 through 2456	Audio Test
2458 through 2480	Touch Pad Pointing Device Test
3206	CD Test
3301 through 6623	
8601 through 8602	

Processor Test Error Codes		
Error Code	Description	Recommended Action
101-xx	CPU test failed	Replace the processor and retest.
102-xx	Coprocessor or Weitek Error	<ol style="list-style-type: none"> 1. Run the Configuration and Diagnostics Utilities. 2. Replace the processor board and retest.
103-xx	DMA page registers test failed	Replace the system board and retest.
104-xx	Interrupt controller master test failed	
105-xx	Port 61 error	
106-xx	Keyboard controller self-test failed	
107-xx	CMOS RAM test failed	
108-xx	CMOS interrupt test failed	
109-xx	CMOS clock test failed	
110-xx	Programmable timer load data test failed	
113-xx	Protected mode test failed	
114-01	Speaker test failed	

Memory Test Error Codes		
Error Code	Description	Recommended Action
200-xx	Memory machine ID test failed	<ol style="list-style-type: none"> 1. Flash the system ROM and retest. 2. Replace the system board and retest.
202-xx	Memory system ROM checksum failed	
203-xx	Write/Read test failed	<ol style="list-style-type: none"> 1. Remove the memory module and retest. 2. Install a new memory module and retest.
204-xx	Address test failed	
211-xx	Random pattern test failed	
214-xx	Noise test failed	
215-xx	Random address test failed	

Keyboard Test Error Codes		
Error Code	Description	Recommended Action
300-xx	Failed ID Test	<ol style="list-style-type: none"> 1. Check the keyboard connection. If disconnected, turn off the computer and connect the keyboard. 2. Replace the keyboard and retest. 3. Replace the system board and retest.
301-xx	Failed Selftest/Interface Test	
302-xx	Failed Individual Key Test	
304-xx	Failed Keyboard Repeat Test	

Parallel Printer Test Error Codes		
Error Code	Description	Recommended Action
401-xx	Printer failed or not connected	<ol style="list-style-type: none"> 1. Connect the printer. 2. Check power to the printer. 3. Install the loop-back connector and retest. 4. Check port and IRQ configuration. 5. Replace the system board and retest.
402-xx	Failed Port Test	
403-xx	Printer pattern test failed	

Diskette Drive Test		
Error Code	Description	Recommended Action
600-xx	Diskette ID drive types test failed	<ol style="list-style-type: none"> 1. Replace the diskette media and retest. 2. Check and/or replace the diskette power and signal cables and retest. 3. Replace the diskette drive and retest. 4. Replace the system board and retest.
601-xx	Diskette format failed	
602-xx	Diskette read test failed	
603-xx	Diskette write, read, compare test failed	
604-xx	Diskette random read test failed	
605-xx	Diskette ID media failed	
606-xx	Diskette speed test failed	
609-xx	Diskette reset controller test failed	
610-xx	Diskette change line test failed	
697-xx	Diskette type error	
698-xx	Diskette drive speed not within limits	<ol style="list-style-type: none"> 1. Replace media. 2. Run the Configuration and Diagnostics Utilities.
699-xx	Diskette drive/media ID error	

Serial Test Error Codes		
Error Code	Description	Recommended Action
1101-xx	Serial port test failed	<ol style="list-style-type: none"> 1. Check port configuration 2. Replace the system board and retest.

Hard Drive Test Error Codes		
Error Code	Description	Recommended Action
1701-xx	Hard drive format test failed	<ol style="list-style-type: none"> 1. Run the Configuration and Diagnostics Utilities and verify drive type. 2. Verify that all secondary drives have secondary drive capability. 3. Replace the hard drive and retest. 4. Replace the system board and retest.
1702-xx	Hard drive read test failed	
1703-xx	Hard drive write/read/compare test failed	
1704-xx	Hard drive random seek test failed	
1705-xx	Hard drive controller test failed	
1706-xx	Hard drive ready test failed	
1707-xx	Hard drive recalibration test failed	
1708-xx	Hard drive format bad track test failed	
1709-xx	Hard drive reset controller test failed	
1710-xx	Hard drive park head test failed	
1715-xx	Hard drive head select test failed	
1716-xx	Hard drive conditional format test failed	
1717-xx	Hard drive ECC* test failed	
1719-xx	Hard drive power mode test failed	
1724-xx	Network preparation test failed	
1736-xx	Drive monitoring test failed	

Video Test Error Codes		
Error Code	Description	Recommended Action
501-xx	Video controller test failed	The following apply to error codes 501-xx through 516-xx: <ol style="list-style-type: none"> 1. Disconnect external monitor and test with internal LCD display. 2. Replace the display assembly and retest. 3. Replace the system board and retest.
502-xx	Video memory test failed	
503-xx	Video attribute test failed	
504-xx	Video character set test failed	
505-xx	Video 80 × 25 mode 9 × 14 character cell test failed	
506-xx	Video 80 × 25 mode 8 × 8 character cell test failed	
507-xx	Video 40 × 25 mode test failed	
508-xx	Video 320 × 200 mode color set 0 test failed	
509-xx	Video 320 × 200 mode color set 1 test failed	
510-xx	Video 640 × 200 mode test failed	
511-xx	Video screen memory page test failed	The following steps apply to error codes 2402-xx through 2456-xx: <ol style="list-style-type: none"> 1. Run the Configuration and Diagnostics Utilities. 2. Replace the display assembly and retest. 3. Replace the system board and retest.
512-xx	Video gray scale test failed	
514-xx	Video white screen test failed	
516-xx	Video noise pattern test failed	
2402-xx	Video memory test failed	
2403-xx	Video attribute test failed	
2404-xx	Video character set test failed	
2405-xx	Video 80 × 25 mode 9 × 14 character cell test failed	
2406-xx	Video 80 × 25 mode 8 × 8 character cell test failed	
2408-xx	Video 320 × 200 mode color set 0 test failed	
2409-xx	Video 320 × 200 mode color set 1 test failed	
2410-xx	Video 640 × 200 mode test failed	The following step applies to error codes 2458-xx through 2480-xx: <p style="color: #000080;">Replace the system board and retest.</p>
2411-xx	Video screen memory page test failed	
2412-xx	Video gray scale test failed	
2414-xx	Video white screen test failed	
2416-xx	Video noise pattern test failed	
2418-xx	ECG/VGC memory test failed	
2419-xx	ECG/VGC ROM checksum test failed	
2421-xx	ECG/VGC 640 × 200 graphics mode test failed	
2422-xx	ECG/VGC 640 × 350 16 color set test failed	
2423-xx	ECG/VGC 640 × 350 64 color set test failed	
2424-xx	ECG/VGC monochrome text mode test failed	
2425-xx	ECG/VGC monochrome graphics mode test failed	
2431-xx	640 × 480 graphics test failure	
2432-xx	320 × 200 graphics (256 color mode) test failure	
2448-xx	Advanced VGA Controller test failed	
2451-xx	132-column Advanced VGA test failed	
2456-xx	Advanced VGA 256 Color test failed	
2458-xx	Advanced VGA BitBLT test	
2468-xx	Advanced VGA DAC test	
2477-xx	Advanced VGA data path test	
2478-xx	Advanced VGA BitBLT test	
2480-xx	Advanced VGA LineDraw test	

Audio Test Error Codes		
Error Code	Description	Recommended Action
3206-xx	Audio System Internal Error	Replace the system board and retest.

TouchPad/Pointing Device Interface Test Error Codes		
Error Code	Description	Recommended Action
8601-xx	Mouse test failed	<ol style="list-style-type: none"> 1. Replace the TouchPad and retest. 2. Replace the system board and retest.
8602-xx	Interface test failed	

CD Drive Test Error Codes		
Error Code	Description	Recommended Action
3301-xx	CD drive read test failed	<ol style="list-style-type: none"> 1. Replace the CD and retest. 2. Verify that the speakers are connected. 3. Verify that drivers are loaded and properly installed. 4. Replace the CD drive and retest. 5. Replace the system board and retest.
3305-xx	CD drive seek test failed	
6600-xx	ID test failed	
6605-xx	Read test failed	
6608-xx	Controller test failed	
6623-xx	Random read test failed	

maintenance & service guide

Presario 1600 Series

Models: 1683, 1685, 1687, 1688, 1690, 1692, 1693, and 1694

Before You Begin	Specifications	Parts Catalog
Removal Sequence	Troubleshooting	Battery Operations
Product Description	Pin Assignments	Index

Preliminary Steps
Clearing the Power-On Password
Power-On Test (POST)
Compaq Diagnostics
Diagnostic Error Codes
Solving Minor Problems
Contacting Compaq Support

Solving Minor Problems

Some minor problems and possible solutions are outlined in the following tables. If the problem appears related to a software application, check the documentation provided with the software.

Solving Audio Problems

Some common audio problems and solutions are listed in the following table.

Solving Audio Problems		
Problem	Probable Cause	Solution(s)
Computer does not beep after the Power-On Self-Test (POST).	This is typical; it indicates successful completion of the Power-On Self-Test (POST).	No action is required.

Solving Battery Pack and Battery Gauge Problems

Some common causes and solutions for battery pack problems are listed in the following table. The "Solving Power Problems" section in this chapter may also be applicable.

Solving Battery Pack and Battery Gauge Problems		
Problem	Probable Cause	Solution(s)
Computer won't turn on when battery pack is inserted and power cord is unplugged.	Battery pack is discharged.	Connect the computer to an external power source and charge the battery pack. Replace the battery pack with a fully charged battery pack. Check the battery connectors on the system board to verify they are evenly spaced and that they are not bent or broken.
Computer is beeping and battery LED icon is blinking.	Battery charge is low.	Immediately save any open file(s). Then do any one of the following: <ul style="list-style-type: none"> Connect the computer to an external power source to charge the battery pack. Turn off the computer or initiate Hibernation until you can find another power source or charge the battery pack.
Computer battery LED icon (front on the unit) blinks to indicate low battery condition, but computer does not beep.	Volume is turned down too low.	Adjust the volume.
Battery LED icon doesn't light and battery pack won't fast charge.	Battery pack is already charged.	No action is necessary.
	Battery pack was exposed to temperature extremes.	Allow time for the battery pack to return to room temperature.
	Battery pack is at end of its life.	Replace battery pack.
You have to set the date and time every time you turn on the computer.	RTC battery is dead.	Replace the RTC battery.

Problem	Probable Cause	Solution(s)
Battery charge does not last as long as expected.	Battery is being exposed to high temperatures or extremely cold temperatures.	Keep the battery pack within the recommended operating temperature range 50° F to 104° F (10° C to 40° C) or recommended storage range -4° F to 86° F (-20° C to 30° C). Recharge the battery pack.
	Battery has partially self-discharged.	Recharge the battery. Discharge the battery completely and then recharge it.
	Power management is disabled.	Set a power management level in Computer Setup.
An external device or PC Card is draining the battery.	Turn off or disconnect external devices when not using them.	No action is required.
Battery pack is warm to the touch after charging.	Normal warming has occurred due to charging.	Enable power management in Computer Setup and in Windows Power Properties.
Battery pack operating time is far less than the documented average operating time.	An external device or PC Card is draining the battery.	Turn off or disconnect external devices when not using them.
	Battery pack has partially self-discharged.	Condition the battery pack by fully charging, fully discharging, then fully recharging it. To maintain the charge, leave battery packs in the computer when it is connected to external power. If the computer is disconnected from external power for more than two weeks, remove battery packs from the computer to reduce the discharge rate.
	Battery pack is being exposed to high temperatures or extremely cold temperatures.	Keep the battery pack within the recommended temperature ranges. Operating: 50° F to 104° F (10° C to 40° C) Storage: -4° F to 86° F (-20° C to 30° C) Recharge the battery pack.

Solving CD Drive Problems

Some common causes and solutions for CD drive problems are listed in the following table.

Solving CD Drive Problems		
Problem	Probable Cause	Solution(s)
CD drive cannot read a compact disc.	Compact disc is upside down or is improperly inserted in the CD drive.	Open the CD loading tray, lay the compact disc in it (label side up), then close the tray.
	CD is CD Plus or Pregap/Track 0 type.	Cannot read these type CDs in 24x. Remove the CD.

Solving Diskette and Diskette Drive Problems

Some common causes and solutions for diskette and diskette drive problems are listed in the following table.

Solving Diskette and Diskette Drive Problems		
Problem	Probable Cause	Solution(s)
Diskette drive cannot write to a diskette.	Diskette is write-protected.	Disable the diskette's write-protect feature or use a diskette that is not write-protected.
	Computer is writing to the wrong drive.	Check the drive letter in the path statement.
	Not enough space is left on the diskette.	Use another diskette.
	Drive error has occurred.	Run Computer Checkup from the Compaq Diagnostics diskette.
	Diskette is not formatted.	Format the diskette. At the system prompt, enter FORMAT A:
Diskette drive cannot read a diskette.	The wrong type of diskette is being used.	Use the type of diskette required by the drive.
	Diskette has a bad sector.	Copy files to hard drive or another diskette. Reformat bad floppy.
	Drive error has occurred.	Run Computer Checkup from the Compaq Diagnostics diskette.
	Diskette is not formatted.	Format the diskette. At the system prompt, enter FORMAT A:
Cannot boot from diskette.	Bootable diskette is not in drive A.	Put the bootable diskette in drive A.
	Diskette Boot has incorrect setting in Computer Setup.	Run Computer Setup and set diskette as first to boot.

Solving Display Problems

This section lists some common causes and solutions for computer display and external monitor problems.

You can perform a monitor self-test on an external VGA color or monochrome monitor by disconnecting the monitor from the computer. To do so, complete the following steps:

- Turn off the monitor.
- Turn off the computer.
- Disconnect the monitor signal cable from the computer.
- Turn on the monitor and allow it to warm up for one minute.

The display should be white. A narrow black border may also appear on the left and right sides of the display. Either of these displays indicates that the monitor is working properly.

Solving Display Problems		
Problem	Probable Cause	Solution(s)
Screen is dim.	Control for brightness or contrast (if applicable) is not set properly.	Adjust the Brightness of the display by using Fn + F7 () or Fn + F8 (-). Adjust the Contrast of the display by using Fn + F5 () or Fn + F6 (-).
	Computer screen is in direct light.	Tilt display or move computer.
Screen is blank.	Screen save was initiated by Power Management due to lack of user activity.	Press any key or touch the Touch Pad.
	Display has overheated.	If computer is in direct sunlight, move it and allow it to cool off.
Display is blank and the Suspend icon is flashing.	System is in Suspend mode.	Press any key or touch the Touch Pad.
Internal display is blank and the screen on an external monitor displays information.	Display function was switched to the external monitor.	Use Fn + F2 to switch between LCD or CRT .

Problem	Probable Cause	Solution(s)
Internal display flashes or has garbled characters when computer is connected to external monitor.	Using 1024 x 768 or higher resolution on external monitor and have toggled back to internal display, which supports up to 800 x 600.	Restart the computer.
The light tubes on the edge of the display panel do not light up at all and Power-On Self-Test (POST) completes when the unit is powered up.**	Improper backlight or display cable connections	Replace the display assembly.
	Defective inverter board.	Replace the display assembly.
	Defective display cable.	Replace the display assembly.
	Defective display panel.	Replace the display assembly.
The light tubes on the edge of the display panel do not light up at all and Power-On Self-Test (POST) does not complete when the unit is powered up.**	Defective system board.	Replace the system board.
	Defective system board.	Replace the system board.
Backlight (brightness) cannot be adjusted with Fn + F7 () or Fn + F8 (-).***	Improper display cable connections.	1. Reseat the display cable to the system board. 2. Replace the display assembly.
	Defective inverter board.	Replace the display assembly.
	Defective display cable.	Replace the display assembly.
	Defective system board.	Replace the system board.
Contrast cannot be adjusted with Fn + F5 () or Fn + F6 (-).	Improper display cable connections.	1. Reseat the display cable to the system board. 2. Replace the display assembly.
	Defective inverter board.	Replace the display assembly.
	Defective display cable.	Replace the display assembly.
	Defective system board.	Replace the system board.

** This problem indicates that the backlight or its power circuitry has failed. Since you cannot observe the POST result on the display panel when the backlight is not functioning, connect the unit to an external monitor before powering the unit up. If an external monitor is not available, verify that POST completes by opening and closing the display, listening for the single or double beep, and watching for the LEDs turn on at the front of the computer.

Problem	Probable Cause	Solution(s)
This display panel has a continuous pattern across it (e.g., a "jailbars" pattern), has a single color on it, or has garbled graphics across the entire panel. This failure is for patterns across the entire panel (not just on one section).	Improper display cable connections	Reseat the display cable to the following until the problem is solved: <ol style="list-style-type: none"> System board Display assembly
	Defective display cable.	Replace the display assembly.
	Defective inverter board.	Replace the display assembly.
	Defective system board.	Replace the system board.
Ghost bars extending from graphics on the display.	Common characteristic of STN displays.	1. Adjust the background colors. 2. Change the Contrast of the display by using Fn + F5 () or Fn + F6 (-).
A single line, small group of lines, or block appears on the display panel. This failure occurs in only a section of the display panel.	Defective display panel.	Replace the display assembly.

NOTE: To perform a "self-test" on an external VGA color or monochrome monitor, complete the following steps: The screen should be white. A narrow black border may also appear on the left and right sides of the display. Either of these displays indicates that the monitor is working properly.

Solving Hard Drive Problems

Some common causes and solutions for hard drive problems are listed in the following table.

	CAUTION: To prevent loss of information, always maintain an up-to-date backup of your hard drive at all times, in case of errors or failures.
--	--

Solving Hard Drive Problems		
Problem	Probable Cause	Solution(s)
Reading hard drive takes an unusually long time after restarting the computer.	System entered Hibernation due to low battery condition and is now exiting from it.	Give the system time to restore the previously saved data to its exact state before Hibernation.
Hard drive error occurs.	Hard drive has bad sectors or has failed.	Run Computer Checkup.
Hard drive does not work.	Hard drive is not seated properly.	Turn off and unplug the computer, remove the battery pack, and remove and then reinstall the hard drive.

Solving Hardware Installation Problems

Some common causes and solutions for hardware installation problems are listed in the following table.

Solving Hardware Installation Problems		
Problem	Probable Cause	Solution(s)
A new device is not recognized as part of the computer system.	Cable(s) of new external device are loose or power cables are unplugged.	Ensure that all cables are properly and securely connected.
	Power switch of new external device is not turned on.	Turn off the computer, turn on the external device, then turn on the computer to integrate the device with the computer system.
	Device is not seated properly.	Turn off the computer and reinsert the device.

Solving Keyboard/Numeric Keypad Problems

Some common causes and solutions for keyboard/numeric keypad problems are listed in the following table.

Solving Keyboard/Numeric Keypad Problems		
Problem	Probable Cause	Solution(s)
Embedded numeric keypad on computer keyboard is disabled.	Num Lock function is not enabled.	Press the Shift+NumLk keys to enable the Num Lock function and embedded numeric keypad. The Num Lock icon on the status panel turns on.
Embedded numeric keypad is disabled and Num Lock function is on.	External numeric keypad is connected to the computer.	Disconnect the external numeric keypad from the computer.

Solving Memory Problems

Some common causes and solutions for memory problems are listed in the following table.

Solving Memory Problems		
Problem	Probable Cause	Solution(s)
Memory count during Power-On Self-Test (POST) is incorrect.	Optional memory expansion card is installed incorrectly, is incompatible with the computer, or is defective.	Ensure that the optional memory expansion card is installed correctly.
"Out of Memory" message is displayed on the screen or insufficient memory error occurs during operation.	System ran out of memory for the application.	Check the application documentation for memory requirements. Install additional memory.
	Too many TSR (terminate-and-stay-resident) applications are running.	Remove from memory any TSR applications that you do not need.

[Solving Minor Problems \(continued\)](#)

maintenance & service guide

Presario 1600 Series

Models: 1683, 1685, 1687, 1688, 1690, 1692, 1693, and 1694

Before You Begin	Specifications	Parts Catalog
Removal Sequence	Troubleshooting	Battery Operations
Product Description	Pin Assignments	Index

Product Description

Models and Features
Controls and Lights
Front Bezel Lights
Front Bezel Buttons
Left Side Components
Right Side Components
Underside of Unit
Rear Connectors
Power Management for Windows 98

Models and Features

	Model 1683	Model 1685 & 1692
Display	12.1 inch TFT	12.1 inch TFT
Processor	AMD-K6 350-MHz MMX	[FrontPage Save Results Component]
Hard Drive	3.2-GB	4.3-GB, 4.8-GB*, 6.4-GB
DVD or CD Drive	24x CD	24x CD, 4X DVD
Modem	56.0 Kbps Data/Fax with PCI	56.0 Kbps Data/Fax with PCI
System Memory	32-MB	32 MB, 64-MB
	Model 1687 & 1694	Model 1688
Display	14.1 inch TFT	13.3 inch TFT
Processor	AMD-K6 380-MHz MMX (model 1687) AMD-K6 400-MHz MMX (model 1694) AMD-K6 433-MHz MMX (model 1694)	[FrontPage Save Results Component]
Hard Drive	4.8-GB*, 6.4-GB	4.8-GB*
DVD or CD Drive	4x DVD	24x CD
Modem	56.0 Kbps Data/Fax with PCI	56.0 Kbps Data/Fax with PCI
System Memory	64-MB	64-MB
	Model 1690 & 1693	CTO
Display	14.1 inch TFT	
Processor	AMD-K6 400-MHz MMX	
Hard Drive	6.4-GB	
CD Drive	24x CD, 4x DVD	
Modem	56.0 Kbps Data/Fax with PCI	56.0 Kbps Data/Fax with PCI
System Memory	64-MB	
(* Hard Drive: 4.8 GB Not Available)		

maintenance & service guide

Presario 1600 Series

Models: 1683, 1685, 1687, 1688, 1690, 1692, 1693, and 1694

Before You Begin	Specifications	Parts Catalog
Removal Sequence	Troubleshooting	Battery Operations
Product Description	Pin Assignments	Index

Product Description

Controls and Lights

[Models and Features](#)

Controls and Lights

[Front Bezel Lights](#)

[Front Bezel Buttons](#)

[Left Side Components](#)

[Right Side Components](#)

[Underside of Unit](#)

[Rear Connectors](#)

[Power Management for Windows 98](#)

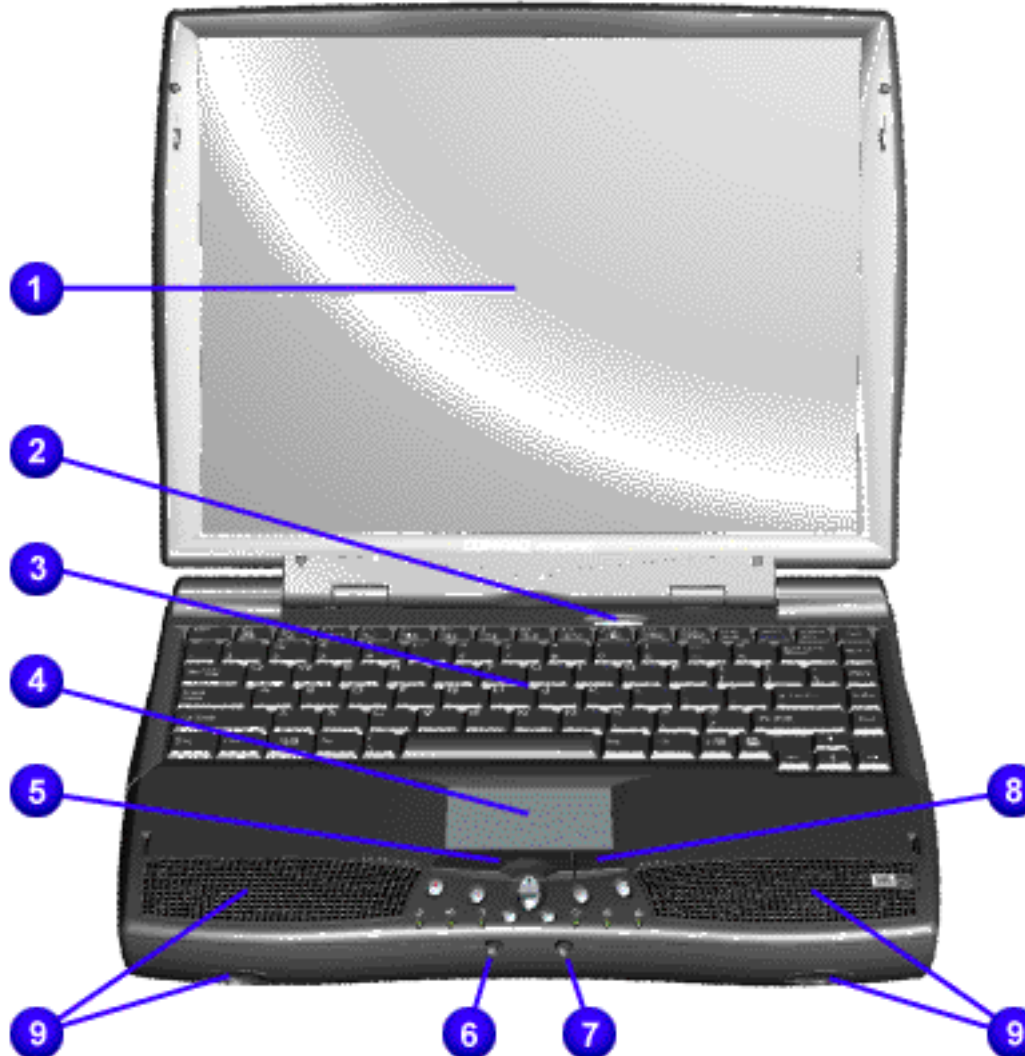

1. Display
2. Power (On/Off) Button
3. Keyboard
4. Touch Pad
5. Touch Pad Button (Left)
6. Headphone Jack
7. Microphone Jack
8. Touch Pad Button (Right)
9. Integrated Speakers and Ports

maintenance & service guide

Presario 1600 Series

Models: 1683, 1685, 1687, 1688, 1690, 1692, 1693, and 1694

Before You Begin	Specifications	Parts Catalog
Removal Sequence	Troubleshooting	Battery Operations
Product Description	Pin Assignments	Index

Product Description

Front Bezel Lights

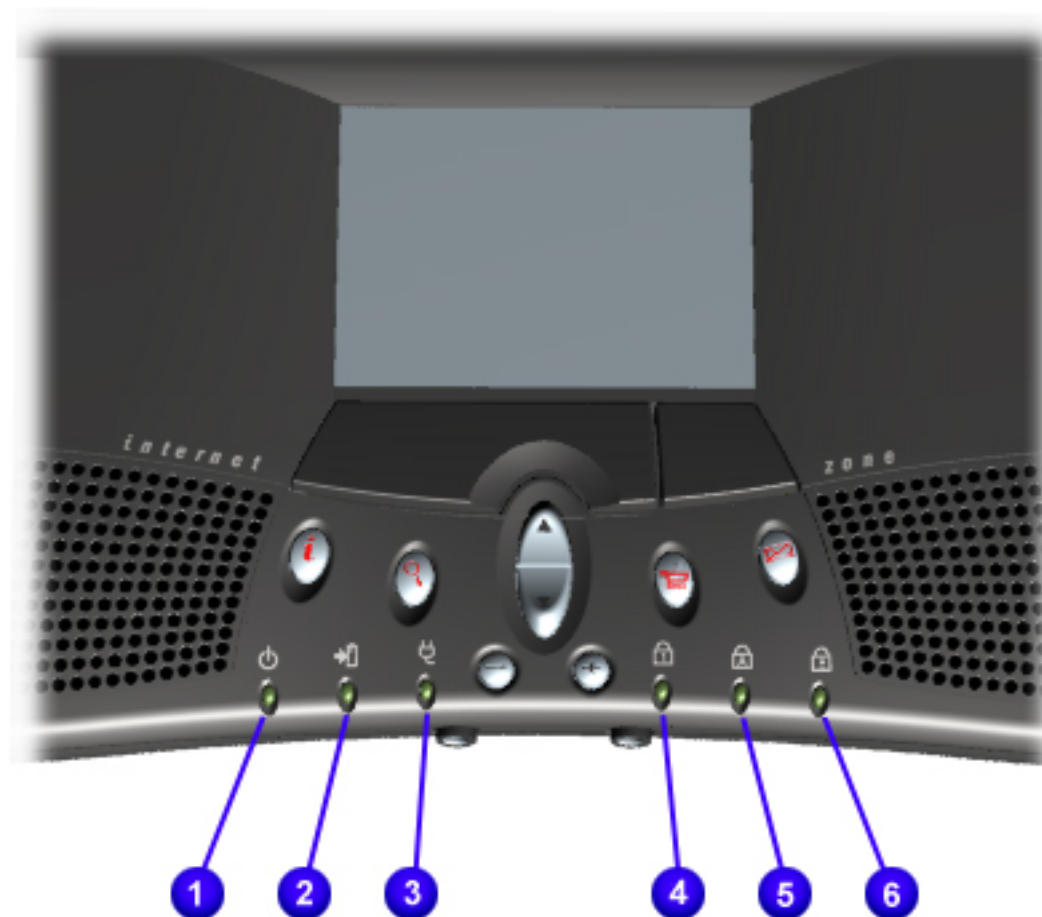

1. Power Light
2. Battery Charge Light
3. Power Cord Light
4. Num Lock Light
5. Cap Lock Light
6. Scroll Lock Light

[Models and Features](#)

[Controls and Lights](#)

Front Bezel Lights

[Front Bezel Buttons](#)

[Left Side Components](#)

[Right Side Components](#)

[Underside of Unit](#)

[Rear Connectors](#)

[Power Management for Windows 98](#)

maintenance & service guide

Presario 1600 Series

Models: 1683, 1685, 1687, 1688, 1690, 1692, 1693, and 1694

Before You Begin	Specifications	Parts Catalog
Removal Sequence	Troubleshooting	Battery Operations
Product Description	Pin Assignments	Index

Product Description

[Models and Features](#)

[Controls and Lights](#)

[Front Bezel Lights](#)

Front Bezel Buttons

[Left Side Components](#)

[Right Side Components](#)

[Underside of Unit](#)

[Rear Connectors](#)

[Power Management for Windows 98](#)

Front Bezel Buttons

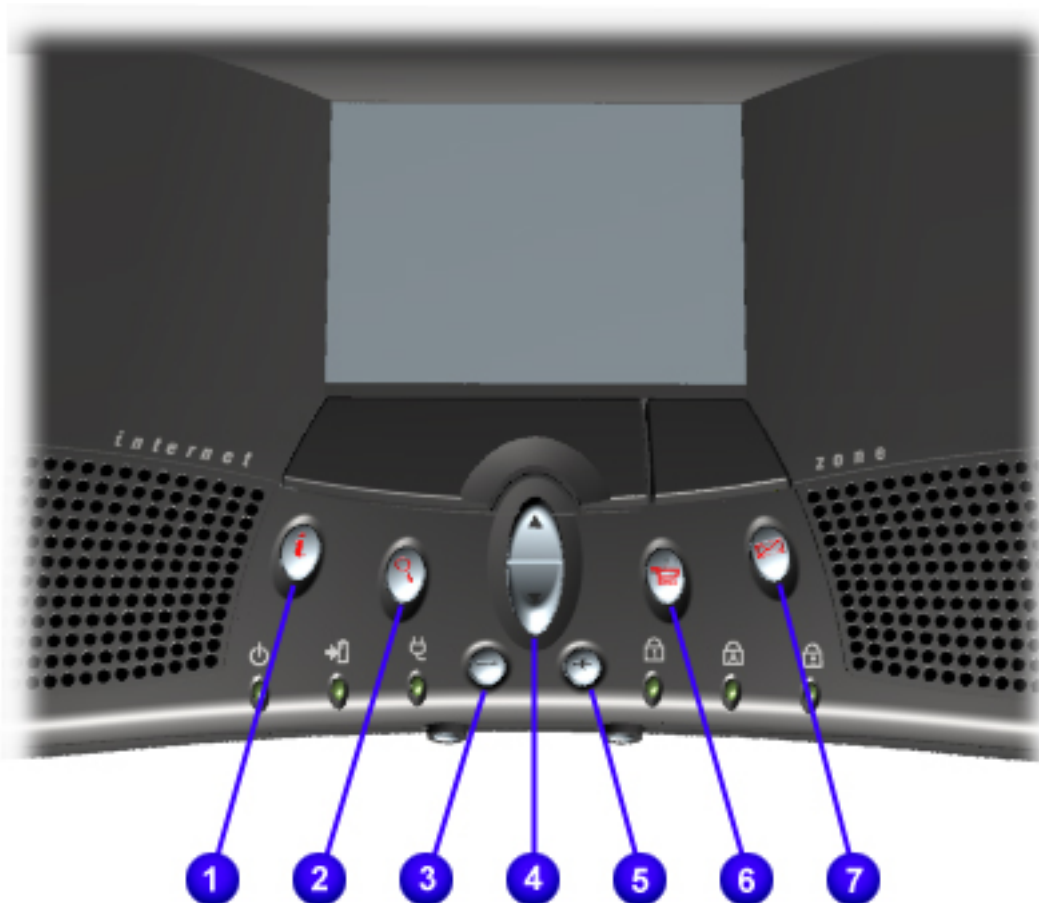

1. Instant Internet Access Button
2. Instant Search Button
3. Volume Down Button
4. Scroll Up/Down Button
5. Volume Up Button
6. Secure E-Commerce Button (or favorite Web site)
7. Instant E-Mail Button

maintenance & service guide

Presario 1600 Series

Models: 1683, 1685, 1687, 1688, 1690, 1692, 1693, and 1694

Before You Begin	Specifications	Parts Catalog
Removal Sequence	Troubleshooting	Battery Operations
Product Description	Pin Assignments	Index

Product Description

Left Side Components



1. PC Card Eject Lever
2. PC Card Slot
3. Ethernet Connector Plug*
4. Diskette Drive Slot
5. Diskette Eject Button

* The Ethernet Plug was removed on models 1692, 1693, and 1694. The Internal Ethernet Card or the Ethernet Plug are **Not Available** for the 1600 Series.

[Models and Features](#)

[Controls and Lights](#)

[Front Bezel Lights](#)

[Front Bezel Buttons](#)

[Left Side Components](#)

[Right Side Components](#)

[Underside of Unit](#)

[Rear Connectors](#)

[Power Management for Windows 98](#)

maintenance & service guide

Presario 1600 Series

Models: 1683, 1685, 1687, 1688, 1690, 1692, 1693, and 1694

Before You Begin	Specifications	Parts Catalog
Removal Sequence	Troubleshooting	Battery Operations
Product Description	Pin Assignments	Index

Product Description

[Models and Features](#)

[Controls and Lights](#)

[Front Bezel Lights](#)

[Front Bezel Buttons](#)

[Left Side Components](#)

[Right Side Components](#)

[Underside of Unit](#)

[Rear Connectors](#)

[Power Management for Windows 98](#)

Right Side Components



1. Battery Compartment
2. DVD or CD Drive Eject Button
3. DVD or CD Drive Manual Eject Hole

maintenance & service guide

Presario 1600 Series

Models: 1683, 1685, 1687, 1688, 1690, 1692, 1693, and 1694

Before You Begin	Specifications	Parts Catalog
Removal Sequence	Troubleshooting	Battery Operations
Product Description	Pin Assignments	Index

Product Description

[Models and Features](#)

[Controls and Lights](#)

[Front Bezel Lights](#)

[Front Bezel Buttons](#)

[Left Side Components](#)

[Right Side Components](#)

[Underside of Unit](#)

[Rear Connectors](#)

[Power Management for Windows 98](#)

Underside of Unit

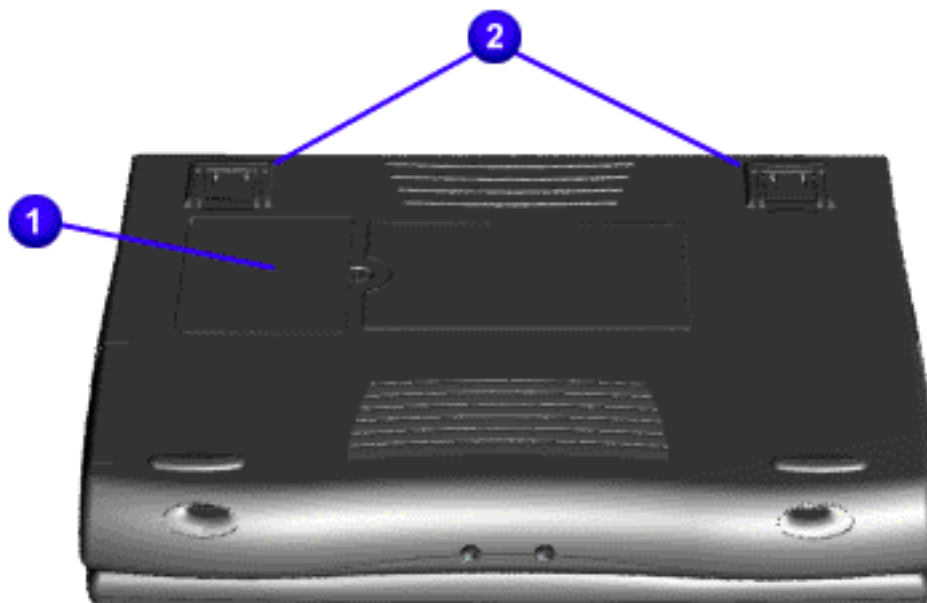

1. Memory Compartment Door
2. Stand Feet

maintenance & service guide

Presario 1600 Series

Models: 1683, 1685, 1687, 1688, 1690, 1692, 1693, and 1694

Before You Begin	Specifications	Parts Catalog
Removal Sequence	Troubleshooting	Battery Operations
Product Description	Pin Assignments	Index

Product Description

[Models and Features](#)

[Controls and Lights](#)

[Front Bezel Lights](#)

[Front Bezel Buttons](#)

[Left Side Components](#)

[Right Side Components](#)

[Underside of Unit](#)

Rear Connectors

[Power Management for Windows 98](#)

Rear Components

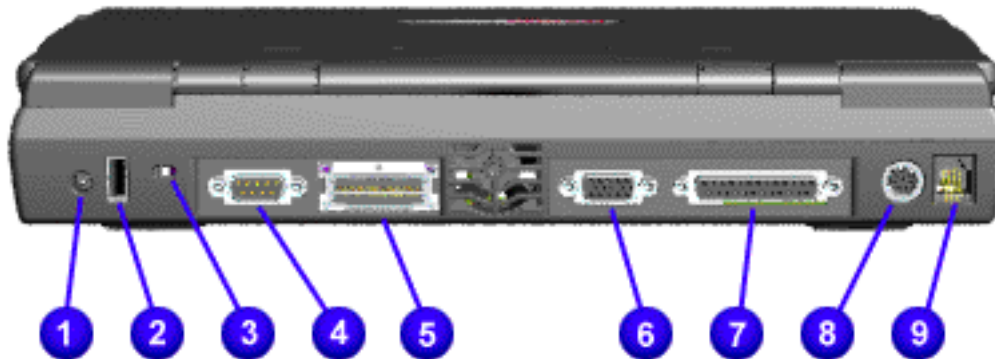

1. AC Adapter
2. Universal Serial Bus
3. Security Slot
4. Serial Port
5. Port Replicator
6. External Monitor Port
7. Parallel Printer Port
8. Keyboard/Mouse Port
9. Modem Jack

maintenance & service guide

Presario 1600 Series

Models: 1683, 1685, 1687, 1688, 1690, 1692, 1693, and 1694

Before You Begin	Specifications	Parts Catalog
Removal Sequence	Troubleshooting	Battery Operations
Product Description	Pin Assignments	Index

Product Description

Models and Features
Controls and Lights
Front Bezel Lights
Front Bezel Buttons
Left Side Components
Right Side Components
Underside of Unit
Rear Connectors
Power Management for Windows 98

Power Management for Windows 98

The following power management features are available for conserving AC power and extending battery operating time:

- [Power Management Settings](#)
- [Sleep](#)
- [Hibernation](#)
- [Servicing Your Computer - Full Off Mode](#)
- [Rebooting After a Lockup](#)
- [Battery Operating Time](#)

Pow

er Management Settings

Depending on your patterns of computer use, you can set different levels of power management. These different power management levels can be activated based on the amount of time passed since the last system activity. System activity examples include keyboard or mouse movement, CD or DVD playback (while under program control that monitors Sleep), and modem use.

You can select different conditions or power schemes through Power Management. The optional settings are **Home/Office Desk**, **Portable/ Laptop**, and **Always On**. From the default settings, you can change the following settings:

- the System goes to Sleep (Standby) mode
- the screen times out and goes blank
- the hard drive spins down

Each of these system components will go to sleep after the selected or default periods of inactivity. (The setting for hard drive must be less than or equal to the setting for System.)

IMPORTANT: If you're on a network, it's recommended that you set **System Standby** to **Never**.

There are five categories of power management settings under the Control Panel. The default setting for each feature is listed below in the tables.

[Top of Page](#)

Power Management Properties

Tab: Power Schemes:	Plugged in	Running on Batteries
Always on System Standby:	Never	15 minutes
Turn OFF Monitor	After 3 hours	Never
Always on System Standby:	After 15 minutes	After 10 minutes

Power Management Properties

Tab: Alarms:	
Low Battery Alarm:	10%
Critical Battery Alarm	0%
Alarm Actions:	X Display Message Notification
	Text Action No Action

[Top of Page](#)

Power Management Properties

Tab: Power Meter:	Default
Tab: Advanced	Default

Display Properties

Tab: Monitor: Laptop Display (Maximum resolution according to unit display size)

[Top of Page](#)

Sleep

You can select Sleep mode instead of turning off the computer when you have finished using it. This allows the computer to wake up faster than turning it completely off and saves power over the active (On) mode. Compaq Presario Series Notebook computers have two levels of sleep, Hibernation and Sleep.

Hibernation - by pushing the power button once your computer will perform a save to disk followed by a shut down of the computer into Off mode.

Sleep - is a low power mode, also referred to as Standby mode. While in Sleep mode, your computer will maintain system information and open files. Unsaved information will be lost if you turn off your system prior to system wake-up, or if you lose power while using the AC adapter.

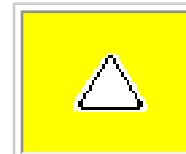
	CAUTION: While in Sleep mode, your computer will maintain system information and open files. Unsaved information will be lost if you turn off your system prior to system wake-up, or if you lose power while using the AC adapter.
--	--

[Top of Page](#)

Hibernation Mode

Hibernation helps conserve battery life and protects your data. Hibernation can be a routine power saving event, or can be the result of a low battery condition. As it enters Hibernation your computer will display a progress screen, as it automatically saves the machine state before it shuts down and turns itself off. Your computer will automatically go into Hibernation, when the battery has little power left, or when the system (operating on battery power) has been in Sleep mode for more than an hour. You can also manually initiate Hibernation by pressing the power button once while the system is active. To restore the computer's previous state, simply press the power button once again. While waking up, the computer will display a progress screen.

The following table shows the conditions and indicators for getting in and out of the various power management modes, Sleep, Hibernation, and Off.

Mode	To Initiate	To End	Indicators
Sleep	Manual keys combination - Fn+ F4	Press any key	Flashing green Power LED
	Time Out Default 15 minutes. If on Battery power (system will not go to Sleep if on AC power)		
Hibernate	Manual - Press Power button once	Press Power button once	No Power LED, blank screen
	Time Out Default If low battery or after 1 hour of sleep (system will not Hibernate if on AC power)		
Off	Perform normal Windows shutdown via the start button, or press and hold down the power button for 4 seconds	Press Power button once	No Power LED, blank screen

[Top of Page](#)

Servicing Your Computer - Full Off Mode

If you need to install or replace components in your system, you must turn the computer off *completely*. Follow the instructions above for properly putting the computer into Off mode, unplug from the outlet, and remove the battery (see battery section for [instruction on removing battery](#)).

Rebooting After a Lockup

Occasionally you may encounter a frozen keyboard or a locked screen. To reboot your computer (as if from a cold start) press and hold down the Power Button for at least four seconds, which will cause a manual shutdown. Then, restart it with a single press of the Power Button. If it still doesn't recover, press the Power Button and hold it for four seconds to shut it down, then, remove the battery or unplug the AC power for at least 30 seconds. Reinsert the battery or reconnect AC power and press the Power Button once to reboot.

[Top of Page](#)

Battery Operating Time

Battery operating time is affected by variables, such as the following:

- Power conservation settings
- Hardware configuration
- Software applications
- Installed options
- Display brightness
- Hard drive usage
- Power button
- Changes in operating temperature
- Type and number of installed PC Cards

For more information on increasing battery pack operating time, conditioning the battery pack, and disposing of a used battery pack, refer to the [Battery Pack Operations](#).

[Top of Page](#)

Free Manuals Download Website

<http://myh66.com>

<http://usermanuals.us>

<http://www.somanuals.com>

<http://www.4manuals.cc>

<http://www.manual-lib.com>

<http://www.404manual.com>

<http://www.luxmanual.com>

<http://aubethermostatmanual.com>

Golf course search by state

<http://golfingnear.com>

Email search by domain

<http://emailbydomain.com>

Auto manuals search

<http://auto.somanuals.com>

TV manuals search

<http://tv.somanuals.com>