

Thank you for purchasing this Factory Service Manual CD/DVD from servicemanuals4u.com.

Please check out our eBay auctions for more great deals on Factory Service Manuals:

[servicemanuals4u](http://servicemanuals4u.com)



HP Pavilion ze5200 Notebook PC
HP Pavilion ze4200 Notebook PC
HP Pavilion ze4100 Notebook PC
Compaq Evo Notebook N1050v Series
Compaq Evo Notebook N1010v Series
Compaq Presario 2500 Series Mobile PC
Compaq Presario 2100 Series Mobile PC
Compaq Presario 1100 Series Mobile PC
Technology Code KE

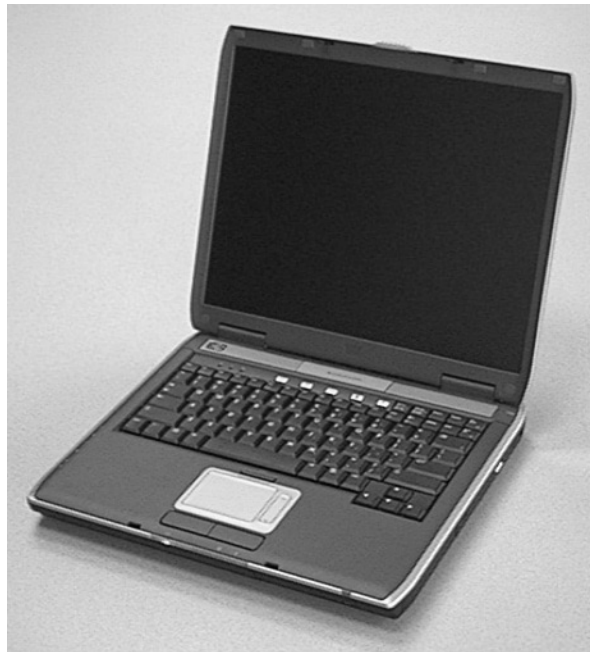

Service Manual

© 2003 Hewlett-Packard Company

Microsoft and Windows are trademarks of Microsoft Corporation in the U.S. and/or other countries. Intel, Celeron, and Pentium are trademarks of Intel Corporation in the U.S. and/or other countries. All other product names mentioned herein may be trademarks of their respective companies.

HP shall not be liable for technical or editorial errors or omissions contained herein or for incidental or consequential damages in connection with the furnishing, performance, or use of this material. The information in this document is provided “as is” without warranty of any kind, including, but not limited to, the implied warranties of merchantability and fitness for a particular purpose, and is subject to change without notice. The warranties for HP products are set forth in the express limited warranty statements accompanying such products. Nothing herein should be construed as constituting an additional warranty.

This document contains proprietary information that is protected by copyright. No part of this document may be photocopied, reproduced, or translated to another language without the prior written consent of Hewlett-Packard Company.

Service Manual

First Edition January 2003

Reference Number: N1050v/N1010v/2500/2100/1100/ze5200/ze4200/ze4100

Document Part Number: 319733-001

Contents

Product Information	1-1
Features	1-15
Operation.....	1-18
Turning the Notebook On and Off	1-18
Checking the Status of the Notebook	1-19
Using Fn Hot Keys	1-20
Resetting the Notebook	1-21
Specifications	1-22
Internal Design	1-27
Removal and Replacement	2-1
Disassembly Flowchart	2-3
Removing the Battery (User-Replaceable).....	2-4
Removing a SDRAM Module (User-Replaceable).....	2-5
Removing the Wireless LAN Mini-PCI Card (User-Replaceable)	2-6
Removing the Hard Disk Drive (User-Replaceable).....	2-7
Replacing Small Parts (User-Replaceable)	2-9
Removing the Keyboard Cover (User-Replaceable).....	2-10
Removing the Speaker Assembly (User-Replaceable).....	2-12
Removing the Keyboard (User-Replaceable).....	2-13
Removing the Switchboard PCA (User-Replaceable)	2-15
Removing the CD/DVD Drive (User-Replaceable).....	2-16
Removing the Display Assembly (Authorized Service Providers Only)	2-17
Removing the Top Case (Authorized Service Providers Only)	2-20
Removing the Floppy Drive (Authorized Service Providers Only)	2-22
Removing the Infrared (I/R) PCA (Authorized Service Providers Only)	2-24
Removing the Heatsink (with Fan) (Authorized Service Providers Only).....	2-26
Removing the CPU Module (Authorized Service Providers Only)	2-28
Removing the Motherboard (Authorized Service Providers Only).....	2-30
Replacing Components on a Bottom Case.....	2-34
Repairing the BIOS IC (Authorized Service Providers Only)	2-36
Removing Other Components (Authorized Service Providers Only)	2-38
Troubleshooting and Diagnostics	3-1
Support by Authorized Service Providers	3-1
Troubleshooting	3-2
Checking for Customer Abuse	3-3
Troubleshooting the Problem	3-3
Verifying the Repair.....	3-4
Suggestions for Troubleshooting.....	3-5
Diagnostic Tools	3-18
e-Diagtools Diagnostic Program	3-18
Power-On Self-Test	3-19
Sycard PCCtest 450/460 PC Card (Optional).....	3-25
Windows Management Instrumentation (WMI)	3-26
BIOS Setup Utility	3-26

Replaceable Parts.....	4-1
-------------------------------	------------

Reference Information	5-1
------------------------------------	------------

Password Removal Policy.....	5-1
Hewlett-Packard Display Quality Statement.....	5-2
Service Notes and Obsolete Parts	5-4

Figures

Figure 1-1. Front View	1-15
Figure 1-2. Back View.....	1-16
Figure 1-3. Bottom View.....	1-17
Figure 1-4. Resetting the Notebook.....	1-21
Figure 1-5. Replaceable Module Diagram.....	1-27
Figure 2-1. Disassembly Flow	2-3
Figure 2-2. Removing the Battery	2-4
Figure 2-3. Removing an SDRAM Module.....	2-5
Figure 2-4. Removing the Mini-PCI Card	2-6
Figure 2-5. Removing the Hard Disk Drive.....	2-7
Figure 2-6. Removing the Hard Disk Drive Tray	2-8
Figure 2-7. Removing the Keyboard Cover.....	2-11
Figure 2-8. Removing the Speaker Assembly.....	2-12
Figure 2-9. Removing the Keyboard.....	2-14
Figure 2-10. Removing the Switchboard PCA	2-15
Figure 2-11. Removing the CD/DVD Drive.....	2-16
Figure 2-12. Removing the Display Assembly	2-18
Figure 2-13. Removing the Top Case	2-21
Figure 2-14. Removing the Floppy Drive.....	2-23
Figure 2-15. Removing the I/R PCA	2-25
Figure 2-16. Removing the Heatsink (with Fan)	2-26
Figure 2-17. Removing the CPU Module.....	2-29
Figure 2-18. Removing the Motherboard	2-31
Figure 2-19. Example of Serial Number Label.....	2-34
Figure 2-20. Replacing the Antennas.....	2-35
Figure 2-21. Removing a PCMCIA Door.....	2-35
Figure 2-22. Boot-Block Jumper	2-37
Figure 3-1. Basic Troubleshooting Steps.....	3-2
Figure 4-1. Exploded View.....	4-2

Tables

Table 1-1. Notebook Products	1-1
Table 1-2. Product Comparisons	1-13
Table 1-3. Activating Power Modes	1-18
Table 1-4. Main Status Lights (front of notebook)	1-19
Table 1-5. Keyboard Status Lights.....	1-19
Table 1-6. Fn Hot Keys	1-20
Table 1-7. Specifications.....	1-22
Table 1-8. Accessories	1-25
Table 1-9. Functional Structure Description	1-28
Table 2-1. Removal Cross-Reference	2-1
Table 2-2. Required Equipment	2-2
Table 2-3. Recommended Screw Torque Values	2-2
Table 2-4. Replacing Small Parts (User-Replaceable).....	2-9
Table 2-5. Removing Components	2-38
Table 3-1. ASP Support Options.....	3-1
Table 3-2. Scope of Diagnostic Tools.....	3-5
Table 3-3. Troubleshooting Suggestions	3-6
Table 3-4. POST Terminal-Error Beep Codes	3-20
Table 3-5. POST Messages	3-23
Table 3-6. Sycard PCCTest Commands	3-25
Table 3-7. BIOS Setup Menus and Parameters.....	3-27
Table 4-1. Replaceable Parts.....	4-3
Table 4-2. Accessory Replaceable Parts	4-11
Table 4-3. Part Number Reference.....	4-12
Table 5-1. LCD Guidelines	5-3

Introduction

This manual provides reference information for servicing the HP Pavilion ze5200, ze4200, and ze4100 Notebook PCs (technology code KE), Compaq Evo Notebook 1050v and 1010v Series (technology code KE), and Compaq Presario 2500, 2100, and 1100 Series Mobile PCs (technology code KE). It is for use by authorized service personnel while installing, servicing, and repairing these products.

The manual is designed as a self-paced guide that will train you to install, configure, and repair these notebooks. The manual is self-contained, so you can follow it even without having equipment available.

The following table lists other sources of information about the notebook computers and related products.

Source	Address or Number	Comments
HP Notebook Web Site	<ul style="list-style-type: none">• http://www.hp.com/notebooks• (http://www.europe.hp.com/notebook, European mirror)	
HP Business Support Web site	www.hp.com/go/bizsupport	
HP Partnership Web site	http://partner.americas.hp.com	Restricted to authorized resellers only.
HP Asia Pacific Channel Support Centre for DPSP Partners	http://www.hp.com.au	Restricted to DPSP Partners only.
HP/MCD Web site	http://www.mcd.hp.com	HP's internal Web site for division information.
America Online	Keyword: HP	Call (800) 827-6364 for membership within the US.
CompuServe	GO HP	Call (800) 524-3388 for membership within the US.
HP Support Assist CD-ROM	(800) 457-1762	US and Canada.
	(801) 431-1587	Outside US and Canada.
Microsoft Windows manual		Information about Windows operating system.
Microsoft Web site	http://www.microsoft.com	Information and updates for Windows operating systems.

Product Information

The following list of HP and Compaq notebook products is current at the time of publication but is subject to change.

Table 1-1. Notebook Products

Notebook Product *	CPU **	Display	Hard Drive	CD/DVD Drives	Standard SDRAM/ Video Mem	Communication	Battery
Pavilion ze5200 Notebook PC							
DB395A ABA	Pentium 4-D 2.0-GHz	14.1-in XGA	40 GB	combination + diskette	512 MB/64 MB integrated	iNIC + modem	Li ion
DB396A ABA	Pentium 4-D 2.4-GHz	15.0-in XGA	40 GB	combination + diskette	512 MB/64 MB integrated	iNIC + modem	Li ion
DB397A ABA	Pentium 4-D 2.4-GHz	15.0-in XGA	60 GB	combination + diskette	512 MB/64 MB integrated	iNIC + modem	Li ion
DB399A ABA	Pentium 4-D 2.0-GHz	15.0-in XGA	40 GB	combination + diskette	512 MB/64 MB integrated	iNIC + modem	Li ion
DC603A ABA	Pentium 4-D 2.4-GHz	15.0-in XGA	40 GB	combination + diskette	512 MB/64 MB integrated	iNIC + modem	Li ion
DC604A ABM	Pentium 4-D 2.4-GHz	15.0-in XGA	40 GB	combination + diskette	256 MB/64 MB integrated	iNIC + modem	Li ion
DC605A ABM	Pentium 4-D 2.8-GHz	15.0-in XGA	60 GB	combination + diskette	512 MB/64 MB integrated	iNIC + modem	Li ion
DC671A ABA	Pentium 4-D 2.0-GHz	15.0-in XGA	40 GB	combination + diskette	256 MB/64 MB integrated	iNIC + modem	Li ion
DC672A ABA	Pentium 4-D 2.4-GHz	15.0-in XGA	40 GB	combination + diskette	512 MB/64 MB integrated	iNIC + modem + 802.11b	Li ion
DC673A ABC	Pentium 4-D 2.4-GHz	15.0-in XGA	40 GB	combination + diskette	512 MB/64 MB integrated	iNIC + modem	Li ion
DC673A ABL	Pentium 4-D 2.4-GHz	15.0-in XGA	40 GB	combination + diskette	512 MB/64 MB integrated	iNIC + modem	Li ion
DC674A ABF	Pentium 4-D 2.4-GHz	15.0-in XGA	30 GB	combination + diskette	256 MB/64 MB integrated	iNIC + modem + 802.11b	Li ion
DC674A ABU	Pentium 4-D 2.4-GHz	15.0-in XGA	30 GB	combination + diskette	512 MB/64 MB integrated	iNIC + modem	Li ion
DC679A ABD	Pentium 4-D 2.53-GHz	15.0-in XGA	30 GB	combination + diskette	256 MB/64 MB integrated	iNIC, modem, + 802.11b	Li ion
DC714A ABD	Pentium 4-D 2.53-GHz	15.0-in XGA	40 GB	combination + diskette	512 MB/64 MB integrated	iNIC + modem	Li ion
DC752A ABF	Pentium 4-D 2.53-GHz	15.0-in XGA	40 GB	combination + diskette	256 MB/64 MB integrated	iNIC + modem	Li ion
DC752A ABU	Pentium 4-D 2.53-GHz	15.0-in XGA	40 GB	combination + diskette	256 MB/64 MB integrated	iNIC + modem	Li ion
DC752A UUZ	Pentium 4-D 2.53-GHz	15.0-in XGA	40 GB	combination + diskette	256 MB/64 MB integrated	iNIC + modem	Li ion
DC753A ABA	Pentium 4-D 2.4-GHz	15.0-in XGA	40 GB	combination + diskette	512 MB/64 MB integrated	iNIC, modem, + 802.11b	Li ion

Notebook Product *	CPU **	Display	Hard Drive	CD/DVD Drives	Standard SDRAM/ Video Mem	Communication	Battery
Pavilion ze5200 Notebook PC (continued)							
DC818A ABU	Pentium 4-D 2.66-GHz	15.0-in XGA	40 GB	combination + diskette	512 MB/64 MB integrated	iNIC + modem	Li ion
DC818A UUZ	Pentium 4-D 2.66-GHz	15.0-in XGA	40 GB	combination + diskette	512 MB/64 MB integrated	iNIC + modem	Li ion
DC819A UUZ	Pentium 4-D 2.8-GHz	15.0-in SXGA	60 GB	combination + diskette	512 MB/64 MB integrated	iNIC + modem + 802.11b	Li ion
DC659A UUZ	Pentium 4-D 2.8-GHz	15.0-in XGA	40 GB	combination + diskette	512 MB/64 MB integrated	iNIC + modem + 802.11b	Li ion
DC820A ABN	Pentium 4-D 2.53-GHz	15.0-in XGA	40 GB	combination + diskette	512 MB/64 MB integrated	iNIC + modem + 802.11b	Li ion
Pavilion ze4200 Notebook PC							
DB385A ABA	Celeron 1.7-GHz	15.0-in XGA	30 GB	combination/ no diskette	256 MB/64 MB integrated	iNIC + modem	Li ion
DB386A ABA	Celeron 1.8-GHz	15.0-in XGA	40 GB	combination/ no diskette	512 MB/64 MB integrated	iNIC + modem	Li ion
DB953A ABA	Celeron 1.6-GHz	14.1-in XGA	20 GB	DVD/ no diskette	256 MB/64 MB integrated	iNIC + modem	Li ion
DC590A ABA	Celeron 1.8-GHz	15.0-in XGA	40 GB	combination/ no diskette	256 MB/64 MB integrated	iNIC + modem	Li ion
DC591A ABA	Celeron 1.6-GHz	14.1-in XGA	20 GB	DVD/ no diskette	128 MB/16 MB integrated	iNIC + modem	Li ion
DC592A ABA	Celeron 1.6-GHz	15.0-in XGA	30 GB	combination/ no diskette	256 MB/64 MB integrated	iNIC + modem	Li ion
DC594A ABF	Celeron 1.6-GHz	14.1-in XGA	20 GB	combination + diskette	256 MB/64 MB integrated	iNIC + modem	Li ion
DC595A ABF	Celeron 1.8-GHz	15.0-in XGA	30 GB	combination + diskette	256 MB/64 MB integrated	iNIC + modem	Li ion
DC596A ABF	Celeron 2.0-GHz	15.0-in XGA	40 GB	combination + diskette	512 MB/64 MB integrated	iNIC + modem	Li ion
DC596A ABN	Celeron 2.0-GHz	15.0-in XGA	40 GB	combination + diskette	512 MB/64 MB integrated	iNIC + modem	Li ion
DC597A ABG	Celeron 2.0-GHz	14.1-in XGA	30 GB	DVD + diskette	256 MB/64 MB integrated	iNIC + modem	Li ion
DC597A AB1	Celeron 2.0-GHz	14.1-in XGA	30 GB	DVD + diskette	256 MB/64 MB integrated	iNIC + modem	Li ion
DC598A AB1	Pentium 4-M 1.8-GHz	14.1-in XGA	20 GB	CD-ROM + diskette	256 MB/64 MB integrated	iNIC + modem	Li ion
DC599A AB1	Pentium 4-M 1.8-GHz	15.0-in XGA	30 GB	combination + diskette	256 MB/64 MB integrated	iNIC + modem	Li ion
DC600A ABG	Pentium 4-M 2.0-GHz	15.0-in XGA	40 GB	combination + diskette	256 MB/64 MB integrated	iNIC + modem	Li ion
DC600A AB1	Pentium 4-M 2.0-GHz	15.0-in XGA	40 GB	combination + diskette	256 MB/64 MB integrated	iNIC + modem	Li ion
DC601A ABM	Celeron 2.0-GHz	14.1-in XGA	40 GB	combination + diskette	256 MB/64 MB integrated	iNIC + modem	Li ion
DC602A ABA	Athlon 1.67-GHz	15.0-in XGA	30 GB	combination, no diskette	512 MB/64 MB integrated	iNIC + modem	Li ion
DC709A ABE	Athlon 1.53-GHz	14.1-in XGA	20 GB	DVD + diskette	256 MB/64 MB integrated	iNIC + modem	Li ion
DC709A ABH	Athlon 1.53-GHz	14.1-in XGA	20 GB	DVD + diskette	256 MB/64 MB integrated	iNIC + modem	Li ion
DC709A ABU	Athlon 1.53-GHz	14.1-in XGA	20 GB	DVD + diskette	256 MB/64 MB integrated	iNIC + modem	Li ion

Notebook Product *	CPU **	Display	Hard Drive	CD/DVD Drives	Standard SDRAM/ Video Mem	Communication	Battery
Pavilion ze4200 Notebook PC (continued)							
DC710A ABE	Athlon 1.67-GHz	15.0-in XGA	30 GB	combination + diskette	256 MB/64 MB integrated	iNIC + modem	Li ion
DC710A ABH	Athlon 1.67-GHz	15.0-in XGA	30 GB	combination + diskette	256 MB/64 MB integrated	iNIC + modem	Li ion
DC711A ABE	Athlon 1.8-GHz	15.0-in XGA	30 GB	combination + diskette	512 MB/64 MB integrated	iNIC + modem	Li ion
DC713A ABD	Athlon 1.8-GHz	15.0-in XGA	30 GB	combination + diskette	512 MB/64 MB integrated	iNIC + modem	Li ion
DC760A ABG	Pentium 4-M 1.9-GHz	14.1-in XGA	40 GB	combination + diskette	256 MB/64 MB integrated	iNIC + modem	Li ion
DC761A ABU	Celeron 2.0-GHz	15.0-in XGA	30 GB	combination + diskette	256 MB/64 MB integrated	iNIC + modem	Li ion
DC761A UUZ	Celeron 2.0-GHz	15.0-in XGA	30 GB	combination + diskette	256 MB/64 MB integrated	iNIC + modem	Li ion
DC762A ABC	Celeron 1.6-GHz	14.1-in XGA	20 GB	DVD/ no diskette	256 MB/64 MB integrated	iNIC + modem	Li ion
DC762A ABL	Celeron 1.6-GHz	14.1-in XGA	20 GB	DVD/ no diskette	256 MB/64 MB integrated	iNIC + modem	Li ion
DC763A ABC	Celeron 1.8-GHz	15.0-in XGA	40 GB	combination + diskette	256 MB/64 MB integrated	iNIC + modem	Li ion
DC763A ABL	Celeron 1.8-GHz	15.0-in XGA	40 GB	combination + diskette	256 MB/64 MB integrated	iNIC + modem	Li ion
DC764A ABA	Celeron 1.8-GHz	15.0-in XGA	40 GB	combination/ no diskette	256 MB/64 MB integrated	iNIC + modem	Li ion
DC765A ABD	Pentium 4-M 2.0-GHz	15.0-in XGA	40 GB	combination + diskette	512 MB/64 MB integrated	iNIC + modem + 802.11b	Li ion
DC766A ABD	Celeron 2.0-GHz	15.0-in XGA	30 GB	combination + diskette	256 MB/64 MB integrated	iNIC + modem	Li ion
DC804A ABZ	Athlon 1.46-GHz	14.1-in XGA	20 GB	combination + diskette	256 MB/64 MB integrated	iNIC + modem	Li ion
DC813A ABF	Celeron 1.8-GHz	15.0-in XGA	40 GB	combination + diskette	512 MB/64 MB integrated	iNIC + modem	Li ion
DC814A UUZ	Pentium 4-M 2.0-GHz	15.0-in XGA	30 GB	combination + diskette	512 MB/64 MB integrated	iNIC + modem	Li ion
DC815A UUZ	Pentium 4-M 2.0-GHz	15.0-in SXGA	40 GB	combination + diskette	512 MB/64 MB integrated	iNIC + modem	Li ion
DC816A UUZ	Pentium 4-M 2.2-GHz	15.0-in SXGA	60 GB	combination + diskette	512 MB/64 MB integrated	iNIC + modem	Li ion
DC850A ABD	Celeron 1.8-GHz	14.1-in XGA	20 GB	DVD/ no diskette	128 MB/16 MB integrated	iNIC + modem	Li ion
DD506A ABZ	Athlon 1.47-GHz	14.1-in XGA	20 GB	DVD/ no diskette	128 MB/16 MB integrated	iNIC + modem	Li ion
DD507A ABH	Athlon 1.8-GHz	15.0-in XGA	40 GB	combination + diskette	512 MB/64 MB integrated	iNIC + modem	Li ion
DD508A ABH	Athlon 1.53-GHz	14.1-in XGA	20 GB	combination + diskette	256 MB/64 MB integrated	iNIC + modem	Li ion
DD508A ABU	Athlon 1.53-GHz	14.1-in XGA	20 GB	combination + diskette	256 MB/64 MB integrated	iNIC + modem	Li ion
DD509A ABH	Athlon 1.67-GHz	15.0-in XGA	30 GB	combination + diskette	256 MB/64 MB integrated	iNIC + modem	Li ion
DD510A ABN	Celeron 2.0-GHz	15.0-in XGA	30 GB	combination + diskette	512 MB/64 MB integrated	iNIC + modem	Li ion

Notebook Product *	CPU **	Display	Hard Drive	CD/DVD Drives	Standard SDRAM/ Video Mem	Communication	Battery
Pavilion ze4200 Notebook PC (continued)							
DD511A ABN	Celeron 1.6-GHz	14.1-in XGA	20 GB	DVD + diskette	256 MB/64 MB integrated	iNIC + modem	Li ion
DD672A AB1	Pentium 4-M 1.9-GHz	15.0-in XGA	30 GB	combination + diskette	256 MB/64 MB integrated	iNIC + modem	Li ion
DD673A AB1	Pentium 4-M 2.0-GHz	15.0-in XGA	30 GB	combination + diskette	256 MB/64 MB integrated	iNIC + modem	Li ion
DD674A AB1	Pentium 4-M 2.0-GHz	15.0-in SXGA	40 GB	combination + diskette	512 MB/64 MB integrated	iNIC + modem	Li ion
DD690A UUZ	Celeron 1.6-GHz	14.1-in XGA	20 GB	combination + diskette	256 MB/64 MB integrated	iNIC + modem	Li ion
Pavilion ze4100 Notebook PC							
F5855 H/ABA	Celeron 1.6-GHz	14.1-in XGA	20 GB	combination/no diskette	256 MB/32 uma	LAN + modem	Li ion
F5856 H/ABA	Celeron 1.8-GHz	14.1-in XGA	30 GB	combination/no diskette	512 MB/32 uma	LAN + modem	Li ion
F5859 H/ABA	Celeron 1.6-GHz	14.1-in XGA	20 GB	combination/no diskette	256 MB/32 uma	LAN + modem	Li ion
F5861 H/ABA	Celeron 1.6-GHz	14.1-in XGA	30 GB	combination/no diskette	256 MB/32 uma	LAN + modem	Li ion
F5868 H/ABU	Pentium 4-M 1.8-GHz	15.0-in XGA	40 GB	combination + diskette	512 MB/uma	LAN + modem	Li ion
F5869 H/ABF	Celeron 1.8-GHz	15.0-in XGA	30 GB	combination + diskette	256 MB/uma	LAN + modem	Li ion
F5869 H/ABU	Celeron 1.8-GHz	15.0-in XGA	30 GB	combination + diskette	256 MB/uma	LAN + modem	Li ion
F5870 H/ABF	Pentium 4-M 1.7-GHz	15.0-in XGA	30 GB	combination + diskette	256 MB/32 uma	LAN + modem	Li ion
F5870 H/ABU	Pentium 4-M 1.7-GHz	15.0-in XGA	30 GB	combination + diskette	256 MB/32 uma	LAN + modem	Li ion
F5871 H/ABA	Celeron 1.6-GHz	14.1-in XGA	30 GB	combination/no diskette	256 MB/32 uma	LAN + modem	Li ion
F5873 H/ABF	Celeron 1.6-GHz	14.1-in XGA	20 GB	combination + diskette	256 MB/uma	LAN + modem	Li ion
F5873 H/ABU	Celeron 1.6-GHz	14.1-in XGA	20 GB	combination + diskette	256 MB/uma	LAN + modem	Li ion
F5874 H/ABG	Celeron 1.7-GHz	14.1-in XGA	20 GB	DVD + diskette	128 MB/32 uma	LAN + modem	Li ion
F5875 H/ABG	Pentium 4-M 1.8-GHz	14.1-in XGA	30 GB	combination + diskette	256 MB/uma	LAN + modem	Li ion
F5878 HG/AR9	Celeron 1.7-GHz	14.1-in XGA	30 GB	combination + diskette	256 MB/32 uma	LAN + modem	Li ion
F5879 HG/AR9	Pentium 4-M 2.0-GHz	15.0-in XGA	40 GB	combination + diskette	256 MB/32 uma	LAN + modem	Li ion

Notebook Product *	CPU **	Display	Hard Drive	CD/DVD Drives	Standard SDRAM/ Video Mem	Communication	Battery
Compaq Evo Notebook N1050v Series							
DC749A ABF	Celeron 1.6-GHz	14.1-in XGA	30 GB	combination + diskette	256 MB/64 MB integrated	iNIC + modem	Li ion
DC749A ABH	Celeron 1.6-GHz	14.1-in XGA	30 GB	combination + diskette	256 MB/64 MB integrated	iNIC + modem	Li ion
DC750A ABF	Pentium 4-M 1.8-GHz	14.1-in XGA	30 GB	DVD + diskette	256 MB/64 MB integrated	iNIC + modem	Li ion
DC750A ABH	Pentium 4-M 1.8-GHz	14.1-in XGA	30 GB	DVD + diskette	256 MB/64 MB integrated	iNIC + modem	Li ion
DC751A ABF	Pentium 4-M 1.8-GHz	15.0-in XGA	30 GB	combination + diskette	256 MB/64 MB integrated	iNIC + modem	Li ion
DC751A ABH	Pentium 4-M 1.8-GHz	15.0-in XGA	30 GB	combination + diskette	256 MB/64 MB integrated	iNIC + modem	Li ion
DC767T ABD	Celeron 1.6-GHz	14.1-in XGA	30 GB	combination + diskette	256 MB/64 MB integrated	iNIC + modem	Li ion
DC767T ABE	Celeron 1.6-GHz	14.1-in XGA	30 GB	combination + diskette	256 MB/64 MB integrated	iNIC + modem	Li ion
DC767T ABF	Celeron 1.6-GHz	14.1-in XGA	30 GB	combination + diskette	256 MB/64 MB integrated	iNIC + modem	Li ion
DC767T ABH	Celeron 1.6-GHz	14.1-in XGA	30 GB	combination + diskette	256 MB/64 MB integrated	iNIC + modem	Li ion
DC767T ABU	Celeron 1.6-GHz	14.1-in XGA	30 GB	combination + diskette	256 MB/64 MB integrated	iNIC + modem	Li ion
DC767T ABZ	Celeron 1.6-GHz	14.1-in XGA	30 GB	combination + diskette	256 MB/64 MB integrated	iNIC + modem	Li ion
DC768T ABE	Pentium 4-M 1.8-GHz	14.1-in XGA	30 GB	DVD + diskette	256 MB/64 MB integrated	iNIC + modem	Li ion
DC768T ABF	Pentium 4-M 1.8-GHz	14.1-in XGA	30 GB	DVD + diskette	256 MB/64 MB integrated	iNIC + modem	Li ion
DC768T ABH	Pentium 4-M 1.8-GHz	14.1-in XGA	30 GB	DVD + diskette	256 MB/64 MB integrated	iNIC + modem	Li ion
DC768T ABU	Pentium 4-M 1.8-GHz	14.1-in XGA	30 GB	DVD + diskette	256 MB/64 MB integrated	iNIC + modem	Li ion
DC768T ABZ	Pentium 4-M 1.8-GHz	14.1-in XGA	30 GB	DVD + diskette	256 MB/64 MB integrated	iNIC + modem	Li ion
DC769T ABD	Pentium 4-M 1.8-GHz	15.0-in XGA	30 GB	combination + diskette	256 MB/64 MB integrated	iNIC + modem	Li ion
DC769T ABE	Pentium 4-M 1.8-GHz	15.0-in XGA	30 GB	combination + diskette	256 MB/64 MB integrated	iNIC + modem	Li ion
DC769T ABF	Pentium 4-M 1.8-GHz	15.0-in XGA	30 GB	combination + diskette	256 MB/64 MB integrated	iNIC + modem	Li ion
DC769T ABH	Pentium 4-M 1.8-GHz	15.0-in XGA	30 GB	combination + diskette	256 MB/64 MB integrated	iNIC + modem	Li ion
DC769T ABU	Pentium 4-M 1.8-GHz	15.0-in XGA	30 GB	combination + diskette	256 MB/64 MB integrated	iNIC + modem	Li ion
DC769T ABZ	Pentium 4-M 1.8-GHz	15.0-in XGA	30 GB	combination + diskette	256 MB/64 MB integrated	iNIC + modem	Li ion
DC770T ABD	Pentium 4-M 1.8-GHz	14.1-in XGA	30 GB	combination + diskette	256 MB/64 MB integrated	iNIC + modem	Li ion
DC770T ABF	Pentium 4-M 1.8-GHz	14.1-in XGA	30 GB	combination + diskette	256 MB/64 MB integrated	iNIC + modem	Li ion

Notebook Product *	CPU **	Display	Hard Drive	CD/DVD Drives	Standard SDRAM/ Video Mem	Communication	Battery
Compaq Evo Notebook N1010v Series							
F5771 J/ABJ	Celeron 1.6-GHz	14.1-in XGA	20 GB	CD + diskette	128 MB/uma	LAN + modem	Li ion
F5772 J/ABJ	Celeron 1.6-GHz	14.1-in XGA	30 GB	CD + diskette	256 MB/uma	LAN + modem	Li ion
Compaq Presario 2500 Series Mobile PC							
DB390A ABA	Pentium 4-D 2.4-GHz	15.0-in XGA	60 GB	combination + diskette	512 MB/64 MB integrated	iNIC + modem + 802.11b	Li ion
DB391A ABA	Pentium 4-D 2.4-GHz	15.0-in XGA	40 GB	combination + diskette	512 MB/64 MB integrated	iNIC + modem	Li ion
DC606A AB2	Pentium 4-D 2.4-GHz	14.1-in XGA	40 GB	DVD + diskette	256 MB/64 MB integrated	iNIC + modem	Li ion
DC607A ABM	Pentium 4-D 2.0-GHz	14.1-in XGA	40 GB	combination + diskette	256 MB/64 MB integrated	iNIC + modem	Li ion
DC609A ABM	Pentium 4-D 2.6-GHz	15.0-in XGA	60 GB	combination + diskette	512 MB/64 MB integrated	iNIC + modem	Li ion
DC715A ABC	Pentium 4-D 2.4-GHz	15.0-in XGA	60 GB	combination/ no diskette	512 MB/64 MB integrated	iNIC + modem + 802.11b	Li ion
DC715A ABL	Pentium 4-D 2.4-GHz	15.0-in XGA	60 GB	combination/ no diskette	512 MB/64 MB integrated	iNIC + modem + 802.11b	Li ion
DC716A ACJ	Pentium 4-D 2.66-GHz	15.0-in XGA	40 GB	combination + diskette	512 MB/64 MB integrated	iNIC + modem	Li ion
DC716A AKL	Pentium 4-D 2.66-GHz	15.0-in XGA	40 GB	combination + diskette	512 MB/64 MB integrated	iNIC + modem	Li ion
DC716A UUF	Pentium 4-D 2.66-GHz	15.0-in XGA	40 GB	combination + diskette	512 MB/64 MB integrated	iNIC + modem	Li ion
DC717A ACJ	Pentium 4-D 2.4-GHz	15.0-in XGA	30 GB	combination + diskette	256 MB/64 MB integrated	iNIC + modem	Li ion
DC717A AKL	Pentium 4-D 2.4-GHz	15.0-in XGA	30 GB	combination + diskette	256 MB/64 MB integrated	iNIC + modem	Li ion
DC717A UUF	Pentium 4-D 2.4-GHz	15.0-in XGA	30 GB	combination + diskette	256 MB/64 MB integrated	iNIC + modem	Li ion
DC718A ABG	Pentium 4-D 2.80-GHz	15.0-in XGA	40 GB	combination + diskette	256 MB/64 MB integrated	iNIC, modem, + 802.11b	Li ion
DC718A UUF	Pentium 4-D 2.80-GHz	15.0-in XGA	40 GB	combination + diskette	256 MB/64 MB integrated	iNIC, modem, + 802.11b	Li ion
DC719A AB1	Pentium 4-D 2.53-GHz	14.1-in XGA	30 GB	CD-ROM + diskette	256 MB/64 MB integrated	iNIC + modem	Li ion
DC719A AB5	Pentium 4-D 2.53-GHz	14.1-in XGA	30 GB	CD-ROM + diskette	256 MB/64 MB integrated	iNIC + modem	Li ion
DC720A AB2	Pentium 4-D 2.53-GHz	14.1-in XGA	40 GB	DVD + diskette	256 MB/64 MB integrated	iNIC + modem	Li ion
DC721A ABG	Pentium 4-D 2.40-GHz	14.1-in XGA	40 GB	combination + diskette	256 MB/64 MB integrated	iNIC, modem, + 802.11b	Li ion
DC722A AB5	Pentium 4-D 2.53-GHz	14.1-in XGA	40 GB	combination + diskette	256 MB/64 MB integrated	iNIC + modem	Li ion
DC723A AB0	Pentium 4-D 2.53-GHz	15.0-in XGA	40 GB	combination + diskette	256 MB/64 MB integrated	iNIC, modem, + 802.11b	Li ion
DC724A AB0	Pentium 4-D 2.53-GHz	15.0-in XGA	30 GB	DVD + diskette	256 MB/64 MB integrated	iNIC + modem	Li ion
DC725A AB0	Pentium 4-D 2.4-GHz	15.0-in XGA	40 GB	combination + diskette	256 MB/64 MB integrated	iNIC + modem	Li ion
DC726A ABO	Pentium 4-D 2.4-GHz	14.1-in XGA	30 GB	DVD + diskette	256 MB/64 MB integrated	iNIC + modem	Li ion

Notebook Product *	CPU **	Display	Hard Drive	CD/DVD Drives	Standard SDRAM/ Video Mem	Communication	Battery
Compaq Presario 2500 Series Mobile PC (continued)							
DC727A AB1	Pentium 4-D 2.66-Hz	15.0-in SXGA	40 GB	combination + diskette	512 MB/64 MB integrated	iNIC + modem	Li ion
DC728A AB1	Pentium 4-D 2.40-GHz	15.0-in SXGA	30 GB	combination + diskette	256 MB/64 MB integrated	iNIC + modem	Li ion
DC730A ABF	Pentium 4-D 2.53-GHz	15.0-in XGA	30 GB	combination + diskette	512 MB/64 MB integrated	iNIC + modem	Li ion
DC731A ABB	Pentium 4-D 2.53-GHz	15.0-in XGA	40 GB	combination + diskette	512 MB/64 MB integrated	iNIC + modem	Li ion
DC731A ABE	Pentium 4-D 2.53-GHz	15.0-in XGA	40 GB	combination + diskette	512 MB/64 MB integrated	iNIC + modem	Li ion
DC731A ABF	Pentium 4-D 2.53-GHz	15.0-in XGA	40 GB	combination + diskette	512 MB/64 MB integrated	iNIC + modem	Li ion
DC731A ABH	Pentium 4-D 2.53-GHz	15.0-in XGA	40 GB	combination + diskette	512 MB/64 MB integrated	iNIC + modem	Li ion
DC731A ABT	Pentium 4-D 2.53-GHz	15.0-in XGA	40 GB	combination + diskette	512 MB/64 MB integrated	iNIC + modem	Li ion
DC731A ABV	Pentium 4-D 2.53-GHz	15.0-in XGA	40 GB	combination + diskette	512 MB/64 MB integrated	iNIC + modem	Li ion
DC731A ABY	Pentium 4-D 2.53-GHz	15.0-in XGA	40 GB	combination + diskette	512 MB/64 MB integrated	iNIC + modem	Li ion
DC731A ABZ	Pentium 4-D 2.53-GHz	15.0-in XGA	40 GB	combination + diskette	512 MB/64 MB integrated	iNIC + modem	Li ion
DC731A AB9	Pentium 4-D 2.53-GHz	15.0-in XGA	40 GB	combination + diskette	512 MB/64 MB integrated	iNIC + modem	Li ion
DC731A AK7	Pentium 4-D 2.53-GHz	15.0-in XGA	40 GB	combination + diskette	512 MB/64 MB integrated	iNIC + modem	Li ion
DC731A AK8	Pentium 4-D 2.53-GHz	15.0-in XGA	40 GB	combination + diskette	512 MB/64 MB integrated	iNIC + modem	Li ion
DC732A ABE	Pentium 4-D 2.66-GHz	15.0-in XGA	40 GB	combination + diskette	512 MB/64 MB integrated	iNIC + modem	Li ion
DC732A UUG	Pentium 4-D 2.66-GHz	15.0-in XGA	40 GB	combination + diskette	512 MB/64 MB integrated	iNIC + modem	Li ion
DC733A ABU	Pentium 4-D 2.66-GHz	15.0-in XGA	40 GB	combination/ no diskette	512 MB/64 MB integrated	iNIC + modem	Li ion
DC734A ABB	Pentium 4-D 2.8-GHz	15.0-in XGA	40 GB	combination + diskette	512 MB/64 MB integrated	iNIC + modem	Li ion
DC734A ABV	Pentium 4-D 2.8-GHz	15.0-in XGA	40 GB	combination + diskette	512 MB/64 MB integrated	iNIC + modem	Li ion
DC754 ABB	Pentium 4-D 2.53-GHz	15.0-in XGA	40 GB	combination + diskette	256 MB/64 MB integrated	iNIC + modem	Li ion
DC754 ABV	Pentium 4-D 2.53-GHz	15.0-in XGA	40 GB	combination + diskette	256 MB/64 MB integrated	iNIC + modem	Li ion
DC755A ABE	Pentium 4-D 2.40-GHz	15.0-in XGA	30 GB	combination	256 MB/64 MB integrated	iNIC + modem	Li ion
DC755A ABZ	Pentium 4-D 2.40-GHz	15.0-in XGA	30 GB	combination	256 MB/64 MB integrated	iNIC + modem	Li ion
DC755A UUG	Pentium 4-D 2.40-GHz	15.0-in XGA	30 GB	combination	256 MB/64 MB integrated	iNIC + modem	Li ion
DC660 ABU	Pentium 4-D 2.80-GHz	15.0-in XGA	60 GB	combination	512 MB/64 MB integrated	iNIC, modem, + 802.11b	Li ion
DC817A ABU	Pentium 4-D 2.53-GHz	15.0-in XGA	30 GB	combination + diskette	384 MB/64 MB integrated	iNIC + modem	Li ion

Notebook Product *	CPU **	Display	Hard Drive	CD/DVD Drives	Standard SDRAM/ Video Mem	Communication	Battery
Compaq Presario 2100 Series Mobile PC							
DB381A ABA	Athlon 1.53-GHz	14.1-in XGA	40 GB	combination/ no diskette	512 MB/64 MB integrated	iNIC + modem	Li ion
DB382A ABA	Athlon 1.67-GHz	15.0-in XGA	60 GB	combination/ no diskette	512 MB/64 MB integrated	iNIC + modem	Li ion
DB383A ABA	Athlon 1.46-GHz	14.1-in XGA	20 GB	combination/ no diskette	256 MB/64 MB integrated	iNIC + modem	Li ion
DB954A ABA	Celeron 1.6-GHz	14.1-in XGA	30 GB	combination/ no diskette	256 MB/64 MB integrated	iNIC + modem	Li ion
DC582A ABM	Celeron 1.6-GHz	14.1-in XGA	30 GB	CDRW + diskette	128 MB/16 MB integrated	iNIC + modem	Li ion
DC583A ABA	Celeron 1.7-GHz	15.0-in XGA	20 GB	DVD + diskette	256 MB/64 MB integrated	iNIC + modem	Li ion
DC584A ABA	Celeron 1.8-GHz	15.0-in XGA	40 GB	combination/ no diskette	512 MB/64 MB integrated	iNIC + modem	Li ion
DC585A AB2	Pentium 4-M 1.9-GHz	14.1-in XGA	40 GB	DVD/ no diskette	256 MB/64 MB integrated	iNIC + modem	Li ion
DC586A AB5	Pentium 4-M 1.9-GHz	14.1-in XGA	20 GB	DVD + diskette	256 MB/64 MB integrated	iNIC + modem	Li ion
DC587A AB5	Pentium 4-M 2.0-GHz	14.1-in XGA	30 GB	combination + diskette	256 MB/64 MB integrated	iNIC + modem	Li ion
DC588A AB0	Pentium 4-M 1.9-GHz	15.0-in XGA	40 GB	DVD + diskette	256 MB/64 MB integrated	iNIC + modem	Li ion
DC589A AB0	Pentium 4-M 2.0-GHz	14.1-in XGA	40 GB	DVD + diskette	256 MB/64 MB integrated	iNIC, modem, + 802.11b	Li ion
DC700A ABC	Athlon 1.53-GHz	14.1-in XGA	40 GB	combination + diskette	512 MB/64 MB integrated	iNIC + modem	Li ion
DC700A ABL	Athlon 1.53-GHz	14.1-in XGA	40 GB	combination + diskette	512 MB/64 MB integrated	iNIC + modem	Li ion
DC701A ABC	Athlon 1.67-GHz	15.0-in XGA	60 GB	combination/ no diskette	256 MB/64 MB integrated	iNIC + modem	Li ion
DC701A ABL	Athlon 1.67-GHz	15.0-in XGA	20 GB	combination/ no diskette	256 MB/64 MB integrated	iNIC + modem	Li ion
DC702A ABF	Athlon 1.53-GHz	14.1-in XGA	20 GB	DVD + diskette	512 MB/64 MB integrated	iNIC + modem	Li ion
DC703A ABE	Athlon 1.53-GHz	14.1-in XGA	30 GB	combination + diskette	256 MB/64 MB integrated	iNIC + modem	Li ion
DC703A ABF	Athlon 1.53-GHz	14.1-in XGA	30 GB	combination + diskette	256 MB/64 MB integrated	iNIC + modem	Li ion
DC704A UUF	Athlon 1.46-GHz	14.1-in XGA	30 GB	CD-ROM + diskette	128 MB/16 MB integrated	iNIC + modem	Li ion
DC705A ABG	Athlon 1.67-GHz	14.1-in XGA	30 GB	combination + diskette	256 MB/64 MB integrated	iNIC + modem	Li ion
DC705A UUF	Athlon 1.67-GHz	14.1-in XGA	30 GB	combination + diskette	256 MB/64 MB integrated	iNIC + modem	Li ion
DC706A ABG	Athlon 1.80-GHz	15.0-in XGA	40 GB	combination + diskette	256 MB/64 MB integrated	iNIC + modem	Li ion
DC706A UUF	Athlon 1.80-GHz	15.0-in XGA	40 GB	combination + diskette	256 MB/64 MB integrated	iNIC + modem	Li ion
DC707A ABG	Athlon 1.67-GHz	15.0-in XGA	30 GB	DVD + diskette	256 MB/64 MB integrated	iNIC + modem	Li ion
DC708A ABG	Athlon 1.53-GHz	14.1-in XGA	30 GB	combination + diskette	256 MB/64 MB integrated	iNIC + modem	Li ion

Notebook Product *	CPU **	Display	Hard Drive	CD/DVD Drives	Standard SDRAM/ Video Mem	Communication	Battery
Compaq Presario 2100 Series Mobile PC (continued)							
DC735A ABC	Celeron 1.6-GHz	14.1-in XGA	30 MB	combination + diskette	256 MB/64 MB integrated	iNIC + modem	Li ion
DC735A ABL	Celeron 1.6-GHz	14.1-in XGA	30 MB	combination + diskette	256 MB/64 MB integrated	iNIC + modem	Li ion
DC736A AB0	Pentium 4-M 2.0-GHz	14.1-in XGA	40 MB	DVD + diskette	256 MB/64 MB integrated	iNIC + modem	Li ion
DC736A AB2	Pentium 4-M 2.0-GHz	14.1-in XGA	40 MB	DVD + diskette	256 MB/64 MB integrated	iNIC + modem	Li ion
DC737A AB0	Celeron 1.7-GHz	15.0-in XGA	30 MB	DVD + diskette	256 MB/64 MB integrated	iNIC + modem	Li ion
DC738A AB2	Celeron 1.6-GHz	14.1-in XGA	20 MB	CD-ROM + diskette	128 MB/32 MB integrated	iNIC + modem	Li ion
DC738A ACJ	Celeron 1.6-GHz	14.1-in XGA	20 MB	CD-ROM + diskette	128 MB/32 MB integrated	iNIC + modem	Li ion
DC738A AKL	Celeron 1.6-GHz	14.1-in XGA	20 MB	CD-ROM + diskette	128 MB/32 MB integrated	iNIC + modem	Li ion
DC738A UUF	Celeron 1.6-GHz	14.1-in XGA	20 MB	CD-ROM + diskette	128 MB/32 MB integrated	iNIC + modem	Li ion
DC739A ACJ	Pentium 4-M 1.8-GHz	14.1-in XGA	30 MB	CD-ROM + diskette	128 MB/16 MB integrated	iNIC + modem	Li ion
DC739A AKL	Pentium 4-M 1.8-GHz	14.1-in XGA	30 MB	CD-ROM + diskette	128 MB/16 MB integrated	iNIC + modem	Li ion
DC739A UUF	Pentium 4-M 1.8-GHz	14.1-in XGA	30 MB	CD-ROM + diskette	128 MB/16 MB integrated	iNIC + modem	Li ion
DC740A ACJ	Pentium 4-M 2.0-GHz	15.0-in XGA	30 MB	combination + diskette	256 MB/64 MB integrated	iNIC + modem	Li ion
DC740A AKL	Pentium 4-M 2.0-GHz	15.0-in XGA	30 MB	combination + diskette	256 MB/64 MB integrated	iNIC + modem	Li ion
DC740A UUF	Pentium 4-M 2.0-GHz	15.0-in XGA	30 MB	combination + diskette	256 MB/64 MB integrated	iNIC + modem	Li ion
DC741A ACJ	Pentium 4-M 2.0-GHz	15.0-in XGA	40 MB	combination + diskette	512 MB/64 MB integrated	iNIC + modem	Li ion
DC741A AKL	Pentium 4-M 2.0-GHz	15.0-in XGA	40 MB	combination + diskette	512 MB/64 MB integrated	iNIC + modem	Li ion
DC741A UUF	Pentium 4-M 2.0-GHz	15.0-in XGA	40 MB	combination + diskette	512 MB/64 MB integrated	iNIC + modem	Li ion
DC742A ABB	Celeron 1.6-GHz	14.1-in XGA	20 GB	DVD + diskette	256 MB/64 MB integrated	iNIC + modem	Li ion
DC742A ABH	Celeron 1.6-GHz	14.1-in XGA	20 GB	DVD + diskette	256 MB/64 MB integrated	iNIC + modem	Li ion
DC742A ABT	Celeron 1.6-GHz	14.1-in XGA	20 GB	DVD + diskette	256 MB/64 MB integrated	iNIC + modem	Li ion
DC742A ABV	Celeron 1.6-GHz	14.1-in XGA	20 GB	DVD + diskette	256 MB/64 MB integrated	iNIC + modem	Li ion
DC742A ABY	Celeron 1.6-GHz	14.1-in XGA	20 GB	DVD + diskette	256 MB/64 MB integrated	iNIC + modem	Li ion
DC742A ABZ	Celeron 1.6-GHz	14.1-in XGA	20 GB	DVD + diskette	256 MB/64 MB integrated	iNIC + modem	Li ion
DC742A AB9	Celeron 1.6-GHz	14.1-in XGA	20 GB	DVD + diskette	256 MB/64 MB integrated	iNIC + modem	Li ion
DC742A AK8	Celeron 1.6-GHz	14.1-in XGA	20 GB	DVD + diskette	256 MB/64 MB integrated	iNIC + modem	Li ion

Notebook Product *	CPU **	Display	Hard Drive	CD/DVD Drives	Standard SDRAM/ Video Mem	Communication	Battery
Compaq Presario 2100 Series Mobile PC (continued)							
DC742A UUG	Celeron 1.6-GHz	14.1-in XGA	20 GB	DVD + diskette	256 MB/64 MB integrated	iNIC + modem	Li ion
DC743A ABB	Celeron 1.8-GHz	15.0-in XGA	20 GB	combination + diskette	256 MB/64 MB integrated	iNIC + modem	Li ion
DC743A ABV	Celeron 1.8-GHz	15.0-in XGA	20 GB	combination + diskette	256 MB/64 MB integrated	iNIC + modem	Li ion
DC743A ABZ	Celeron 1.8-GHz	15.0-in XGA	20 GB	combination + diskette	256 MB/64 MB integrated	iNIC + modem	Li ion
DC743A UUG	Celeron 1.8-GHz	15.0-in XGA	20 GB	combination + diskette	256 MB/64 MB integrated	iNIC + modem	Li ion
DC744A ABB	Celeron 2.0-GHz	15.0-in XGA	30 GB	combination + diskette	256 MB/64 MB integrated	iNIC + modem	Li ion
DC744A ABT	Celeron 2.0-GHz	15.0-in XGA	30 GB	combination + diskette	256 MB/64 MB integrated	iNIC + modem	Li ion
DC744A ABV	Celeron 2.0-GHz	15.0-in XGA	30 GB	combination + diskette	256 MB/64 MB integrated	iNIC + modem	Li ion
DC744A AB7	Celeron 2.0-GHz	15.0-in XGA	30 GB	combination + diskette	256 MB/64 MB integrated	iNIC + modem	Li ion
DC744A AB9	Celeron 2.0-GHz	15.0-in XGA	30 GB	combination + diskette	256 MB/64 MB integrated	iNIC + modem	Li ion
DC744A AK8	Celeron 2.0-GHz	15.0-in XGA	30 GB	combination + diskette	256 MB/64 MB integrated	iNIC + modem	Li ion
DC744A UUG	Celeron 2.0-GHz	15.0-in XGA	30 GB	combination + diskette	256 MB/64 MB integrated	iNIC + modem	Li ion
DC745A ABU	Celeron 2.0-GHz	15.0-in XGA	30 GB	combination/ no diskette	256 MB/64 MB integrated	iNIC + modem	Li ion
DC746A ABB	Pentium 4-M 2.0-GHz	15.0-in SXGA	40 GB	combination + diskette	512 MB/64 MB integrated	iNIC + modem	Li ion
DC746A ABE	Pentium 4-M 2.0-GHz	15.0-in SXGA	40 GB	combination + diskette	512 MB/64 MB integrated	iNIC + modem	Li ion
DC746A ABF	Pentium 4-M 2.0-GHz	15.0-in SXGA	40 GB	combination + diskette	512 MB/64 MB integrated	iNIC + modem	Li ion
DC746A ABV	Pentium 4-M 2.0-GHz	15.0-in SXGA	40 GB	combination + diskette	512 MB/64 MB integrated	iNIC + modem	Li ion
DC746A ABY	Pentium 4-M 2.0-GHz	15.0-in SXGA	40 GB	combination + diskette	512 MB/64 MB integrated	iNIC + modem	Li ion
DC746A AB7	Pentium 4-M 2.0-GHz	15.0-in SXGA	40 GB	combination + diskette	512 MB/64 MB integrated	iNIC + modem	Li ion
DC746A AK8	Pentium 4-M 2.0-GHz	15.0-in SXGA	40 GB	combination + diskette	512 MB/64 MB integrated	iNIC + modem	Li ion
DC747A ABM	Celeron 2.0-GHz	14.1-in XGA	40 GB	combination + diskette	256 MB/64 MB integrated	iNIC + modem	Li ion
DC802A ABF	Athlon 1.67-GHz	15.0-in XGA	30 GB	combination + diskette	256 MB/64 MB integrated	iNIC + modem	Li ion
DC802A ABZ	Athlon 1.67-GHz	15.0-in XGA	30 GB	combination + diskette	256 MB/64 MB integrated	iNIC + modem	Li ion
DC803A ABF	Athlon 1.8-GHz	15.0-in XGA	40 GB	combination + diskette	512 MB/64 MB integrated	iNIC + modem	Li ion
DC803A ABZ	Athlon 1.8-GHz	15.0-in XGA	40 GB	combination + diskette	512 MB/64 MB integrated	iNIC + modem	Li ion
DC805A ABF	Pentium 4-M 2.0-GHz	15.0-in SXGA	30 GB	combination + diskette	256 MB/64 MB integrated	iNIC + modem	Li ion

Notebook Product *	CPU **	Display	Hard Drive	CD/DVD Drives	Standard SDRAM/ Video Mem	Communication	Battery
Compaq Presario 2100 Series Mobile PC (continued)							
DC806A ABH	Celeron 1.6-GHz	14.1-in XGA	20 GB	combination + diskette	256 MB/64 MB integrated	iNIC + modem	Li ion
DC806A AB7	Celeron 1.6-GHz	14.1-in XGA	20 GB	combination + diskette	256 MB/64 MB integrated	iNIC + modem	Li ion
DC806A UUG	Celeron 1.6-GHz	14.1-in XGA	20 GB	combination + diskette	256 MB/64 MB integrated	iNIC + modem	Li ion
DC807A AK8	Celeron 1.8-GHz	14.1-in XGA	20 GB	combination + diskette	256 MB/64 MB integrated	iNIC + modem	Li ion
DC808A ABE	Celeron 2.0-GHz	15.0-in XGA	30 GB	combination + diskette	512 MB/64 MB integrated	iNIC + modem	Li ion
DC808A ABH	Celeron 2.0-GHz	15.0-in XGA	30 GB	combination + diskette	512 MB/64 MB integrated	iNIC + modem	Li ion
DC808A ABY	Celeron 2.0-GHz	15.0-in XGA	30 GB	combination + diskette	512 MB/64 MB integrated	iNIC + modem	Li ion
DC808A AB7	Celeron 2.0-GHz	15.0-in XGA	30 GB	combination + diskette	512 MB/64 MB integrated	iNIC + modem	Li ion
DC808A AK8	Celeron 2.0-GHz	15.0-in XGA	30 GB	combination + diskette	512 MB/64 MB integrated	iNIC + modem	Li ion
DC809A ABB	Pentium 4-M 1.8-GHz	15.0-in XGA	30 GB	combination + diskette	256 MB/64 MB integrated	iNIC + modem	Li ion
DC809A ABV	Pentium 4-M 1.8-GHz	15.0-in XGA	30 GB	combination + diskette	256 MB/64 MB integrated	iNIC + modem	Li ion
DC810A AK8	Pentium 4-M 2.0-GHz	15.0-in SXGA	40 GB	combination + diskette	512 MB/64 MB integrated	iNIC + modem + 802.11b	
DC811A ABZ	Pentium 4-M 2.2-GHz	15.0-in SXGA	60 GB	combination + diskette	512 MB/64 MB integrated	iNIC + modem	Li ion
DC849A AB0	Pentium 4-M 1.8-GHz	14.1-in XGA	30 GB	DVD + diskette	256 MB/64 MB integrated	iNIC + modem	Li ion
DD512A ABH	Pentium 4-M 2.0-GHz	15.0-in XGA	40 GB	combination + diskette	512 MB/64 MB integrated	iNIC + modem	Li ion
DD513A AK8	Celeron 1.8-GHz	14.1-in XGA	20 GB	DVD + diskette	256 MB/64 MB integrated	iNIC + modem	Li ion
DD514A UUG	Celeron 1.6-GHz	15.0-in XGA	20 GB	DVD + diskette	256 MB/64 MB integrated	iNIC + modem	Li ion
DD515A AB0	Pentium 4-M 2.0-GHz	14.1-in XGA	40 GB	combination + diskette	256 MB/64 MB integrated	iNIC + modem	Li ion
DD516A AB5	Pentium 4-M 1.8-GHz	14.1-in XGA	20 GB	DVD + diskette	256 MB/64 MB integrated	iNIC + modem	Li ion
DD517A ABA	Athlon 1.67-GHz	15.0-in. XGA	30 GB	combination, no diskette	256 MB/64 MB integrated	iNIC + modem	Li ion
DD664A ABU	Athlon 1.46-GHz	14.1-in. XGA	20 GB	DVD + diskette	256 MB/64 MB integrated	iNIC + modem	Li ion
DD668A ABU	Celeron 1.6-GHz	14.1-in XGA	20 GB	DVD + diskette	128 MB/32 MB integrated	iNIC + modem	Li ion
DD669A UUG	Celeron 1.7-GHz	14.1-in XGA	20 GB	DVD + diskette	128 MB/32 MB integrated	iNIC + modem	Li ion
DD670A AB5	Pentium 4-M 1.8-GHz	15.0-in XGA	30 GB	DVD + diskette	256 MB/64 MB integrated	iNIC + modem	Li ion
DD671A AB5	Pentium 4-M 2.0-GHz	15.0-in XGA	30 GB	combination + diskette	256 MB/64 MB integrated	iNIC + modem	Li ion

Notebook Product *	CPU **	Display	Hard Drive	CD/DVD Drives	Standard SDRAM/ Video Mem	Communication	Battery
Compaq Presario 1100 Series Mobile PC							
F5781 H/ABU	Celeron 1.6-GHz	14.1-in XGA	20 GB	DVD + diskette	256 MB/uma	LAN + modem	Li ion
F5781 H/ABZ	Celeron 1.6-GHz	14.1-in XGA	20 GB	DVD + diskette	256 MB/uma	LAN + modem	Li ion
F5782 H/ABZ	Celeron 1.6-GHz	14.1-in XGA	20 GB	combination + diskette	256 MB/uma	LAN + modem	Li ion
F5783 H/ABZ	Celeron 1.8-GHz	15.0-in XGA	30 GB	combination + diskette	256 MB/uma	LAN + modem	Li ion
F5876 H/ABD	Celeron 1.6-GHz	14.1-in XGA	20 GB	DVD + diskette	256 MB/uma	LAN + modem	Li ion
F5877 H/ABD	Celeron 1.6-GHz	14.1-in XGA	20 GB	combination + diskette	256 MB/uma	LAN + modem	Li ion
F5880 H/ABD	Celeron 1.8-GHz	14.1-in XGA	30 GB	combination + diskette	256 MB/uma	LAN + modem	Li ion

Table 1-2. Product Comparisons

	HP Pavilion ze5200	HP Pavilion ze4200
Processor*	Pentium 4-D (2.0-, 2.4-, and 2.8-GHz)	Pentium 4-M (1.8- and 2.0-GHz) Celeron (1.6-, 1.7-, 1.8-, and 2.0-GHz) Athlon (1.53-, 1.37-, and 1.80-GHz)
Memory	Up to 1 GB (1024 MB) SDRAM using 512 MB modules. At least 512 MB SDRAM preinstalled.	Up to 512 MB SDRAM using 256 MB modules. At least 128 MB SDRAM preinstalled.
Display	15.0-inch XGA (1024 × 768) or SXGA+ (1400 × 1050) or 14.1-inch XGA (1024 × 768) active-matrix TFT.	15.0-inch XGA (1024 × 768) or SXGA+ (1400 × 1050) or 14.1-inch XGA (1024 × 768) active-matrix TFT.
Video	ATI Mobility Radeon graphics accelerator with 16, 32, or 64 MB UMA graphics memory, 4x AGP graphics capability.	ATI Mobility Radeon graphics accelerator with 16, 32, or 64 MB UMA graphics memory, 4x AGP graphics capability.
Operating System	Windows XP Professional or Home preinstalled.	Windows XP Professional or Home preinstalled.
Power States	On, Standby, Hibernate, Off.	On, Standby, Hibernate, Off.
	HP Pavilion ze4100	Compaq Evo Notebook N1050v
Processor*	Pentium 4-M (1.7-, 1.8-, and 2.0-GHz) Celeron (1.6-, 1.7-, and 1.8-GHz)	Pentium 4-M (1.7-, 1.8-, and 2.0-GHz) Celeron (1.6-, 1.7-, and 1.8 GHz)
Memory	Up to 1 GB (1024 MB) SDRAM using 512 MB modules. At least 128 MB SDRAM preinstalled.	Up to 1 GB (1024 MB) SDRAM using 512 MB modules. At least 128 MB SDRAM preinstalled.
Display	15.0-inch XGA (1024 × 768) or SXGA+ (1400 × 1050) or 14.1-inch XGA (1024 × 768) active-matrix TFT.	15.0-inch XGA (1024 × 768) or SXGA+ (1400 × 1050) or 14.1-inch XGA (1024 × 768) active-matrix TFT.
Video	ATI Mobility Radeon graphics accelerator with 16, 32, or 64 MB UMA graphics memory, 4x AGP graphics capability.	ATI Mobility Radeon graphics accelerator with 16, 32, or 64 MB UMA graphics memory, 4x AGP graphics capability.
Operating System	Windows XP Professional or Home preinstalled.	Windows XP Professional or Home preinstalled.
Power States	On, Standby, Hibernate, Off.	On, Standby, Hibernate, Off.

	Compaq Evo Notebook N1010v	Compaq Presario 2500
Processor*	Celeron (1.6- and 1.8-GHz)	Pentium 4-D (2.0-, 2.4-, and 2.6-GHz)
Memory	Up to 512 MB SDRAM using 256 MB modules. At least 128 MB SDRAM preinstalled.	Up to 512 MB SDRAM using 256 MB modules. At least 256 MB SDRAM preinstalled.
Display	15.0-inch XGA (1024 × 768) or SXGA+ (1400 × 1050) or 14.1-inch XGA (1024 × 768) active-matrix TFT.	15.0-inch XGA (1024 × 768) or SXGA+ (1400 × 1050) or 14.1-inch XGA (1024 × 768) active-matrix TFT.
Video	ATI Mobility Radeon graphics accelerator with 16, 32, or 64 MB UMA graphics memory, 4x AGP graphics capability.	ATI Mobility Radeon graphics accelerator with 16, 32, or 64 MB UMA graphics memory, 4x AGP graphics capability.
Operating System	Windows XP Professional or Home preinstalled.	Windows XP Professional or Home preinstalled.
Power States	On, Standby, Hibernate, Off.	On, Standby, Hibernate, Off.
	Compaq Presario 2100	Compaq Presario 1100
Processor*	Pentium 4-M (1.8-, 1.9-, and 2.0-GHz) Celeron (1.6-, 1.7-, 1.8-, and 2.0-GHz) Athlon (1.46-, 1.53-, and 1.67-GHz)	Celeron (1.6- and 1.8-GHz)
Memory	Up to 1 GB (1024 MB) SDRAM using 512 MB modules. At least 128 MB SDRAM preinstalled.	Up to 512 MB SDRAM using 256 MB modules. At least 128 MB SDRAM preinstalled.
Display	15.0-inch XGA (1024 × 768) or SXGA+ (1400 × 1050) or 14.1-inch XGA (1024 × 768) active-matrix TFT.	15.0-inch XGA (1024 × 768) or SXGA+ (1400 × 1050) or 14.1-inch XGA (1024 × 768) active-matrix TFT.
Video	ATI Mobility Radeon graphics accelerator with 16, 32, or 64 MB UMA graphics memory, 4x AGP graphics capability.	ATI Mobility Radeon graphics accelerator with 16, 32, or 64 MB UMA graphics memory, 4x AGP graphics capability.
Operating System	Windows XP Professional or Home preinstalled.	Windows XP Professional or Home preinstalled.
Power States	On, Standby, Hibernate, Off.	On, Standby, Hibernate, Off.
* Intel Desktop Pentium 4-D, Intel Mobile Pentium 4-M, and Intel Celeron Mobile processors. All models feature HP TopTools, and are ACPI compliant.		

Features

The following three illustrations show the notebook's main external features. For an exploded view of the notebook, see page 4-2.

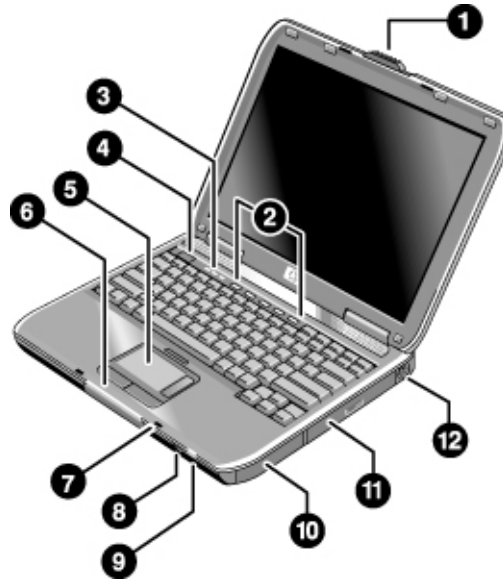

Figure 1-1. Front View

- | | |
|---|--|
| 1. Notebook open/close latch. | 7. Microphone option (not available). |
| 2. One-touch buttons. | 8. Infrared port.* |
| 3. Keyboard status lights. | 9. Wireless on-off button and indicator light.* |
| 4. Power button. Turns the notebook on and off. | 10. Battery. |
| 5. Touch pad, scroll pad, click buttons, plus on-off button. | 11. CD-ROM, DVD, or other drive. |
| 6. Main status lights (left to right): power mode, hard disk activity, battery. | 12. PS/2 keyboard or PS/2 mouse port (supports Y adapter). |
- * on certain models

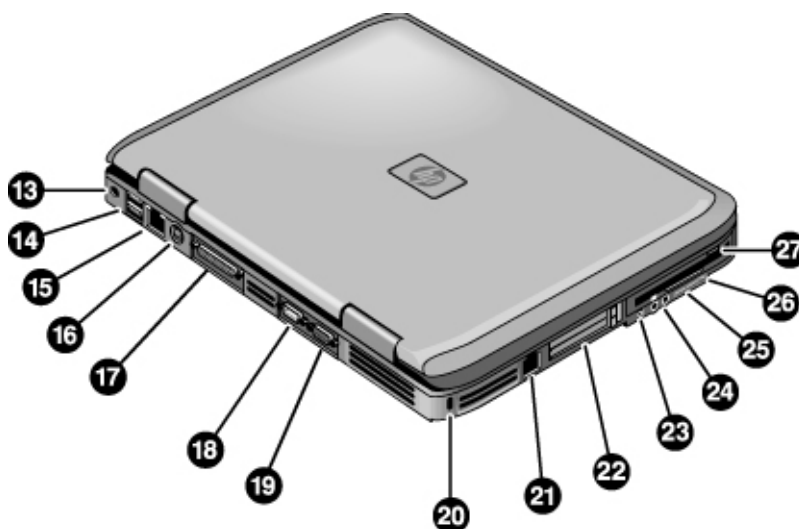

Figure 1-2. Back View

- | | |
|--|---|
| <ul style="list-style-type: none"> 13. AC adapter jack. 14. Two universal serial bus (USB) ports. 15. LAN port.* 16. S-video port.* 17. Parallel port (LPT1). Use this port for a parallel printer or other parallel device. 18. Serial port (COM1). Use this port for a serial mouse, modem, printer, or other serial device. 19. External monitor port. 20. Kensington lock slot (security connector). | <ul style="list-style-type: none"> 21. Modem port.* 22. PCMCIA card and CardBus slot and button. 23. IEEE 1394 port.* 24. Audio jacks (left to right): external microphone, audio out (headphones). 25. Volume controls.* 26. Audio mute button and audio mute light.* 27. Floppy drive.* <p>* on certain models</p> |
|--|---|

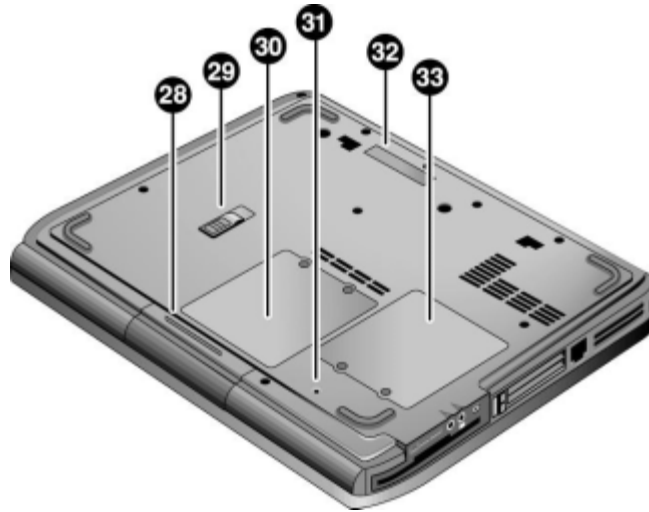

Figure 1-3. Bottom View

28. Hard disk drive.

29. Battery latch.

30. SDRAM door.

31. Reset button.

32. Port replicator connect.*

33. Mini-PCI door (no user parts inside).

* on certain models

Operation

This section gives an overview of the notebook's operation.

Turning the Notebook On and Off

You can start and stop your notebook using its power button. However, at certain times you might want to use other methods to start or stop the notebook—depending on power considerations, types of active connections, and start-up time.

Note

This manual describes the notebook in its original factory configuration, with all settings at their default values.







Table 1-3. Activating Power Modes

Power mode	To enter this mode
On Power mode status light is on.	Press the power button.
Standby mode Saves significant power. Turns off the display and other components. Maintains current session in RAM. Restarts quickly. Restores network connections. Power mode status light blinks.	Press the power button —or— click Start > Turn Off Computer > Stand By (Windows XP) —or— click Start > Shut Down > Standby (Windows 2000) —or— allow timeout.
Hibernation mode Saves maximum power. Saves current session to disk, then shuts down. Restores network connections. Power mode status light is off.	Press Fn+F12 —or— click Start > Shut Down > Hibernate (Windows 2000) —or— allow timeout.
Shut down (off) Saves maximum power. Turns off without saving current session. At startup, resets everything, starts a new session, and restores network connections. Power mode status light is off.	Click Start > Turn Off Computer > Turn Off (Windows XP) —or— click Start > Shut Down > Shut down (Windows 2000) —or— press the power button for 4 seconds (only if the Start menu procedure doesn't work).
To turn on: Press the power button to restart, or to resume your session from Standby or Hibernation mode.	

Checking the Status of the Notebook







The main status lights on the front of the notebook report power status, battery status, and hard disk activity.

Table 1-4. Main Status Lights (front of notebook)

  	Meaning
	Power status On: notebook is on (even if the display is off). Blinking: notebook is in Standby mode. Off: notebook is off or in Hibernation mode.
	Hard disk drive activity On: notebook is accessing the hard disk drive.
	Battery status Green: The AC adapter is connected and the battery is fully charged. Amber: The AC adapter is connected and the battery is charging. Blinking: The AC adapter is connected and the battery is missing or has a fault. Off: The AC adapter is not connected.

The keyboard status lights, located above the keyboard, indicate the states of the keyboard locks.

Table 1-5. Keyboard Status Lights

  	Meaning
	Caps Lock Caps Lock is active.
	Num Lock Num Lock is active. (The Keypad Lock must also be on to use the embedded keypad.)
	Keypad Lock The embedded keypad is active (Fn+F8). Num Lock must also be on for the numeric keys; otherwise, cursor control is active (as marked on an external keyboard).

Using Fn Hot Keys

The combination of the Fn key plus another key creates a *hot key*—a shortcut key sequence—for various system controls. To use a hot key, press *and hold* Fn, press the appropriate second key, then release both keys.

Table 1-6. Fn Hot Keys

Hot Key	Effect
Fn+F1	Decreases the display brightness.
Fn+F2	Increases the display brightness.
Fn+F5	Toggles among the built-in display, an external display, and simultaneous display on both.
Fn+F8	Toggles the built-in keypad on and off. Does not affect an external keyboard. If Num Lock is on, then the numeric functions are active; otherwise, cursor control is active (as marked on an external keyboard).
Fn+F12	Enters Hibernation mode.
Fn+NumLock	Toggles Scroll Lock on and off.
Fn+Page Up	Increases the audio volume and cancels the mute setting.
Fn+Page Down	Decreases the audio volume.
Fn+Backspace	Audio mute.

Resetting the Notebook

Occasionally, Windows or the notebook might stop responding, so that you cannot turn the notebook off. If this happens, try the following in the order listed. Press the power button to restart.

- If possible, shut down Windows:

Windows XP: press CTRL+ALT+DEL, and then click Shut Down, Restart.

Windows 2000: press CTRL+ALT+DEL, click Shut Down, and press the power button to restart.

- Press and hold the power button for about four seconds until the display shuts down, and then press the power button again to restart.
- Use a ball-point pen or a straightened paper clip to press the reset button on the bottom of the notebook.

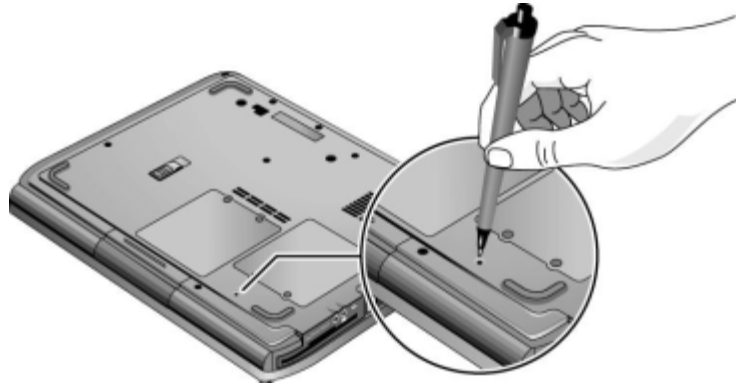

Figure 1-4. Resetting the Notebook

Note

To boot from a CD, insert a bootable CD (such as the *Recovery CDs*) into the CD/DVD drive, then restart. Press Esc when the HP logo appears, then select the CD/DVD drive as the temporary boot device.

Specifications

The following tables list the specifications for the notebook and its accessories. These are subject to change: for the latest versions, see the HP Notebook Web site (www.hp.com/notebooks).

Table 1-7. Specifications

Physical Attributes	<p>Size (14-inch display): 328 × 272 × 33 mm (12.9 × 10.7 × 1.3 in). Size (15-inch display): 328 × 272 × 35 mm (12.9 × 10.7 × 1.4 in). Weight: 2.9 kg (6.5 lb) minimum, depending on configuration.</p>
Processor and Bus Architecture	<p>HP Pavilion ze5200: 2.00-, 2.40-, 2.53-, 2.66-, or 2.80-GHz Intel Desktop Pentium 4 processor-D with Intel Speed Step technology, 512-KB L2 cache, and 1.2- to 1.3-V core low-power processor with 400-MHz processor system bus.</p> <p>HP Pavilion ze4200: 1.8-, 1.9-, 2.0-, or 2.2-GHz Intel Mobile Pentium 4 processor-M with Intel Speed Step technology, 512-KB L2 cache, and 1.2- to 1.3-V core low-power processor with 400-MHz processor system bus.</p> <p>or</p> <p>1.6-, 1.7-, 1.8-, or 2.0-GHz Intel Mobile Celeron processor with 256-KB L2 cache and 1.45-V core low-power processor with 133-MHz processor system bus.</p> <p>or</p> <p>1.46-, 1.53-, 1.67-, or 1.80-GHz Athlon processor with 256-KB L2 cache and 1.45-V core low-power processor with 133-MHz processor system bus.</p> <p>HP Pavilion ze4100: 1.7-, 1.8-, or 2.0-GHz Intel Mobile Pentium 4 processor-M with Intel Speed Step technology, 512-KB L2 cache, and 1.2- to 1.3-V core low-power processor with 400-MHz processor system bus.</p> <p>or</p> <p>1.6-, 1.7-, or 1.8-GHz Intel Mobile Celeron processor with 256-KB L2 cache and 1.45-V core low-power processor with 133-MHz processor system bus.</p> <p>Compaq Evo Notebook N1050: 1.8-GHz Intel Mobile Pentium 4 processor-M with Intel Speed Step technology, 512-KB L2 cache, and 1.2- to 1.3-V core low-power processor with 400-MHz processor system bus.</p> <p>or</p> <p>1.6-GHz Intel Mobile Celeron processor with 256-KB L2 cache and 1.45-V core low-power processor with 133-MHz processor system bus.</p> <p>Compaq Presario 2500: 2.00-, 2.40-, 2.53-, 2.60-, 2.66-, or 2.80-GHz Intel Desktop Pentium 4 processor-D with Intel Speed Step technology, 512-KB L2 cache, and 1.2- to 1.3-V core low-power processor with 400-MHz processor system bus.</p>

<p>Processor and Bus Architecture (continued)</p>	<p>Compaq Presario 2100: 1.8-, 1.9-, 2.0-, or 2.2-GHz Intel Mobile Pentium 4 processor-M with Intel Speed Step technology, 512-KB L2 cache, and 1.2- to 1.3-V core low-power processor with 400-MHz processor system bus.</p> <p>or</p> <p>1.6-, 1.7-, 1.8-, or 2.0-GHz Intel Mobile Celeron processor with 256-KB L2 cache and 1.45-V core low-power processor with 133-MHz processor system bus.</p> <p>or</p> <p>1.46-, 1.53-, 1.67-, or 1.80-GHz Athlon processor with 256-KB L2 cache and 1.45-V core low-power processor with 133-MHz processor system bus.</p> <p>Compaq Evo Notebook N1010v and Presario 1010: 1.6- or 1.8-GHz Intel Mobile Celeron processor with 256-KB L2 cache and 1.45-V core low-power processor with 133-MHz processor system bus.</p>
<p>Video</p>	<p>14.1-inch XGA (1024 × 768), or 15.0-inch XGA (1024 × 768) or SXGA+ (1400 × 1050) active-matrix (TFT) LCD display. Hardware 3D acceleration, hardware DVD acceleration.</p> <p>External monitors up to 1600 × 1200 resolution, 16M colors, and at least 85 Hz refresh rate (only 60 Hz at 1400 × 1050). Refresh rate and clarity may vary depending on monitor, resolution, and color depth. ATI Mobility Radeon graphics accelerator with 16- or 32-MB DDR graphics memory, 4x AGP graphics capability. Dual display capability (depends on operating system support).</p>
<p>Power</p>	<p>Rechargeable lithium-ion (14.8 Vdc) or nickel-metal-hydride (9.6 Vdc) battery with LED charge-level gauge. Battery life: up to 3 (Lilon) or 2 hours (NiMH) hours typical (varies with model, usage, and power settings). Fast battery recharge: 2 hours when system is off, 3 hours when system is on. Low-battery warning. Suspend/resume capability.</p> <p>Universal AC adapter: 100–240 Vac (50/60 Hz) input, 19 Vdc output, 75 W.</p>
<p>Mass Storage</p>	<p>20- to 40-GB removable hard drive with Ultra-DMA 100 interface. 1.44-MB floppy drive (certain models). 24x CD-ROM, or 8x DVD, or CD-RW, or CD-RW/DVD drive (or higher).</p>
<p>RAM</p>	<p>At least 128 MB SDRAM preinstalled.</p> <p>HP Pavilion ze5200, ze4200, ze4100, Compaq Evo N1050v, Compaq Presario 2500, and Compaq Presario 2100 Two slots for PC2100 DDR-266 SDRAM modules. Up to 1 GB (1024 MB) SDRAM using 512 MB modules.</p> <p>Compaq Evo N1010v and Presario 1100 Two slots for PC2100 DDR-266 SDRAM modules. Up to 512 MB SDRAM using 256 MB modules.</p>
<p>Audio System</p>	<p>Stereo sound via two built-in speakers. 3D-enhanced audio. Volume and mute buttons (certain models). Headphone-out and microphone-in.</p>
<p>Keyboard and Pointing Device</p>	<p>87/88-key touch-type QWERTY keyboard with 101/102 key emulation. Embedded numeric keypad. 12 function (Fn) keys. 5 user-programmable One-Touch buttons. Touch pad with integrated scroll pad, on-off button and indicator. Left and right click buttons.</p>
<p>LAN (certain models)</p>	<p>Ethernet 10Base-T (10 Mbps) and 100Base-TX (100 Mbps) support. Supports wake-on-LAN, fast IP, DMI, dRMON. MBA (Managed Boot Agent) support for PXE/BINL, NCP/IPX, DHCP.</p>

Modem (certain models)	Software-based modem. Data speed: 56 Kbps (V.92) maximum. Fax speed: 14.4 Kbps, Class 1 and 2. Modulation: V.21, V.22, V.22bis, V.23, V.32, V.32bis, V.34, V.90, V.92, X2, Bell 103, Bell 212A. Synchronous transfer: V.80. Compression: V.42bis, MNP5. Error correction: V.42, MNP2-4. Fax: Group 3 fax, Class 1. V.17, V.27ter, V.29, V.21.
Wireless LAN (certain models)	Radio: IEEE 802.11b, WECA Wi-Fi compliant, direct-sequence spread-spectrum. Operating frequency: 2.5-GHz ISM band, exact frequencies and channels depend on country. Raw data rate: 1, 2, 5.5, or 11 Mbps. Transmitter output: 15 dBm typical (approx. 30 mW), 16 dBm max (approx. 40 mW). Receiver sensitivity: -84 dBm typical. Range: up to 100 m (300 ft) or more, depending on environment and conditions. On-off button and indicator. Mini-PCI interface.
Input/Output	9-pin, 115,200-bps serial. 25-pin bi-directional ECP/EPP parallel. 15-pin VGA video-out with DDC support. S-video TV out (certain models). PS/2 keyboard/mouse. 4-Mbps IrDA-compliant infrared port (certain models). IEEE-1394 (certain models). Universal serial bus (USB 1.1), two ports.
Expandability	One or two 16-/32-bit PC Card slots, Type II or III, CardBus enabled. Optional port replicator (certain models).
Security Features	User and administrator passwords. System password. PC identification displayed at boot. WMI-accessible electronic serial number. Kensington MicroSaver lock slot.
Environmental Limits	Operating temperature: 5 to 35° C (41 to 95° F). Operating humidity: 20 to 90 percent RH (5 to 35° C). Operating altitude: up to 3000 m (10,000 ft) at 25° C (77° F). Storage temperature: -20 to 50° C (-4 to 122° F).
Major ICs	CPU: Intel Mobile Pentium 4 processor-M. Core logic: ALI 1671/1535+ chipset. Display controller: ATI Mobility Radeon M6-C/P. Audio/Modem controller: Conexant Smart AMC CX20468-21. CardBus controller: TI PC1520. Keyboard/embedded controller: National PC87570. Super I/O: integrated in core logic. IEEE 1394: TI TSB43AB22. LAN: National NS83815. 802.11b wireless LAN: Ambit with Intersil Prism 2.5 chipset. or CPU: Intel Mobile Celeron processor. Core logic: VIA Twister-T + VT8231 chipset. Display controller: S3 Savage Pro integrated in core logic. Audio/Modem controller: Conexant Smart AMC CX20468-21. CardBus controller: O2Micro 6912. Keyboard/embedded controller: National PC87570. Super I/O: integrated in core logic. LAN: VIA Phy, MAC integrated in core logic. 802.11b wireless LAN: Ambit with Intersil Prism 2.5 chipset.

Table 1-8. Accessories

Accessory	Description	Pavilion ze5200 and Presario 2500	Pavilion ze4200, Evo N1050v, and Presario 2100	Pavilion ze4200 and Presario 2100	Evo N1010v and Presario 1100	Pavilion ze4100
Memory						
F4694-60901 317434-001	128MB DDR266B		•	•	•	•
F4695-60901 317435-001	256MB DDR266B		•	•	•	•
F4696-60901 317436-001	512MB DDR266B		•	•		•
Hard Drives						
0950-4193 319412-001	HDD-20 GB 9.5mm, Hitachi ATA100	•	•	•	•	•
0950-4318	HDD-20 GB 9.5mm, IBM ATA100 FDB				•	•
0950-4287	HDD-20 GB 9.5mm, TOSH ATA100 FDB				•	•
0950-4168	HDD-30 GB 9.5mm, Hitachi ATA100				•	•
0950-4162 319413-001	HDD-30 GB 9.5mm, IBM (diablo) ATA100	•	•	•	•	•
0950-4319	HDD-30 GB 9.5mm, IBM ATA100 FDB (Cascade)				•	•
0950-4360	HDD-30 GB 9.5mm, TITAN Toshiba ATA100 (TITAN)				•	•
0950-4176	HDD-30 GB 9.5mm, Toshiba ATA100				•	•
0950-4320 319414-001	HDD-40 GB 9.5mm, IBM ATA100 FDB	•	•	•		•
0950-4288	HDD-40 GB 9.5mm, Toshiba ATA100					•
319415-001	SPS-DRV HD 60 G (4200 rpm)	•	•	•		
319416-001	SPS-DRV HD 60 G (5400 rpm)		•	•		
320692-001	SPS-DRV,HD,80GB,4200RPM	•				

Accessory	Description	Pavilion ze5200 and Presario 2500	Pavilion ze4200, Evo N1050v, and Presario 2100	Pavilion ze4200 and Presario 2100	Evo N1010v and Presario 1100	Pavilion ze4100
Power Options						
F4600-60901	AC-Adapter-Ultraslim Delta 75W s/PFC				•	•
F4809-60901 319411-001	Battery, Lilon 4.4Ahr 8 Cell Li-Ion	•	•	•	•	•
8120-6312 317444-011	Cord, Pwr, Austr #ABG (2w)			•	•	•
8120-6314	Cord, Pwr, Europe #ABB (2w)				•	•
317444-002	SPS-CORD-AC PWR 2 WIRE-INTL			•		
317444-061	SPS-CORD-AC PWR 2 WIRE-IT			•		
8120-6316 317444-291	Cord, Pwr, Japan #ABJ (2w)				•	•
317444-AD1	SPS-CORD-AC PWR 2 WIRE-KOR			•		
8120-8373 317444-AA1	Cord, Pwr, People's Republic of China #AB2 (2w)			•		
317444-101	SPS-CORD-AC PWR 2 WIRE-SWE			•		
317444-111	SPS-CORD-AC PWR 2 WIRE-SWI			•		
317444-AB1	SPS-CORD-AC PWR 2 WIRE-TAI			•		
8120-8699 317444-031	Cord, Pwr, UK (EPSR) For Hong Kong (2w)			•	•	•
8120-6313 317444-001	Cord, Pwr, US #ABA (2w)			•	•	•
PC Cards						
F4640-60978 319468-051	Card, mini-PCI-802.11B France	•	•	•		•
F4640-60977 319468-002	Card, mini-PCI-802.11B worldwide	•	•	•	•	•
Docking						
F4808-60901	Port Replicator Assy			•	•	•
F4808-60902	Simple Port Replicator hp/compaq				•	•

Internal Design

The motherboard PCA is the central component of the notebook's design. It plays a role in virtually all system functions. The CPU module and most other subsystems connect to the motherboard.

The following figure shows the connections among the notebook's replaceable electronic modules. Table 1-9 on page 1-28 lists the roles that these modules play in the notebook's functional subsystems.

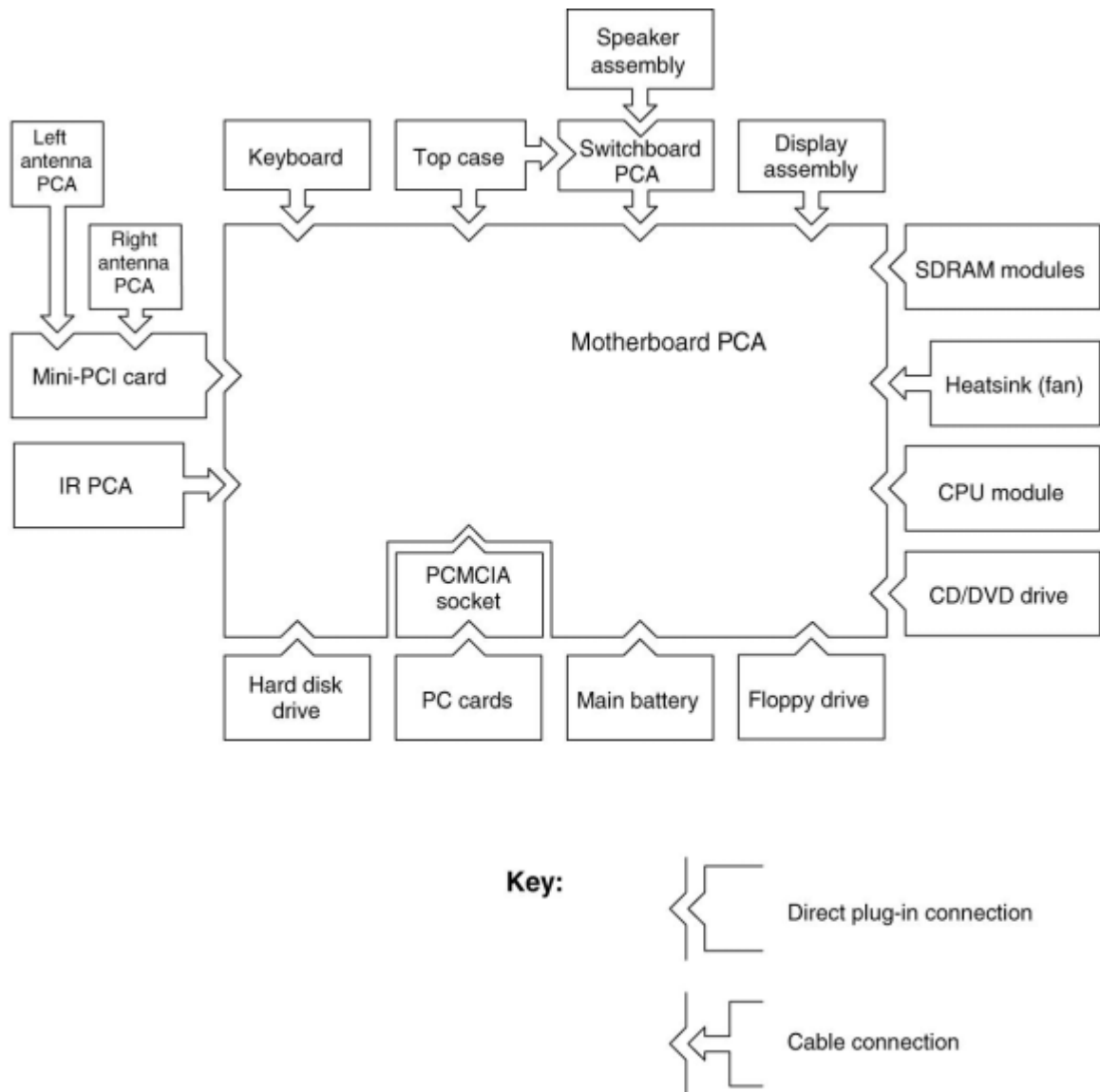

Figure 1-5. Replaceable Module Diagram

Table 1-9. Functional Structure Description

Bootup	CPU module Motherboard Hard disk drive Floppy drive	Main processor (MMO). Primary system circuitry, system BIOS. First source of disk-based startup code. Second source of disk-based startup code.
Processor	CPU module Motherboard	Main processor, numeric data processor, L1 and L2 cache. Primary system circuitry.
Memory	Motherboard SDRAM module	Video RAM (XE4500). Changeable SDRAM (2 slots), video RAM (XE4100).
Power	Battery Motherboard Switchboard PCA AC adapter	Power storage. AC adapter socket, reset button, lid switch, power supply, power control circuitry. Power button AC-to-DC converter.
Display	Motherboard SDRAM module Display assembly	Graphics controller, video RAM. Display output, backlight, power converter for backlight.
Hard disk	Motherboard Hard disk drive	Hard disk controller. Hard disk mechanism.
Floppy drive	Motherboard Floppy drive	I/O controller, floppy connector. Floppy drive mechanism.
Keyboard	Motherboard Switchboard PCA Keyboard	Keyboard BIOS, keyboard controller. Power switch, one-touch buttons Key switches.
PS/2 Touchpad	Motherboard Top case	Keyboard circuitry, keyboard controller, keyboard BIOS. Touch pad sensor, click buttons, controller (PS/2 output).
Audio	Motherboard Speaker assembly	Audio controller, audio decoder, speaker amplifier, microphone, external audio jacks, headphone amplifier, audio-off switch. Speakers.
Status	Motherboard Switchboard PCA Top case	LED circuitry, keyboard controller. Keyboard LEDs. Main status LEDs.
Serial	Motherboard	I/O controller, serial connector.
Parallel	Motherboard	I/O controller, parallel connector.
Infrared	Motherboard IR PCA	I/O controller. Infrared transmitter/receiver.
PS/2 port	Motherboard	PS/2 connector, keyboard controller.
USB	Motherboard	Bus controller (South Bridge), USB connector.
S-Video	Motherboard	I/O controller, S-video connector (certain models).
Port Replicator	Motherboard	Port replicator logic, port replicator connector (certain models).
PCMCIA	Motherboard PCMCIA socket	PCMCIA controller. PCMCIA connectors.
Wireless LAN (certain models)	Mini-PCI Antenna PCAs IR PCA	I/O controller, radio, radio frequency circuitry. Transmit/receive antennas. On/off switch, indicator light.
LAN	Motherboard	LAN circuitry, bus controller, LAN connector.
Modem	Motherboard	Modem circuitry (certain models), modem connector.

Removal and Replacement

This chapter tells you how to remove and replace the notebook's components and assemblies. The items marked by • in the following table are user-replaceable.

Table 2-1. Removal Cross-Reference

<ul style="list-style-type: none"> • Assembly, speaker (page 2-12). • Battery, CMOS (page 2-36). • Battery, main (page 2-4). • Card, wireless LAN mini-PCI (page 2-6). • Case, bottom (page 2-34). • Case, top (page 2-20). • Cover, keyboard (page 2-10). • Assembly, display (page 2-17). • Door, mini-PCI (page 2-9). • Door, SDRAM (page 2-9). • Doors, PCMCIA (page 2-34). • Drive, CD/DVD (page 2-16). 	<ul style="list-style-type: none"> • Drive, floppy (page 2-22). • Drive, hard disk (page 2-7). • Feet, rubber (page 2-9). • Heatsink (with fan) (page 2-26). • Keyboard (page 2-13). • Module, SDRAM (page 2-5). • Module, CPU (page 2-28). • PCA, antennas (page 2-17). • PCA, I/R (page 2-24). • PCA, motherboard (page 2-30). • PCA, switchboard (page 2-13). • Rubber screw plugs, display (page 2-9).
--	--

Caution

Always provide proper grounding when performing repairs. Without proper grounding, an electrostatic discharge can damage the notebook and its components.



Notes

Reassembly steps are the reverse of the removal steps. Reassembly notes are included at the end of each section below.

 Symbols like these are displayed throughout this chapter to show approximate full-size screw outlines. You can use these to verify the sizes of screws before you install them. Installing a wrong-size screw can damage the notebook. (The symbol at the left represents an M2.5 × 4 mm T-head screw.)

Table 2-2. Required Equipment

- #0 and #1 Phillips screwdrivers, preferably magnetized.
- Small flat-blade screwdriver.
- 5 mm nut driver

Table 2-3. Recommended Screw Torque Values

Screw Thread Size	Torque (cm-kgf)	Torque (in-lbf)
M2	2,0 – 2,5	1.7 – 2.2
M2.5 (hinges)	3,5 – 4,0	3.0 – 3.4
M2.5 (other)	2,5 – 3,0	2.2 – 2.6
M3	2,5 – 3,0	2.2 – 2.6
Standoff, hex	2,5 – 3,0	2.2 – 2.6

Disassembly Flowchart

The following diagram shows the general “path” you will use when disassembling the notebook to access any particular component.

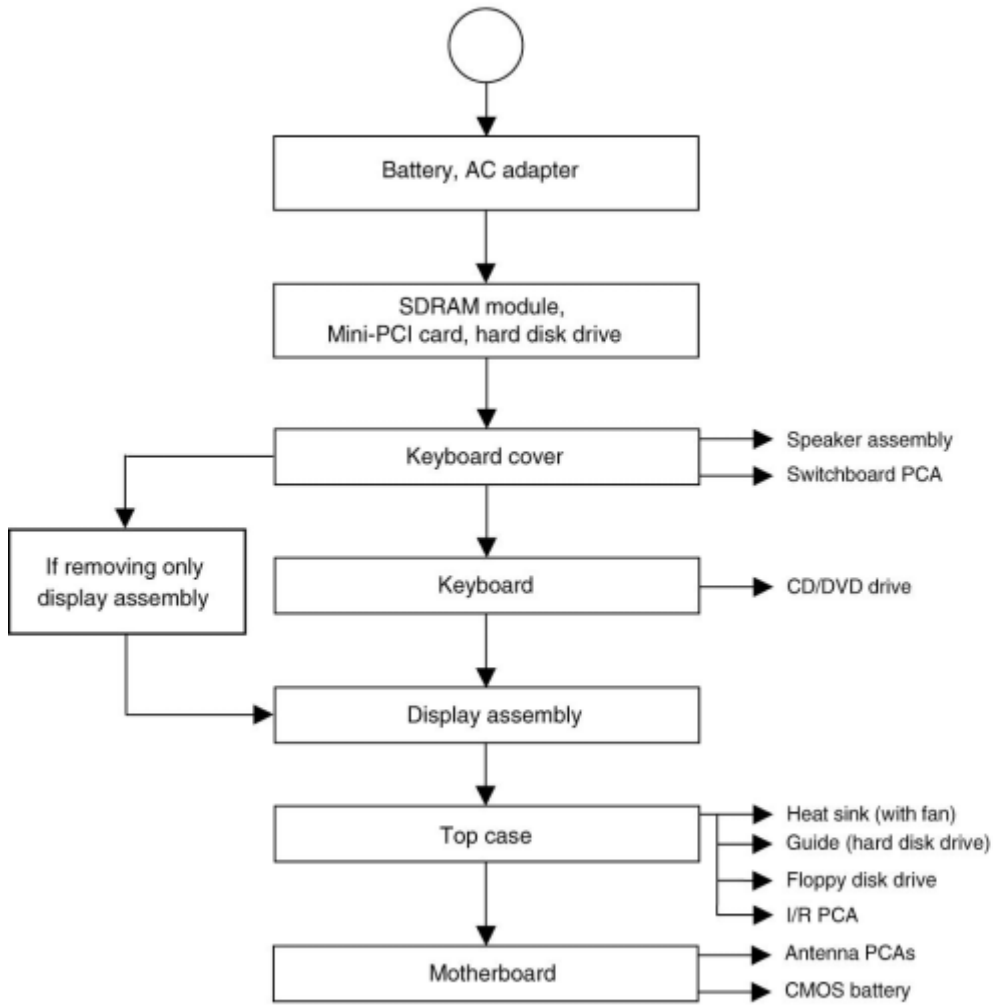

Figure 2-1. Disassembly Flow

Removing the Battery

(User-Replaceable)

Required Equipment

- None.

Removal Procedure

- Slide the battery's release latch, then pull the battery out of its compartment.

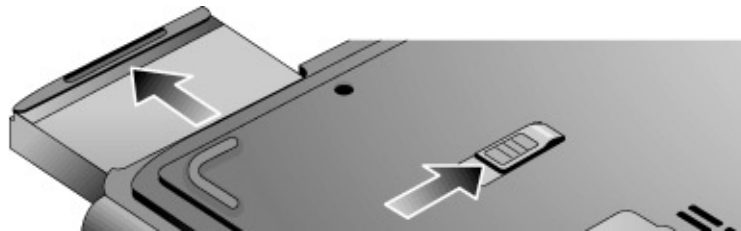

Figure 2-2. Removing the Battery

Removing a SDRAM Module (User-Replaceable)

The notebook has no system memory built into its motherboard, but has two slots for SDRAM modules. One slot contains an SDRAM module that was factory installed.

Note

HP Pavilion ze5200, ze4200, ze4100, Compaq Evo Notebook N1050v and N1010v, and Presario 2500, 2100, and 1100 notebooks use only DDR266 SDRAM modules. Using the wrong type of module prevents the notebook from booting.

Caution

Handle the SDRAM module only by its edges and provide proper grounding, or you might damage the module through electrostatic discharge.

Required Equipment

- #1 Phillips screwdriver.

Removal Procedure

1. Unplug the AC adapter, if present, and then remove the battery.
2. On the bottom of the notebook, loosen the captive screws holding the SDRAM door, and then remove the door.
3. Press outward on the latches at the sides of the SDRAM module to release it (the SDRAM module pops up).
4. Carefully pull the SDRAM module out of the connector.

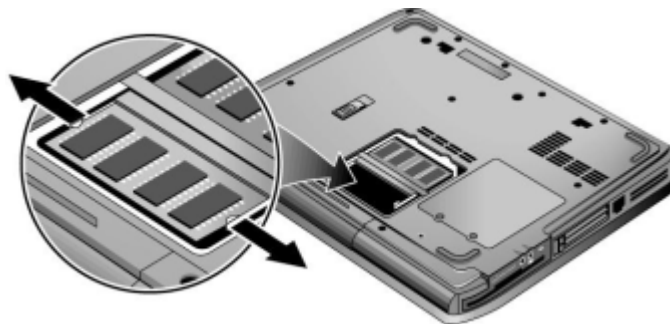

Figure 2-3. Removing an SDRAM Module

Reassembly Notes

- Carefully press the SDRAM module into the connector at an angle of about 30°, until it is fully inserted. Then press down on both sides of the SDRAM module until the latches snap closed.

Removing the Wireless LAN Mini-PCI Card (User-Replaceable)

Certain notebooks include a wireless LAN mini-PCI card under the mini-PCI door on the bottom of the notebook.

Caution

Handle the Mini-PCI card only by its edges and provide proper grounding, or you might damage the card through electrostatic discharge.

Required Equipment

- #0 Phillips screwdriver.

Removal Procedure

1. Unplug the AC adapter, if present, and then remove the battery.
2. On the bottom of the notebook, loosen the captive screws holding the Mini-PCI door, and then remove the door.

Caution

Be careful when connecting and disconnecting the antenna cables from the mini-PCI card. Damaged cables or connectors can degrade notebook performance.

3. Disconnect the two antenna cables from the mini-PCI card.
4. Press outward on the latches at the sides of the mini-PCI card to release it (the mini-PCI card pops up).
5. Carefully pull the mini-PCI card out of the connector.

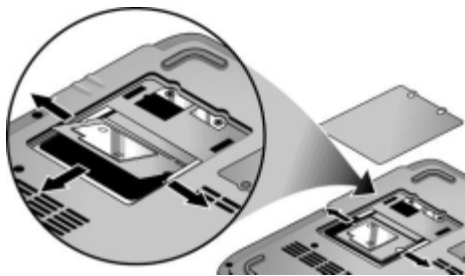

Figure 2-4. Removing the Mini-PCI Card

Reassembly Notes

- Carefully press the mini-PCI card into the connector at an angle of about 30°, until it is fully inserted. Then press down on both sides of the mini-PCI card until the latches snap closed.

Removing the Hard Disk Drive

(User-Replaceable)

Required Equipment

- #1 Phillips screwdriver.

Removal Procedure

Important

If you are installing a new hard disk drive, load the factory software and operating system on the drive as described in "Recovering the Factory Software," as shown on the next page.

1. Unplug the AC adapter, if present, and then remove the battery.
2. On the bottom of the notebook, remove the hard drive rubber screw plugs and retaining screws.
3. Carefully pull the hard drive out of the notebook.

Screw, M2.5×6mm (2)

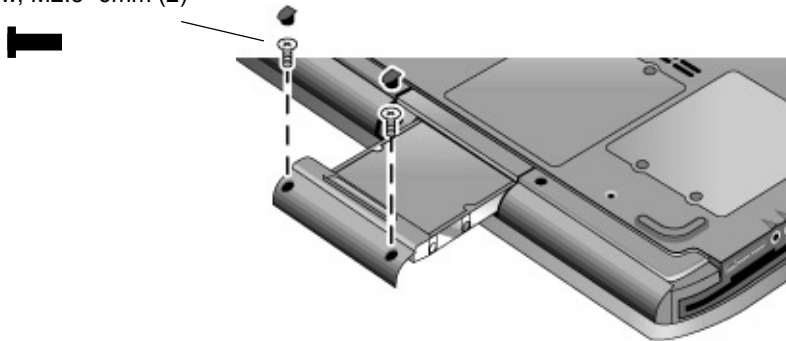

Figure 2-5. Removing the Hard Disk Drive

4. Remove the screws from the drive and drive tray, then lift the drive out of the tray.
5. Remove the connector from the hard disk drive.

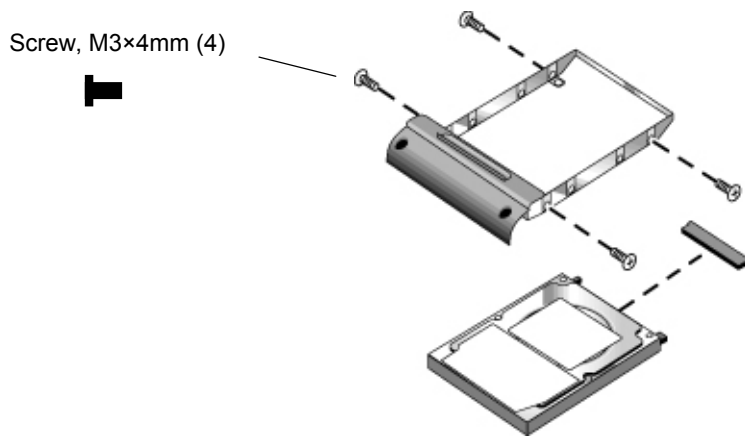

Figure 2-6. Removing the Hard Disk Drive Tray

Recovering the Factory Software

The following procedure describes how to recover the notebook's original software and operating system. This process can take up to 15 minutes to complete. (For more information about recovering the factory software installation, see the readme.txt file in the root directory of the *Recovery CDs*.)

Caution

Do not interrupt the following process or unplug the AC adapter until the process completes.

1. Connect the AC adapter to the notebook.
2. Insert *Recovery CD* disk 1 into the notebook's CD/DVD drive. If the notebook is turned off, use a pin or straightened paper clip to press the release switch on the drive door to open it.
3. Turn on or restart the notebook.
4. When the HP logo appears, press Esc to display the Boot menu.
5. Use the arrow keys to select the CD/DVD drive as the first boot device, then press Enter.
6. When the *Recovery CD* dialog box appears, follow the displayed instructions. If prompted, accept the recommended partition size.

To create the Utility partition without installing the factory software, click Advanced and select not to install the operating system.

If the hard disk is partitioned into several logical drives, you can install the factory software on drive C without affecting other drives. Click Advanced and select to restore only the C partition.

7. When prompted to reboot the notebook, press Ctrl+Alt+Del and follow any instructions that appear.

Replacing Small Parts (User-Replaceable)

The user can replace the following small parts.

Table 2-4. Replacing Small Parts (User-Replaceable)

Part	Replacement Procedure
Rubber screw plugs, display (on display bezel)	Insert a small flat-blade screwdriver under the rubber screw plug and pry it loose. To replace, firmly press the adhesive side of the screw plug into the recess.
Door, mini-PCI	On the bottom of the notebook, loosen the screws that secure the mini-PCI door to the bottom case and then remove the door.
Door, memory	On the bottom of the notebook, loosen the screws that secure the SDRAM module door to the bottom case and then remove the door.
Feet, rubber (on bottom of notebook)	Insert a small flat-blade screwdriver under the foot and pry it loose. To replace, firmly press the adhesive side of the foot into the recess.
Rubber cover, docking port (XE4500 only)	Grasp the rubber docking port cover with your fingers and gently remove it. To replace, firmly press the docking port cover into the opening in the bottom case.
Cover, modem port	Insert a small flat-blade screwdriver at the top of the cover and gently pry it loose. To replace, insert the cover into the modem port opening.

Removing the Keyboard Cover

(User-Replaceable)

Required Equipment

- #1 Phillips screwdriver.
- Small flat-blade screwdriver.

Removal Procedure

1. Unplug the AC adapter, if present, and then remove the battery.
2. Remove the two hinge cover screws that secure the keyboard cover to the rear of the notebook.
3. Carefully insert a flat-blade screwdriver blade under the keyboard cover near the right end, then near the center, then near the left end, and then gently lift up the center of the cover. Gently pry up the hinge covers if needed, being careful not to damage the plastics or wireless antenna underneath.

Caution

Be careful not to damage the antenna PCA that is connected to the left and right display assembly hinges. Damaging either antenna PCA can degrade notebook performance.

4. If necessary, while holding the center of the cover, carefully insert the flat-blade screwdriver under the right side of the display assembly hinge, gently pry up, and then lift the cover out. This procedure might need to be repeated on the left side of display assembly hinge to completely remove the cover.

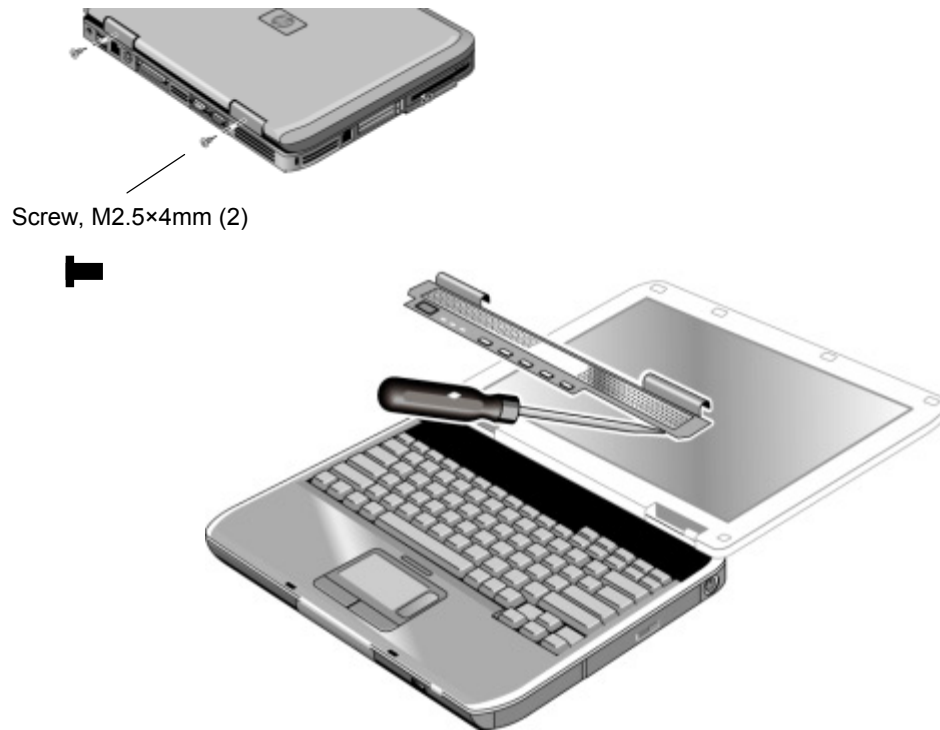

Figure 2-7. Removing the Keyboard Cover

Reassembly Note

- Insert the tabs on the left- and right-center of the panel into the mating slots under the keyboard, and then press the panel into place.

Removing the Speaker Assembly

(User-Replaceable)

Note: The following speaker assembly removal procedures apply only to Compaq Evo Notebook N1010v and Compaq Presario 1100 Series notebooks. The Pavilion ze4100 Series notebook speakers are integrated into the top case. Refer to the “Removing the Top Case” section later in this chapter for procedures on removing the top case and speakers on the Pavilion ze4100 Series notebook.

Required Equipment

- #1 Phillips screwdriver.

Removal Procedure

1. Unplug the AC adapter, if present, and then remove the battery.
2. Remove the keyboard cover (page 2-10).
3. Remove the screw that secures the speaker assembly to the top case.
4. Disconnect the 4-wire cable from the switchboard PCA.

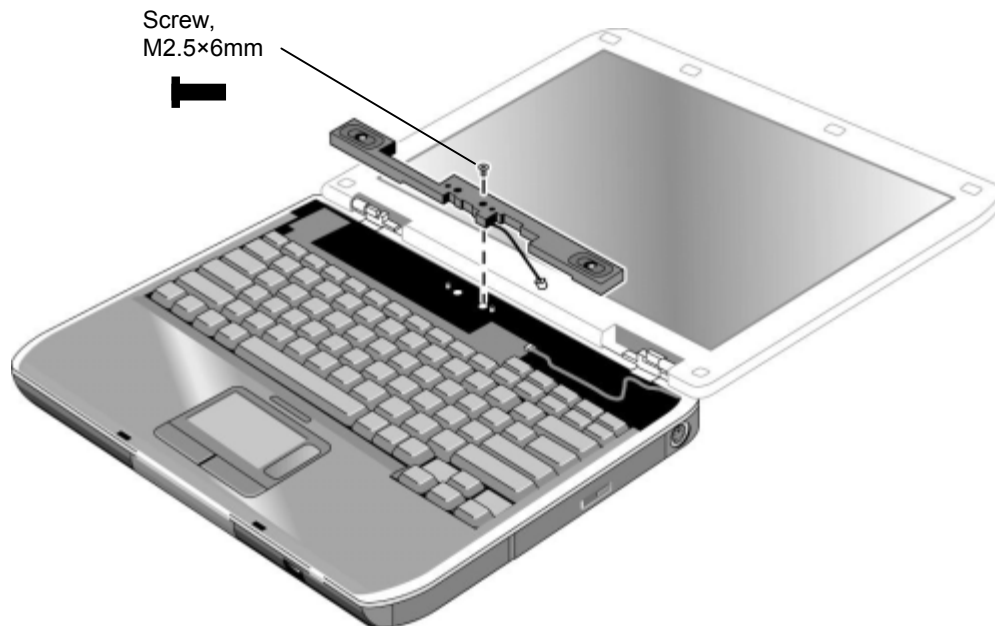

Figure 2-8. Removing the Speaker Assembly

Removing the Keyboard

(User-Replaceable)

Required Equipment

- #1 Phillips screwdriver.

Removal Procedure

1. Unplug the AC adapter, if present, and remove the battery.
2. Remove the keyboard cover (page 2-10).
3. Remove the screws that secure the keyboard to the top case.
4. Lift up on the keyboard at the switchboard PCA end and then pull it toward the display assembly to release the tabs from the top case.
5. Turn the keyboard over and disconnect the motherboard cable.
6. Remove the keyboard.

Reassembly Notes

Caution

Do not excessively bend or fold the keyboard cable. Excessive flexing can damage the keyboard cable connectors.

- Lay the keyboard face down on the top case, forward of its normal position, then reconnect the keyboard cable.
- Slide the metal tabs on the bottom of the keyboard into their slots in the top case, then lower the keyboard into place.

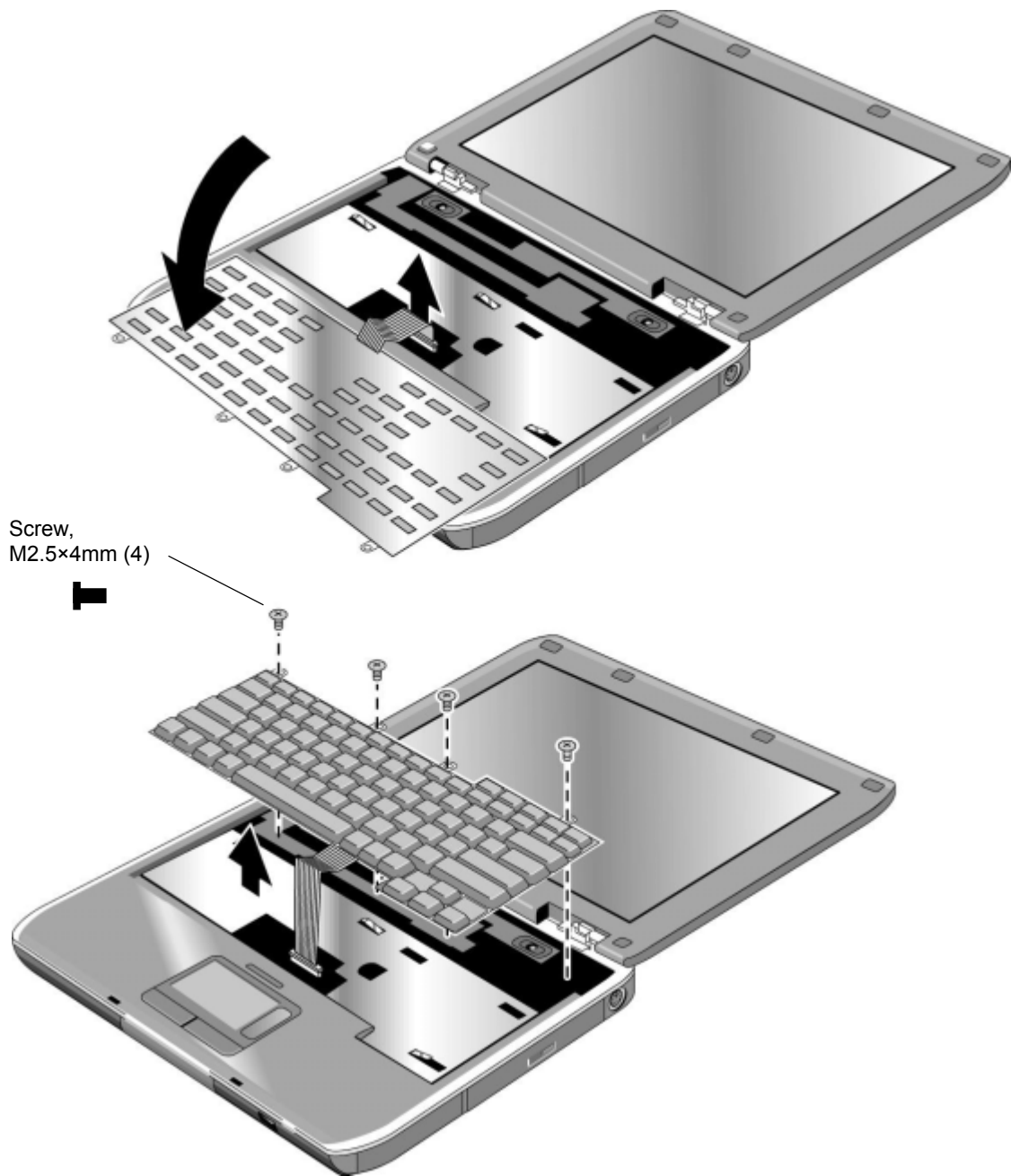

Figure 2-9. Removing the Keyboard

Removing the Switchboard PCA (User-Replaceable)

Required Equipment

- #1 Phillips screwdriver.

Removal Procedure

1. Unplug the AC adapter, if present, and then remove the battery.
2. Remove the keyboard cover (page 2-10).
3. Disconnect both the 2-wire and 4-wire cables that connect the switchboard PCA to the top case and speaker assembly, respectively.
4. Remove the screws that secure the keyboard and switchboard PCA to the top case (page 2-13).
5. Gently lift up on the keyboard, carefully remove the switchboard PCA from the top case, and then disconnect the underside motherboard cable.

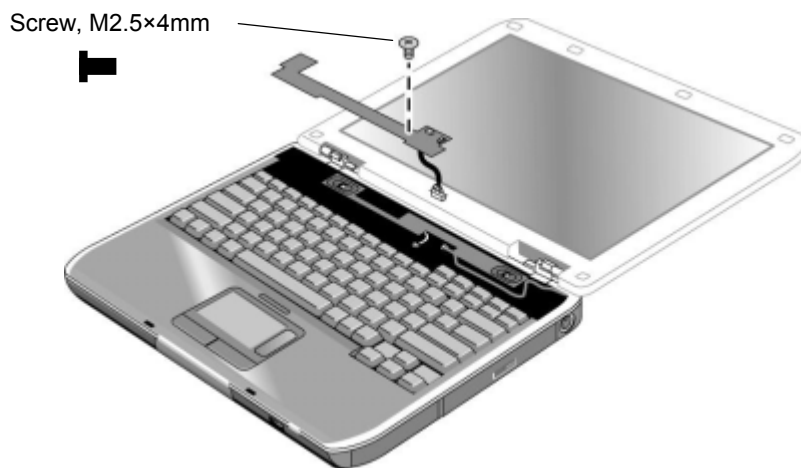

Figure 2-10. Removing the Switchboard PCA

Reassembly Note

- Connect the underside motherboard cable before installing the switchboard PCA.

Removing the CD/DVD Drive (User-Replaceable)

Required Equipment

- #1 Phillips screwdriver.

Removal Procedure

1. Unplug the AC adapter, if present, and remove the battery.
2. Remove these additional assemblies:
 - Keyboard cover (page 2-10).
 - Keyboard (page 2-13).
3. Remove the screws that secure the CD/DVD drive to the top case and motherboard.
4. Place your index finger in the top case opening and push out on the CD/DVD drive to release it from the motherboard.
5. Remove the CD/DVD drive.

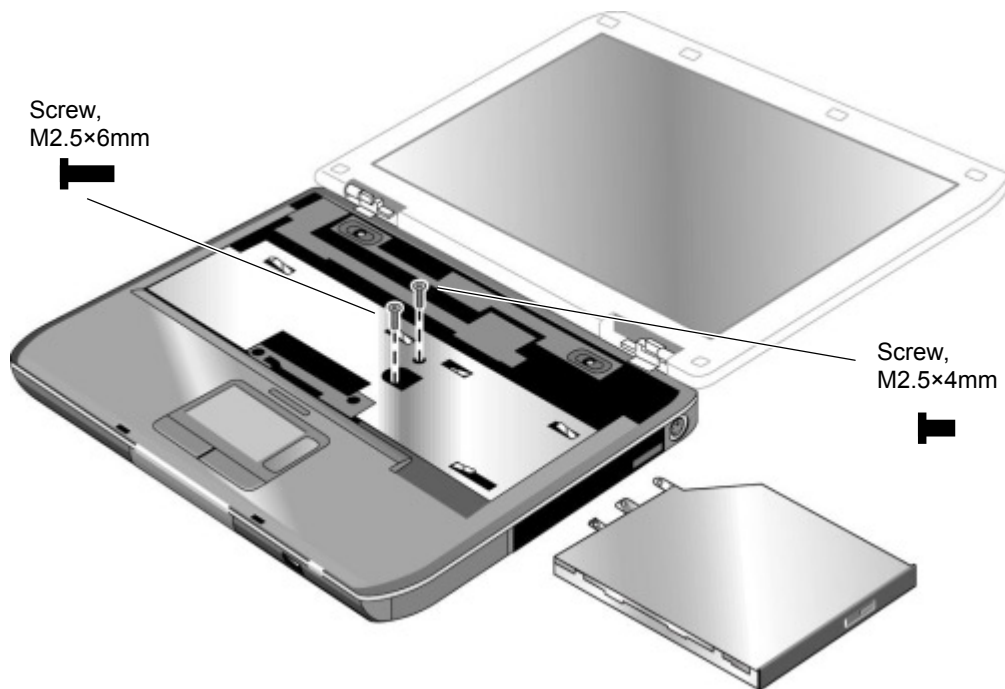

Figure 2-11. Removing the CD/DVD Drive

Removing the Display Assembly

(Authorized Service Providers Only)

Required Equipment

- #1 Phillips screwdriver.

Removal Procedure

1. Unplug the AC adapter, if present, and remove the battery.
2. Remove the keyboard cover (page 2-10).
3. Remove the two retaining screws from the rear of the notebook.
4. Remove the screws from the left and right antenna PCAs. Relocate the antenna PCAs away from the display assembly hinges.
5. Disconnect the display assembly cable from the motherboard.
6. Remove the six retaining screws that secure the display assembly to the top case. Note that there is a grounding strap at the left hinge.
7. Lift the display assembly off of the notebook.

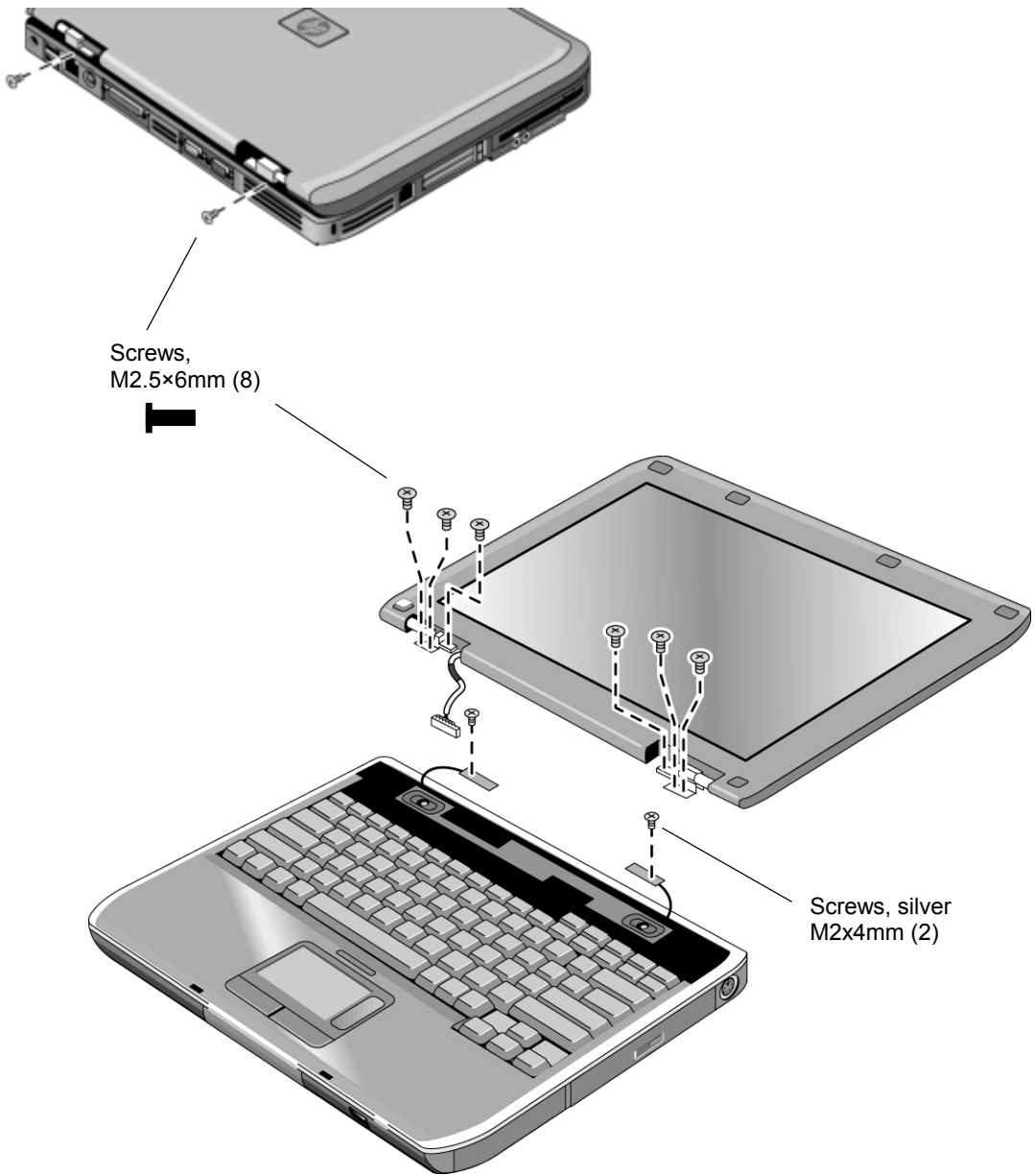

Figure 2-12. Removing the Display Assembly

Reassembly Notes

Important

After replacing the display assembly or motherboard, you must use the Service Utilities floppy disk to reprogram the EEPROM on the motherboard for the new display.

1. Download the notebook series service package from the Partnership Web site (see page vi), and create a Service Utilities floppy disk as described in the package's Readme file.
2. Plug in an AC adapter.
3. Insert the Service Utilities floppy disk in the floppy drive. If the unit has no internal floppy drive, connect a USB floppy drive.
4. Turn on the notebook.
5. When you see the HP logo, press ESC to display the boot menu, then boot from the floppy drive.
6. Select the option to update the display/LCD identification stored on the motherboard.

- Make sure you connect the grounding strap to the left display assembly hinge.
- When connecting the left and right antenna PCAs, make sure they are parallel with the display assembly hinges.

Removing the Top Case

(Authorized Service Providers Only)

Required Equipment

- #1 Phillips screwdriver.

Removal Procedure

1. Unplug the AC adapter, if present, and remove the battery.
2. Remove these additional assemblies:
 - Hard disk drive (page 2-6).
 - Keyboard cover (page 2-10).
 - Speaker assembly (page 2-12).
 - Switchboard PCA (page 2-13).
 - Keyboard (page 2-13).
 - CD/DVD drive (page 2-16).
 - Display assembly (page 2-17).
3. Remove the two screws from the rear of the bottom case.
4. Remove the screws from the middle and near the back of the top case.
5. Remove the rubber screw plugs and screws from the bottom case.
6. Lift the top case off of the notebook and then disconnect the touch pad cable from the motherboard.

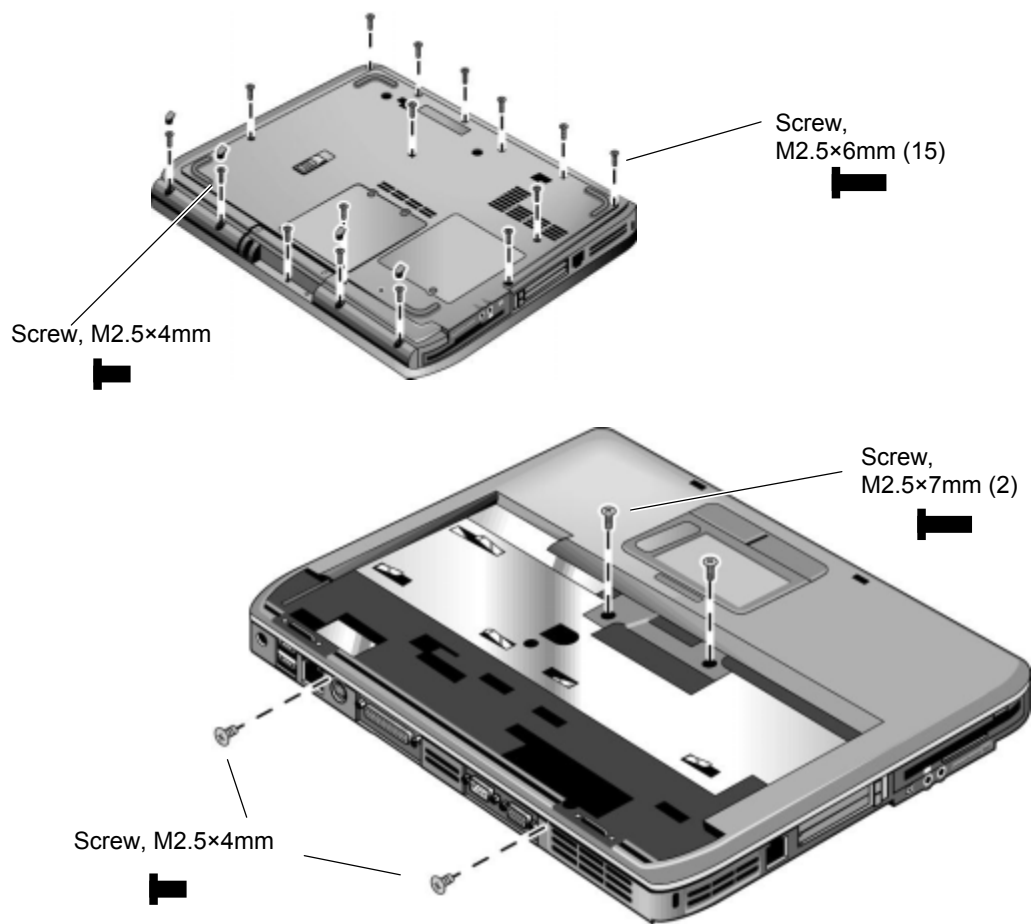

Figure 2-13. Removing the Top Case

Removing the Floppy Drive

(Authorized Service Providers Only)

Required Equipment

- #1 Phillips screwdriver.

Removal Procedure

1. Unplug the AC adapter, if present, and remove the battery.
2. Remove these additional assemblies:
 - Hard disk drive (page 2-6).
 - Keyboard cover (page 2-10).
 - Switchboard PCA (page 2-13).
 - Keyboard (page 2-13).
 - Display assembly (page 2-17).
 - Top case (page 2-20).
3. Remove the screws (right side) that secure the hard disk drive guide to the motherboard. Note that the screws (left side) are missing. These screws were removed during the top case removal procedure.
4. Disconnect the motherboard cable.
5. Remove the screws that secure the floppy drive to the motherboard.
6. Remove the floppy drive.

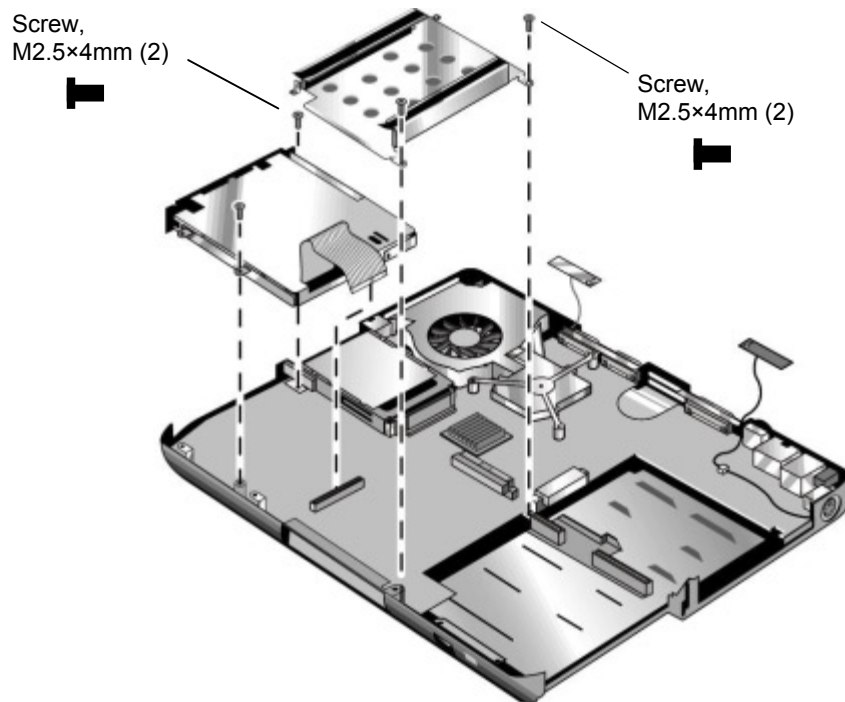

Figure 2-14. Removing the Floppy Drive

Reassembly Notes

Caution

Do not excessively bend or fold the floppy drive cable. Excessive flexing can damage the floppy drive cable connections.

- Connect the floppy drive cable to the motherboard prior to replacing the floppy drive and hard disk drive guide.
- When replacing the hard disk drive guide, do not secure the left side to the motherboard. The left side of the guide gets secured during the top case replacement procedure.

Removing the Infrared (I/R) PCA

(Authorized Service Providers Only)

Required Equipment

- #1 Phillips screwdriver.

Removal Procedure

1. Unplug the AC adapter, if present, and remove the battery.
2. Remove these additional assemblies:
 - Hard disk drive (page 2-6).
 - Keyboard cover (page 2-10).
 - Switchboard PCA (page 2-13).
 - Keyboard (page 2-13).
 - Display assembly (page 2-17).
 - Top case (page 2-20).
3. Disconnect the cable from the motherboard.
4. Remove the screws that secure the I/R PCA to the bottom case.
5. Remove the I/R PCA.

Reassembly Note

Caution

Use care when handling the I/R PCA cable. Damaging the cable can degrade notebook performance.

- Make sure you route the I/R PCA cable between the left screw hole and the bottom case.

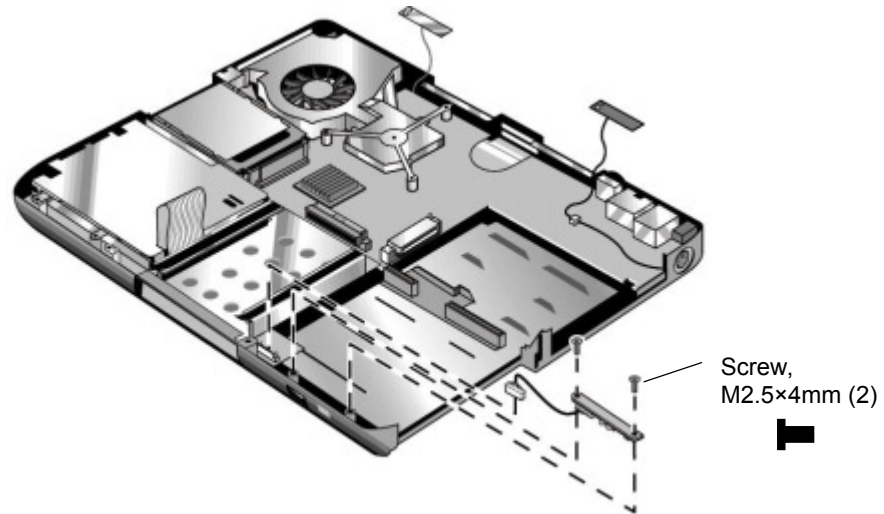

Figure 2-15. Removing the I/R PCA

Removing the Heatsink (with Fan)

(Authorized Service Providers Only)

Required Equipment

- #0 Phillips screwdriver.

Removal Procedure

1. Unplug the AC adapter, if present, and remove the battery.
2. Remove these additional assemblies:
 - Hard disk drive (page 2-6).
 - Keyboard cover (page 2-10).
 - Switchboard PCA (page 2-13).
 - Keyboard (page 2-13).
 - Display assembly (page 2-17).
 - Top case (page 2-20).
3. Remove all three retaining screws.
4. Lift up on the heatsink (with fan) and then disconnect the fan cable from the motherboard.

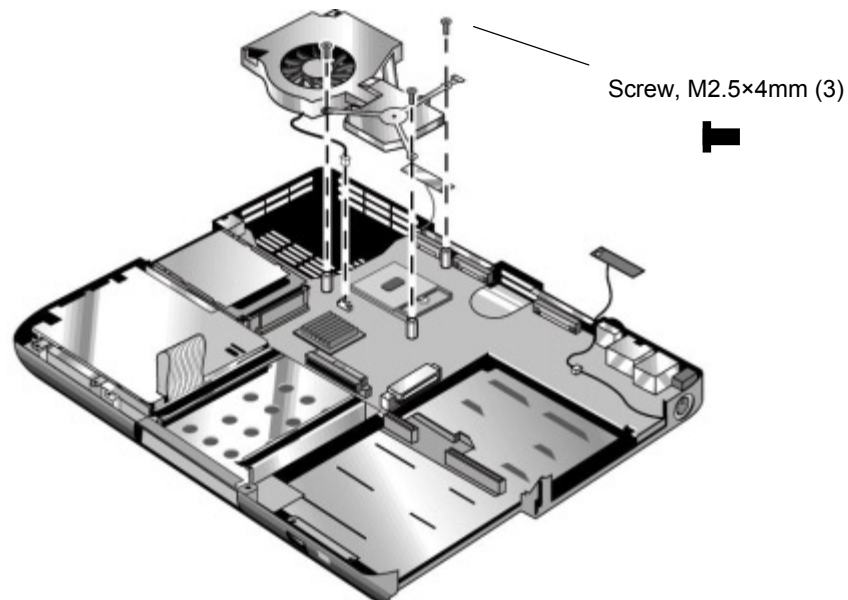

Figure 2-16. Removing the Heatsink (with Fan)

Caution

Do not spin the fan blades with your finger, or you could damage the fan's bearings.

Reassembly Notes

- If the thermal pad is damaged, use a sharp knife or scraper to carefully remove it from the heat sink, then attach a new thermal pad.
- Install the heatsink screws in this order:
 1. Install all three screws lightly.
 2. Fully tighten the screws in the order marked on the heatsink.

Removing the CPU Module

(Authorized Service Providers Only)

Required Equipment

- Small flat-blade screwdriver.

Removal Procedure

1. Unplug the AC adapter, if present, and remove the battery.
2. Remove these additional assemblies:
 - Hard disk drive (page 2-6).
 - Keyboard cover (page 2-10).
 - Switchboard PCA (page 2-13).
 - Keyboard (page 2-13).
 - Display assembly (page 2-17).
 - Top case (page 2-20).
 - Heatsink (page 2-16).

3. Turn the lock screw one-half turn counterclockwise to release the CPU module (you should hear a light snap). Carefully lift the CPU module off of its socket on the motherboard.

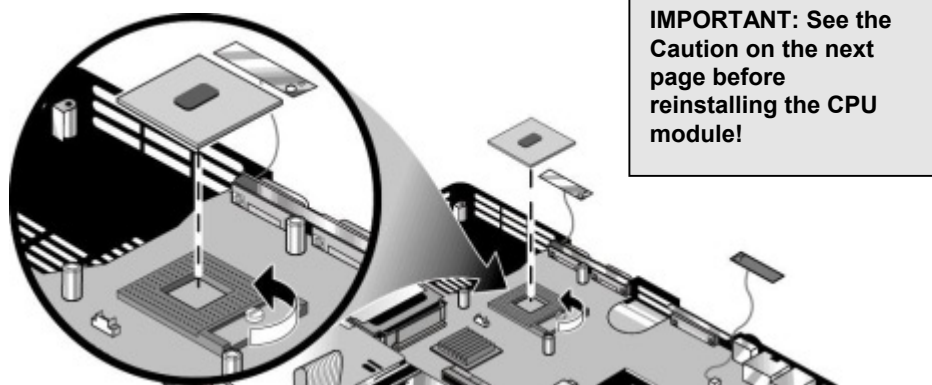

Figure 2-17. Removing the CPU Module

Reassembly Notes

Caution

Each time you install a new CPU module, you must also replace the heat sink's thermal pad to maintain optimum heat transfer. Use a sharp knife or scraper to carefully remove the old thermal pad from the heat sink, then attach the new thermal pad.

- The CPU module is keyed for installation, and can be inserted only one way.
- Carefully insert the CPU module into the motherboard, and turn the lock screw one-half turn clockwise to secure the CPU module.
- Be sure to replace the thermal pad on the heatsink, as described in the reassembly notes on page 2-27.

Removing the Motherboard

(Authorized Service Providers Only)

Required Equipment

- #1 Phillips screwdriver.

Removal Procedure

Note: Before Replacing the Motherboard

If possible, record the computer's electronic serial number before you replace the motherboard. You will then store the electronic serial number in the EEPROM on the new motherboard using the Service Utility floppy disk.

1. Download the notebook service package from the Partnership Web site (see page vi), and create a Service Utilities floppy disk as described in the package's Readme file.
2. Plug in an AC adapter.
3. Insert the Service Utilities floppy disk in the floppy drive.
4. Turn on the notebook. When the HP logo appears (on either the built-in display or the external monitor), press Esc to display the boot menu, then choose Removable Device and boot from the floppy disk.
5. Select the Serial Number option from the boot menu.
6. When prompted, type A for the automatic update option. This stores the current system data from the old motherboard on the floppy disk.

1. Unplug the AC adapter, if present, and remove the battery.
2. Remove these additional assemblies:
 - Hard disk drive (page 2-6).
 - Keyboard cover (page 2-10).
 - Keyboard (page 2-13).
 - CD/DVD drive (page 2-16).
 - Display assembly (page 2-17).
 - Top case (page 2-20).
 - Heatsink (page 2-16).
 - Floppy drive (page 2-17).

Caution: Wireless Models

Be careful when removing and attaching antenna cables. Damage to cables or connectors can degrade performance.

3. **Wireless models only:** Remove the mini-PCI door and unplug the two antenna cables from the mini-PCI card. Do not remove the mini-PCI card at this time.
4. Remove the four screws that attach the motherboard to the bottom case.
5. From the back of the notebook, remove the six standoffs (two each from the external monitor port, serial port, and parallel port).
6. Remove the antenna cable from the metal holder on the motherboard.
7. Carefully lift the motherboard out of the bottom case.
8. If present, remove the modem port cover.

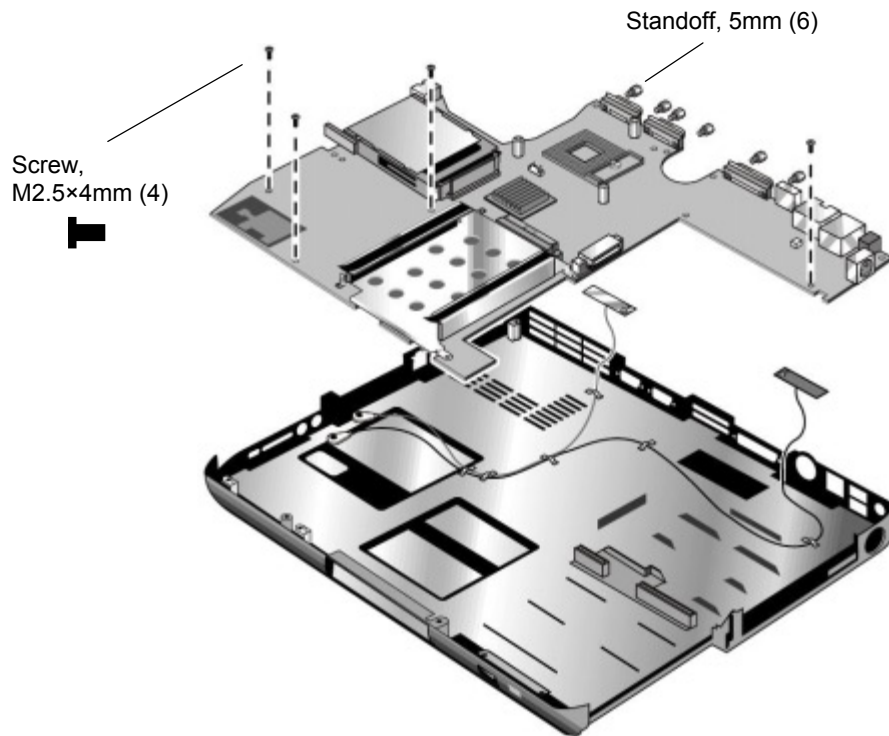

Figure 2-18. Removing the Motherboard

Reassembly Notes

Important

After replacing the display assembly or motherboard, you must use the Service Utilities floppy disk to reprogram the EEPROM on the motherboard for the new display.

1. Download the notebook Series service package from the Partnership Web site (see page vi), and create a Service Utilities floppy disk as described in the package's Readme file.
2. Plug in an AC adapter.
3. Insert the Service Utilities floppy disk in the floppy drive. If the unit has no internal floppy drive, connect a USB floppy drive.
4. Turn on the notebook.
5. When you see the HP logo, press ESC to display the boot menu, then boot from the floppy drive.
6. Select the option to update the display/LCD identification stored on the motherboard.

- If you are replacing the CPU module, you must also replace the thermal pad on the heat sink (see page 2-28).

Wireless Models Only

- Before installing the motherboard, make sure the round coaxial cables from the antenna PCAs are held in place by the clips in the bottom case.
- Make sure there is sufficient length to the front antenna PCA cables so they can easily be connected to the mini-PCI card.

Reassembly Procedure

Caution

Be extremely careful when replacing the motherboard. The motherboard has EMI springs attached to it that can bend very easily. Bending any EMI spring could cause a motherboard short.

Note: Reprogramming the BIOS IC

A new BIOS IC contains only enough basic programming to enable the notebook to boot. After installing a new motherboard, you must reprogram the BIOS IC, preferably with the latest BIOS—see page 2-35.

1. Remove the following components from the old motherboard and install onto the new motherboard:
 - CPU module
 - Wireless LAN mini-PCI card (if present)
 - SDRAM modules
2. Follow the reassembly notes in the section entitled “Removing the Motherboard” on page 2-32.

Note: After Replacing the Motherboard

If present, insert the modem port cover into the modem port opening. Afterwards, you must use the Service Utility floppy disk to store the system data and display information in the EEPROM on the new motherboard. To do so:

1. Plug in an AC adapter.
2. Insert the Service Utilities floppy disk in the floppy drive.
3. Turn on the notebook.
4. If you hear 5 beeps, press F1 to update the display data stored on the motherboard. Let the notebook reboot and go to the next step.
5. Select the Serial Number option from the boot menu.
6. If you successfully stored system data on the floppy disk before removing the old motherboard, type A for the automatic update. This restores the old system data on the new motherboard.

If you did not store system data, type M for the manual update option. Enter the serial number from the bottom of the notebook—you might have to contact an HP support center to do this.

Replacing Components on a Bottom Case

Reassembly Procedure

1. Transfer the plastic wireless panel, and if present, the docking port cover from the old bottom case to the new bottom case.
2. Install a new Microsoft Product ID label.
3. Transfer the old serial number label and install a new overlay, or create a new serial number label using the steps below.
4. Follow the “Reassembly Notes” on page 2-32.

Installing a New Serial Number Label

Download the latest version of the serial number label template (Microsoft Word format) from the Partnership Web site (see page vi) under Support/Service in Technical Support Information. The latest version includes fields for warranty period and manufacturing location. Store the template with other Word templates on a PC connected to a laser printer.

1. Open a new document based on the serial label template.
2. Enter the information from the old serial label, and print the new label on plain white paper. The new label does not have barcodes.
3. Carefully cut out the new serial label just inside the border and place it into the inner recess in the bottom case. The bottom of the label goes toward the front of the case.
4. Make sure all regulatory labels that were on the old bottom case are also on the new bottom case.
5. While holding the paper label in place, attach a serial label overlay into the outer recess. The overlay covers and protects the serial label.

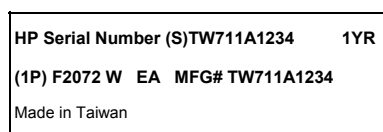

Figure 2-19. Example of Serial Number Label

Replacing the Left and Right Antennas

If you need to remove or replace an antenna, see the figure below.

Caution

Handle the connector ends of the antennas carefully. Failure to do so could degrade notebook performance.

Handle the antenna routing metal tabs in the bottom case carefully. These tabs can be easily broken.

1. Carefully remove both antennas from the old bottom case.
2. Route both antenna cables through the new bottom case as shown below. Make sure you leave enough room at the cable connector end to connect to the mini-PCI card.

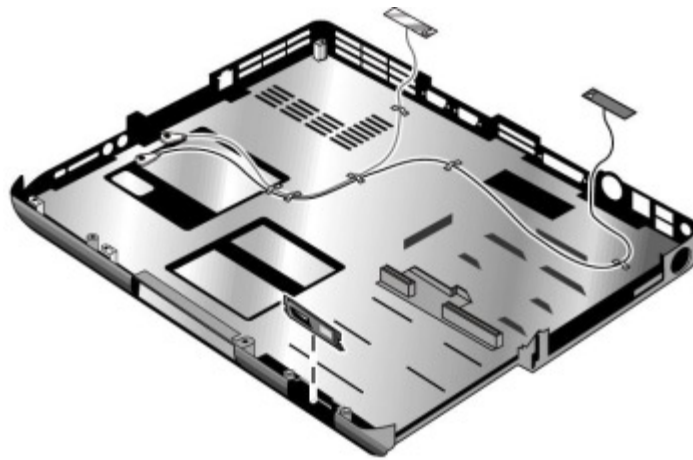

Figure 2-20. Replacing the Antennas

Replacing a PCMCIA Door

If you need to remove or replace a PCMCIA door, see the figure below.



Figure 2-21. Removing a PCMCIA Door

Repairing the BIOS IC

(Authorized Service Providers Only)

The notebook's BIOS IC cannot be replaced separately. If it is defective, you must replace the motherboard. In some cases, however, you might be able to reprogram a malfunctioning BIOS IC using either e-DiagTools for Windows, a BIOS floppy disk, or a Crisis Recovery floppy disk.

If the notebook will boot sufficiently, use e-DiagTools for Windows or a BIOS floppy disk to reprogram the BIOS IC. If you cannot boot the notebook adequately, use a Crisis Recovery floppy disk. See below for instructions for all three methods.

Using e-DiagTools for Windows

Caution

The BIOS update completely replaces the previous BIOS, so follow these directions exactly or you might damage the notebook. The BIOS update also resets the configurations in the BIOS Setup utility—except for BIOS passwords—so record these before performing the update.

Update the notebook's BIOS as follows:

1. In Windows, exit any programs that are running.
2. Undock the notebook if it is docked, and remove any PCMCIA cards from it.
3. Connect the AC adapter to the notebook.
4. Connect any cables or equipment needed to connect to the Internet.
5. Click Start > Programs (or All Programs) > Hewlett-Packard > Notebook > HP e-DiagTools > e-DiagTools for Windows.
6. Click Update, select Download New and click OK. Follow the instructions that appear. **Once the update process begins, do not interrupt it.**

The first time you make an Internet connection from this program on a particular unit, click Change Settings in the Connect window to define your connection settings.

7. When the process completes, press the power button to reset the notebook.

BIOS updates are available from the HP Business Support Web site (www.hp.com/go/bizsupport). Installation utilities and instructions for creating a BIOS floppy disk are provided with the updates.

Using a BIOS Floppy Disk

If you do not have a BIOS floppy disk, download the package from the Partnership Web site (see page vi) under Product Support Information in the Service and Support Library. Follow the instructions for creating the BIOS floppy disk.

Caution

Make sure to use the correct BIOS floppy disk for the notebook model you are repairing. The program does not verify the notebook model, so you could accidentally install the wrong BIOS.

1. Insert the BIOS floppy disk in the floppy disk drive.
2. Turn on the notebook and allow it to boot from the BIOS floppy disk.

If the notebook does not turn on at all, do the following to boot from the BIOS floppy disk:

- a. Unplug the AC adapter.
- b. Press and hold Fn+B
- c. Plug in the AC adapter.
- d. Release Fn+B.

Note: If the notebook will not boot from the BIOS floppy disk, try plugging the boot-block jumper into the notebook's parallel port. See the wiring diagram below.

3. The display goes blank for a minute or more while the BIOS is reprogrammed.

Note: If you plugged in a boot block jumper, unplug it before the notebook automatically reboots.

4. After the BIOS reprograms itself, check the BIOS version to make sure it is the latest version. If necessary, download the latest BIOS version and reprogram the BIOS IC.

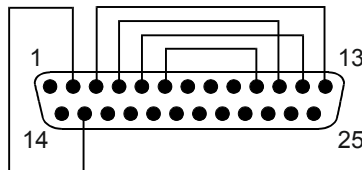

Figure 2-22. Boot-Block Jumper

Removing Other Components

(Authorized Service Providers Only)

Required Equipment

- #0 and #1 Phillips screwdrivers.
- Small flat-blade screwdriver.

Removal Procedure

1. Unplug the AC adapter, if present, and remove the battery.
2. Remove the assemblies and follow the additional steps listed in the table below.

Table 2-5. Removing Components

Component	Removal Procedure	Additional Steps
Battery, CMOS	Keyboard cover (page 2-10). Speaker (page 2-12). Switchboard PCA (page 2-13). Keyboard (page 2-13). CD/DVD (page 2-16). Display (page 2-17). Top case (page 2-20). Heatsink (page 2-26). Floppy (page 2-22). Motherboard (page 2-30).	Reassembly Notes: After replacing the CMOS battery, set the correct time and date using the BIOS Setup utility or Date/Time in the Control Panel.
Case, bottom	See page 2-34.	
Case, top	See page 2-20.	
CD/DVD drive	See page 2-16.	
CPU module	See page 2-28.	
Display assembly	See page 2-17.	
Doors, PCMCIA	Keyboard cover (page 2-10). Speaker (page 2-12). Switchboard PCA (page 2-13). Keyboard (page 2-13). CD/DVD (page 2-16). Display (page 2-17). Top case (page 2-20). Heatsink (page 2-26). Floppy (page 2-22). Motherboard (page 2-30).	See page 2-34.
Floppy drive	See page 2-22.	

Component	Removal Procedure	Additional Steps
Guide, HDD	Keyboard cover (page 2-10). Speaker (page 2-12). Switchboard PCA (page 2-13). Keyboard (page 2-13). CD/DVD (page 2-16). Display (page 2-17). Top case (page 2-20).	When replacing the HDD guide, make sure you only replace the two right screws. Do not replace the two left screws.
Heatsink (with fan)	See page 2-26.	
Keyboard	See page 2-13.	
Panel, wireless	Keyboard cover (page 2-10). Speaker (page 2-12). Switchboard PCA (page 2-13). Keyboard (page 2-13). CD/DVD (page 2-16). Display (page 2-17). Top case (page 2-20).	Press the tabs on both sides of the panel and then lift it from the bottom case.
PCA, I/R	See page 2-24.	
PCA, left and right antennas (wireless models only)	Keyboard cover (page 2-10). Speaker (page 2-12). Switchboard PCA (page 2-13). Keyboard (page 2-13). CD/DVD (page 2-16). Display (page 2-17). Top case (page 2-20). Heatsink (page 2-26). Floppy (page 2-22). Motherboard (page 2-30). Bottom case (page 2-34).	Disconnect the front antenna PCA cables from the mini-PCI card (page 2-6). Be careful not to bend the metal tabs on the bottom case when removing or replacing either of the two antenna PCAs.
PCA, motherboard	See page 2-30.	
PCA, switchboard	See page 2-13.	
Socket, PCMCIA	Keyboard cover (page 2-10). Keyboard (page 2-13). CD/DVD (page 2-16). Display (page 2-17). Top case (page 2-20). Heatsink (page 2-26). Floppy (page 2-22). Motherboard (page 2-30).	<ol style="list-style-type: none"> 1. Remove the two screws attaching the socket to the motherboard. 2. Unplug the PCMCIA socket from the motherboard.
Speaker assembly	See page 2-12.	

Troubleshooting and Diagnostics

This chapter includes troubleshooting and diagnostic information for testing the functionality of the notebook, and for identifying faulty components:

- ASP support information
- Troubleshooting information
 - Checking for customer abuse (page 3-3).
 - Troubleshooting the problem (page 3-3).
 - Verifying the repair (page 3-4).
 - Suggestions for troubleshooting (page 3-5).
- Diagnostic tools
 - e-Diagtools diagnostic program (page 3-18).
 - Power-on self-test (page 3-19).
 - Sycard PCCtest 450/460 PC card (page 3-25).
 - Windows Management Instrumentation (page 3-26).
 - BIOS Setup utility (page 3-26).

Support by Authorized Service Providers

In the U.S., support of notebook computers by Authorized Service Providers (ASPs) is a purchasable option. Standard predefined models and standard special models do *not* include ASP support. The sales force has the option of creating models with ASP support using the specials process.

The serial number label on the bottom of the notebook indicates the ASP support status for that model. See the following table.

Table 3-1. ASP Support Options

Serial Number Label	ASP Support Status
"NoASP"	No reimbursement to ASP for parts or labor. However the ASP is authorized to repair the notebook, and reimbursement can be negotiated directly with the customer.
"ASP"	Parts and labor will be reimbursed to the ASP.

In other countries, ASP support is standard in most situations—but you should check the marking on the serial number label to verify the ASP support status for that model.

Troubleshooting

The suggestions in this section can help isolate and repair the cause of a problem. To ensure quality repair, follow the basic troubleshooting steps shown below.

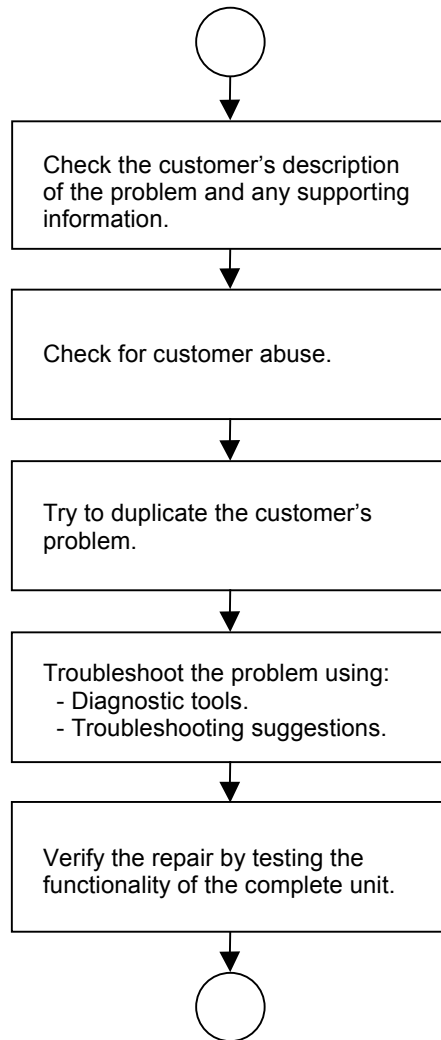

Figure 3-1. Basic Troubleshooting Steps

Checking for Customer Abuse

Some notebooks might appear to have been damaged by customer abuse. Use these guidelines to help determine if this is the case:

- If the shipping box is seriously damaged, customer abuse *cannot* be declared.
- If the damage *could have* a cause other than customer abuse, customer abuse *cannot* be declared.
- If the notebook shows any of the following, customer abuse is declared:
 - Missing parts.
 - Broken plastic parts.
 - Parts not original to the notebook.
 - Damaged or missing keys on the keyboard.

Table 3-3 lists additional criteria for determining customer abuse to specific parts of the notebook.

Important

Parts damaged by customer abuse are not covered by the warranty.

Troubleshooting the Problem

Record pertinent information about the notebook:

- Model and serial number.
- Operating system and version.
- Software version (stored in hidden file c:\version.inf).
- BIOS version.
- Accessories and peripherals used.

Analyze the problem:

- **Observe Symptoms.** Using the customer's information, try to duplicate the problem. Determine how the problem differs from proper behavior. Also, note the functions that *do* work properly.
- **Separate Problems.** If there are multiple symptoms, separate them into distinct problems.
- **Consider Causes.** Keep in mind possible causes for each problem. Use the diagnostic tools and troubleshooting suggestions to help find possible causes.
 - The e-Diagtools diagnostic program tests most of the notebook's components using automatic and interactive tests, and is your primary troubleshooting tool. Other tools include the power-on self-test, WMI/Toptools (if installed), the BIOS Setup utility, and the Sycard PCCtest. Table 3-2 on page 3-5 shows how you can use these tools to isolate the cause of the notebook's problem.
 - The troubleshooting suggestions on page 3-6 include general suggestions for repairing notebooks that show specific failure symptoms.

Swapping modules that might be defective with others known to be good is generally an ideal way to find the module responsible for the problem. A failure symptom is rarely caused by more than one module, so you will not usually need to replace more than one to correct a particular failure.

After you replace a module, the notebook will normally be in a confused state and lock up when you apply power. If this happens, press the reset button: this turns the notebook off, so that you can restart it in a known state.

Verifying the Repair

Before returning the repaired notebook to the customer, verify the repair by running the following tests:

- **e-Diagtools Basic Diagnostic Test.** Run the basic test of the e-Diagtools diagnostic program (page 3-18).
–and–
- **Function Tests.** Run tests that check the repaired function, such as those in e-Diagtools (page 3-18).
–and–
- **Failed Tests.** Run any other tests that failed during troubleshooting.

Suggestions for Troubleshooting

Table 3-2. Scope of Diagnostic Tools

Function	e-Diagtools	Power-On Self-Test	Sycard PCCTest 450	WMI/ Toptools (if installed)	BIOS Setup
Bootup		Tests		Describes	Configures
Processor		Tests		Describes	
Memory	Tests	Tests		Describes	Describes
Fan	Tests				
Batteries		Tests (CMOS battery only)		Describes	
Display	Tests			Describes	Configures
Hard disk	Tests	Tests		Describes	Configures
Floppy drive	Tests*	Tests		Describes	Configures
Keyboard	Tests	Tests		Describes	
Audio	Tests				
Serial	Tests*			Describes	Configures
Parallel	Tests			Describes	Configures
LAN	Tests			Describes	Configures
Modem					Configures
Wireless					Configures
Infrared				Describes	Configures
PS/2 port	Tests†				Configures
USB				Describes	Configures
Port replicator					
PCMCIA	Tests		Tests	Describes	
IEEE 1394	Tests				
AC adapter				Status	
* Test might be available only on certain units.					
† Use an external keyboard to exercise the port. Run the external 101-key test.					

If you cannot isolate the cause of a problem using the above diagnostic tools, use the suggestions in the following table to help find the problem.

Table 3-3. Troubleshooting Suggestions

Symptom	Call Center: Suggestions	Repair Center: Likely Causes	Repair Center: Comments
To help determine likely causes of a problem, determine which replaceable modules are involved in the system function and what roles they play: see the figure on page 1-27 and the table on page 1-28.			
Startup			
Does not boot on AC or battery.	<p>Check power source. Press and hold power button to turn notebook off, then press power button to turn notebook on.</p> <p>Unplug AC adapter, remove the battery and any PC cards, press reset button to turn notebook off, then reconnect power and try again.</p> <p>Do not use touch pad while booting or resuming.</p> <p>Remove all but one SDRAM module and try again. Reinsert any other SDRAM module and try again.</p>	<p>AC adapter.</p> <p>SDRAM module.</p> <p>CPU module.</p> <p>Switchboard PCA.</p> <p>Motherboard.</p> <p>Display assembly.</p> <p>Hard drive.</p>	<p>Check AC adapter. Remove all but one SDRAM module and try again.</p> <p>If power status light does not turn on, reprogram BIOS, replace top case, replace motherboard.</p> <p>If power status light turns on but display remains off, try external monitor. If monitor shows successful boot, replace display assembly. If monitor shows activity but BIOS does not complete, replace display assembly. If monitor is blank, replace switchboard PCA, replace motherboard.</p> <p>If power status light and display turn on, BIOS completes, but OS does not start from hard disk or floppy drive, replace CPU module, replace motherboard. If OS starts from floppy drive, reload hard drive, replace hard drive.</p>
Beeps once, spins hard disk, repeats, but does not boot.	Make sure at least one SDRAM module is installed.	SDRAM module.	
Does not boot on battery, but boots on AC.	<p>Make sure battery is properly installed and fully charged. Check battery level on battery LEDs.</p> <p>Check battery contacts. If available, try another battery.</p>	<p>Battery or contacts.</p> <p>Motherboard.</p>	
Does not boot from floppy drive.	<p>Make sure floppy disk is bootable.</p> <p>Use BIOS Setup to check default boot order.</p>	<p>Floppy disk or floppy drive.</p> <p>Motherboard.</p>	Make sure floppy drive is installed and connected correctly.
Does not boot from CD in CD/DVD drive.	<p>Make sure CD is bootable.</p> <p>Use BIOS Setup to check default boot order.</p> <p>Restart notebook.</p>	<p>CD/DVD drive.</p> <p>Motherboard.</p>	Make sure CD/DVD is installed and connected correctly.

Symptom	Call Center: Suggestions	Repair Center: Likely Causes	Repair Center: Comments
Sluggish startup or shutdown.	Use Tools tab in disk's Properties sheet to check hard disk. Use Disk Defragmenter to optimize hard disk. Delete temporary and unneeded files.	Hard drive.	
Error message such as "Invalid system disk" or "Auto IDE error".	Check for disk in floppy drive. Check boot order in BIOS Setup. Remove and reinstall hard drive.	Hard drive contacts. Hard drive.	If notebook boots from floppy drive, check for corrupt files on hard drive, use <i>Recovery CDs</i> to reinstall factory software onto hard drive, replace hard drive.
Password forgotten.	Verify proper ownership, then follow removal procedure with owner and record appropriate data—see page 5-1.		User must call Technical Support and provide proof of ownership. Password removal is restricted to certain sites. See page 5-1.
Power			
No power.	Make sure charged battery is installed or AC adapter connected. Try another battery or AC adapter if available.	AC adapter. Battery. Motherboard.	

Symptom	Call Center: Suggestions	Repair Center: Likely Causes	Repair Center: Comments
Notebook has short operating time when on battery.	<p>Turn down display brightness.</p> <p>Check timeout settings in Power in Control Panel.</p> <p>Check power management settings in BIOS Setup. Try default settings.</p> <p>Battery gauge might need calibration. Run HP Battery Optimizer from Start menu.</p> <p>Certain applications can cause excess CPU and power usage. (User can get Intel Power Monitor from www.intel.com and monitor CPU load.)</p> <p>When playing DVD movies on battery power, use Power Options in Control Panel to select Portable/Laptop power scheme.</p> <p>When using applications with automatic save feature (such as MS Word), extend save time or disable to reduce hard disk access and power usage.</p> <p>PCMCIA card use can affect battery life. Some PCMCIA cards draw power even while not in use.</p> <p>Heavy modem use can affect battery operating time.</p>	Battery. Motherboard.	Battery capacity often decreases after a year or more.
Turns off immediately after turning on.	Battery may be extremely low. Plug in AC adapter or insert charged battery	Battery.	
Does not run on battery; empty battery indication.	Check battery and contacts. Try another battery if available.	Battery or contacts. Motherboard.	
Beeps repeatedly.	Notebook beeps repeatedly when battery is low. Connect AC adapter or replace battery.	Battery.	
Battery does not charge.	<p>Make sure AC adapter has correct power rating.</p> <p>Make sure AC adapter is connected properly and battery installed properly.</p> <p>Check battery contacts. If available, try another battery and AC adapter.</p> <p>Move notebook away from any nearby heat source.</p> <p>Unplug AC adapter and allow battery to cool. Check for blocked air vents.</p>	Battery or contacts. AC adapter. Motherboard. Heatsink.	Check battery and AC adapter. Check heatsink.

Symptom	Call Center: Suggestions	Repair Center: Likely Causes	Repair Center: Comments
AC adapter does not power notebook.	Try another AC adapter, if available.	AC adapter. Motherboard.	AC adapter cannot be repaired, and must be replaced.
Battery indicator is inaccurate.	Time Remaining is an estimate based on notebook's power use at that moment. It therefore depends on current task, and assumes power will be used at that rate until battery runs out. So if notebook is currently using good deal of power (such as when reading CD or DVD), Time Remaining likely shows less time than actually remains.		
Standby/resume			
General problems.	Close all applications before entering (or allowing notebook to enter) Standby or Hibernation mode. If problem appears after installing new software (including drivers), uninstall that software. Contact software vendor for additional support.		
Notebook resumes slowly from Standby mode.	Notebook can take a minute or longer to resume if network card is installed. Blinking cursor appears while system is loading and checking hardware and network connections. When hardware is reinitialized, Windows desktop appears.		
Does not suspend to Standby mode as expected.	Notebook won't suspend if connection to another computer is active. If notebook is busy, it normally finishes current operation before suspending.		
Does not automatically enter Hibernation mode as expected.	Make sure hibernate support is enabled in Power in Control Panel. Also, make sure Hibernate timeouts (Power Schemes tab) for AC and battery power are not set to Never.		

Symptom	Call Center: Suggestions	Repair Center: Likely Causes	Repair Center: Comments
Display			
Dark display, no light.	Make sure notebook is turned on and warmed up. Check power supply. Make sure SDRAM modules are installed properly. Adjust display brightness. Press Fn+F5 several times. Try external monitor.	Display cable connection. SDRAM modules. CPU module. Display assembly. Motherboard.	Check cable connections. Replace SDRAM modules. Make sure CPU module is installed properly, replace CPU module. Check display cable connections, replace display assembly. If external monitor displays no image, replace motherboard.
White display.	Adjust display brightness.	Display assembly. Switchboard PCA.	
Erratic display.		Display cable connection. Switchboard PCA. Display assembly. Motherboard.	Check display cable connection.
Bright or missing pixels or lines.	See quality statement on page 5-2.	Display cable connection. Display assembly.	Check display cable connection. See quality statement on page 5-2.
Punctured display.			Declared to be caused by customer abuse.
Vertical crack near center of display.		Usually caused by closing display with pencil-sized object on keyboard.	Declared to be caused by customer abuse.
Scratched display glass.			Declared to be caused by customer abuse.
Local area of dark or light discoloration visible when display is on.		Caused by excessive pressure applied to area on screen.	Declared to be caused by customer abuse.
External display does not work.	Check connections. Press Fn+F5 several times. Try display on another computer.	External display. Motherboard.	
Hard disk			
Hard disk never spins.	Check power source. Remove and reinstall hard drive. Check connector.	Hard drive or connector. Motherboard.	If drive case is damaged, drive may not operate properly.
Hard disk makes clunking or scratching noise.	Back up disk immediately. Was notebook or drive dropped?	Hard drive.	Check notebook and drive for evidence of customer abuse.
Hard disk makes buzzing or whining noise.	Back up disk immediately. Check hard disk installation. Check for alternate noise sources, such as PCMCIA drive or fan.	Depends on noise source.	

Symptom	Call Center: Suggestions	Repair Center: Likely Causes	Repair Center: Comments
Files corrupted.	Run virus scan program. Check hard disk using Tools tab in disk's Properties sheet. Test hard disk drive with e-Diagtools diagnostics. Back up files if possible, then use <i>Recovery CDs</i> to reformat hard disk and reinstall factory software.		
Disk capacity less than normal.	Check hard disk using Tools tab in disk's Properties sheet. Check partitions using Control Panel, Administrative Tools, Computer Management under Storage. Use <i>Recovery CDs</i> to reformat hard disk and reinstall factory software.	Hard drive.	
Disk's reported capacity is less than actual size	Hard disk allocates approximately 20 MB to diagnostic software. This space is unavailable for other uses, and not included in hard disk capacity reported by Windows.		
Floppy drive			
General problems.	No response from floppy drive.	Floppy drive. Motherboard.	Make sure floppy drive is installed and connected correctly.
CD/DVD drive			
Particular CD or DVD not playing properly.	Check disk for proper insertion, dirt, or damage. Clean with soft cloth or replace as needed. If CD was created on CD-RW drive, try using HP certified media. Read and write quality can vary for other media.		
Cannot read any CD or DVD.	Restart notebook. Make sure CD/DVD drive is installed properly.	CD/DVD drive.	
DVD movie stops playing.	DVD may be double-sided. Movie may be paused. Press Play button.		

Symptom	Call Center: Suggestions	Repair Center: Likely Causes	Repair Center: Comments
Region Code error.	DVDs contain embedded regional codes that prevent them from playing outside region in which they are sold. This error occurs when trying to play DVD intended for different region. Important: Most DVD drives allow region code to be changed only a limited number of times (usually no more than four). When this limit is reached, last change is hard-coded on DVD drive, and is permanent. Refer to DVD player software help for details.		HP warranty does not cover expense of correcting this situation.
“System Error: Unable to read drive” message.	Make sure disk is clean, undamaged, and inserted correctly. Clean with soft cloth or replace as needed. Wait 5 to 10 seconds after closing tray before pressing Play. Restart notebook.	CD/DVD drive. Motherboard.	Make sure CD/DVD drive is installed properly.
No DVD or CD-RW software on notebook.	If software was removed, use the <i>Recovery CDs</i> to reinstall factory software.		
All DVD play is erratic.	Some DVDs include software called “PC Friendly”. This software can cause errors or erratic play. If needed, uninstall PC Friendly and restart notebook.		
Keyboard			
Some or all keys do not work properly.	Check settings in Control Panel.	Keyboard. Motherboard.	Try reinserting ribbon cable in connector on motherboard.
Embedded numeric keypad does not work.	Press Fn+F8 to activate numeric keypad, and Lock key to turn on number lock. Avoid touching touch pad while booting or resuming.	Keyboard. Motherboard.	
PS/2 keyboard and mouse with Y-adapter do not work.	Check devices separately.	Y-adapter. PS/2 device. Motherboard.	

Symptom	Call Center: Suggestions	Repair Center: Likely Causes	Repair Center: Comments
Touch pad			
General problems.	Reset notebook (see page 1-21). Check settings in Control Panel. Make sure touch pad is enabled in Mouse Properties. By default, touch pad is disabled if external PS/2 mouse is connected, Use BIOS Setup to check settings. Avoid touching touch pad while booting or resuming.	Top case. Motherboard.	
Special touch pad features not working.	In Mouse Properties, select Synaptics PS/2 TouchPad driver. (Driver is installed from \hp\drivers\touchpad.)	Top case. Motherboard.	
Click button does not work.		Top case. Motherboard.	
Memory			
Out of memory error.	Make sure C drive has adequate free space. Delete temporary and unneeded files. Use memory troubleshooter in Windows Help. Not all third-party memory cards have been tested for use with notebook.	SDRAM module.	
Notebook does not boot after adding SDRAM.	Use only DDR-266 SDRAM modules.	SDRAM module.	
Audio			
No sound audible.	Increase sound volume. Check whether sound is enabled (mute button and software controls). Check for sound resource conflicts in Device Manager. Test audio with e-Diagtools diagnostics.	Top case. Speaker assembly. Switchboard PCA. Motherboard.	Check operation using headphones or external speakers (switchboard PCA). Make sure speaker assembly cable is connected.
Sound does not record.	Use an external microphone (internal microphone normally not included). Check software controls. Test audio with e-Diagtools diagnostics.	Switchboard PCA. Motherboard.	

Symptom	Call Center: Suggestions	Repair Center: Likely Causes	Repair Center: Comments
Serial/Parallel/USB			
General problems.	Check connections. Restart notebook. Use troubleshooters in Windows Help. Check settings in Control Panel. Check port settings in Device Manager. Test ports with e-Diagtools diagnostics. For USB: contact device vendor and HP Notebook Web site (see page vi) for latest USB drivers. For USB: if the device is powered by the USB port, try the other port.	Motherboard.	
Modem			
General problems.	Check settings in Control Panel. Open hardware Device Manager. If modem is disabled, try to enable. If modem has a conflict, try disabling another device. Use analog telephone line (2, 3, or 4 wires), not PBX or digital line. In a hotel, ask for data line. Try disabling error correction and data compression. Test modem with e-Diagtools diagnostics.	Motherboard.	

Symptom	Call Center: Suggestions	Repair Center: Likely Causes	Repair Center: Comments
LAN/network			
General problems.	<p>Check cables and connections.</p> <p>Try connecting notebook to another network station (if applicable). If green light next to LAN port does not light, LAN cable may not be connected to network or network may be down.</p> <p>Use networking troubleshooter in Windows Help.</p> <p>Check settings in Control Panel.</p> <p>Make sure LAN cable is Category 3, 4, or 5 for 10Base-T operation, or Category 5 for 100Base-TX operation. Maximum cable length is 100 meters (330 feet).</p> <p>Test LAN with e-Diagtools diagnostics.</p>	Motherboard.	
Infrared			
General problems.	<p>Infrared is disabled and no drivers installed as shipped. (Drivers are included.)</p> <p>Make sure line between infrared ports is not blocked, ports face each other squarely and are no more than 1 meter apart. Sunlight, heat from nearby equipment, or other sources of infrared radiation can cause transmission errors.</p> <p>Open Hardware Device Manager. Try to enable the infrared port.</p> <p>Remove any PC cards from notebook (possible IRQ conflict).</p> <p>For fast-IrDA, check for DMA conflict with ECP parallel port.</p>	Motherboard.	

Symptom	Call Center: Suggestions	Repair Center: Likely Causes	Repair Center: Comments
Wireless			
General problems.	Check TCP/IP setup in Control Panel. Check SSID, channel, and encryption settings.	Mini-PCI card. Antenna PCAs. Motherboard.	Make sure all cables are properly connected to mini-PCI card and motherboard. Check for damaged coaxial cables or connectors.
One-Touch button problems			
Buttons not working properly.	Make sure correct applications are associated with buttons in One-Touch tab of Keyboard in Control Panel.	Keyboard cover. Switchboard PCA. Motherboard.	
On-screen display does not appear when button is pressed.	Make sure Onscreen Display is enabled in One-Touch tab of Keyboard in Control Panel.		
PCMCIA			
General problems.	Restart notebook. Try card in another computer. If card requires an IRQ, make sure one is available. In Device Manager, refresh device list and check for conflicts. Download current drivers from card manufacturer's Web site.	PCMCIA socket. Motherboard.	Using a flashlight, look for bent pins inside the PCMCIA socket. For model XE4500, if only one slot is affected, replace PCMCIA socket. If both slots are affected, replace motherboard.
AC adapter			
Does not power notebook.	Make sure AC adapter has correct power rating. Try another AC adapter, if available.	AC adapter. Motherboard.	AC adapter cannot be repaired and must be replaced.
Motherboard			
Evidence of spilled liquid.			Declared to be caused by customer abuse.
Bent or broken connectors, or burnt component.			Declared to be caused by customer abuse.
Motherboard cracked.			Declared to be caused by customer abuse.
Miscellaneous			
Clock loses time	Plug in AC adapter for 24 hours to charge CMOS battery.	CMOS battery. Motherboard.	Charge CMOS battery.
Notebook gets abnormally hot.	Always set notebook on a flat surface, so air can flow freely around and underneath it Make sure air vents are not blocked. Games and other programs that drive CPU usage toward 100% can contribute.	Heatsink.	Check heatsink for damage or proper fan operation. Check thermal contact between CPU and heatsink. Replace thermal pad if needed.

Symptom	Call Center: Suggestions	Repair Center: Likely Causes	Repair Center: Comments
Notebook pauses or runs sluggishly.	<p>May be normal Windows behavior (background processing can affect response time).</p> <p>Certain operations (such as virus scanning or file browsers) can affect performance.</p> <p>Press Ctrl+Alt+Del to see if an application is not responding.</p> <p>Restart notebook.</p> <p>If hard disk has spun down to conserve power, it can take several seconds to spin up (you can hear this). Use Control Panel to modify hard disk power settings.</p> <p>Check for overheating—see previous symptom.</p> <p>If notebook's hard drive frequently runs (as indicated by hard drive light on front of notebook) while notebook appears to be paused or running slowly, consider installing additional SDRAM.</p> <p>Make sure hard drive has adequate free space. Delete temporary and unneeded files.</p>	CPU module. Motherboard.	If notebook slows after period of continuous activity, check heatsink—see previous symptom.
Notebook still on but stops responding.	<p>Press Ctrl+Alt+Del and end any application not responding.</p> <p>Reset notebook (see page 1-21).</p>		
Accessories			
Port replicator problems.	<p>Check notebook's power supply.</p> <p>Check settings in BIOS Setup.</p>	Port replicator. Motherboard.	Port replicator is not repairable, and must be exchanged.

Diagnostic Tools

This section describes the following diagnostic tools you can use for troubleshooting and repairing the notebook:

- Notebook e-Diagtools diagnostic program (below).
- Power-on self-test (page 3-19).
- Sycard PCCtest 450 PC card (page 3-25).
- Windows Management Instrumentation (page 3-26).
- BIOS Setup utility (page 3-26).

e-Diagtools Diagnostic Program

The hardware diagnostic programs provide two levels of testing:

- User-level testing using a basic hardware test.
- Advanced testing using individual hardware tests.

The tests are designed to run after the system reboots, so that the notebook will be in a predictable state during the tests. The tests are non-destructive, and are intended to preserve the state of the notebook. The notebook reboots when you exit the program so drivers can be loaded.

Updating e-Diagtools

You can download the latest version of e-Diagtools using e-Diagtools for Windows.

Running e-Diagtools

The following procedure describes how to run e-Diagtools. The individual steps might differ slightly for different versions of e-Diagtools.

1. Click Start > Turn Off Computer (or Shut Down), Restart.
2. When the HP logo appears, press F10 to start the diagnostic test.

The first time you run the program, you are prompted to select the language for the program.

3. When the menu appears, press F2 to run e-Diagtools.
4. When the Configuration Description appears, check the list of detected hardware.
5. **Run the basic test.** Press F2 to start the basic hardware test. The results appear when the test is complete.
6. If you intend to exit without running the advanced tests, press F4 to view the Support Ticket. Press F3 to exit e-Diagtools.
7. **Optional: run the advanced tests.** Press F2 to open the advanced test screen.
8. Use the arrow keys and ENTER to select the test you want to run. Tests are listed only for detected hardware.
9. Press F2 to run the selected tests and add the results to the Support Ticket.

10. After each run, press F2 to return to the advanced test screen, or press F4 to view the Support Ticket.
11. **Exit.** Press F3 and then any key to exit and reboot.
12. **Optional: open the Support Ticket.** In Windows, click Start > All Programs (or Programs) > Hewlett-Packard > Notebook > HP e-Diagtools > e-Diagtools for Windows.
13. Click View to display the Support Ticket.
14. To add information about your problem, click Comments, type the information, and then click OK.
To save or print the Support Ticket, click Save As or Print.

To e-mail the Support Ticket to your support agent, click e-Mail. The first time you make an e-mail connection from this program, click Change Settings in the Connect window and enter the settings recommended by your support agent.

e-Diagtools for Windows can also update the version of e-Diagtools on your notebook's hard disk. In e-Diagtools for Windows, use the e-Diagtools menu.

If you have trouble running e-Diagtools diagnostics from the hard disk, you can also run it from the *Recovery CD* or *DVD*. Boot from the CD or DVD and select the diagnostics option.

Interpreting the Results

The e-Diagtools diagnostic program returns test groups, error codes, and suggestions for repair and/or follow-up actions. The basic hardware test shows a recommended replacement part.

To help interpret the results of the e-Diagtools tests, refer to the following:

- e-Diagtools Support Ticket on page 3-19.
- Replaceable Module Diagram on page 1-27
- Functional Structure Description on page 1-28

This combined information should enable you to determine which of the notebook's components require service.

Power-On Self-Test

Note

If Quiet Boot is enabled in BIOS Setup (the default setting), press Esc during boot to see POST messages.

When the notebook boots, its system BIOS runs a series of initialization routines and diagnostic tests called POST (Power-On Self-Test). The BIOS will not boot the notebook's operating system if the system memory, CPU, DMA, or interrupt controller fails the POST diagnostic tests. POST indicates progress by a sequence of codes; if an error occurs, the BIOS displays a message and/or issues a beep code.

Note that not all POST messages indicate a failure in the notebook—some messages are for information only. You should not necessarily interpret the failure of one or more POST tests as a hardware, software, or firmware failure. If POST displays an error message or issues a beep code indicating an error, *confirm the problem using other diagnostic tools*.

First, confirm the failure by performing a “clean” boot, as described below. Note that if the notebook fails to restart with a clean boot, it requires repair.

1. Remove all accessories, including SDRAM modules, port replicator, PC cards, printer, external monitor, pointing device, and keyboard.
2. Provide “clean” AC power—no auto adapter or unusual AC adapter configuration.
3. Press the reset button to return the notebook to a known state.
4. Press the power button to start the notebook.

If the BIOS detects a terminal error condition, it halts POST after issuing a beep code and/or displaying a message (see the following table). The beep code indicates the POST routine in which the terminal error occurred.

Table 3-4. POST Terminal-Error Beep Codes

Beep Codes*	POST Description
1	One short beep before boot.
1-2	Search for option ROMs.
1-1-1-3	Verify Real Mode.
1-1-1-4	Disable Non-Maskable Interrupt (NMI).
1-1-2-1	Get CPU type.
1-1-2-3	Initialize system hardware.
1-1-2-4	Disable shadow and execute code from ROM.
1-1-3-1	Initialize chipset with initial POST values.
1-1-3-2	Set IN POST flag.
1-1-3-3	Initialize CPU registers.
1-1-3-4	Enable CPU cache.
1-1-4-1	Initialize caches to initial POST values.
1-1-4-3	Initialize I/O component.
1-1-4-4	Initialize local bus IDE.
1-2-1-1	Initialize Power Management.
1-2-1-2	Load alternate registers with initial POST values.
1-2-1-3	Restore CPU control word during warm boot.
1-2-1-4	Initialize PCI Bus Mastering devices.
1-2-2-1	Initialize keyboard controller.
1-2-2-3	BIOS ROM checksum.
1-2-2-4	Initialize cache before memory Auto size.
1-2-3-1	8254 timer initialization.
1-2-3-3	8237 DMA controller initialization.
1-2-4-1	Reset Programmable Interrupt Controller.
1-3-1-1	Test DRAM refresh.
1-3-1-3	Test 8742 Keyboard Controller (on motherboard).
1-3-2-1	Set ES segment register to 4 GB.
1-3-3-1	Auto size DRAM; or wrong type or no RAM installed.
1-3-3-2	Initialize POST Memory Manager.
1-3-3-3	Clear 512 kB base RAM.
1-3-4-1	RAM failure on address line xxxx.
1-3-4-3	RAM failure on data bits xxxx of low byte of memory bus.
1-3-4-4	Enable cache before system BIOS shadow.
1-4-1-1	RAM failure on data bits xxxx of high byte of memory bus.
1-4-1-3	Test CPU bus-clock frequency.
1-4-1-4	Initialize Phoenix Dispatch Manager.
1-4-2-3	Warm start shut down.
1-4-3-1	Shadow system BIOS ROM.
1-4-3-3	Auto size cache.
1-4-4-1	Advanced configuration of chipset registers.
1-4-4-2	Load alternate registers with CMOS values.
2-1-1-2	Initialize extended memory for RomPilot.
2-1-1-3	Initialize interrupt vectors.
2-1-2-2	POST device initialization.
2-1-2-3	Check ROM copyright notice.
2-1-2-4	Initialize I20 support.
2-1-3-1	Check video configuration against CMOS.
2-1-3-2	Initialize PCI bus and devices.
2-1-3-3	Initialize all video adapters in system.
2-1-3-4	QuietBoot start (optional).
2-1-4-1	Shadow video BIOS ROM.

Beep Codes*	POST Description
2-1-4-3	Display BIOS copyright notice.
2-1-4-4	Initialize MultiBoot.
2-2-1-1	Display CPU type and speed.
2-2-1-2	Initialize EISA board.
2-2-1-3	Test keyboard.
2-2-2-1	Set key click if enabled.
2-2-2-2	Enable USB devices.
2-2-3-1	Test for unexpected interrupts.
2-2-3-2	Initialize POST display service.
2-2-3-3	Display prompt "Press F2 to enter SETUP".
2-2-3-4	Disable CPU cache.
2-2-4-1	Test RAM between 512 and 640 kB.
2-3-1-1	Test extended memory.
2-3-1-3	Test extended memory address lines.
2-3-2-1	Jump to UserPatch1.
2-3-2-3	Configure advanced cache registers.
2-3-2-4	Initialize Multi Processor APIC.
2-3-3-1	Enable external and CPU caches.
2-3-3-2	Set up System Management Mode (SMM) area.
2-3-3-3	Display external L2 cache size.
2-3-3-4	Load custom defaults (optional).
2-3-4-1	Display shadow-area message.
2-3-4-3	Display possible high address for UMB recovery.
2-4-1-1	Display error messages.
2-4-1-3	Check for configuration errors.
2-4-2-3	Check for keyboard errors.
2-4-4-1	Set up hardware interrupt vectors.
2-4-4-2	Initialize Intelligent System Monitoring.
2-4-4-3	Initialize coprocessor if present.
3-1-1-1	Disable onboard Super I/O ports and IRQs.
3-1-1-2	Late POST device initialization.
3-1-1-3	Detect and install external RS232 ports.
3-1-1-4	Configure non-MCD IDE controllers.
3-1-2-1	Detect and install external parallel ports.
3-1-2-2	Initialize PC-compatible PnP ISA devices.
3-1-2-3	Re-initialize onboard I/O ports.
3-1-2-4	Configure Motherboard Configurable Devices (optional).
3-1-3-1	Initialize BIOS Data Area.
3-1-3-2	Enable Non-Maskable Interrupts (NMIs).
3-1-3-3	Initialize Extended BIOS Data Area.
3-1-3-4	Test and initialize PS/2 mouse.
3-1-4-1	Initialize floppy controller.
3-1-4-4	Determine number of ATA drives (optional).
3-2-1-1	Initialize hard-disk controllers.
3-2-1-2	Initialize local-bus hard-disk controllers.
3-2-1-3	Jump to UserPatch2.
3-2-1-4	Build MPTABLE for multi-processor boards.
3-2-2-2	Install CD-ROM for boot.
3-2-2-3	Clear huge ES segment register.
3-2-2-4	Fix up Multi Processor table.
3-2-3-2	Check for SMART Drive (optional).
3-2-3-3	Shadow option ROMs.
3-2-4-1	Set up Power Management.
3-2-4-2	Initialize security engine (optional).
3-2-4-3	Enable hardware interrupts.
3-2-4-4	Determine number of ATA and SCSI drives.
3-3-1-1	Set time of day.
3-3-1-3	Check key lock.
3-3-2-1	Initialize typematic rate.
3-3-3-1	Erase F2 prompt.
3-3-3-3	Scan for F2 keystroke.
3-3-4-1	Enter SETUP.
3-3-4-3	Clear Boot flag.
3-4-1-1	Check for errors.
3-4-1-2	Inform RomPilot about the end of POST.
3-4-1-3	POST done - prepare to boot OS.
3-4-2-2	Terminate QuietBoot (optional).
3-4-2-3	Check password (optional).
3-4-2-4	Initialize ACPI BIOS.
3-4-3-2	Prepare Boot.
3-4-3-3	Initialize SMBIOS.
3-4-3-4	Initialize PnP Option ROMs.

Beep Codes*	POST Description
3-4-4-1	Clear parity checkers.
3-4-4-2	Display MultiBoot menu.
3-4-4-3	Clear screen (optional).
3-4-4-4	Check virus and backup reminders.
4-1-1-1	Try to boot with INT 19.
4-1-1-2	Initialize POST Error Manager (PEM).
4-1-1-3	Initialize error logging.
4-1-1-4	Initialize error display function.
4-1-2-1	Initialize system error handler.
4-1-2-2	PnPnd dual CMOS (optional).
4-1-2-3	Initialize note dock (optional).
4-1-2-4	Initialize note dock late.
4-1-3-1	Force check (optional).
4-1-3-2	Extended checksum (optional).
4-1-3-3	Redirect Int 15h to enable remote keyboard.
4-1-3-4	Redirect Int 13h to Memory Technologies Devices such as ROM, RAM, PCMCIA, and serial disk.
4-1-4-1	Redirect Int 10h to enable remote serial video.
4-1-4-2	Re-map I/O and memory for PCMCIA.
4-1-4-3	Initialize digitizer and display message.
4-2-1-3	Unknown interrupt.
4-3-1-1	Initialize the chipset.
4-3-1-2	Initialize the bridge.
4-3-1-3	Initialize the CPU.
4-3-1-4	Initialize system timer.
4-3-2-1	Initialize system I/O.
4-3-2-2	Check force recovery boot.
4-3-2-3	Checksum BIOS ROM.
4-3-2-4	Go to BIOS.
4-3-3-1	Set Huge Segment.
4-3-3-2	Initialize Multi Processor.
4-3-3-3	Initialize OEM special code.
4-3-3-4	Initialize PIC and DMA.
4-3-4-1	Initialize Memory type.
4-3-4-2	Initialize Memory size.
4-3-4-3	Shadow Boot Block.
4-3-4-4	System memory test.
4-4-1-1	Initialize interrupt vectors.
4-4-1-2	Initialize Run Time Clock.
4-4-1-3	Initialize video.
4-4-1-4	Initialize System Management Manager.
4-4-2-1	Output one beep.
4-4-2-2	Clear Huge Segment.
4-4-2-3	Boot to Mini DOS.
4-4-2-4	Boot to Full DOS.
1 long, 2 short	Improper video configuration (reprogram EEPROM) or external ROM checksum failure.

The following table lists POST messages and explanations for reported problems. If the system fails after you make changes in BIOS Setup, reset the notebook, enter BIOS Setup, and install the defaults or correct the error.

Table 3-5. POST Messages

Message	Description
0200 Failure Fixed Disk	Fixed (hard) disk is not working or not configured properly. Make sure the hard disk is installed properly. Run BIOS Setup and make sure the hard disk type is correctly identified.
0210 Stuck key	Stuck key on keyboard.
0211 Keyboard error	Keyboard is not working.
0212 Keyboard Controller Failed	Keyboard controller failed the test. might require replacing the motherboard (contains the keyboard controller).
0213 Keyboard locked – Unlock key switch	Unlock the system to proceed.
0220 Monitor type does not match CMOS – Run SETUP	Monitor type is not correctly identified in BIOS Setup.
0230 Shadow RAM Failed at offset: <i>nnnn</i>	Shadow RAM failed at offset <i>nnnn</i> of the 64k block at which the error was detected.
0231 System RAM Failed at offset: <i>nnnn</i>	System RAM failed at offset <i>nnnn</i> of the 64k block at which the error was detected.
0232 Extended RAM Failed at offset: <i>nnnn</i>	Extended memory is not working or not configured properly at offset <i>nnnn</i> . Update to the latest BIOS version.
0250 System battery is dead – Replace and run SETUP	CMOS clock battery indicator shows that the CMOS battery is dead. Connect the AC adapter for at least 24 hours, then run BIOS Setup to reconfigure the system.
0251 System CMOS checksum bad – Default configuration used	System CMOS has been corrupted or modified incorrectly, perhaps by an application that changes CMOS data. In response, the BIOS has installed the default Setup values. Use BIOS Setup to modify these values if needed. If the error persists, check the system battery. Connect the AC adapter for at least 24 hours; replace the motherboard.
0260 System timer error	Timer test failed. Replace the motherboard.
0270 Real time clock error	Real-time clock failed the BIOS test. Might require replacing the motherboard.
0271 Check date and time settings	BIOS found the date or time to be out of range, and reset the real-time clock. You might need to use BIOS Setup to reset the legal date.
0280 Previous boot incomplete – Default configuration used	Previous POST did not complete successfully. POST loads default values and offers to run BIOS Setup. If the failure was caused by incorrect values that are not corrected, the next boot will likely fail. This error is cleared the next time the system is booted.
0281 Memory Size found by POST differed from CMOS	Memory size found by POST differed from that specified in CMOS.
02B0 Diskette drive A error	Drive A: is present but fails the BIOS POST diskette tests. Make sure the drive is defined with the proper diskette type in BIOS Setup and that the drive is connected correctly.
02B2 Incorrect Drive A type – run SETUP	Type of floppy drive A: not correctly identified in BIOS Setup.
02D0 System cache error – Cache disabled	RAM cache failed and BIOS disabled the cache. May require replacing the motherboard. A disabled cache slows system performance considerably.
02F0: CPU ID:	CPU socket number for Multi-Processor error.

Message	Description
02F4: EISA CMOS not writeable	ServerBIOS2 test error: Cannot write to EISA CMOS.
02F5: DMA Test Failed	ServerBIOS2 test error: Cannot write to extended Direct Memory Access (DMA) registers.
02F6: Software NMI Failed	ServerBIOS2 test error: Cannot generate software Non-Maskable Interrupt (NMI).
02F7: Fail-Safe Timer NMI Failed	ServerBIOS2 test error: Fail-safe timer takes too long.
device Address Conflict	Address conflict for the specified device.
Allocation Error for: device	Run ISA or EISA Configuration Utility to resolve a resource conflict for the specified device.
CD ROM Drive	CD-ROM drive identified.
Entering SETUP ...	Starting BIOS Setup.
Failing Bits: <i>nnnn</i>	Hex number <i>nnnn</i> is a map of the bits at the RAM address that failed the memory test. Each 1 (one) in the map indicates a failed bit. See errors 230, 231, or 232 above for offset address of the failure in System, Extended, or Shadow memory.
Fixed Disk <i>n</i>	Fixed disk <i>n</i> (0–3) identified.
Invalid System Configuration Data	Problem with NVRAM (CMOS) data.
I/O device IRQ conflict	I/O device IRQ conflict error.
PS/2 Mouse Boot Summary Screen:	PS/2 mouse installed.
<i>nnnn</i> kB Extended RAM Passed	Where <i>nnnn</i> is the amount of RAM in kB successfully tested.
<i>nnnn</i> Cache SRAM Passed	Where <i>nnnn</i> is the amount of system cache in kB successfully tested.
<i>nnnn</i> kB Shadow RAM Passed	Where <i>nnnn</i> is the amount of shadow RAM in kB successfully tested.
<i>nnnn</i> kB System RAM Passed	Where <i>nnnn</i> is the amount of system RAM in kB successfully tested.
Operating system not found	Operating system cannot be located on drive A: or drive C:. Enter BIOS Setup and see if the hard disk and drive A: are properly identified.
Parity Check 1 <i>nnnn</i>	Parity error found in the system bus. BIOS attempts to locate the address and display it on the screen. Parity is a method for checking errors in binary data. A parity error indicates that data has been corrupted.
Parity Check 2 <i>nnnn</i>	Parity error found in the I/O bus. BIOS attempts to locate the address and display it on the screen.
Press <F1> to resume, <F2> to Setup, <F3> for previous	Displayed after any recoverable error message. Press <F1> to start the boot process or <F2> to enter BIOS Setup and change the settings. Press <F3> to display the previous screen (usually an initialization error of an Option ROM, such as an add-on card). Write down and follow the information shown on the screen.
Press <F2> to enter Setup	Optional message displayed during POST.
PS/2 Mouse:	PS/2 mouse identified.

System BIOS shadowed	System BIOS copied to shadow RAM.
UMB upper limit segment address: <i>nnnn</i>	Displays the address <i>nnnn</i> of the upper limit of Upper Memory Blocks (UMB), indicating released segments of the BIOS that can be reclaimed by a virtual memory manager.
Video BIOS shadowed	Video BIOS copied to shadow RAM.

Sycard PCCTest 450/460 PC Card (Optional)

The PCCTest 450 and 460 cards (version 1.05) from Sycard Technology are the only recommended diagnostic tools that test the functionality of the PCMCIA slots using a PCMCIA card. Each is a Type II PC card that works with test software to exercise PCMCIA functions. (For details, see the Sycard Technology Web site: <http://www.sycard.com>).

The PCCTest product contains these components:

- PCCTest 450 or 460 (revision 1.05) PC card.
- PCCTest 450/460 software disk. (Software updates are available at the Sycard Technology Web site.)
- Configuration headers (PC card/16-bit and CardBus/32-bit) that attach to the card.

You will also need a CardBus extender card (such as the Sycard PCCextend 70) to avoid wear on the Sycard PCMCIA connector.

Use the following tests to check the function of the notebook's PCMCIA slots. See the Sycard documentation for details about running the tests.

Table 3-6. Sycard PCCTest Commands

	Slot	PCMCIA PC card (16-bit) test (PC card configuration header)	CardBus (32-bit) test (CardBus configuration header)
All notebook models (PCI 1520)	Upper Lower	pct450-v-1-b80 pct450-v-0-b80	testcb-v-1-b80 testcb-v-0-b80

Windows Management Instrumentation (WMI)

The Windows Management Instrumentation is basically sets of rules for accessing information about a notebook. WMI allows an application to determine, for example, the operating system being used, which hardware and software components are in the notebook, and possibly whether any of the components need replacing. A local or remote application can use the WMI interface to check which hardware and software components are installed on your notebook, and might be able to tell how well they are working or if they need replacement.

Installing the WMI Package

The WMI package is either preinstalled on the notebook's hard disk or can be downloaded from <http://www.hp.com/toptools> (the contents are the same in both cases). The package must be properly installed before it can be used.

To install the WMI preloaded on the hard disk:

1. Start Windows, if it is not already running.
2. Click Start > Programs (or All Programs) > Hewlett-Packard > HP Toptools Agent > Setup.

Using WMI

For a complete description of how to use WMI, see the following documentation provided with the notebook:

- A README.TXT file: click Start > Programs > Hewlett-Packard > HP Toptools Agent > Read me.
- A Windows online help file describing Hewlett-Packard's implementation of WMI (group and attribute definitions): click Start > Programs Hewlett-Packard > HP Toptools Agent > HP Toptools Help.

Uninstalling the WMI Package

1. Click Start > Programs (or All Programs) > Hewlett-Packard > HP Toptools Agent > Uninstall WMI.
2. Restart the notebook.

BIOS Setup Utility

The BIOS Setup utility provides access to the notebook's basic configuration settings. It is independent of the operating system.

Running the BIOS Setup Utility

1. Close all applications, then restart the notebook: click Start > Turn Off Computer > Restart. (If necessary, you can press Ctrl+Alt+Del to restart.)
2. When the HP logo appears, press F2 to enter the BIOS Setup utility.

3. The pointing devices are not active in BIOS Setup, so you will need to use the keyboard to navigate:

- Press the LEFT and RIGHT arrow keys to move among menus.
- Press the UP and DOWN arrow keys to move among parameters in a menu.
- Press F5 or F6 to move through values for the current parameter, or press Enter to change a setting.

4. After you select the options you want, press F10 or use the Exit menu to exit BIOS Setup.

If the settings cause a conflict between devices during reboot, the system prompts you to run BIOS Setup, and marks the conflicting settings.

Note

The listings in the following table are for the initial BIOS release and might differ somewhat for other models.

Table 3-7. BIOS Setup Menus and Parameters

All notebook models: Introduced with BIOS version KE.01.04 (Fall 2002).		
Main Menu	Description	Default
BIOS Revision	Shows the current BIOS version.	Detected automatically.
System Time	Sets the time using 24-hour format. Values set take effect immediately.	
System Date	Sets the date using dd/mm/yy format (except English, which uses mm/dd/yy format).	
Language	Sets the language for BIOS Setup.	Detected automatically.
Internal Hard Disk	Sets the hard disk drive type and various parameters.	Detected automatically.
Extended Memory	Shows the extended memory size.	Detected automatically.
CPU Serial Number	For a Pentium processor with a serial number, makes the serial number available to software.	Disabled.
Serial Number	Displays the serial number as shown on the back of the notebook.	Detected automatically.
PC ID	Displays the PC ID String stored in the reserved part of RAM.	
Main Menu	Description	
Service ID	Displays an identifier used for repair service.	Detected automatically.
UUID	Displays the value of the 16-byte UUID (Universally Unique ID) as 32 hex characters.	Detected automatically.
MAC Address	Displays the MAC network address of the internal (wired) LAN, if present.	Detected automatically.
System Devices Menu	Description	Default
Video Display Device	Sets whether the built-in display automatically switches to an external display, if one is detected.	Auto

External Pointing Devices	Disables the internal pointing devices when an external pointing device is connected.	Auto
Legacy USB Support	Enables BIOS support for USB mouse, keyboard, and floppy drive during startup.	Enabled
Wake On LAN from Power Off	Lets the notebook be turned on via the LAN port. If this option is enabled, the notebook uses increased power while it is shut down.	Disabled
Security Menu	Description	Default
User Password is	Shows if a user password is set.	Clear
Administrator Password is	Shows if an administrator password is set.	Clear
Set User Password	Press ENTER to set, change, or clear the user password. The password can have no more than 8 characters (0-9, A-Z), and cannot include special or accented characters.	Enter
Set Administrator Password	Press ENTER to set, change, or clear the administrator password, which protects BIOS Setup settings. The password can have no more than 8 characters (0-9, A-Z), and cannot include special or accented characters.	Enter
Password Required to Boot	Sets whether a user password is required when the computer boots. Requires the administrator password for changes.	Disabled
Boot Menu	Description	Default
Hard Disk Removable Device CD/DVD Built-in LAN	Shows the order of boot devices. Move the entries to change the order. Built-in LAN provides diskless boot from a network server.	1. Hard Disk 2. Removable Device 3. CD/DVD 4. Built-in LAN
Exit Menu	Description	
Save Changes and Exit	Saves Setup changes, and then exits and reboots.	
Discard Changes and Exit	Discards any Setup changes made since last save, and then exits and reboots. Does not affect password, date, or time changes.	
Get Default Values	Restores default settings, and remains in Setup. Does not affect password, date, or time changes.	

Updating the Notebook's BIOS

Hewlett-Packard might from time to time provide updates to the notebook's BIOS. Use e-DiagTools for Windows to download and install these BIOS updates as needed (page 2-36).

Replaceable Parts

This chapter contains an exploded view of the notebook and the following lists of parts:

- Notebook replaceable parts (page 4-3).
- Accessory replacement parts (page 4-11).
- Part number reference (page 4-12).

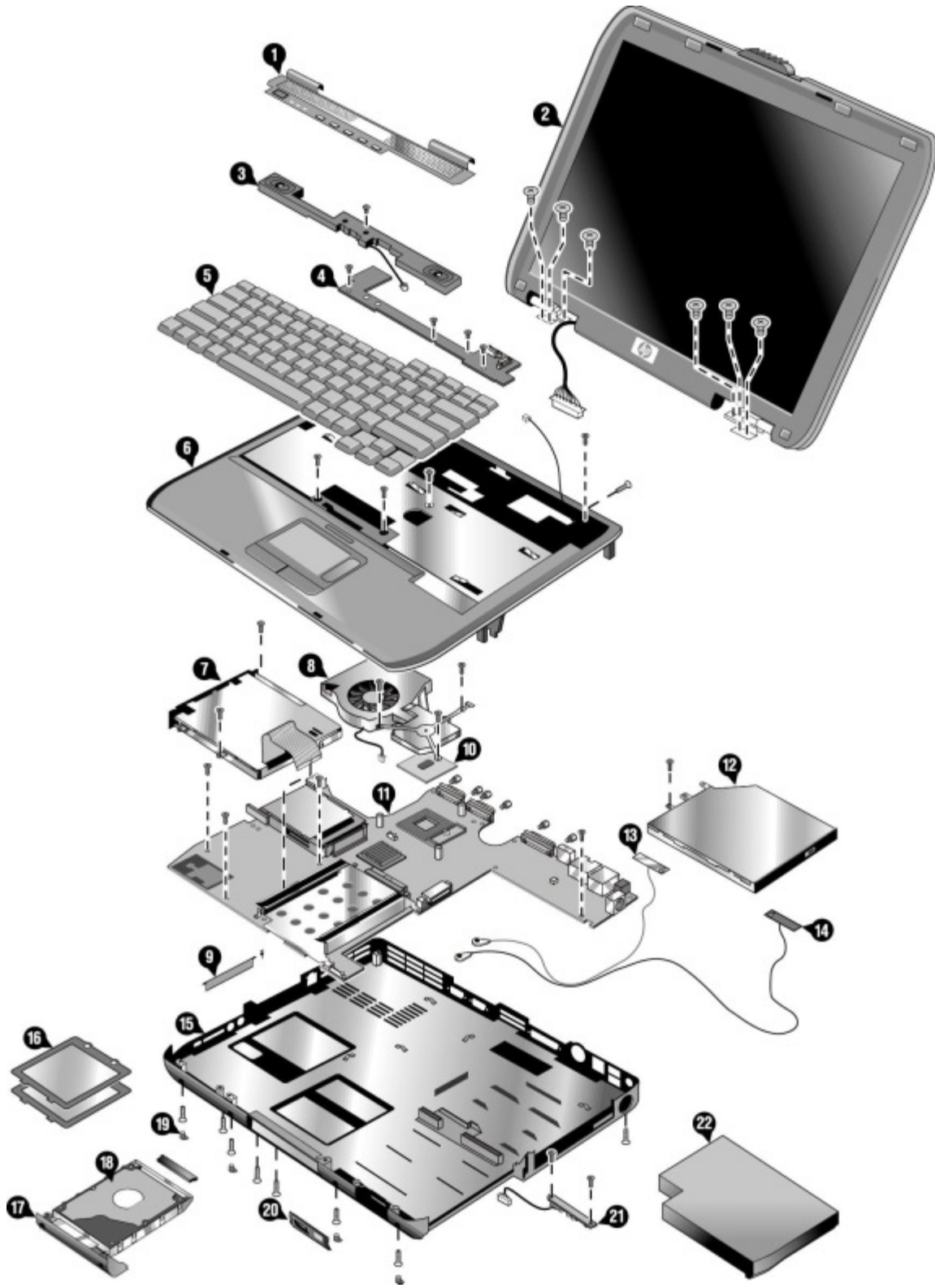

Figure 4-1. Exploded View

Table 4-1. Replaceable Parts

	Description	Part Number	Exchange Part Number	Pavilion ze5200 and Presario 2500	Pavilion ze4200, Evo N1050v, and Presario 2100	Pavilion ze4200 and Presario 2100	Evo N1010v and Presario 1100 F5771J	Pavilion ze4100 F5761H	User Repl
1	Cover, Keyboard – 1F Pavilion	F5761-60904 319428-001			•	•		•	No
1	Cover, Keyboard – 1F Compaq	F5771-60904 319430-001				•	•		No
2	Display 15.0-inch SXGA+ – Pavilion KE	F5761-60912	F5761-69012		•	•		•	No
2	Display 15.0-inch XGA – Pavilion KE	F5761-60911 319437-001	F5761-69011		•	•		•	No
2	Display 14.1-inch XGA – Pavilion KE	F5761-60910 319436-001	F5761-69010		•	•		•	No
2	Display 15.0-inch SXGA+ – (Compaq)	F5771-60903	F5771-69003				•		No
2	Display 15.0-inch XGA – (Compaq)	F5771-60902	F5771-69002				•		No
2	Display 14.1-inch XGA – (Compaq)	F5771-60901	F5771-69001				•		No
2	SPS-DSPLY PANEL 14.1-inch XGA PAV	319483-001		•					No
2	SPS-DSPLY PANEL 15.0-inch XGA PAV	319484-001		•					No
2	SPS-DSPLY PANEL 15.0-inch SXGA PAV	319485-001		•					No
2	SPS-DSPLY PANEL 14.1-inch SGA PRES	319486-001		•					No
2	SPS-DSPLY PANEL 15.0-inch SGA PRES	319487-001		•					No
2	SPS-DSPLY PANEL 15.0-inch SXGA PRES	319488-001		•					No
2	SPS-DSPLY PANEL 15.0-inch SXGA CPQ	319441-001			•	•			No
2	SPS-DSPLY PANEL 15.0-inch XGA CPQ	319440-001			•	•			No
2	SPS-DSPLY PANEL 14.1-inch XGA CPQ	319439-001			•	•			No
3	Speaker assy – 1F	F4640-60908 319447-001			•	•	•		No
	SPS-BD AUDIO CONTROL 3F	319504-001		•					No

		Part Number	Exchange Part Number	Pavilion ze5200 and Presario 2500	Pavilion ze4200, Evo N1050v, and Presario 2100	Pavilion ze4200 and Presario 2100	Evo N1010v and Presario 1100 F5771J	Pavilion ze4100	User Repl
4	PCA, switchboard w/cable 1F Pavilion	F5761-60905 317445-001			•	•		•	No
4	PCA, switchboard w/cable 1F	F4640-60933					•		No
5	SPS-KEYBOARD-AR	F4640-60909 317443-171			•	•			No
5	SPS-KEYBOARD-BEL	F4640-60910 317443-181			•	•			No
5	SPS-KEYBOARD-BR	317443-201			•	•			No
5	SPS-KEYBOARD-CZ	F4640-60911 317443-221			•	•			No
5	SPS-KEYBOARD-DEN	F4640-60912 317443-081			•	•			No
5	SPS-KEYBOARD-EUR	317443-021		•					No
5	Keybd, FRENCH	F4640-60913 317443-051		•	•	•		•	No
5	SPS-KEYBOARD-FC	F4640-60914 317443-121			•	•			No
5	Keybd, GERMAN	F4640-60915 317443-041		•	•	•	•		No
5	SPS-KEYBOARD-GRK	F4640-60916 317443-151			•	•			No
5	SPS-KEYBOARD-HE	F4640-60917 317443-BB1			•	•			No
5	SPS-KEYBOARD-HUN	F4640-60918 317443-211			•	•			No
5	SPS-KEYBOARD-ICL	317443-DD1			•	•			No
5	SPS-KEYBOARD-INTL	F4640-60920 317443-002		•	•	•			No
5	Keybd, ITALIAN	F4640-60921 317443-061		•	•	•	•		No
5	Keybd, JAPANESE	F4640-60922 317443-291			•	•	•		No
5	SPS-KEYBOARD-KO	317443-AD1			•	•			No
5	SPS-KEYBOARD-LA	317443-161			•	•			No
5	SPS-KEYBOARD-NO	F4640-60923 317443-091			•	•			No
5	SPS-KEYBOARD-PRC	F4640-60929 317443-AA1			•	•			No
5	SPS-KEYBOARD-PT	F4640-60924 317443-131			•	•			No

	Description	Part Number	Exchange Part Number	Pavilion ze5200 and Presario 2500	Pavilion ze4200, Evo N1050v, and Presario 2100	Pavilion ze4200 and Presario 2100	Evo N1010v and Presario 1100 F5771J	Pavilion ze4100 F5761H	User Repl
5	SPS-KEYBOARD-RU	F4640-60925 317443-251			•	•			No
5	SPS-KEYBOARD-SK	317443-231			•	•			No
5	Keybd, SPANISH	F4640-60926 317443-071		•	•	•		•	No
5	SPS-KEYBOARD-SWE	F4640-60927 317443-101			•	•			No
5	SPS-KEYBOARD-SWI	F4640-60928 317443-111			•	•			No
5	SPS-KEYBOARD-TAI	317443-AB1			•	•			No
5	SPS-KEYBOARD-THAI	317443-281			•	•			No
5	SPS-KEYBOARD-TK	F4640-60930 317443-141			•	•			No
5	Keybd, UK	F4640-60931 317443-031		•	•	•	•	•	No
5	Keybd, US ENGLISH	F4640-60932 317443-001		•	•	•		•	No
6	Case, top – 1F (Pavilion)	F5761-60906						•	No
6	Case, top – 1F FF (gray/silver)	F4640-60942					•		No
6	SPS-CASE, TOP PAV	319426-001			•	•			No
6	SPS-CASE, TOP CPQ	319427-001			•	•			No
6	SPS-CASE TOP 3F CPQ FF	319477-001		•					No
6	SPS-CASE, TOP 3F PAV FF	319478-001		•					No
6	SPS-CASE TOP 3F CPQ DF	322998-001		•					No
6	SPS-CASE, TOP 3F PAV DF	322999-001		•					No
6	SPS-COVER, KEYBOARD W/SPEAKERS CPQ	319479-001		•					No
6	SPS-COVER, KEYBOARD W/SPEAKERS PAV	323099-001		•					No
7	FDD Assy w/cable 1F	F4640-60945 319448-001			•	•	•	•	No
7	SPS-DRV DSKT 1.44-MB 3F	320691-001		•					No
	SPS-COVER DSKT DRV BLANK	319511-001		•					No
	Cover, FDD – 1F	F5761-60901 319432-001			•	•		•	No
8	Heatsink – 1F w/fan	F4640-60947 319456-001			•	•	•	•	No
8	SPS-HEATSINK 3F W/2 FANS	319492-001			•				No

	Description	Part Number	Exchange Part Number	Pavilion ze5200 and Presario 2500	Pavilion ze4200, Evo N1050v, and Presario 2100	Pavilion ze4200 and Presario 2100	Evo N1010v and Presario 1100	Pavilion ze4100 F5761H	User Repl
	Thermal pad, set	F4640-60984 317438-001			•	•	•	•	No
	SPS-FAN 3F SMALL	319490-001			•				No
9	Kit, door – PCMCIA 1F Upper Door w/ Spring Lower Door w/ Spring	F4640-60965 319431-001			•	•	•	•	No
9	SPS-DOOR PCMCIA	319494-001		•					No
10	SPS-PROC P4 2.4GHZ	319462-001			•	•			No
10	SPS-PROC P4 2.2GHZ	319461-001			•	•			No
10	SPS-PROC DT P4 2.2GHZ	319482-001		•					No
10	SPS-PROC 2.4GHZ 400MHZ FSB	323222-001		•					No
10	SPS-PROC 2.4GHZ 533MHZ FSB	323223-001		•					No
10	CPU, P4 2.0 GHz Northwood UfcPGA	1822-0913 319460-001	F5535-69205		•	•		•	No
10	CPU, P4 1.9 GHz Northwood uFCPGA	1822-1060 319459-001	F5765-69201		•	•		•	No
10	CPU, P4 1.8 GHz Northwood uFCPGA	1822-0819 319458-001	F5535-69202		•	•		•	No
10	SPS-PROC DT P4 1.8GHZ	319480-001		•					No
10	CPU, P4 1.7 GHz Northwood Ufcpga	1822-0781	F3398-69201					•	No
10	SPS-PROC P4 1.6GHZ	1822-0780 319457-001			•	•			No
10	SPS-PROC C/2.0GHZ	319466-001			•	•			No
10	CPU, Cel-M 1.8 GHz Northwood uFCPGA	1822-1037 319465-001	F5765-69206		•	•	•	•	No
10	CPU, Cel-M 1.7 GHz Northwood uFCPGA	1822-0990 319464-001	F5765-69204		•	•		•	No
10	CPU, Cel-M 1.6 GHz Northwood uFCPGA	1822-0989 319463-001	F5765-69203		•	•	•	•	No
10	CPU, Cel-M 1.5 GHz Northwood Ufcpga	1822-1024	F5765-69202					•	No
10	SPS-PROC ATH XP2000+ 1.67GHZ 45W	319849-001				•			No
10	SPS-PROC ATH XP1800+ 1.53GHZ 45W	319848-001				•			No
10	SPS-PROC ATH XP1700+ 1.46GHZ 45W	319850-001				•			No

	Description	Part Number	Exchange Part Number	Pavilion ze5200 and Presario 2500	Pavilion ze4200, Evo N1050v, and Presario 2100	Pavilion ze4200 and Presario 2100	Evo N1010v and Presario 1100 F5771J	Pavilion ze4100 F5761H	User Repl
11	PCA, motherboard – KE w/ IEEE 1394 Socket, PCMCIA – 1F Guide, HDD – 1F	F5761-60902 F4640-60967 F4640-60944 319455-001			•	•	• • •	• • •	No No No
11	PCA, motherboard – KE w/o IEEE 1394 Socket, PCMCIA – 1F Guide, HDD – 1F	F5761-60903 F4640-60967 F4640-60944 319455-001			•	•	•	•	No No No
11	SPS-BD SYSTEM DF	319506-001		•					No
11	SPS-BD SYSTEM FF	319507-001		•					No
11	SPS-BD SYSTEM DF	319449-001			•				No
11	SPS-BD SYSTEM FF	319450-001			•				No
11	SPS-BD SYSTEM DF	319612-001				•			No
11	SPS-BD SYSTEM FF	319613-001				•			No
12	CD-ROM Assy – 24x	F4640-60934 319420-001		•	•	•	•	•	No
12	DVD Assy – 8x	F4640-60936 319421-001		•	•	•	•	•	No
12	CD-RW/DVD Combo Assy	F4640-60937 319422-001		•	•	•	•	•	No
12	SPS-DVD+RW	319423-001			•	•			No
12	SPS-DRV CD-RW	319419-001			•	•			No
13	Antennas, Wireless R&L – 1F	F4640-60976 319467-001			•	•	•	•	No
14	Antennas, Wireless R&L – 1F	F4640-60976 319467-001			•	•	•	•	No

	Description	Part Number	Exchange Part Number	Pavilion ze5200 and Presario 2500	Pavilion ze4200, Evo N1050v, and Presario 2100	Pavilion ze4200 and Presario 2100	Evo N1010v and Presario 1100 F5771J	Pavilion ze4100 F5761H	User Repl
15	Case, bottom assy – FF XPHome	F4640-60981					•		No
15	Case, bottom assy – FF W2K/XPPro	F4640-60980					•		No
15	Case, bottom assy – FF W2K/XPPro	F4640-60986					•	•	No
15	Case, bottom assy – FF XPHome	F4640-60987					•		No
15	Base Enclosure FF	319469-001		•					No
15	Base Enclosure DF	319470-001		•					No
15	SPS-ENCLOSURE BASE DF	317433-001			•	•			No
15	SPS-ENCLOSURE BASE FF	317432-001			•	•			No
	SPS-BD RJ45/1394	319512-001		•					No
	SPS-BD RJ45	319513-001		•					No
	Cover, docking port HP/Compaq	F4641-60905					•	•	Yes
	Cover, docking port	F4640-60966 319435-001			•	•	•	•	Yes
	Cover, modem port	F4640-60960 319434-001			•	•	•	•	Yes
16	Cover, mem or mini-PCI – 1F w/ labels	F4640-60901 319433-001			•	•	•	•	Yes
16	SPS-COVER MEM/MINI PC 3F	319489-001		•					Yes
17	Tray, HDD – 1F	F4640-60903 319417-001			•	•	•	•	Yes

	Description	Part Number	Exchange Part Number	Pavilion ze5200 and Presario 2500	Pavilion ze4200, Evo N1050v, and Presario 2100	Pavilion ze4200 and Presario 2100	Evo N1010v and Presario 1100 F5771J	Pavilion ze4100 F5761H	User Repl
18	SPS-DRV HD 60 G (4200rpm)	319415-001		•	•	•			Yes
18	SPS-DRV HD 60 G (5400 rpm)	319416-001			•	•			Yes
18	SPS-DRV HD 80 G (4200 rpm)	320692-001		•	•	•			Yes
18	HDD-40 GB 9.5mm, IBM ATA100 FDB	0950-4320 319414-001		•	•	•		•	Yes
18	HDD-40 GB 9.5mm, Toshiba ATA100	0950-4288						•	Yes
18	HDD-30 GB 9.5mm, Hitachi ATA100	0950-4168					•	•	Yes
18	HDD-30 GB 9.5mm, IBM (diablo) ATA100	0950-4162 319413-001		•	•	•	•	•	Yes
18	HDD-30 GB 9.5mm, IBM ATA100 FDB (Cascade)	0950-4319					•	•	Yes
18	HDD-30 GB 9.5mm, TITAN Toshiba ATA100 (TITAN)	0950-4360					•	•	Yes
18	HDD-30 GB 9.5mm, Toshiba ATA100	0950-4176					•	•	Yes
18	HDD-20 GB 9.5mm, Hitachi ATA100	0950-4193 319412-001		•	•	•	•	•	Yes
18	HDD-20 GB 9.5mm, IBM ATA100 FDB	0950-4318					•	•	Yes
18	HDD-20 GB 9.5mm, TOSH ATA100 FDB	0950-4287					•	•	Yes
	Kit, cable – 1F	F4640-60974 319424-001			•	•	•	•	No
	SPS-CABLE KIT 3F	319493-001		•					No
	Kit, display screw cover	F4640-60970 319446-001			•	•	•		Yes
	Kit, display screw cover – Pavilion	F5761-60907						•	Yes
19	Kit, rubber foot and screw plug	F4640-60969 317437-001			•	•	•	•	Yes

	Description	Part Number	Exchange Part Number	Pavilion ze5200 and Presario 2500	Pavilion ze4200, Evo N1050v, and Presario 2100	Pavilion ze4200 and Presario 2100	Evo N1010v and Presario 1100 F5771J	Pavilion ze4100 F5761H	User Repl
20	SPS PANEL IR 3F W/IR & BUTTON	319502-001		•					No
20	SPS PANEL IR 3F W/IR & W/O BTN	319503-001		•					No
20	Panel, IR – 1F w/o IR & w/ button	F4640-60948 317439-001			•	•	•	•	No
20	Panel, IR – 1F w/o IR & w/o button	F4640-60949 317440-001			•	•	•	•	No
20	Panel, IR – 1F w/IR & w/button	F4640-60950 317441-001			•	•	•	•	No
20	Panel, IR – 1F w/IR & w/o button	F4640-60951 317442-001			•	•	•	•	No
21	SPS-BD IR 3F	319505-001		•					No
21	PCA, IR – 1F w/o IR	F4640-60964 319454-001			•	•	•	•	No
21	PCA, IR – 1F w/IR	F4640-60946 319453-001			•	•	•	•	No
22	Battery, Li Ion 4.4AHr 8 Cell Li-Ion	F4809-60901 319411-001		•	•	•	•	•	Yes

Table 4-2. Accessory Replaceable Parts

Description	Part Number	Exchange Part Number	Pavilion ze5200 and Presario 2500	Pavilion ze4200, Evo N1050v, and Presario 2100	Pavilion ze4200 and Presario 2100	Evo N1010v and Presario 1100 F5771J	Pavilion ze4100	User Repl
128MB DDR266B	F4694-60901 317434-001			•	•	•	•	Yes
256MB DDR266B	F4695-60901 317435-001			•	•	•	•	Yes
512MB DDR266B	F4696-60901 317436-001			•	•		•	Yes
AC-Adapter-Ultralim Delta 75W s/PFC	F4600-60901					•	•	Yes
Battery, Lilon 4.4Ahr 8 Cell Li-Ion	F4809-60901 319411-001		•	•	•	•	•	Yes
Card, mini-PCI-802.11B France	F4640-60978 319468-051		•	•	•		•	Yes
Card, mini-PCI-802.11B worldwide	F4640-60977 319468-002		•	•	•	•	•	Yes
Cord, Pwr, Austr #ABG (2w)	8120-6312 317444-011				•		•	Yes
Cord, Pwr, Europe #ABB (2w)	8120-6314					•	•	Yes
Cord, Pwr, Japan #ABJ (2w)	8120-6316 317444-291				•	•		Yes
Cord, Pwr, UK (EPSR) For Hong Kong (2w)	8120-8699 317444-031				•	•	•	Yes
Cord, Pwr, US #ABA (2w)	8120-6313 317444-001				•		•	Yes
Port Replicator Assy	F4808-60901 317448-001			•	•	•	•	Yes
Simple Port Replicator HP/Compaq	F4808-60902					•	•	Yes

Table 4-3. Part Number Reference

Part Description	Exchange Part Number	Description	Pavilion ze5200 and Presario 2500	Pavilion ze4200, Evo N1050v, and Presario 2100	Pavilion ze4200 and Presario 2100	Evo N1010v and Presario 1100 F5771J	Pavilion ze4100 H5761H	User Repl
0950-4162	F2072-69115	HDD-30.0GB 9.5mm, IBM (diablo) ATA100	•	•	•	•	•	Yes
0950-4168	F3257-69106	HDD-30GB 9.5mm, Hitachi ATA100				•	•	Yes
0950-4176	F3257-69103	HDD-30GB 9.5mm, Toshiba ATA100				•	•	Yes
0950-4193	F3257-69105	HDD-20GB 9.5mm, Hitachi ATA100	•	•	•	•	•	Yes
0950-4287	F3476-69002	HDD-20GB 9.5mm, TOSH ATA100 FDB				•	•	Yes
0950-4288	F3378-69102	HDD-40GB 9.5mm, Toshiba ATA100					•	Yes
0950-4318	F3257-69501	HDD-20GB 9.5mm, IBM ATA100 FDB				•	•	Yes
0950-4319	F3414-69500	HDD-30.0GB 9.5mm, IBM ATA100 FDB (Cascade)				•	•	Yes
0950-4320	F3428-69500	HDD-40.0GB 9.5mm, IBM ATA100 FDB			•		•	Yes
0950-4360	F3414-69501	HDD-30GB 9.5mm, TITAN Toshiba ATA100 (TITAN)				•	•	Yes
1822-0780		SPS-PROC P4 1.6GHZ		•	•			No
1822-0781	F3398-69201	CPU, P4 1.7 GHz Northwood uFCPGA					•	No
1822-0819	F5535-69202	CPU, P4 1.8 GHz Northwood uFCPGA		•	•		•	No
1822-0913	F5535-69205	CPU, P4 2.0 GHz Northwood uFCPGA		•	•		•	No
1822-0989	F5765-69203	CPU, Cel-M 1.6 GHz Northwood uFCPGA		•	•	•	•	No
1822-0990	F5765-69204	CPU, Cel-M 1.7 GHz Northwood uFCPGA		•	•		•	No
1822-1024	F5765-69202	CPU, Cel-M 1.5 GHz Northwood uFCPGA					•	No
1822-1037	F5765-69206	CPU, Cel-M 1.8 GHz Northwood uFCPGA		•	•	•	•	No
1822-1060	F5765-69201	CPU, P4 1.9 GHz Northwood uFCPGA		•	•		•	No
7121-7525		Overlay, serial label				•	•	No
8120-6312		Cord, Pwr, Austr #ABG (2w)		•	•		•	Yes
8120-6313		Cord, Pwr, US #ABA (2w)		•	•		•	Yes
8120-6314		Cord, Pwr, Europe #ABB (2w)				•	•	Yes
8120-6316		Cord, Pwr, Japan #ABJ (2w)		•	•	•		Yes

Part Description	Exchange Part Number	Description	Pavilion ze5200 and Presario 2500	Pavilion ze4200, Evo N1050v, and Presario 2100	Pavilion ze4200 and Presario 2100	Evo N1010v and Presario 1100 F5771J	Pavilion ze4100 H5761H	User Repl
8120-8373		SPS-CORD AC PWR 2 WIRE-PRC		•	•			Yes
8120-8699		Cord, Pwr, UK (EPSR) For Hong Kong (2w)		•	•	•	•	Yes
317432-001		SPS-ENCLOSURE BASE FF		•	•			No
317433-001		SPS-ENCLOSURE BASE DF		•	•			No
317434-001		128MB DDR266B		•	•			Yes
317435-001		256MB DDR266B		•	•	•	•	Yes
317436-001		512MB DDR266B		•	•		•	Yes
317437-001		Kit, rubber foot and screw plug		•	•	•	•	Yes
317438-001		Thermal pad, set		•	•	•	•	No
317439-001		Panel, IR -1F w/o IR & w/ button		•	•	•	•	No
317440-001		Panel, IR - 1F w/o IR & w/o button		•	•	•	•	No
317441-001		Panel, IR - 1F w/IR & w/button		•	•	•	•	No
317442-001		Panel, IR - 1F w/IR & w/o button		•	•	•	•	No
317443-001		Keybd, US ENGLISH	•	•	•		•	No
317443-002		SPS-KEYBOARD-INTL	•	•	•			No
317443-021		SPS-KEYBOARD-EUR	•					No
317443-031		Keybd, UK	•	•	•	•	•	No
317443-041		Keybd, GERMAN	•	•	•	•		No
317443-051		Keybd, FRENCH	•	•	•		•	No
317443-061		Keybd, ITALIAN	•	•	•	•		No
317443-071		Keybd, SPANISH	•	•	•		•	No
317443-081		SPS-KEYBOARD-DEN		•	•			No
317443-091		SPS-KEYBOARD-NO		•	•			No
317443-101		SPS-KEYBOARD-SWE		•	•			No
317443-111		SPS-KEYBOARD-SWI		•	•			No
317443-121		SPS-KEYBOARD-FC		•	•			No
317443-131		SPS-KEYBOARD-PT		•	•			No
317443-141		SPS-KEYBOARD-TK		•	•			No
317443-151		SPS-KEYBOARD-GRK		•	•			No
317443-161		SPS-KEYBOARD-LA		•	•			No
317443-171		SPS-KEYBOARD-AR		•	•			No
317443-181		SPS-KEYBOARD-BEL		•	•			No
317443-201		SPS-KEYBOARD-BR		•	•			No
317443-211		SPS-KEYBOARD-HUN		•	•			No
317443-221		SPS-KEYBOARD-CZ		•	•			No
317443-231		SPS-KEYBOARD-SK		•	•			No
317443-251		SPS-KEYBOARD-RU		•	•			No
317443-281		SPS-KEYBOARD-THAI		•	•			No

Part Description	Exchange Part Number	Description	Pavilion ze5200 and Presario 2500	Pavilion ze4200, Evo N1050v, and Presario 2100	Pavilion ze4200 and Presario 2100	Evo N1010v and Presario 1100 F5771J	Pavilion ze4100 H5761H	User Repl
317443-291		Keybd, JAPANESE		•	•	•		No
317443-AA1		SPS-KEYBOARD-PRC		•	•			No
317443-AB1		SPS-KEYBOARD-TAI		•	•			No
317443-AD1		SPS-KEYBOARD-KO		•	•			No
317443-BB1		SPS-KEYBOARD-HE		•	•			No
317443-DD1		SPS-KEYBOARD-ICL		•	•			No
317444-001		Cord, Pwr, US #ABA (2w)		•	•		•	Yes
317444-002		SPS-CORD AC PWR 2 WIRE-INTL		•	•			Yes
317444-011		Cord, Pwr, Austr #ABG (2w)	•	•	•	•	•	Yes
317444-031		Cord, Pwr, UK (EPSR) For Hong Kong (2w)		•	•	•	•	Yes
317444-061		SPS-CORD AC PWR 2 WIRE-IT		•	•			Yes
317444-101		SPS-CORD AC PWR 2 WIRE-SWE		•	•			Yes
317444-111		SPS-CORD AC PWR 2 WIRE-SWI		•	•			Yes
317444-291		Cord, Pwr, Japan #ABJ (2w)		•	•	•		Yes
317444-AA1		SPS-CORD AC PWR 2 WIRE-PRC		•	•			Yes
317444-AB1		SPS-CORD AC PWR 2 WIRE-TAI		•	•			Yes
317444-AD1		SPS-CORD AC PWR 2 WIRE-KO		•	•			Yes
317445-001		PCA, switchboard w/cable 1F Pavilion		•	•		•	No
317446-001		SPS-BD SWITCH W/CABLE 1F CPQ		•	•			No
317447-001		SPS-LABEL NAME SET		•	•			Yes
317448-001		Port Replicator Assy		•	•	•	•	Yes
317473-001		Kit, rubber foot and screw plug		•	•			Yes
319411-001		Battery, Li Ion 4.4Ahr 8 Cell Li-Ion	•	•	•			Yes
319412-001		HDD-20GB 9.5mm, Hitachi ATA100	•	•	•	•	•	Yes
319413-001		HDD-30.0GB 9.5mm, IBM (diablo) ATA100	•	•	•	•	•	Yes
319414-001		HDD-40 GB 9.5mm, IBM ATA100 FDB	•	•	•			Yes
319415-001		SPS-DRV HD 60 G (4200rpm)	•	•	•			Yes
319416-001		SPS-DRV HD 60 G (5400 rpm)		•	•			Yes
319417-001		Tray, HDD - 1F		•	•	•	•	Yes

Part Description	Exchange Part Number	Description	Pavilion ze5200 and Presario 2500	Pavilion ze4200, Evo N1050v, and Presario 2100	Pavilion ze4200 and Presario 2100	Evo N1010v and Presario 1100 F5771J	Pavilion ze4100 H5761H	User Repl
319418-001		Guide, HDD - 1F		•	•	•	•	No
319419-001		SPS-DRV CD-RW		•	•			No
319420-001		CD-ROM Assy – 24X	•	•	•	•	•	No
319421-001		DVD Assy – 8x	•	•	•	•	•	No
319422-001		CD-RW/DVD Combo ASSY	•	•	•	•	•	No
319423-001		SPS-DVD+RW		•	•			
319424-001		Kit, cable - 1F		•	•	•	•	No
319425-001		Kit, screw		•	•	•	•	Yes
319426-001		SPS-CASE, TOP PAV		•	•			No
319427-001		SPS-CASE, TOP CPQ		•	•			No
319428-001		Cover, Keyboard – 1F Pavilion		•	•		•	No
319429-001		SPS-COVER KEYBOARD EVO		•	•			No
319430-001		Cover, Keyboard – 1F Compaq		•	•	•		No
319431-001		Kit, door – PCMCIA		•	•	•	•	No
319432-001		Cover, FDD – 1F		•	•		•	No
319433-001		Cover, mem or mini-PCI - 1F w/ labels		•	•	•	•	Yes
319434-001		Cover, modem port		•	•	•	•	Yes
319435-001		Cover, docking port		•	•		•	Yes
319436-001		Display 14.1-inch XGA – Pavilion KE		•	•		•	No
319437-001		Display 15.0-inch XGA – Pavilion KE		•	•		•	No
319438-001		Display 15.0-inch SXGA+ – Pavilion KE		•	•		•	No
319439-001		SPS-DSPLY PANEL 15.0-inch SXGA CPQ		•	•			No
319440-001		SPS-DSPLY PANEL 15.0-inch XGA CPQ		•	•			No
319441-001		SPS-DSPLY PANEL 14.1-inch XGA CPQ		•	•			No
319445-001		SPS-BD INVERTER		•	•			No
319446-001		Kit, display screw cover		•	•	•		Yes
319447-001		Speaker assy - 1F		•	•	•		No
319448-001		FDD Assy w/cable 1F		•	•	•	•	No
319449-001		SPS-BD SYSTEM DF		•				No
319450-001		SPS-BD SYSTEM FF		•				No
319453-001		PCA, IR -1F w/IR		•	•	•	•	No
319454-001		PCA, IR - 1F w/o IR		•	•	•	•	No
319455-001		Socket, PCMCIA - 1F		•	•	•	•	No
319456-001		Heatsink - 1F w/fan		•	•	•	•	No

Part Description	Exchange Part Number	Description	Pavilion ze5200 and Presario 2500	Pavilion ze4200, Evo N1050v, and Presario 2100	Pavilion ze4200 and Presario 2100	Evo N1010v and Presario 1100 F5771J	Pavilion ze4100 H5761H	User Repl
319457-001		SPS-PROC P4 1.6GHZ		•	•			No
319458-001		CPU, P4 1.8 GHz Northwood uFCPGA		•	•		•	No
319459-001		CPU, P4 1.9 GHz Northwood uFCPGA		•	•		•	No
319460-001		CPU, P4 2.0 GHz Northwood uFCPGA		•	•		•	No
319461-001		SPS-PROC P4 2.2GHZ		•	•			No
319462-001		SPS-PROC P4 2.4GHZ		•	•			No
319463-001		CPU, Cel-M 1.6 GHz Northwood uFCPGA		•	•	•	•	No
319464-001		CPU, Cel-M 1.7 GHz Northwood uFCPGA		•	•		•	No
319465-001		CPU, Cel-M 1.8 GHz Northwood uFCPGA		•	•	•	•	No
319466-001		SPS-PROC C/2.0GHZ		•	•			No
319467-001		Antennas, Wireless R&L – 1F		•	•	•	•	No
319468-002		Card, mini-PCI-802.11B worldwide	•	•	•	•	•	Yes
319468-051		Card, mini-PCI-802.11B France	•	•	•		•	Yes
319469-001		Base Enclosure FF	•					No
319470-001		Base Enclosure DF	•					No
319477-001		SPS-CASE TOP 3F CPQ FF	•					No
319478-001		SPS-CASE, TOP 3F PAV FF	•					No
319479-001		SPS-COVER, KEYBOARD W/SPEAKERS CPQ	•					No
319480-001		SPS-PROC DT P4 1.8GHZ	•					No
319482-001		SPS-PROC DT P4 2.2GHZ	•					No
319483-001		SPS-DSPLY PANEL 14.1-inch XGA PAV	•					No
319484-001		SPS-DSPLY PANEL 15.0-inch XGA PAV	•					No
319485-001		SPS-DSPLY PANEL 15.0-inch SXGA PAV	•					No
319486-001		SPS-DSPLY PANEL 14.1-inch SGA PRES	•					No
319487-001		SPS-DSPLY PANEL 15.0-inch SGA PRES	•					No
319488-001		SPS-DSPLY PANEL 15.0-inch SXGA PRES	•					No
319489-001		SPS-COVER MEM/MINI PC 3F	•					Yes
319490-001		SPS-FAN 3F SMALL		•				No
319492-001		SPS-HEATSINK 3F W/2 FANS		•				No

Part Description	Exchange Part Number	Description	Pavilion ze5200 and Presario 2500	Pavilion ze4200, Evo N1050v, and Presario 2100	Pavilion ze4200 and Presario 2100	Evo N1010v and Presario 1100 F5771J	Pavilion ze4100 H5761H	User Repl
319493-001		SPS-CABLE KIT 3F	•					No
319494-001		SPS-DOOR PCMCIA	•					No
319502-001		SPS PANEL IR 3F W/IR & BUTTON	•					No
319503-001		SPS PANEL IR 3F W/IR & W/O BTN	•					No
319504-001		SPS-BD AUDIO CONTROL 3F	•					No
319505-001		SPS-BD IR 3F	•					No
319506-001		SPS-BD SYSTEM DF	•					No
319507-001		SPS-BD SYSTEM FF	•					No
319511-001		SPS-COVER DSKT DRV BLANK	•					No
319512-001		SPS-BD RJ45/1394	•					No
319513-001		SPS-BD RJ45	•					No
319612-011		SPS-BD SYSTEM DF			•			No
319613-001		SPS-BD SYSTEM FF			•			No
319848-001		SPS-PROC ATH XP1800+ 1.53GHZ 45W			•			No
319849-001		SPS-PROC ATH XP2000+ 1.67GHZ 45W			•			No
319850-001		SPS-PROC ATH XP1700+ 1.46GHZ 45W			•			No
320691-001		SPS-DRV DSKT 1.44MB 3F	•					No
320692-001		SPS-DRV HD 80 G (4200 rpm)	•	•	•			Yes
322998-001		SPS-CASE TOP 3F CPQ DF	•					No
322998-001		SPS-CASE, TOP 3F PAV DF	•					No
323099-001		SPS-COVER, KEYBOARD W/SPEAKERS PAV	•					No
323222-001		SPS-PROC 2.4GHZ 400MHZ FSB	•					No
323223-001		SPS-PROC 2.4GHZ 533MHZ FSB	•					No
F4600-60901		AC-Adapter-Ultralim Delta 75W s/PFC				•	•	Yes
F4640-60901		Cover, mem or mini-PCI - 1F w/ labels		•	•	•	•	Yes
F4640-60903		Tray, HDD – 1F		•	•	•	•	Yes
F4640-60908		Speaker assy - 1F		•	•	•		No
F4640-60909		SPS-KEYBOARD-AR		•	•			No
F4640-60910		SPS-KEYBOARD-BEL		•	•			No
F4640-60911		SPS-KEYBOARD-CZ		•	•			No
F4640-60912		SPS-KEYBOARD-DEN		•	•			No

Part Description	Exchange Part Number	Description	Pavilion ze5200 and Presario 2500	Pavilion ze4200, Evo N1050v, and Presario 2100	Pavilion ze4200 and Presario 2100	Evo N1010v and Presario 1100 F5771J	Pavilion ze4100 H5761H	User Repl
F4640-60913		Keybd, FRENCH					•	No
F4640-60914		SPS-KEYBOARD-FC		•	•			No
F4640-60915		Keybd, GERMAN				•		No
F4640-60916		SPS-KEYBOARD-GRK		•	•			No
F4640-60917		SPS-KEYBOARD-HE		•	•			No
F4640-60918		SPS-KEYBOARD-HUN		•	•			No
F4640-60920		SPS-KEYBOARD-INTL	•	•	•			No
F4640-60921		Keybd, ITALIAN		•	•	•		No
F4640-60922		Keybd, JAPANESE		•	•	•		No
F4640-60923		SPS-KEYBOARD-NO		•	•			No
F4640-60924		SPS-KEYBOARD-PT		•	•			No
F4640-60925		SPS-KEYBOARD-RU		•	•			No
F4640-60926		Keybd, SPANISH					•	No
F4640-60927		SPS-KEYBOARD-SWE		•	•			No
F4640-60928		SPS-KEYBOARD-SWI		•	•			No
F4640-60929		SPS-KEYBOARD-PRC		•	•			No
F4640-60930		SPS-KEYBOARD-TK		•	•			No
F4640-60931		Keybd, UK	•	•	•	•	•	No
F4640-60932		Keybd, US ENGLISH	•	•	•		•	No
F4640-60933		PCA, switchboard w/cable 1F				•		No
F4640-60934		CD-ROM Assy – 24X	•	•	•	•	•	No
F4640-60936		DVD Assy – 8x	•	•	•	•	•	No
F4640-60937	F4640-69037	CD-RW/DVD Combo ASSY	•	•	•	•	•	No
F4640-60942		Case, top -1F (gray/silver)				•		No
F4640-60944		Guide, HDD - 1F		•	•	•	•	No
F4640-60945		FDD Assy w/cable 1F		•	•	•	•	No
F4640-60946		PCA, IR -1F w/IR		•	•	•	•	No
F4640-60947		Heatsink - 1F w/fan		•	•	•	•	No
F4640-60948		Panel, IR -1F w/o IR & w/ button		•	•	•	•	No
F4640-60949		Panel, IR - 1F w/o IR & w/o button		•	•	•	•	No
F4640-60950		Panel, IR - 1F w/IR & w/button		•	•	•	•	No
F4640-60951		Panel, IR - 1F w/IR & w/o button		•	•	•	•	No
F4640-60960		Cover, modem port		•	•	•	•	Yes
F4640-60964		PCA, IR - 1F w/o IR		•	•	•	•	No
F4640-60965		Kit, door – PCMCIA		•	•	•	•	No
F4640-60966		Cover, docking port		•	•		•	Yes
F4640-60967		Socket, PCMCIA - 1F		•	•	•	•	No
F4640-60969		Kit, rubber foot and screw plug		•	•	•	•	Yes
F4640-60970		Kit, display screw cover		•	•	•		Yes

Part Description	Exchange Part Number	Description	Pavilion ze5200 and Presario 2500	Pavilion ze4200, Evo N1050v, and Presario 2100	Pavilion ze4200 and Presario 2100	Evo N1010v and Presario 1100 F5771J	Pavilion ze4100 H5761H	User Repl
F4640-60974		Kit, cable - 1F		•	•	•	•	No
F4640-60975		Kit, screw		•	•	•	•	Yes
F4640-60976		Antennas, Wireless R&L – 1F		•	•	•	•	No
F4640-60977		Card, mini-PCI-802.11B worldwide	•	•	•	•	•	Yes
F4640-60978		Card, mini-PCI-802.11B France	•	•	•		•	Yes
F4640-60980	F4640-69080	Case, bottom assy - W2K/XPPro				•		No
F4640-60981	F4640-69081	Case, bottom assy - XPHome				•		No
F4640-60984		Thermal pad, set		•	•	•	•	No
F4640-60986	F4640-69086	Case, bottom assy - w/1394 W2K/XPPro				•	•	No
F4640-60987	F4640-69087	Case, bottom assy - w/1394 XPHome				•		No
F4641-60905		Cover, docking port hp/compaq				•	•	Yes
F4641-60906		Training set, Series 02-B				•	•	No
F4694-60901		128MB DDR266B		•	•	•	•	Yes
F4695-60901		256MB DDR266B		•	•	•	•	Yes
F4696-60901		512MB DDR266B		•	•		•	Yes
F4808-60901		Port Replicator Assy		•	•	•	•	Yes
F4808-60902		Simple Port Replicator hp/compaq				•	•	Yes
F4809-60901		Battery, Lilon 4.4Ahr 8 Cell Li-Ion			•	•	•	Yes
F5761-12001		CD, Rec XP Home NA ENG					•	No
F5761-12003		CD, Rec XP Home AUS EN					•	No
F5761-12006		CD, Rec XP Home NA ENG					•	No
F5761-60901		Cover, FDD – 1F		•	•		•	No
F5761-60902	F5761-69002	PCA, motherboard – KE w/ IEEE 1394				•	•	No
F5761-60903	F5761-69003	PCA, motherboard – KE w/o IEEE 1394				•	•	No
F5761-60904		Cover, Keyboard – 1F Pavilion		•	•		•	No
F5761-60905		PCA, switchboard w/cable 1F Pavilion		•	•		•	No
F5761-60906		Case, top –1F (Pavilion)					•	No
F5761-60907		Kit, display screw cover – Pavilion					•	No
F5761-60910	F5761-69010	Display 14.1-inch XGA – Pavilion KE		•	•		•	No
F5761-60911	F5761-69011	Display 15.0-inch XGA – Pavilion KE		•	•		•	No
F5761-60912	F5761-69012	Display 15.0-inch SXGA+ – Pavilion KE		•	•		•	No

Part Description	Exchange Part Number	Description	Pavilion ze5200 and Presario 2500	Pavilion ze4200, Evo N1050v, and Presario 2100	Pavilion ze4200 and Presario 2100	Evo N1010v and Presario 1100 F5771J	Pavilion ze4100 H5761H	User Repl
F5761-60913		Label, Name set – KE				•	•	Yes
F5771-60901	F5771-69001	Display 14.1-inch XGA – (Compaq)				•		No
F5771-60902	F5771-69002	Display 15.0-inch XGA – (Compaq)				•		No
F5771-60903	F5771-69003	Display 15.0-inch SXGA+ – (Compaq)				•		No
F5771-60904		Cover, Keyboard – 1F Compaq		•	•	•		No
F5781-12004		CD, Rec XP Home UK ENG				•		No

Reference Information

This chapter includes the following reference information:

- Password removal policy.
- Display quality statement.

Password Removal Policy

If the user forgets the system password, the user calls Technical Support to determine the proper removal procedure. The user must provide proof of ownership, and the notebook must be operated during the procedure.

The password removal procedure is protected as HP Company Private information. There are a restricted number of locations that can perform password removal. It might not be disclosed or distributed outside those locations.

Password removal is strictly controlled. Hewlett-Packard and authorized support providers must ensure with written evidence that the notebook being “cleansed” is actually in the possession of the notebook’s actual and current owner. This requires a sales receipt showing the notebook serial number and owner’s name, or a written statement from the owner attesting that he or she is the owner of the notebook. The statement can be a fax copy of the document. The fact that the notebook is in the hands of an HP representative on behalf of the customer is not evidence of ownership. In addition, HP will not remove the password of a notebook for any non-owner, even if it is requested by law enforcement agencies. If you receive such a request, you should notify management and HP Corporate Legal immediately. (These requests might require a court order prior to our participation.)

Further, the entity removing the password must log the name, serial number and date of the removal, and file the written backup with the log. The log and backup are subject to standard record retention process and review.

The final issue relating to removal of passwords is that HP cannot provide information to users that would assist them in improperly removing a password and opening a notebook.

Hewlett-Packard Display Quality Statement

TFT display manufacturing is a highly precise but imperfect technology, and manufacturers cannot produce large displays that are cosmetically perfect. Most, if not all, TFT displays exhibit some level of cosmetic imperfection. These cosmetic imperfections might be visible to the customer under varying display conditions, and can appear as bright, dim, or dark spots. *This issue is common across all vendors supplying TFT displays in their products and is not specific to the notebook display.*

Notebook TFT displays meet or exceed all HP standards for cosmetic quality of TFT displays. HP does not warrant that the displays will be free of cosmetic imperfections. *TFT displays can have a small number of cosmetic imperfections and still conform to HP's cosmetic quality specifications.*

Here are some guidelines for determining what action to take on customers' complaints of cosmetic imperfections in their TFT displays:

1. View the notebook under the customer's normal operating conditions.

This means that if the customer uses the unit predominately in DOS, in Windows, or in some other application or combination of applications, you should make the determination under those same applications. Self test is not a normal operating condition and is not a sufficient tool for interpreting display quality.

2. Use the table below to determine whether the display should be considered for replacement. These are the only conditions in this guideline that might call for a replacement due to a defect in material or workmanship based on the HP Limited Warranty Statement.
3. If a display is considered for replacement, make sure the customer understands that cosmetic variations might also exist on the replacement display, and might require the customer to use a work-around to obscure the cosmetic imperfection.
4. Customers with cosmetic-based complaints that do not conform to the above conditions and tests will not normally be considered for display replacement. The HP-responsible person working with the customer should identify work-arounds that are reasonable and appropriate for the individual customer. Customers who must have a more perfect display solution should consider switching to a notebook with a DSTN display.

We expect that over time the industry will continue to produce displays with fewer inherent cosmetic imperfections, and we will adjust our HP guidelines as these improvements are implemented.

Table 5-1. LCD Guidelines

Type of Imperfection	Imperfections Not Allowed
Electrical Imperfections: Bright dots (a) Dark dots (a)	<ul style="list-style-type: none"> • 7 or more single bright dots. • 7 or more single dark dots. • 9 or more total (bright and dark combined) defective dots. • Any occurrence of multiple defective dots within 15 mm.
Mechanical Imperfections: Discoloration Polarizer bubbles, dents (b)	<ul style="list-style-type: none"> • Any polarizer bubble, discoloration, or dent that is visible from at least 36 cm (14 in).
Definitions of imperfections: a Bright or dark dot: a subpixel (red, green, or blue dot) that is stuck on or off. b Polarizer dent or bubble: a light spot with a darker border that appears on a lighted display and does not change size. (In contrast, a polarizer scratch is a light line that is visible on a darker background and does not change size.)	

Service Notes and Obsolete Parts

Service notes containing important repair information for these products will be issued as needed. These notes are available online at the Partnership Web site—see page vi.



Part Number
319733-001

Printed in U.S.A. 01/03

Free Manuals Download Website

<http://myh66.com>

<http://usermanuals.us>

<http://www.somanuals.com>

<http://www.4manuals.cc>

<http://www.manual-lib.com>

<http://www.404manual.com>

<http://www.luxmanual.com>

<http://aubethermostatmanual.com>

Golf course search by state

<http://golfingnear.com>

Email search by domain

<http://emailbydomain.com>

Auto manuals search

<http://auto.somanuals.com>

TV manuals search

<http://tv.somanuals.com>