

# Compaq ProLiant BL p-Class GbE Interconnect Switch

---

## User Guide

Part Number 263680-001

June 2002 (First Edition)

Product Version: Version 1.0

This user guide provides installation and reference information about the Compaq ProLiant BL p-Class GbE Interconnect Switch, Compaq ProLiant BL p-Class QuadT Interconnect Module, and Compaq ProLiant BL p-Class DualTSX Interconnect Module.

***COMPAQ***

© 2002 Compaq Information Technologies Group, L.P.

Compaq, the Compaq logo, QuickFind, Compaq Insight Manager, and ProLiant are trademarks of Compaq Information Technologies Group, L.P. in the U.S. and/or other countries. Microsoft and Windows are trademarks of Microsoft Corporation in the U.S. and/or other countries.

Intel is a trademark of Intel Corporation in the U.S. and/or other countries.

All other product names mentioned herein may be trademarks of their respective companies.

Compaq shall not be liable for technical or editorial errors or omissions contained herein. The information in this document is provided “as is” without warranty of any kind and is subject to change without notice. The warranties for Compaq products are set forth in the express limited warranty statements accompanying such products. Nothing herein should be construed as constituting an additional warranty.

Compaq ProLiant BL p-Class GbE Interconnect Switch User Guide

June 2002 (First Edition)  
Part Number 263680-001

---

# Contents

## About This Guide

Symbols in Text.....	ix
Important Safety Information.....	ix
Compaq Technician Notes .....	ix
Where to Go for Additional Help.....	xi
Telephone Numbers.....	xi
Text Conventions .....	xi

## Chapter 1

### Introduction

Overview .....	1-1
ProLiant BL p-Class C-GbE Interconnect Kit .....	1-1
ProLiant BL p-Class F-GbE Interconnect Kit.....	1-2
Features .....	1-2
Enterprise Class Performance .....	1-2
GbE Interconnect Switch Redundancy .....	1-3
Configuration and Management .....	1-3
Diagnostic Tools .....	1-4
GbE Interconnect Switch Architecture.....	1-4
GbE Interconnect Switches.....	1-5
Redundant Crosslinks .....	1-5
Redundant Paths to Servers .....	1-5
Supported Technologies .....	1-5
Layer 2 Based Packet Forwarding .....	1-6
IEEE 802.1Q Based Virtual Local Area Network .....	1-6
Spanning Tree Protocol.....	1-6
Simple Network Management Protocol and Remote Monitoring.....	1-7
Port Mirroring .....	1-7
Trunking.....	1-7
Trivial File Transfer Protocol Support.....	1-7
Storage and Forward Switching Scheme .....	1-7
IEEE 802.1p Based Class of Service for Packet Prioritization.....	1-8
Internet Group Management Protocol Snooping .....	1-8
Dynamic Host Configuration Protocol or Bootstrap Protocol .....	1-8
External Components .....	1-8
GbE Interconnect Switch Front Panel.....	1-9
QuadT Interconnect Module Panel .....	1-12
DualTSX Interconnect Module Panel.....	1-14

## Chapter 2

### Setting Up and Installing the GbE Interconnect Switch

Overview .....	2-1
Installing the GbE Interconnect Switches and Interconnect Modules .....	2-1
Installation Guidelines .....	2-1
Installing a New GbE Interconnect Switch for a New Deployment .....	2-2
Replacing an Existing GbE Interconnect Switch .....	2-3
Upgrading from RJ-45 Patch Panels .....	2-4
Planning the GbE Interconnect Switch Configuration .....	2-4
Default Settings .....	2-4
Security Issues .....	2-5
Manually Configuring a GbE Interconnect Switch .....	2-6
Configuring Multiple GbE Interconnect Switches .....	2-6
Cabling the GbE Interconnect Switch .....	2-7
Powering Up the GbE Interconnect Switch .....	2-8
Accessing the GbE Interconnect Switch .....	2-8
Logging On and Configuring the GbE Interconnect Switch .....	2-9
Additional Information .....	2-10

## Chapter 3

### Configuring the GbE Interconnect Switch Using the Console Management Interface

Introduction .....	3-1
Before You Begin .....	3-1
Connecting to the GbE Interconnect Switches .....	3-1
Using the Console Management Interface .....	3-2
Navigation Features .....	3-2
Field-level Help and System Messages .....	3-2
Logging On to the GbE Interconnect Switch .....	3-3
Setting Up New Users .....	3-4
Saving Changes .....	3-6
Managing User Accounts .....	3-7
Updating a User Account .....	3-8
Viewing Current User Accounts .....	3-8
Deleting a User Account .....	3-9
Configuring the GbE Interconnect Switch .....	3-9
Configuring the IP Address .....	3-9
Configuring the GbE Interconnect Switch Information and Advanced Settings .....	3-11
Configuring Port Settings .....	3-14
Configuring Bandwidth .....	3-15
Configuring Spanning Tree Protocol .....	3-19
Configuring the Static (Destination-Address Filtering) Table .....	3-22
Configuring VLANs .....	3-25
Configuring IGMP Snooping .....	3-30
Configuring Port Trunking .....	3-31
Configuring Port Mirroring .....	3-33
Configuring the Threshold of Broadcast/Multicast/DA-Unknown Storm .....	3-34
Configuring Class of Service, Default Priority, and Traffic Class .....	3-35
Configuring Port Security .....	3-39
Configuring Priority MAC Addresses .....	3-40

Configuring RS232 and SLIP .....	3-41
Monitoring GbE Interconnect Switch Functions.....	3-42
Monitoring Port Utilization.....	3-43
Monitoring Trunk Utilization .....	3-44
Monitoring Port Error Packets .....	3-45
Monitoring Port Packet Analysis .....	3-46
Monitoring MAC Address Forwarding Table .....	3-47
Monitoring GbE Interconnect Switch History .....	3-48
Monitoring IGMP Snooping .....	3-48
Monitoring the Dynamic Group Registration Table .....	3-50
Monitoring VLAN Status .....	3-51
Configuring SNMP Manager .....	3-51
Using System Utilities.....	3-53
Upgrading Firmware from a TFTP Server.....	3-54
Downloading Configuration File from a TFTP Server .....	3-55
Saving Settings to a TFTP Server.....	3-55
Saving the History Log to a TFTP Server.....	3-57
Performing a Ping Test .....	3-58
Rebooting the GbE Interconnect Switch .....	3-58
Logging Out .....	3-60

## Chapter 4

### Configuring the GbE Interconnect Switch Using the Web-Based Management Interface

Introduction .....	4-1
Before You Begin.....	4-1
Connecting to the GbE Interconnect Switch .....	4-2
Logging On to the GbE Interconnect Switch .....	4-2
Setting Up New Users .....	4-3
Saving Changes .....	4-5
Configuring the GbE Interconnect Switch .....	4-5
Configuring IP Address .....	4-6
Setting Basic GbE Interconnect Switch Information.....	4-7
Configuring Advanced Settings.....	4-8
Configuring Port Settings .....	4-10
Configuring Port Mirroring.....	4-12
Configuring Port Trunking .....	4-13
Configuring IGMP Snooping.....	4-14
Configuring Spanning Tree Protocol Settings .....	4-15
Configuring Spanning Tree Protocol Port Settings.....	4-17
Configuring Unicast Filtering .....	4-18
Configuring Multicast Filtering .....	4-19
Configuring the Static VLAN Entry .....	4-19
Configuring the Port VLAN ID .....	4-22
Configuring the Restart Ingress Bandwidth Settings.....	4-24
Displaying the Current Ingress Bandwidth Table.....	4-24
Configuring the Restart Egress Bandwidth Settings.....	4-25
Displaying the Current Egress Bandwidth Table.....	4-25
Configuring the Threshold of Broadcast.....	4-26
Configuring the Port Priority .....	4-27

Configuring the Class of Traffic.....	4-28
Configuring the Class of Service.....	4-29
Configuring Port Security.....	4-30
Configuring Priority MAC Addresses.....	4-31
Configuring RS232 and SLIP.....	4-32
Configuring the Security IP.....	4-33
Configuring the SNMP Manager.....	4-34
Configuring the Trap Manager.....	4-35
Setting Up and Managing User Accounts.....	4-35
Monitoring GbE Interconnect Switch Functions.....	4-37
Monitoring the GbE Interconnect Switch Using the Active Switch Graphic.....	4-37
Monitoring Port Utilization.....	4-38
Monitoring Packets.....	4-38
Monitoring Errors.....	4-43
Monitoring Packet Size.....	4-46
Monitoring Trunk Utilization.....	4-48
Monitoring MAC Address Table.....	4-50
Monitoring IGMP Snooping Table.....	4-51
Monitoring Dynamic Group Registration.....	4-51
Monitoring VLAN Status.....	4-52
Maintaining the GbE Interconnect Switch.....	4-53
Using TFTP Services.....	4-53
Displaying GbE Interconnect Switch History.....	4-56
Performing a Ping Test.....	4-57
Resetting the GbE Interconnect Switch Configuration to Factory Defaults.....	4-58
Rebooting the GbE Interconnect Switch.....	4-59
Setting the Connection Timeout.....	4-59
Logging Out.....	4-60

**Appendix A**  
**Technical Specifications**

**Appendix B**  
**RJ-45 Pin Specification**

**Appendix C**  
**Runtime Switching Software Default Settings**

Switch A and Switch B: General Default Settings.....	C-1
Switch A: Port Names, VLANs, STP/ByPass, Trunking Default Settings.....	C-4
Switch B: Port Names, VLANs, STP/ByPass, Trunking Default Settings.....	C-6

**Appendix D**  
**Spanning Tree Protocol**

Introduction.....	D-1
Blocking State.....	D-1
Listening State.....	D-2
Learning State.....	D-4
Forwarding State.....	D-5
Disabled State.....	D-6

Troubleshooting STP .....	D-8
Spanning Tree Protocol Failure .....	D-8
Full/Half Duplex Mismatch .....	D-9
Unidirectional Link.....	D-10
Packet Corruption .....	D-10
Resource Errors.....	D-11
Identifying a Data Loop .....	D-11
Avoiding Trouble.....	D-12

## Appendix E

### SNMP/RMON MIBs Support

Introduction .....	E-1
SNMP Manager Software.....	E-1
Standard MIBs.....	E-2
Enterprise-Specific MIBs .....	E-2

## Appendix F

### Upgrading Firmware by Means of the Serial Port

## Appendix G

### Troubleshooting

## Appendix H

### Regulatory Compliance Notices—ProLiant p-Class C-GbE Interconnect Kit

Class A Equipment .....	H-1
Modifications .....	H-1
Cables.....	H-1
Canadian Notice (Avis Canadien).....	H-1
Class A Equipment .....	H-1
European Union Notice .....	H-2
Taiwan Notice .....	H-2
Japanese Notice .....	H-2

## Appendix I

### Regulatory Compliance Notices—ProLiant BL p-Class F-GbE Interconnect Kit

European Union Notice .....	I-1
-----------------------------	-----

## Index

### List of Figures

1-1	ProLiant BL p-Class GbE Interconnect Switch and QuadT Interconnect Module .....	1-1
1-2	ProLiant BL p-Class GbE Interconnect Switch and DualTSX Interconnect Module.....	1-2
1-3	ProLiant BL p-Class GbE Interconnect Switch architecture .....	1-4
1-4	GbE Interconnect Switch front panel.....	1-9
1-5	GbE Interconnect Switch front panel NIC LED assignments.....	1-10
1-6	GbE Interconnect Switch front panel NIC LED functions .....	1-11
1-7	QuadT Interconnect Module connectors.....	1-12
1-8	QuadT Interconnect Module LEDs.....	1-13

1-9	DualTSX Interconnect Module connectors .....	1-14
1-10	DualTSX Interconnect Module LEDs .....	1-15
2-1	Installing the QuadT or DualTSX Interconnect Modules .....	2-2
2-2	Installing the GbE Interconnect Switches .....	2-3
2-3	Installing the cable-retaining bracket .....	2-7
B-1	Standard RJ-45 receptacle/connector for 10/100 Mb/s and Gigabit over Copper.....	B-1
D-1	Blocking state .....	D-2
D-2	Listening state.....	D-3
D-3	Learning state .....	D-5
D-4	Forwarding state .....	D-6
D-5	Disabled state .....	D-7
D-6	Example of Spanning Tree Protocol failure .....	D-8
D-7	Example of full- and half-duplex mismatch .....	D-9
D-8	Example of unidirectional link .....	D-10
D-9	Common network design example 1 .....	D-13
D-10	Common network design example 2 .....	D-14
F-1	POST message screen .....	F-2
F-2	Download mode message screen.....	F-3
F-3	Boot Configuration Menu.....	F-4
F-4	Connection established message screen .....	F-5
F-5	Send File window .....	F-6
F-6	ZModem file send for Interconnect Switch window .....	F-6
F-7	Download completed message screen .....	F-7
F-8	ProLiant BL p-Class GbE Interconnect Switch login screen .....	F-7



---

## About This Guide

This user guide can be used for reference when servicing the ProLiant BL p-Class GbE Interconnect Switch, ProLiant BL p-Class QuadT Interconnect Module, and ProLiant BL p-Class DualTSX Interconnect Module.



**WARNING:** To reduce the risk of personal injury from electric shock and hazardous energy levels, only authorized service technicians should attempt to repair this equipment. Improper repairs can create conditions that are hazardous.

---

## Symbols in Text

These symbols may be found in the text of this guide. They have the following meanings.



**WARNING:** Text set off in this manner indicates that failure to follow directions in the warning could result in bodily harm or loss of life.

---



**CAUTION:** Text set off in this manner indicates that failure to follow directions could result in damage to equipment or loss of information.

---

**IMPORTANT:** Text set off in this manner presents clarifying information or specific instructions.

**NOTE:** Text set off in this manner presents commentary, sidelights, or interesting points of information.

## Important Safety Information

Before installing this product, read the *Important Safety Information* document provided.

## Compaq Technician Notes



**WARNING:** Only authorized technicians trained by Compaq should attempt to repair this equipment. All troubleshooting and repair procedures are detailed to allow only subassembly/module-level repair. Because of the complexity of the individual boards and subassemblies, no one should attempt to make repairs at the component level or to make modifications to any printed wiring board. Improper repairs can create a safety hazard.

---



**WARNING:** To reduce the risk of personal injury from electric shock and hazardous energy levels, do not exceed the level of repairs specified in these procedures. Because of the complexity of the individual boards and subassemblies, do not attempt to make repairs at the component level or to make modifications to any printed wiring board. Improper repairs can create conditions that are hazardous.

---



**WARNING:** To reduce the risk of electric shock or damage to the equipment:

- Disconnect power from the system by unplugging all power cords from the power supplies.
  - Do not disable the power cord grounding plug. The grounding plug is an important safety feature.
  - Plug the power cord into a grounded (earthed) electrical outlet that is easily accessible at all times.
- 



**CAUTION:** To properly ventilate the system, you must provide at least 7.6 cm (3.0 in.) of clearance at the front and back of the server.

---



**CAUTION:** The computer is designed to be electrically grounded (earthed). To ensure proper operation, plug the AC power cord into a properly grounded AC outlet only.

---

**NOTE:** Any indications of component replacement or printed wiring board modifications may void any warranty.

## Where to Go for Additional Help

In addition to this guide, the following information sources are available:

- User documentation
- *Compaq Service Quick Reference Guide*
- Service training guides
- Compaq service advisories and bulletins
- Compaq *QuickFind*<sup>™</sup> information services
- Compaq Insight Manager software

For additional copies, visit the Compaq website:

[www.compaq.com](http://www.compaq.com)

## Telephone Numbers

For the name of your nearest Compaq authorized reseller:

- In the United States, call 1-800-345-1518.
- In Canada, call 1-800-263-5868.

For Compaq technical support:

- In the United States and Canada, call 1-800-OK COMPAQ.
- For Compaq technical support phone numbers outside the United States and Canada, visit the Compaq website:

[www.compaq.com](http://www.compaq.com)

## Text Conventions

This document uses the following conventions:

- *Italic type* is used for complete titles of published guides or variables. Variables include information that varies in system output, in command lines, and in command parameters in text.
- **Bold type** is used for emphasis, for onscreen interface components (window titles, menu names and selections, button and icon names, and so on), and for keyboard keys.
- `Monospace typeface` is used for command lines, code examples, screen displays, error messages, and user input.
- `Sans serif typeface` is used for uniform resource locators (URLs).

## Overview

This user guide provides installation and reference information for the Compaq *ProLiant*<sup>™</sup> BL p-Class C-GbE Interconnect Kit and the ProLiant BL p-Class F-GbE Interconnect Kit.

### ProLiant BL p-Class C-GbE Interconnect Kit

The ProLiant BL p-Class C-GbE Interconnect Kit contains two GbE Interconnect Switches and two QuadT Interconnect Modules. The ProLiant BL p-Class GbE Interconnect Switch uses 10Base-T/100Base-TX/1000Base-T Gigabit Layer 2 switching technology to provide up to a 32-to-1 reduction in the number of networking cables per BL p-Class server enclosure.

Each GbE Interconnect Switch and QuadT Interconnect Module reduces sixteen 10Base-T/100Base-TX server networking ports to one or two RJ-45 100Base-TX/1000Base-T and one or two RJ-45 10Base-T/100Base-TX uplink ports.

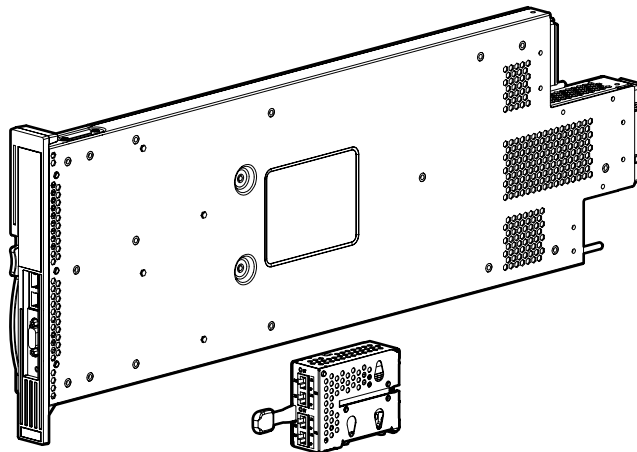
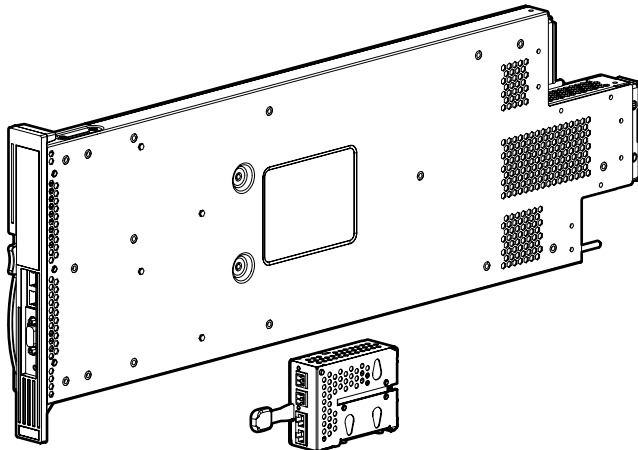

**Figure 1-1: ProLiant BL p-Class GbE Interconnect Switch and QuadT Interconnect Module**

## ProLiant BL p-Class F-GbE Interconnect Kit

The ProLiant BL p-Class F-GbE Interconnect Kit contains two GbE Interconnect Switches and two DualTSX Interconnect Modules. The ProLiant BL p-Class GbE Interconnect Switch uses 10Base-T/100Base-TX/1000Base-SX Gigabit Layer 2 switching technology to provide up to a 32-to-1 reduction in the number of networking cables per BL p-Class server enclosure.

Each GbE Interconnect Switch and DualTSX Interconnect Module reduces sixteen 10Base-T/100Base-TX server networking ports to one or two LC 1000Base-SX and one or two RJ-45 10Base-T/100Base-TX uplink ports.



**Figure 1-2: ProLiant BL p-Class GbE Interconnect Switch and DualTSX Interconnect Module**

## Features

The ProLiant BL p-Class GbE Interconnect Switch and interconnect modules are designed for easy installation and high performance in an environment where traffic on the network and the number of users increases continually.

### Enterprise Class Performance

ProLiant BL p-Class GbE Interconnect Switch features include:

- Up to a 16-to-1 reduction in networking cables and connections
  - Concentration of sixteen 10/100 Ethernet networking ports down to as little as one Gigabit Ethernet port, or up to two Gigabit Ethernet ports plus two 10/100 Ethernet networking ports for additional bandwidth and redundant connections to the network backbone.
  - Integration for a ProLiant BL p-Class server blade enclosure with redundant switching modules that provides redundant networking paths to each server blade.
- Preconfiguration for immediate use with a ProLiant BL p-Class server blade enclosure

- Industry-standard protocols compatible with other widely-used networking components
- Support for up to sixty-four 802.1Q VLANs, for server grouping and isolation
- A variety of in-band and out-of-band management interfaces
- Support for saving and downloading of switch configurations to a TFTP server, thus allowing for rapid deployment of multiple systems, and backup and restore capabilities
- Failover and redundancy features and components
- Front panel link activity and speed indicators
- Extra ports for management debugging and port mirroring

## GbE Interconnect Switch Redundancy

The ProLiant BL p-Class GbE Interconnect Switch offers several redundancy and failover features. With these features, the network configuration can be designed to allow for continued network access to each server blade in case of a component or link failure. GbE Interconnect Switch redundancy and failover features include:

- Two separate GbE Interconnect Switches per one ProLiant BL p-Class server blade enclosure
- Two Gigabit Ethernet uplink ports and two 10/100 Ethernet uplink ports per GbE Interconnect Switch for designing fully meshed uplink paths to the network backbone
- Server networking connections routed to each of the separate GbE Interconnect Switches for redundant paths to tolerate a switch or port malfunction
- Redundant data path 10/100 Ethernet cross connections between GbE Interconnect Switches
- Spanning Tree Protocol support that eliminates potential problems caused by redundant networking paths and provides for failover with a secondary path in case of primary path failure
- Power and cooling by redundant power supplies and redundant cooling fans within the server blade enclosure

## Configuration and Management

The ProLiant BL p-Class GbE Interconnect Switch provides the following configuration and management interfaces and tools:

- A menu-driven console interface allows local, Telnet, or Serial Line Internet Protocol (SLIP) access.
- A browser-based GUI allows remote access using a Web browser such as Microsoft Internet Explorer or Netscape Navigator.
- Simple Network Management Protocol (SNMP) and Remote Monitoring (RMON) manageability and monitoring are supported. An SNMP-based scripting utility allows remote configuration of the GbE Interconnect Switch.

- The interconnect switch functionality allows you to save and download interconnect switch configurations to a TFTP server, thus allowing the rapid deployment of multiple server blade systems, and providing robust backup and restore capabilities.

## Diagnostic Tools

The hardware, software, and firmware diagnostic tools that are available include:

- *Compaq Insight Manager™ 7*
- Power-On Self-Test (POST) built into the interconnect switch boot process
- GbE Interconnect Switch management suite of tools and interfaces
- GbE Interconnect Switch port mirroring
- GbE Interconnect Switch LEDs for port status and speed

## GbE Interconnect Switch Architecture

The ProLiant BL p-Class system provides integrated switching technology for network cable reduction.

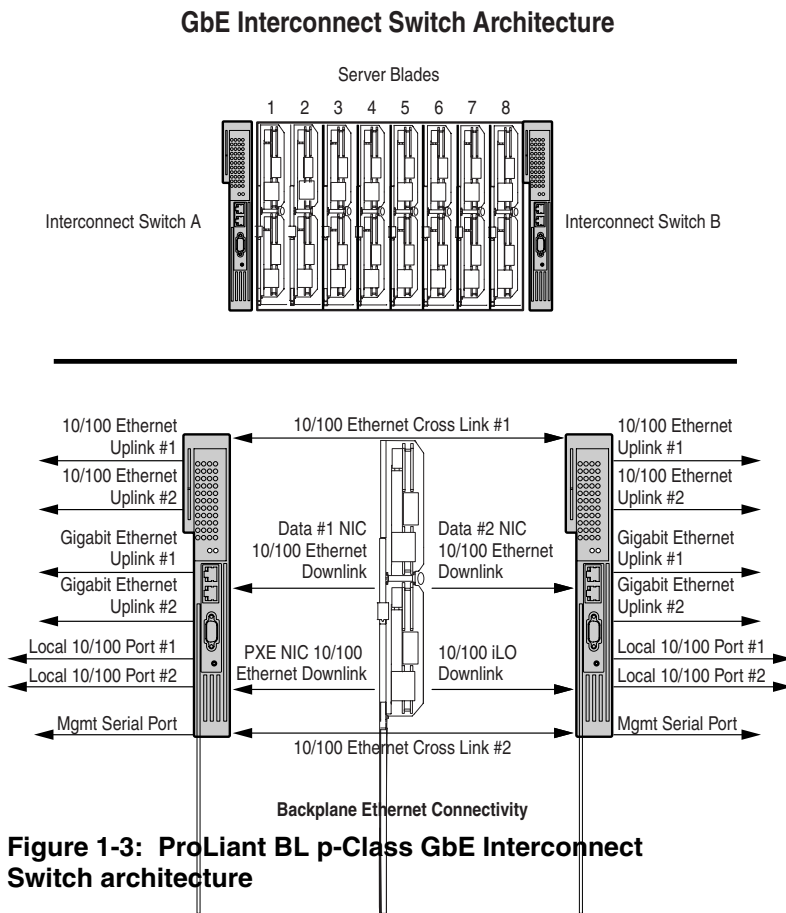

---

## GbE Interconnect Switches

Two GbE Interconnect Switches in the ProLiant BL p-Class server blade enclosure provide switch redundancy and redundant paths to the network ports on the server blades.

Each GbE Interconnect Switch has two Gigabit and two 10/100 Ethernet uplink ports and direct connections to two of the four network controllers on each server blade. The four network controllers on each server blade are NIC1, NIC2, NIC3, and Integrated Lights-Out (iLO). NIC1 is Preboot eXecution Environment (PXE)-enabled. Each pair of GbE Interconnect Switches consolidates up to thirty-two 10/100 Ethernet controllers on eight servers into one-to-four Gigabit ports and one-to-four 10/100 uplink port on the back of the system. This design eliminates up to 31 network cables from the back of the server blade enclosure.

**NOTE:** Refer to the *Compaq ProLiant BL p-Class System Setup and Installation Guide* for more information about Integrated Lights-Out (iLO) management and the Preboot eXecution Environment (PXE).

## Redundant Crosslinks

The two GbE Interconnect Switches are connected through redundant 100-Mb/s crosslinks. These two crosslinks provide an aggregate throughput of 200 Mb/s for traffic between the GbE Interconnect Switches.

## Redundant Paths to Servers

The three 10/100 NIC ports and the one iLO controller on each server are routed through the enclosure backplane to different GbE Interconnect Switches. PXE NIC1 and NIC2 on each server blade are routed to Switch A. NIC 3 and iLO on each server blade are routed to Switch B. This configuration provides redundant paths to each server.

**NOTE:** On a heavily used system, using a single uplink port for all 24 NICs and 8 iLOs can cause a traffic bottleneck. For example, if uplink 1 on Switch A is the only uplink used, all traffic to and from NIC 3 and the iLO on any of the server blades must travel over the crosslinks between Switch A and Switch B. The crossover links are intended as a failover route on the switch management link and should not be used as a primary path. For optimum performance, use the uplink ports from both GbE Interconnect Switches.

## Supported Technologies

The ProLiant BL p-Class GbE Interconnect Switch supports the following technologies. Refer to Chapter 3 and Chapter 4 for more details on these features.



## Layer 2 Based Packet Forwarding

The ProLiant BL p-Class GbE Interconnect Switch uses 10/100/1000 Gigabit Layer 2 switching technology. Layer 2 refers to the Data Link layer of the Open Systems Interconnection (OSI) model, which is concerned with moving data packets across a network by enforcing Carrier Sense Multiple Access with Collision Detection (CSMA/CD). This layer performs the following tasks:

- Ethernet packet framing
- MAC addressing
- Physical medium transmission error detection
- Medium allocation (collision avoidance)
- Contention resolution (collision handling)

Layer 2 switching technology allows the GbE Interconnect Switch to look into data packets and redirect them based on the destination MAC address. This reduces traffic congestion on the network because packets, instead of being transmitted to all ports, are transmitted to the destination port only.

## IEEE 802.1Q Based Virtual Local Area Network

The ProLiant BL p-Class GbE Interconnect Switch provides support for up to sixty-four 802.1Q Virtual Local Area Networks (VLANs) for server grouping and isolation. A VLAN is a network segment configured according to a logical scheme rather than a physical layout. VLANs can be used to combine any collection of LAN segments into an autonomous user group that appears as a single LAN. VLANs also logically segment the physical network into different broadcast domains so that packets are forwarded only between ports within the VLAN. This technology enhances performance by conserving bandwidth and improves security by limiting traffic to specific domains.

**Example 1-1: You may want to isolate the server blade iLO ports from the rest of the NICs. The iLO ports on Interconnect Switch B can be assigned to their own VLAN and go to a dedicated uplink or share an uplink using VLAN tagging. Refer to the “Configuring VLANs” section in Chapter 3 or Chapter 4 for more information.**

## Spanning Tree Protocol

The GbE Interconnect Switch supports the Spanning Tree Protocol (STP), which allows the blocking of links that form loops between switches in a network. When multiple links between switches are detected, a primary link is established. Duplicated links are blocked from use and become standby links. If the primary link fails, the standby link is activated. Refer to Appendix D for more information.

---

## Simple Network Management Protocol and Remote Monitoring

Each GbE Interconnect Switch can be configured and monitored remotely from a Simple Network Management Protocol (SNMP)/Remote Monitoring (RMON)-based network management station. The GbE Interconnect Switch supports industry-standard SNMP Management Information Bases (MIBs), proprietary Compaq Switch MIBs, and RMON groups 1 (Statistics), 2 (History), 3 (Alarm), and 9 (Event) for fault detection, configuration, and monitoring of switch functionality.

To secure the management interface, the switch administrator can configure community strings with various levels of access. Access can be restricted to a limited number of management stations by configuring a list of IP addresses of those stations that can access the GbE Interconnect Switch. Refer to Appendix E for more information.

## Port Mirroring

The GbE Interconnect Switch allows you to mirror a port to another port for network monitoring and troubleshooting purposes. This technology offers a way for network packet analyzers to view the traffic moving through the GbE Interconnect Switches by providing a copy of the traffic that is currently being passed through any other port. The packets are normally sent to a network packet analyzer or other monitoring device attached to the mirror port.

## Trunking

The GbE Interconnect Switch port trunking feature allows several ports to be grouped together and act as a single logical link called a trunk. This feature provides a bandwidth that is a multiple of the bandwidth of a single link. It also improves reliability since a configurable way of load balancing is automatically applied to the ports in the trunked group. A link failure within the group causes the network traffic to be directed to the remaining links in the group.

## Trivial File Transfer Protocol Support

Trivial File Transfer Protocol (TFTP) support allows the GbE Interconnect Switch firmware to be upgraded by downloading a new firmware file from a TFTP server to the GbE Interconnect Switch. A configuration file can also be loaded into a GbE Interconnect Switch from a TFTP server, configuration settings can be saved to the TFTP server, and a history log can be uploaded from the switch to the TFTP server.

## Storage and Forward Switching Scheme

The ProLiant BL p-Class GbE Interconnect Switch provides a storage and forward switching scheme that allows each packet to be buffered (stored) before it is forwarded to its destination. While this method creates latency, it improves reliability in a heavily used interconnect switch. Packets that cannot be forwarded are saved immediately, rather than dropped, so that packets behind them are less likely to be dropped in periods of heavy usage.

## IEEE 802.1p Based Class of Service for Packet Prioritization

Class of Service (CoS) for packet prioritization allows switch administrators to set priority levels on the GbE Interconnect Switch for forwarding packets based on the priority setting information in the packets. The GbE Interconnect Switch supports four classes of traffic (buffers or queues) for implementing priority and allows administrators to map eight priority levels to the four classes. Traffic from a specific server port can be given priority over packets from other devices according to this range of priority levels. For example, with multiple packets in a buffer, the packet with the highest priority would be forwarded first, regardless of when it was received.

## Internet Group Management Protocol Snooping

Internet Group Management Protocol (IGMP) snooping, when enabled and configured properly, manages multicast traffic in a GbE Interconnect Switch by allowing directed switching of the IP multicast traffic. The GbE Interconnect Switch can use IGMP Snooping to configure ports dynamically, so that IP multicast traffic is forwarded only to those ports associated with IP multicast hosts.

IGMP Snooping allows the GbE Interconnect Switch to recognize IGMP queries and reports sent between network stations or devices and an IGMP host that belong to a specific multicast group. When enabled for IGMP Snooping, the GbE Interconnect Switch can open or close a port to a specific device based on IGMP messages passing through the module. This feature further limits unnecessary broadcasts.

## Dynamic Host Configuration Protocol or Bootstrap Protocol

By default, the GbE Interconnect Switch is configured to obtain an IP address from a Dynamic Host Configuration Protocol (DHCP) or Bootstrap Protocol (BOOTP) server during the boot process. The IP settings can also be manually configured by means of the console interface. The IP settings are also configurable from other interfaces, such as the Web, but because the connection is based on an IP address for these interfaces, users will have to reconnect with the newly assigned IP address.

## External Components

This section describes the front panel of the ProLiant BL p-Class GbE Interconnect Switch, the QuadT Interconnect Module Panel, and the DualTSX Interconnect Module Panel.

## GbE Interconnect Switch Front Panel

The front panel of the GbE Interconnect Switch has LEDs to indicate link activity, link speed, power status, and management status. It has two RJ-45 connectors for 10/100 Ethernet test ports, one DB-9 serial management console port, and a power or reset button.

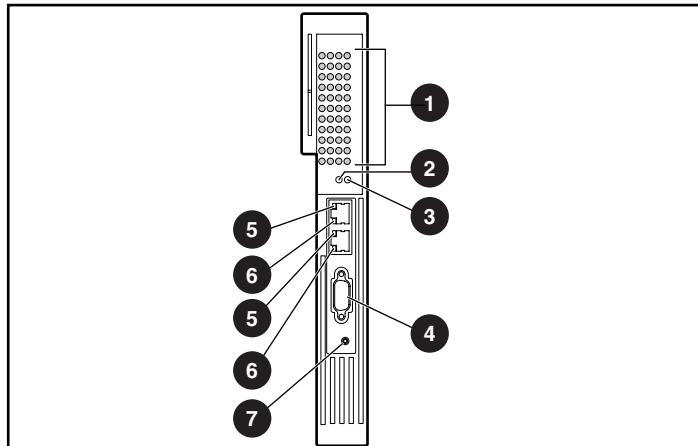
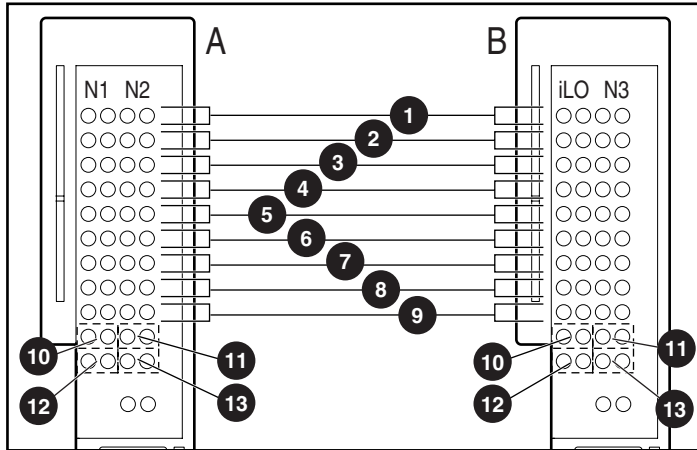

Figure 1-4: GbE Interconnect Switch front panel

Table 1-1: GbE Interconnect Switch Front Panel

Item	Description	Status
1	Link activity and speed LED	Refer to the following figures and tables for link activity and speed LED assignments and functions.
2	Power status LED	Green = Power on Amber = Standby mode Off = Power off
3	Management status LED	Flashing = Management session active Off = No management session active
4	DB-9 connector	Accesses the local management console.
5	Test RJ-45 connector link speed LED	Green = 100 Mb/s Off = 10 Mb/s
6	Test RJ-45 connector link activity LED	Green = Link and no activity Green flashing = Link and activity Amber = Port disabled Off = No link
7	Pwr/Rst button	Forces the GbE Interconnect Switch to power up or reboot.

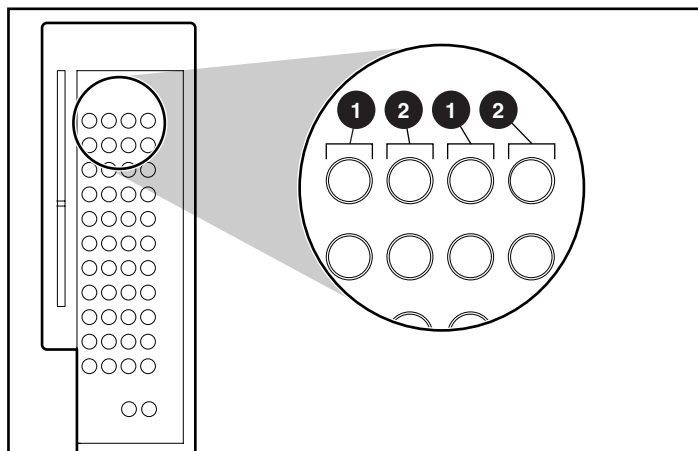

**Figure 1-5: GbE Interconnect Switch front panel NIC LED assignments**

**Table 1-2: GbE Interconnect Switch Front Panel NIC LED Assignments**

Item	Description
1	Server blade 1 Ethernet ports
2	Server blade 2 Ethernet ports
3	Server blade 3 Ethernet ports
4	Server blade 4 Ethernet ports
5	Server blade 5 Ethernet ports
6	Server blade 6 Ethernet ports
7	Server blade 7 Ethernet ports
8	Server blade 8 Ethernet ports
9	Interswitch cross connection ports
10	Port (19x) RJ-45 uplink connector for rear panel uplink ports
11	Port (20x) RJ-45 uplink connector for rear panel uplink ports
12	Port (21x) RJ-45 (or LC)* uplink connector for rear panel uplink ports
13	Port (22x) RJ-45 (or LC)* uplink connector for rear panel uplink ports

\*Ports 21x and 22x are RJ-45 uplink connectors on the QuadT Interconnect Module and LC uplink connectors on the DualTSX Interconnect Module.



**Figure 1-6: GbE Interconnect Switch front panel NIC LED functions**

**Table 1-3: GbE Interconnect Switch Front Panel NIC LED Functions**

Item	LED Description	Status
1	Link speed	Amber = 1000 Mb/s Green = 100 Mb/s Off = 10 Mb/s
2	Link activity	Green = Link and no activity Green flashing = Link and activity Amber = Port disabled Off = No link

## QuadT Interconnect Module Panel

One QuadT Interconnect Module is inserted into the rear side of each GbE Interconnect Switch. Each QuadT Interconnect Module has four RJ-45 connectors with link activity and speed LEDs for uplink network cabling. Two RJ-45 connectors support Gigabit Ethernet connections and two support 10/100 Ethernet connections for uplink connectivity.

**NOTE:** To the side of the two Gigabit Ethernet RJ-45 connectors are LEDs reserved for stacking support. Stacking functionality is planned for a future release of GbE Interconnect Switch firmware.

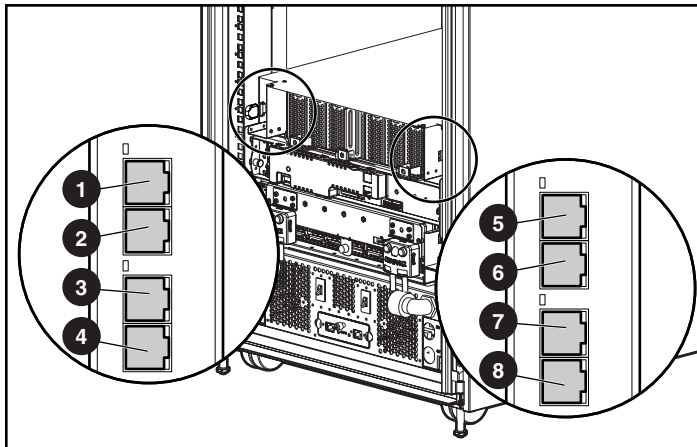
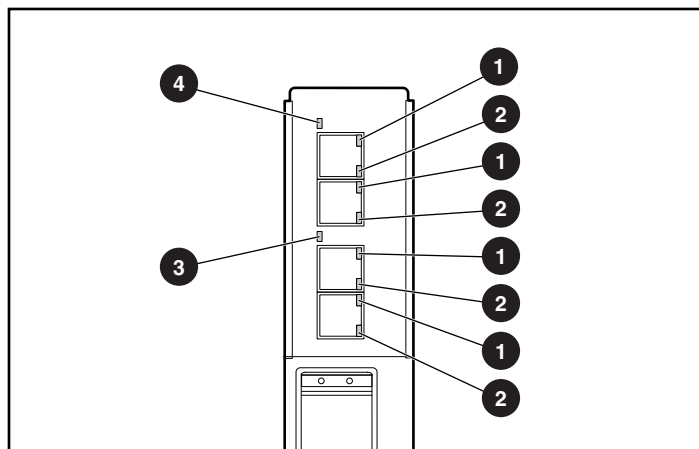

Figure 1-7: QuadT Interconnect Module connectors

Table 1-4: QuadT Interconnect Module Connectors

Item	Description
1	Port (22x) RJ-45 connector for 10/100/1000Base-T uplink on Switch B
2	Port (21x) RJ-45 connector for 10/100/1000Base-T uplink on Switch B
3	Port (20x) RJ-45 connector for 10/100Base-T uplink on Switch B
4	Port (19x) RJ-45 connector for 10/100Base-T uplink on Switch B
5	Port (22x) RJ-45 connector for 10/100/1000Base-T uplink on Switch A
6	Port (21x) RJ-45 connector for 10/100/1000Base-T uplink on Switch A
7	Port (20x) RJ-45 connector for 10/100Base-T uplink on Switch A
8	Port (19x) RJ-45 connector for 10/100Base-T uplink on Switch A



**Figure 1-8: QuadT Interconnect Module LEDs**

**Table 1-5: QuadT Interconnect Module LEDs**

Item	LED Description	Status
1	Link activity	Green = Link and no activity Green flashing = Link and activity Amber = Port disabled Off = No link
2	Link speed	Amber = 1000 Mb/s Green = 100 Mb/s Off = 10 Mb/s
3	Port 21 stacking*	Amber = Slave unit Green = Base unit Off = No stacking
4	Port 22 stacking*	Amber = Slave unit Green = Base unit Off = No stacking

\*Stacking functionality is planned for a future release of the GbE Interconnect Switch firmware.



## DualTSX Interconnect Module Panel

One DualTSX Interconnect Module is inserted into the rear side of each GbE Interconnect Switch. Each DualTSX Interconnect Module has two RJ-45 connectors with link activity and speed LEDs and two LC connectors with only link activity LEDs for uplink network cabling. Two LC connectors support 1000 SX Ethernet short-haul fiber connections, and two RJ-45 connectors support 10/100 Ethernet copper connections for uplink connectivity.

**NOTE:** To the side of the two Gigabit Ethernet LC connectors are LEDs reserved for stacking support. Stacking functionality is planned for a future release of GbE Interconnect Switch firmware.

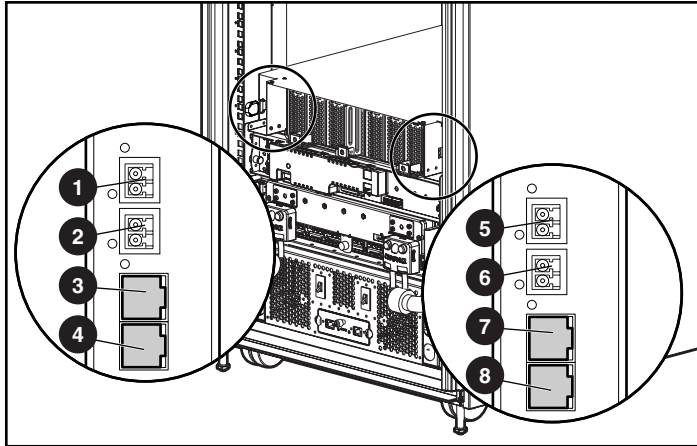
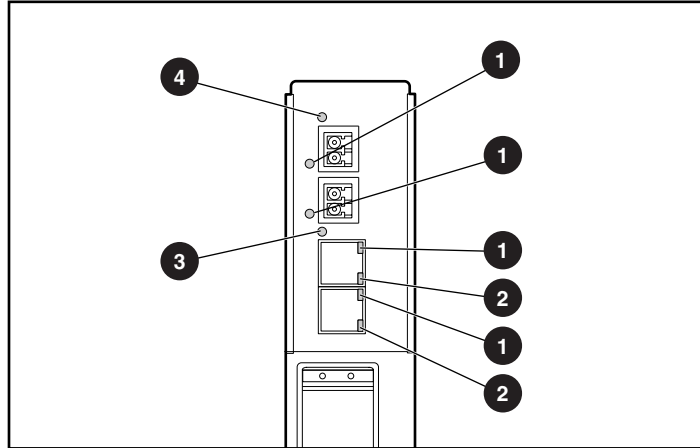

Figure 1-9: DualTSX Interconnect Module connectors

Table 1-6: DualTSX Interconnect Module Connectors

Item	Description
1	Port (22x) LC connector for 1000Base-SX uplink on Switch B
2	Port (21x) LC connector for 1000Base-SX uplink on Switch B
3	Port (20x) RJ-45 connector for 10/100Base-T uplink on Switch B
4	Port (19x) RJ-45 connector for 10/100Base-T uplink on Switch B
5	Port (22x) LC connector for 1000Base-SX uplink on Switch A
6	Port (21x) LC connector for 1000Base-SX uplink on Switch A
7	Port (20x) RJ-45 connector for 10/100Base-T uplink on Switch A
8	Port (19x) RJ-45 connector for 10/100Base-T uplink on Switch A



**Figure 1-10: DualTSX Interconnect Module LEDs**

**Table 1-7: DualTSX Interconnect Module LEDs**

Item	LED Description	Status
1	Link activity	Green = Link and no activity Green flashing = Link and activity Amber = Port disabled Off = No link
2	Link speed	Green = 100 Mb/s Off = 10 Mb/s
3	Port 21 stacking*	Amber = Slave unit Green = Base unit Off = No stacking
4	Port 22 stacking*	Amber = Slave unit Green = Base unit Off = No stacking

\*Stacking functionality is planned for a future release of the GbE Interconnect Switch firmware.

---

## Setting Up and Installing the GbE Interconnect Switch

### Overview

This chapter describes how to set up and install the ProLiant BL p-Class GbE Interconnect Switches and the interconnect modules.

The setup and installation process includes the following tasks:

1. Installing the GbE Interconnect Switches and interconnect modules
2. Planning the GbE Interconnect Switch configuration
3. Cabling the GbE Interconnect Switch to the network
4. Powering up the GbE Interconnect Switch
5. Accessing the GbE Interconnect Switch
6. Logging on and configuring the GbE Interconnect Switch

### Installing the GbE Interconnect Switches and Interconnect Modules

This section describes how to install the hardware in a new GbE Interconnect Switch deployment, a replacement for an existing GbE Interconnect Switch, or an upgrade from an RJ-45 Patch Panel.

**IMPORTANT:** Record the switch MAC address printed on the MAC address label attached to your GbE Interconnect Switch. The MAC address can be used to find the IP address from a DHCP server.

### Installation Guidelines

Observe the following guidelines:

- Always install GbE Interconnect Switches in pairs. Each server blade enclosure requires two GbE Interconnect Switches for proper connectivity. Do not mix the network interconnect environment. Always install the same type of device (either the Compaq ProLiant BL p-Class C-GbE Interconnect Kit, Compaq ProLiant BL p-Class F-GbE Interconnect Kit, or RJ-45 Patch Panels).

- Always install the interconnect modules in the top-left and top-right bays on the rear side of the server blade enclosure.
- Be sure that each interconnect module is fully seated. The latch/handle drops into place when the module is firmly seated.
- Always install the GbE Interconnect Switches into the communication bays, which are the left-most (side A) and right-most (side B) bays on the front side of the server blade enclosure.

## Installing a New GbE Interconnect Switch for a New Deployment

1. Insert the interconnect modules into the top-left and top-right module bays on the rear side of the ProLiant BL p-Class server blade enclosure.

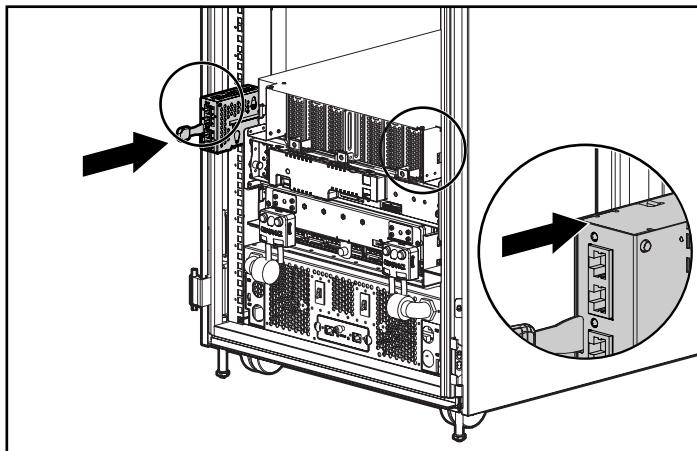

**Figure 2-1: Installing the QuadT or DualTSX Interconnect Modules**

2. Slide the GbE Interconnect Switch into the right communication bay in the front side of the ProLiant BL p-Class server blade enclosure (1).
3. Lock the ejector lever (2).

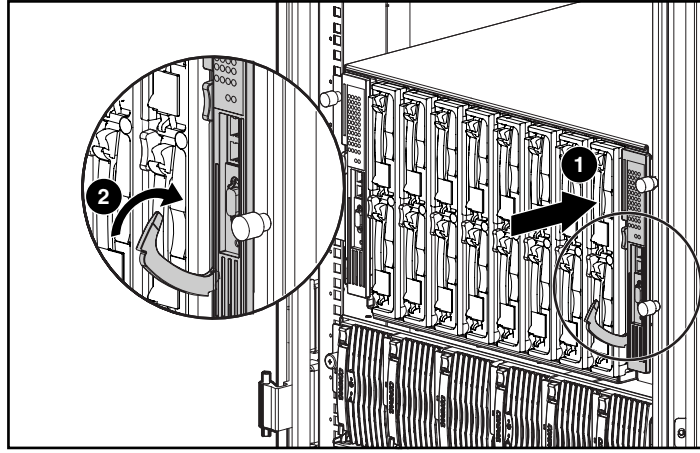

**Figure 2-2: Installing the GbE Interconnect Switches**

4. Repeat steps 2 and 3 for the second GbE Interconnect Switch in the left communication bay.

**IMPORTANT:** Be sure that the interconnect modules are fully seated. The latch/handle will drop into place when the module is firmly seated.

## Replacing an Existing GbE Interconnect Switch



**CAUTION:** Removing an RJ-45 Patch Panel from a powered enclosure **will** result in the loss of network communications between the server blade and the network infrastructure.

**IMPORTANT:** If you are replacing an existing GbE Interconnect Switch or upgrading from an RJ-45 Patch Panel, and have strict security requirements:

- Do not cable the GbE Interconnect Switch until after configuration.
- Or
- Connect the GbE Interconnect Switch to the optional Diagnostic Station. The Diagnostic Station enables you to power up, configure, and diagnose a ProLiant p-Class server blade or a ProLiant p-Class GbE Interconnect Switch outside of the rack environment.

To replace an existing GbE Interconnect Switch:

1. If possible, save the configuration file to a TFTP server for later retrieval. Refer to the “Saving Settings to a TFTP Server” section in Chapter 3 (console management interface) and “Saving Settings to TFTP Server” in Chapter 4 (Web-based management interface).
2. On the front side of the ProLiant BL p-Class server blade, release the ejector lever for the GbE Interconnect Switch.
3. Pull down on the ejector lever to unlock the GbE Interconnect Switch from the enclosure.

4. Slide the GbE Interconnect Switch out of the communication bay.
5. Slide the new GbE Interconnect Switch fully into the communication bay.
6. Close the ejector lever.
7. If you saved the configuration file to a TFTP server, download the configuration. Refer to the “Downloading Configuration File from a TFTP Server” section in Chapter 3 (console management interface) and “Downloading a Configuration File on a TFTP Server” in Chapter 4 (Web-based management interface).

## Upgrading from RJ-45 Patch Panels



**CAUTION:** Removing a GbE Interconnect Switch from a powered enclosure **will** result in the loss of network communications between the server blade and the GbE Interconnect Switch.

---

1. From the front side of the ProLiant BL p-Class server blade enclosure, unlock the ejector lever and slide out the Patch Panels from the left and right communication bays.
2. From the rear side of the server blade enclosure, slide out the top and bottom patch panel RJ-45 modules (four total) from the left and right module bays and unplug the cables.
3. From the rear side of the server blade enclosure, insert the new interconnect modules (two total) that came with the GbE Interconnect Switches into the top-left and top-right module bays.
4. From the front side of the server blade enclosure, slide the GbE Interconnect Switch into the left communication bay.
5. Lock the ejector lever.
6. Repeat steps 4 and 5 to install the second GbE Interconnect Switch in the right communication bay.

## Planning the GbE Interconnect Switch Configuration

Before you configure the GbE Interconnect Switch, Compaq recommends that you plan the configuration. As you plan, consider your default settings, security issues and privileges, and whether you want to configure each GbE Interconnect Switch manually or configure multiple GbE Interconnect Switches at the same time.

### Default Settings

The GbE Interconnect Switches ship with a default configuration in which all ports are enabled and assigned a default virtual LAN (VLAN) with a VLAN ID (VID) equal to 1. This default configuration simplifies your initial setup by allowing you to use a single uplink cable (from any external Ethernet connector) to connect your server blade enclosure to your network. You need to assess your particular server environment to determine any requirements for other considerations.

When planning the configuration, consider the default settings for the following parameters:

- Switch IP settings
- VLAN and Group VLAN Registration Protocol (GVRP) settings
- STP settings
- Port names and types
- Multilink trunk settings
- CoS settings
- Interswitch cross-connect settings
- SNMP/RMON settings
- User name and password settings
- Default access to various management interfaces
- IGMP Snooping settings

**IMPORTANT:** Refer to Appendix C for a complete list of default configuration settings.

## Security Issues

When planning the configuration for a GbE Interconnect Switch, to secure access to the management interface:

- Create users with various access levels to the local console, remote Telnet, and Web interface. Refer to Table 2-1 for the three levels of user access privileges.
- Enable or disable access to various management interfaces to fit the security policy.
- Change default SNMP/RMON community strings for read-only and read-write access.

## Root, User+, and User Privileges

There are three levels of user privileges: Root, User+, and User. Some menu selections available to users with Root privileges may not be available to those with User+ and User privileges. The following table summarizes the user privileges.

**Table 2-1: User Privileges**

Privilege	Root	User+	User
Configuration	Yes	Read-only	Read-only
Network Monitoring	Yes	Read-only	Read-only
Community Strings and Trap Stations	Yes	Read-only	Read-only
Update Firmware and Configuration Files	Yes	No	No
System Utilities	Yes	Ping-only	Ping-only

*continued*

**Table 2-1: User Privileges** *continued*

Privilege	Root	User+	User
Factory Reset	Yes	No	No
Reboot Switch	Yes	Yes	No
Add/Update/Delete User Accounts	Yes	No	No
View User Accounts	Yes	No	No

## Manually Configuring a GbE Interconnect Switch

A GbE Interconnect Switch can be configured manually using a local console interface, a remote Telnet console interface, a Web interface, or an SNMP/RMON interface. Refer to Chapters 3 and 4 for information on how to use these interfaces to configure the GbE Interconnect Switch.

After a switch is configured, you can back up the configuration as a binary file to a TFTP server. The backup configuration file can then be downloaded from the TFTP server to restore the switch back to the original configuration. This restoration may be necessary under one of the following conditions:

- The switch configuration becomes corrupted during operation.
- The switch must be replaced because of a hardware failure.

## Configuring Multiple GbE Interconnect Switches

You can configure multiple GbE Interconnect Switches using the SNMP script utility or a TFTP server.

### Using the SNMP Script Utility

The SNMP script utility, provided with the GbE Interconnect Switch, allows you to execute customized configuration templates on multiple switches. Each configuration template can be tailored to one of the multiple switches, and then that first configuration can be deployed to other servers from a central deployment workstation.

### Using a TFTP Server

If the basic configuration of multiple switches in your network is the same, you can manually configure one GbE Interconnect Switch, upload the configuration to a TFTP server, and use the configuration as a basic configuration template file. This basic configuration template can then be downloaded to multiple GbE Interconnect Switches.



GbE Interconnect Switch IP addresses are acquired by default using DHCP, therefore, each GbE Interconnect Switch has a unique IP address. Each GbE Interconnect Switch can then be remotely accessed from a central deployment workstation and an individual interconnect switch configuration can be entered to meet specific network requirements. Refer to the “Downloading Configuration File from TFTP Server” and “Saving Settings to a TFTP Server” sections in Chapter 3 (console management interface) and “Saving Settings to TFTP Server” and “Downloading a Configuration File on a TFTP Server” in Chapter 4 (Web-based management interface).

## Cabling the GbE Interconnect Switch

After installing the GbE Interconnect Switch hardware and planning the configuration, cable the GbE Interconnect Switch to your network.

**IMPORTANT:** If you are replacing an existing GbE Interconnect Switch or upgrading from an RJ-45 Patch Panel, and have strict security requirements:

- Do not cable the GbE Interconnect Switch until after configuration.
- Or
- Connect the GbE Interconnect Switch to the optional Diagnostic Station. The Diagnostic Station enables you to power up, configure, and diagnose a ProLiant p-Class server blade or a ProLiant p-Class GbE Interconnect Switch outside of the rack environment.

To connect the interconnect modules to the network:

1. Connect your network cables to the interconnect modules. For connector locations, refer to the section “QuadT Interconnect Module Panel” or “DualTSX Interconnect Module Panel” in Chapter 1.
2. Gather your network cables for the right side of the rack.
3. Insert the end of the cable retaining bracket (provided with the bus bar and power bus boxes) into the cable bracket (1).
4. Tighten the thumbscrew to secure the cable retaining bracket over the cables (2).

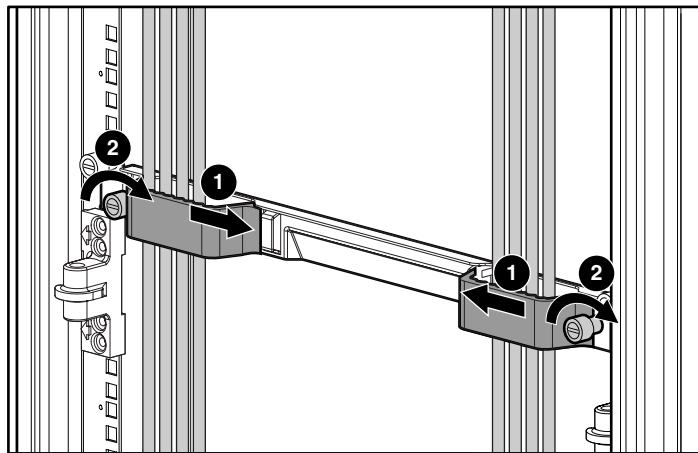

**Figure 2-3: Installing the cable-retaining bracket**

5. Repeat steps 2 through 4 for the network cables on the left side of the rack.

## Powering Up the GbE Interconnect Switch

If the server blade enclosure has power applied, the GbE Interconnect Switch automatically begins to power up when installed. The power status LED on the front of the GbE Interconnect Switch starts out as amber to indicate that power is connected to the GbE Interconnect Switch. After a few seconds, the power status LED turns to green to indicate that the GbE Interconnect Switch is powered up. After the built in self-test flashes all LEDs, the active links are illuminated and the power status LED stays green.

You can manually force the GbE Interconnect Switch to power up by pressing the **Pwr/Rst** button through the access hole in the front panel of the GbE Interconnect Switch while the power status LED is amber. Compaq recommends using a small blunt object for this purpose.



**CAUTION:** Pressing the **Pwr/Rst** button while the power status LED is green will reset the GbE Interconnect Switch.

---

**NOTE:** If the server blade enclosure does not have power applied, refer to the *Compaq ProLiant BL p-Class Class System Setup and Installation Guide*.

## Accessing the GbE Interconnect Switch

The GbE Interconnect Switch can be accessed using the DB-9 serial management port or an Ethernet connection.

- To access the GbE Interconnect Switch locally, use the front panel DB-9 serial management port.
- To access the GbE Interconnect Switch through an Ethernet connection, use either the GbE Interconnect Switch front panel RJ-45 ports or one of the following:
  - The uplink RJ-45 ports in the QuadT Interconnect Module
  - The uplink LC or RJ-45 ports in the DualTSX Interconnect Module

To access the GbE Interconnect Switch remotely, you need to assign it an IP address. By default, the GbE Interconnect Switch is set up to obtain its IP address from a DHCP server existing on the attached network.

To access the GbE Interconnect Switch remotely:

1. Go to the DHCP server and use the GbE Interconnect Switch MAC address to obtain the switch IP address. The MAC address is printed on the MAC address label attached to the GbE Interconnect Switch.
2. From a computer connected to the same network, access the GbE Interconnect Switch using a Web browser or Telnet application. Use the switch IP address obtained in step 1 to access the switch using the Web or console interface. The GbE Interconnect Switch logon screen is displayed.

If the GbE Interconnect Switch does not obtain the IP address assigned by means of the DHCP service, you can access the IP address locally by using the following instructions. After assigning the IP address to the switch, you can then access the switch remotely.

To access the GbE Interconnect Switch locally:

1. Connect the GbE Interconnect Switch DB-9 serial connector, using the null-modem serial cable (provided with the following option kits: Scalable Busbar, Mini Busbar, and Power Bus Box), to a local client device (such as a laptop computer) with VT100 terminal emulation software.
2. Open a VT100 terminal emulation session with the following settings: **9600 baud rate, eight data bits, no parity, and one stop bit**. The GbE Interconnect Switch logon screen is displayed.

## Logging On and Configuring the GbE Interconnect Switch

**NOTE:** The GbE Interconnect Switch logon screen does not have any initial user names or passwords set.

On the GbE Interconnect Switch logon screen:

1. Leave the **User name** field blank, and press the **Tab** key.
2. Leave the **Password** field blank, and press the **Enter** key. The main menu is displayed.
3. Perform the following recommended tasks from the main menu:
  - a. Set up users, passwords, and access privileges.
  - b. Change default SNMP community strings for read-write and read-only.
  - c. Set up network configurations including the IP address (if required).

**NOTE:** After you configure the IP address, the GbE Interconnect Switch can be accessed using Telnet, SNMP, or a Web browser. Refer to the "Configuring the IP Address" section in Chapter 3.

Refer to Chapter 3 for information on how to use the console management interface to change configuration settings and monitor switch operation using one of the following interfaces:

- Local serial RS-232 console management interface
- Remote Telnet console management interface

Refer to Chapter 4 for information on how to use the embedded Web-based (HTML) interface to manage the GbE Interconnect Switch from anywhere on the network using a standard browser, such as Netscape Navigator or Microsoft Internet Explorer.

Appendix E provides information regarding the SNMP and RMON Agents, along with the MIBs supported. This appendix also describes how to use these MIBs to configure and monitor the GbE Interconnect Switch using a generic SNMP manager, such as HP Openview.

## **Additional Information**

For additional information, refer to the Compaq website at  
[www.compaq.com/support/servers](http://www.compaq.com/support/servers)

---

# Configuring the GbE Interconnect Switch Using the Console Management Interface

## Introduction

Your ProLiant BL p-Class GbE Interconnect Switch supports a console management interface that allows you to set up and control your GbE Interconnect Switches, either with an ordinary terminal (or terminal emulator) or over the network using the TCP/IP Telnet protocol. You can use this facility to perform many basic network management functions. In addition, the console program allows you to configure the GbE Interconnect Switches for management using an SNMP-based network management system. This chapter describes how to use the console interface to access the GbE Interconnect Switches, change their settings, and monitor their operation.

## Before You Begin

The ProLiant BL p-Class GbE Interconnect Switch supports a wide array of functions and provides flexibility and increased network performance. Some planning is required to arrive at a deployment strategy that maximizes the potential of the interconnect switch. Refer to the “Planning the GbE Interconnect Switch Configuration” section in Chapter 2 for items to keep in mind as you configure your GbE Interconnect Switches.

## Connecting to the GbE Interconnect Switches

You can use the console interface by connecting the interconnect switch to a VT100-compatible terminal or a computer running an ordinary terminal emulator program (for example, the terminal program included with the Windows operating system) using an RS-232C serial cable.

Set your terminal parameters to the following settings:

- VT-100/ANSI compatible
- 9600 baud
- 8 data bits
- No parity

- One stop bit
- No flow control

You can also access the same functions over a Telnet interface. After you have set an IP address for each GbE Interconnect Switch, you can use a Telnet program (in VT100-compatible terminal mode) to access and control each module. All of the screens are identical, whether they are accessed from the console port or from a Telnet interface.

## Using the Console Management Interface

The console management interface provides many features that make configuring the GbE Interconnect Switch and navigating through the system easy.

## Navigation Features

Use the features in Table 3-1 to navigate through the screens.

**Table 3-1: Console Management Interface Navigation**

To	Action
Toggle between the field options	Highlight items in <angle brackets>, then press the spacebar.
Enter data in a field	Highlight the item in [square brackets], then type the new data.
Execute a command	Highlight the command displayed in UPPERCASE letters, then press the <b>Enter</b> key.
Move between fields on a screen	Press the <b>Page Up</b> and <b>Page Down</b> keys, the left and right arrow keys, the <b>Tab</b> key, or the <b>Backspace</b> key.
Display the previous screen	Press the <b>Esc</b> key.
Display the main menu	Press the <b>Ctrl+T</b> keys.
Refresh the screen display	Press the <b>Ctrl+R</b> keys.
Display the next page of information	Press the <b>N</b> key.
Display the previous page of information	Press the <b>P</b> key.

## Field-level Help and System Messages

The bottom section of each screen displays field-level help and system messages.

- **Function**—Displays field-level help.
- **Message**—Displays system messages.

## Logging On to the GbE Interconnect Switch

When you log on to a GbE Interconnect Switch, the following logon screen is displayed. Notice that the name of the GbE Interconnect Switch is also displayed on the screen.

```
Compaq ProLiant BL p-Class GbE Interconnect Switch B
Copyright 2001, Compaq Computer Corporation

Switch MAC: 00-80-C8-24-37-1A
DVM IP: 10.10.27.87

Username: [ ]
Password: [ ]

*****
Function:Enter case-sensitive username.
Message:
CTRL+R = Refresh
```

**IMPORTANT:** The switch does not have any initial user names or passwords set. Compaq recommends that after logging on, you create at least one Root-level user as the switch administrator. (Refer to Table 2-1 in Chapter 2 for an explanation of user privileges.) If you forget your password after it has been set up, call Compaq Customer Support for assistance.

To log on for the first time:

1. Leave the **Username** field blank and press the **Tab** key.
2. Leave the **Password** field blank and press the **Enter** key. The main menu for the GbE Interconnect Switch is displayed. The main menu displays the major categories for switch management.

**NOTE:** Subsequent users will enter their user name and password, then press the **Enter** key.

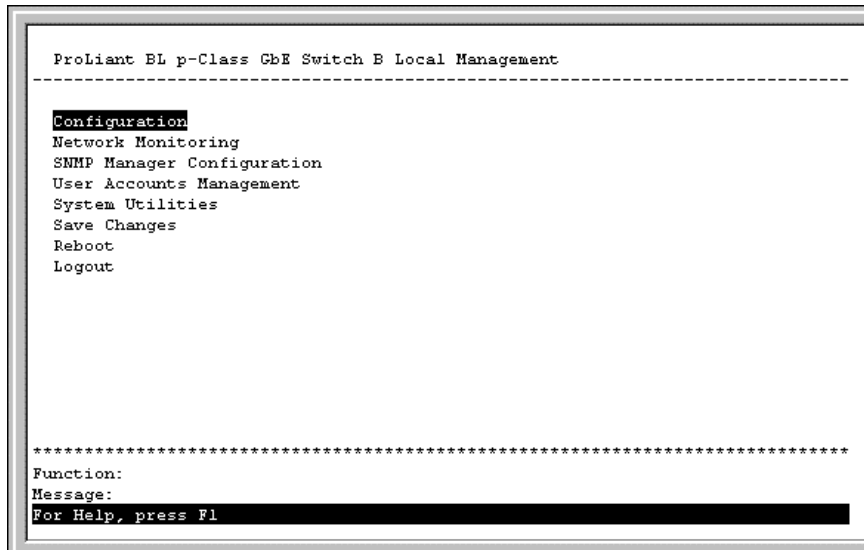

```
ProLiant BL p-Class GbE Switch B Local Management
-----
Configuration
Network Monitoring
SNMP Manager Configuration
User Accounts Management
System Utilities
Save Changes
Reboot
Logout

*****
Function:
Message:
For Help, press F1
```

## Setting Up New Users

After logging on to the GbE Interconnect Switch for the first time, you need to set up at least one user account with Root privileges. You can set up a maximum of eight users on a GbE Interconnect Switch.



To create a new user account:

1. Highlight **User Accounts Management** on the main menu and press the **Enter** key. The **Setup User Accounts** screen is displayed.

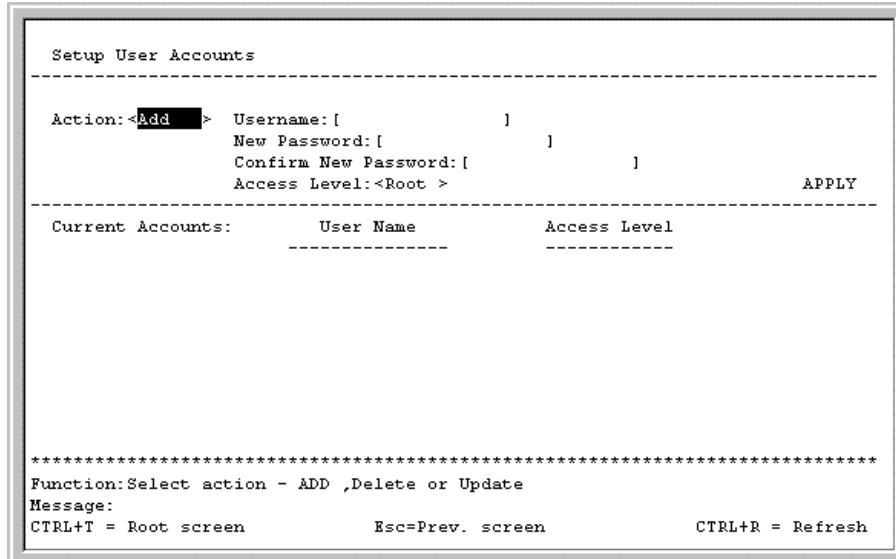

2. Using the spacebar, toggle the **Action** field to select **Add**.

**NOTE:** The other options are **Delete**, which allows the deletion of a user entry, and **Update**, which allows for changes to be made to an existing user entry.

3. Type the user’s name in the **Username** field.
4. Type an initial password for the user in the **New Password** field.

**NOTE:** Passwords used to access the GbE Interconnect Switch are case-sensitive.

5. Type the new password a second time in the **Confirm New Password** field.
6. Using the spacebar, toggle the **Access Level** field to select the user’s access privilege.
7. Highlight **APPLY**. Press the **Enter** key to make the user addition effective. A listing of all current user accounts and access levels is displayed.

**IMPORTANT:** **APPLY** makes changes to the switch configuration for the current session only. You must enter all permanent changes, including user additions or updates, into non-volatile RAM (NVRAM) using the **Save Changes** option on the main menu. Refer to the “Saving Changes” section.

8. Press the **Esc** key to return to the main menu. Use the **Save Changes** option to save the changes into non-volatile RAM.

## Saving Changes

The GbE Interconnect Switch has two levels of memory, normal RAM and non-volatile RAM (NVRAM). Configuration changes are made effective on a screen by highlighting **APPLY**, then pressing the **Enter** key. When this is done, the settings are immediately applied to the switching software in RAM.

Some settings require you to restart the GbE Interconnect Switch before they will take effect. Restarting the GbE Interconnect Switch erases all settings in RAM and reloads the stored settings from NVRAM. Thus, it is necessary to save all setting changes to NVRAM before rebooting the GbE Interconnect Switch.

To retain any configuration changes permanently in NVRAM:

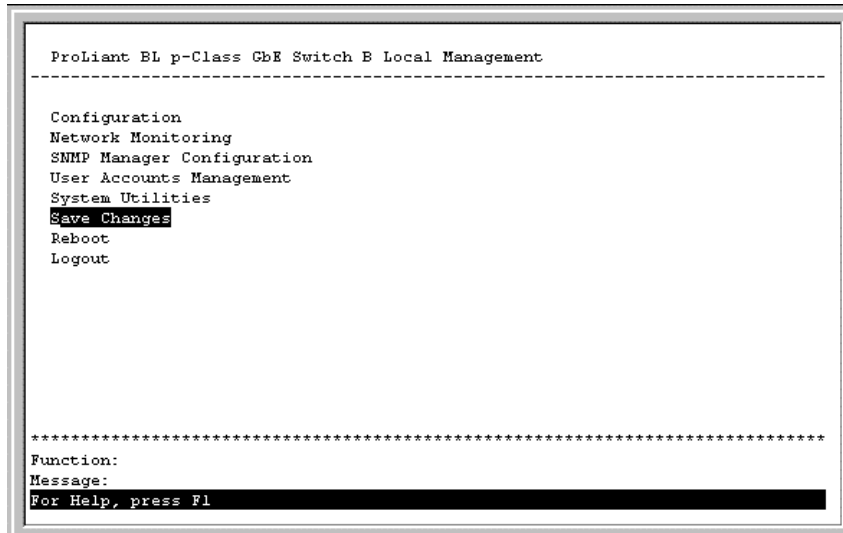

1. Highlight **Save Changes** on the main menu.

2. Press the **Enter** key. The following screen is displayed to verify that your new settings have been saved to NVRAM.

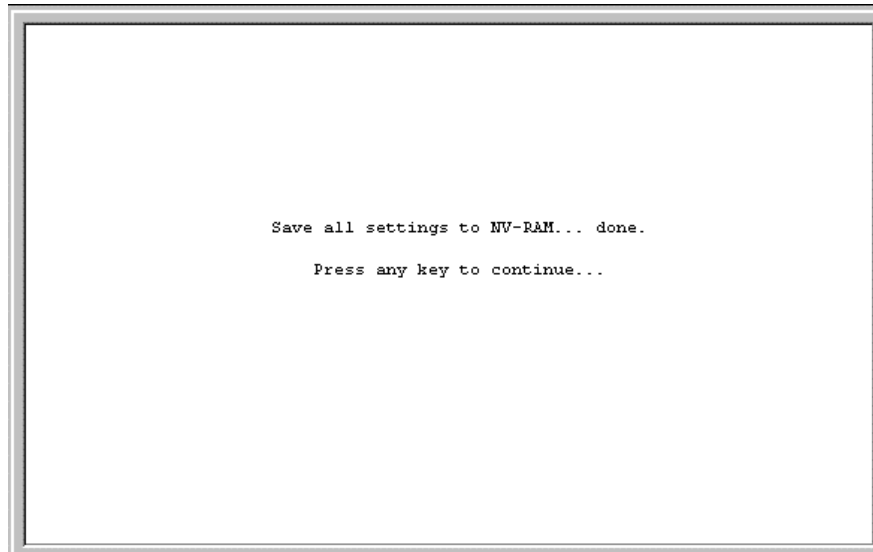

After the configuration settings have been saved to NVRAM, they become the default settings for the GbE Interconnect Switch. These settings are then used every time the GbE Interconnect Switch is rebooted.

**IMPORTANT:** After saving your final configuration, Compaq highly recommends that you save the configuration image to TFTP server storage. Refer to the "Saving Settings to a TFTP Server" section later in this chapter for more information.

## Managing User Accounts

Changes to user accounts are made through the **User Account Management** option on the main menu. Only a user with Root privileges can make changes to user accounts.

## Updating a User Account

To update a user password or privilege level:

1. Highlight **User Accounts Management** on the main menu.
2. Press the **Enter** key. The **Setup User Accounts** screen is displayed.

```

Setup User Accounts
-----
Action: <Add >  Username: [          ]
                New Password: [          ]
                Confirm New Password: [          ]
                Access Level: <Root >                                APPLY
-----
Current Accounts:      User Name      Access Level
                      -----
*****
Function: Select action - ADD ,Delete or Update
Message:
CTRL+T = Root screen      Esc=Prev. screen      CTRL+R = Refresh
    
```

3. Toggle the **Action** field to select **Update**.
4. Type the user name for the account you want to change in the **Username** field.
5. If the password is to be changed, type the new password in the **New Password** and **Confirm New Password** fields.
6. If the privilege level is to be changed, toggle the **Access Level** field until the appropriate level is displayed—**Root**, **User+**, or **User**.
7. Highlight **APPLY** and press the **Enter** key to make the change effective.

**NOTE:** To save the configuration settings permanently, you must enter them into NVRAM using the **Save Changes** option on the main menu. Refer to the “Saving Changes” section earlier in this chapter.

## Viewing Current User Accounts

To view the current user accounts:

1. Highlight **User Accounts Management** on the main menu.
2. Press the **Enter** key. The **Setup User Accounts** screen displays a list of all current user accounts.

## Deleting a User Account

To prevent accidental deletion of all of the users with Root privilege, the console interface does not allow you delete the current logged-on user.

To delete a user account:

1. Highlight **User Accounts Management** on the main menu.
2. Press the **Enter** key. The **Setup User Accounts** screen displays a list of all current user accounts.
3. Toggle the **Action** field to select **Delete**.
4. Type the user name in the **Username** field.
5. Type the user's password for the account you want to delete in the **New Password** field.
6. Highlight **APPLY** and press the **Enter** key.

**NOTE:** To save the configuration settings permanently, you must enter them into NVRAM using the **Save Changes** option on the main menu. Refer to the "Saving Changes" section earlier in this chapter.

## Configuring the GbE Interconnect Switch

This section describes options found under the **Configuration** menu.

```

Configuration
-----
Configure IP Address
Configure Switch Information and Advanced Settings
Configure Ports
Configure Bandwidth
Configure Spanning Tree Protocol
Configure Static (Destination-Address Filtering) Table
Configure VLANs
Configure IGMP Snooping
Configure Port Trunking
Configure Port Mirroring
Configure Threshold of Broadcast/Multicast/DA-Unknown Storm
Configure Class of Service, Default Priority and Traffic Class
Configure Port Security
Configure Priority MAC Addresses
Configure RS232 and SLIP

*****
Function:
Message:
CTRL+T = Root screen           Esc=Prev. screen           CTRL+R = Refresh
    
```

## Configuring the IP Address

Some settings must be entered to allow the GbE Interconnect Switch to be managed from an SNMP-based Network Management System, such as SNMP v1, or to be able to access the GbE Interconnect Switch using the Telnet protocol.

To set up the GbE Interconnect Switch for remote management:

1. Highlight **Configure IP Address** from the **Configuration** menu.
2. Press the **Enter** key. The following screen is displayed.

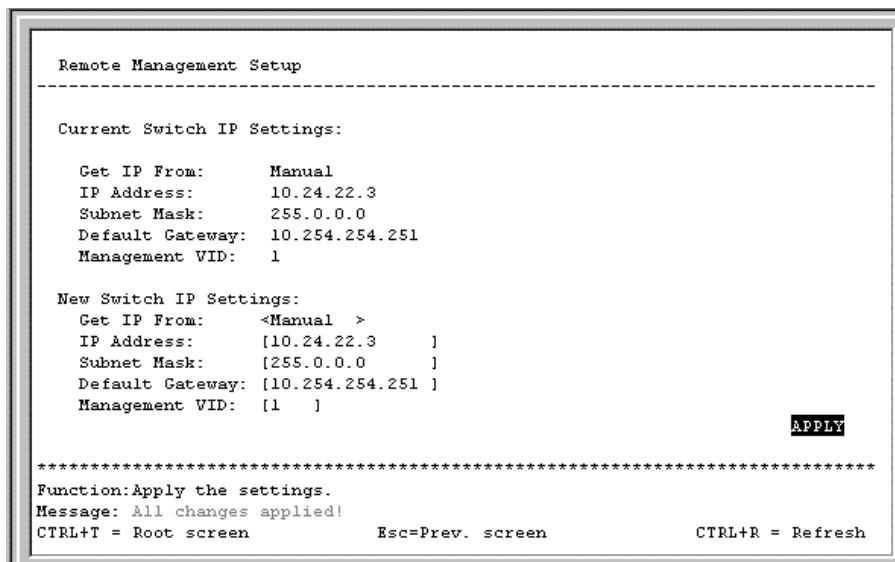

The **Remote Management Setup** screen lets you specify how the GbE Interconnect Switch will be assigned an IP address, which allows an in-band network management system (for example, Telnet) client to find it on the network.

The fields listed under the **Current Switch IP Settings** heading are those that are currently being used by the GbE Interconnect Switch. The fields listed under the **New Switch IP Settings** heading are those that will be used after the GbE Interconnect Switch has been rebooted.

3. Toggle the **Get IP From** field to choose from **Manual**, **BOOTP**, or **DCHP**. This action selects how the GbE Interconnect Switch will be assigned an IP address on the next reboot or startup.
  - **BOOTP**—The GbE Interconnect Switch sends out a BOOTP broadcast request when it is powered up. The BOOTP protocol allows IP addresses, network masks, and default gateways to be assigned by a central BOOTP server. If this option is set, the GbE Interconnect Switch first looks for a BOOTP server to provide it with this information before using the default or previously entered settings.
  - **DCHP**—The GbE Interconnect Switch sends out a DCHP broadcast request when it is powered up. The DCHP protocol allows IP addresses, network masks, and default gateways to be assigned by a DCHP server. If this option is set, the GbE Interconnect Switch first looks for a DCHP server to provide it with this information before using the default or previously entered settings.

- **Manual**—This option allows the entry of an IP address, subnet mask, and default gateway for the GbE Interconnect Switch. The data in these fields should be of the form *xxx.xxx.xxx.xxx*, where each *xxx* is a number between 0 and 255. This address should be a unique address on the network assigned for use by the Network Administrator. The fields that require entries under this option include:
  - **Subnet Mask**—A Bitmask that determines the extent of the subnet that the GbE Interconnect Switch is on. The value should be 255.0.0.0 for a Class A network, 255.255.0.0 for a Class B network, and 255.255.255.0 for a Class C network, but custom subnet masks are allowed.
  - **Default Gateway**—An IP address that determines where packets with a destination address outside the current subnet should be sent. This is usually the address of a router or a host acting as an IP gateway. If your network is not part of an intranet, or you do not want the GbE Interconnect Switch to be accessible outside your local network, you can leave this field unchanged.

If you select **Manual**, type the appropriate data into the **IP Address**, **Subnet Mask**, and **Default Gateway** fields.

4. Type the VLAN ID (VID) of a VLAN that will have access to the Telnet manager in the **Management VID** field. This ID will be the VID of the VLAN on which a management station is located.
5. Highlight **APPLY** and press the **Enter** key to make the change effective.

**NOTE:** To save the configuration settings permanently, you must enter them into NVRAM using the **Save Changes** option on the main menu. Refer to the “Saving Changes” section earlier in this chapter.

## Configuring the GbE Interconnect Switch Information and Advanced Settings

To configure the GbE Interconnect Switch information and advanced settings:

1. Highlight **Configure Switch Information and Advanced Settings** from the **Configuration** menu.

2. Press the **Enter** key. The following screen is displayed.

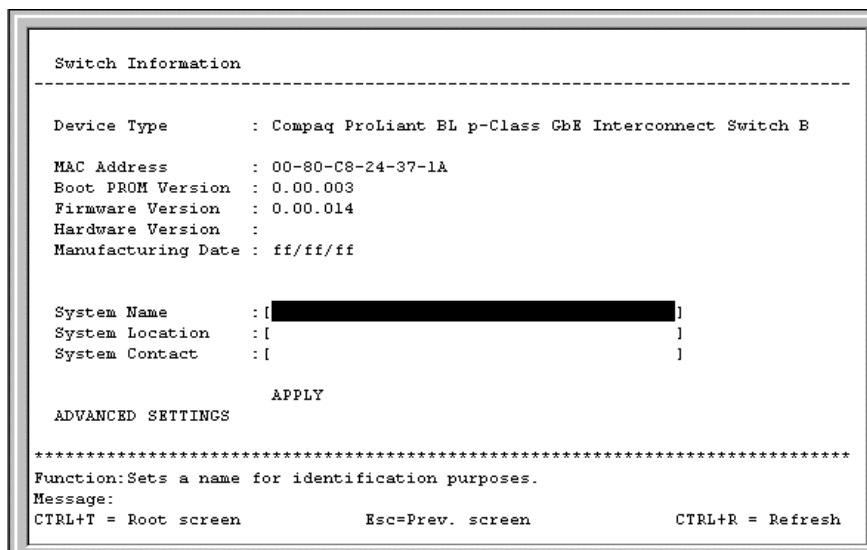

## Configuring GbE Interconnect Switch Information

The **Switch Information** menu shows the type of switch, any external modules that are installed, and the MAC address (assigned by the factory and unchangeable) for that GbE Interconnect Switch. In addition, the boot PROM and firmware version numbers are shown. This information is helpful in monitoring PROM and firmware updates and obtaining the MAC address for entry into the address table of another network device.

To complete the GbE Interconnect Switch information:

1. Type the name of the system in the **System Name** field.
2. Type the location of the system in the **System Location** field.
3. Type the name and telephone number of the System Administrator in the **System Contact** field. Compaq recommends entering the name of the person who is responsible for the maintenance of the network system on which the GbE Interconnect Switch is located.
4. Highlight **APPLY** and press the **Enter** key to make the change effective.

**NOTE:** To save the configuration settings permanently, you must enter them into NVRAM using the **Save Changes** option on the main menu. Refer to the “Saving Changes” section earlier in this chapter.

## Configuring Advanced GbE Interconnect Switch Features

To configure advanced GbE Interconnect Switch features:

1. Highlight **ADVANCED SETTINGS** at the bottom of the **Switch Information** menu.



2. Press the **Enter** key. The following screen is displayed.

```

Configure Advanced Switch Features
-----
Auto-Logout: <10 mins>
MAC Address Aging Time(sec): [300  ]
IGMP Snooping: <Disabled>
Switch GVRP: <Disabled>
Telnet Status: <Enabled >
Web Status: <Enabled >
Group Address Filter Mode: <Forward All Unregistered>
Scheduling Mechanism for CoS Queues: <Strict >
Trunk Load Sharing Algorithm: <Src Address >
Backpressure: <Disabled>

                                APPLY

*****
Function: Select auto logout timer.
Message:
CTRL+T = Root screen          Esc=Prev. screen          CTRL+R = Refresh

```

The **Configure Advanced Switch Features** screen allows you to set the following features:

- **Auto-Logout**—Sets the time the interface can be idle before the GbE Interconnect Switch automatically logs out the user. The options are **2 mins**, **5 mins**, **10 mins**, **15 mins**, and **Never**.
- **MAC Address Aging Time (sec)**—Specifies the length of time a learned MAC address remains in the forwarding table without being accessed (that is, how long a learned MAC address is allowed to remain idle). The **Aging Time** can be set to any value between 10 and 1,000,000 seconds.
- **IGMP Snooping**—Enables Internet Group Management Protocol (IGMP) Snooping, which enables the GbE Interconnect Switch to read IGMP packets being forwarded through the GbE Interconnect Switch in order to obtain forwarding information from them and learn which ports contain multicast members.
- **Switch GVRP**—Allows members to dynamically join VLANs. This feature is used to enable or disable the Group VLAN Registration Protocol (GVRP) on the GbE Interconnect Switch.
- **Telnet Status**—Allows access to the GbE Interconnect Switch over the network using the TCP/IP Telnet protocol by toggling to **Enabled**.
- **Web Status**—Allows use of a Web-based browser to manage the GbE Interconnect Switch by toggling to **Enabled**.
- **Group Address Filter Mode**—Sets the IGMP filter mode for processing multicast packets. The options are **Forward All**, **Forward All Unregistered**, and **Filtered All Unregistered**.

- **Scheduling Mechanism for CoS Queues**—Provides two possibilities for setting Class of Service queue options, **RoundRobin** and **Strict**. If you select **Strict**, when the highest priority queue is full, those packets are the first to be forwarded. If you select **RoundRobin**, the forwarding is based on the settings made on the **Class of Service Configuration** screen.
- **Trunk Load Sharing Algorithm**—Sets options for trunk load sharing. The trunk load sharing options are **Dst Address**, **Src&Dst Address**, and **Src Address**.
- **Backpressure**—Select **Enabled** or **Disabled** to initiate or terminate traffic flow control in and out of the switch.

**NOTE:** A very long aging time can result in out-of-date Dynamic Entries that may cause incorrect packet filtering and forwarding decisions. A very short aging time may cause entries to be aged out too soon, resulting in a high percentage of received packets whose source addresses cannot be found in the address table, in which case the GbE Interconnect Switch will broadcast the packet to all ports, negating many of the benefits of having a switch.

3. After making your changes, highlight **APPLY**, then press the **Enter** key.

**NOTE:** To save the configuration settings permanently, you must enter them into NVRAM using the **Save Changes** option on the main menu. Refer to the “Saving Changes” section earlier in this chapter.

## Configuring Port Settings

To configure ports:

1. Highlight **Configure Ports** from the **Configuration** menu.
2. Press the **Enter** key. The following screen is displayed.

```

Configure Ports
-----
View Ports:<1 to 12 > Configure Port:[1 ] Port Name:[Server1_IL0 ]
State:<Enabled > Speed/Duplex:<Auto > Flow Control:<Off > APPLY
-----
P#  Type      VLAN Name      Port Name      State  Settings  Connection
-----
1  Server  DEFAULT_VLAN  Server1_IL0    Enabled Auto/Off  -
2  Server  DEFAULT_VLAN  Server1_Port3  Enabled Auto/Off  -
3  Server  DEFAULT_VLAN  Server2_IL0    Enabled Auto/Off  -
4  Server  DEFAULT_VLAN  Server2_Port3  Enabled Auto/Off  -
5  Server  DEFAULT_VLAN  Server3_IL0    Enabled Auto/Off  -
6  Server  DEFAULT_VLAN  Server3_Port3  Enabled Auto/Off  -
7  Server  DEFAULT_VLAN  Server4_IL0    Enabled Auto/Off  -
8  Server  DEFAULT_VLAN  Server4_Port3  Enabled Auto/Off  -
9  Server  DEFAULT_VLAN  Server5_IL0    Enabled Auto/Off  -
10 Server  DEFAULT_VLAN  Server5_Port3  Enabled Auto/Off  -
11 Server  DEFAULT_VLAN  Server6_IL0    Enabled Auto/Off  -
12 Server  DEFAULT_VLAN  Server6_Port3  Enabled Auto/Off  -
*****
Function:Select the scope of ports for display and configuration.
Message:
CTRL+T = Root screen      Esc=Prev. screen      CTRL+R = Refresh
    
```

3. Toggle the **View Ports** field, using the spacebar, to display the configuration of Ports **1 through 12** or Ports **13 through 24**.

4. Type the port number in the **Configure Port** field.
5. Toggle the **State** field to enable or disable a given port.
6. Toggle the **Speed/Duplex** field to select the speed and duplex state of the port. **Auto** means auto-negotiation between 10-Mb/s, 100-Mb/s, or 1000-Mb/s devices in full- or half-duplex mode. The **Auto** setting allows the port to automatically determine the fastest settings that the device the port is connected to can handle. The other options are **1000M/Full**, **100M/Full**, **100M/Half**, **10M/Full**, or **10M/Half**. There is no automatic adjustment of port settings with any option other than **Auto**.

**NOTE:** If you have the ProLiant BL p-Class F-GbE Interconnect Kit option with the DualTSX Interconnect Modules, the management interface supports only 1000M/Full and Auto options for the Speed/Duplex fields for Gigabit uplink ports, The fiber Dual TSX Interconnect module supports **only 1000-Mb/s (Gigabit) speed**, and **not** 10-Mb/s or 100-Mb/s.

7. Toggle **Flow Control** to **On** or **Off**.
8. Highlight **APPLY** and press the **Enter** key to make the change effective.

**NOTE:** To save the configuration settings permanently, you must enter them into NVRAM using the **Save Changes** option on the main menu. Refer to the "Saving Changes" section earlier in this chapter.

## Configuring Bandwidth

To configure bandwidth:

1. Highlight **Configure Bandwidth** on the **Configuration** menu.
2. Press the **Enter** key. The following menu is displayed.

```
Bandwidth Configuration
-----
Configure Restart Port Ingress Bandwidth
Display Current Port Ingress Bandwidth
Configure Restart Port Egress Bandwidth
Display Current Port Egress Bandwidth

*****
Function:
Message:
CTRL+T = Root screen          Esc=Prev. screen          CTRL+R = Refresh
```

The **Bandwidth Configuration** menu allows you to access screens that set and display the ingress bandwidth and egress bandwidth of specified ports on the GbE Interconnect Switch.

## Configuring Restart Port Ingress Bandwidth

To configure restart port ingress bandwidth:

1. Highlight **Configure Restart Port Ingress Bandwidth** on the **Bandwidth Configuration** menu.
2. Press the **Enter** key. The following screen is displayed.

```
Setup Restart Ingress Bandwidth
-----
Action: <Add/Modify>   Port: [1 ]   Ingress Bandwidth: [1 ]units   APPLY
-----
Port   Units   KBytes   Port Speed   Port   Units   KBytes   Port Speed
-----

```

\*\*\*\*\*  
Function: Select the action- ADD/MODIFY or DELETE.  
Message:  
Esc= Previous screen CTRL+R= Refresh CTRL+N= Next Page CTRL+P=Previous Page

3. Toggle the **Action** field to **Add/Modify**.  
**NOTE:** To delete an entry, toggle the **Action** field to **Delete**.
4. Type a port number in the **Port** field.
5. Type a number between 1 and 127 in the **Ingress Bandwidth** field.
6. Highlight **APPLY** and press the **Enter** key.
7. Save the changes using **Save Changes** on the main menu.
8. Reboot the GbE Interconnect Switch to allow your changes to take effect.

## Displaying Current Port Ingress Bandwidth

To view the current port ingress bandwidth settings:

1. Highlight **Display Current Port Ingress Bandwidth** on the **Bandwidth Configuration** menu.
2. Press the **Enter** key. The following screen is displayed.

```
-
Display Current Ingress Bandwidth Settings
-----
Port  Units  KBytes  Port Speed      Port  Units  KBytes  Port Speed
-----  -----  -----  -----
*****
Function:
Message:
Esc= Previous screen  CTRL+R= Refresh  CTRL+N= Next Page  CTRL+P=Previous Page
```

This read-only screen displays current ingress bandwidth information.

## Configuring Restart Port Egress Bandwidth

To configure port egress bandwidth:

1. Highlight **Configure Restart Port Egress Bandwidth** on the **Bandwidth Configuration** screen.
2. Press the **Enter** key. The following screen is displayed.

```

Setup Restart Egress Bandwidth
-----
Action: <Add/Modify>      Server Port: [slp1]  Destination Port: [1  ]
Egress Bandwidth: [1  ] units                                APPLY
-----
Srv Port  Dst. Port  Units  KBytes  Port Speed
-----
  S1P2     2         2     1872   none
  S1P2     3         1      936   none
  S1P2    24         1      936   none
-----
*****
Function: Select the action- ADD/MODIFY or DELETE.
Message:
Esc= Previous screen  CTRL+R= Refresh  CTRL+N= Next Page  CTRL+P=Previous Page
    
```

3. Toggle the **Action** field to **Add/Modify**.
  - NOTE:** To delete an entry, toggle the **Action** field to **Delete**.
4. Type a destination port in the **Port** field.
5. Type a number between 1 and 127 in the **Egress Bandwidth** field.
6. Highlight **APPLY** and press the **Enter** key.
7. Save the changes using **Save Changes** on the main menu.
8. Reboot the GbE Interconnect Switch to allow your changes take effect.

## Displaying Current Port Egress Bandwidth Settings

To view port egress bandwidth settings:

1. Highlight **Display Current Port Egress Bandwidth** on the **Bandwidth Configuration** menu.
2. Press the **Enter** key. The following screen is displayed.

```

-
Display Current Egress Bandwidth
-----
-----
Srv Port  Dst. Port  Units  KBytes  Port Speed
-----
S1P2      2           2      1872    none
S1P2      3           1       936    none
S1P2     24           1       936    none

*****
Function:
Message:
Esc= Previous screen  CTRL+R= Refresh  CTRL+N= Next Page  CTRL+P=Previous Page

```

This read-only screen displays current egress bandwidth information.

## Configuring Spanning Tree Protocol

STP operates on two levels: the GbE Interconnect Switch level and the port level. On the GbE Interconnect Switch level, the settings are globally implemented. On the port level, the settings are implemented on a user-defined group basis.

To globally configure the Spanning Tree Protocol (STP) on the GbE Interconnect Switch:

1. Highlight **Configure Spanning Tree Protocol** on the **Configuration** menu.
2. Press the **Enter** key. The following screen is displayed.

```

Configure Spanning Tree
-----
Switch Settings:                STP Status:
  Status: <Disabled>           Bridge ID: 800000055DF93287
  Max Age: [20]                Designated Root Bridge: 00055DF93287
  Hello Time: [2 ]             Root Priority: 32768
  Forward Delay: [15]          Cost to Root: 0
  Priority: [32768]             Root Port: 0
                               Last Topology Change: 2126 secs
                               Topology Changes Count: 0
                               APPLY

Port Settings

*****
Function:Set spanning tree status.
Message:
CTRL+T = Root screen          Esc=Prev. screen          CTRL+R = Refresh
    
```

**NOTE:** The factory default settings should cover the majority of installations. Compaq recommends that you keep the default settings as set at the factory unless it is absolutely necessary to change them.

**NOTE:** Observe the following formulas when setting the STP parameters:

- $\text{Max Age} \leq 2 \times (\text{Forward Delay} - 1 \text{ second})$
- $\text{Max Age} \geq 2 \times (\text{Hello Time} + 1 \text{ second})$

The **Configure Spanning Tree** screen allows you to set the following:

- **Status**—Toggle to **Enabled** to implement STP on the GbE Interconnect Switch.
- **Max Age**—The maximum age can be set from 6 to 40 seconds. At the end of the maximum age, if a Bridge Protocol Data Unit (BPDU) has still not been received from the Root Bridge, your GbE Interconnect Switch will start sending its own BPDU to all other switches for permission to become the Root Bridge. If your GbE Interconnect Switch has the lowest Bridge Identifier, it will become the Root Bridge.
- **Hello Time**—The hello time can be set from 1 to 10 seconds. This is the interval between two transmissions of BPDU packets sent by the Root Bridge to tell all other switches that it is indeed the Root Bridge. If you set a hello time for your GbE Interconnect Switch, and it is not the Root Bridge, the set hello time will be used if and when your GbE Interconnect Switch becomes the Root Bridge. The hello time cannot be longer than the maximum age, otherwise, a configuration error will occur.



- **Forward Delay**—The forward delay can be from 4 to 30 seconds. This is the time any port on the GbE Interconnect Switch spends in the listening state while moving from the blocking state to the forwarding state.
- **Priority**—A priority for the GbE Interconnect Switch can be set from 0 to 65,535. Zero indicates the highest priority. The priority number is used in the voting process between switches on the network to determine which GbE Interconnect Switch will be the Root GbE Interconnect Switch. A low number indicates a high priority, and a high probability that this GbE Interconnect Switch will be elected as the Root GbE Interconnect Switch.

3. After making your changes, highlight **APPLY** and press the **Enter** key.

**NOTE:** To save the configuration settings permanently, you must enter them into NVRAM using the **Save Changes** option on the main menu. Refer to the “Saving Changes” section earlier in this chapter.

### Configuring Port Spanning Tree Settings

In addition to setting Spanning Tree parameters for use on the GbE Interconnect Switch level, the GbE Interconnect Switch allows for the configuration of STP on individual ports.

To define individual ports:

1. Highlight **Port Settings** on the **Configure Spanning Tree** menu.
2. Press the **Enter** key. The following screen is displayed.

```

Port Spanning Tree Settings
-----
View Ports:<1 to 12 >      Configure Port from[1 ] to[1 ]
STP Status:<Enabled > Port Cost:[100 ] Priority:[128] ByPass:<No >  APPLY
-----
Port#      Connection      STP Status      Cost      Priority      ByPass      Port State
-----
 1      100M/Full/None      Enabled      100      128      No      Forwarding
 2      -      Enabled      100      128      No      Disabled
 3      -      Enabled      100      128      No      Disabled
 4      -      Enabled      100      128      No      Disabled
 5      -      Enabled      100      128      No      Disabled
 6      -      Enabled      100      128      No      Disabled
 7      -      Enabled      100      128      No      Disabled
 8      -      Enabled      100      128      No      Disabled
 9      -      Enabled      100      128      No      Disabled
10      -      Enabled      100      128      No      Disabled
11      -      Enabled      100      128      No      Disabled
12      -      Enabled      100      128      No      Disabled
-----
*****
Function:Select the scope of ports for display and configuration.
Message:
CTRL+T = Root screen      Esc=Prev. screen      CTRL+R = Refresh
    
```

3. Toggle the **View Ports** field to the range of ports to be configured. The Fast Ethernet ports displayed for configuration in groups of 12 and the optional 100Base-TX ports are displayed together if a 2-port rather than a 1-port extension module is installed.
4. Type the port number or port range in the **Configure Port** field.
5. Toggle the **STP Status** field to **Enabled** or **Disabled**.
6. Type the Spanning Tree port cost in the **Port Cost** field.

7. Type the Spanning Tree priority in the **Priority** field.
8. Toggle the **ByPass** field to **Yes** to enable the GbE Interconnect Switch to skip the usual waiting time associated with the listening state. (This is also known as fast forward.)
9. Highlight **APPLY** and press the **Enter** key.

**NOTE:** To save the configuration settings permanently, you must enter them into NVRAM using the **Save Changes** option on the main menu. Refer to the “Saving Changes” section earlier in this chapter.

## Configuring the Static (Destination-Address Filtering) Table

To configure the Static (Destination-Address Filtering) Table:

1. Highlight **Configure Static (Destination-Address Filtering) Table** on the **Configuration** menu.
2. Press the **Enter** key. The following menu is displayed.

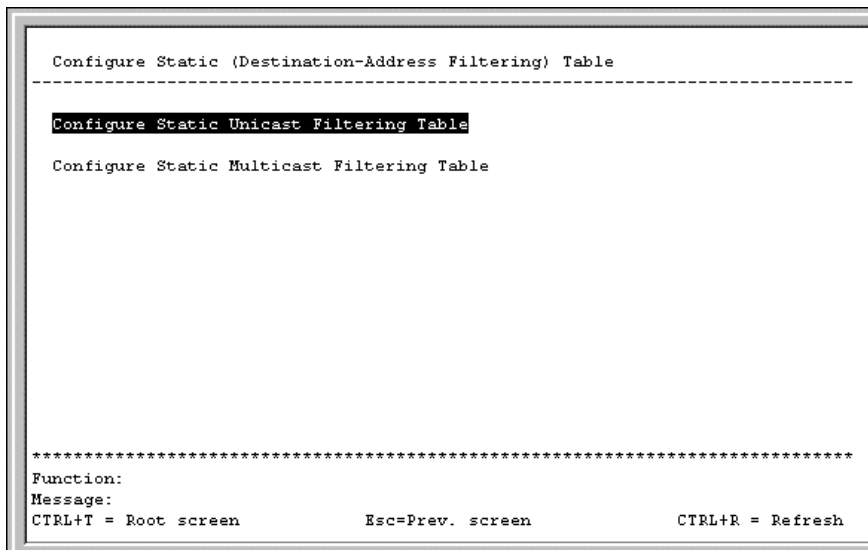

```
Configure Static (Destination-Address Filtering) Table
-----
Configure Static Unicast Filtering Table
Configure Static Multicast Filtering Table

*****
Function:
Message:
CTRL+T = Root screen      Esc=Prev. screen      CTRL+R = Refresh
```

The **Configure Static (Destination-Address Filtering) Table** menu allows you to access screens to create, modify, and delete both the Static Unicast Filtering Table and the Static Multicast Filtering Table.

## Configuring Static Unicast Filtering Table

To configure the Static Unicast Table:

1. Highlight **Configure Static Unicast Table** on the **Configure Static (Destination-Address Filtering) Table** menu.
2. Press the **Enter** key. The following screen is displayed.

```

Setup Unicast Filtering Table
-----
Action: <Add/Modify>
VLAN ID: [1 ]          MAC Address: [000000000000]
Type: <Permanent     >      Allow to Go Port: [1 ]
Total Entries: 0                                     APPLY
-----
MAC Address   VID   Port   Type
-----
*****
Function: Select the action- ADD/MODIFY or DELETE.
Message:
Esc= Previous screen  CTRL+R= Refresh  CTRL+N= Next Page  CTRL+P=Previous Page
    
```

3. Toggle the **Action** field between **Add/Modify** and **Delete**.
4. Type the VID in the **VLAN ID** field.
5. Type the MAC address to be statically entered in the forwarding table in the **MAC Address** field.
6. Toggle the **Type** field to **Permanent** or **DeleteOnReset**, to set the unicast filter type.
7. Type the port number in the **Allow to Go Port** field.
8. Highlight **APPLY** and press the **Enter** key.

**NOTE:** To save the configuration settings permanently, you must enter them into NVRAM using the **Save Changes** option on the main menu. Refer to the “Saving Changes” section earlier in this chapter.

## Configuring Static Multicast Filtering Table

To edit the IEEE 802.1q Multicast Filtering settings:

1. Highlight **Configure Static Multicast Filtering Table** on the **Configure Static (Destination-Address Filtering) Table**.
2. Press the **Enter** key. The following screen is displayed.

```

Setup Static Multicast Filtering Table
-----
Action: <Add/Modify>      VLAN ID: [1 ]
Multicast MAC Address: [000000000000]
Egress 1 to 8 9 to 16 17 to 24
(E/-) [-----][-----][-----]
Type: <Permanent      >                               Total Entries: 0      APPLY
-----
MAC Address      VID      1 to 8 9 to 16 17 to 24      Type
-----
*****
Function: Select the action- ADD/MODIFY or DELETE.
Message:
Esc= Previous screen  CTRL+R= Refresh  CTRL+N= Next Page  CTRL+P=Previous Page
    
```

3. Toggle the **Action** field to **Add/Modify**.
4. Type the VID number of the VLAN that will be receiving the multicast packets in the **VLAN ID** field.
5. Type the MAC address of the multicast source in the **Multicast MAC Address** field.
6. Set the multicast group membership of each port by highlighting (E/-) field using the arrow keys, and then toggling between **E**, **F**, or a dash (—) using the spacebar.
  - **E** (Egress Member)—Specifies that the port is a static member of the multicast group. Egress Member Ports transmit traffic for the multicast group.
  - **F** (Forbidden Nonmember)—Specifies that the port is not a member of the multicast group and that the port is forbidden from becoming a member of the multicast group dynamically.
  - — (Nonmember)—Specifies that the port is not a member of the multicast group, but the port can become a member of the multicast group dynamically.
7. Toggle the **Type** field to the static multicast filter type **Permanent** or **DeleteOnReset**.
8. Highlight **APPLY** and press the **Enter** key.

**NOTE:** To save the configuration settings permanently, you must enter them into NVRAM using the **Save Changes** option on the main menu. Refer to the “Saving Changes” section earlier in this chapter.

## Configuring VLANs

The GbE Interconnect Switch reserves one VLAN, VID 1, also called the DEFAULT\_VLAN, for internal use. The factory default setting assigns all ports on the GbE Interconnect Switch to the DEFAULT\_VLAN. As new VLANs are configured, their respective member ports are removed from the DEFAULT\_VLAN. If the DEFAULT\_VLAN is reconfigured, all ports are again assigned to it. Ports that are not wanted as part of the DEFAULT\_VLAN are removed during the configuration.

Packets cannot cross VLANs. If a member of one VLAN wants to connect to another VLAN, it must be through a router.

**NOTE:** The DEFAULT\_VLAN has a VID equal to 1. An IP interface called System in the IP interface entry menu also has a VID value of 1, and therefore corresponds to the DEFAULT\_VLAN.

To edit VLAN definitions and to configure port settings for IEEE 802.1Q VLAN support:

1. Highlight **Configure VLANs** on the **Configuration** menu.
2. Press the **Enter** key. The following menu is displayed.

```
IEEE 802.1Q VLANs Configuration
-----
Configure Static VLAN Entry
Configure Port VLAN ID
Configure Port Ingress Filter
Configure Port GVRP Settings

*****
Function:
Message:
CTRL+T = Root screen      Esc=Prev. screen      CTRL+R = Refresh
```

## Configuring Static VLAN Entry

To create an 802.1Q VLAN:

1. Highlight **Configure Static VLAN Entry** on the **IEEE 802.1Q VLANs Configuration** menu.
2. Press the **Enter** key. The following screen is displayed.

```

802.1Q Static VLAN Settings
-----
VID: [E]          VLAN Name: [          ]      Entries: 1
      1           8 9           16 17       24
Egress/Forbidden: [-----] [-----] [-----]
Tag/Untag         : [UUUUUUUU] [UUUUUUUU] [UUUUUUUU]
State             : <Active >   APPLY
-----

VID   VLAN Name           Port List-Egress/Forbidden,Tag/Untag
1     DEFAULT_VLAN       EEEEEEE EEEEEEE EEEEEEE
                        UUUUUUUU  UUUUUUUU  UUUUUUUU

*****
Function: Enter VID (1-4094):
Message:
Esc= Previous screen  CTRL+R= Refresh  CTRL+N= Next Page  CTRL+P=Previous Page
    
```

3. Type a VLAN ID number in the **VID** field.
4. Type a name for the new VLAN in the **VLAN Name** field.
5. Set the 802.1Q VLAN membership for each port by highlighting the **Egress/Forbidden** field using the arrow keys, and then toggling between **E**, **F**, and the dash (—) using the spacebar.
  - **E** (Egress Member)—Specifies the port as being a static member of the VLAN. Egress Member Ports are ports that will be transmitting traffic for the VLAN. These ports can be either tagged or untagged.
  - **F** (Forbidden Nonmember)—Defines the port as not being a member and also forbids the port from joining a VLAN dynamically.
  - — (Nonmember)—Specifies the port as not being a member of the VLAN, but the port can become a member of the VLAN dynamically.

6. Set the state of each port by highlighting the **Tag/Untag** field using the arrow keys and then toggling between **U** and **T** using the spacebar.
  - **U**—Specifies the port as an untagged member of the VLAN. When the port transmits an untagged packet, the packet header remains unchanged. When a tagged packet exits the port, the tag is stripped and the packet is changed to an untagged packet.
  - **T**—Specifies the port as a tagged member of the VLAN. When the port transmits an untagged packet, the packet header is changed to include the 32-bit tag associated with the PVID (Port VLAN Identifier). When a tagged packet exits the port, the packet header is unchanged.
7. Toggle the **State** field between **Active** and **Inactive**.
8. Highlight **APPLY** and press the **Enter** key.

**NOTE:** If the port is attached to a device that is not IEEE 802.1Q VLAN compliant (VLAN-tag unaware), then set the port to U (Untagged). If the port is attached to a device that is IEEE 802.1Q VLAN compliant (VLAN-tag aware), then set the port to T (Tagged).

### Configuring a Port VLAN

To assign a port a PVID:

1. Highlight **Configure Port VLAN ID** on the **IEEE 802.1Q VLANs Configuration** menu.
2. Press the **Enter** key. The following screen is displayed.

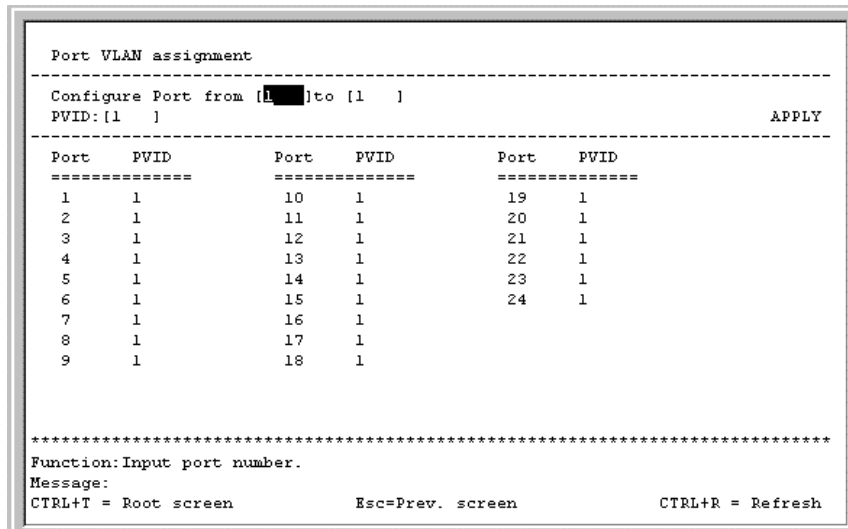

3. Type the range of port numbers you want to configure in the **Configure Port** field.

4. Type the PVID for the VLAN member ports you want to configure in the **PVID** field.  
 PVID is a classification mechanism that associates a port with a specific VLAN and is used to make forwarding decisions for untagged packets received by the port. For example, if Port 2 is assigned a PVID of 3, then all untagged packets received on Port 2 will be assigned to VLAN 3. This number is generally the same as the VID number assigned to the port in the **802.1Q Static VLAN Settings** screen.
5. Highlight **APPLY** and press the **Enter** key.

**NOTE:** To save the configuration settings permanently, you must enter them into NVRAM using the **Save Changes** option on the main menu. Refer to the “Saving Changes” section earlier in this chapter.

### Configuring Port Ingress Filtering

To set ingress filtering on a port:

1. Highlight **Configure Port Ingress Filter** on the **IEEE 802.1Q VLANs Configuration** menu.
2. Press the **Enter** key. The following screen is displayed.

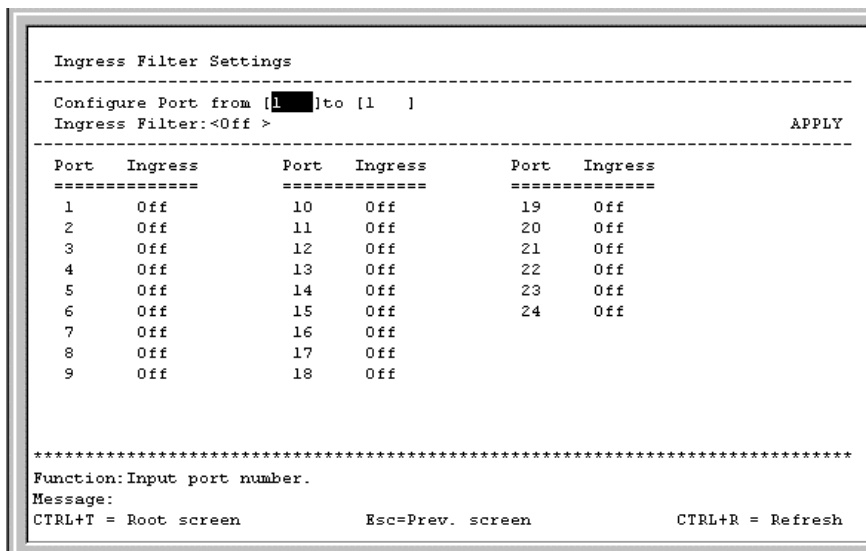

3. Type the range of port numbers you want to configure in the **Configure Port** fields.
4. Toggle between **On** and **Off** in the **Ingress Filter** field.  
 An ingress filter enables the port to compare the VID tag of an incoming packet with the PVID number assigned to the port. If the two are different, the port filters (drops) the packet.
5. Highlight **APPLY** and press the **Enter** key.

**NOTE:** To save the configuration settings permanently, you must enter them into NVRAM using the **Save Changes** option on the main menu. Refer to the “Saving Changes” section earlier in this chapter.



## Configuring Port GVRP Settings

GARP VLAN Registration Protocol (GVRP) is a Generic Attribute Registration Protocol (GARP) application that provides 802.1Q-compliant VLAN pruning and dynamic VLAN creation on 802.1Q trunk ports. With GVRP, the GbE Interconnect Switch can exchange VLAN configuration information with other GVRP switches, prune unnecessary broadcast and unknown unicast traffic, and dynamically create and manage VLANs on switches connected through 802.1Q trunk ports.

GVRP updates dynamic VLAN registration entries and communicates the new VLAN information across the network. This feature allows stations to physically move to other GbE Interconnect Switch ports and keep their original VLAN settings, without having to reconfigure.

To enable a port to dynamically become a member of a VLAN:

1. Highlight **Configure Port GVRP Settings** on the **IEEE 802.1Q VLANs Configuration** menu.
2. Press the **Enter** key. The following screen is displayed.

```

Port GVRP Settings
-----
Configure Port from [1 ] to [1 ]
GVRP State:<Off >                                APPLY
-----
Port    GVRP      Port    GVRP      Port    GVRP
-----
 1     Off       10     Off       19     Off
 2     Off       11     Off       20     Off
 3     Off       12     Off       21     Off
 4     Off       13     Off       22     Off
 5     Off       14     Off       23     Off
 6     Off       15     Off       24     Off
 7     Off       16     Off
 8     Off       17     Off
 9     Off       18     Off

*****
Function:Input port number.
Message:
CTRL+T = Root screen      Esc=Prev. screen      CTRL+R = Refresh
    
```

The **Port GVRP Settings** screen allows you to enable or disable the GARP VLAN Registration Protocol.

3. Type the range of ports to be configured in the **Configure Port** fields.
4. Toggle the **GVRP State** to **On**.
5. Highlight **APPLY** and press the **Enter** key.

**NOTE:** To save the configuration settings permanently, you must enter them into NVRAM using the **Save Changes** option on the main menu. Refer to the “Saving Changes” section earlier in this chapter.

## Configuring IGMP Snooping

Internet Group Management Protocol (IGMP) Snooping allows the GbE Interconnect Switch to recognize IGMP queries and reports sent between network stations or devices and an IGMP host. When enabled for IGMP Snooping, the GbE Interconnect Switch can open or close a port to a specific device based on IGMP messages passing through the GbE Interconnect Switch.

To configure IGMP Snooping:

1. Highlight **Configure IGMP Snooping** on the **Configuration** menu.
2. Press the **Enter** key. The following screen is displayed.

```

IGMP Snooping Settings
-----
Switch IGMP Snooping: Disabled
*Notes: If you want to change it, back to Configure Switch.
Action: <Add/Modify>
VLAN ID: [1 ]          State: <Enabled >      Querier State: <Non-Querier>
Robustness Variable: [2 ] Query Interval: [125 ] Max Response: [10]  APPLY
-----
  VID   State   Age Out  Querier State
-----
  1     Enabled  260     Non-Querier

Age Out = Robustness Variable * Query Interval + Max Response
*****
Function: Select the action- ADD/MODIFY or DELETE.
Message:
Esc= Previous screen  CTRL+R= Refresh  CTRL+N= Next Page  CTRL+P=Previous Page
    
```

The **IGMP Snooping Settings** screen allows you to set the following:

- **Switch IGMP Snooping**—Toggle using the spacebar between **Disabled** and **Enabled**. This setting is used to enable or disable IGMP Snooping globally on the GbE Interconnect Switch.
- **Action**—Toggle to the option you want, **Add/Modify** or **Delete**.
- **Querier State**—Toggle between **Non-Querier**, **V1-Querier**, and **V2-Querier**. This setting is used to specify the IGMP version (1 or 2) that is used by the IGMP interface when making queries.
- **Robustness Variable**—Enter a value between 2 and 255, with larger values being specified for subnetworks that are expected to lose larger numbers of packets. This option is a tuning variable to allow for subnetworks that are expected to lose a large number of packets.

- **Query Interval**—Enter a value between 1 and 65,500 seconds, with a default of 125 seconds. This setting specifies the length of time between sending IGMP queries.
  - **Max Response**—Set the maximum amount of time allowed before sending an IGMP response report. A value between 1 and 25 seconds can be entered; the default is 10 seconds.
3. After making your changes, highlight **APPLY**, then press the **Enter** key.

**NOTE:** To save the configuration settings permanently, you must enter them into NVRAM using the **Save Changes** option on the main menu. Refer to the “Saving Changes” section earlier in this chapter.

## Configuring Port Trunking

Port trunking allows several ports to be grouped together to act as a single link. This setting provides a bandwidth that is a multiple of a single link bandwidth. Port trunking is most commonly used to link a bandwidth-intensive network device or devices, such as a server, to the backbone of a network.

The GbE Interconnect Switch allows the creation of up to six port trunking groups, each group consisting of up to eight links (ports). The trunked ports must be contiguous (they must have sequential port numbers). All of the ports in the group must be members of the same VLAN. Further, the trunked ports must all be of the same speed and should be configured as full-duplex.

The configuration of the lowest numbered port in the group becomes the configuration for all of the ports in the aggregation group. This port is called the Master Port of the group, and all configuration options, including the VLAN configuration, that can be applied to the Master Port are applied to the entire port trunking group.

Load balancing is automatically applied to the ports in the trunked group, and a link failure within the group causes the network traffic to be directed to the remaining links in the group.

The Spanning Tree Protocol treats a port trunking group as a single link on the GbE Interconnect Switch level. On the port level, the STP uses the port parameters of the Master Port in the calculation of port cost and in determining the state of the port trunking group. If two redundant port trunking groups are configured on the GbE Interconnect Switch, STP blocks one entire group, in the same way STP blocks a single port that has a redundant link.

To configure a port trunking group:

1. Highlight **Configure Port Trunking** on the **Configuration** menu.
2. Press the **Enter** key. The following screen is displayed.

```

Port Trunking Settings
-----
Group ID: [1]
Group Name: [XConnect]
           1
           1 to 8 9 to 16 17 to 24
Member ports: [-----] [-----] [MM-----]
State: <Enabled >                                APPLY
-----
ID   Group Name   1 to 8  9 to 16  17 to 24  State
-----
 1   XConnect    -----  -----  MM-----  Enabled
 2                                     -----  Disabled
 3                                     -----  Disabled
 4                                     -----  Disabled
 5                                     -----  Disabled
 6                                     -----  Disabled

*****
Function: Enter group ID.
Message:
CTRL+T = Root screen          Esc=Prev. screen          CTRL+R = Refresh
    
```

The **Port Trunking Settings** screen allows you to set the following:

- **Group ID**—Enter a group ID number for the port trunking group.
- **Group Name**—Enter a name for the port trunking group.
- **Member ports**—Toggle between **M** to indicate membership of the port trunking group, or a dash (—) to indicate nonmembership.
- **State**—Toggle between **Enabled** and **Disabled**. This setting is used to turn a port trunking group on or off. It is useful for diagnostics, to quickly isolate a bandwidth intensive network device, or to have an absolute backup aggregation group that is not under automatic control.

3. After making your changes, highlight **APPLY**, then press the **Enter** key.

**NOTE:** To save the configuration settings permanently, you must enter them into NVRAM using the **Save Changes** option on the main menu. Refer to the “Saving Changes” section earlier in this chapter.

## Configuring Port Mirroring

The GbE Interconnect Switch allows you to copy frames transmitted and received on a port and redirect the copies to another port. You can attach a monitoring device to the mirrored port, such as a sniffer or an RMON probe, to view details about the packets passing through the first port. This setting is useful for network monitoring and troubleshooting purposes.

**NOTE:** You cannot mirror a fast port onto a slower port. For example, if you try to mirror the traffic from a 100-Mb/s port onto a 10-Mb/s port, you can cause throughput problems. The port from which you are copying frames must support an equal or lower speed than the port to which you are sending the copies. Also, the target port cannot be a member of a trunk group.

To configure port mirroring:

1. Highlight **Configure Port Mirroring** on the **Configuration** menu.
2. Press the **Enter** key. The following screen is displayed.

```

Setup Port Mirroring
-----
This feature allows you to mirror a port to another port for network
monitoring and troubleshooting purposes.
The target port must always be a regular non-trunked port.

Source Port:<1 >
Source Direction:<Ingress & Egress>
Target Port:<11 >
Mirror Status:<Disabled>

      APPLY

*****
Function:
Message:
CTRL+T = Root screen      Esc=Prev. screen      CTRL+R = Refresh

```

3. In the **Source Port** field, toggle to the number of the port from which you want to copy frames.
4. In the **Source Direction** field, toggle to the desired direction.
5. In the **Target Port** field, toggle to the port that receives the copies from the source port. The target port is where you connect a monitoring or troubleshooting device such as a sniffer or an RMON probe.
6. Toggle the **Mirror Status** field to **Enabled**.
7. Highlight **APPLY** and press the **Enter** key.

**NOTE:** To save the configuration settings permanently, you must enter them into NVRAM using the **Save Changes** option on the main menu. Refer to the “Saving Changes” section earlier in this chapter.

## Configuring the Threshold of Broadcast/Multicast/DA-Unknown Storm

To configure the threshold of a broadcast, multicast, or DA-Unknown Storm:

1. Highlight **Configure Threshold of Broadcast/Multicast/DA-Unknown Storm** on the **Configuration** menu.
2. Press the **Enter** key. The following screen is displayed.

```
Setup Threshold of Broadcast/Multicast/DA-Unknown Storm
-----
Monitoring Broadcast Storm:<Disabled>
      Multicast Storm:<Disabled>
      DA-Unknown Storm:<Disabled>
      Threshold(Pkts/sec): [500  ]

                        APPLY

*****
Function: Enable/Disable Broadcast Storm monitoring.
Message:
CTRL+T = Root screen          Esc=Prev. screen          CTRL+R = Refresh
```

3. Toggle the desired storm option to **Enabled**. Leave the other two options **Disabled**.
4. Type a threshold in the **Threshold (Pkts/sec)** field.
5. Highlight **APPLY** and press the **Enter** key.

**NOTE:** To save the configuration settings permanently, you must enter them into NVRAM using the **Save Changes** option on the main menu. Refer to the “Saving Changes” section earlier in this chapter.

## Configuring Class of Service, Default Priority, and Traffic Class

To configure Class of Service, default priority, and traffic class:

1. Highlight **Configure Class of Service, Default Priority and Traffic Class** on the **Configuration** menu.
2. Press the **Enter** key. The following menu is displayed.

```
Configure Class of Service, Default Priority and Traffic Class
-----
Configure Class of Service
Configure Default Priority
Configure Traffic of Class

*****
Function:
Message:
CTRL+T = Root screen      Esc=Prev. screen      CTRL+R = Refresh
```

## Configuring Class of Service

To configure Class of Service:

1. Highlight **Configure Class of Service** on the **Configure Class of Service, Default Priority and Traffic Class** menu.
2. Press the **Enter** key. The following screen is displayed.

```

Class of Service Configuration
-----
          Max. Packets  Max. Latency
          -----
Class-0  [10 ]         [10 ]
Class-1  [10 ]         [10 ]
Class-2  [10 ]         [10 ]
Class-3  [10 ]         [10 ]

          APPLY

*****
Function: Input maximum packet count for a CoS Queue. (takes effect at roundRobin
mode)ge:
CTRL+T = Root screen           Esc=Prev. screen           CTRL+R = Refresh
    
```

The **Class of Service Configuration** screen allows you to set the following features:

- **Max. Packets**—The Class of Service scheduling algorithm starts from the highest CoS for a given port, sends the maximum number of packets, then moves on to the next lower CoS. Values from 0 to 255 can be entered in this field. Entering zero instructs the GbE Interconnect Switch to continue processing packets until there are no more packets in the CoS transaction queue.
- **Max. Latency**—The maximum latency is the maximum allowable time a packet stays in the CoS queue. The packets in this queue are not delayed more than the amount entered in this field. The timer is disabled when this field is set to zero. Each unit of this timer is equal to 16 microseconds.

3. After making your changes, highlight **APPLY**, then press the **Enter** key.

**NOTE:** To save the configuration settings permanently, you must enter them into NVRAM using the **Save Changes** option on the main menu. Refer to the “Saving Changes” section earlier in this chapter.



## Assigning Port Default Priority

To assign port default priority:

1. Highlight **Configure Default Priority** on the **Configure Class of Service, Default Priority and Traffic Class** menu.
2. Press the **Enter** key. The following screen is displayed.

```

Default Port Priority Assignment
-----
Configure Port from [1 ]to [1 ]
Default Priority: [0]                                     APPLY
-----
Port  Priority      Port  Priority      Port  Priority
-----
 1      0             10     0             19     0
 2      0             11     0             20     0
 3      0             12     0             21     0
 4      0             13     0             22     0
 5      0             14     0             23     0
 6      0             15     0             24     0
 7      0             16     0
 8      0             17     0
 9      0             18     0

*****
Function:Input port number.
Message:
CTRL+T = Root screen          Esc=Prev. screen          CTRL+R = Refresh
    
```

3. Type the port range in **Configure Port** fields.
4. Highlight **APPLY** and press the **Enter** key.

**NOTE:** To save the configuration settings permanently, you must enter them into NVRAM using the **Save Changes** option on the main menu. Refer to the “Saving Changes” section earlier in this chapter.

## Configuring Class of Traffic

To configure traffic class:

1. Highlight **Configure Traffic of Class** on the **Configure Class of Service, Default Priority and Traffic Class** menu.
2. Press the **Enter** key. The following screen is displayed.

```
Class of Traffic Configuration
-----
Priority-0 --> <Class-0>
Priority-1 --> <Class-0>
Priority-2 --> <Class-1>
Priority-3 --> <Class-1>
Priority-4 --> <Class-2>
Priority-5 --> <Class-2>
Priority-6 --> <Class-3>
Priority-7 --> <Class-3>

      APPLY

*****
Function:Select the traffic class for this priority.
Message:
CTRL+T = Root screen      Esc=Prev. screen      CTRL+R = Refresh
```

3. Toggle the **Priority** fields to set the traffic class for the eight levels of priority for the GbE Interconnect Switch. Class values are from 0 to 3.
4. Highlight **APPLY** and press the **Enter** key.

**NOTE:** To save the configuration settings permanently, you must enter them into NVRAM using the **Save Changes** option on the main menu. Refer to the “Saving Changes” section earlier in this chapter.

## Configuring Port Security

To configure security for a specified port or range of ports on the GbE Interconnect Switch:

1. Highlight **Configure Port Security** on the **Configuration** menu.
2. Press the **Enter** key. The following screen is displayed.

```

Port Security Settings
-----
View Ports: <1 to 12 >      Configure Port from [1 ] to [1 ]
Admin State: <Disabled>    Max. Addr. [1   ] Mode <DeleteOnReset >      APPLY
-----
Port#  Admin State  Max. Learning Addr.  Lock Address Mode
-----
  1    Disabled      1                    DeleteOnReset
  2    Disabled      1                    DeleteOnReset
  3    Disabled      1                    DeleteOnReset
  4    Disabled      1                    DeleteOnReset
  5    Disabled      1                    DeleteOnReset
  6    Disabled      1                    DeleteOnReset
  7    Disabled      1                    DeleteOnReset
  8    Disabled      1                    DeleteOnReset
  9    Disabled      1                    DeleteOnReset
 10    Disabled      1                    DeleteOnReset
 11    Disabled      1                    DeleteOnReset
 12    Disabled      1                    DeleteOnReset
*****
Function: Select the scope of ports for display and configuration.
Message:
CTRL+T = Root screen          Esc=Prev. screen          CTRL+R = Refresh
    
```

3. Toggle the **View Ports** field to the range that you want.
4. Type the range of ports in the **Configure Port** fields.
5. Toggle the **Admin State** field to **Enabled**.
6. Type the maximum number of addresses in the **Max. Addr.** field.
7. Toggle to the mode that you want in the **Mode** field.
8. Highlight **APPLY** and press the **Enter** key.

**NOTE:** To save the configuration settings permanently, you must enter them into NVRAM using the **Save Changes** option on the main menu. Refer to the “Saving Changes” section earlier in this chapter.

## Configuring Priority MAC Addresses

To configure a priority MAC address for a specified port or range of ports on the GbE Interconnect Switch:

1. Highlight **Configure Priority MAC Addresses** on the **Configuration** menu.
2. Press the **Enter** key. The following screen is displayed.

```

Setup Priority MAC Addresses
-----
Action: <Add/Modify>      VLAN ID: [1  ]      MAC Address: [000000000000]
Priority Level: [0]        Look at: <Src.  >                APPLY
-----
VID  MAC Address  Priority  Look at  Total Entries: 0
-----
*****
Function: Select the action- ADD/MODIFY or DELETE.
Message:
Esc= Previous screen  CTRL+R= Refresh  CTRL+N= Next Page  CTRL+P=Previous Page
    
```

The **Setup Priority MAC Address** window allows you to set up the priority MAC address for each VLAN ID.

To set the priority level for a MAC address:

1. Toggle to **Add** in the **Action** field.
2. Type the VLAN ID in the **VLAN ID** field.
3. Type the MAC address for which priority on the GbE Interconnect Switch is to be established in the **MAC Address** field.
4. Type the priority level for the MAC address in the **Priority Level** field. The range is from 0 to 7, with 0 being the highest priority.
5. Select the state under which the above priority will be active in the **Look at** field. The options are:
  - **Dst.Addr**—Packets with the selected MAC address as their destination will be given the selected priority.

- **Src.Addr**—Packets with the selected MAC address as their source will be given the selected priority.
- **Either**—All packets with the selected MAC address will be given the selected priority.

6. Highlight **APPLY** and press the **Enter** key.

**NOTE:** To save the configuration settings permanently, you must enter them into non-volatile RAM (NVRAM) using the **Save Changes** option on the main menu. Refer to the “Saving Changes” section earlier in this chapter.

## Configuring RS232 and SLIP

To configure RS232 and Serial Line Internet Protocol (SLIP):

1. Highlight **Configure RS232 and SLIP** on the **Configuration** menu.
2. Press the **Enter** key. The following screen is displayed.

```

Serial Port and SLIP Settings
-----
Serial Port Setting:          SLIP Settings:
Baud Rate: <9600 >          Local IP Address:  0.0.0.0
Data Bits: <8 >              Remote IP Address: 0.0.0.0
Parity   : <None >           MTU: 1006
Stop Bits: <1 >
Auto-Logout: <Never >
Serial Port For: <Console >

                                           APPLY

*****
Function: Select baud rate.
Message:
CTRL+T = Root screen      Esc=Prev. screen      CTRL+R = Refresh
    
```

The **Serial Port and SLIP Settings** window allows you to configure the GbE Interconnect Switch serial port through either the console port or through use of the Telnet protocol.

You can set the following features:

- **Baud Rate**—Specifies the rate at which data will be exchanged over the serial link. The default value is 9600 baud.
- **Data Bits**—Specifies the number of bits that will carry data over the serial link. The default value is 8 bits.
- **Stop Bits**—Specifies the number of bits that indicate when a serial word ends. The default value is 1 bit.

- **Auto-Logout**—Specifies length of time a management session can be idle. When this time has expired, the GbE Interconnect Switch management agent will disconnect the user. The default value is 10 minutes.
  - **Serial Port For**—Select Console or SLIP.
  - **Local IP Address**—Local IP address of the SLIP connection.
  - **Remote IP Address**—Remote IP address of the SLIP connection.
  - **MTU**—Maximum transfer unit (MTU) specifies the size of the transferring IP packets. The default value is 1006.
3. After making your changes, highlight **APPLY** then press the **Enter** key.

**NOTE:** To save the configuration settings permanently, you must enter them into NVRAM using the **Save Changes** option on the main menu. Refer to the “Saving Changes” section earlier in this chapter.

## Monitoring GbE Interconnect Switch Functions

The GbE Interconnect Switch provides extensive network monitoring capabilities.

To display the network data compiled by the GbE Interconnect Switch:

1. Highlight **Network Monitoring** on the main menu.
2. Press the **Enter** key. The following menu is displayed.

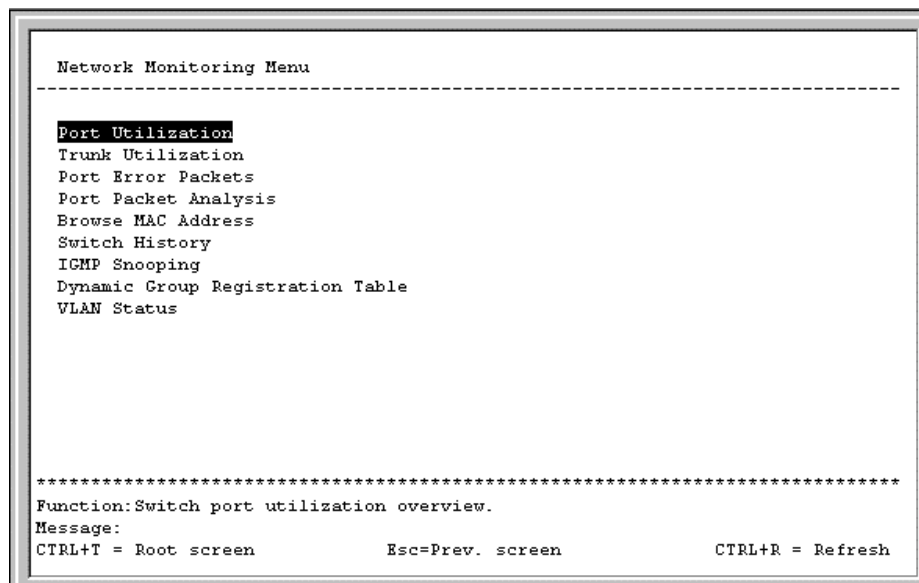

```
Network Monitoring Menu
-----
Port Utilization
Trunk Utilization
Port Error Packets
Port Packet Analysis
Browse MAC Address
Switch History
IGMP Snooping
Dynamic Group Registration Table
VLAN Status

*****
Function:Switch port utilization overview.
Message:
CTRL+T = Root screen          Esc=Prev. screen          CTRL+R = Refresh
```

## Monitoring Port Utilization

To view the port utilization of all the ports on the GbE Interconnect Switch:

1. Highlight **Port Utilization** on the **Network Monitoring Menu**.
2. Press the **Enter** key. The following screen is displayed.

```

Port Utilization
-----
                                CLEAR COUNTER                               Interval:< 2 sec >
-----
Port      TX/sec    RX/sec  %Util.   Port      TX/sec    RX/sec  %Util.
-----
 1         0         22      1        14        0         0        0
 2         0         0        0        15        0         0        0
 3         0         0        0        16        0         0        0
 4         0         0        0        17        0         0        0
 5         0         0        0        18        0         0        0
 6         0         0        0        19        0         0        0
 7         0         0        0        20        0         0        0
 8         0         0        0        21        0         0        0
 9         0         0        0        22        0         0        0
10         0         0        0        23        0         0        0
11         0         0        0        24        0         0        0
12         0         0        0
13         0         0        0
*****
Function:Clear counter.
Message:
CTRL+T = Root screen          Esc=Prev. screen          CTRL+R = Refresh
    
```

The **Port Utilization** screen shows the number of packets transmitted and received per second and calculates the percentage of the total available bandwidth being used on the port (displayed under **%Util.**).

3. To reset the counters, highlight **CLEAR COUNTER** and press the **Enter** key.

## Monitoring Trunk Utilization

To view the trunk utilization of all the ports on the GbE Interconnect Switch:

1. Highlight **Trunk Utilization** on the **Network Monitoring Menu**.
2. Press the **Enter** key. The following screen is displayed.

```

Trunk Utilization
-----
                                CLEAR COUNTER                               Interval:< 2 sec >
ID Group Name      Member Ports      State      TX      RX      TX&RX
                  %utl      %utl      %utl
-----
1  XConnect        17,18          Enabled    0       0       0
2                               Disabled  N/A     N/A     N/A
3                               Disabled  N/A     N/A     N/A
4                               Disabled  N/A     N/A     N/A
5                               Disabled  N/A     N/A     N/A
6                               Disabled  N/A     N/A     N/A

*****
Function:Clear counter.
Message:
CTRL+T = Root screen      Esc=Prev. screen      CTRL+R = Refresh
    
```

The **Trunk Utilization** window allows you to view three items for an individual port trunking group: the percentage of total available bandwidth being used by the group, the percentage of packets transmitted, and the percentage of packets being received per second.

3. To reset the counters, highlight **CLEAR COUNTER** and press the **Enter** key.



## Monitoring Port Error Packets

To view the error statistics for a port:

1. Highlight **Port Error Packets** on the **Network Monitoring Menu**.
2. Press the **Enter** key. The following screen is displayed.

```

Packet Error Statistic
-----
Port: <1 >          CLEAR COUNTER      Interval: < 2 sec >

          RX Frames                      TX Frames
          -----                      -----
CRC Error          0                      ExDefer          0
Undersize          0
Oversize           0                      Late Coll.       0
Fragment          0                      Ex. Coll.       0
Jabber            0                      Single Coll.    0
Drop Pkts        2442                      Coll.           0

*****
Function: Select port number.
Message:
CTRL+T = Root screen      Esc=Prev. screen      CTRL+R = Refresh
    
```

3. Toggle the **Port** field to the number of the port to be viewed.
4. Toggle the **Interval** field from 2 seconds to 1 minute, or select **Suspend** to set the interval at which the error statistics are updated.
5. Highlight **CLEAR COUNTER** and press the **Enter** key to reset the counters.

## Monitoring Port Packet Analysis

To view an analysis of the size of packets received or transmitted by a port:

1. Highlight **Port Packet Analysis** on the **Network Monitoring Menu**.
2. Press the **Enter** key. The following screen is displayed.

```

Packet Analysis
-----
Port: <1> CLEAR COUNTER Interval: < 2 sec >

      Frames  Frames/sec      Total  Total/sec
-----
64          5625         19      RX Bytes 3088391  4603
65-127      4939          4      RX Frames 14461    25
128-255     2066          0
256-511     695           0      TX Bytes  632     0
512-1023    175           0      TX Frames  8      0
1024-1518   969           2

Unicast RX  994           0
Multicast RX 2646          2
Broadcast RX 10821         23

*****
Function: Select port number.
Message:
CTRL+T = Root screen      Esc=Prev. screen      CTRL+R = Refresh
    
```

In addition to the size of packets received or transmitted by the selected port, statistics on the number of unicast, multicast, and broadcast packets are displayed.

3. To reset the counters, highlight **CLEAR COUNTER** and press the **Enter** key.

## Monitoring MAC Address Forwarding Table

To view the MAC address forwarding table:

1. Highlight **Browse MAC Address** on the **Network Monitoring Menu**.
2. Press the **Enter** key. The following screen is displayed.

```

Browse Address Table
-----
Browse By: <ALL ██████████> VLAN ID: [1 ] Total Addresses in Table: 192
MAC Address: [000000000000] BROWSE CLEAR ALL
-----
VID  MAC Address  Port  Status      VID  MAC Address  Port  Status
-----
1    0000819AF2F4  1     Dynamic     1    0020482D0A55  1     Dynamic
1    000102030400  1     Dynamic     1    0020485A70A2  1     Dynamic
1    000130FA5F00  1     Dynamic     1    00224488779B  1     Dynamic
1    0001969C0600  1     Dynamic     1    003326081100  1     Dynamic
1    00055DF93287  CPU   Self        1    004005254874  1     Dynamic
1    00055DF93616  1     Dynamic     1    0040052EAEDC  1     Dynamic
1    001002123457  1     Dynamic     1    004005400C85  1     Dynamic
1    00106F030FB1  1     Dynamic     1    00400541AFBF  1     Dynamic
1    001083CFA85E  1     Dynamic     1    00400551842F  1     Dynamic
1    001300000001  1     Dynamic     1    00400551E1DE  1     Dynamic
1    0020481A8547  1     Dynamic     1    00402647F56F  1     Dynamic
-----
*****
Function:
Message:
Esc= Previous screen  CTRL+R= Refresh  CTRL+N= Next Page  CTRL+P=Previous Page
    
```

3. Toggle the **Browse By** field between **ALL**, **MAC Address**, **Port**, and **VLAN**. This option sets a filter to determine which MAC addresses from the forwarding table are displayed. **ALL** specifies no filter.

### Searching for a Particular MAC Address

To search for a particular MAC address:

1. Toggle the **Browse By** field to **MAC Address**. A **MAC Address** field is displayed.
2. Type the MAC address in the **MAC Address** field, then press the **Enter** key.
3. Highlight **BROWSE** and press the **Enter** key to initiate the browsing action.
4. Highlight **CLEAR ALL** and press the **Enter** key to reset the table counters.

## Monitoring GbE Interconnect Switch History

To view the GbE Interconnect Switch history log:

1. Highlight **Switch History** from the **Network Monitoring Menu**.
2. Press the **Enter** key. The following screen is displayed.

```

Switch History
-----
Seq. #      Time      Log Text
-----
 29      000d04h47m  Module 1, Port 1 Link Up
 28      000d04h40m  Configuration saved to flash.
 27      000d04h00m  Successful login through console.
 26      000d00h22m  Module 1, Port 1 Link Down
 25      000d00h06m  Module 1, Port 1 Link Up
 24      000d00h06m  Module 1, Port 1 Link Down
 23      000d00h06m  Module 1, Port 1 Link Up
 22      000d00h04m  Module 1, Port 1 Link Down
 21      000d00h00m  Successful logout through console.
 20      000d00h00m  Module 1, Port 1 Link Up
 19      000d00h00m  Successful login through console.
 18      000d00h00m  Cold Start
- more (12 of 29)

*****
Function:View Switch Logs and Health Status
Message:
CTRL+N=Next Page  CTRL+P=Previous Page  B=Begin  E=End  C=Clear  CTRL+R=Refresh
    
```

The **Switch History** screen displays the GbE Interconnect Switch logs and health status.

## Monitoring IGMP Snooping

IGMP Snooping allows the GbE Interconnect Switch to read the Multicast Group IP address and the corresponding MAC address from IGMP packets that pass through the GbE Interconnect Switch. The ports where the IGMP packets were snooped are displayed and designated with an “M.” The number of IGMP reports that were snooped is also displayed in the **Reports** field.

To view the IGMP Snooping table:

1. Highlight **IGMP Snooping** on the **Network Monitoring Menu**.
2. Press the **Enter** key. The following screen is displayed.

```

IGMP Snooping Status
-----
VID: [1]          GO          Total Entries in the VLAN: 0
-----
VID: 1          State: Enabled   Age Out: 260   Queries:Non-Querier
Multicast group:          1 to 8  9 to 16  17 to 24
MAC address:
Reports:

Multicast group:          1 to 8  9 to 16  17 to 24
MAC address:
Reports:

Multicast group:          1 to 8  9 to 16  17 to 24
MAC address:
Reports:
*****
Function: Enter VLAN ID
Message:
Esc= Previous screen  CTRL+R= Refresh  CTRL+N= Next Page  CTRL+P=Previous Page
    
```

3. Type the VLAN name in the **VID** field.
4. Highlight **GO** and press the **Enter** key to view the IGMP Snooping table.

## Monitoring the Dynamic Group Registration Table

To view the Dynamic Group Registration Table:

1. Highlight **Dynamic Group Registration Table** on the **Network Monitoring Menu**.
2. Press the **Enter** key. The following screen is displayed.

The screenshot shows a terminal window titled "Dynamic Group Registration Table". The table has four columns: "VID", "Group Addr.", "Type", and "Member Port-list". The table is currently empty. Below the table, there is a separator line of asterisks, followed by the text "Function:", "Message:", and "Esc= Previous screen CTRL+R= Refresh CTRL+N= Next Page CTRL+P=Previous Page".

```
Dynamic Group Registration Table
-----
VID  Group Addr.  Type           Member Port-list
-----
                                          
                                          
                                          
                                          
                                          
*****
Function:
Message:
Esc= Previous screen  CTRL+R= Refresh  CTRL+N= Next Page  CTRL+P=Previous Page
```

The **Dynamic Group Registration Table** displays filtering information for VLANs configured into the Bridge by local or network management, or learned dynamically. It specifies the set of ports to which frames received on a VLAN for this forwarding database (FDB), and containing a specific group destination address, are allowed to be forwarded.

## Monitoring VLAN Status

To view the VLAN Status table:

1. Highlight **VLAN Status** on the **Network Monitoring Menu**.
2. Press the **Enter** key. The following screen is displayed.

```

VLAN Status
-----
Number of IEEE 802.1Q VLAN: 1

IEEE 802.1Q VLAN ID: 1

Current Egress Ports:  1,  2,  3,  4,  5,  6,  7,  8,  9, 10,
                      11, 12, 13, 14, 15, 16, 17, 18, 19, 20,
                      21, 22, 23, 24,CPU
Current Untagged Ports:  1,  2,  3,  4,  5,  6,  7,  8,  9, 10,
                      11, 12, 13, 14, 15, 16, 17, 18, 19, 20,
                      21, 22, 23, 24

Status: Permanent

Creation time since switch power up: 00:58:52

*****
Function:
Message:
Esc= Previous screen  CTRL+R= Refresh  CTRL+N= Next Page  CTRL+P=Previous Page
    
```

The **VLAN Status** window displays which VLAN ports are egress and which ports are untagged.

## Configuring SNMP Manager

The GbE Interconnect Switch sends out SNMP traps (alert messages) to network management stations whenever certain exceptional events occur, such as when the GbE Interconnect Switch is turned on or when a system reset occurs. The GbE Interconnect Switch allows traps to be routed to up to four network management hosts.

SNMP (version 1) implements a rudimentary form of security by requiring that each request include a “community name.” A community name is an arbitrary string of characters used as a “password” to control access to the GbE Interconnect Switch. If the GbE Interconnect Switch receives a request with a community name it does not recognize, it triggers an authentication trap.

SNMP allows up to four community names to be defined. The community name “public” is defined by default; you can change this name in addition to adding others. You must coordinate these names with the community name settings you use in your network management system.

To set the SNMP Manager Configuration settings:

1. Highlight **SNMP Manager Configuration** on the main menu.
2. Press the **Enter** key. The following screen is displayed.

```

SNMP Manager Configuration
-----
SNMP Community String      Access Right      Status
[public                    ] <Read Only>      <Valid >
[private                   ] <Read/Write>     <Valid >
[                           ] <Read Only>      <Invalid>
[                           ] <Read Only>      <Invalid>

SNMP Trap Manager Configuration
IP Address                 SNMP Community String      Status
[10.44.7.1                 ] [public                    ] <Valid >
[                           ] [                           ] <Invalid>
[                           ] [                           ] <Invalid>
[                           ] [                           ] <Invalid>

Security IP:
[0.0.0.0                   ] [0.0.0.0                   ] [0.0.0.0                   ] [0.0.0.0                   ]
[0.0.0.0                   ] [0.0.0.0                   ] [0.0.0.0                   ] [0.0.0.0                   ]

                                APPLY
*****
Function:Edit SNMP Community Strings.
Message:
CTRL+T = Root screen           Esc=Prev. screen             CTRL+R = Refresh
    
```

The following SNMP Manager and Trap Manager Configuration parameters can be set:

- **SNMP Community String**—Displays the community string that is included on SNMP packets sent to and from the GbE Interconnect Switch. Any station not privy to this community does not receive the packet.
- **Access Right**—Allows each community to be separately set to either **Read Only**, meaning that the community member can only view switch settings, or **Read/Write**, which allows the member to change settings in the GbE Interconnect Switch.
- **Status**—Determines whether this community name entry is **Valid** or **Invalid**. An entry can be disabled by changing its status to **Invalid**.
- **IP Address**—Displays the IP address of the network management station designated to receive traps.
- **Security IP**—Allows you to create a list of IP addresses that are allowed to access the GbE Interconnect Switch by means of SNMP or Telnet.

3. After making your changes, highlight **APPLY**, then press the **Enter** key.

**NOTE:** To save the configuration settings permanently, you must enter them into NVRAM using the **Save Changes** option on the main menu. Refer to the “Saving Changes” section earlier in this chapter.



## Using System Utilities

To set the system utilities settings:

1. Highlight **System Utilities** on the main menu.
2. Press the **Enter** key. The following screen is displayed.

```
Switch Utilities
-----
Switch Settings:

Server IP Address: 10.43.10.1
Switch IP Address: 10.24.22.3
Subnet Mask: 255.0.0.0
Gateway Router: 10.254.254.251

TFTP Services:                Others:
Upgrade Firmware from TFTP Server  Ping Test
Use Configuration File on TFTP Server
Save Settings to TFTP Server
Save History Log to TFTP Server

*****
Function:Upgrade firmware from TFTP server.
Message:
CTRL+T = Root screen          Esc=Prev. screen          CTRL+R = Refresh
```

**NOTE:** Trivial File Transfer Protocol (TFTP) services allow the switch firmware to be upgraded by transferring a new firmware file from a TFTP server to the GbE Interconnect Switch. A configuration file can also be loaded into the GbE Interconnect Switch from a TFTP server, GbE Interconnect Switch settings can be saved to the TFTP server, and a history log can be uploaded from the GbE Interconnect Switch to the TFTP server.

## Upgrading Firmware from a TFTP Server

To upgrade the firmware from a TFTP server:

1. Highlight **Upgrade Firmware from TFTP Server** on the **Switch Utilities** menu.
2. Press the **Enter** key. The following screen is displayed.

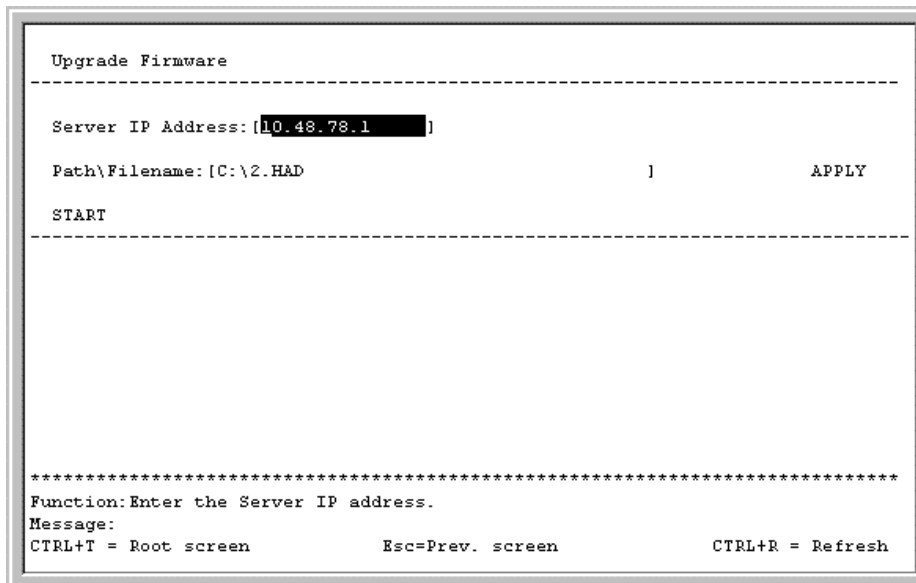

3. Type the IP address of the TFTP server in the **Server IP Address** field.

**NOTE:** The TFTP server must be on the same IP subnet as the GbE Interconnect Switch.

4. Type the path and the filename to the firmware file on the TFTP server in the **Path\Filename** field.

**NOTE:** The TFTP server must be running TFTP server software to perform the file transfer. TFTP server software is included in many network management software packages, or it can be obtained as a separate program.

5. Highlight **APPLY** and press the **Enter** key to record the IP address of the TFTP server.
6. Highlight **START** and press the **Enter** key to initiate the file transfer.

**NOTE:** To save the configuration settings permanently, you must enter them into NVRAM using the **Save Changes** option on the main menu. Refer to the “Saving Changes” section earlier in this chapter.

## Downloading Configuration File from a TFTP Server

To download a GbE Interconnect Switch configuration file from a TFTP server:

1. Highlight **Use a Configuration File on TFTP Server** on the **Switch Utilities** menu.
2. Press the **Enter** key. The following screen is displayed.

```
Use Configuration File on TFTP Server
-----
Server IP Address: [10.43.10.1]
Path\Filename: [          ]      APPLY
START
-----

*****
Function: Enter the Server IP address.
Message:
CTRL+T = Root screen      Esc=Prev. screen      CTRL+R = Refresh
*****
```

3. Type the IP address of the TFTP server in the **Server IP Address** field.
4. Type the location of the GbE Interconnect Switch configuration file on the TFTP server in the **Path\Filename** field.
5. Highlight **APPLY** and press the **Enter** key to record the IP address of the TFTP server.
6. Highlight **START** and press the **Enter** key to initiate the file transfer.

**NOTE:** To save the configuration settings permanently, you must enter them into NVRAM using the **Save Changes** option on the main menu. Refer to the “Saving Changes” section earlier in this chapter.

## Saving Settings to a TFTP Server

After completing the final configuration for the GbE Interconnect Switch, Compaq highly recommends that you save the GbE Interconnect Switch configuration file to TFTP server storage.

To save the GbE Interconnect Switch configuration file to a TFTP server:

1. Highlight **Save Settings to TFTP Server** on the **Switch Utilities** menu.
2. Press the **Enter** key. The following screen is displayed.

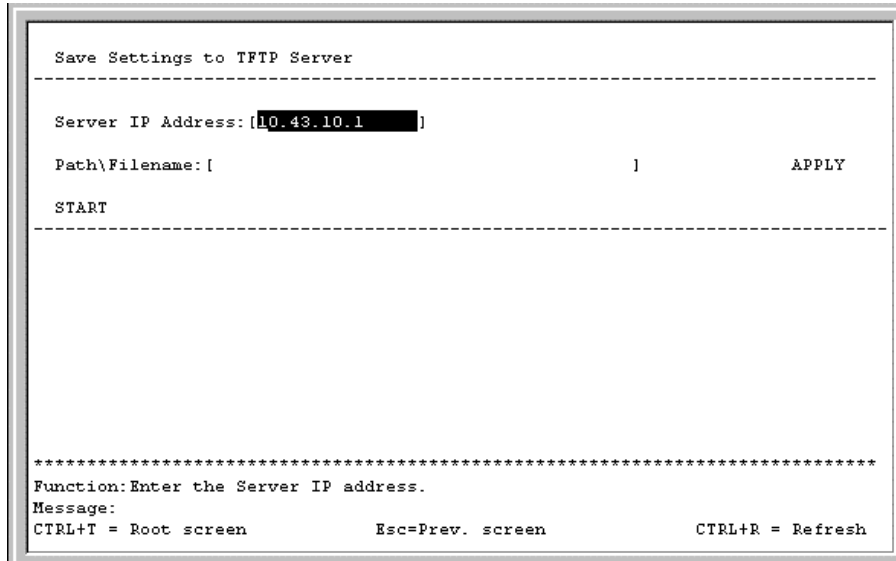

3. Type the IP address of the TFTP server in the **Server IP Address** field.
4. Type the location of the GbE Interconnect Switch configuration file on the TFTP server in the **Path\Filename** field.
5. Highlight **APPLY** and press the **Enter** key.
6. Highlight **START** and press the **Enter** key to initiate the file transfer.

**NOTE:** To save the configuration settings permanently, you must enter them into NVRAM using the **Save Changes** option on the main menu. Refer to the “Saving Changes” section earlier in this chapter.

## Saving the History Log to a TFTP Server

To save the History Log on a TFTP server:

1. Highlight **Save History Log to TFTP Server** on the **Switch Utilities** menu.
2. Press the **Enter** key. The following screen is displayed.

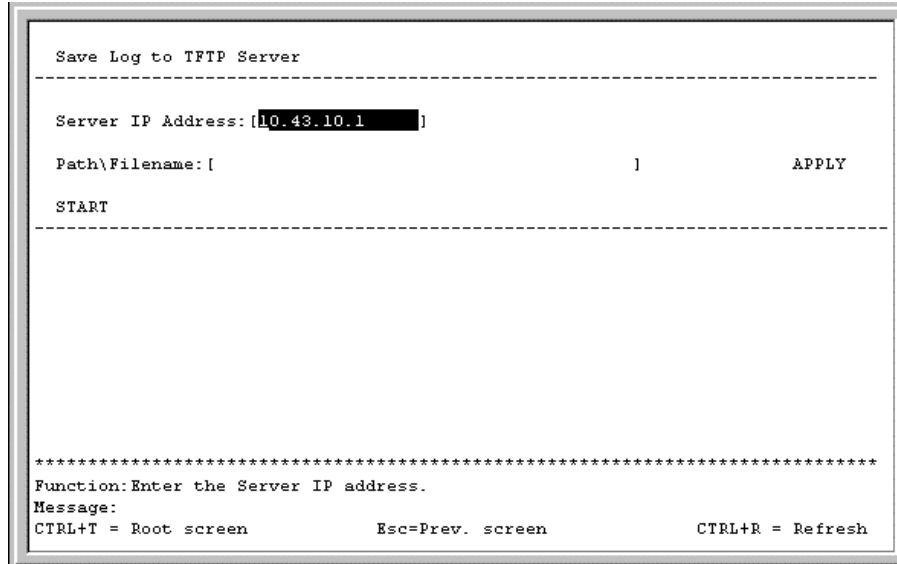

3. Type the IP address of the TFTP server in the **Server IP Address** field.
4. Type the path and filename for the history log on the TFTP server in the **Path\Filename** field.
5. Highlight **APPLY** and press the **Enter** key to make the changes current.
6. Highlight **START** and press the **Enter** key to initiate the file transfer.

**NOTE:** To save the configuration settings permanently, you must enter them into NVRAM using the **Save Changes** option on the main menu. Refer to the “Saving Changes” section earlier in this chapter.

## Performing a Ping Test

To test the connection with another network device using Ping:

1. Highlight **Ping Test** on the **Switch Utilities** menu.
2. Press the **Enter** key. The following screen is displayed.

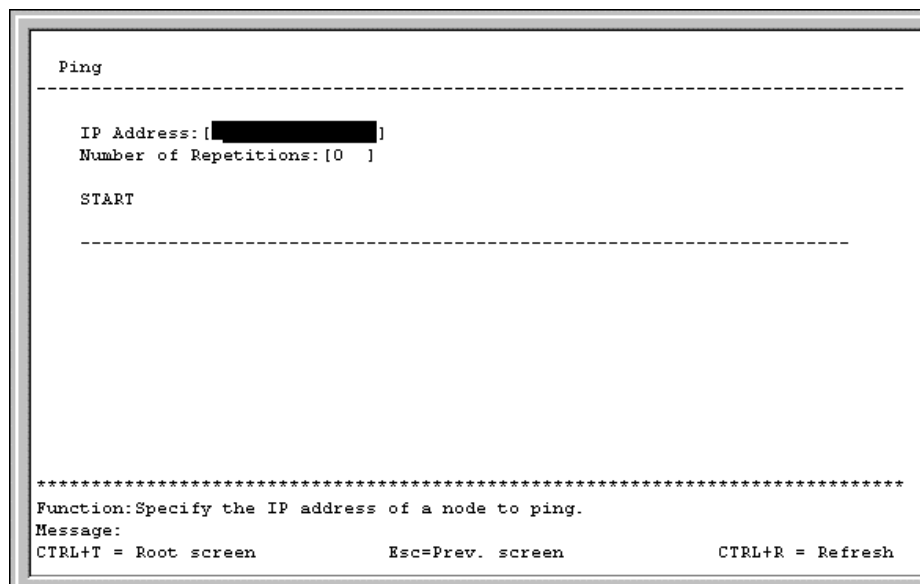

3. Type the IP address of the network device to be pinged in the **IP Address** field.
4. Type the number of test packets to be sent (three is usually enough) in the **Number of Repetitions** field.
5. Highlight **START** and press the **Enter** key.

**NOTE:** To save the configuration settings permanently, you must enter them into NVRAM using the **Save Changes** option on the main menu. Refer to the “Saving Changes” section earlier in this chapter.

## Rebooting the GbE Interconnect Switch

The GbE Interconnect Switch reboot options are:

- **Reboot**—Restarts the GbE Interconnect Switch. Any configuration settings not saved using **Save Changes** from the main menu are lost. The GbE Interconnect Switch configuration is restored to the last configuration saved in NVRAM.
- **Save Configuration & Reboot**—Saves the configuration to NVRAM (identical to using **Save Changes**) and then restarts the GbE Interconnect Switch.

- **Reboot & Load Factory Default Configuration**—Restarts the GbE Interconnect Switch using the default factory configuration. All user-defined configuration data is lost.
- **Reboot & Load Factory Default Configuration Except IP Address**—Restarts the GbE Interconnect Switch using the default factory configuration, except the user-configured IP address, which is retained. All other configuration data is lost. If you want your IP address to default from DHCP or BOOTP, do not choose this option.

**NOTE:** Refer to Appendix C for a list of factory default settings.

To reboot the GbE Interconnect Switch from the console:

1. Highlight **Reboot** on the main menu.
2. Press the **Enter** key. The following menu is displayed.

```
System Reboot
-----
Reboot
Save Configuration & Reboot
Reboot & Load Factory Default Configuration
Reboot & Load Factory Default Configuration Except IP Address

*****
Function:
Message:
CTRL+T = Root screen      Esc=Prev. screen      CTRL+R = Refresh
```

3. Highlight the appropriate selection.

4. Press the **Enter** key. The following screen is displayed.

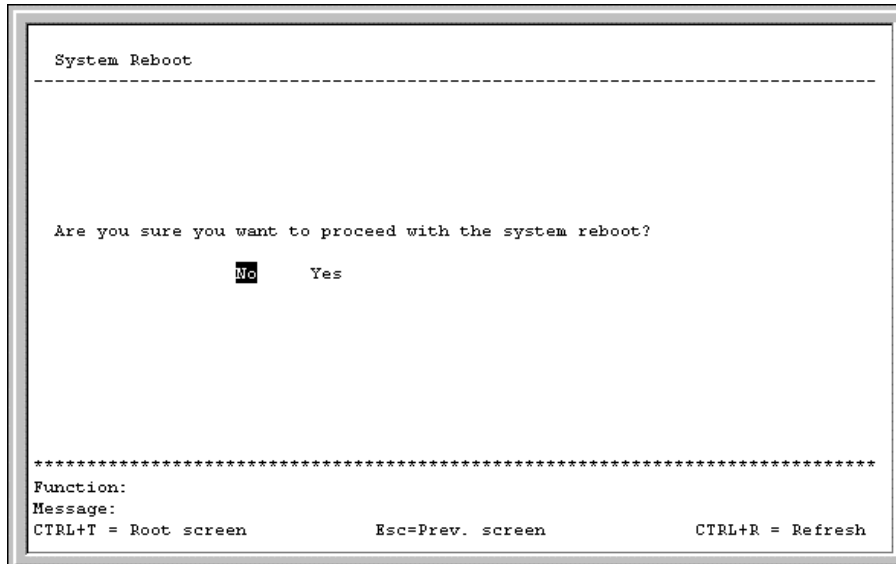

5. Highlight **Yes** and press the **Enter** key.

## Logging Out

To exit the setup pages, select **Logout** on the **Maintenance** menu. The **Account Login** screen is displayed.



---

# Configuring the GbE Interconnect Switch Using the Web-Based Management Interface

## Introduction

The GbE Interconnect Switch offers an embedded Web-based (HTML) interface that allows users to manage each GbE Interconnect Switch from anywhere on the network through a standard browser, such as Netscape Navigator or Microsoft Internet Explorer. The Web browser acts as a universal access tool and can communicate directly with the GbE Interconnect Switches using the HTTP protocol.

**NOTE:** Your browser window may differ from the screen shots in this guide.

The Web-based management module and the console management program are different ways to access and configure the same internal switching software. All settings encountered in Web-based management are the same as those in the console management program.

This chapter describes how to use the Web-based management interface to access the GbE Interconnect Switches, change their settings, and monitor their operation.

**NOTE:** This Web-based management module does not accept Chinese language input (or other languages requiring two bytes per character).

## Before You Begin

The ProLiant BL p-Class GbE Interconnect Switch supports a wide array of functions and gives great flexibility and increased network performance. This flexibility and rich feature set require some planning to arrive at a deployment strategy that will maximize the potential of the GbE Interconnect Switch. Refer to the section, “Planning the GbE Interconnect Switch Configuration,” in Chapter 2 for things to keep in mind as you configure your GbE Interconnect Switches.

## Connecting to the GbE Interconnect Switch

Before you can connect to a GbE Interconnect Switch using the Web-based management interface, you must set the IP address on the GbE Interconnect Switch. By default, if there is a DHCP server on the network, a GbE Interconnect Switch obtains the IP address automatically. If there is no DHCP server on the network, configure the IP address of the GbE Interconnect Switches using the console management interface.

**NOTE:** Refer to the section, “Accessing the GbE Interconnect Switch,” in Chapter 2 for information on how to connect to the console management interface. Refer to the sections, “Logging on to the GbE Interconnect Switch,” and, “Configuring the IP Address,” in Chapter 3 for information on how to use the console interface management system to manually configure the IP address of a GbE Interconnect Switch.

To connect to a GbE Interconnect Switch using the Web-based management interface:

1. Start a Web browser, for example, Microsoft Internet Explorer version 5.5 or higher or Netscape Navigator version 6.1 or higher.
2. Type the IP address you have defined for the GbE Interconnect Switch in the browser address bar. The URL in the address bar should be similar to: `http://10.24.22.8`.
3. Press the **Enter** key. The **Enter Network Password** dialog box for the GbE Interconnect Switch is displayed.

**IMPORTANT:** The proxy for session connection should be turned off.

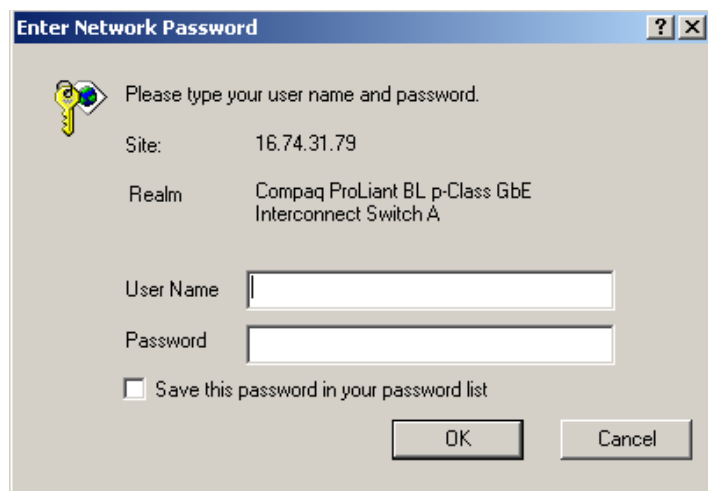

## Logging On to the GbE Interconnect Switch

**IMPORTANT:** The GbE Interconnect Switch does not have any initial user names or passwords set. Compaq recommends that after logging on, create at least one Root-level user as the switch administrator. (Refer to Table 2-1 in Chapter 2 for an explanation of user privileges.) If you forget your password after it has been set up, call Compaq Customer Support for assistance.

To log on to the GbE Interconnect Switch for the first time:

1. Click **OK** at the **Enter Network Password** dialog box. No initial user name or password is set for the first user. The main page in the Web-based management module is displayed.

The main page displays the main menu, an active graphic of the GbE Interconnect Switch, and the **TCP/IP Parameters Setup** window.

The active graphic of the GbE Interconnect Switch allows you to monitor the GbE Interconnect Switch status. Graphical LEDs display current link speed and activity. Graphical RJ-45 connectors allow you to display statistics for individual ports. Refer to the section, “Monitoring the GbE Interconnect Switch Using the Active Switch Graphic,” for detailed information.

The **TCP/IP Parameters Setup** window is used to determine whether the GbE Interconnect Switch should get its IP address settings from the user (Manual), a BOOTP server, or a DHCP server. Refer to the section “Configuring IP Address.”

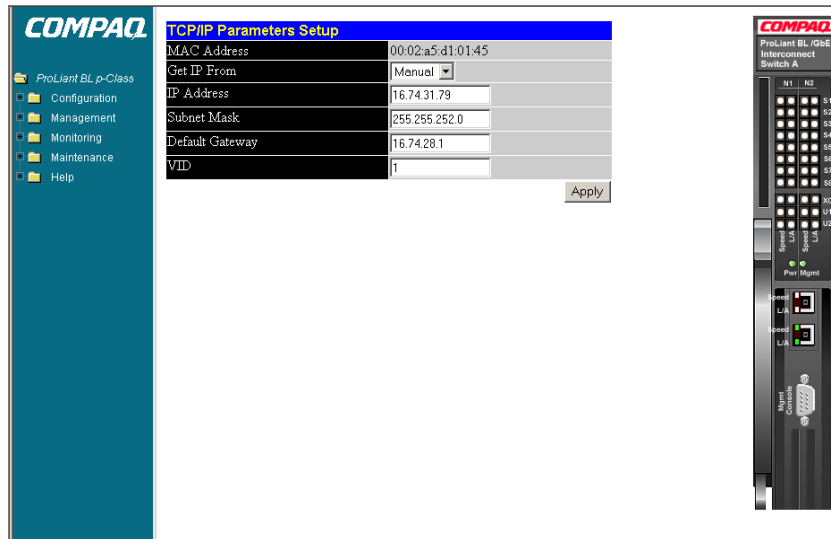

2. Click the small square hyperlink to the left of the folder icons to display a list of additional menus used to configure, manage, monitor, and maintain the GbE Interconnect Switch.

## Setting Up New Users

You can set up a maximum of eight users on a GbE Interconnect Switch.

**NOTE:** After logging on to the GbE Interconnect Switch for the first time, you must set up at least one user account with Root privileges.

To create a new user account:

1. Click the small square to the left of the **Management** folder on the main menu. The Management menus are displayed.
2. Click **User Accounts**. The following window is displayed.

User Account Management		
User Name	Access Right	
admin	Root	Add Modify
switchuser	User	Modify

3. Click **Add** to add a new user to the table. The following window is displayed.

User Account Modify Table	
User Name	<input type="text"/>
New Password	<input type="text"/>
Confirm New Password	<input type="text"/>
Access Right	Root <input type="button" value="v"/>
<input type="button" value="Apply"/>	

4. Type the user name in the **User Name** field.
5. Type the user’s password in the **New Password** field.
6. Type the new password a second time in the **Confirm Password** field.
7. Click the drop-down arrow in the **Access Right** field to select the access level. The three access levels are **User**, **User+**, and **Root**. A **Root** user has full read/write access, while a **User** has read-only access. A **User+** has the same privileges as a **User**, but with the added ability to restart the GbE Interconnect Switch.

**NOTE:** Refer to Table 2-1 in Chapter 2 for an explanation of access rights.

8. Click **Apply**. The **Enter Network Password** dialog box is displayed.
9. Type the new user’s name in the **User Name** field.
10. Type the user’s password in the **Password** field.
11. Click **OK**. The **User Account Management** window is displayed with the new user listed. You are now ready to configure the GbE Interconnect Switch.

**NOTE:** To save the configuration settings permanently, you must enter them into non-volatile RAM (NVRAM) using the **Save Changes** option on the **Maintenance** menu. Refer to the “Saving Changes” section in this chapter.

## Saving Changes

The GbE Interconnect Switch has two levels of memory, normal RAM and NVRAM. Configuration changes on a screen are made effective by clicking the **Apply** button. The settings are then immediately applied to the switching software in RAM.

To make your configuration changes permanent, save them to NVRAM using the **Save Changes** option on the **Maintenance** menu before rebooting the system.

**NOTE:** Some settings require you to restart the GbE Interconnect Switch before they take effect. Restarting the GbE Interconnect Switch erases all settings in RAM and reloads the stored settings from NVRAM.

To retain any configuration changes permanently:

1. Open the **Maintenance** folder on the main menu.
2. Click **Save Changes**. The **Save Configuration** window is displayed.

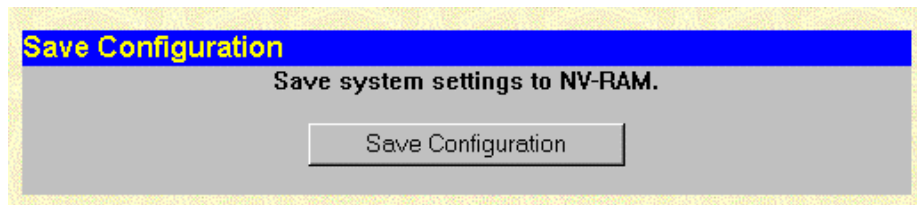

3. Click **Save Configuration** to save all the changes made in the current session to the NVRAM memory of the GbE Interconnect Switch. A message box is displayed when the save is completed.
4. Click **OK**. After the GbE Interconnect Switch configuration settings have been saved to NVRAM, they become the default settings for the GbE Interconnect Switch. These settings are used every time the GbE Interconnect Switch is rebooted.

**IMPORTANT:** After saving your final configuration, Compaq highly recommends that you save the GbE Interconnect Switch configuration image to TFTP server storage. Refer to the section, "Saving Settings to TFTP Server," later in this chapter.

## Configuring the GbE Interconnect Switch

Selecting the **Configuration** menu from the main menu provides the following options:

- IP Address
- Switch Information
- Advanced Settings

- Port Configuration
- Port Mirroring
- Port Trunking
- IGMP Snooping

## Configuring IP Address

When you select **IP Address** from the **Configuration** menu, the following screen is displayed.

TCP/IP Parameters Setup	
MAC Address	00:05:5d:f9:32:87
Get IP From	Manual
IP Address	10.24.22.8
Subnet Mask	255.0.0.0
Default Gateway	0.0.0.0
VID	1

Apply

The **TCP/IP Parameters Setup** window is used to determine whether the GbE Interconnect Switch should get its IP address settings from the user (Manual), a BOOTP server, or a DHCP server.

The window displays the following information:

- **MAC Address**—The Ethernet address for the device, also known as the physical address
- **Get IP From**—The choices for how the GbE Interconnect Switch receives its IP address settings: Manual, BOOTP, and DHCP
- **IP Address**—The host address for the device on the TCP/IP network
- **Subnet Mask**—The address mask that controls subnetting on your TCP/IP network
- **Default Gateway**—The IP address of the device, usually a router, that handles connections to other subnets or other TCP/IP networks
- **VID**—The VLAN ID (VID) number for the switch management port

To set the IP address:

1. Select **Manual**, **BOOTP**, or **DHCP** in the **Get IP From** field:
  - If you select **Manual**, enter the **IP Address**, **Subnet Mask**, and **Default Gateway** of the GbE Interconnect Switch.

- If you select **BOOTP**, you do not need to configure any IP parameters because a BOOTP server automatically assigns IP configuration parameters to the GbE Interconnect Switch.
- If you select **DHCP**, a DHCP request will be sent when the GbE Interconnect Switch is powered up.

2. Click **Apply** to activate the new settings.

**NOTE:** To save the configuration settings permanently, you must enter them into NVRAM using the **Save Changes** option on the **Maintenance** menu. Refer to the section, “Saving Changes,” earlier in this chapter.

## Setting Basic GbE Interconnect Switch Information

When you select **Switch Information** from the **Configuration** menu, the following screen is displayed.

Switch Information (Basic Settings)	
Device Type	Compaq ProLiant BL p-Class GbE Interconnect Switch B
Mac Address	00:80:c8:24:37:1a
Boot PROM Version	0.00.003
Firmware Version	0.00.014
Hardware Version	
Manufacturing Date	ff / ff / ff
System Name	<input type="text"/>
System Location	<input type="text"/>
System Contact	<input type="text"/>

The **Switch Information (Basic Settings)** window displays the following information:

- **Device Type**—A description of the GbE Interconnect Switch type.
- **MAC Address**—The Ethernet address for the device.
- **Boot PROM Version**—The version number for the firmware chip. This information is needed for new runtime software downloads.
- **Firmware Version**—The version number of the firmware installed on the GbE Interconnect Switch. This information can be updated by using the **Update Firmware** window in the **Reset and Update** section.
- **Hardware Version**—The version of the optional module plugged into the front slot.
- **Manufacturing Date**—The manufacture date of the GbE Interconnect Switch.
- **System Name**—A user-assigned name for the GbE Interconnect Switch.

- **System Location**—A user-assigned description for the physical location of the GbE Interconnect Switch.
- **System Contact**—The name of the person to contact if there are any problems or questions with the system. You may also want to include a phone number or extension.

To complete the user-assigned GbE Interconnect Switch information:

1. Type the system name in the **System Name** field.
2. Type the physical location of the GbE Interconnect Switch in the **System Location** field.
3. Type the name of the contact person responsible for the GbE Interconnect Switch (and telephone number or other contact information) in the **System Contact** field.
4. Click **Apply**.

**NOTE:** To save the configuration settings permanently, they must be entered into NVRAM using the **Save Changes** option on the **Maintenance** menu. Refer to the section, “Saving Changes,” earlier in this chapter.

## Configuring Advanced Settings

When you select **Advanced Settings** from the **Configuration** menu, the following screen is displayed.

Switch Information(Advanced Settings)	
Auto Logout of Console & Telnet	10 Minutes
Mac Address Aging Time	300
IGMP Snooping	Disabled
GVRP Status	Disabled
Telnet Status	Enabled
Web Status	Enabled
Group Address Filter Mode	Forward All Unregistered
Scheduling Mechanism for CoS Queues	Strict
Trunk Load Sharing Algorithm	Source Addr
Backpressure	Disabled

Apply

You can change the following parameters:

- **Auto Logout of Console & Telnet**—Select the time that the interface can be idle before the GbE Interconnect Switch automatically logs-out the user. The options are **2 minutes**, **5 minutes**, **10 minutes**, **15 minutes**, and **Never**.



- **Mac Address Aging Time**—Select the length of time a learned MAC address remains in the forwarding table without being accessed (that is, how long a learned MAC address is allowed to remain idle). The aging time can be set to any value between 10 and 1,000,000 seconds.  
  
**NOTE:** A very long aging time can result in out-of-date dynamic entries that may cause incorrect packet filtering and forwarding decisions. A very short aging time may cause entries to be aged out too soon, resulting in a high percentage of received packets whose source addresses cannot be found in the address table, in which case the GbE Interconnect Switch will broadcast the packet to all ports, negating many of the benefits of having a GbE Interconnect Switch.
- **IGMP Snooping**—Choose to enable or disable Internet Group Management Protocol (IGMP) Snooping. IGMP Snooping enables the GbE Interconnect Switch to read IGMP packets being forwarded through the GbE Interconnect Switch in order to obtain forwarding information from them, such as which ports contain Multicast members.
- **GVRP Status**—Choose to enable or disable Group VLAN Registration Protocol (GVRP) on the GbE Interconnect Switch. GVRP allows members to dynamically join VLANs.
- **Telnet Status**—Choose to enable or disable access to the GbE Interconnect Switch over the network using the TCP/IP Telnet protocol.
- **Web Status**—Choose to enable or disable management of the GbE Interconnect Switch over the Web.
- **Group Address Filter Mode**—Select one of the forwarding or filtering options to set the IGMP filter mode for processing multicast packets.
- **Scheduling Mechanism for CoS Queues**—Choose one of the **Class of Service** queue options. If you select **Strict**, then when the highest priority queue is full, those packets will be the first to be forwarded. If you select **RoundRobin**, the forwarding is based on the settings made on the **Class of Service Configuration** screen.
- **Trunk Load Sharing Algorithm**—Select one of the trunk load sharing options, **Source Addr**, **Destination Addr**, or **Both**, to determine if load balancing decisions will be made based on the source MAC address, destination MAC address, or both addresses.
- **Backpressure**— Select **Enabled** or **Disabled** to initiate or terminate traffic flow control in and out of the switch.

After making your choices in **Advanced Settings**, click **Apply**.

**NOTE:** To save the configuration settings permanently, they must be entered into NVRAM using the **Save Changes** option on the **Maintenance** menu. Refer to the section, “Saving Changes,” earlier in this chapter.

## Configuring Port Settings

When you select **Port Configuration** from the **Configuration** menu, the following screen is displayed.

**Port Configuration**

Port	Port Name	State	Speed/Duplex	Flow Control	Apply
Port 1	Server1_ILO	Enabled	Auto	Off	Apply

**The Port Information Table**

Port	Type	VLAN Name	Port Name	State	Speed/Duplex	Flow Control	Connection
1	Server	DEFAULT_VLAN	Server1_ILO	Enabled	AUTO	Off	---
2	Server	DEFAULT_VLAN	Server1_Port3	Enabled	AUTO	Off	---
3	Server	DEFAULT_VLAN	Server2_ILO	Enabled	AUTO	Off	---
4	Server	DEFAULT_VLAN	Server2_Port3	Enabled	AUTO	Off	---
5	Server	DEFAULT_VLAN	Server3_ILO	Enabled	AUTO	Off	---
6	Server	DEFAULT_VLAN	Server3_Port3	Enabled	AUTO	Off	---
7	Server	DEFAULT_VLAN	Server4_ILO	Enabled	AUTO	Off	---
8	Server	DEFAULT_VLAN	Server4_Port3	Enabled	AUTO	Off	---
9	Server	DEFAULT_VLAN	Server5_ILO	Enabled	AUTO	Off	---
10	Server	DEFAULT_VLAN	Server5_Port3	Enabled	AUTO	Off	---
11	Server	DEFAULT_VLAN	Server6_ILO	Enabled	AUTO	Off	---
12	Server	DEFAULT_VLAN	Server6_Port3	Enabled	AUTO	Off	---
13	Server	DEFAULT_VLAN	Server7_ILO	Enabled	AUTO	Off	---
14	Server	DEFAULT_VLAN	Server7_Port3	Enabled	AUTO	Off	---
15	Server	DEFAULT_VLAN	Server8_ILO	Enabled	AUTO	Off	---
16	Server	DEFAULT_VLAN	Server8_Port3	Enabled	AUTO	Off	---
17	X-Connect	DEFAULT_VLAN	XConnect_1	Enabled	AUTO	Off	---
18	X-Connect	DEFAULT_VLAN	XConnect_2	Enabled	AUTO	Off	---
19	M Uplink	DEFAULT_VLAN	UpLink1_ILO	Enabled	AUTO	Off	---
20	M Uplink	DEFAULT_VLAN	UpLink2_ILO	Enabled	AUTO	Off	---
21	D Uplink	DEFAULT_VLAN	UpLink1_Port3	Enabled	AUTO	On	---
22	D Uplink	DEFAULT_VLAN	UpLink2_Port3	Enabled	AUTO	On	---

To change the port settings:

1. Select the port you want to configure in the **Port** field, or click the port on the GbE Interconnect Switch front panel display.
2. Choose **Enabled** or **Disabled** in the **State** field. If you choose **Disabled**, devices connected to that port cannot use the GbE Interconnect Switch, and the switch purges their addresses from its address table after the MAC address aging time elapses.

3. Configure the **Speed/Duplex** setting for the port:

**NOTE:** If you have the ProLiant BL p-Class F-GbE Interconnect Kit option with the DualTSX Interconnect Modules, the management interface supports only 1000M/Full and Auto options for the **Speed/Duplex** fields for the Gigabit uplink ports. The fiber DualTSX Interconnect Module supports **only 1000-Mb/s (Gigabit) speed**, and **not** 10-Mb/s or 100-Mb/s.

- Select **Auto** to allow the port to select the best transmission speed, duplex mode, and flow control settings based on the capabilities of the device at the other end. The other selections allow you to force the port to operate in the specified manner.
- Select **1000M/FULL** for port operation at 1000 Mb/s and full duplex.
- Select **100M/FULL** for port operation at 100 Mb/s and full duplex.
- Select **100M/HALF** for port operation at 100 Mb/s and half duplex.
- Select **10M/FULL** for port operation at 10 Mb/s and full duplex.
- Select **10M/HALF** for port operation at 10 Mb/s and half duplex.

4. Configure the **Flow Control** setting for the port:

- Select **On** for flow control.
- Select **Off** for no flow control.

**IMPORTANT:** You must reboot the GbE Interconnect Switch before a flow control change can take effect.

5. Click **Apply**.

**NOTE:** To save the configuration settings permanently, you must enter them into NVRAM using the **Save Changes** option on the **Maintenance** menu. Refer to the section, “Saving Changes,” earlier in this chapter.

## Configuring Port Mirroring

When you select **Port Mirroring** from the **Configuration** menu, the following screen is displayed.

Port Mirroring	
Source Port	Port 1
Source Direction	Either
Target Port	Port 11
Status	Disabled

Apply

**Note(1):** The "Source Port" and "Target Port" should be different, or the setup will be invalid.

**Note(2):** The target port should be a non-trunked port.

**The Trunking Ports:**  
Group ID (1):17 18

The GbE Interconnect Switch allows you to copy frames transmitted and received on a port, and to redirect the copies to another port. You can attach a monitoring device to the mirrored port, such as a sniffer or an RMON probe, to view details about the packets passing through the first port.

**IMPORTANT:** You cannot mirror a faster port onto a slower port. For example, if you try to mirror the traffic from a 100-Mb/s port onto a 10-Mb/s port, you can cause throughput problems. The port you are copying frames from should always support an equal or lower speed than the port to which you are sending the copies. Also, the target port for mirroring cannot be a member of a trunk group. A target port and a source port also cannot be the same port.

To configure a mirror port:

1. Select the **Source Port** from which you want to copy frames.
2. Select the **Source Direction**, either **Ingress**, **Egress**, or **Either**.
3. Select the **Target Port** that receives the copies from the source port. This is the port where you would connect a monitoring or troubleshooting device, such as a sniffer or an RMON probe.
4. Select **Enabled** in the **Status** field.
5. Click **Apply**.

**NOTE:** To save the configuration settings permanently, you must enter them into NVRAM using the **Save Changes** option on the **Maintenance** menu. Refer to the section, "Saving Changes," earlier in this chapter.

## Configuring Port Trunking

When you select **Port Trunking** from the **Configuration** menu, the following screen is displayed.

Port Trunking Settings																											
ID	Name	Member Ports																								State	Active
		1	2	3	4	5	6	7	8	9	10	11	12	13	14	15	16	17	18	19	20	21	22	23	24		
1	XConnect	<input type="checkbox"/>	<input type="checkbox"/>	<input type="checkbox"/>	<input type="checkbox"/>	<input type="checkbox"/>	<input type="checkbox"/>	<input type="checkbox"/>	<input type="checkbox"/>	<input type="checkbox"/>	<input type="checkbox"/>	<input type="checkbox"/>	<input type="checkbox"/>	<input type="checkbox"/>	<input type="checkbox"/>	<input type="checkbox"/>	<input checked="" type="checkbox"/>	<input checked="" type="checkbox"/>	<input type="checkbox"/>	<input type="checkbox"/>	<input type="checkbox"/>	<input type="checkbox"/>	<input type="checkbox"/>	<input type="checkbox"/>	<input type="checkbox"/>	Enabled	Apply
2		<input type="checkbox"/>	<input type="checkbox"/>	<input type="checkbox"/>	<input type="checkbox"/>	<input type="checkbox"/>	<input type="checkbox"/>	<input type="checkbox"/>	<input type="checkbox"/>	<input type="checkbox"/>	<input type="checkbox"/>	<input type="checkbox"/>	<input type="checkbox"/>	<input type="checkbox"/>	<input type="checkbox"/>	<input type="checkbox"/>	<input type="checkbox"/>	<input type="checkbox"/>	<input type="checkbox"/>	<input type="checkbox"/>	<input type="checkbox"/>	<input type="checkbox"/>	<input type="checkbox"/>	<input type="checkbox"/>	<input type="checkbox"/>	Disabled	Apply
3		<input type="checkbox"/>	<input type="checkbox"/>	<input type="checkbox"/>	<input type="checkbox"/>	<input type="checkbox"/>	<input type="checkbox"/>	<input type="checkbox"/>	<input type="checkbox"/>	<input type="checkbox"/>	<input type="checkbox"/>	<input type="checkbox"/>	<input type="checkbox"/>	<input type="checkbox"/>	<input type="checkbox"/>	<input type="checkbox"/>	<input type="checkbox"/>	<input type="checkbox"/>	<input type="checkbox"/>	<input type="checkbox"/>	<input type="checkbox"/>	<input type="checkbox"/>	<input type="checkbox"/>	<input type="checkbox"/>	<input type="checkbox"/>	Disabled	Apply
4		<input type="checkbox"/>	<input type="checkbox"/>	<input type="checkbox"/>	<input type="checkbox"/>	<input type="checkbox"/>	<input type="checkbox"/>	<input type="checkbox"/>	<input type="checkbox"/>	<input type="checkbox"/>	<input type="checkbox"/>	<input type="checkbox"/>	<input type="checkbox"/>	<input type="checkbox"/>	<input type="checkbox"/>	<input type="checkbox"/>	<input type="checkbox"/>	<input type="checkbox"/>	<input type="checkbox"/>	<input type="checkbox"/>	<input type="checkbox"/>	<input type="checkbox"/>	<input type="checkbox"/>	<input type="checkbox"/>	<input type="checkbox"/>	Disabled	Apply
5		<input type="checkbox"/>	<input type="checkbox"/>	<input type="checkbox"/>	<input type="checkbox"/>	<input type="checkbox"/>	<input type="checkbox"/>	<input type="checkbox"/>	<input type="checkbox"/>	<input type="checkbox"/>	<input type="checkbox"/>	<input type="checkbox"/>	<input type="checkbox"/>	<input type="checkbox"/>	<input type="checkbox"/>	<input type="checkbox"/>	<input type="checkbox"/>	<input type="checkbox"/>	<input type="checkbox"/>	<input type="checkbox"/>	<input type="checkbox"/>	<input type="checkbox"/>	<input type="checkbox"/>	<input type="checkbox"/>	<input type="checkbox"/>	Disabled	Apply
6		<input type="checkbox"/>	<input type="checkbox"/>	<input type="checkbox"/>	<input type="checkbox"/>	<input type="checkbox"/>	<input type="checkbox"/>	<input type="checkbox"/>	<input type="checkbox"/>	<input type="checkbox"/>	<input type="checkbox"/>	<input type="checkbox"/>	<input type="checkbox"/>	<input type="checkbox"/>	<input type="checkbox"/>	<input type="checkbox"/>	<input type="checkbox"/>	<input type="checkbox"/>	<input type="checkbox"/>	<input type="checkbox"/>	<input type="checkbox"/>	<input type="checkbox"/>	<input type="checkbox"/>	<input type="checkbox"/>	<input type="checkbox"/>	Disabled	Apply

**Note:** It is only valid to set up at most 8 member ports of any one trunk group and a port can be a member of only one trunk group at a time.

The GbE Interconnect Switch supports up to six trunk groups. Trunks are groups of ports that are banded together to form a single, logical, high-bandwidth data pipe.

You can change the following parameters:

- **Name**—Type the user-assigned name of the trunk group.
- **Port Members**—Check the number of ports that will be members of the trunk group.
- **State**—Choose to enable or disable the trunk group.

To create or modify a trunk group:

1. Type a name in the **Name** field.
2. In the **Member Ports** area, check the ports that will compose the port trunk.
3. Change the **State** field to **Enabled**.
4. Click **Apply**.

**NOTE:** To save the configuration settings permanently, you must enter them into NVRAM using the **Save Changes** option on the **Maintenance** menu. Refer to the section, “Saving Changes,” earlier in this chapter.

## Configuring IGMP Snooping

When you select **IGMP Snooping** from the **Configuration** menu, the following screen is displayed.

IGMP Snooping Settings						
VLAN ID	State	Querier State	Robustness Variable	Query Interval	Max Response	Add/Modify
1	Enabled	Non-Querier	2	125	10	Apply

IGMP Snooping Setup Table					
VID	VLAN Name	State	Age Out	Querier State	Delete
1	DEFAULT_VLAN	Enabled	260	Non-Querier	X

Internet Group Management Protocol (IGMP) Snooping allows the GbE Interconnect Switch to recognize IGMP queries and reports sent between network stations or devices and an IGMP host. When enabled for IGMP Snooping, the GbE Interconnect Switch can open or close a port to a specific device based on IGMP messages passing through the GbE Interconnect Switch.

You can change the following parameters:

- **VLAN ID**—Select a VID number in this field.
- **State**—Choose to enable or disable the IGMP settings.
- **Querier State**—Select the IGMP version that will be used by the IGMP interface when making queries. Select from **Non-Querier**, **V1-Querier**, and **V2-Querier**.
- **Robustness Variable**—This is a tuning variable that allows you to configure the acceptable number of packets that may be lost. Type a value between 1 and 255, with larger values being specified for subnets that are expected to lose larger numbers of packets.
- **Query Interval**—Type a value between 1 and 65,500 seconds to specify the length of time between sending IGMP queries. The default is 125 seconds.
- **Max Response**—Type the maximum amount of time allowed before sending an IGMP response report. The range is 1 to 25 seconds.

To set up IGMP Snooping:

1. Type a VID number in the **VLAN ID** field.
2. Select **Enabled** in the **State** field.
3. Select the desired setting in the **Querier State** field.
4. Type a value between 1 and 255 in the **Robustness Variable** field. The default is 2.
5. Type a value between 1 and 65,500 seconds in the **Query Interval** field.

6. Type a value between 1 and 25 seconds in the **Max Response** field.
7. Click **Apply**.

**NOTE:** To save the configuration settings permanently, you must enter them into NVRAM using the **Save Changes** option on the **Maintenance** menu. Refer to the section, “Saving Changes,” earlier in this chapter.

## Configuring Spanning Tree Protocol Settings

The GbE Interconnect Switch supports the 801.2d Spanning Tree Protocol (STP), which allows you to create alternative paths (with multiple switches or other types of bridges) in your network.

When you select **STP Switch Settings** from the **Spanning Tree** menu, the following screen is displayed.

Switch Spanning Tree Settings	
Spanning Tree Protocol	Disabled ▾
Time Since Topology Changes(Sec)	26112
Topology Change Count	0
Bridge ID	80000080c824371a
Designated Root	0080c824371a
Cost to Root	0
Root Port	0
Root Priority(Sec)	32768
Bridge Max Age (6-40 Sec)	<input type="text" value="20"/>
Bridge Hello Time (1-10 Sec)	<input type="text" value="2"/>
Bridge Forward Delay (4-30 Sec)	<input type="text" value="15"/>
Bridge Priority (0-65535 Sec)	<input type="text" value="32768"/>
<input type="button" value="Apply"/>	
<p><i>Note: <math>2 * (\text{Forward Delay} - 1) \geq \text{Max Age}</math>,  <math>\text{Max Age} \geq 2 * (\text{Hello Time} + 1)</math></i></p>	

You can change the following STP parameters:

- **Spanning Tree Protocol**—Choose to enable or disable the STP setting.
- **Bridge Max Age (6–40 Sec)**—Type the maximum age. The range is 6 to 40 seconds. When the maximum age is reached, if a Bridge Protocol Data Unit (BPDU) has still not been received from the Root Bridge, your GbE Interconnect Switch will start sending its own BPDU to all other switches for permission to become the Root Bridge. If your GbE Interconnect Switch has the lowest bridge identifier, it will become the Root Bridge.

- **Bridge Hello Time (1–10 Sec)**—Type the hello time. The range is 1 to 10 seconds. This time is the interval between two transmissions of BPDU packets sent by the Root Bridge to tell all other switches that it is indeed the Root Bridge. If you set a hello time for your GbE Interconnect Switch and it is not the Root Bridge, the default hello time will be used until your GbE Interconnect Switch becomes the Root Bridge.
- **Bridge Forward Delay (4–30 Sec)**—Type the forward delay time. The range is 4 to 30 seconds. This interval is the time any port on the GbE Interconnect Switch spends in the listening state while moving from the blocking state to the forwarding state.
- **Bridge Priority (0–65535 Sec)**—Type the bridge priority. The range is from 0 to 65,535. Zero is equal to the highest bridge priority.

Click **Apply** after making changes to the settings.

**NOTE:** To save the configuration settings permanently, you must enter them into NVRAM using the **Save Changes** option on the **Maintenance** menu. Refer to the section, “Saving Changes,” earlier in this chapter.



## Configuring Spanning Tree Protocol Port Settings

When you select **STP Port Settings** from the **Spanning Tree** menu, the following screen is displayed.

**STP Port Settings**

From	To	State	Cost(1~65535)	Priority(0~255)	ByPass	Apply
Port 1	Port 1	Disabled	0	0	No	Apply

**The STP Port Informations**

Port	Connection	STP Status	Cost	Priority	ByPass	Port State
1	---	Enabled	19	128	Yes	Disabled
2	---	Enabled	19	128	Yes	Disabled
3	---	Enabled	19	128	Yes	Disabled
4	---	Enabled	19	128	Yes	Disabled
5	---	Enabled	19	128	Yes	Disabled
6	---	Enabled	19	128	Yes	Disabled
7	---	Enabled	19	128	Yes	Disabled
8	---	Enabled	19	128	Yes	Disabled
9	---	Enabled	19	128	Yes	Disabled
10	---	Enabled	19	128	Yes	Disabled
11	---	Enabled	19	128	Yes	Disabled
12	---	Enabled	19	128	Yes	Disabled
13	---	Enabled	19	128	Yes	Disabled
14	---	Enabled	19	128	Yes	Disabled
15	---	Enabled	19	128	Yes	Disabled
16	---	Enabled	19	128	Yes	Disabled
17	---	Enabled	19	128	No	Disabled
18	---	Enabled	19	128	No	Disabled
19	---	Enabled	19	128	No	Disabled
20	---	Enabled	19	128	No	Disabled
21	---	Enabled	4	128	No	Disabled
22	---	Enabled	4	128	No	Disabled
23	100M/Full/None	Enabled	19	128	No	Forwarding
24	---	Enabled	19	128	No	Disabled

The **STP Port Settings** window allows you to configure Spanning Tree Protocol functions for individual ports.

You can change the following parameters:

- **From**—Select the first port to be configured.
- **To**—Select the last port to be configured.
- **State**—Choose the STP state for the port, either **Enabled** or **Disabled**.
- **Cost (1–65535)**—Type a port cost between 1 and 65,535. The lower the cost, the greater the probability that the port will be chosen as the designated port to forward packets.
- **Priority (0–255)**—Type a port priority between 0 to 255. The lower the priority, the greater the probability that the port will be chosen as the root port.

- **ByPass**—Choose **Yes** or **No**. The bypass sets the forward delay timer to zero, thus bypassing the waiting time before the listening state. (This procedure is also known as fast forward.)

Click **Apply** after making changes to the settings.

**NOTE:** To save the configuration settings permanently, you must enter them into NVRAM using the **Save Changes** option on the **Maintenance** menu. Refer to the section, “Saving Changes,” earlier in this chapter.

### Configuring Unicast Filtering

The **Static Filtering Table** menu allows you to change the parameters for unicast filtering and multicast filtering.

When you select **Unicast Filtering** from the **Static Filtering Table** menu, the following screen is displayed.

The screenshot displays two web-based forms. The top form, titled "Add Unicast Filtering", has a table with columns for MAC Address, VID, Type, and PortMap (ports 1-24). The Type dropdown is set to "Permanent". The PortMap row shows port 1 selected. An "Apply" button is visible. The bottom form, titled "Unicast Filtering Table", has a similar table structure but includes a "Remove" column.

The **Add Unicast Filtering** window allows you to set up static packet filtering on the GbE Interconnect Switch.

You can change the following parameters:

- **MAC Address**—Type the MAC address from which packets will be statically filtered.
- **VID**—Type the VID number of the VLAN to which the MAC address belongs.
- **Type**—Choose the filter type, either **Permanent** or **DeleteOnReset**.
- **Port Map**—Select the port on which the MAC address resides.

Click **Apply** after making changes to the settings.

**NOTE:** To save the configuration settings permanently, you must enter them into NVRAM using the **Save Changes** option on the **Maintenance** menu. Refer to the section, “Saving Changes,” earlier in this chapter.

## Configuring Multicast Filtering

When you select **Multicast Filtering** from the **Static Filtering Table** menu, the following screen is displayed.

The screenshot displays two windows from a web-based management interface. The top window is titled "Add Multicast Filtering" and contains a form with the following fields:

- MAC Address**: A text input field.
- VID**: A text input field.
- Type**: A dropdown menu currently set to "Permanent".
- PortMap**: A section with two rows of checkboxes. The first row is labeled "State" and the second "Egress". Both rows have checkboxes for ports 1 through 24. The "Apply" button is located to the right of the "Egress" row.

The bottom window is titled "Multicast Filtering Table" and contains a table with the following columns:

- MAC Address**
- VID**
- Type**
- PortMap**: A sub-section with a "State" row and checkboxes for ports 1 through 24.
- Remove**: A button for each row.

The **Add Multicast Filtering** window allows you to set up multicast filtering on the GbE Interconnect Switch.

You can change the following parameters:

- **MAC Address**—Type the MAC address of the static source of multicast packets.
- **VID**—Type the VID number of the VLAN to which the MAC address belongs.
- **Type**—Choose the filter type, either **Permanent** or **DeleteOnReset**.
- **Port Map**—Select the ports that will be members of the static multicast group and ports that have no restrictions from joining dynamically.

Click **Apply** after making changes to the settings.

**NOTE:** To save the configuration settings permanently, you must enter them into NVRAM using the **Save Changes** option on the **Maintenance** menu. Refer to the section, "Saving Changes," earlier in this chapter.

## Configuring the Static VLAN Entry

The **VLAN** menu allows you to configure the following:

- Static VLAN entry
- Port VLAN ID (PVID)

When you select **Static VLAN Entry** from the **VLAN** menu, the following screen is displayed.

802.1Q Static VLANs			
VLAN ID (VID)	VLAN Name	Add	Delete
1	DEFAULT_VLAN	Modify	X

The **802.1Q Static VLANs** window allows you to create or delete entries to the 802.1Q Static VLAN table.

To add an entry to this table, click **Add** and then fill in the appropriate information in the following window. To modify an entry, click **Modify** beside the appropriate VID. To delete an entry, click the icon in the **Delete** column.

802.1Q Static VLAN Setup																											
VID	1																										
VLAN Name	DEFAULT_VLAN																										
Port	1	2	3	4	5	6	7	8	9	10	11	12	13	14	15	16	17	18	19	20	21	22	23	24	SP1	SP2	
Tag	<input type="checkbox"/>	<input type="checkbox"/>	<input type="checkbox"/>	<input type="checkbox"/>	<input type="checkbox"/>	<input type="checkbox"/>	<input type="checkbox"/>	<input type="checkbox"/>	<input type="checkbox"/>	<input type="checkbox"/>	<input type="checkbox"/>	<input type="checkbox"/>	<input type="checkbox"/>	<input type="checkbox"/>	<input type="checkbox"/>	<input type="checkbox"/>	<input type="checkbox"/>	<input type="checkbox"/>	<input type="checkbox"/>	<input type="checkbox"/>	<input type="checkbox"/>	<input type="checkbox"/>	<input type="checkbox"/>	<input type="checkbox"/>	<input type="checkbox"/>	<input type="checkbox"/>	<input type="checkbox"/>
None	<input type="radio"/>	<input type="radio"/>	<input type="radio"/>	<input type="radio"/>	<input type="radio"/>	<input type="radio"/>	<input type="radio"/>	<input type="radio"/>	<input type="radio"/>	<input type="radio"/>	<input type="radio"/>	<input type="radio"/>	<input type="radio"/>	<input type="radio"/>	<input type="radio"/>	<input type="radio"/>	<input type="radio"/>	<input type="radio"/>	<input type="radio"/>	<input type="radio"/>	<input type="radio"/>	<input type="radio"/>	<input type="radio"/>	<input type="radio"/>	<input type="radio"/>	<input type="radio"/>	<input type="radio"/>
Egress	<input checked="" type="radio"/>	<input checked="" type="radio"/>	<input checked="" type="radio"/>	<input checked="" type="radio"/>	<input checked="" type="radio"/>	<input checked="" type="radio"/>	<input checked="" type="radio"/>	<input checked="" type="radio"/>	<input checked="" type="radio"/>	<input checked="" type="radio"/>	<input checked="" type="radio"/>	<input checked="" type="radio"/>	<input checked="" type="radio"/>	<input checked="" type="radio"/>	<input checked="" type="radio"/>	<input checked="" type="radio"/>	<input checked="" type="radio"/>	<input checked="" type="radio"/>	<input checked="" type="radio"/>	<input checked="" type="radio"/>	<input checked="" type="radio"/>	<input checked="" type="radio"/>	<input checked="" type="radio"/>	<input checked="" type="radio"/>	<input checked="" type="radio"/>	<input checked="" type="radio"/>	<input checked="" type="radio"/>
Forbidden	<input type="radio"/>	<input type="radio"/>	<input type="radio"/>	<input type="radio"/>	<input type="radio"/>	<input type="radio"/>	<input type="radio"/>	<input type="radio"/>	<input type="radio"/>	<input type="radio"/>	<input type="radio"/>	<input type="radio"/>	<input type="radio"/>	<input type="radio"/>	<input type="radio"/>	<input type="radio"/>	<input type="radio"/>	<input type="radio"/>	<input type="radio"/>	<input type="radio"/>	<input type="radio"/>	<input type="radio"/>	<input type="radio"/>	<input type="radio"/>	<input type="radio"/>	<input type="radio"/>	<input type="radio"/>
																										Apply	

The **802.1Q Static VLAN Setup** window allows you to change the following parameters for each VLAN ID (VID):

- **VID**—Allows you to type the VLAN ID number of the VLAN you want to add. The range is 1 to 4094. This field is grayed out in the **Modify** mode.
- **VLAN Name**—Allows you to type the name of the VLAN that is being created.
- **Tag**—Specifies the port as either 802.1Q tagging or 802.1Q untagging. Click the check box to designate the port as tagging.
- **None**—Allows you to select the radio button to specify that the port is **not** a static member of the VLAN, but with no restrictions for joining the VLAN dynamically through GVRP.

- **Egress**—Allows you to select the radio button to specify that the port is a static member of the VLAN. Egress member ports transmit traffic for the VLAN.
- **Forbidden**—Specifies the port as not being a member of the VLAN and that the port is forbidden from dynamically becoming a member of the VLAN.

**NOTE:** Characteristics of DEFAULT\_VLAN include:

- DEFAULT\_VLAN is an IEEE 802.1Q Static VLAN with VID equal to 1.
- DEFAULT\_VLAN cannot be deleted.
- The VID cannot be changed. The VID that is equal to 1 is reserved for DEFAULT\_VLAN.
- The VLAN name can be changed to any other valid VLAN name.
- You cannot delete a port from DEFAULT\_VLAN, unless it is a member of another 802.1Q VLAN.
- You cannot forbid a port from DEFAULT\_VLAN, unless it is a member of another 802.1Q VLAN.
- If a port is deleted from the only 802.1Q VLAN of which it is a member, then it will automatically become a member of DEFAULT\_VLAN as an untagged, egress port.
- If a port is assigned to a user-created 802.1Q VLAN, and is **not** a tagged egress port member of DEFAULT\_VLAN (in other words, it is an untagged egress port), then it will be deleted automatically from DEFAULT\_VLAN.
- A tagged egress port of DEFAULT\_VLAN will not be deleted from DEFAULT\_VLAN, when it is assigned to another user-created 802.1Q VLAN.

To configure an 802.1Q static VLAN entry:

1. Type the VLAN ID in the **VID** field.
2. Type the VLAN name in the **VLAN Name** field.
3. Select **Tag** if you want a member port to be a tagging port. Leave it unselected if you do not want it to be a tagging port.
4. Click **None** if you do not want a port to belong to the VLAN, or click **Egress** to statically set a port to belong to a VLAN.
5. Click **Apply** to let the changes take effect.

**NOTE:** To save the configuration settings permanently, you must enter them into NVRAM using the **Save Changes** option on the **Maintenance** menu. Refer to the section, “Saving Changes,” earlier in this chapter.

## Configuring the Port VLAN ID

When you select **Port VLAN ID (PVID)** from the **VLANs** menu, the following screen is displayed.

**802.1Q Port Settings**

From	To	PVID	Ingress	GVRP	Apply
Port 1	Port 1	1	Off	Off	Apply

**802.1Q Port Table**

Port	PVID	Ingress	GVRP
1	1	Off	Off
2	1	Off	Off
3	1	Off	Off
4	1	Off	Off
5	1	Off	Off
6	1	Off	Off
7	1	Off	Off
8	1	Off	Off
9	1	Off	Off
10	1	Off	Off
11	1	Off	Off
12	1	Off	Off
13	1	Off	Off
14	1	Off	Off
15	1	Off	Off
16	1	Off	Off
17	1	Off	Off
18	1	Off	Off
19	1	Off	Off
20	1	Off	Off

The **802.1Q Port Settings** window allows you to assign a Port VLAN ID (PVID) number, enable or disable the ingress filtering check, and enable or disable GVRP for individual ports.

Ingress filtering means that a receiving port will check to see if the port is a member of the VLAN ID in the packet before forwarding the packet.

GVRP is a Generic Attribute Registration Protocol (GARP) application that provides 802.1Q-compliant VLAN pruning and dynamic VLAN creation on 802.1Q trunk ports. With GVRP, the GbE Interconnect Switch can exchange VLAN configuration information with other GVRP switches, prune unnecessary broadcast and unknown unicast traffic, and dynamically create and manage VLANs on switches connected through 802.1Q trunk ports.

**NOTE:** Characteristics of a PVID include:

- By default, the PVID of all ports is the same as the VID of DEFAULT\_VLAN, which is equal to 1.
- When a user creates an untagged 802.1Q VLAN and assigns a port, the PVID will be changed to the VID of that 802.1Q VLAN.
- For a tagged port, the PVID will be the same as the VID of the IEEE 802.1Q VLAN to which this port was first assigned.
- If the first IEEE 802.1Q VLAN to which the tagged port is assigned is deleted, the PVID will change to that of the second IEEE 802.1Q VLAN to which the port was assigned.
- The PVID of a port can only be set to a VID of a VLAN for which the port is already a member.

You can change the following parameters:

- **From** and **To**—Select the range of ports to be included in the settings.
- **PVID**—Type the PVID. This tuning variable allows for subnetworks that are expected to lose a large number of packets. The PVID is used by the port to tag outgoing, untagged packets and to make filtering decisions about incoming packets. If the port is specified as tagging, and an untagged packet is forwarded to the port for transmission, the port will add an 802.1Q tag using the PVID to write the VID in the tag. When the packet arrives at its destination, the receiving device uses the PVID to make VLAN forwarding decisions. If the port receives a packet, and ingress filtering is enabled, the port compares the VID of the incoming packet to its PVID. If the two are unequal, the port drops the packet. If the two are equal, the port receives the packet.
- **Ingress Filter**—Select **Off** or **On** to specify the port that checks the VID of incoming packets against its VID or PVID. If the two are equal, the port receives the packet. If the two are unequal, the port drops the packet. This setting is used to limit traffic to a single VLAN.
- **GVRP**—Select **Off** or **On** to enable or disable GARP VLAN Registration Protocol.

Click **Apply** after making changes to the settings.

**NOTE:** To save the configuration settings permanently, you must enter them into NVRAM using the **Save Changes** option on the **Maintenance** menu. Refer to the section, “Saving Changes,” earlier in this chapter.

## Configuring the Restart Ingress Bandwidth Settings

When you select **Restart Ingress Bandwidth** from the **Port Bandwidth** menu, the following screen is displayed.

Ingress Bandwidth Settings				
Port Num	Ingress Bandwidth(1~127 Units)	Add/Modify		
Port 1	1	Apply		

Ingress Bandwidth Setup Table				
Port	Units	KBytes	Port Speed	Delete

To configure ingress bandwidth for a specific port:

1. Select the desired port in the **Port Num** field.
2. Type a number between 1 and 127 in the **Ingress Bandwidth (1–127 Units)** field.
3. Click **Apply**.
4. Select **Restart System** from the **Maintenance** menu.
5. Select **Yes** to save the settings.
6. Click **Restart**. The system reboots and saves your settings.

**NOTE:** To delete an entry, click the icon in the **Delete** column on the **Ingress Bandwidth Setup Table**.

## Displaying the Current Ingress Bandwidth Table

When you select **Current Ingress Bandwidth** from the **Port Bandwidth** menu, the following screen is displayed.

Current Ingress Bandwidth Table			
Port	Units	KBytes	Port Speed

**Current Ingress Bandwidth Table** is a read-only screen displaying current ingress bandwidth information.



## Configuring the Restart Egress Bandwidth Settings

When you select **Restart Egress Bandwidth** from the **Port Bandwidth** menu, the following screen is displayed.

Egress Bandwidth Settings		
Port Num	Egress Bandwidth(1~127 Units)	Add/Modify
Port 1	1	Apply

Egress Bandwidth Setup Table				
Port	Units	K.Bytes	Port Speed	Delete

To configure egress bandwidth for a specific port:

1. Select the desired port in the **Port Num** field.
2. Type a number between 1 and 127 in the **Egress Bandwidth (1–127 Units)** field.
3. Click **Apply** to save the change or addition.
4. Select **Restart System** from the **Maintenance** menu.
5. Select **Yes** to save the settings.
6. Click **Restart**. The system reboots and saves your settings.

**NOTE:** To delete an entry, click the icon in the **Delete** column on the **Egress Bandwidth Setup Table**.

## Displaying the Current Egress Bandwidth Table

When you select **Current Egress Bandwidth** from the **Port Bandwidth** menu, the following screen is displayed.

Current Egress Bandwidth Table			
Port	Units	K.Bytes	Port Speed

**Current Egress Bandwidth Table** is a read-only screen displaying current egress bandwidth information.

## Configuring the Threshold of Broadcast

When you select **Threshold of Broadcast** from the **Configuration** menu, the following screen is displayed.

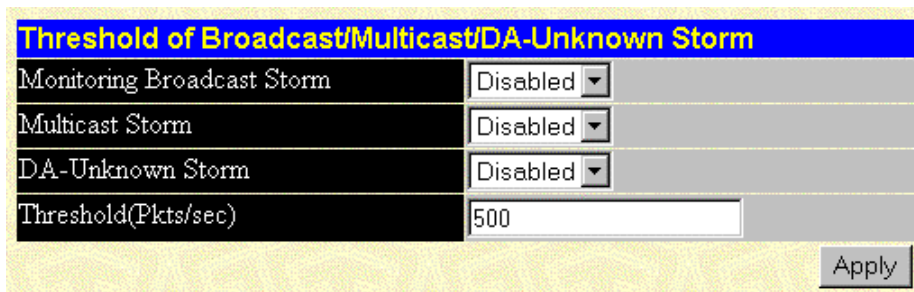

Threshold of Broadcast/Multicast/DA-Unknown Storm	
Monitoring Broadcast Storm	Disabled ▾
Multicast Storm	Disabled ▾
DA-Unknown Storm	Disabled ▾
Threshold(Pkts/sec)	500
<input type="button" value="Apply"/>	

The GbE Interconnect Switch allows you to set the threshold for three types of storms: broadcast, multicast, and one where the destination address is unknown. The higher the threshold, the more packets the GbE Interconnect Switch can accept per second. If the threshold is exceeded, any additional packets received are dropped. Entering a low value means packets have a greater chance to exceed the threshold and be dropped from the GbE Interconnect Switch.

To set a threshold:

1. Select **Enabled** for the appropriate option.
2. Type a threshold value in the **Threshold(Pkts/sec)** field.
3. Click **Apply** to save the changes.

**NOTE:** To save the configuration settings permanently, you must enter them into NVRAM using the **Save Changes** option on the **Maintenance** menu. Refer to the section, “Saving Changes,” earlier in this chapter.

## Configuring the Port Priority

When you select **Port Priority** from the **Configuration** menu, the following screen is displayed.

**Default Port Priority assignment**

From	To	Priority(0-7)	Apply
Port 1 ▾	Port 1 ▾	0	Apply

**The Port Priority Table**

Port	Priority
1	0
2	0
3	0
4	0
5	0
6	0
7	0
8	0
9	0
10	0
11	0
12	0
13	0
14	0
15	0
16	0
17	0
18	0
19	0

The **Default Port Priority assignment** window allows you to set a default priority for packets that have not been assigned a priority value.

To set a default priority:

1. Select the appropriate port in the **From** and **To** fields.
2. Type the priority in the **Priority (0-7)** field.
3. Click **Apply** to save the changes.

**NOTE:** To save the configuration settings permanently, you must enter them into NVRAM using the **Save Changes** option on the **Maintenance** menu. Refer to the section, "Saving Changes," earlier in this chapter.

## Configuring the Class of Traffic

When you select **Class of Traffic** from the **Configuration** menu, the following screen is displayed.

Priority	Class
Priority-0	Class-0
Priority-1	Class-0
Priority-2	Class-1
Priority-3	Class-1
Priority-4	Class-2
Priority-5	Class-2
Priority-6	Class-3
Priority-7	Class-3

Apply

The **Configure Class of Traffic** window allows you to configure traffic class priority by specifying the class value, from 0 to 3, of the eight levels of priority of the GbE Interconnect Switch.

To set traffic class priority:

1. Select the class value for each priority.
2. Click **Apply** to save the changes.

**NOTE:** To save the configuration settings permanently, you must enter them into NVRAM using the **Save Changes** option on the **Maintenance** menu. Refer to the section, "Saving Changes," earlier in this chapter.

## Configuring the Class of Service

When you select **Class of Service** from the **Configuration** menu, the following screen is displayed.

Class of Service Configuration		
	Max. Packets	Max. Latency
Class-0	10	10
Class-1	10	10
Class-2	10	10
Class-3	10	10

Apply

The **Class of Service Configuration** window allows you to set the maximum number of packets and the maximum allowable time a packet stays in the CoS queue.

You can change the following parameters:

- **Max. Packets**—Type a value between 0 and 255. The Class of Service scheduling algorithm starts from the highest CoS for a given port, sends the maximum number of packets, then moves on to the next lower CoS. Entering zero instructs the GbE Interconnect Switch to continue processing packets until there are no more packets in the CoS transaction queue.
- **Max. Latency**—Type the maximum allowable time a packet stays in the CoS queue. The packets in this queue are not delayed more than the maximum allowable latency entered in this field. The timer is disabled when this field is set to zero. Each unit of this timer is equal to 17 microseconds.

Click **Apply** after making changes to the settings.

**NOTE:** To save the configuration settings permanently, you must enter them into NVRAM using the **Save Changes** option on the **Maintenance** menu. Refer to the section, “Saving Changes,” earlier in this chapter.

## Configuring Port Security

When you select **Port Security** from the **Configuration** menu, the following screen is displayed.

**Port Security Settings**

From	To	Admin State	Max. Address	Mode	Apply
Port 1	Port 1	Disabled	1	DeleteOnReset	Apply

**Port Security Table**

Port	Admin State	Max Learning Addr	Lock Address Mode
1	Disabled	1	DeleteOnReset
2	Disabled	1	DeleteOnReset
3	Disabled	1	DeleteOnReset
4	Disabled	1	DeleteOnReset
5	Disabled	1	DeleteOnReset
6	Disabled	1	DeleteOnReset
7	Disabled	1	DeleteOnReset
8	Disabled	1	DeleteOnReset
9	Disabled	1	DeleteOnReset
10	Disabled	1	DeleteOnReset
11	Disabled	1	DeleteOnReset
12	Disabled	1	DeleteOnReset
13	Disabled	1	DeleteOnReset
14	Disabled	1	DeleteOnReset
15	Disabled	1	DeleteOnReset
16	Disabled	1	DeleteOnReset
17	Disabled	1	DeleteOnReset
18	Disabled	1	DeleteOnReset
19	Disabled	1	DeleteOnReset
20	Disabled	1	DeleteOnReset
21	Disabled	1	DeleteOnReset
22	Disabled	1	DeleteOnReset
23	Disabled	1	DeleteOnReset
24	Disabled	1	DeleteOnReset

The **Port Security Settings** window is used to set up security for a port or a range of ports.

To set up security for a port or ports:

1. Select the range of ports in the **From** and **To** fields.
2. Choose **Enabled** in the **Admin State** field.
3. Type the maximum number of addresses in the **Max. Address** field.
4. Select the **Mode** that you want, either **Permanent** or **DeleteOnReset**.
5. Click **Apply** to apply your settings.

**NOTE:** To save the configuration settings permanently, you must enter them into NVRAM using the **Save Changes** option on the **Maintenance** menu. Refer to the section, “Saving Changes,” earlier in this chapter.

## Configuring Priority MAC Addresses

When you select **Priority MAC Addresses** from the **Configuration** menu, the following screens are displayed.

Setup Priority MAC Addresses				
VLAN ID	MAC Address	Priority Level	Look at	Add/Modify
1	00:00:00:00:00:00	0	Src. Addr	Apply

Priority MAC Address Table				
VID	MAC Address	Priority	Look at	Delete

The **Setup Priority MAC Addresses** window allows you to set up the priority, between 0 and 7 with 0 being the highest, for a specified MAC address.

To set the priority level for a MAC address:

1. Type the VLAN ID in the **VLAN ID** field.
2. Type the MAC address for which priority on the GbE Interconnect Switch is to be established in the **MAC Address** field.
3. Type the priority level for the MAC address in the **Priority Level** field. The range is from 0 to 7, with 0 being the highest priority.
4. In the **Look at** field, select the state under which the priority will be active. The options are:
  - **Dst. Addr**—Packets with the selected MAC address as their destination will be given the selected priority.
  - **Src. Addr**—Packets with the selected MAC address as their source will be given the selected priority.
  - **Either**—All packets with the selected MAC address will be given the selected priority.
5. Click **Apply** to apply the changes.

**NOTE:** To save the configuration settings permanently, you must enter them into NVRAM using the **Save Changes** option on the **Maintenance** menu. Refer to the section, "Saving Changes," earlier in this chapter.

## Configuring RS232 and SLIP

When you select **Configure RS232 and SLIP** from the **Configuration** menu, the following screens are displayed.

Serial Port Settings	
Baud Rate	9600
Data Bits	8
Parity	None
Stop Bits	1
Auto-Logout	Never
Serial Port For	Console

SLIP Settings	
Local IP Address	0.0.0.0
Remote IP Address	0.0.0.0
MTU	1006

Apply

The **Serial Port Settings** window allows you to configure the serial port of the GbE Interconnect Switch either through the console port or through use of the Telnet protocol. You can set the following features:

- **Baud Rate**—Select the rate at which data will be exchanged over the serial link. The default value is 9600 baud.
- **Data Bits**—Select the number of bits that will carry data over the serial link. The default value is 8 bits.
- **Stop Bits**—Select the number of bits that indicate when a serial word ends. The default value is 1 bit.
- **Auto-Logout**—Select the length of time a management session can be idle. When this time has expired, the management agent of the GbE Interconnect Switch will disconnect the user. The default value is 10 minutes.
- **Serial Port For**—Choose **Console** or **SLIP**.

The following SLIP settings display:

- **Local IP Address**—Local IP address of the SLIP connection.



- **Remote IP Address**—Remote IP address of the SLIP connection.
- **MTU**—Specifies the size of the transferring IP packets. The default value is 1006.

Click **Apply** after making changes to the settings.

**NOTE:** To save the configuration settings permanently, you must enter them into NVRAM using the **Save Changes** option on the **Maintenance** menu. Refer to the section, “Saving Changes,” earlier in this chapter.

## Configuring the Security IP

When you select **Security IP** from the **Management** menu, the following screen is displayed.

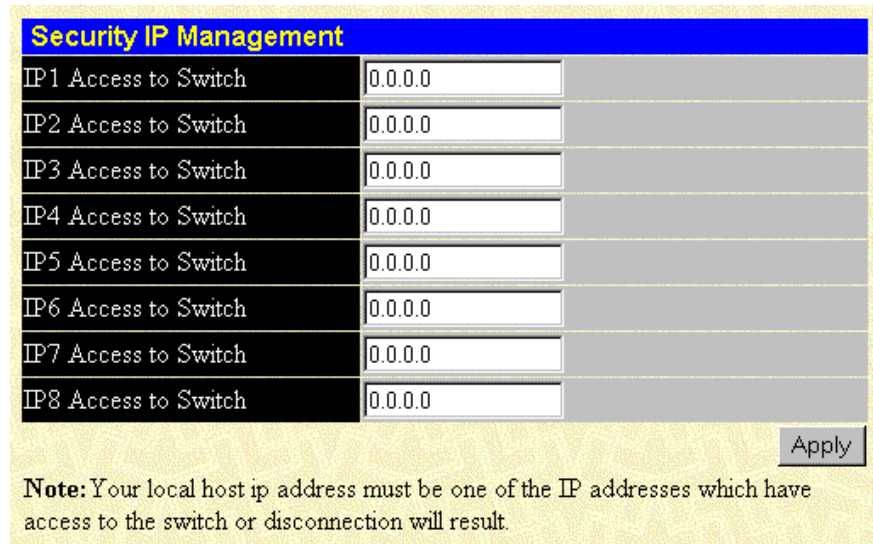

Security IP Management	
IP1 Access to Switch	0.0.0.0
IP2 Access to Switch	0.0.0.0
IP3 Access to Switch	0.0.0.0
IP4 Access to Switch	0.0.0.0
IP5 Access to Switch	0.0.0.0
IP6 Access to Switch	0.0.0.0
IP7 Access to Switch	0.0.0.0
IP8 Access to Switch	0.0.0.0

**Note:** Your local host ip address must be one of the IP addresses which have access to the switch or disconnection will result.

The **Security IP Management** window allows you to specify IP addresses that are allowed to access the GbE Interconnect Switch.

To specify which IP addresses are allowed to access the GbE Interconnect Switch:

1. Type the appropriate IP addresses.
2. Click **Apply**.

## Configuring the SNMP Manager

When you select **SNMP Manager** from the **Management** menu, the following screen is displayed.

Community String	Access Right	Status
public	Read-Only	Valid
private	Read-Write	Valid
	Read-Only	Invalid
	Read-Only	Invalid

Apply

The **SNMP Manager Configuration** window allows you to configure SNMP parameters.

You can change the following parameters:

- **Community String**—Type a user-defined SNMP community name.
- **Access Right**—Choose the access of **Read-Only** or **Read-Write** using the SNMP community name.
- **Status**—Set the status of the current community string to **Valid** or **Invalid**.

Click **Apply** after making changes to the settings.

**NOTE:** To save the configuration settings permanently, you must enter them into NVRAM using the **Save Changes** option on the **Maintenance** menu. Refer to the section, “Saving Changes,” earlier in this chapter.

## Configuring the Trap Manager

When you select **Trap Manager** from the **Management** menu, the following screen is displayed.

Trap Receiving Station	Community String	Status
0.0.0.0		Invalid
0.0.0.0		Invalid
0.0.0.0		Invalid
0.0.0.0		Invalid

Apply

The **SNMP Trap Manager Configuration** window allows you to set the trap receiving station, which runs a network management application to receive and store traps.

You can change the following parameters:

- **Trap Receiving Station**—Type the IP address of the trap receiving station.
- **Community String**—Type a user-defined SNMP community name.
- **Status**—Set the trap receiving station status to **Valid** or **Invalid**.

Click **Apply** after making changes to the settings.

**NOTE:** To save the configuration settings permanently, you must enter them into NVRAM using the **Save Changes** option on the **Maintenance** menu. Refer to the section, “Saving Changes,” earlier in this chapter.

## Setting Up and Managing User Accounts

When you select **User Accounts** from the **Management** menu, the following screen is displayed.

User Name	Access Right	Add
admin	Root	Modify
switchuser	User	Modify

The **User Account Management** window displays all current users for the GbE Interconnect Switch and their current access level.

The following information is displayed:

- **User Name**—Displays all current users for the GbE Interconnect Switch.

- **Access Right**—Displays the current access level assigned to each corresponding user. The available options are **User**, **User+**, or **Root**. A **Root** user has full read/write access, while a **User** has read only access. A **User+** has the same privileges as a **User**, but with the added ability to restart the GbE Interconnect Switch.
- **Add**—Adds a new user to the table.

The **User Account Modify Table** also is displayed. The **User Account Modify Table** allows you to add or delete user account information.

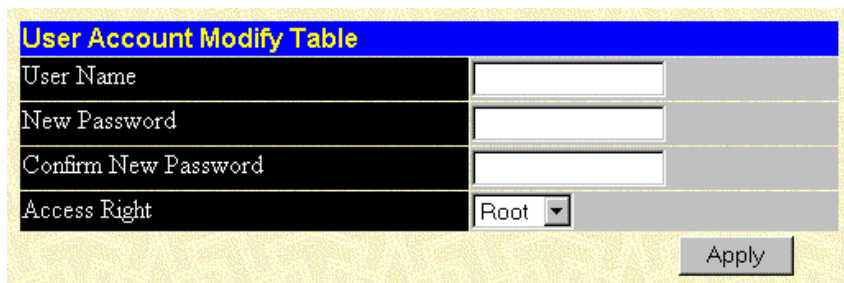

The screenshot shows a web interface titled "User Account Modify Table" with a blue header. Below the header is a form with four rows. The first three rows have text labels on the left and text input fields on the right: "User Name", "New Password", and "Confirm New Password". The fourth row has a text label "Access Right" on the left and a drop-down menu on the right showing "Root". At the bottom right of the form is an "Apply" button.

To add a user account:

1. Type the user name in the **User Name** field.
2. Type the user's password in the **New Password** field.
3. Type the new password a second time in the **Confirm Password** field.
4. Select one of the access levels from the **Access Right** drop-down menu.

**NOTE:** Refer to Table 2-1 in Chapter 2 for an explanation of access rights.

5. Click **Apply**.

**NOTE:** To save the configuration settings permanently, you must enter them into NVRAM using the **Save Changes** option on the **Maintenance** menu. Refer to the section, "Saving Changes," earlier in this chapter.

## Monitoring GbE Interconnect Switch Functions

The **Monitoring** menu has the following sections:

- Port Utilization
- Packets—Received (RX), UMB-cast (RX), Transmitted (TX)
- Errors—Received (RX) and Transmitted (TX)
- Size—Packet Size
- Trunk Utilization
- MAC Address Table
- IGMP Snooping Table
- Dynamic Group Registration
- VLAN Status Table

## Monitoring the GbE Interconnect Switch Using the Active Switch Graphic

At the right side of the main page, an active graphic of the GbE Interconnect Switch displays.

**NOTE:** Positioning the pointer on an RJ-45 connector or an LED displays the port number, and selecting an RJ-45 connector or an LED displays the port statistics.

Monitor the GbE Interconnect Switch status by using the following tools:

- Graphical LEDs display current link speed and activity of ports 1X through 24X.
- On Switch A, LEDs labeled 1X, 3X, 5X,...15X (odd numbers) represent NIC 1 (PXE capable) of server bays 1 through 8. LEDs labeled 2X, 4X, 6X,...16X (even numbers) represent NIC 2 of server bays 1 through 8.
- On Switch B, LEDs labeled 1X, 3X, 5X,...15X (odd numbers) represent iLO of server bays 1 through 8. LEDs labeled 2X, 4X, 6X,...16X (even numbers) represent NIC 3 of server bays 1 through 8.
- LEDs labeled 17X and 18X represent cross-connect ports.
- LEDs labeled 19X and 20X represent the Fast Ethernet uplinks.
- LEDs labeled 21X and 22X represent Gigabit Ethernet uplinks.
- RJ-45 connectors labeled 23X and 24X represent front panel ports meant for debugging and monitoring the GbE Interconnect Switch.

## Monitoring Port Utilization

When you select **Port Utilization** from the **Monitoring** menu, the following screen is displayed.

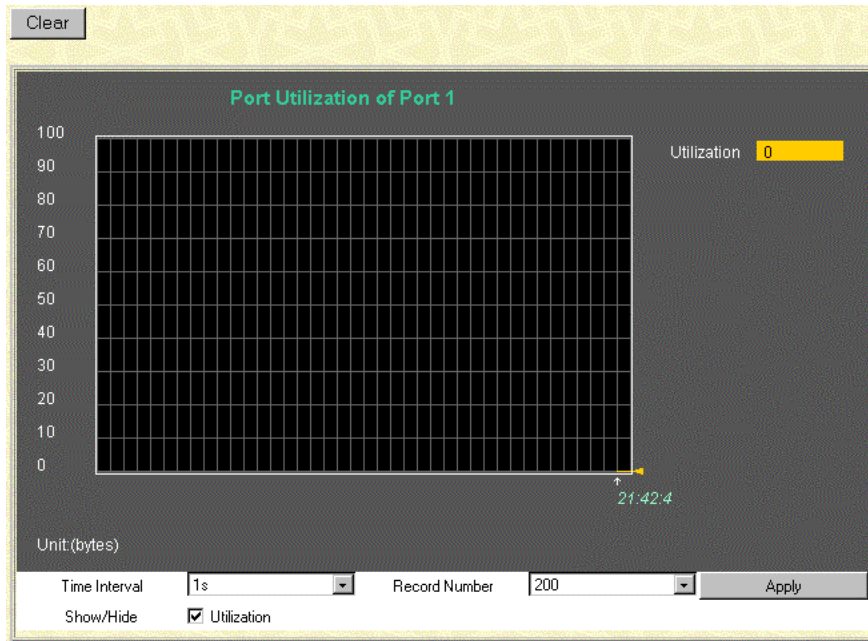

The **Port Utilization** window shows the percentage of the total available bandwidth being used on a specified port.

The following information is displayed:

- **Utilization**—Indicates the percentage of the total bandwidth being used on the specified port.
- **Time Interval**—The frequency at which the information on the screen is refreshed. The default is two seconds.
- **Record Number**—Indicates the number of polling attempts. The default is 200.
- **Show/Hide**—Shows or hides the line graph for utilization.

Click **Clear** to reset the counters.

## Monitoring Packets

The Web Manager allows various packet statistics to be viewed as either a line graph or a table. You can choose the type of graphic to display by clicking **View Table** or **View Line Chart**.

## Monitoring Received (RX) Packets

When you select **Received (RX) Packets** from the **Packets** menu, the following screens are displayed.

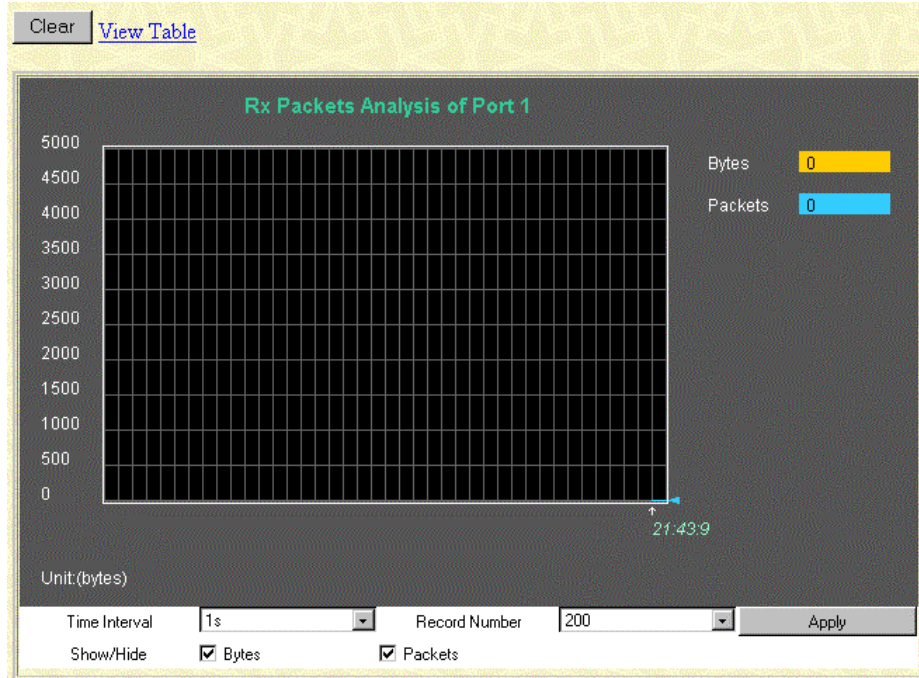

[View LineChart](#)

Packet Analysis of Port 1				
	Time Interval	1s	OK	
<b>Rx Packets</b>	Current	Total	Average	Peak
Bytes	0	0	0	0
Packets	0	0	0	0
<b>Rx Packets</b>	Current	Total	Average	Peak
Unicast	0	0	0	0
Multicast	0	0	0	0
Broadcast	0	0	0	0
<b>Tx Packets</b>	Current	Total	Average	Peak
Bytes	0	0	0	0
Packets	0	0	0	0

The **Rx Packets Analysis** window displays the number of bytes and packets received on the port.

The following information is displayed:

- **Time Interval**—The frequency at which the information on the screen is refreshed. The setting is between 1s and 60s, where “s” stands for seconds. The default value is one second.
- **Record Number**—Displays the number of times that the GbE Interconnect Switch will be polled. The setting can be between 20 and 200. The default value is 20.
- **Bytes**—Counts the number of bytes received on the port.
- **Packets**—Counts the number of packets received on the port.
- **Show/Hide**—Displays or hides bytes and packets information.

Click **Clear** to reset the counters.

### Monitoring UMB-cast (RX) Packets

When you select **UMB-cast (RX) Packets** from the **Packets** menu, the following screens are displayed.

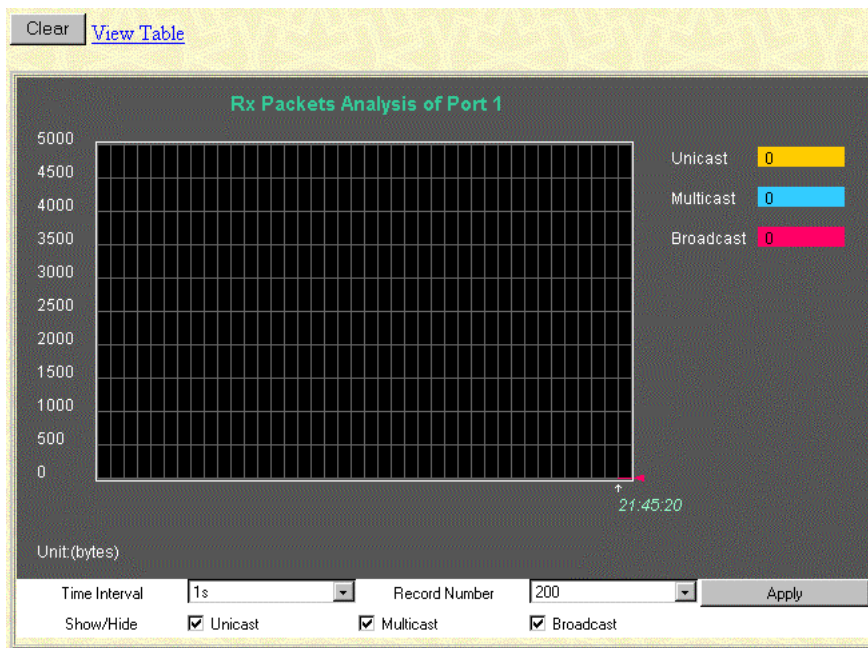



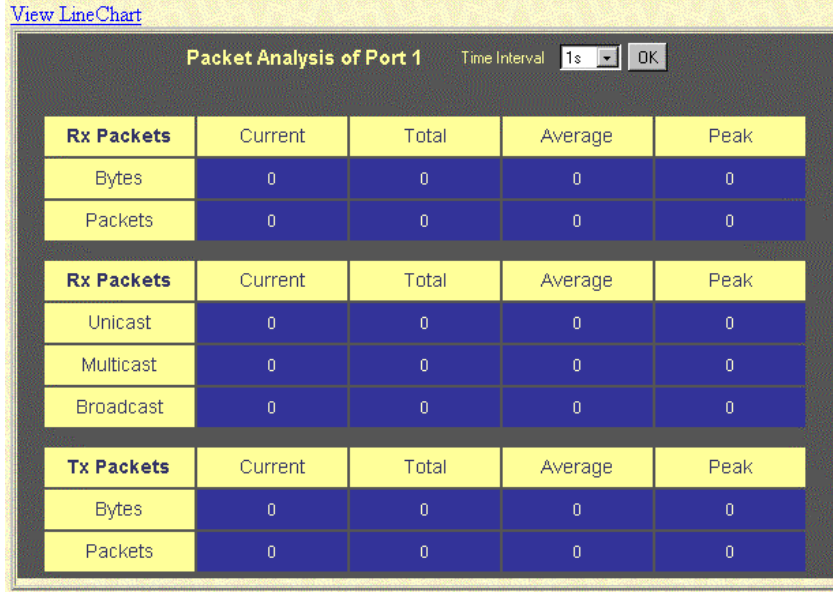

The **UMB-cast (RX) Packets** window displays the number of good bytes and packets that were received by a unicast, multicast, or broadcast address.

The following information is displayed:

- **Time Interval**—The frequency at which the information on the screen is refreshed. The setting can be between 1s and 60s, where “s” stands for seconds.
- **Record Number**—Displays the number of times the GbE Interconnect Switch will be polled. The setting can be between 20 and 200.
- **Unicast**—Counts the total number of good packets that were received by a unicast address.
- **Multicast**—Counts the total number of good packets that were received by a multicast address.
- **Broadcast**—Counts the total number of good packets that were received by a broadcast address.
- **Show/Hide**—Displays or hides unicast, multicast, or broadcast packets.

Click **Clear** to reset the counters.

## Monitoring Transmitted (TX) Packets

When you select **Transmitted (TX) Packets** from the **Packets** menu, the following screens are displayed.

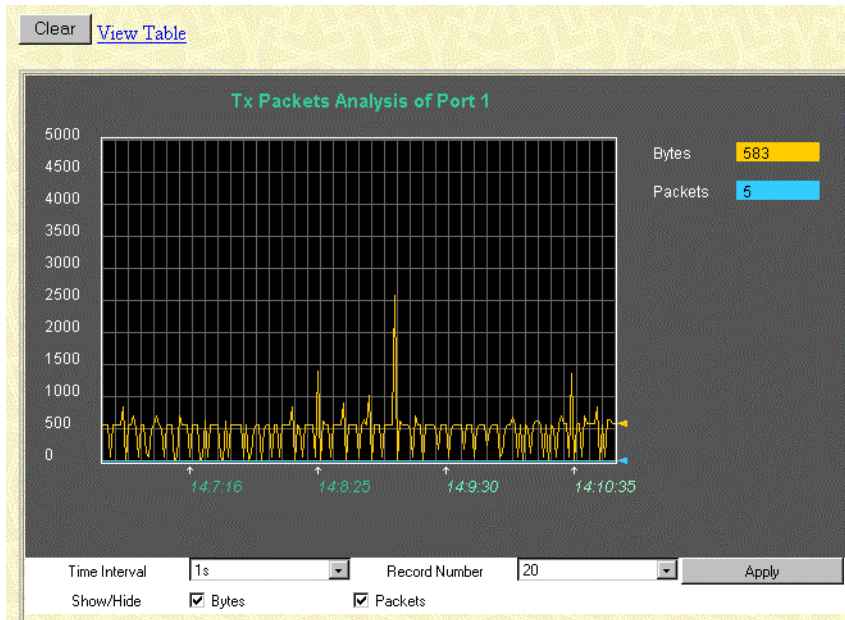

[View LineChart](#)

**Packet Analysis of Port 1** Time Interval: 1s OK

Rx Packets	Current	Total	Average	Peak
Bytes	0	0	0	0
Packets	0	0	0	0

Rx Packets	Current	Total	Average	Peak
Unicast	0	0	0	0
Multicast	0	0	0	0
Broadcast	0	0	0	0

Tx Packets	Current	Total	Average	Peak
Bytes	0	0	0	0
Packets	0	0	0	0

The **Tx Packets Analysis** window displays the number of bytes and packets successfully sent from the port.

The following information is displayed:

- **Time Interval**—The frequency at which the information on the screen is refreshed. The setting can be between 1s and 60s, where “s” stands for seconds. The default value is one second.
- **Record Number**—Displays the number of times the GbE Interconnect Switch will be polled. The setting can be between 20 and 200. The default value is 20.
- **Bytes**—Counts the number of bytes successfully sent from the port.
- **Packets**—Counts the number of packets successfully sent from the port.
- **Show/Hide**—Displays or hides bytes and packets information.

Click **Clear** to reset the counters.

## Monitoring Errors

The Web Manager allows port error statistics compiled by the management agent of the GbE Interconnect Switch to be viewed as either a line graph or a table. You can choose the type of graphic to display by clicking **View Table** or **View Line Chart**.

### Monitoring Received (RX) Errors

When you select **Received (RX) Errors** from the **Errors** menu, the following screens are displayed.

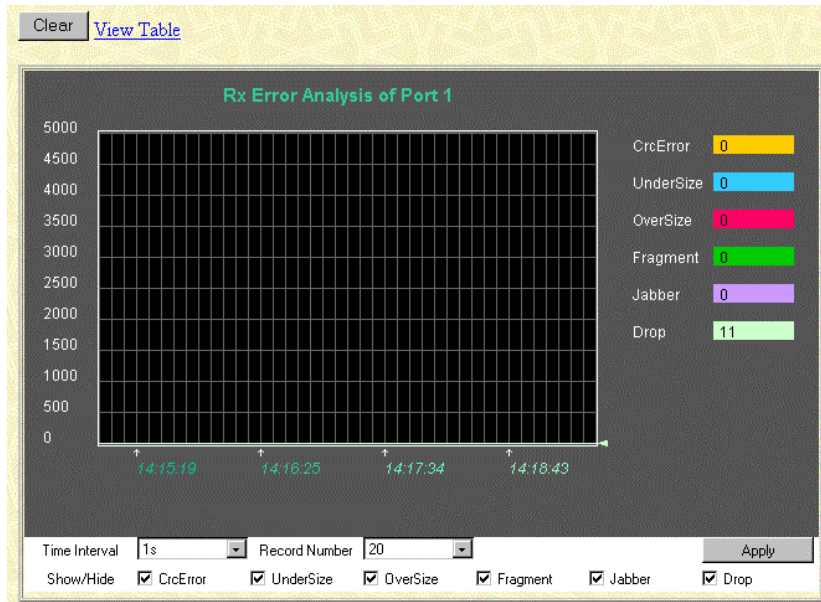

[View Line Chart](#)

**Packet Analysis of Port 1** Time Interval

Rx Error	Current	Total	Average	Peak
CrcError	0	0	0	2147495380
UnderSize	0	0	0	0
OverSize	0	1	0	2147589740
Fragment	0	0	0	2152299664
Jabber	0	0	0	2152299660
Drop	6	345160	6	2148922492

The **Rx Error Analysis** window displays the number of errors received.

The following information is displayed:

- **Time Interval**—The frequency at which the information on the screen is refreshed. The setting can be between 1s and 60s, where “s” stands for seconds. The default value is one second.
- **Record Number**—Displays the number of times the GbE Interconnect Switch will be polled. The setting can be between 20 and 200. The default value is 20.
- **CRCErrors**—Counts otherwise valid frames that did not end on a byte (octet) boundary.
- **UnderSize**—Displays the number of frames detected that are less than the minimum permitted frame size of 64 bytes and have a good CRC. Undersized frames usually indicate collision fragments, a normal network occurrence.
- **OverSize**—Counts packets received that were longer than 1518 octets, or if a VLAN frame, 1522 octets, and less than the MAX\_PKT\_LEN. Internally, MAX\_PKT\_LEN is equal to 1522.
- **Fragment**—Displays the number of packets less than 64 bytes with either bad framing or an invalid CRC. These packets are normally the result of collisions.
- **Jabber**—Displays the number of frames with lengths more than the MAX\_PKT\_LEN bytes. Internally, MAX\_PKT\_LEN is equal to 1522.
- **Drop**—Displays the number of frames that were dropped by this port since the last GbE Interconnect Switch reboot.
- **Show/Hide**—Displays or hides CrcError, UnderSize, OverSize, Fragment, Jabber, and Drop errors.

Click **Clear** to reset the counters.

## Monitoring Transmitted (TX) Errors

When you select **Transmitted (TX) Errors** from the **Errors** menu, the following screens are displayed.

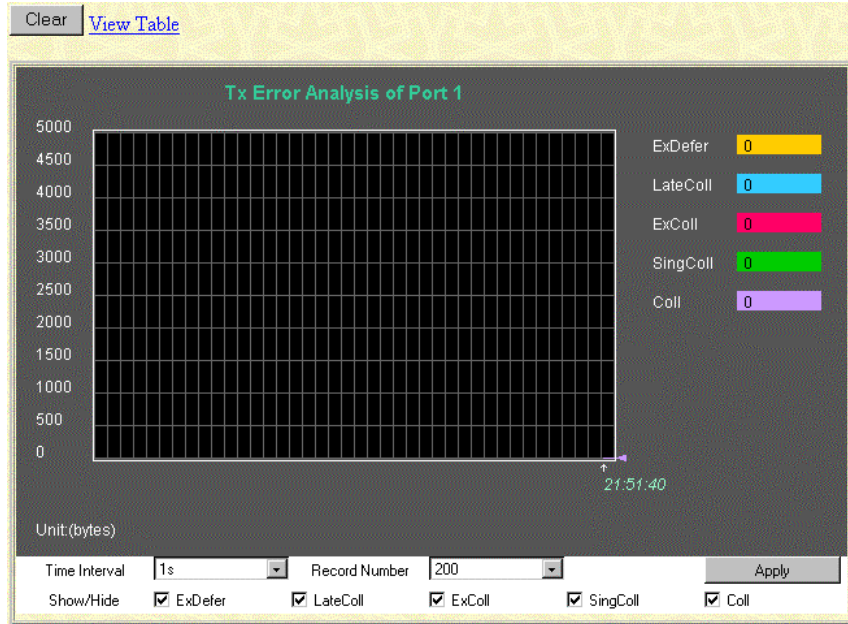

Packet Analysis of Port 1 Time Interval 1s OK

Tx Error	Current	Total	Average	Peak
ExDefer	0	0	0	0
LateColl	0	0	0	0
ExColl	0	0	0	0
SingColl	0	0	0	0
Coll	0	0	0	0

The **Tx Error Analysis** window displays the number of errors that occurred during transmission.

The following information is displayed:

- **Time Interval**—The frequency at which the information on the screen is refreshed. The setting can be between 1s and 60s, where “s” stands for seconds. The default value is one second.

- **Record Number**—Displays the number of times the GbE Interconnect Switch will be polled. This setting can be between 20 and 200. The default value is 20.
- **ExDefer**—Counts the number of frames for which the first transmission attempt on a particular interface was delayed because the medium was busy.
- **LateColl**—Counts the number of times that a collision is detected later than 512 bit-times into the transmission of a packet.
- **ExColl**—Counts the number of frames that experienced 16 collisions during transmission and were aborted.
- **SingColl**—Counts the number frames that experienced exactly one collision during transmission.
- **Coll**—Counts the number of collisions that occurred during the transmission of a frame.
- **Show/Hide**—Displays or hides ExDefer, LateColl, CRCError, SingColl, and Coll errors.

Click **Clear** to reset the counters.

## Monitoring Packet Size

The Web Manager allows packets received by the GbE Interconnect Switch, arranged in six groups, to be viewed as either a line graph or a table.

When you select **Packet Size** from the **Size** menu, the following screens are displayed.

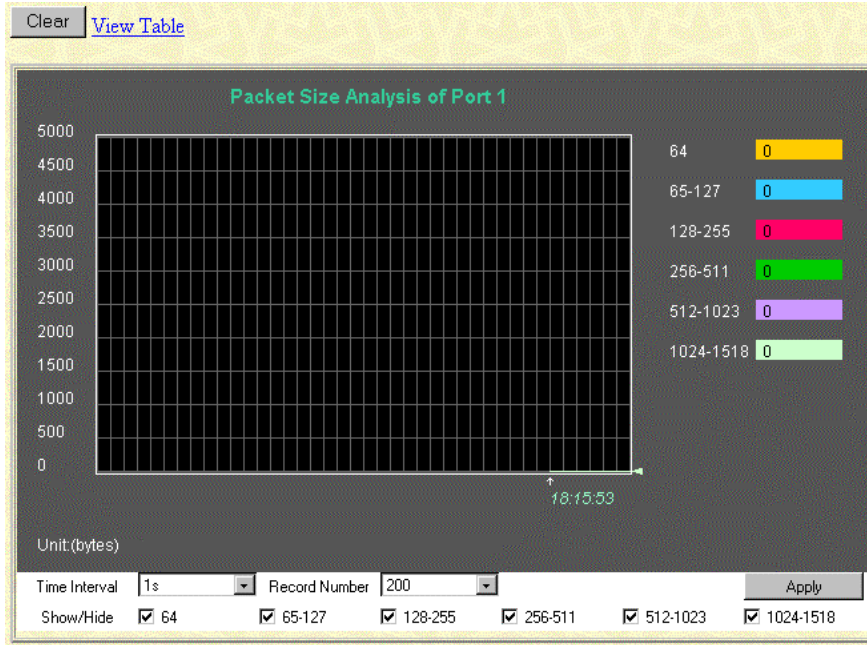

[View Line Chart](#)

Packet Analysis of Port 1				
Rx Size	Current	Total	Average	Peak
64	57	2175785	57	175527
65-127	8	444016	8	140150
128-255	0	175527	0	25879
256-511	0	140150	0	113855
512-1023	0	25879	0	388388300
1024-1518	2	113855	2	2855053

The **Rx Size Analysis** window displays the number of packets received that were within a certain range of octets in length.

The following information is displayed:

- **Time Interval**—The frequency at which the information on the screen is refreshed. The setting can be between 1s and 60s, where “s” stands for seconds. The default value is one second.
- **Record Number**—Displays the number of times the GbE Interconnect Switch will be polled. The setting can be between 20 and 200. The default value is 20.

- **64**—Displays the total number of packets (including bad packets) received that were 64 octets in length (excluding framing bits but including FCS octets).
- **65–127**—Displays the total number of packets (including bad packets) received that were between 65 and 127 octets in length inclusive (excluding framing bits but including FCS octets).
- **128–255**—Displays the total number of packets (including bad packets) received that were between 128 and 255 octets in length inclusive (excluding framing bits but including FCS octets).
- **256–511**—Displays the total number of packets (including bad packets) received that were between 256 and 511 octets in length inclusive (excluding framing bits but including FCS octets).
- **512–1023**—Displays the total number of packets (including bad packets) received that were between 512 and 1023 octets in length inclusive (excluding framing bits but including FCS octets).
- **1024–1518**—Displays the total number of packets (including bad packets) received that were between 1024 and 1518 octets in length inclusive (excluding framing bits but including FCS octets).
- **Show/Hide**—Displays or hides packets of the following lengths: 64, 65–127, 128–255, 256–511, 512–1023, and 1024–1518 packets received.

Click **Clear** to reset the counters.

## Monitoring Trunk Utilization

When you select **Trunk Utilization** from the **Monitoring** menu, the following screens are displayed.

Trunk Utilization				
ID	Group Name	Member Ports	State	Trunk Utilization
1	XConnect	17,18	Enabled	<a href="#">View</a>
2			Disabled	
3			Disabled	
4			Disabled	
5			Disabled	
6			Disabled	



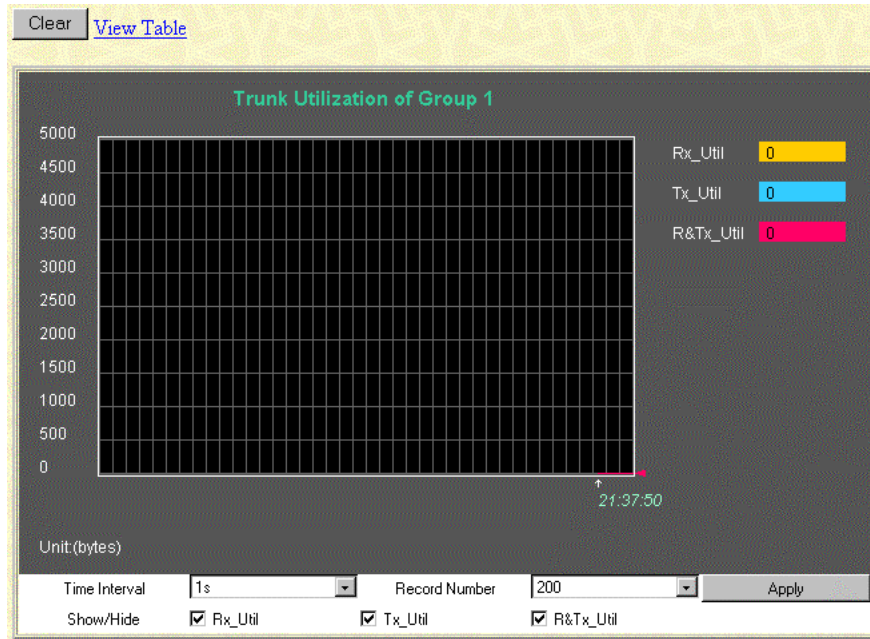

The **Trunk Utilization** window allows you to view graphs of three items for an individual port trunking group: the percentage of total available bandwidth being used by the group, the percentage of packets transmitted, and the percentage of packets being received per second.

## Monitoring MAC Address Table

When you select **MAC Address Table** from the **Monitoring** menu, the following screens are displayed.

Search by VLAN ID	<input type="text"/>	Jump	Find
Search by MAC Address	<input type="text" value="00-00-00-00-00-00"/>	Jump	Find
Search by Port	<input type="text" value="13"/>	Jump	Find

MAC Address Table			
VID	MAC Address	Port	Learned
1	00-00-00-00-00-05	15	dynamic
1	00-00-81-9a-a0-9f	15	dynamic
1	00-00-81-9a-f2-ba	15	dynamic
1	00-00-81-9a-f2-f4	15	dynamic
1	00-00-86-47-47-58	15	dynamic
1	00-00-86-4e-e1-01	15	dynamic
1	00-00-e2-41-fb-54	15	dynamic
1	00-00-f4-95-b5-4a	15	dynamic
1	00-00-f8-7c-1c-29	15	dynamic
1	00-01-02-03-04-00	15	dynamic
1	00-01-02-42-41-00	15	dynamic
1	00-01-03-83-0e-ea	15	dynamic
1	00-01-03-83-11-fd	15	dynamic

The Web Manager allows the GbE Interconnect Switch MAC address table (sometimes referred to as a forwarding table) to be viewed.

The following information is displayed:

- **Search by VLAN ID**—Type the VLAN ID you want to search for.
- **Search by MAC Address**—Type the MAC address you want to search for.
- **Search by Port**—Select the port number for which you want to search.
- **Jump**—Click this button to move to a sector of the database corresponding to a user defined port, VLAN, or MAC address.
- **Find**—Click this button to find the data entry.
- **Clear All**—Click this button to clear all forwarding table entries.
- **Clear By Port**—Click this button to clear the forwarding table entries that have the entered port number.
- **VID**—View the VLAN ID of the VLAN that the port is a member of.
- **MAC Address**—View the MAC address entered into the address table.
- **Port**—View the port that the MAC address corresponds to.

- **Learned**—View the method that the GbE Interconnect Switch used to discover the MAC address.
- **Next**—Click this button to view the next page of the address table.

## Monitoring IGMP Snooping Table

When you select **IGMP Snooping** from the **Monitoring** menu, the following screen is displayed.

		Port Map												Reports
Multicast Group	MAC Address	1	2	3	4	5	6	7	8	9	10	11	12	
		13	14	15	16	17	18	19	20	21	22	23	24	

The table is organized by VLAN ID (VID) and displays the following information:

- **VID**—Type the VLAN ID of the VLAN for which the IGMP Snooping table is to be displayed.
- **Search**—Click this button to display the IGMP Snooping Table for the current VID.
- **Multicast Group**—View the IP address of a multicast group discovered by IGMP Snooping.
- **MAC Address**—View the corresponding MAC address discovered by IGMP Snooping.
- **Port Map**—View the ports that have forwarded multicast packets.
- **Reports**—View the number of IGMP reports for the listed source.

## Monitoring Dynamic Group Registration

When you select **Dynamic Group Registration** from the **Monitoring** menu, the following screen is displayed.

		Static / IGMP Snooping					Member Port List							
VID	Multicast Group	1	3	5	7	9	11	13	15	17	19	21	23	25
		2	4	6	8	10	12	14	16	18	20	22	24	26

The **Dynamic Group Registration Table** displays filtering information for VLANs that have been discovered dynamically or have been configured into the bridge by local or network management. The table specifies the set of ports that are allowed to be forwarded, based on the frames received on a VLAN for this forwarding database (FDB) and the specific group destination address for the VLAN.

## Monitoring VLAN Status

When you select **VLAN Status** from the **Monitoring** menu, the following screen is displayed.

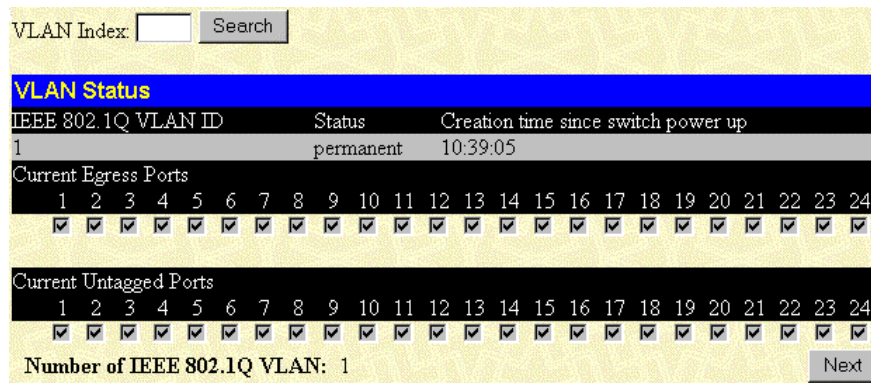

The **VLAN Status** window displays information on which VLAN ports are in egress and which are untagged.

The following information is displayed:

- **IEEE 802.1Q VLAN ID**—Displays the VLAN for which the VLAN table is displayed.
- **Status**—Displays the current status of the VID.
- **Creation time since switch power up**—Displays the hours, minutes, and seconds since the GbE Interconnect Switch was last rebooted.
- **Current Egress Ports**—Displays the current egress ports on the VLAN.
- **Current Untagged Ports**—Displays the current untagged ports on the VLAN.
- **Prev**—Displays the previous VLAN.
- **Next**—Displays the next VLAN.

To display the **VLAN Status** window for the desired VLAN:

1. Type a VLAN ID number in the **VLAN Index** field.
2. Click **Search**. The VLAN status is displayed.

## Maintaining the GbE Interconnect Switch

The **Maintenance** menu has the following sections:

- TFTP Services (Update Firmware, Configuration File, Save Settings, and Save History Log)
- Switch History
- Ping Test
- Save Changes
- Factory Reset
- Restart System
- Connection Timeout
- Logout

### Using TFTP Services

TFTP services allow the GbE Interconnect Switch firmware to be upgraded by downloading a new firmware file from a TFTP server to the GbE Interconnect Switch. A configuration file can also be loaded into the GbE Interconnect Switch, and GbE Interconnect Switch settings can be saved to a TFTP server. In addition, the history log of the GbE Interconnect Switch can be uploaded from the GbE Interconnect Switch to a TFTP server.

Please note that TFTP server software must be running on the management station for the TFTP services to function.

### Updating the Firmware File Path

When you select **Update Firmware** from the **TFTP Services** menu, the following screen is displayed.

Update Firmware from Server	
Server IP Address	10 . 48 . 78 . 1
File Name	C:\2.HAD
<input type="button" value="Start"/> <input type="button" value="Apply"/>	

The **Update Firmware from Server** window allows you to update the path of a new firmware file on the TFTP server.

To update the path:

1. Type the IP address of the TFTP Server in the **Server IP Address** field.
2. Type the complete path and file name of the firmware file for the GbE Interconnect Switch in the **File Name** field.

3. Click **Apply** to enter the IP address of the server into the GbE Interconnect Switch RAM.
4. Click **Start** to initiate the file transfer. The system automatically reboots after the file transfer is completed.

### Downloading a Configuration File on a TFTP Server

When you select **Configuration File** from the **TFTP Services** menu, the following screen is displayed.

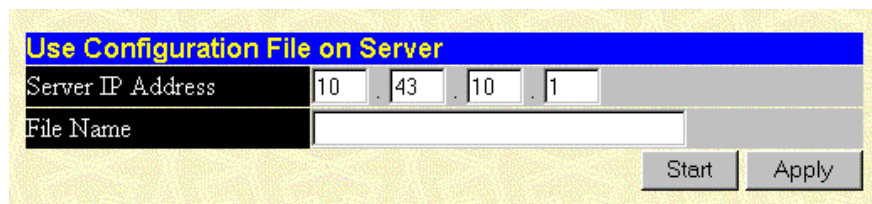

A configuration file can be downloaded from a TFTP server to the GbE Interconnect Switch. This file is then used by the GbE Interconnect Switch to configure itself.

**NOTE:** Configuration files used in the earlier version of the GbE Interconnect Switch (firmware version 1.0) are not supported by the present version (firmware version 2.0). The GbE Interconnect Switch Information window displays the firmware version.

To download the file:

1. Type the IP address of the TFTP Server in the **Server IP Address** field.
2. Type the complete path and file name of the firmware file for the GbE Interconnect Switch in the **File Name** field.
3. Click **Apply** to enter the IP address of the server into the GbE Interconnect Switch RAM.
4. Click **Start** to initiate the file transfer. The system automatically reboots after the file transfer is completed.

### Saving Settings to TFTP Server

When you select **Save Settings** from the **TFTP Services** menu, the following screen is displayed.

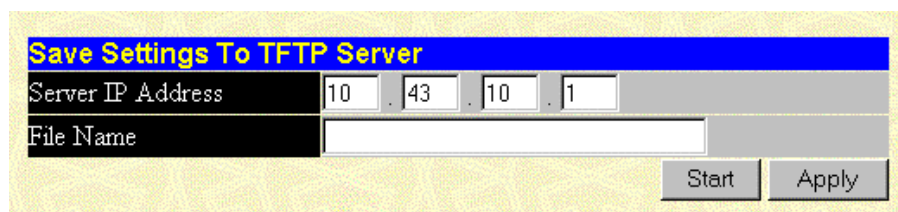

After saving the GbE Interconnect Switch configuration to NVRAM, Compaq highly recommends that you upload the configuration image to TFTP server storage.

The management agent of the GbE Interconnect Switch can upload the current switch configuration settings to a TFTP server.

To upload the current settings to a TFTP server:

1. Type the IP address of the TFTP server in the **Server IP Address** field.
2. Type the complete path and file name of the firmware file for the GbE Interconnect Switch in the **File Name** field.
3. Click **Apply** to enter the IP address of the server into the GbE Interconnect Switch RAM.
4. Click **Start** to initiate the file transfer.

**NOTE:** To save the configuration settings permanently, you must enter them into NVRAM using the **Save Changes** option on the **Maintenance** menu. Refer to the section, "Saving Changes," earlier in this chapter. If you do not save configurations to NVRAM, the configurations you are uploading to a TFTP server will not be saved correctly.

### Saving History Log

When you select **Save History Log** from the **TFTP Services Maintenance** menu, the following screen is displayed.

The screenshot shows a web form titled "Save Switch History To TFTP Server". The form has two main input areas. The first is labeled "Server IP Address" and contains the IP address "10.43.10.1" entered in four separate boxes. The second is labeled "File Name" and is currently empty. At the bottom right of the form, there are two buttons: "Start" and "Apply".

The GbE Interconnect Switch management agent can upload its history log file to a TFTP server.

**NOTE:** An empty history file on the TFTP server must exist on the server before the GbE Interconnect Switch can upload its history file.

To upload the history log file to a TFTP server:

1. Type the IP address of the TFTP Server in the **Server IP Address** field.
2. Type the complete path and file name of the firmware file for the GbE Interconnect Switch in the **File Name** field.
3. Click **Apply** to enter the IP address of the server into the GbE Interconnect Switch RAM.
4. Click **Start** to initiate the file transfer.

## Displaying GbE Interconnect Switch History

When you select **Switch History** from the **Maintenance** menu, the following screen is displayed.

Switch History		
Sequence	Time	Log Text
307	000d09h57m	Successful login through web.
306	000d07h03m	Successful login through web.
305	000d06h55m	Successful login through web.
304	000d06h43m	Successful login through web.
303	000d06h38m	Successful login through web.
302	000d05h58m	Successful login through web.
301	000d05h57m	Port 23 Link Up
300	000d05h42m	Configuration saved to flash.
299	000d03h38m	Successful login through console.
298	000d03h35m	Successful logout through console.
297	000d02h31m	Configuration saved to flash.
296	000d02h31m	Successful login through console.
295	000d02h20m	Successful login through console.
294	000d01h21m	Successful login through console.
293	000d00h00m	Successful login through console.
292	000d00h00m	Cold Start
291	000d00h01m	Upgrade Prom Code from successfully.
290	000d00h00m	Upgrade firmware unsuccessfully.
289	000d00h00m	Upgrade firmware unsuccessfully.
288	000d00h00m	Successful login through console.

The Web Manager allows you to view the history log of the GbE Interconnect Switch, as compiled by the GbE Interconnect Switch management agent. The GbE Interconnect Switch can record event information to its own logs, to designated SNMP trap receiving stations, and to the PC connected to the console manager.

The following information is displayed:

- **Sequence**—Displays a counter incremented whenever an entry to the GbE Interconnect Switch history log is made. The table displays the last entry (highest sequence number) first.
- **Time**—Displays the time in days, hours, and minutes since the GbE Interconnect Switch was last restarted.
- **Log Text**—Displays text describing the event that triggered the history log entry.

Click **Next** to display all of the Switch Trap Logs.



## Performing a Ping Test

When you select **Ping Test** from the **Maintenance** menu, the following screen is displayed.

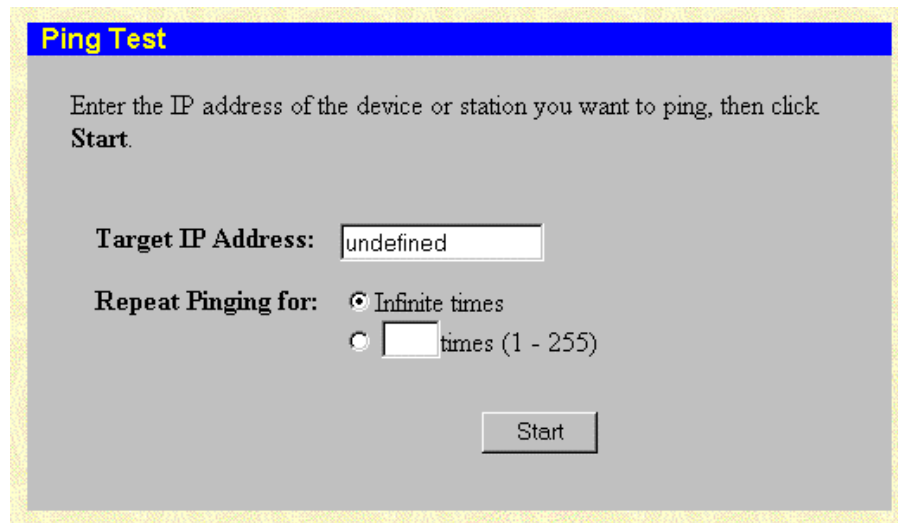

The screenshot shows a web interface titled "Ping Test" with a blue header. Below the header, there is a text prompt: "Enter the IP address of the device or station you want to ping, then click **Start**." The interface contains two main input sections. The first is labeled "Target IP Address:" followed by a text input field containing the word "undefined". The second is labeled "Repeat Pinging for:" and includes two radio button options: "Infinite times" (which is selected) and a text input field followed by "times (1 - 255)". At the bottom right of the form is a "Start" button.

The GbE Interconnect Switch can test the connection to another network device by pinging it.

To initiate the Ping program:

1. Type the IP address of the network device to be pinged in the **Target IP Address** field.
2. Select the number of test packets to be sent (three is usually enough) in the **Repeat Pinging for** field.
3. Click **Start** to initiate the Ping program.

## Resetting the GbE Interconnect Switch Configuration to Factory Defaults

When you select **Factory Reset** from the **Maintenance** menu, the following screen is displayed.

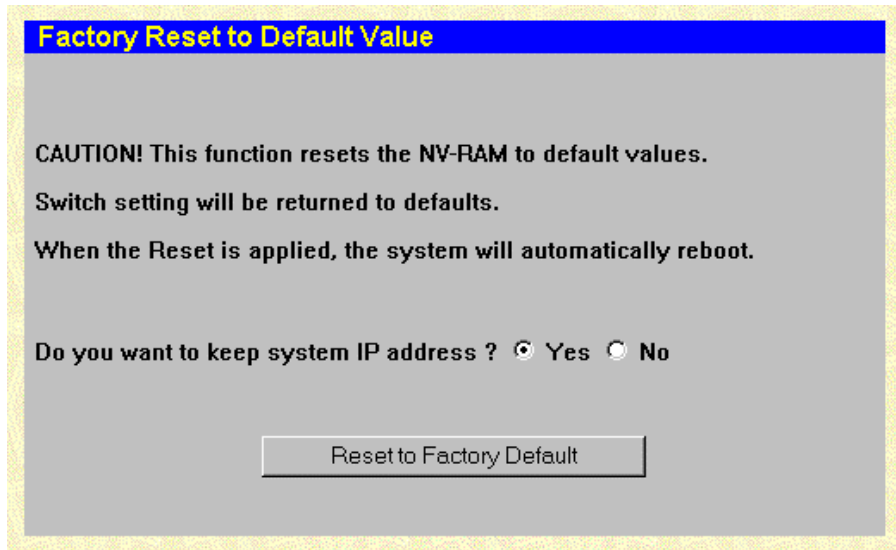

**Factory Reset** allows you to return the GbE Interconnect Switch settings to the factory defaults.

To return the settings to the factory defaults:

1. Select **Yes** or **No** to keep the system IP address. If you want your IP address to default from DHCP or BOOTP, select **No**.
2. Click **Reset to Factory Default** to reset the GbE Interconnect Switch.

## Rebooting the GbE Interconnect Switch

When you select **Restart System** from the **Maintenance** menu, the following screen is displayed.

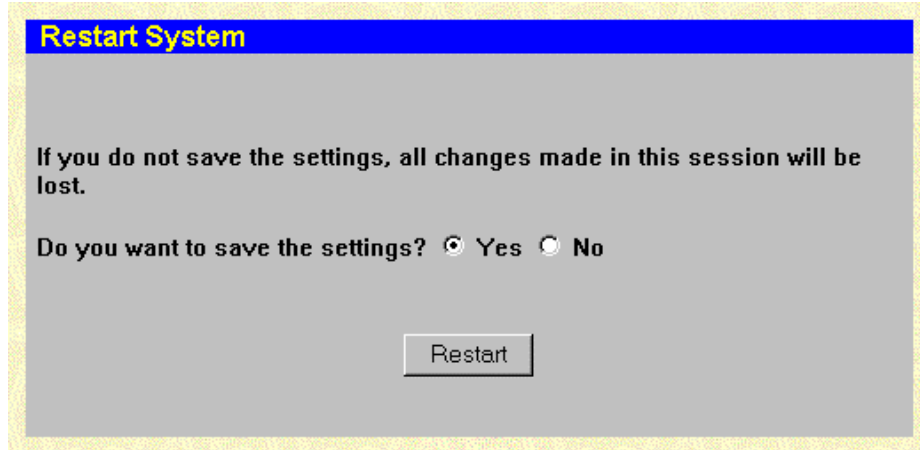

**Restart System** allows you to perform a reboot of the GbE Interconnect Switch, which resets the system.

To restart the system:

1. Select **Yes** or **No** to save the settings.
2. Click **Restart**.

## Setting the Connection Timeout

When you select **Connection Timeout** from the **Maintenance** menu, the following screen is displayed.

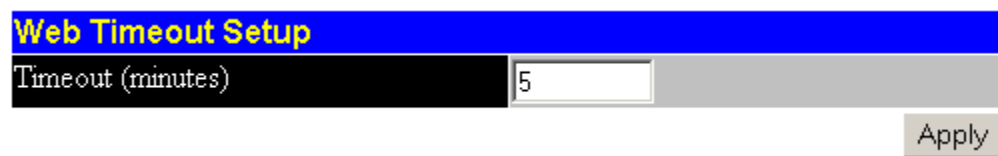

The **Web Timeout Setup** screen allows you to set the timeout interval.

To enter the Web timeout setting:

1. Type the desired age-out time in the **Timeout (minutes)** field.
2. Click **Apply**.

**NOTE:** To save the configuration settings permanently, you must enter them into NVRAM using the **Save Changes** option on the **Maintenance** menu. Refer to the section, “Saving Changes,” earlier in this chapter.

## **Logging Out**

To exit the setup pages, select **Logout** on the **Maintenance** menu. The **Account Login** screen is displayed.

## Technical Specifications

**Table A-1: General Specifications**

<b>Standards</b>	IEEE 802.1D Spanning Tree
	IEEE 802.1p QOS prioritization
	IEEE 802.1Q VLAN
	IEEE 802.3 10Base-T Ethernet
	IEEE 802.3ab 1000Base-T Ethernet
	IEEE 802.3z 1000Base-SX Ethernet
	IEEE 802.3ac Frame Extensions for VLAN
	IEEE 802.3u 100Base-TX Fast Ethernet
	IEEE 802.3x Full-Duplex Flow Control
ANSI/IEEE 802.3 Nway Auto-Negotiation	
<b>Protocols</b>	CSMA/CD
<b>Data Transfer Rates</b>	
Ethernet	Half-Duplex: 10 Mb/s
	Full-Duplex: 20 Mb/s
Fast Ethernet	Half-Duplex: 100 Mb/s
	Full-Duplex: 200 Mb/s
Gigabit Ethernet	Full Duplex: 2000 Mb/s
<b>Connectors</b>	
GbE Interconnect Switch	2 RJ-45, 1 DB-9
QuadT Interconnect Module	4 RJ-45
DualTSX Interconnect Module	2 RJ-45, 2 LC fiber

*continued*

**Table A-1: General Specifications** *continued*

<b>Network Cables</b>	
10Base-T	Two Pair UTP Category 3,4,5 (100 m) EIA/TIA-568 100-ohm STP (100 m)
100Base-TX	Two Pair or four Pair UTP Category 5 (100 m) EIA/TIA-568 100-ohm STP (100 m)
1000Base-T	Four Pair UTP Category 5e (100 m) EIA/TIA-568 100-ohm STP (100 m)
1000Base-SX	50/125 $\mu$ m Multimode Fiber with 400 MHz/Km rating has a maximum distance of 500 meters. 50/125 $\mu$ m Multimode Fiber with 500 MHz/Km rating has a maximum distance of 550 meters. 62.5/125 $\mu$ m Multimode Fiber with 160 MHz/Km rating has a maximum distance of 220 meters. 62.5/125 $\mu$ m Multimode Fiber with 200 MHz/Km rating has a maximum distance of 275 meters.
<b>Number of Ports per GbE Interconnect Switch</b>	16 x 10/100-Mb/s Nway Ports dedicated to server blade for GbE Interconnect Switch communications  2 x 10/100-Mb/s Nway Ports dedicated to communications between GbE Interconnect Switches A and B  2 x 10Base-T/100Base-TX/1000Base-T uplink Ethernet ports or 2 1000Base-SX uplink Ethernet ports (depending on C-GbE or F-GbE kit options)  2 x 10Base-T/100Base-TX uplink Ethernet ports  2 x 10Base-T/100Base-TX front-panel management ports  1 x serial RS232 front-panel management port

**Table A-2: Physical and Environmental Specifications**

<b>DC Inputs</b>	-48V: 1050 mA maximum per GbE Interconnect Switch
<b>Power Consumption</b>	50W maximum per GbE Interconnect Switch
<b>Operating Temperature</b>	10 to 35 degrees Celsius
<b>Storage Temperature</b>	-30 to 60 degrees Celsius
<b>Operating Humidity</b>	20% to 80% RH noncondensing
<b>Storage Humidity</b>	5% to 95% RH noncondensing
<b>GbE Interconnect Switch Dimensions</b>	28.0 in. x 10.4 in. x 1.6 in.
<b>Interconnect Module Dimensions</b>	7.4 in. x 3.5 in. x 1.6 in.
<b>Weight</b>	11.5 lb (GbE Interconnect Switch and Interconnect Module)
<b>EMI</b>	FCC Class A ICES-003 Class A AS/NZS 3548 Class A VCCI Class A
<b>Safety</b>	UL/CUL Listed Accessory CE

**Table A-3: Performance Specifications**

<b>Transmission Method</b>	Store-and-forward
<b>RAM Buffer</b>	8MB per GbE Interconnect Switch
<b>Filtering Address Table</b>	8K per GbE Interconnect Switch
<b>Packet Filtering/Forwarding Rate</b>	Full-wire speed for all connections 148,809.5 pps per port (for 100 Mb/s) per GbE Interconnect Switch 1,488,095 pps per port (for 1000 Mb/s) per GbE Interconnect Switch
<b>MAC Address Learning</b>	Automatic update
<b>Forwarding Table Age Time</b>	Maximum age: 10 to 9999 seconds Default: 3000 seconds
<b>Maximum Number of VLANs</b>	64 (including default VLAN)

## RJ-45 Pin Specification

When connecting the Compaq ProLiant BL p-class GbE Interconnect Switch to a switch, bridge, or hub, an Ethernet cable is necessary.

Figure B-1 displays the standard RJ-45 receptacle/connector for 10/100 Mb/s and Gigabit over Copper ports. Table B-1 indicates the pin number and wire color assignments for the switch-to-network adapter card connection, and the Ethernet cable for the switch-to-switch, switch-to-hub, or switch-to-bridge connection. Table B-2 provides the same information for the Gigabit over Copper ports.

**NOTE:** A cable configured for Gigabit over Copper can also be used on a 10/100-Mb/s connection.

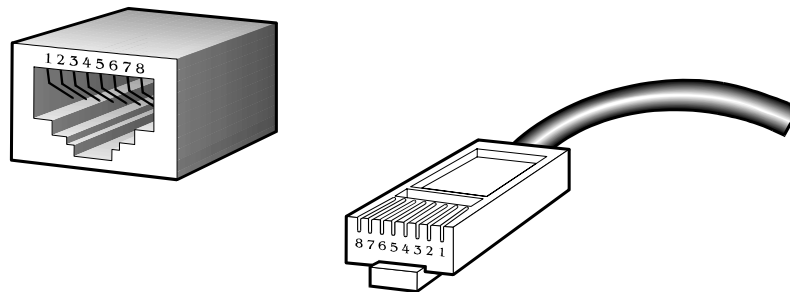

**Figure B-1: Standard RJ-45 receptacle/connector for 10/100 Mb/s and Gigabit over Copper**

**Table B-1: RJ-45 Connector Pin Assignment for 10/100-Mb/s**

Contact	Media Direct Interface Signal	Color Match
1	Tx + (transmit)	White/Orange
2	Tx - (transmit)	Orange/White
3	Rx + (receive)	White/Green
4	Not used	Blue/White
5	Not used	White/Blue
6	Rx - (receive)	Green/White
7	Not used	White/Brown
8	Not used	Brown/White



**Table B-2: RJ-45 Connector Pin Assignment for Gigabit over Copper**

<b>Contact</b>	<b>Media Direct Interface Signal</b>	<b>Color Match</b>
1	BI_DA+	White/Orange
2	BI_DA-	Orange/White
3	BI_DB+	White/Green
4	BI_DC+	Blue/White
5	BI_DC-	White/Blue
6	BI_DB-	Green/White
7	BI_DD+	White/Brown
8	BI_DD-	Brown/White

## Runtime Switching Software Default Settings

The GbE Interconnect Switch is configured with the following factory default settings:

- Table C-1 contains general default settings for both Switch A and Switch B
- Table C-2 contains Port Names, VLANs, STP/ByPass, Trunking Default Settings for Switch A
- Table C-3 contains Port Names, VLANs, STP/ByPass, Trunking Default Settings for Switch B

### Switch A and Switch B: General Default Settings

Switch A and Switch B are configured with the following general default settings:

**Table C-1: Switch A and Switch B: General Default Settings**

Setting	Value
User Name	None
Password	None
DHCP Service	Enabled
Bootup Service	Disabled
IP Address (if manual IP option is selected)	Switch A = 10.90.90.90 Switch B = 10.90.90.91
Subnet Mask (if manual IP option is selected)	255.0.0.0
Default Gateway (if manual IP option is selected)	0.0.0.0
Management VID	1
System Name	None
System Location	None
System Contact	None
Auto Logout	10 minutes
MAC Address Aging Time	300 seconds
IGMP Snooping	Disabled

*continued*

**Table C-1: Switch A and Switch B: General Default Settings** *continued*

Setting	Value
Switch GVRP	Disabled
Telnet Status	Enabled
Web Status	Enabled
Group Address Filter Mode	Forward all unregistered
Scheduling Mechanism for COS Queues	Strict
Trunk Load Sharing Algorithm	Src Address
Backpressure	Disabled
Port State	Enabled
Port Speed/Duplex	Auto
Flow Control	Off
Setup Restart Ingress Bandwidth	None
Setup Restart Egress Bandwidth	None
Switch STP	Enable
Bridge Max Age	20 seconds
Bridge Hello Time	2 seconds
Bridge Forward Delay	15 seconds
Bridge Priority	32768
Configure Static Unicast Filtering Table	None
Configure Static Multicast Filtering Table	None
Configure Static VLAN Entry	Default VLAN (VID = 1)
Default Port VID	1
Default Port Ingress Rule Checking	Off
Port GVRP Setting	Off
IGMP Snooping—VLAN ID	1
IGMP Snooping—State	Enabled
IGMP Snooping—Querier State	Non-querier
IGMP Snooping—Robustness Variable	2
IGMP Snooping—Query Interval	125 seconds
IGMP Snooping—Max Response	10 seconds
Port Trunking	Xconnect (Port 17–18)
Port Mirroring—Source Port	1
Port Mirroring—Source Direction	Ingress and Egress
Port Mirroring—Target Port	11

*continued*

**Table C-1: Switch A and Switch B: General Default Settings** *continued*

Setting	Value
Port Mirroring—Mirror Status	Disabled
Broadcast Storm	Disabled
Multicast Storm	Disabled
DA Unknown Storm	Disabled
Storm Threshold	500 Packets/Second
Class of Service—Max Packets	10
Class of Service—Max Latency	0
Default Port Priority	0
Class of Traffic	<ul style="list-style-type: none"> <li>• Priority 0, 1: Class 0</li> <li>• Priority 2, 3: Class 1</li> <li>• Priority 4, 5: Class 2</li> <li>• Priority 6, 7: Class 3</li> </ul>
Port Security—Admin State	Disabled
Port Security—Max Address	1
Port Security—Mode	DeleteOnReset
Priority MAC Address	None
SNMP Community String	“public,” “private”
SNMP Trap Manager IP	None
Security IP	0.0.0.0
User Account	None
Firmware Update	Disabled
Configuration File on TFTP Server	Disabled
Save Setting to TFTP Server	Disabled
Save History Log to TFTP Server	Disabled
PING Test	Disabled
Out-of-band Baud Rate	9600
Data Bit	8
Parity Bit	None
Stop Bit	1
TFTP Server IP Address	0.0.0.0
VLAN Mode	IEEE 802.1Q

## Switch A: Port Names, VLANs, STP/ByPass, Trunking Default Settings

**NOTE:** If you have the ProLiant BL p-Class F-GbE Interconnect Kit option with the DualTSX Interconnect Modules, the management interface supports only 1000M/Full and Auto options for the Speed/Duplex fields for Gigabit uplink ports. The fiber DualTSX Interconnect Module supports **only 1000-Mb/s (Gigabit) speed**, and **not** 10-Mb/s or 100-Mb/s.

Switch A is configured with the following factory default settings for Port Names, VLANs, STP/ByPass, and Trunking.

**Table C-2: Switch A: Port Names, VLANs, STP/ByPass, Trunking Default Settings**

Port Type	UI Port No.	Speed	VID	VLAN Member AS	VLAN Name	Port Name	STP/ByPass Enabled	Multilink Trunk
Server	1	10/100 (Auto)	1	Egress	DEFAULT_VLAN	Server1_Port1	Yes	
Server	2	10/100 (Auto)	1	Egress	DEFAULT_VLAN	Server1_Port2	Yes	
Server	3	10/100 (Auto)	1	Egress	DEFAULT_VLAN	Server2_Port1	Yes	
Server	4	10/100 (Auto)	1	Egress	DEFAULT_VLAN	Server2_Port2	Yes	
Server	5	10/100 (Auto)	1	Egress	DEFAULT_VLAN	Server3_Port1	Yes	
Server	6	10/100 (Auto)	1	Egress	DEFAULT_VLAN	Server3_Port2	Yes	
Server	7	10/100 (Auto)	1	Egress	DEFAULT_VLAN	Server4_Port1	Yes	
Server	8	10/100 (Auto)	1	Egress	DEFAULT_VLAN	Server4_Port2	Yes	
Server	9	10/100 (Auto)	1	Egress	DEFAULT_VLAN	Server5_Port1	Yes	
Server	10	10/100 (Auto)	1	Egress	DEFAULT_VLAN	Server5_Port2	Yes	
Server	11	10/100 (Auto)	1	Egress	DEFAULT_VLAN	Server6_Port1	Yes	
Server	12	10/100 (Auto)	1	Egress	DEFAULT_VLAN	Server6_Port2	Yes	
Server	13	10/100 (Auto)	1	Egress	DEFAULT_VLAN	Server7_Port1	Yes	
Server	14	10/100 (Auto)	1	Egress	DEFAULT_VLAN	Server7_Port2	Yes	

*continued*

**Table C-2: Switch A: Port Names, VLANs, STP/ByPass, Trunking Default Settings** *continued*

Port Type	UI Port No.	Speed	VID	VLAN Member AS	VLAN Name	Port Name	STP/ByPass Enabled	Multilink Trunk
Server	15	10/100 (Auto)	1	Egress	DEFAULT_VLAN	Server8_Port1	Yes	
Server	16	10/100 (Auto)	1	Egress	DEFAULT_VLAN	Server8_Port2	Yes	
X-Connect	17	10/100 (Auto)	1	Egress	DEFAULT_VLAN	XConnect_1	No	XConnect
X-Connect	18	10/100 (Auto)	1	Egress	DEFAULT_VLAN	XConnect_2	No	XConnect
M Uplink	19	10/100 (Auto)	1	Egress	DEFAULT_VLAN	U1_Port_19	No	
M Uplink	20	10/100 (Auto)	1	Egress	DEFAULT_VLAN	U1_Port_20	No	
D Uplink	21	10/100 /1000 (Auto)	1	Egress	DEFAULT_VLAN	U2_Port_21	No	
D Uplink	22	10/100 /1000 (Auto)	1	Egress	DEFAULT_VLAN	U2_Port_22	No	
Front Panel	23	10/100 (Auto)	1	Egress	DEFAULT_VLAN	FrontPanel1	No	
Front Panel	24	10/100 (Auto)	1	Egress	DEFAULT_VLAN	FrontPanel2	No	

## Switch B: Port Names, VLANs, STP/ByPass, Trunking Default Settings

**NOTE:** If you have the ProLiant BL p-Class F-GbE Interconnect Kit option with the DualTSX Interconnect Modules, the management interface supports only 1000M/Full and Auto options for the Speed/Duplex fields for Gigabit uplink ports. The fiber DualTSX Interconnect Module supports **only 1000-Mb/s (Gigabit) speed**, and **not** 10-Mb/s or 100-Mb/s.

Switch B is configured with the following factory default settings for Port Names, VLANs, STP/ByPass, and Trunking.

**Table C-3: Switch B: Port Names, VLANs, STP/ByPass, Trunking Default Settings**

Port Type	UI Port No.	Speed	VID	VLAN Member AS	VLAN Name	Port Name	STP/ByPass Enabled	Multilink Trunk
Server	1	10/100 (Auto)	1	Egress	DEFAULT_VLAN	Server1_iLO	Yes	
Server	2	10/100 (Auto)	1	Egress	DEFAULT_VLAN	Server1_Port3	Yes	
Server	3	10/100 (Auto)	1	Egress	DEFAULT_VLAN	Server2_iLO	Yes	
Server	4	10/100 (Auto)	1	Egress	DEFAULT_VLAN	Server2_Port3	Yes	
Server	5	10/100 (Auto)	1	Egress	DEFAULT_VLAN	Server3_iLO	Yes	
Server	6	10/100 (Auto)	1	Egress	DEFAULT_VLAN	Server3_Port3	Yes	
Server	7	10/100 (Auto)	1	Egress	DEFAULT_VLAN	Server4_iLO	Yes	
Server	8	10/100 (Auto)	1	Egress	DEFAULT_VLAN	Server4_Port3	Yes	
Server	9	10/100 (Auto)	1	Egress	DEFAULT_VLAN	Server5_iLO	Yes	
Server	10	10/100 (Auto)	1	Egress	DEFAULT_VLAN	Server5_Port3	Yes	
Server	11	10/100 (Auto)	1	Egress	DEFAULT_VLAN	Server6_iLO	Yes	
Server	12	10/100 (Auto)	1	Egress	DEFAULT_VLAN	Server6_Port3	Yes	
Server	13	10/100 (Auto)	1	Egress	DEFAULT_VLAN	Server7_iLO	Yes	

*continued*

**Table C-3: Switch B: Port Names, VLANs, STP/ByPass, Trunking Default Settings** *continued*

Port Type	UI Port No.	Speed	VID	VLAN Member AS	VLAN Name	Port Name	STP/By Pass Enabled	Multilink Trunk
Server	14	10/100 (Auto)	1	Egress	DEFAULT_VLAN	Server7_Port3	Yes	
Server	15	10/100 (Auto)	1	Egress	DEFAULT_VLAN	Server8_iLO	Yes	
Server	16	10/100 (Auto)	1	Egress	DEFAULT_VLAN	Server8_Port3	Yes	
X-Connect	17	10/100 (Auto)	1	Egress	DEFAULT_VLAN	XConnect_1	No	XConnect
X-Connect	18	10/100 (Auto)	1	Egress	DEFAULT_VLAN	XConnect_2	No	XConnect
M Uplink	19	10/100 (Auto)	1	Egress	DEFAULT_VLAN	U1_Port_19	No	
M Uplink	20	10/100 (Auto)	1	Egress	DEFAULT_VLAN	U1_Port_20	No	
D Uplink	21	10/100 /1000 (Auto)	1	Egress	DEFAULT_VLAN	U2_Port_21	No	
D Uplink	22	10/100 /1000 (Auto)	1	Egress	DEFAULT_VLAN	U2_Port_22	No	
Front Panel	23	10/100 (Auto)	1	Egress	DEFAULT_VLAN	FrontPanel1	No	
Front Panel	24	10/100 (Auto)	1	Egress	DEFAULT_VLAN	FrontPanel2	No	

**Note:** By default, the processor port is assigned to DEFAULT\_VLAN. XConnect1 and XConnect2 between GbE Interconnect Switch A and GbE Interconnect Switch B are bundled in to a Multilink Trunk.



---

# Spanning Tree Protocol

## Introduction

When the Spanning Tree Protocol (STP) determines that a port should be transitioned to the forwarding state, the following occurs:

- The port is put into the listening state where it receives Bridge Protocol Data Units (BPDUs) and passes them to the processor of the GbE Interconnect Switch.
- If no BPDUs that suggest the port should go to the blocking state are received, the BPDU packets from the processor are processed.
  - The port waits for the expiration of the forward delay timer. The port then moves to the learning state.
  - In the learning state, the port learns station location information from the source addresses of packets and adds this information to its forwarding database.
  - The expiration of the forwarding delay timer moves the port to the forwarding state, where both learning and forwarding are enabled. At this point, the port forwards packets.

## Blocking State

A port in the blocking state does not forward packets. When the switch is booted, a BPDU is sent to each port in the switch putting these ports into the blocking state.

A switch initially assumes it is the root switch for a network. When the switch begins to exchange BPDUs with other switches, the switch that is the best choice for the root switch is determined. If there is only one switch on the network, no BPDU exchange occurs, the forward delay timer expires, and the ports move to the listening state. All STP-enabled ports enter the blocking state following switch boot.

A port in the blocking state:

- Discards packets received from the network segment to which it is attached.
- Discards packets sent from another port on the switch for forwarding.
- Does not add addresses to its forwarding database.
- Receives BPDUs and directs them to the processor.

- Does not transmit BPDUs received from the processor.
- Receives and responds to network management messages.

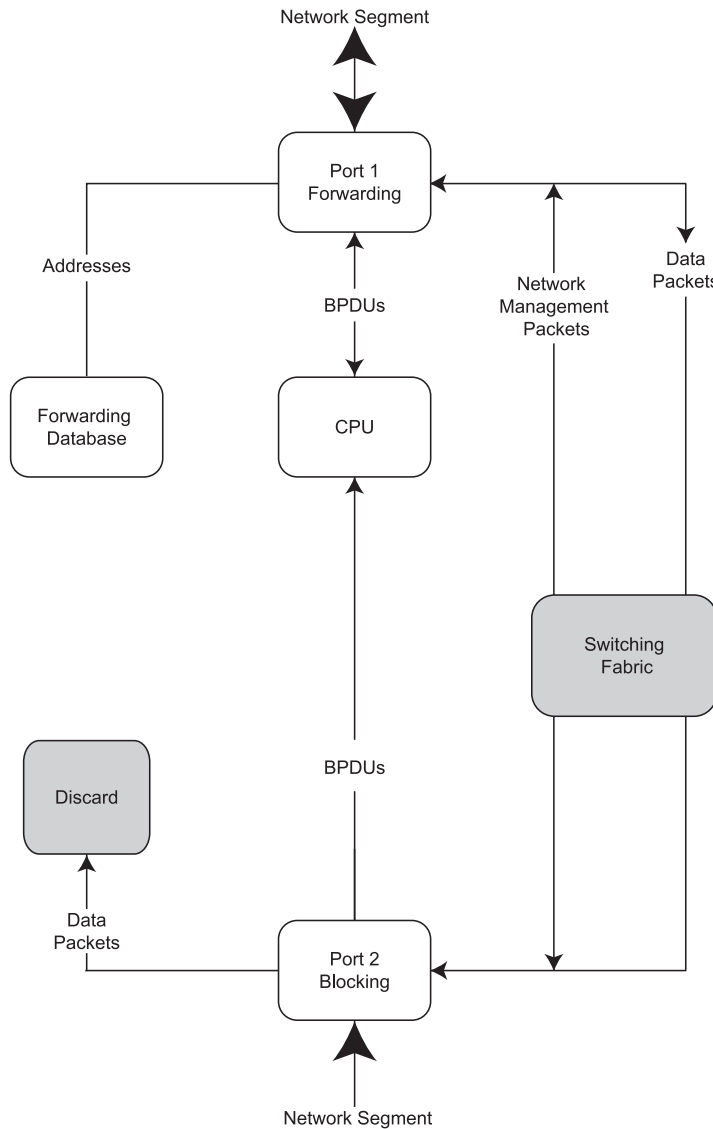

**Figure D-1: Blocking state**

## Listening State

The listening state is the first transition for a port from the blocking state. Listening is an opportunity for the switch to receive BPDUs that may tell the switch that the port should not continue to transition to the forwarding state, but should return to the blocking state (that is, a different port is a better choice).

There is no address learning or packet forwarding from a port in the listening state.

A port in the listening state:

- Discards frames received from the network segment to which it is attached.
- Discards packets sent from another port on the switch for forwarding.
- Does not add addresses to its forwarding database.
- Receives BPDUs and directs them to the processor.
- Processes BPDUs received from the processor.
- Receives and responds to network management messages.

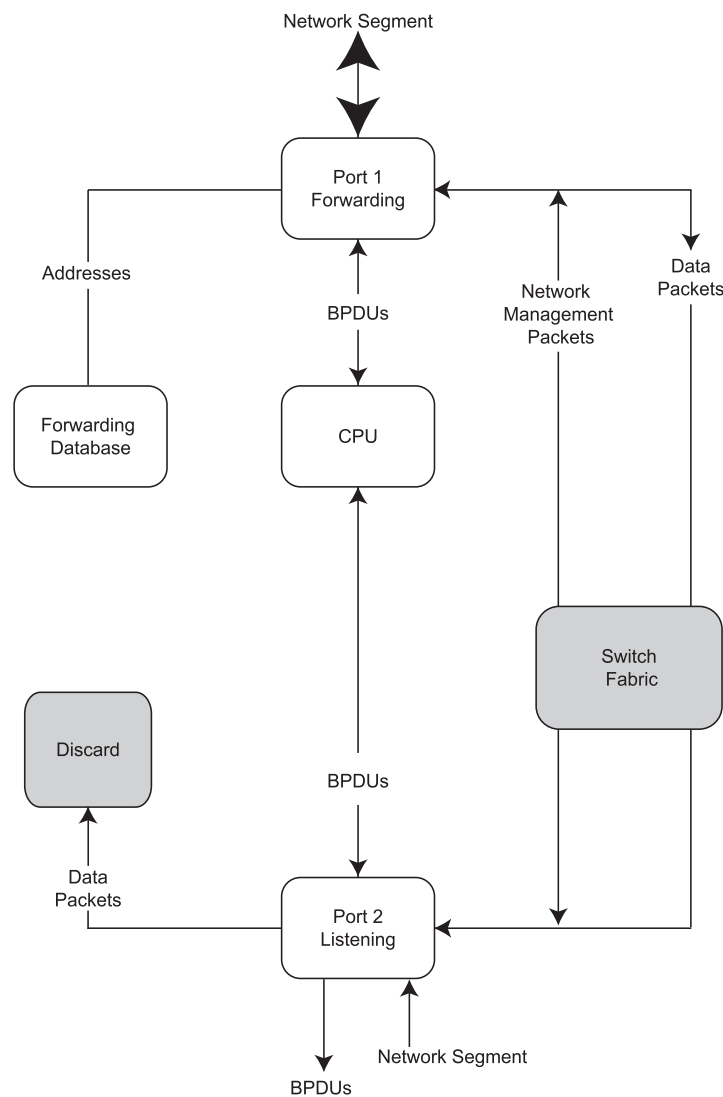

**Figure D-2: Listening state**

## Learning State

A port in the learning state prepares to participate in frame forwarding. The port enters the learning state from the listening state.

A port in the learning state:

- Discards frames received from the network segment to which it is attached.
- Discards packets sent from another port on the switch for forwarding.
- Adds addresses to its forwarding database.
- Receives BPDUs and directs them to the processor.
- Processes and transmits BPDUs received from the processor.
- Receives and responds to network management messages.

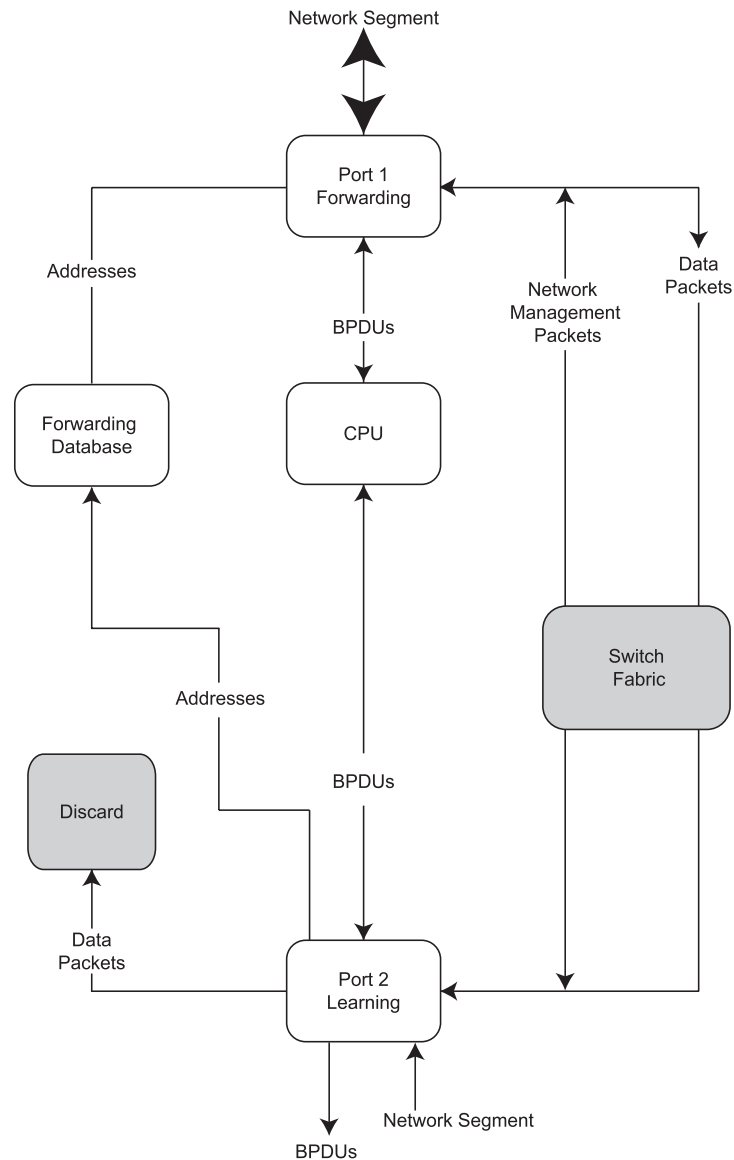

**Figure D-3: Learning state**

## Forwarding State

A port in the forwarding state forwards packets. The port enters the forwarding state from the learning state when the forward delay timer expires.

A port in the forwarding state:

- Forwards packets received from the network segment to which it is attached.
- Forwards packets sent from another port on the switch.
- Incorporates station location information into its address database.

- Receives BPDUs and directs them to the system processor.
- Receives and responds to network management messages.

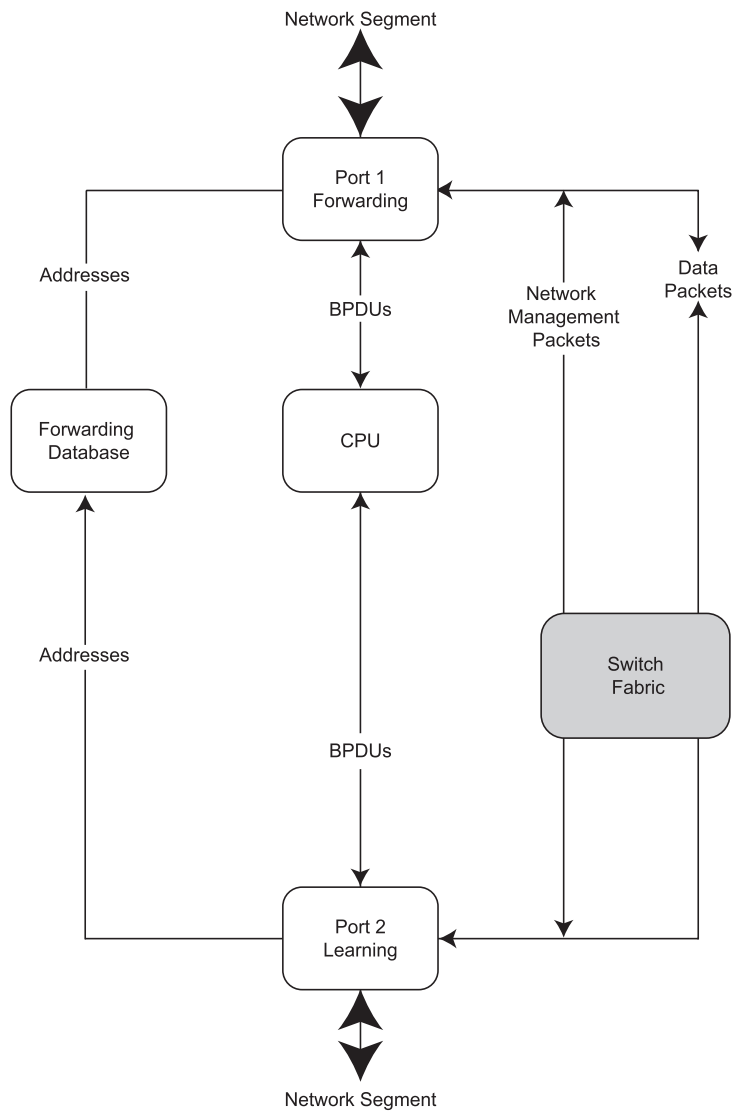

**Figure D-4: Forwarding state**

## Disabled State

A port in the disabled state does not participate in frame forwarding or STP. A port in the disabled state is virtually nonoperational.

A disabled port:

- Discards packets received from the network segment to which it is attached.
- Discards packets sent from another port on the switch for forwarding.

- Does not add addresses to its forwarding database.
- Receives BPDUs, but does not direct them to the system processor.
- Does not receive BPDUs for transmission from the system processor.
- Receives and responds to network management messages.

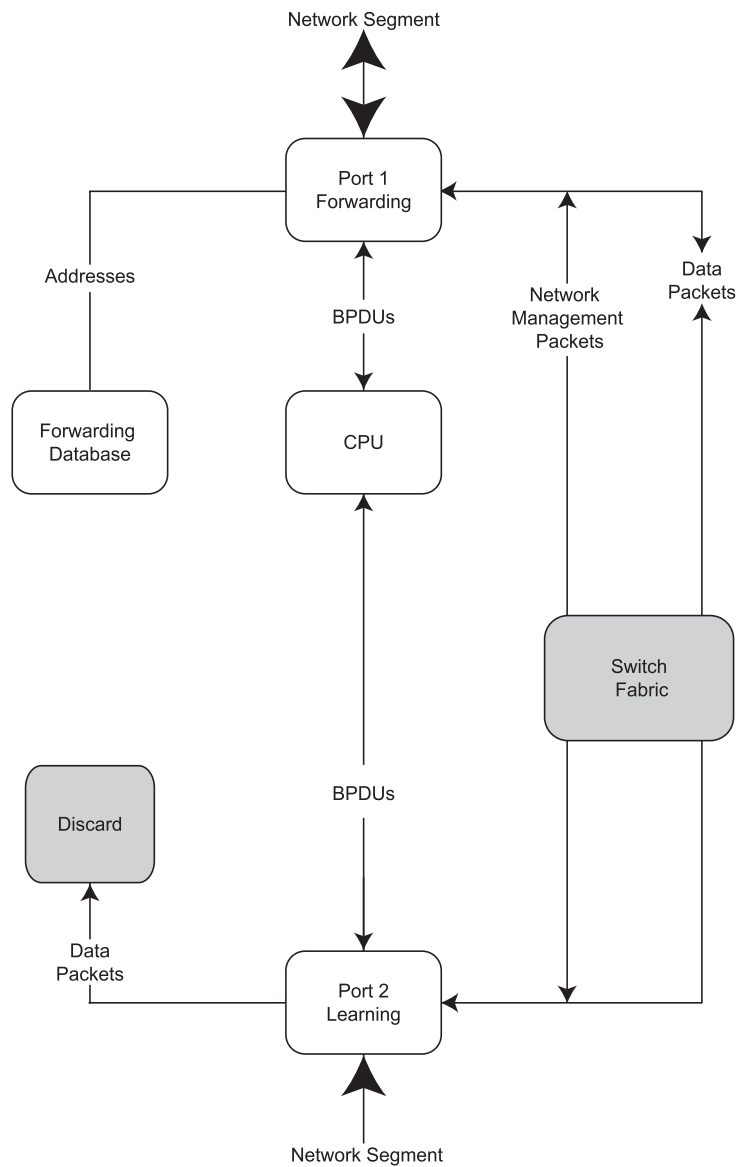

**Figure D-5: Disabled state**

## Troubleshooting STP

This section describes several troubleshooting tips.

### Spanning Tree Protocol Failure

A failure in the STP generally leads to a bridging loop. A bridging loop in an STP environment comes from a port that should be in the blocking state, but is forwarding packets.

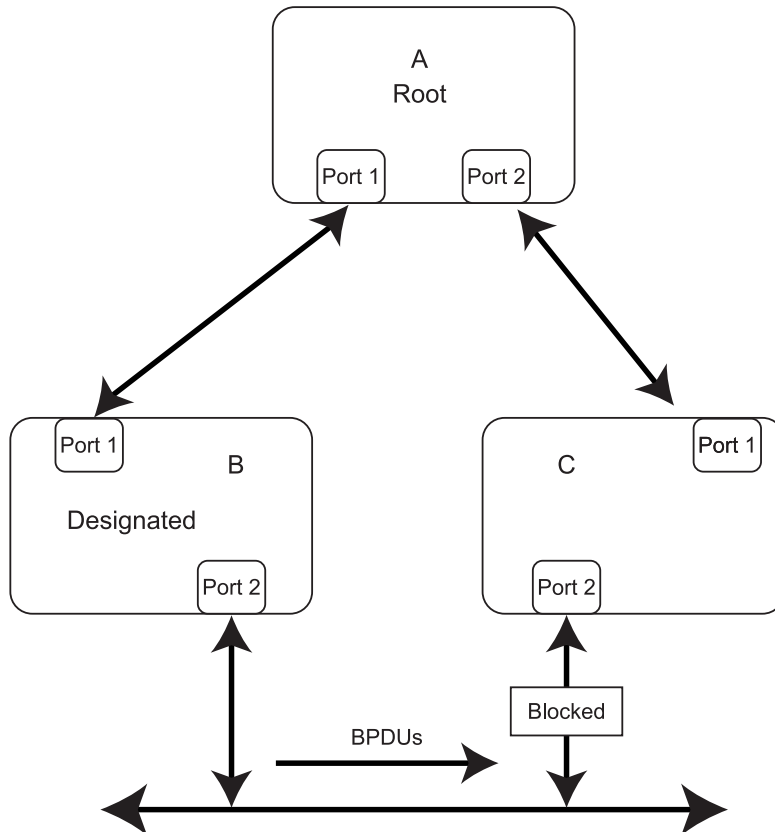

**Figure D-6: Example of Spanning Tree Protocol failure**

In the example, switch B has been elected as the designated bridge, and port 2 on switch C is in the blocking state. The election of switch B as the designated bridge is determined by the exchange of BPDUs between switches B and C. Switch B continues sending BPDUs advertising its superiority over the other bridges on the LAN. If switch C fails to receive these BPDUs for longer than the Max Age (default of 20 seconds), it could start to transition its port 2 from the blocking state to the forwarding state.

**IMPORTANT:** A port must continue to receive BPDUs advertising superior paths to remain in the blocking state.



There are a number of circumstances in which the STP can fail, mostly related to the loss of a large number of BPDUs. These situations will cause a port in the blocking state to transition to the forwarding state.

## Full/Half Duplex Mismatch

A mismatch in the duplex state of two ports is a very common configuration error for a point-to-point link. If one port is configured as a full-duplex, and the other port is left in auto-negotiation mode, the second port will end up in half-duplex because ports configured as half- or full-duplex do not negotiate.

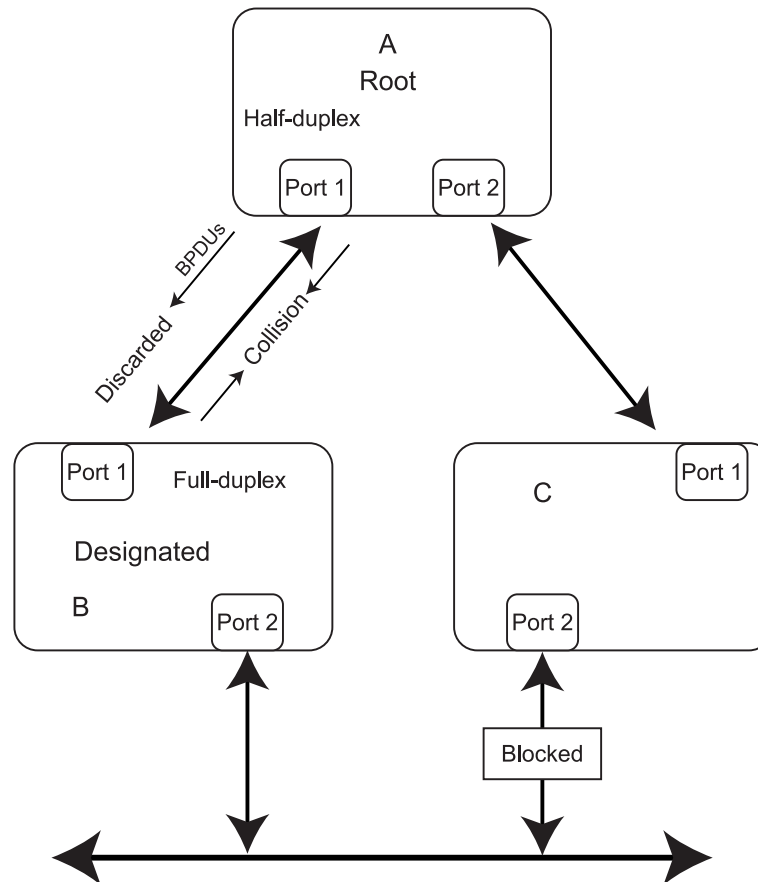
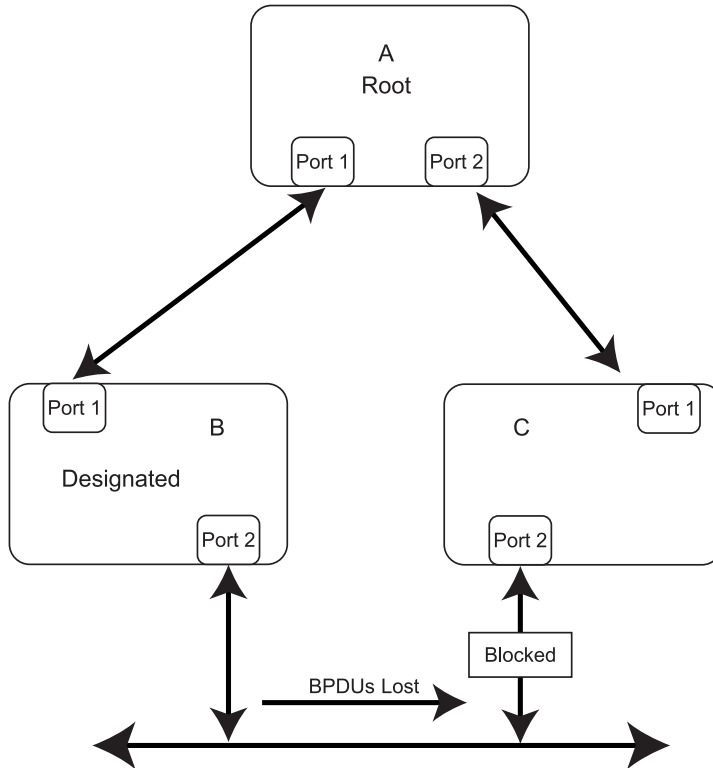

**Figure D-7: Example of full- and half-duplex mismatch**

In the example, port 1 on switch B is configured as a full-duplex port, and port 1 on switch A is either configured as a half-duplex port or left in auto-negotiation mode. Because port 1 on switch B is configured as a full-duplex port, it does not do the carrier sense when accessing the link. Switch B will then start sending packets even if switch A is using the link. Switch A will then detect collisions and begin to run the flow control algorithm. If there is enough traffic between switches B and A, all packets (including BPDUs) will be dropped. If the BPDUs sent from switch A to switch B are dropped for longer than the Max Age, switch B will lose its connection to the root (switch A) and will unblock its connection to switch C. This will lead to a data loop.

## Unidirectional Link

Unidirectional links can be caused by an undetected failure in one side of a fiber cable or a problem with the transceiver of a port. Any failure that allows a link to remain operational while providing one-way communication is very dangerous for STP.



**Figure D-8: Example of unidirectional link**

In this example, port 2 on switch B can receive but not transmit packets. Port 2 on switch C should be in the blocking state, but because it can no longer receive BPDUs from port 2 on switch B, it will transition to the forwarding state. If the failure exists at boot, STP will not converge and rebooting the bridges will have no effect.

This type of failure is difficult to detect because the link-state LEDs for Ethernet links rely on the transmit side of the cable to detect a link. If a unidirectional failure on a link is suspected, you must go to the console or other management software and look at the packets received and transmitted for the port. For example, a unidirectional port will have many packets transmitted but none received, or vice versa.

## Packet Corruption

Packet corruption can also lead to the Spanning Tree Protocol failure. If a link is experiencing a high rate of physical errors, a large number of consecutive BPDUs can be dropped. If the BPDUs dropped for 50 seconds (at the default setting) a port in the blocking state would transition to the forwarding state. If the Max Age is set too low, the transition time is reduced.

## Resource Errors

The ProLiant BL e-Class C-GbE Interconnect Switch performs its switching and routing functions primarily in hardware, using specialized ASICs. STP is implemented in software so it relies on the speed of the processor and other factors to converge. If the processor is overutilized, the BPDUs may not be sent in a timely fashion. STP generally is not processor intensive and is given priority over other processes, so this type of error is rare.

Very low values for the Max Age and the Forward Delay can result in an unstable spanning tree. The loss of BPDUs can lead to data loops.

The diameter of the network can also cause problems. The default values for STP give a maximum network diameter of seven hops. This means that two switches in the network cannot be more than seven hops apart. Part of this diameter restriction is the BPDU age field. As BPDUs are propagated from the root bridge to the leaves of the spanning tree, each bridge increments the age field. When this field is beyond the maximum age, the packet is discarded. For large diameter networks, STP convergence can be very slow.

## Identifying a Data Loop

Broadcast storms have a similar effect on the network to data loops, but broadcast storm controls in modern switches (along with subnetting and other network practices) have been very effective in controlling broadcast storms. The best way to determine if a data loop exists is to capture traffic on a saturated link and check if similar packets are seen multiple times.

Generally, if all the users of a given domain are having trouble connecting to the network at the same time, a data loop can be suspected. The port utilization data in the console of the switch will show unusually high values in this case.

The priority for most loop situations is to restore connectivity as soon as possible. The simplest remedy is to manually disable all of the ports that provide redundant links. If time allows, disabling the ports one at a time, and then checking for a restoration of the user's connectivity will identify the link that is causing the problem. Connectivity will be restored immediately after disabling a data loop.

## Avoiding Trouble

Following are some tips for avoiding STP network problems.

### Know Where the Root Is Located

Although the STP can elect a root bridge, a well-designed network will have an identifiable root for each VLAN. Careful setup of the STP parameters will lead to the selection of the preferred interconnect switch as the root for each VLAN. Redundant links can then be built into the network. STP is well suited to maintaining connectivity in the event of a device failure or removal, but is poorly suited to designing networks.

### Know Which Links Are Redundant

Organize the redundant links and tune the port cost parameter of STP to force those ports to be in the blocking state.

For each VLAN, know which ports should be blocked in a stable network. A network diagram that shows each physical loop in the network and which ports break which loops is extremely helpful.

### Minimize the Number of Ports in the Blocking State

A single blocking port transitioning to the forwarding state at an inappropriate time can cause a large part of a network to fail. Limiting the number of blocked ports helps to minimize the risk of an inappropriate transition.

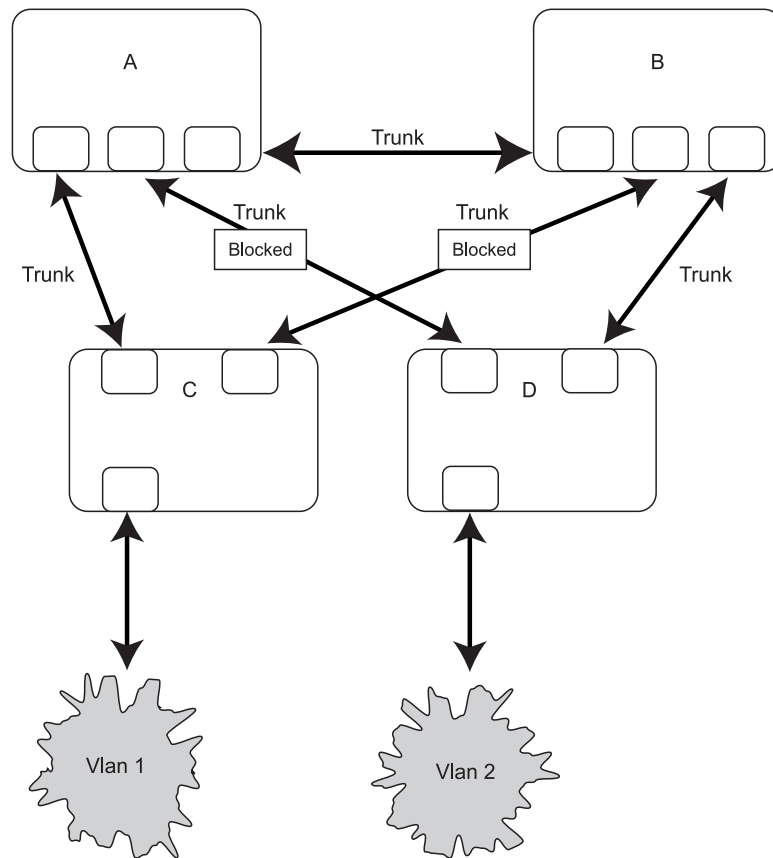

**Figure D-9: Common network design example 1**

The preceding graphic is an example of a common network design. The switches C and D have redundant links to the backbone switches A and B using trunks. Trunks, by default, carry all the VLAN traffic from VLAN 1 and VLAN 2. So switch C is not only receiving traffic for VLAN 1, but it is also receiving unnecessary broadcast and multicast traffic for VLAN 2. It is also blocking one port for VLAN 2. Thus, there are three redundant paths between switches A and B and two blocked ports per VLAN. This increases the chance of a data loop.

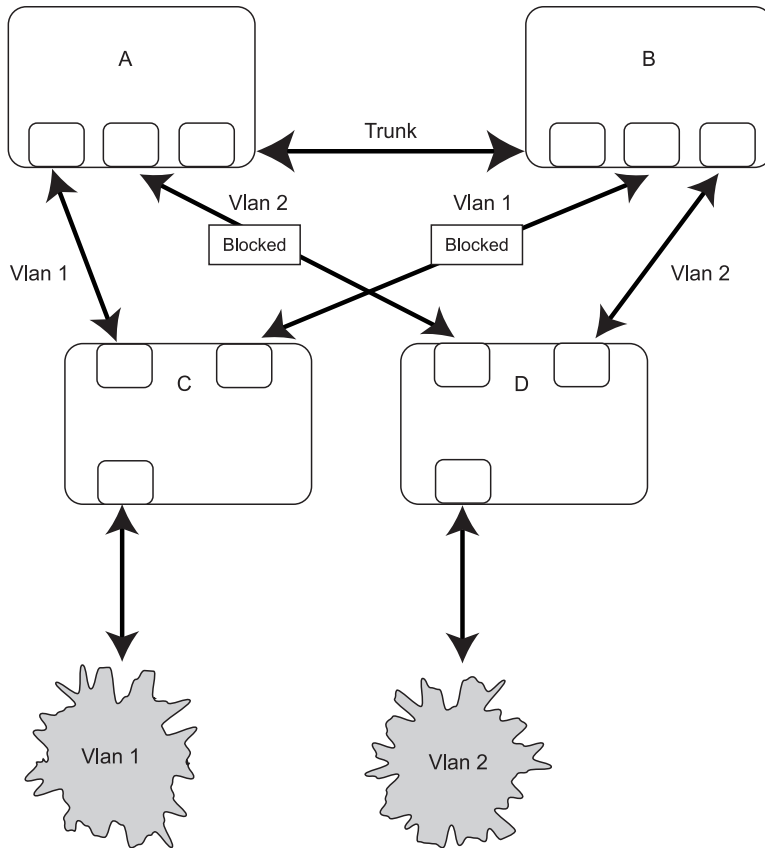

**Figure D-10: Common network design example 2**

In the second network design example, the VLAN definitions are extended to switches A and B. This configuration has only one blocked port per VLAN and allows the removal of all redundant links by removing switch A or B from the network.

---

## SNMP/RMON MIBs Support

### Introduction

Management and counter information are stored in the switch in the Management Information Base (MIB). The switch uses the standard MIB-II Management Information Base module. Values for MIB objects can be retrieved from any SNMP-based network management software.

In addition to the standard MIB-II, the switch also supports its own proprietary enterprise MIB as an extended Management Information Base. The proprietary MIB is retrieved by specifying the MIB Object-Identifier (OID) at the network manager station.

MIB values can be either read-only or read/write variables.

- Read-only MIB variables can be constants that are programmed into the switch or variables that change while the switch is in operation. Examples of read-only constants include the number and types of ports. Examples of read-only variables are the statistics counters, such as the number of errors that have occurred or how many kilobytes of data have been received and forwarded through a port.
- Read/write MIB variables are usually related to user-customized configurations. Examples include the IP address of the switch, Spanning Tree Algorithm parameters, and port status.

### SNMP Manager Software

If you use third-party vendor SNMP software to manage the switch, a diskette listing the propriety enterprise MIBs for the switch can be obtained by request. If your software provides functions to browse or modify MIBs, you can also change the MIB values (if the MIB attributes permit the write operation). This process can be quite involved, however, because you must know the MIB OIDs and retrieve them one by one.

Use an SNMP manager, such as HP OpenView or Tivoli NetView, to access the enterprise-specific MIBs. Compile the MIBs into the MIB database and then use a MIB browser to navigate through them. For detailed information, access the individual descriptions of each MIB or go to the documentation that came with your SNMP manager software.

## Standard MIBs

The SNMP agent for the switch supports the following standard MIBs:

- Bridge MIB (RFC 1493)
- MIB-II (RFC 1213)
- Mini-RMON MIB (RFC 1757)—Groups 1 (Statistics), 2 (History), 3 (Alarm), and 9 (Event)
- 802.1p MIB (RFC 2674)
- 802.1q MIB (RFC 2674)
- Entity MIB (RFC 2737)
- IF-MIB (RFC 2233)
- Ethernet-like MIB (RFC 2358)—dot3StatsTable

## Enterprise-Specific MIBs

The SNMP agent for the switch supports the following enterprise-specific MIBs:

- cpqAgent.mib
  - agentBasicInfo—Basic information for the switch
  - agentBasicConfig—Basic configuration management
  - agentIpProtoConfig—IP-related configuration management
  - agentIpTrapManager—Setting of the trap manager IP
- cpql2mgt.mib
  - swPortTrunkPackage—Management of the port trunk function
  - swPortMirrorPackage—Management of the port mirroring function
  - swIGMPPackage—Management of the IGMP function
- vesubio.mib
  - swL2BwMgmt—Management of the ingress and egress bandwidth
  - swL2CosMgmt—Management of the Class of Service
  - swL2PortSecurityMgmt—Management of port security
  - dswL2DevMgmt—Management of the device advanced settings
  - swL2PortMgmt—Management of the port link
- CIMTrap.mib—Redefining of the entConfigChange trap in SNMP



---

## Upgrading Firmware by Means of the Serial Port

The system firmware of a GbE Interconnect Switch can be upgraded by connecting a computer to the serial console port on the front of GbE Interconnect Switch and using terminal emulation software that supports the ZModem or XModem protocols. This procedure is only necessary if your GbE Interconnect Switch does not have access to a TFTP server, or if the firmware procedure was previously interrupted and the switch will not boot properly.

To download system firmware using the current download baud rate and current download protocol, follow steps 1 through 4 and steps 11 through 16.

To change the default download baud rate of 115200 and the default download protocol of ZModem, follow steps 5 through 9.

**IMPORTANT:** Because some required actions are time critical, it is recommended that you read through all the steps and become familiar with the terminal emulation software before trying to download firmware or change the boot configuration.

To download a firmware file to a GbE Interconnect Switch, do the following:

1. From a PC using Microsoft Windows HyperTerminal or any other terminal emulation program, connect to the serial console interface on the GbE Interconnect Switch using the default values of 9600 baud, 8 data bits, no parity and 1 stop bit.

**NOTE:** For information on how to connect to the switch console interface, refer to the section "Connecting to the GbE Interconnect Switches" in Chapter 3.

**NOTE:** For faster data transfers, change the speed of your console connection from 9600 to 115200. Remember to also change the baud rate of your terminal emulation session to match the console speed settings. Refer to the section "Configuring RS232 and SLIP" in Chapter 3.

2. Reboot the GbE Interconnect Switch by using the **Reboot** menu option or by pressing the **Pwr/Rst** button on the front panel of the GbE Interconnect Switch. The boot procedure will run the Power-On Self-Test (POST) and a screen similar to the following will be displayed.

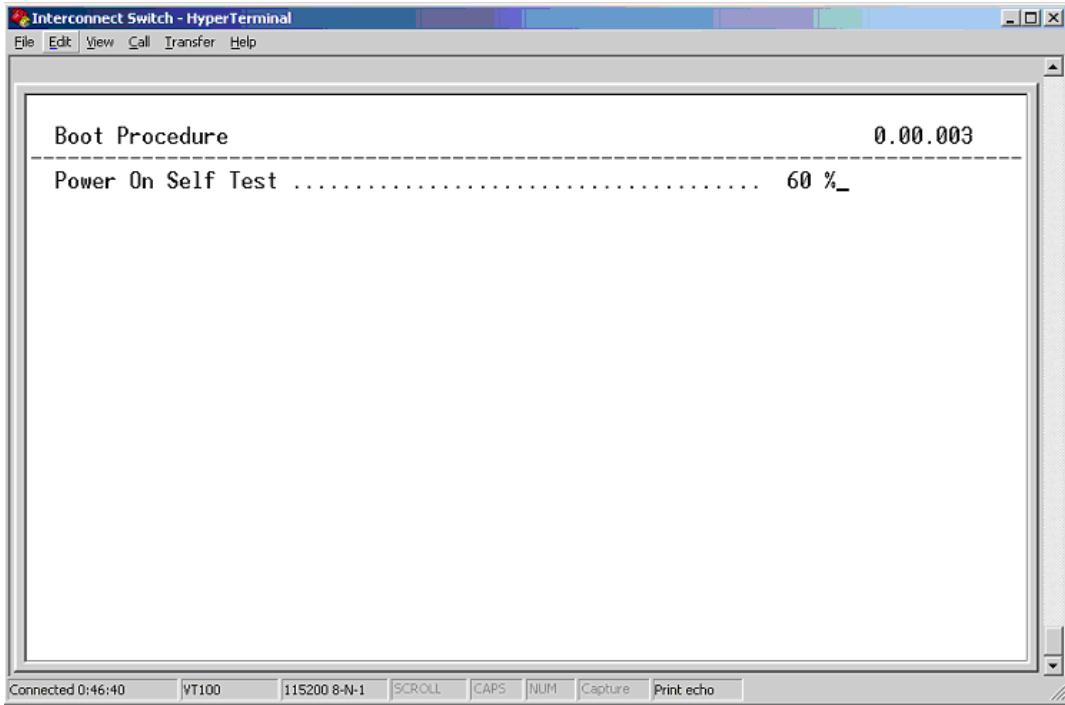

**Figure F-1: POST message screen**

3. Press the # key (**Shift+3**) as soon as you see the Boot Procedure header and before the POST line reads 100%. This action forces the GbE Interconnect Switch into the download mode. A screen similar to the following should be displayed. If this screen is not displayed, repeat step 2.

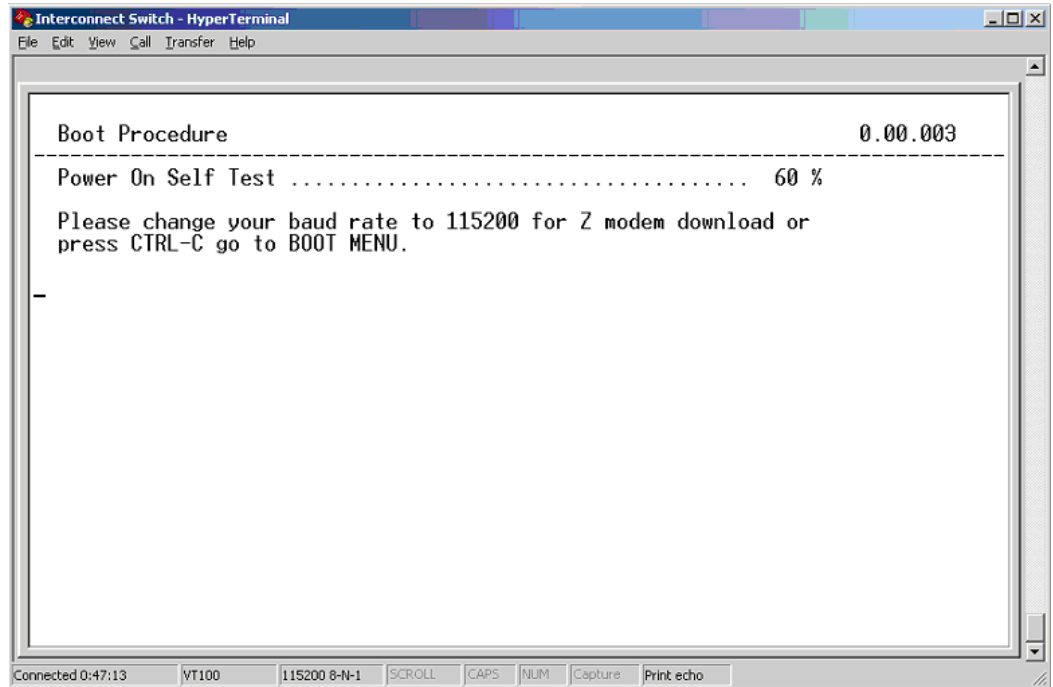
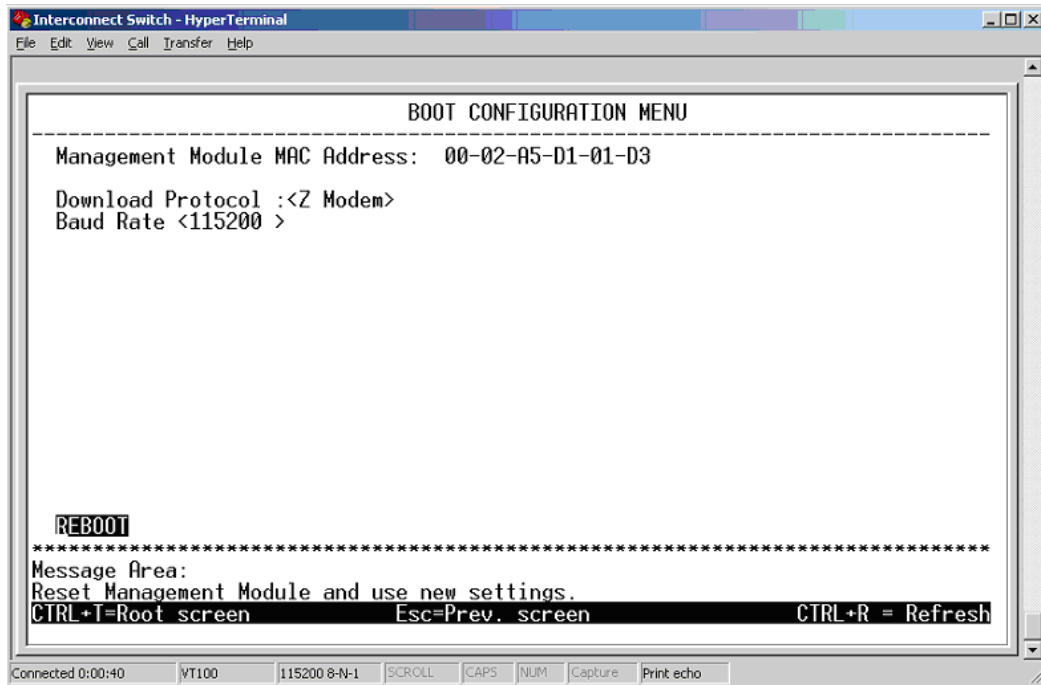

**Figure F-2: Download mode message screen**

4. At this point, one of the following two actions can be selected:
  - To download firmware using the current boot configuration, go to step 11.
  - To change the baud rate and download protocol of the boot configuration, go to step 5.

- To change the download parameters, press the **Ctrl+C** keys within two seconds of pressing the **#** key (**Shift+3**) to display the **Boot Configuration Menu**. A screen similar to the following is displayed.

**NOTE:** If HyperTerminal starts displaying unusual characters on the screen, it has skipped the Boot Configuration mode and is in the firmware download mode. Wait for it to display "Please change your baud rate to ..." (this is repeated until the download is started or it is in the Boot Configuration mode). At this point, try pressing the **Ctrl+C** keys again.

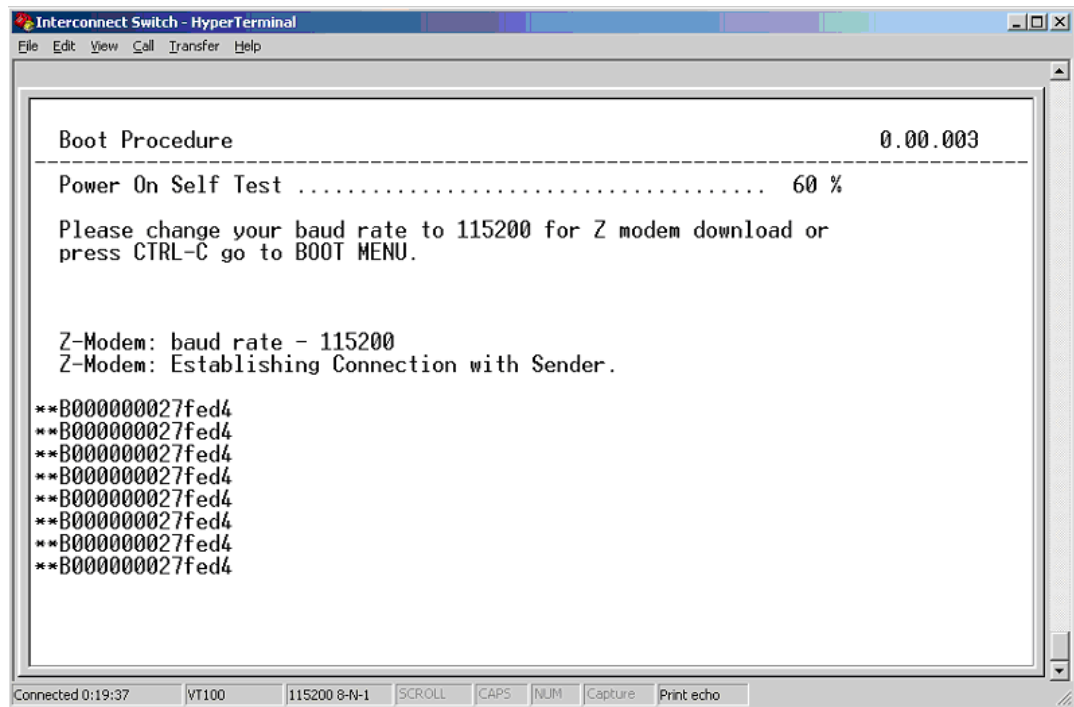

**Figure F-3: Boot Configuration Menu**

- Select the download protocol by using the space bar to toggle between **XModem** and **ZModem**. Use the down arrow to highlight the baud rate.
- Select the baud rate by using the space bar to toggle between **9600**, **19200**, **38400**, and **115200**.
- Use the down arrow to highlight **Reboot**.
- Press the **Enter** key. The GbE Interconnect Switch will reboot.
- To continue with the system firmware download, press the **#** key (**Shift+3**) as soon as you see the Boot Procedure header and before the POST line reads 100%. This forces the GbE Interconnect Switch into the download mode. A screen similar to Figure F-2 should be displayed. If this screen is not displayed, reboot the GbE Interconnect Switch using the instructions in step 2.

11. While the GbE Interconnect Switch is in the download mode, change the baud rate of the HyperTerminal session to match the baud rate of the GbE Interconnect Switch shown in the display window. (The default is 115200, which is the fastest. If you need to change the baud rate of the GbE Interconnect Switch, refer to steps 5 through 9 for instructions.) To change the baud rate:
  - a. Disconnect the HyperTerminal session by selecting **Call** from the **Interconnect Switch – HyperTerminal** window menu, and then selecting **Disconnect**.
  - b. From the **Interconnect Switch – HyperTerminal** window menu, select **File** then **Properties**.
  - c. Click **Configure**.
  - d. Make the necessary changes to the baud rate and click **OK**.
  - e. After connecting HyperTerminal, a connection established message is displayed, as shown in Figure F-4.

**IMPORTANT:** If the following screen displays unusual characters, this indicates a mismatched baud rate configuration somewhere in the network. Check HyperTerminal to determine if the baud rate setting on the GbE Interconnect Switch console interface and the HyperTerminal are mismatched.



**Figure F-4: Connection established message screen**

- From the **Interconnect Switch – HyperTerminal** window menu, select **Transfer** then **Send File**. The following window is displayed.

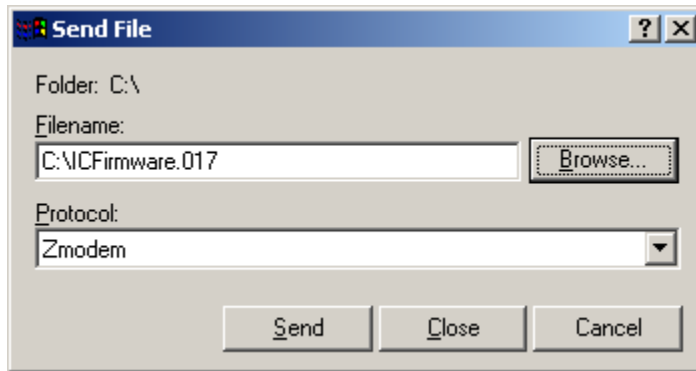

**Figure F-5: Send File window**

- Click **Browse** and select the firmware file to be downloaded to the GbE Interconnect Switch.
- Click the drop-down button to select the download protocol that is shown in the **Interconnect Switch – HyperTerminal** display window (ZModem or XModem).
- Click **Send** to start the download process. The following screen is displayed.

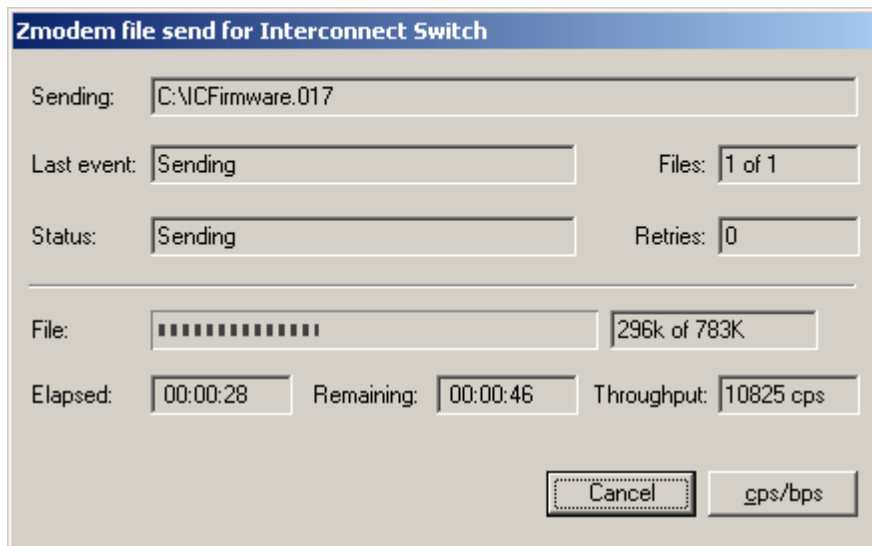

**Figure F-6: ZModem file send for Interconnect Switch window**

After the firmware file transfer is complete, a download completed message is displayed.

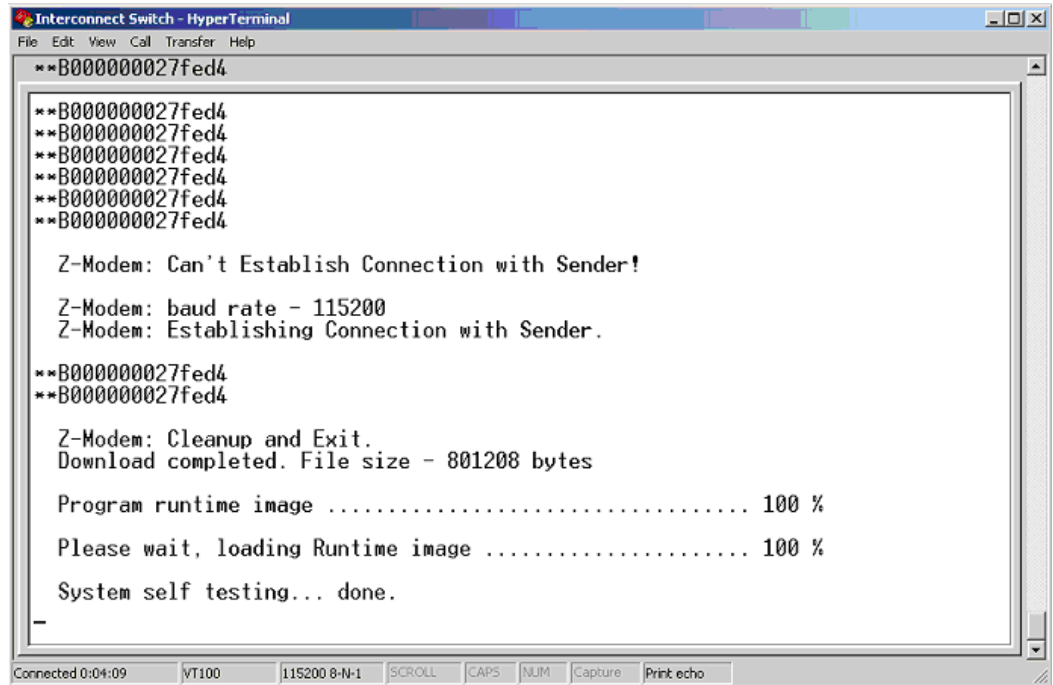

**Figure F-7: Download completed message screen**

- Set your HyperTerminal session baud rate to match the Console interface settings in runtime mode if they are different and press any key.

The GbE Interconnect Switch login screen is displayed. This completes the firmware download procedure.

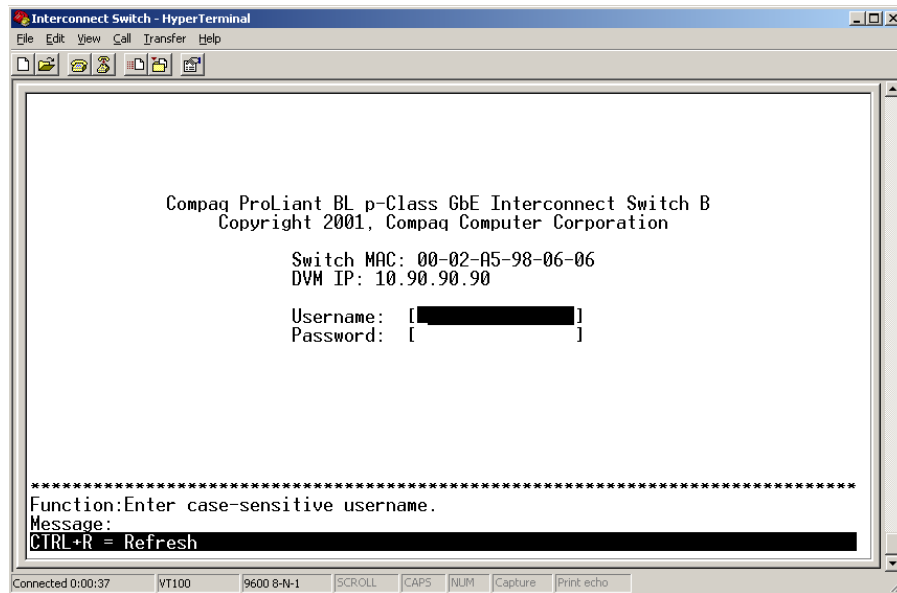

**Figure F-8: ProLiant BL p-Class GbE Interconnect Switch login screen**

---

## Troubleshooting

This section provides information on solutions to problems that may occur during the configuration and operation of ProLiant BL p-Class GbE Interconnect Switch. The following tables provide steps to take before calling your service representative.

Following are four tables with basic troubleshooting information:

- **Setting Up and Accessing**—Table G-1 contains general troubleshooting information about setting up and accessing the GbE Interconnect Switch. Topics covered include LEDs, cables, failure of the GbE Interconnect Switch to get IP settings, failure to connect to the GbE Interconnect Switch remotely, and what to do if you forget your administrator user name and password.
- **Configuring**—Table G-2 contains general troubleshooting information about configuring the GbE Interconnect Switch. Topics covered include configuring VLANs, XConnect ports, and SLIP settings.
- **Using a TFTP Server**—Table G-3 contains general troubleshooting information about using a TFTP server to back up GbE Interconnect Switch configuration or to configure multiple GbE Interconnect Switches.
- **Upgrading Firmware Using the Serial Port**—Table G-4 contains general troubleshooting information about upgrading system firmware using the serial console port.

For additional troubleshooting information:

- Refer to Appendix D, Spanning Tree Protocol
- Visit the Compaq website:  
[www.compaq.com/support/](http://www.compaq.com/support/)



**Table G-1: Troubleshooting: Setting Up and Accessing**

Problem	Possible Cause	Possible Solution
<p>Forgot the administrator user name and password that you configured on the GbE Interconnect Switch.</p>	<p>Unknown</p>	<p>Call Compaq technical support at 1-800-OK COMPAQ or your service representative and provide your GbE Interconnect Switch MAC address (available on the MAC address label attached to your GbE Interconnect Switch) to obtain a unique switch password. This password gives you Root privileges. After receiving the password, do the following:</p> <ol style="list-style-type: none"> <li>1. Reboot the GbE Interconnect Switch.</li> <li>2. Access the console interface.</li> <li>3. Within 60 seconds of when the Logon screen displays, type the password in the <b>Password</b> field.</li> <li>4. Leave the <b>Username</b> field blank.</li> <li>5. Press the <b>Enter</b> key. The main menu will be displayed.</li> <li>6. Access the <b>User Accounts Management</b> option and set a new Administrator password. (Refer to Chapter 3.)</li> </ol> <hr/> <p>If you do not need to preserve your GbE Interconnect Switch configuration, reload the factory default settings:</p> <ol style="list-style-type: none"> <li>1. Power off the system.</li> <li>2. Power on the system. The console interface logon screen is displayed.</li> <li>3. In the <b>Username</b> field, do the following very quickly: Press the <b>Esc</b> key and type <code>DLKS</code>.</li> <li>4. At the prompt (<code>&gt;</code>), type <code>FactoryReset</code>.</li> <li>5. A message is displayed indicating that the system is rebooting. The factory defaults reload and the GbE Interconnect switch reboots.</li> <li>6. Follow the directions to log on to the GbE Interconnect Switch for the first time. Refer to "Logging on to the GbE Interconnect Switch" in Chapter 3.</li> </ol>

*continued*

**Table G-1: Troubleshooting: Setting Up and Accessing** *continued*

<b>Problem</b>	<b>Possible Cause</b>	<b>Possible Solution</b>
The Power LED on the GbE Interconnect Switch is not on.	The GbE Interconnect Switch is not seated properly.	Make sure that the GbE Interconnect Switch is inserted completely and seated properly.
	The server blade enclosure is not powered up.	Make sure that the server blade enclosure is powered up and all the power connections are intact.
The Power LED on the GbE Interconnect Switch stays amber for more than 30 seconds and GbE Interconnect Switch does not boot.	The standby mode time out function is malfunctioning.	Force the GbE Interconnect Switch to boot by pressing the <b>Pwr/Rst</b> button.
No link LED displays, even after you plug the Category 5 cable in the RJ-45 connector of the external port.	The cable is not properly plugged in.	Check the cable to ensure that it is plugged in and seated properly.
	The cable or connector heads are faulty.	Replace the cable with another tested cable.
	The RJ-45 connector on the switch or LED is faulty.	After checking and replacing the cable, if no link LED displays, check whether the port is transferring data. If yes, the LED is faulty. If no, it could be a faulty RJ-45 connector. Call your service representative.
Cannot access the GbE Interconnect Switch serial console interface using null modem connection from a PC Terminal Emulation Program.	The null modem cable is faulty.	Make sure that you use the null modem cable provide by Compaq Computer Corporation with this hardware.
	The connection settings do not match the GbE Interconnect Switch serial settings.	Make sure that the PC Terminal Emulation session settings match the GbE Interconnect Switch serial settings.  <b>NOTE:</b> Refer to Chapter 3 for default serial settings if you are connecting to the GbE Interconnect Switch for the first time.
An error message that the GbE Interconnect Switch failed to complete the system self-testing is displayed on the serial console screen.	The system diagnostic tests failed.	Note the reason for the failure from the serial console screen message and call your service representative.
The keyboard locks up when using HyperTerminal to log on to the GbE Interconnect Switch through the console interface.	Scroll lock is on.	Press the <b>Scroll Lock</b> key on the keyboard and make sure that the scroll lock is off.

*continued*

**Table G-1: Troubleshooting: Setting Up and Accessing** *continued*

<b>Problem</b>	<b>Possible Cause</b>	<b>Possible Solution</b>
<p>The GbE Interconnect Switch fails to get its IP settings from the DHCP server, even though by default it is configured for DHCP.</p> <p><b>NOTE:</b> If you are running in spanning tree mode, it can take up to 90 seconds for the GbE Interconnect Switch to get its IP settings.</p>	<p>The GbE Interconnect Switch is not connected properly to the network.</p>	<p>Check the cable and connections and make sure that there is network connectivity between the GbE Interconnect Switch and the DHCP server.</p>
	<p>The DHCP server is not available on the network or VLAN that is attached to the switch management port.</p>	<p>Make sure that the DHCP server is present on the network or VLAN attached to the GbE Interconnect Switch.</p>
	<p>The DHCP server cannot offer IP settings to the GbE Interconnect Switch because no IP addresses are available.</p>	<p>Add additional IP addresses as necessary.</p>
	<p>The GbE Interconnect Switch timed out its request for IP settings.</p>	<ul style="list-style-type: none"> <li>• Go to the <b>Switch IP Settings</b> screen and click <b>Apply</b> to make the GbE Interconnect Switch retry DHCP.</li> <li>• Reset and reboot the GbE Interconnect Switch.</li> </ul>
<p>Cannot connect to the GbE Interconnect Switch console interface remotely using Telnet.</p>	<p>The GbE Interconnect Switch IP address may not be configured or correct.</p>	<ul style="list-style-type: none"> <li>• From the serial console interface on the <b>Switch IP Settings</b> screen, make sure that the GbE Interconnect Switch IP address is configured and valid on your network.</li> <li>• Use the correct IP address to establish the Telnet connection with the GbE Interconnect Switch.</li> </ul>
	<p>The setting allowing access to the GbE Interconnect Switch using the Telnet interface is disabled.</p>	<p>From the serial console interface on the <b>Advanced Switch Settings</b> screen, make sure that the Telnet interface is enabled.</p>
	<p>The Security IP list (if used) does not contain the IP address of your management station.</p>	<p>From the <b>SNMP Manager Configuration</b> screen, make sure that the Security IP list or Management IP Station list has the IP address of your management station.</p>

*continued*

**Table G-1: Troubleshooting: Setting Up and Accessing** *continued*

Problem	Possible Cause	Possible Solution
<p>Cannot connect to the GbE Interconnect Switch remotely using the Web interface.</p>	<p>The GbE Interconnect Switch IP address may not be configured or correct.</p>	<ul style="list-style-type: none"> <li>From the serial console interface on the <b>Switch IP Settings</b> screen, make sure that the GbE Interconnect Switch IP address is configured and valid on your network.</li> <li>Use the correct IP address to establish the Web connection with the GbE Interconnect Switch.</li> </ul>
	<p>Access to the GbE Interconnect Switch using the Web interface is disabled.</p>	<p>From the serial console interface on the <b>Advanced Switch Settings</b> screen, make sure that the Web interface is enabled.</p>
	<p>The Proxy server settings are configured on your Internet browser and your proxy server does not know the GbE Interconnect Switch IP address.</p>	<p>Disable the manual proxy settings on your Internet browser and let it automatically find Web servers using the IP address.</p>
	<p>The Security IP list (if used) does not contain the IP address of your management station.</p>	<p>From the <b>SNMP Manager Configuration</b> screen, make sure that the Security IP list or Management IP Station list has the IP address of your management station.</p>
<p>Cannot connect to the GbE Interconnect Switch SNMP interface.</p>	<p>The GbE Interconnect Switch IP address may not be configured or correct.</p>	<ul style="list-style-type: none"> <li>From the serial console interface on the <b>Switch IP Settings</b> screen, make sure that the GbE Interconnect Switch IP address is configured and valid on your network.</li> <li>Use the correct IP address to establish the SNMP connection with the GbE Interconnect Switch.</li> </ul>
	<p>The Security IP list (if used) does not contain the IP address of your management station.</p>	<p>From the <b>SNMP Manager Configuration</b> screen, make sure that the security IP list or Management IP Station list has the IP address of your management station.</p>
<p>Cannot connect to the GbE Interconnect Switch management interface through the Telnet, Web, or SNMP interfaces. The IP configuration, including address settings, is valid and the VLANs are configured correctly.</p>	<p>The internal switch processor port (meant for supporting switch management interfaces) and the port to which you have connected to access the switch from the Telnet, Web, or SNMP interfaces are not in the same VLAN.</p>	<p>Make sure that the Management VLAN ID on the <b>Switch IP Settings</b> screen is the same as the VLAN ID of the port that is trying to make the Telnet, Web, or SNMP connection. If not, change it to match.</p>

**Table G-2: Troubleshooting: Configuring**

Problem	Possible Cause	Possible Solution
After connecting more than one port to another switch or destination device, the port activity LEDs continuously indicate activity.	Because there are multiple links across this device and the destination device, they form loops, which cause broadcast storms.	From the <b>Configure Spanning Tree settings</b> screen, enable STP at switch level. From the <b>Port Spanning Tree settings</b> screen, enable STP at port level if you want multiple links. Make sure that the Bypass setting is disabled. This setting prevents loops and maintains standby links for resilience in case the primary links go down.
While configuring VLANs, you cannot enable a port in multiple VLANs.	A port can be part of only one VLAN unless the port is a tagged port.	Make sure that your VLANs are 802.1Q VLANs and enable the port as a tagged port from the <b>802.1Q Static VLAN Settings</b> screen on the console interface or from the <b>VLAN settings</b> screen on the Web-based interface.
After assigning a port to multiple 802.1Q VLANs by configuring it as a tagged port, you check the PVID. It is equal to the first VLAN ID.	For port-based VLANs, ports belong to only one VLAN and only one PVID can be assigned. Port-based VLANs can be extended to other switches by cross connecting ports that have the same PVID (the same port-based VLAN).	By default, all the ports have PVID 1. The switch assigns to the port a PVID that is equal to the VLAN ID of the first VLAN that the port was enabled in. To manually configure a Port VLAN, refer to “Configuring a Port VLAN” in Chapter 3 (console management interface) and “Configuring the Port VLAN ID” in Chapter 4 (Web-based management interface).
Changing the first XConnect port settings changes the next XConnect port settings. But changes to the second XConnect port settings cannot be applied or saved.	By default, XConnect ports are bundled into a Multilink Trunk.	Because they are bundled in to a trunk, the settings of the first port are referenced and applied to the rest of the ports. So in a trunk, only the first port (reference port) is configurable and defines the characteristics of the other ports in the trunk.
While assigning the ports to VLANs, the GbE Interconnect Switch does not let the user enable two adjacent ports into two different VLANs.	The ports could be two adjacent ports that are bundled in a Multilink Trunk.	Two ports that are assigned to a Multilink Trunk cannot be assigned to two different VLANs. Either break the trunk to assign it two different VLANs or assign the ports to one VLAN.
While configuring SLIP settings, you cannot apply the setting after making the local IP address the same as the GbE Interconnect Switch IP address.	Local IP addresses cannot be same as the GbE Interconnect Switch IP address. Local IP addresses should be a different IP address from the same subnet range.	Make sure that the SLIP local IP address is not configured to be same as the GbE Interconnect Switch IP address. Make sure that it is from the same subnet range so that SLIP can function properly.
After forcing the speed, duplex, and flow control on the port, the link does not come up and transfer data properly.	Both sides need to be forced to the same settings. In case of auto-negotiation, both sides will negotiate and match the setting to make the correct link.	From the <b>Configure Ports</b> screen, make sure that the ports are forced to the same setting as the setting on the other end of the link.

**Table G-3: Troubleshooting: Using a TFTP Server**

Problem	Possible Cause	Possible Solution
<p>While using TFTP to download firmware, the GbE Interconnect Switch fails to connect to the TFTP server, or after connection the download fails.</p>	<p>The TFTP server is not available to connect to or there is connectivity failure between the switch and TFTP server.</p>	<ul style="list-style-type: none"> <li>• Make sure that the IP address of the TFTP server is correct.</li> <li>• Make sure that the TFTP server exists on the same network or VLAN as the GbE Interconnect Switch.</li> <li>• Make sure that you can ping the TFTP server from the GbE Interconnect Switch and vice versa.</li> </ul>
	<p>The firmware file is not found on the TFTP server. The file name could be wrong.</p>	<ul style="list-style-type: none"> <li>• Make sure that a valid firmware file exists on the TFTP server to download to the GbE Interconnect Switch.</li> <li>• On the GbE Interconnect Switch, check the file name you configured to download.</li> </ul>
<p>While using TFTP to download or upload a configuration file, the GbE Interconnect Switch fails to connect to the TFTP server, or after connection the download or upload fails.</p>	<p>The TFTP server is not available to connect or there is a connectivity failure between the GbE Interconnect Switch and the TFTP server.</p>	<ul style="list-style-type: none"> <li>• Make sure that the TFTP server exists on the same network or VLAN as that of the switch.</li> <li>• Make sure that you can ping the TFTP server from the switch and vice versa.</li> <li>• Make sure that the IP address of the TFTP server is correct.</li> </ul>
	<p>The configuration file is not found on the TFTP server. The file name could be wrong.</p>	<ul style="list-style-type: none"> <li>• Make sure that a valid configuration file exists on the TFTP server to download to the GbE Interconnect Switch.</li> <li>• On the GbE Interconnect Switch, check the file name you configured to download or upload.</li> </ul>
<p>While using TFTP to save the history log, the GbE Interconnect Switch fails to connect to the TFTP server, or after connection the download fails.</p>	<p>The TFTP server is not available to connect to or there is connectivity failure between the GbE Interconnect Switch and the TFTP server.</p>	<ul style="list-style-type: none"> <li>• Make sure that the IP address of the TFTP server is correct.</li> <li>• Make sure that the TFTP server and the GbE Interconnect Switch are on the same network or VLAN.</li> <li>• Make sure that you can ping the TFTP server from the GbE Interconnect Switch and vice versa.</li> </ul>

**Table G-4: Troubleshooting: Upgrading Firmware Using the Serial Port**

<b>Problem</b>	<b>Possible Cause</b>	<b>Possible Solution</b>
On the serial console screen, a message that GbE Interconnect Switch failed to load runtime image (firmware) is displayed.	The Runtime image (firmware file) is corrupt.	Download the new runtime image (firmware file) using the procedure in Appendix F.
	The Flash file system is partially corrupted.	Call your service representative.
From the serial console, pressing the pound (#) key during the boot procedure does not force the GbE Interconnect Switch into the download mode.	You did not press the pound (#) key during the time the boot procedure responds to this special key.	Press the pound (#) key immediately when you see the boot procedure starting the Power-On Self-Test. Pressing the pound (#) key in the middle of the Power-On Self-Test process puts the GbE Interconnect Switch into the download mode instead of the runtime mode.
After forcing the GbE Interconnect Switch into the download mode, the console screen displays a message to change the baud rate for your terminal emulation session for ZModem transfer and also displays unusual characters.	Your terminal emulation session baud rate does not match the GbE Interconnect Switch serial console baud rate in the download mode.	Change the baud rate of your terminal emulation session to match the GbE Interconnect Switch serial console baud rate in the download mode.  <b>NOTE:</b> The baud rate for the GbE Interconnect Switch serial console in the download mode and runtime mode are two separate settings.
After starting to download the firmware file, the download fails.	The firmware file is not the correct one or is corrupt.	<ul style="list-style-type: none"> <li>Obtain the latest firmware file that is specified for this GbE Interconnect Switch.</li> <li>Be sure that the file size matches the original one on the media.</li> </ul>
The GbE Interconnect Switch configuration is corrupt.	An error was made when saving the GbE Interconnect Switch configuration.	<p>Reboot the GbE Interconnect Switch and reload the factory settings. This action clears all settings and restores them to the initial values that were present when the GbE Interconnect Switch was purchased. Refer to “Rebooting the GbE Interconnect Switch” in Chapter 3 (console management interface) or “Resetting the GbE Interconnect Switch Configuration to Factory Defaults” in Chapter 4 (Web-based interface).</p> <p>After reloading the factory settings, reconfigure the GbE Interconnect Switch settings.</p> <p><b>NOTE:</b> When rebooting, you have the option to reset all settings except the IP address.</p>

---

## Regulatory Compliance Notices—ProLiant p-Class C-GbE Interconnect Kit

### Class A Equipment

This equipment has been tested and found to comply with the limits for a Class A digital device, pursuant to Part 15 of the FCC Rules. These limits are designed to provide reasonable protection against harmful interference when the equipment is operated in a commercial environment. This equipment generates, uses, and can radiate radio frequency energy and, if not installed and used in accordance with the instructions, may cause harmful interference to radio communications. Operation of this equipment in a residential area is likely to cause harmful interference, in which case the user will be required to correct the interference at personal expense.

### Modifications

The FCC requires the user to be notified that any changes or modifications made to this device that are not expressly approved by Compaq Computer Corporation may void the user's authority to operate the equipment.

### Cables

Connections to this device must be made with shielded cables with metallic RFI/EMI connector hoods in order to maintain compliance with FCC Rules and Regulations.

## Canadian Notice (Avis Canadien)

### Class A Equipment

This Class A digital apparatus meets all requirements of the Canadian Interference-Causing Equipment Regulations.

Cet appareil numérique de la classe A respecte toutes les exigences du Règlement sur le matériel brouilleur du Canada.



## European Union Notice



Products bearing the CE marking comply with the EMC Directive (89/336/EEC) and the Low Voltage Directive (73/23/EEC) issued by the Commission of the European Community and if this product has telecommunication functionality, the R&TTE Directive (1999/5/EC).

Compliance with these directives implies conformity to the following European Norms (in parentheses are the equivalent international standards and regulations):

- EN 55022 (CISPR 22)—Electromagnetic Interference
- EN55024 (IEC61000-4-2, 3, 4, 5, 6, 8, 11)—Electromagnetic Immunity
- EN61000-3-2 (IEC61000-3-2)—Power Line Harmonics
- EN61000-3-3 (IEC61000-3-3)—Power Line Flicker
- EN 60950 (IEC 60950)—Product Safety

## Taiwan Notice

警告使用者：

這是甲類的資訊產品，在居住的環境中使用時，可能會造成射頻干擾，在這種情況下，使用者會被要求採取某些適當的對策。

## Japanese Notice

この装置は、情報処理装置等電波障害自主規制協議会（VCCI）の基準に基づくクラスA情報技術装置です。この装置を家庭環境で使用すると電波妨害を引き起こすことがあります。この場合には使用者が適切な対策を講ずるよう要求されることがあります。

---

# Regulatory Compliance Notices—ProLiant BL p-Class F-GbE Interconnect Kit

## European Union Notice



Products bearing the CE marking comply with the EMC Directive (89/336/EEC) and the Low Voltage Directive (73/23/EEC) issued by the Commission of the European Community and if this product has telecommunication functionality, the R&TTE Directive (1999/5/EC).

Compliance with these directives implies conformity to the following European Norms (in parentheses are the equivalent international standards and regulations):

- EN 55022 (CISPR 22)—Electromagnetic Interference
- EN55024 (IEC61000-4-2, 3, 4, 5, 6, 8, 11)—Electromagnetic Immunity
- EN61000-3-2 (IEC61000-3-2)—Power Line Harmonics
- EN61000-3-3 (IEC61000-3-3)—Power Line Flicker
- EN 60950 (IEC 60950)—Product Safety

## A

- accessing switch
  - procedure 2-8
  - troubleshooting G-2
- accounts, user
  - console management interface 3-4
  - Web-based management interface 4-35
- active switch graphic 4-37
- advanced settings
  - console management interface 3-12
  - Web-based management interface 4-8
- architecture, switch 1-4
- Auto-Logout 3-13
- Auto-Logout of Console & Telnet 4-8

## B

- Backpressure
  - console management interface 3-14
  - Web-based management interface 4-9
- bandwidth, configuring
  - console management interface 3-15
  - Web-based management interface 4-24
- basic settings
  - console management interface 3-12
  - Web-based management interface 4-7
- blocking state, STP D-1, D-12
- Bootstrap Protocol (BOOTP)
  - IP address assignment 3-10
  - overview 1-8
- broadcast storm
  - configuring threshold 3-34, 4-26
  - troubleshooting D-11
- browsers 4-1

## C

- cabling of switch
  - procedures 2-7
  - reduction feature 1-2, 1-4
  - specifications A-2
- Canadian regulatory notice H-1

- Carrier Sense Multiple Access with Collision Detection (CSMA/CD) 1-6
- Class of Service (CoS)
  - console management interface 3-36
  - overview 1-8
  - Web-based management interface 4-29
- class of traffic
  - console management interface 3-38
  - Web-based management interface 4-28
- community names, SNMP 3-51
- Compaq authorized reseller xi
- Compaq ProLiant BL p-Class C-GbE Interconnect Kit features 1-1
- Compaq ProLiant BL p-Class F-GbE Interconnect Kit features 1-2
- Compaq ProLiant BL p-Class GbE Interconnect Switch
  - architecture 1-4
  - console management interface 3-1
  - external components 1-8
  - installing 2-1
  - runtime switching software settings C-1
  - SNMP/RMON MIBs support E-1
  - specifications A-1
  - supported technologies 1-5
  - troubleshooting G-1
  - Web-based management interface 4-1
- Compaq website xi
- configuration
  - console management interface 3-1
  - features 1-3
  - manual 2-6
  - multiple switches 2-6
  - planning for 2-4
  - specific procedures 2-9
  - troubleshooting G-6
  - Web-based management interface 4-1
- connecting procedures
  - console management interface method 3-1
  - Web-based management interface 4-2
- connection timeout 4-59
- console management interface
  - connecting procedures 3-1
  - login procedures 3-3
  - managing user accounts 3-7

- monitoring switch functions 3-42
- navigation features 3-2
- overview 3-1
- rebooting 3-58
- saving changes 3-6
- SNMP manager configuration 3-51
- specific configuration procedures 3-9
- system utilities 3-53
- upgrading firmware 3-54, F-1
- user setup 3-4

crosslinks, redundant 1-5

CSMA/CD (Carrier Sense Multiple Access with Collision Detection) 1-6

current egress bandwidth settings

- console management interface 3-19
- Web-based management interface 4-25

current ingress bandwidth settings

- console management interface 3-17
- Web-based management interface 4-24

**D**

data loop, identifying D-11

data transfer rates A-1

DA-unknown storm, configuring threshold

- console management interface 3-34
- Web-based management interface 4-26

default settings

- parameters to set 2-4
- port priority 3-37, 4-27
- resetting factory defaults 4-58
- runtime switching software C-1

deleting user accounts 3-9

Destination-Address Filtering table 3-22

DHCP (Dynamic Host Configuration Protocol)

- IP address assignment 3-10
- overview 1-8

diagnostics tools 1-4

disabled state, STP D-6

DualTSX Interconnect Module

- LED indicators 1-15
- location 1-14
- overview 1-2

Dynamic Group Registration Table

- console management interface 3-50
- Web-based management interface 4-51

**E**

egress bandwidth settings

- console management interface 3-18
- Web-based management interface 4-25

enterprise-specific MIBs E-2

error packets, monitoring

- console management interface 3-45
- Web-based management interface 4-43

errors, resource D-11

Ethernet ports/connectors

- features 1-2
- locations 1-12, 1-14
- specifications A-1

European Union regulatory notice H-2, I-1

external components, overview 1-8

**F**

factory default reset 4-58

failover features 1-3

features 1-2, 3-2

Federal Communications Commission (FCC)

- notice H-1

field-level help 3-2

firmware upgrades

- console management interface 3-54, F-1
- troubleshooting G-8
- Web-based management interface 4-53

Forward Delay setting and resource errors D-11

forwarding state, STP D-5

front panel components, overview 1-9

full/half duplex mismatch problems D-9

**G**

Group Address Filter Mode 3-13, 4-9

GVRP (GARP VLAN Registration Protocol) settings

- console management interface 3-13, 3-29
- Web-based management interface 4-9, 4-23

**H**

hardware installation 2-1

help resources

- console management interface 3-2
- general xi

history, switch

- console management interface 3-48
- saving with TFTP server 3-57
- Web-based management interface 4-55

HTTP protocol 4-1

**I**

IEEE 802.1p-based class of service 1-8

IEEE 802.1Q-based VLAN 1-6

IEEE/ANSI standards, specifications A-1

IGMP (Internet Group Management Protocol)

- snooping
- advanced settings 3-13, 4-9
- configuring 3-30, 4-14
- monitoring 3-48, 4-51
- overview 1-8

ingress bandwidth settings

- console management interface 3-16
- Web-based management interface 4-24
- ingress filtering of ports 3-28, 4-22
- installation
  - additional information 2-10
  - cabling 2-7
  - hardware 2-1
  - initial power-up 2-8
  - overview 2-1
  - planning configuration 2-4
  - troubleshooting G-2
- Integrated Lights Out (iLO)
  - switch architecture 1-5
  - VLAN features 1-6
- interconnect modules
  - accessing switch with 2-8
  - cabling procedure 2-7
  - DualTSX 1-2, 1-14, 1-15
  - installation 2-2
  - QuadT 1-12, 1-13
- IP addresses
  - console management interface 3-9
  - DHCP and BOOTP sources for 1-8
  - security 4-33
  - TFTP server 2-6
  - Web-based management interface 4-2, 4-6

**J**

- Japanese regulatory notice H-2

**L**

- LAN (local area network) 1-6
- Layer 2-Based Packet Forwarding 1-6
- learning state, STP D-4
- LED indicators
  - DualTSX module 1-15
  - QuadT module 1-13
  - switch front panel 1-10
- listening state, STP D-2
- load balancing 1-7
- local area network (LAN) 1-6
- login procedures
  - console management interface 3-3
  - initial setup 2-5
  - specific 2-9
  - Web-based management interface 4-3
- logout procedures
  - console management interface 3-60
  - Web-based management interface 4-60

**M**

- MAC Address Aging Time (sec) 3-13, 4-9
- MAC addresses

- configuring 3-40, 4-31
- monitoring 3-47, 4-50
- Maintenance menu 4-53
- manual assignment of IP addresses 3-11
- manual configuration 2-6
- Max Age and resource errors D-11
- MIBs (Management Information Bases) E-1
- Microsoft Internet Explorer 4-1
- mirroring of ports
  - console management interface 3-33
  - overview 1-7
  - Web-based management interface 4-12
- multicast filtering, configuring
  - console management interface 3-24
  - IGMP 1-8
  - Web-based management interface 4-19
- multicast storm, configuring
  - console management interface 3-34
  - Web-based management interface 4-26
- multiple-switch configuration 2-6

**N**

- navigation features 3-2
- Netscape Navigator 4-1
- Network Monitoring Menu 3-42
- new deployment installation 2-2
- new users, setting up
  - console management interface 3-4
  - Web-based management interface 4-3
- NICs (network interface cards), LED functions 1-11
- NVRAM (non-volatile RAM) 3-6, 4-5

**O**

- Open Systems Interconnection (OSI) model 1-6

**P**

- packets, data
  - corruption of D-10
  - error monitoring 3-45, 4-43
  - forwarding technology 1-6
  - monitoring 3-46, 4-38
  - prioritization service 1-8, 3-36, 4-29
  - size monitoring 3-46, 4-46
- patch panels, upgrading from 2-4
- performance features 1-2
- performance specifications A-3
- physical and environmental specifications A-3
- ping test
  - console management interface 3-58
  - Web-based management interface 4-57
- port trunking, configuring
  - console management interface 3-31
  - Web-based management interface 4-13

- port VLAN ID (PVID) 4-22
  - ports
    - assigning VLANs to 3-27
    - configuring settings 3-14, 4-10, 4-17
    - default priority 3-37, 4-27
    - full/half duplex mismatch problem D-9
    - GVRP settings 3-29, 4-9
    - ingress filtering for 3-28
    - locations 1-12, 1-14
    - management tips D-12
    - mirroring of 1-7, 3-33, 4-12
    - monitoring utilization 3-43, 4-38
    - name defaults C-4
    - security for 3-39, 4-30
    - specifications A-2
  - power-up procedures, initial 2-8
  - priority MAC addresses
    - console management interface 3-40
    - Web-based management interface 4-31
  - priority, port
    - console management interface 3-37
    - CoS packet 1-8
    - Web-based management interface 4-27
  - privileges, user 2-5
  - protocols, network
    - BOOTP 1-8, 3-10
    - DHCP 1-8, 3-10
    - GVRP 3-13, 3-29, 4-9
    - HTTP 4-1
    - overview 1-6
    - SLIP 3-41, 4-32
    - specifications A-1
    - XModem/ZModem F-1
  - PVID (port VLAN ID) 4-22
- Q**
- QuadT Interconnect Module
    - LED indicators 1-13
    - location 1-12
    - overview 1-1
- R**
- rebooting switch
    - console management interface 3-58
    - Web-based management interface 4-59
  - received (RX) packets 4-39, 4-43
  - redundancy features
    - crosslinks 1-5
    - identifying links D-12
    - overview 1-3
  - regulatory compliance notices H-1
  - remote access to switch 2-8
  - remote monitoring (RMON)
    - overview 1-7
    - SNMP/RMON MIBs support E-1
  - replacing switch 2-3
  - resource errors D-11
  - restart egress bandwidth settings
    - console management interface 3-18
    - Web-based management interface 4-25
  - restart ingress bandwidth settings
    - console management interface 3-16
    - Web-based management interface 4-24
  - RJ-45 connectors
    - location 1-12, 1-14
    - pin specifications B-1
  - RJ-45 patch panels, upgrading from 2-4
  - RMON (remote monitoring)
    - overview 1-7
    - SNMP/RMON MIBs support E-1
  - roots for VLANs, importance of D-12
  - RS232, configuring
    - console management interface 3-41
    - Web-based management interface 4-32
  - runtime switching software C-1
- S**
- safety information resources ix
  - saving changes
    - console management interface 3-6
    - Web-based management interface 4-5
  - Scheduling Mechanism for CoS Queues
    - console management interface 3-14
    - Web-based management interface 4-9
  - security
    - configuring IP address 4-33
    - configuring port 3-39, 4-30
    - overview 2-5
  - serial port, upgrading firmware from F-1, G-8
  - server blades, features 1-2
  - size of packets, monitoring
    - console management interface 3-46
    - Web-based management interface 4-46
  - SLIP (serial line Internet protocol)
    - console management interface 3-41
    - Web-based management interface 4-32
  - SNMP (Simple Network Management Protocol)
    - configuring 3-51, 4-34
    - overview 1-7
    - SNMP script utility 2-6
    - SNMP/RMON MIBs support E-1
  - spanning tree protocol (STP)
    - configuring 3-19, 4-15
    - overview 1-3, 1-6
    - states D-1
    - STP/Bypass default settings C-4
    - troubleshooting D-8
  - specifications
    - RJ-45 pin B-1

- switch A-1
- stacking feature 1-12
- standard MIBs E-2
- standards, IEEE/ANSI A-1
- static (Destination-Address Filtering) table 3-22
- static VLAN entry
  - console management interface 3-26
  - Web-based management interface 4-19
- storage and forward switching scheme 1-7
- Switch GVRP 3-13
- symbols in text ix
- system messages 3-2
- system utilities 3-53

## T

- Taiwan regulatory notice H-2
- technician notes ix
- telephone numbers xi
- Telnet protocol 3-2
- Telnet Status
  - console management interface 3-13
  - Web-based management interface 4-9
- terminal connection to switch 3-1
- text conventions xi
- text symbols ix
- TFTP (Trivial File Transfer Protocol) server
  - multiple switch configurations 2-6
  - overview 1-7
  - troubleshooting G-7
  - updating switch from 3-54
  - Web-based management interface 4-53
- timeout, connection 4-59
- traffic classes, configuring
  - console management interface 3-38
  - Web-based management interface 4-28
- transmitted (TX) packets 4-42, 4-45
- trap manager, configuring 4-35
- troubleshooting
  - spanning tree protocol D-8
  - switch G-1
- Trunk Load Sharing Algorithm
  - console management interface 3-14
  - Web-based management interface 4-9
- trunking feature
  - configuring 3-31, 4-13
  - default settings C-4
  - monitoring utilization 3-44, 4-48
  - overview 1-7

## U

- UMB-cast (RX) packets 4-40

- unicast filtering, configuring
  - console management interface 3-23
  - Web-based management interface 4-18
- unidirectional link problem D-10
- updating user accounts 3-8
- upgrading firmware
  - console management interface 3-54
  - through serial port F-1
  - troubleshooting G-8
  - Web-based management interface 4-53
- upgrading from RJ-45 patch panels 2-4
- uplink issues 1-5
- users
  - managing accounts 4-35
  - privilege levels 2-5
  - setup procedures 3-4, 4-3
- utilities, system 3-53

## V

- ventilation clearances x
- VLAN ID 2-4, 4-22
- VLANs (virtual local area networks)
  - configuring 3-25, 4-19
  - default settings C-4
  - features 1-6
  - importance of root bridge D-12
  - monitoring 3-51, 4-52
  - overview 1-3

## W

- Web browsers 4-1
- Web Status 3-13, 4-9
- Web-based management interface
  - connecting procedures 4-2
  - introduction 4-1
  - login procedures 4-3
  - maintaining switch 4-53
  - monitoring functions 4-37
  - new user setup 4-3
  - saving changes 4-5
  - specific configuration procedures 4-5
- website, Compaq xi

## X

- XModem protocol F-1

## Z

- ZModem protocol F-1

## Free Manuals Download Website

<http://myh66.com>

<http://usermanuals.us>

<http://www.somanuals.com>

<http://www.4manuals.cc>

<http://www.manual-lib.com>

<http://www.404manual.com>

<http://www.luxmanual.com>

<http://aubethermostatmanual.com>

Golf course search by state

<http://golfingnear.com>

Email search by domain

<http://emailbydomain.com>

Auto manuals search

<http://auto.somanuals.com>

TV manuals search

<http://tv.somanuals.com>