

DocuPrint CM505 da



User Guide



SD Logo is a trademark of SD-3C, LLC.

Microsoft, Windows, Windows NT, Windows Server, Windows Vista, Microsoft Network, and Internet Explorer are trademarks or registered trademarks of Microsoft Corporation in the U.S. and other countries.

NetWare is a registered trademark of Novell, Inc. in the United States and other countries.

Adobe, Acrobat, PostScript, and Adobe PostScript 3 are trademarks of Adobe Systems Incorporated.

EtherTalk, Macintosh, and Mac OS are registered trademarks of Apple Inc.

PCL, HP-GL, and HP-GL/2 are registered trademarks of Hewlett-Packard Corporation.

RSA and BSAFE are either registered trademarks or trademarks of RSA Security Inc. in the United States and/or other countries.

RSA Security Inc. All right reserved.

All product/brand names are trademarks or registered trademarks of the respective holders.

Microsoft product screen shot(s) reprinted with permission from Microsoft Corporation.

For information on license, refer to About License.

In this manual, safety instructions are preceded by the symbol . Always read and follow the instructions before performing the required procedures.

The data saved in the hard disk of the machine may be lost if there is any problem in the hard disk. Fuji Xerox is not responsible for any direct and indirect damages arising from or caused by such data loss.

Fuji Xerox is not responsible for any breakdown of machines due to infection of computer virus or computer hacking.

#### **Important**

1. This manual is copyrighted with all rights reserved. Under the copyright laws, this manual may not be copied or modified in whole or part, without the written consent of the publisher.
2. Parts of this manual are subject to change without prior notice.
3. We welcome any comments on ambiguities, errors, omissions, or missing pages.
4. Never attempt any procedure on the machine that is not specifically described in this manual. Unauthorized operation can cause faults or accidents. Fuji Xerox is not liable for any problems resulting from unauthorized operation of the equipment.

An export of this product is strictly controlled in accordance with Laws concerning Foreign Exchange and Foreign Trade of Japan and/or the export control regulations of the United States.

XEROX, the sphere of connectivity design, PDF Bridge, ContentsBridge, and CentreWare are trademarks or registered trademarks of Xerox Corporation in the U.S. or Fuji Xerox Co., Ltd.

DocuWorks is a trademark of Fuji Xerox Co., Ltd.

# Table of Contents

---

Table of Contents .....	3
<b>1 Before Using the Machine .....</b>	<b>13</b>
Preface .....	14
Types of Manuals .....	15
Using This Guide .....	16
Organization of This Guide .....	16
Conventions .....	16
Safety Notes .....	19
Electrical Safety .....	20
Machine Installation .....	21
Operational Safety .....	23
Consumable .....	27
Location of Warning and Caution Labels .....	27
Regulation .....	29
Radio Frequency Emissions (Class B) .....	29
Product Safety Certification (UL, CB) .....	29
Environment .....	30
About License .....	31
RSA BSAFE .....	31
Heimdal .....	31
JPEG Code .....	31
Libcurl .....	31
FreeBSD .....	32
OpenLDAP .....	33
DES .....	35
AES .....	35
TIFF (libtiff) .....	35
ICC Profile (Little cms) .....	35
XPS (XML Paper Specification) .....	35
EDICT and COMPDIC .....	35
Cyrus SASL .....	36
Legal Notice .....	38
<b>2 Product Overview .....</b>	<b>39</b>
Machine Components .....	40
Front, Side, Top, and Rear View .....	40
Power Source .....	44
Switching the Main Power On .....	44
Switching the Power On .....	44
Switching the Power Off .....	45
Switching the Main Power Off .....	45

---

Ground Fault Interrupter .....	47
Energy Saver Mode.....	48
Entering the Energy Saver Mode.....	48
Exiting the Energy Saver Mode .....	48
Control Panel.....	50
Screens and Buttons Displayed.....	53
About the [Services Home] Screen .....	54
Entering Text.....	58
<b>3 Copy .....</b>	<b>59</b>
Copying Procedure.....	60
Step 1 Loading Documents .....	60
Step 2 Selecting Features .....	62
Step 3 Entering a Quantity.....	63
Step 4 Starting the Copy Job.....	64
Step 5 Confirming the Copy Job in Job Status .....	65
Operations during Copying.....	66
Stopping the Copy Job .....	66
Changing the Number of Copies .....	67
Interrupting the Copy Job .....	68
Simple Copy .....	69
Paper Supply (Selecting the Paper for Copying).....	69
Reduce/Enlarge (Making Enlarged/Reduced Copies).....	70
2 Sided Copying (Making 2 Sided Copies).....	71
Black & White/Color (Selecting the Color for Copying).....	71
Lighten/Darken (Adjusting the Copy Density).....	72
2 Pages Up (Copying Two Pages onto One Sheet) .....	72
Original Orientation (Specifying the Orientation of Loaded Documents).....	72
Copy .....	74
Reduce/Enlarge (Making Enlarged/Reduced Copies).....	74
Paper Supply (Selecting the Paper for Copying).....	77
Output Color (Selecting the Color for Copying).....	80
2 Sided Copying (Making 2 Sided Copies).....	85
Copy Output (Specifying Finishing Options).....	85
Pages per Side (Copying Multiple Pages onto One Sheet).....	85
Lighten/Darken (Adjusting the Copy Density).....	85
Image Quality .....	86
Original Type (Selecting the Document Type).....	86
Image Options (Adjusting Copy Density/Sharpness/Saturation of Images) .....	87
Image Enhancement (Erasing the Background Color of Documents/Adjusting Contrast).....	88
Color Effects (Selecting an Image Quality).....	89
Color Balance (Adjusting Color Balance) .....	90
Color Shift (Adjusting the Color Tone).....	92



---

Layout Adjustment.....	93
2 Sided Copying (Making 2 Sided Copies) .....	93
Book Copying (Copying Facing Pages onto Separate Sheets) .....	95
2 Sided Book Copying (Making 2 Sided Copies of Facing Pages).....	96
Original Size (Specifying the Scan Size for the Document).....	98
Mixed Size Originals (Scanning Different Size Documents Simultaneously).....	99
Edge Erase (Erasing Edges and Margin Shadows of the Document) .....	100
Image Shift (Adjusting the Image Position).....	101
Invert Image (Making Reversed Copies of Images).....	104
Original Orientation (Specifying the Orientation of Loaded Documents) .....	104
Image Rotation (Changing the Orientation of Images) .....	105
Output Format .....	107
2 Sided Copying (Making 2 Sided Copies) .....	107
Booklet Creation (Creating a Booklet) .....	108
Covers (Attaching Covers to Copies).....	110
Pages per Side (Copying Multiple Pages onto One Sheet) .....	111
Poster (Making Enlarged Copies Spread over Multiple Sheets).....	112
Repeat Image (Making Multiple Copies on One Sheet).....	114
Preset Repeat Image (Making Multiple Copies on a Single Sheet) .....	115
Transparency Options (Inserting Blank Sheets between Transparencies).....	116
Copy Output (Specifying Finishing Options) .....	117
ID Card Copy (Copying Both Sides of an ID Card).....	119
Job Assembly .....	121
Build Job	
(Processing Documents Scanned with Different Settings as One Job) .....	121
Sample Job (Checking the Finished Output of the Copy).....	125
Combine Original Sets (Adding Originals) .....	126
Delete Outside/Delete Inside (Deleting Outside or Inside of the Selected Area)	128
Stored Programming (Calling a Stored Program for Build Job).....	130
<b>4 Fax .....</b>	<b>141</b>
Fax Procedure .....	142
Step 1 Loading Documents.....	142
Step 2 Selecting Features.....	144
Step 3 Specifying Destinations .....	145
Step 4 Starting the Fax Job .....	146
Step 5 Confirming the Fax Job in Job Status.....	147
Operations during Faxing .....	149
Stopping the Fax Job .....	149
Changing the Scan Settings .....	150
About Internet Fax.....	152
Internet Fax Features.....	152
Sending Internet Fax.....	154
Receiving Internet Fax .....	155
Useful Features.....	156

---

---

Simple Fax .....	160
Specifying a Destination Using the Numeric Keypad .....	160
Speed Dialing (Specifying a Destination Using an Address Number) .....	161
Resolution (Specifying the Scanning Resolution).....	162
Original Type (Selecting the Document Type).....	162
2 Sided Scanning (Transmitting 2-sided Originals) .....	163
Fax/Internet Fax .....	164
Internet Fax/Fax (Selecting Internet Fax/Fax) .....	164
+ Add (Sending Faxes to Multiple Recipients).....	165
Specifying a Destination Using the Address Book.....	165
Speed Dialing (Specifying a Destination Using an Address Number) .....	167
Specifying a Destination Using the Keyboard Screen .....	168
Specifying a Destination Using the Redial Feature .....	168
Entering Specific Symbols .....	169
Removing/Confirming a Recipient .....	170
Lighten/Darken (Adjusting Fax Density) .....	170
2 Sided Scanning (Transmitting 2-sided Originals) .....	171
Original Type (Selecting the Document Type).....	172
Resolution (Specifying the Scanning Resolution).....	172
Layout Adjustment.....	174
2 Sided Scanning (Transmitting 2-sided Originals) .....	174
Original Size (Specifying the Scan Size for the Original).....	174
Mixed Size Originals (Scanning Different Size Documents Simultaneously) .....	175
Book Faxing (Scanning Facing Pages onto Separate Sheets).....	176
Reduce/Enlarge (Specifying a Scan Ratio) .....	177
Fax/Internet Fax Options.....	179
Acknowledgement Report (Confirming Transmission Results) .....	179
Starting Rate (Selecting a Communication Mode).....	181
Priority Send/Delay Start (Specifying Send Priority/Send Time) .....	182
Transmission Header Text (Adding Sender Name and Phone Number to Faxes)....	184
Cover Page (Transmitting Documents With a Cover Page) .....	185
Internet Fax Subject (Specifying the Internet Fax Subject) .....	187
Internet Fax Message (Editing the Internet Fax Mail Contents) .....	187
Recipient Print Sets (Printing Multiple Sets at the Remote Machine).....	188
Pages per Side (Combining Multiple Pages into One Sheet).....	189
Remote Folder (Using Remote Folder).....	189
F Code (Using F Code Transmission) .....	192
Internet Fax Profile (Specifying Internet Fax Profiles) .....	196
Encryption (Sending Internet Fax Encrypted by S/MIME) .....	197
Digital Signature (Sending Internet Fax with a Digital Signature by S/MIME) .....	198
More Options.....	199
Remote Polling (Retrieving Files from Remote Machines).....	199
Store for Polling (Storing Files on the Machine that a Remote Machine can Retrieve)	202

---

On-hook (Confirming Remote Machine Response Prior to Transmission) .....	203
Broadcast .....	205
Broadcast Send (Transmitting to Multiple Recipients) .....	205
Relay Broadcast (Transmitting Documents Through a Relay Station) .....	205
Remote Relay Broadcast (Performing Relay Broadcast to Remote Locations)..	209
Receiving Faxes .....	213
Switching between Auto Receive and Manual Receive .....	213
Using Auto Receive .....	214
Using Manual Receive .....	214
Using Folder Receive.....	214
Facsimile Information Services.....	216
Using the Receiver.....	216
When Not Using a Receiver.....	216
<b>5 Scan .....</b>	<b>221</b>
Scanning Procedure .....	222
Step 1 Loading Documents.....	222
Step 2 Selecting the Features.....	223
Step 3 Starting the Scan Job .....	226
Step 4 Confirming the Scan Job in Job Status .....	227
Step 5 Saving the Scanned Data.....	228
Operations during Scanning .....	229
Stopping the Scan Job.....	229
Previewing the Scanned Images during a Scan Job .....	230
Changing Scan Settings .....	231
E-mail .....	232
Address Book (Specifying an E-mail Address) .....	232
New Recipient (Entering an Address).....	235
Add Me (Adding the Sender's Address).....	236
Recipient(s) (Editing a Recipient) .....	236
From (Setting the Sender's Address).....	238
Subject (Setting the Subject) .....	238
Message (Entering the E-mail Body) .....	239
Preview (Previewing the Scanned Images during a Scan Job) .....	239
Color Scanning (Selecting an Output Color).....	239
2 Sided Scanning (Scanning Both Sides of a Document).....	240
Original Type (Selecting the Document Type).....	241
File Format (Selecting a File Format for Output Data).....	242
Network Scanning .....	251
Preview (Previewing the Scanned Images during a Scan Job) .....	252
Color Scanning (Selecting an Output Color).....	252
2 Sided Scanning (Scanning Both Sides of a Document).....	252
Original Type (Selecting the Document Type).....	252
File Format (Selecting a File Format for Output Data).....	252
Scan to PC .....	253

---

---

Transfer Protocol (Selecting a Transfer Protocol) .....	253
Address Book (Specifying a Destination PC Using the Address Book).....	254
Browse (Specifying a Destination PC by Browsing Your Network) .....	255
Specifying a Destination (Specifying a Destination PC Using the Screen Keyboard).....	256
Preview (Previewing the Scanned Images during a Scan Job) .....	258
Color Scanning (Selecting an Output Color).....	258
2 Sided Scanning (Scanning Both Sides of a Document) .....	258
Original Type (Selecting the Document Type).....	258
File Format (Selecting a File Format for Output Data).....	258
Store to Folder.....	259
Color Scanning (Selecting an Output Color).....	259
2 Sided Scanning (Scanning Both Sides of a Document) .....	260
Original Type (Selecting the Document Type).....	260
Preview (Previewing the Scanned Images during a Scan Job) .....	260
Store to USB .....	261
Save in (Specifying a Storage Location in the USB Memory Device) .....	262
Details (Displaying the Details of a Storage Location in the USB Memory Device) ..	263
Preview (Previewing the Scanned Images during a Scan Job).....	264
Color Scanning (Selecting an Output Color).....	264
2 Sided Scanning (Scanning Both Sides of a Document) .....	264
Original Type (Selecting the Document Type).....	264
File Format (Selecting a File Format for Output Data).....	264
Store & Send Link .....	265
Scan To (Displaying the E-mail Address of the Authenticated User) .....	266
From (Displaying the E-mail Address of the Authenticated User) .....	266
Subject (Setting the Subject) .....	266
Message (Entering the E-mail Body) .....	266
Color Scanning (Selecting an Output Color).....	266
2 Sided Scanning (Scanning Both Sides of a Document) .....	266
Original Type (Selecting the Document Type).....	266
Preview (Previewing the Scanned Images during a Scan Job) .....	267
File Format (Selecting a File Format for Output Data).....	267
Advanced Settings .....	268
Photographs (Scanning a Color Photograph).....	268
Image Options (Adjusting Scan Density and Image Sharpness).....	269
Image Enhancement (Erasing the Background Color of Documents/Adjusting Contrast) .....	270
Shadow Suppression (Suppressing the Document Background).....	270
Color Space (Specifying the Color Space) .....	271
Layout Adjustment.....	273
Resolution (Specifying a Scanning Resolution).....	273
2 Sided Scanning (Scanning Both Sides of a Document) .....	274
Book Scanning (Scanning Facing Pages on Separate Sheets) .....	274

---

Original Size (Specifying a Scan Size) .....	275
Mixed Size Originals (Scanning Different Size Documents Simultaneously).....	276
Edge Erase (Erasing Edges and Margin Shadows in the Document) .....	277
Reduce/Enlarge (Specifying a Scanning Ratio).....	279
Original Orientation (Specifying the Orientation of the Loaded Documents) .....	279
E-mail Options/Filing Options .....	281
Quality/File Size (Specifying an Image Compression Ratio When Scanning) ....	281
Read Receipts (Specifying Read Receipts).....	282
Split Send (Sending in Sections) .....	283
File Name (Specifying a Name for the File to be Sent).....	283
Reply To (Specifying a Reply Address) .....	284
File Name Conflict (Setting the Action to be Taken for File Name Conflict) .....	285
File Name (Specifying a Name for the File to be Saved).....	285
Encryption (Sending E-mail Encrypted by S/MIME) .....	286
Digital Signature (Sending E-mail with a Digital Signature by S/MIME) .....	286
Login Name.....	286
Password .....	286
Meta Data .....	287
<b>6 Send from Folder.....</b>	<b>289</b>
Folder Operating Procedure .....	290
Step 1 Opening the [Send from Folder] Screen.....	290
Step 2 Selecting a Folder.....	291
Step 3 Checking/Selecting Files in a Folder .....	291
Step 4 Operating Files in a Folder .....	291
Selecting a Folder.....	292
Checking/Operating Files in a Folder .....	293
Checking File Details.....	295
Printing Files in a Folder.....	296
Configuring/Starting Job Flow .....	299
[Link Job Flow Sheet to Folder] Screen.....	301
Job Flow Restrictions.....	304
<b>7 Stored Programming.....</b>	<b>305</b>
Stored Programming Overview .....	306
Registering/Deleting/Renaming Stored Programs.....	307
Registering Stored Programs.....	308
Notes and Restrictions on Registering Stored Programs .....	308
Registering Stored Programs for Build Job.....	309
Deleting Stored Programs.....	310
Entering/Changing a Stored Program Name .....	311
Assigning/Changing Icons for Stored Programs .....	311
Calling a Stored Program .....	313
Calling a Stored Program for Build Job.....	314

---

<b>8</b>	<b>Media Print (Text and Photos)</b> .....	<b>315</b>
	Overview of Media Print .....	316
	Supported Media and File Formats .....	316
	Notes and Restrictions on Media Print .....	317
	Media Print - Text .....	319
	Selecting Files .....	319
	[Select From List] Screen .....	320
	Media Print - Photos .....	321
	Selecting Files .....	321
	[Select From List] Screen .....	322
	Selecting the Printing Options .....	323
	Media Print - Photos .....	323
	Media Print - Text .....	324
	Index Print.....	324
<b>9</b>	<b>Job Status</b> .....	<b>327</b>
	Job Status Overview .....	328
	Checking Current/Pending Jobs.....	329
	Checking Completed Jobs .....	331
	Printing and Deleting Stored Jobs.....	332
	Secure Print.....	332
	Sample Set .....	334
	Delayed Print .....	336
	Charge Print.....	337
	Private Charge Print .....	340
	Public Folder.....	342
	Undelivered Faxes.....	343
	Printing Pending Jobs .....	345
	Handling Error Terminations .....	346
<b>10</b>	<b>Computer Operations</b> .....	<b>347</b>
	Features Overview .....	348
	Print.....	349
	Print Features .....	349
	Setup .....	351
	Printing.....	351
	E-mail Printing .....	352
	Setup .....	352
	Receiving E-Mail.....	352
	Sending Fax .....	354
	Registering Destinations.....	354
	Importing Scanned Data.....	356
	Importing to a TWAIN Compatible Application .....	356
	Importing Using Stored File Manager 3.....	358

Importing Using CentreWare Internet Services .....	360
Importing Using EasyOperator.....	362
CentreWare Internet Services .....	364
<b>11 Appendix .....</b>	<b>369</b>
Glossary .....	370
<b>Index.....</b>	<b>377</b>





# 1 Before Using the Machine

This chapter describes how to use this guide, as well as safety notes and legal notice you should read before using the machine.

- Preface ..... 14
- Types of Manuals ..... 15
- Using This Guide ..... 16
- Safety Notes ..... 19
- Regulation..... 29
- Environment..... 30
- About License ..... 31
- Legal Notice ..... 38

## Preface

---

---

Thank you for selecting this machine (hereafter referred to as "the machine").

This guide describes how to operate the machine and the precautions you should follow during operation. To get the most out of the machine and to use it effectively, be sure to read this guide before use.

This guide assumes that you have a basic knowledge of the operating environment of the personal computer in use and networking environments. For information on the environment of the personal computer in use and the basic knowledge and operations of networking environments, refer to the manuals provided with the personal computer, operating system, and network system.

For information on how to configure your network environment, refer to the Administrator Guide. For information on optional accessories for the print service, also refer to the guide provided with each optional accessory.

After reading this guide, be sure to keep it handy for quick reference. It will be useful in case you forget how to perform operations or if a problem occurs with the machine.

**Warning:**

This equipment will be inoperable when mains power fails.

---

## Types of Manuals

---

The following guides are provided with the machine.

### Accompanying Manuals

■ **User Guide (this guide) (Document CD-ROM)**

The guide describes all the necessary steps for copy, print, scan, and fax.

■ **Administrator Guide (Document CD-ROM)**

The guide is intended for system administrators, and describes how to configure network and how to solve problems that may occur with the machine. This guide also describes daily maintenance and the System Settings procedures.

■ **Quick Reference Guide (Booklet)**

The guide describes the basic operations of the machine, as well as daily management and maintenance.

■ **Manual (HTML)**

The manual describes installation and configuration procedures for print drivers and the machine environment. This manual is included in the Driver CD Kit.

■ **Print Driver Help**

The help describes print features and operations.

■ **CentreWare Internet Services Help**

The help describes how to change various settings of the machine using a web browser, and how to import scanned data to a computer from the machine.

### Guides for Optional Components

Optional components are available for this machine. Some of them come with user guides. The guides for optional components describe all the necessary steps for using the optional components and installing the software.

## Using This Guide

---

---

This guide is intended for first time users of the machine. It describes the basic operations for the Copy, Print, Scan, and Fax services.

### Organization of This Guide

---

This guide consists of the following chapters:

■1 **Before Using the Machine**

Describes how to use this guide, as well as safety notes, legal notices, and other important information you should read before using the machine.

■2 **Product Overview**

Describes the basic information of the machine, such as the names of components, how to use the touch screen, how to switch the machine on and off, and how to exit the Energy Saver mode.

■3 **Copy**

Describes the basic operation and features for the Copy service.

■4 **Fax**

Describes the basic operations and features for the Fax services.

■5 **Scan**

Describes the basic operations and features for the Scan services.

■6 **Send from Folder**

Describes the basic operations and features to use folders.

■7 **Stored Programming**

Describes the Stored Programming service that enables you to store customized job settings.

■8 **Media Print (Text and Photos)**

Describes the basic operations and features of Media Print that allows you to print image data and document files.

■9 **Job Status**

Describes how to check job status and how to delete jobs.

■10 **Computer Operations**

Describes operations performed from a computer, such as printing documents, importing scanned files, using Direct Fax, and operating CentreWare Internet Services.

■11 **Appendix**

Contains a glossary of terms used in this guide.

### Conventions

---

- The screen images and illustrations that are used in this guide are based on the machine configuration with the various options. Some of the items in the screen images may not be displayed or there may be features that cannot be used depending on the machine configuration.
- The procedures in this guide may vary depending on the driver and utility software being used due to the upgrades.
- In this guide, "Computer" refers to a personal computer or workstation.
- The following terms are used in this guide:
  - Important : Indicates important information that you should read.
  - Note : Indicates additional information on operations or features.
- The following symbols are used in this guide:
  - " " :
    - A cross-reference included in this guide.
    - Refers to names of CD-ROM, features, and touch screen messages and input text.
  - [ ] :
    - Refers to folders, files, applications, button, or menu names displayed on the touch screen.
    - The names of menus, commands, windows, or dialog boxes displayed on the computer screen and their buttons and menu names.
  - < > button : Indicates a hardware button on the control panel.
  - < > key : Indicates a key on the keyboard of the computer.
  - > :
    - Indicates a path to a certain item within a procedure on the control panel.  
Example: When you see the procedure "select [Tools] > [Setup] > [Create Folder]", this means that you need to select [Tools], select [Setup], and then select [Create Folder].
    - Indicates a path to a certain item within a procedure on a computer.  
Example: When you see the procedure "to search for files and folders, click [Start] > [Search] > [For Files or Folders]", this means that you need to click [Start], click [Search], and then click [For Files or Folders] in order to search for files and folders.
    - The reference is indicated in the following manner:  
"Refer to "5 Tools" > "Common Service Settings" > "Audio Tones" in the Administrator Guide."  
The sentence above means that you need to refer to the section "Audio Tones", which can be found under "Common Service Settings" in Chapter 5 Tools of the Administrator Guide.

- Orientation of documents or paper is described in this guide as follows:
  - ☐, ☐, Long Edge Feed (LEF): Loading the document or paper in portrait orientation when viewed from the front of the machine.
  - ☐, ☐, Short Edge Feed (SEF): Loading the document or paper in landscape orientation when viewed from the front of the machine.

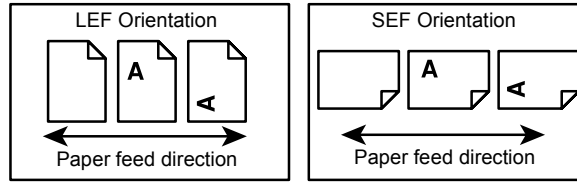

## Safety Notes



















Before using this product, read "Safety Notes" carefully for safety use.

This product and recommended supplies have been tested and found to comply with strict safety requirements including safety agency approvals and compliance with environmental standards. Follow the following instructions for safety use.

**⚠ WARNING**

Any unauthorized alteration including an addition of new functions or connection to external devices may not be covered by the product warranty. Contact your local Fuji Xerox representative for more information.

Follow all warning instructions marked on this product. The warning marks stand for the followings:

<b>⚠ DANGER</b>	Used for item that if not followed strictly, can lead death or severe or fatal injuries and the possibility to do it is comparatively high.
<b>⚠ WARNING</b>	Used for items that if not followed strictly, can lead to severe or fatal injuries.
<b>⚠ CAUTION</b>	Used for items that if not followed strictly, can cause injuries to user or damages to machine.
<p>⚠ : A symbol for items to pay attention to when handling machine. Follow instructions carefully to use machine safely.</p> <div style="display: flex; justify-content: space-around; align-items: center;"> <div style="text-align: center;"> Static Sensitive</div> <div style="text-align: center;"> Caution</div> <div style="text-align: center;"> Flammable</div> <div style="text-align: center;"> Explodable</div> <div style="text-align: center;"> Electric shock</div> <div style="text-align: center;"> Heated surface</div> <div style="text-align: center;"> Moving object</div> <div style="text-align: center;"> Pinched fingers</div> </div>	
<p>⊘ : A symbol for prohibited items. Follow instructions carefully to avoid any dangerous acts.</p> <div style="display: flex; justify-content: space-around; align-items: center;"> <div style="text-align: center;"> Prohibited</div> <div style="text-align: center;"> No fire</div> <div style="text-align: center;"> Do not touch</div> <div style="text-align: center;"> Do not use in bathroom</div> <div style="text-align: center;"> Do not tear down</div> <div style="text-align: center;"> Keep away from wet</div> <div style="text-align: center;"> Never touch with wet hand</div> </div>	
<p>● : A symbol for items that must be performed. Follow instructions carefully to carry out these essential tasks.</p> <div style="display: flex; justify-content: space-around; align-items: center;"> <div style="text-align: center;"> Instructions</div> <div style="text-align: center;"> Unplug</div> <div style="text-align: center;"> Ground/Earth</div> </div>	

## Electrical Safety

### ⚠️ WARNING

This product shall be operated by the power source as indicated on the product's data plate. Consult your local power company to check if your power source meets the requirements.



**WARNING:** Connect this product to a protective earth circuit.

This product is supplied with a plug that has a protective earth pin. The plug fits only into an earthed electrical outlet. This is a safety feature. If the plug doesn't fit to the outlet, contact an electrician to replace the outlet to avoid risk of electric shock. Never use an earthed adapter plug to connect the product to the electrical outlet that has no earth connection terminal.

Improper connection of a grounding conductor may cause electric shock.



Plug the power cord directly into a grounded electrical outlet. To prevent overheat and a fire accident, do not use an extension cord, a multi-plug adaptor or a multiple connector. Consult your local Fuji Xerox representative to check if an outlet is grounded.



Connect this product to a branch circuit or an outlet that has larger capacity than the rated ampere and voltage of this product. See the data plate on the rear panel of this product for its rated ampere and voltage.



Never touch the power cord with wet hands. It may cause electric shock.



Do not place an object on the power cord.



Always keep the plug connection free of dust. The dusty and damp environment may bring about minute electric current in a connector. It may generate heat and eventually cause a fire accident.



To avoid the risk of electric shock and a fire accident, only use the power cord supplied with this product or the ones designated by Fuji Xerox.

The power cord is exclusive use for this product. Do not use it for any other product.

Do not damage or alter the power cord. Damage and alteration may generate heat and eventually cause electric shock or a fire accident.

If the power cord is damaged or insulated wires are exposed, contact your local Fuji Xerox representative for its replacement. Do not use a damaged or uninsulated cord to avoid the risk of electric shock and a fire accident.

### ⚠️ CAUTION



When cleaning this product, always switch off the power and unplug it. Access to a live machine interior may cause electric shock.



Do not unplug or re-plug this product with the main power switch and the power switch on. Plugging and unplugging a live connector may deform the plug and generate heat, and eventually cause a fire accident.



Hold the plug not the cord when unplugging this product, or it may damage the cord and cause electric shock or a fire accident.



Switch off and unplug the product when it (i.e., fax function) is not used over weekends or long holidays. Please note that it cannot receive fax message during switch-off.





- Once a month, switch off this product and check if
- the power cord is plugged firmly into an electrical outlet;
  - the plug is not excessively heated, rusted or bent;
  - the plug and electrical outlet are free of dust; and
  - the power cord is not cracked or worn down.

Once you notice any unusual condition, switch off and unplug this product first and contact your local Fuji Xerox representative.

## Machine Installation

### ⚠ WARNING



Do not locate this product where people might step on or trip over the power cord. Friction or excessive pressure may generate heat and eventually cause electric shock or a fire accident.

### ⚠ CAUTION



- Never locate this product in the following places:
- Near radiators or any other heat sources
  - Near volatile flammable materials such as curtains
  - In the hot, humid, dusty or poorly ventilated environment
  - In the place receiving direct sunlight
  - Near cookers or humidifiers



This product weights 56 Kg. When moving it, always carry it by a team of four or more persons to avoid mishandling or injury.



When lifting this product, lift it with our persons. The person in front holds the machine with one hand on each side. Never lift it by gripping any other areas. It will prevent you from dropping the product and getting back ache or injuries.

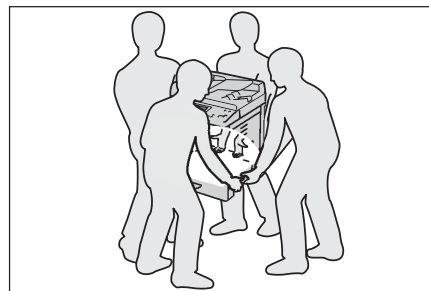

Locate this product on a level and sturdy surface that can withstand a weight of 115 Kg (maximum weight when the One tray module, Two tray module, and Finisher-AB1 are installed). Otherwise, if tilted, the product may fall over and cause injuries.



Locate this product in a well-ventilated area. Do not obstruct ventilation openings of the product.  
Keep the minimum clearance as follows for ventilation and an access to the power plug. Unplug the product if an abnormal condition is noted.

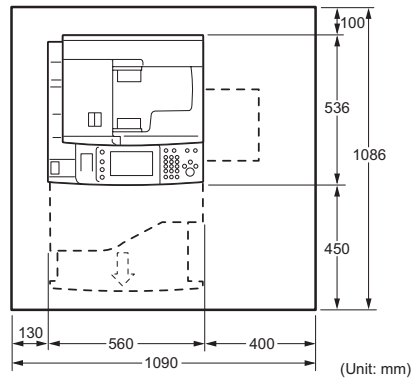

With Finisher-AB1 (optional)

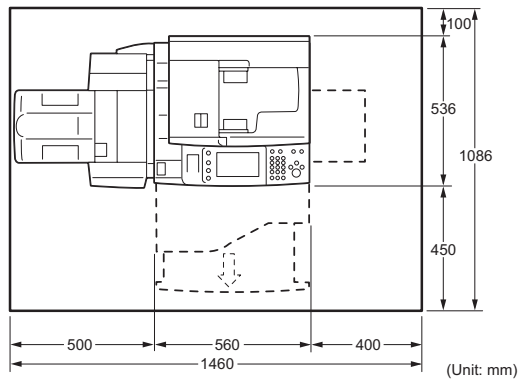

With Finisher-AB1 and Stand (optional)

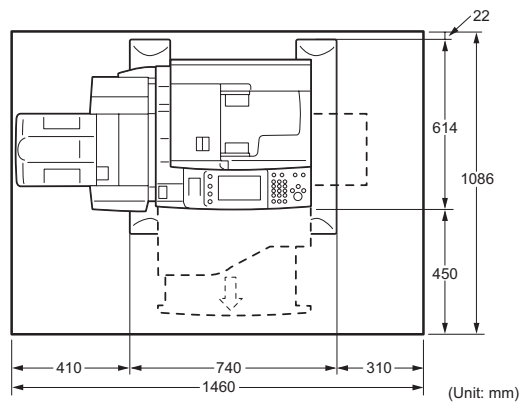

Do not incline the product at more than 10 degree angle. Otherwise, it may fall over and cause injuries.

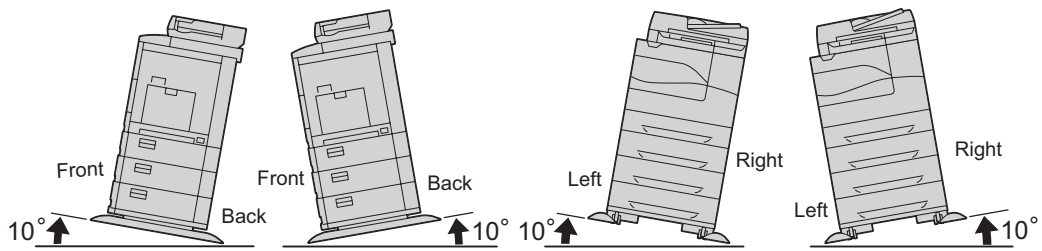

Always lock the wheels of this product after installation. Otherwise, it may fall over or slide and cause injuries.

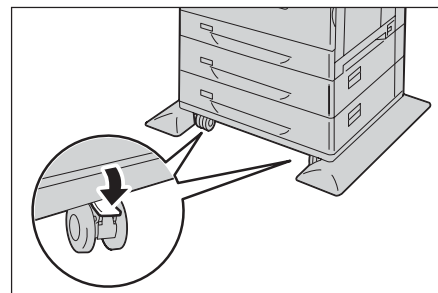

Always locate the output unit inside the rack under the scanning unit.

## Others



To keep this product in a good performance and condition, always use it in the following environment:

- Temperature: 10 - 32°C
- Humidity: 15 - 85%

When the product is left in a chilly room and the room is rapidly warmed up by heater, dew condensation may form inside the product and cause a partial deletion on printing.

## Operational Safety

### ⚠ WARNING



The operator's product maintenance procedures are described in the customer documentation supplied with this product. Do not carry out any other maintenance procedures not described in the documentation.



This product features safety design not to allow operators access to hazard areas. The hazard areas are isolated from operators by covers or protectors which require a tool to remove. To prevent electric shock and injuries, never remove those covers and protectors.



To avoid the risk of electric shock and a fire accident, switch off and unplug the product promptly in the following conditions, then contact your local Fuji Xerox representative.

- The product emits smoke or its surface is unusually hot.
- The product emits unusual noise or odor.
- The power cord is cracked or worn down.
- A circuit breaker, fuse or any other safety device is activated.
- Any liquid is spilled into the product.
- The product is soaked in water.
- Any part of the product is damaged.



Do not insert any object into slots or openings of this product.

Do not place any of the followings on the product:

- Liquid container such as flower vases or coffee cups
- Metal parts such as staples or clips
- Heavy objects

If liquid is spilled over or metal parts are slipped into the product, it may cause electric shock or a fire accident.



Do not use conductive paper such as origami paper, carbonic paper or conductively-coated paper. When paper jam occurs, it may cause short-circuit and eventually a fire accident.



When cleaning this product, use the designated cleaning materials exclusive to it. Other cleaning materials may result in poor performance of the product. Never use aerosol cleaners, or it may catch fire and cause explosion.



If you need to pull out a tray to remove paper jam, contact your local Fuji Xerox representative. Do not pull out a tray, otherwise it may cause injuries.



Laser Safety

CAUTION: Any operations or adjustments not stated in the operation manual may cause hazardous light exposure and eventually burn injuries or loss of eyesight.

This product has been tested and found to comply with the Class 1 Laser Equipment requirements defined by the international standard IEC60825 and has no light exposure hazard. The product has no hazardous light emission as it features light protection components and covers to shut in all light beam during operation and maintenance.

## CAUTION



Keep electrical and mechanical safety interlocks active. Keep the safety interlocks away from magnetic materials. Magnetic materials may accidentally activate the product and cause injuries or electric shock.



A ground fault interrupter is embedded in this product. If current leakage occurs, the ground fault interrupter automatically cuts off power circuit to prevent electric shock and a fire accident. The ground fault interrupter is normally ON ("I"). Check once a month if the ground fault interrupter works properly in accordance with the following procedures:

1) Switch the power off.

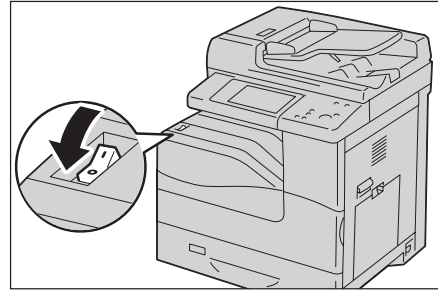

2) Press the main power switch to the [O] position to switch the main power off.

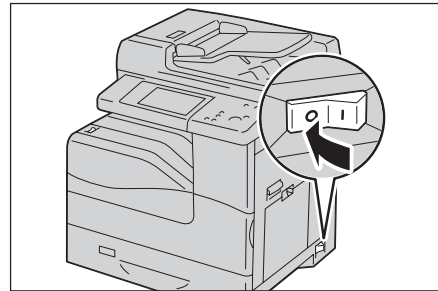

3) Press the <RESET> button to the reset position. The button will be depressed even after the pushing force is released.

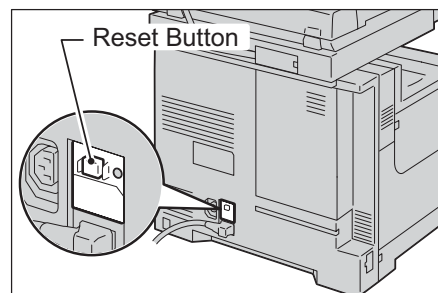

4) Press the <TEST> button lightly with a sharp edge such as a pen tip. The depressed <RESET> button will stick out again. This is the end of the check procedure.

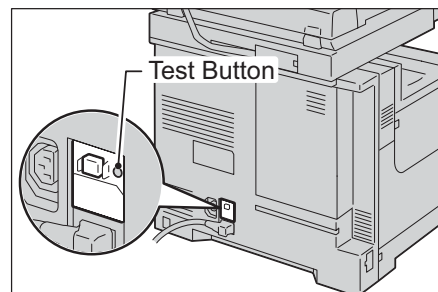

5) Press the <RESET> button back to the depressed position.

If the circuit does not work properly, contact your local Fuji Xerox representative.



Do not attempt to remove a paper jammed deeply inside the product, particularly a paper wrapped around a Fusing Unit or a heat roller. Otherwise, it may cause injuries or burns. Switch off the product promptly and contact your local Fuji Xerox representative.



Never touch the paper output area of the finisher during operation. It may cause injuries.



Be careful in removing jammed staples.







Do not apply excessive force to hold thick document on the document glass. It may break the glass and cause injuries.





Ventilate well during extended operation or mass copying. It may affect the office air environment due to odor such as ozone in a poorly ventilated room.  
Provide proper ventilation to ensure the comfortable and safe environment.

## Consumable

### ⚠ WARNING

-  Store all consumables in accordance with the instructions given on its package or container.
-  Use a broom or a wet cloth to wipe off spilled toner. Never use a vacuum cleaner for the spills. It may catch fire by electric sparks inside the vacuum cleaner and cause explosion. If you spill a large volume of toner, contact your local Fuji Xerox representative.
-  Never throw a toner cartridge into an open flame. Remaining toner in the cartridge may catch fire and cause burn injuries or explosion.  
If you have a used toner cartridge no longer needed, contact your local Fuji Xerox representative for its disposal.
-  Never throw a waste toner container into an open flame. Toner may catch fire and cause burn injuries or explosion.  
If you have a used waste toner container no longer needed, contact your local Fuji Xerox representative for its disposal.

### ⚠ CAUTION

-  Keep the drum cartridges and toner cartridges out of the reach of children. If a child accidentally swallows toner, spit it out, rinse mouth with water, drink water and consult a physician immediately.
-  When replacing the drum cartridges and toner cartridges, be careful not to spill the toner. In case of any toner spills, avoid contact with clothes, skin, eyes and mouth as well as inhalation.
-  If toner spills onto your skin or clothing, wash it off with soap and water.  
If you get toner particles in your eyes, wash it out with plenty of water for at least 15 minutes until irritation is gone. Consult a physician if necessary.  
If you inhale toner particles, move to a fresh air location and rinse your mouth with water.  
If you swallow toner, spit it out, rinse your mouth with water, drink plenty of water and consult a physician immediately.

## Location of Warning and Caution Labels

-  Always follow all warning instructions marked on or supplied with this product.  
To avoid the risk of burn injuries and electric shock, never touch the area with the "High Temperature" or "High Voltage" marks on.

⚠ CAUTION Do not stare at light. It may cause discomfort or irritation to your eyes.  
 ⚠ 注意 ランプの光を見つめないでください。目の疲れや痛みの原因となることがあります。  
 ⚠ 注意 请勿直视曝光灯光源，以免造成眼睛疲劳及伤害眼睛。  
 ⚠ 注意 請勿直視曝光燈光源，以免造成眼睛疲勞及傷害眼睛。  
 ⚠ 주의 광원을 보지 않아 주십시오. 눈의 피로 또는 통증의 원인이 될 수 있습니다.  
 ⚠ ข้อควรระวัง ห้ามจ้องมองแสงไฟ เพราะอาจทำให้ปวดหรือระคายเคืองดวงตา

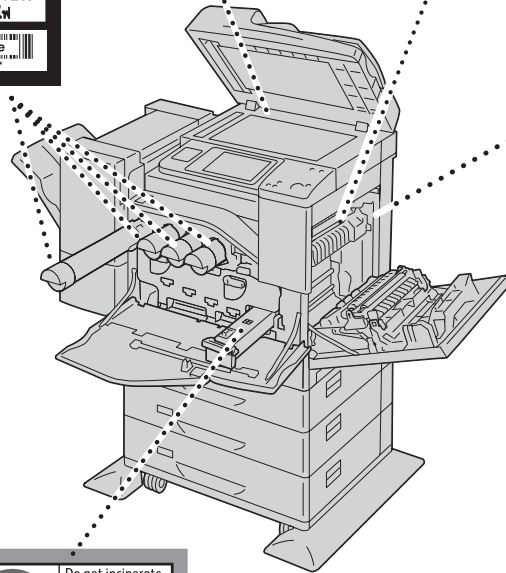
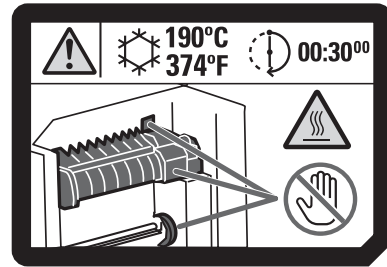



---

## Regulation

---

### Radio Frequency Emissions (Class B)

---



This product has been tested and found to comply with the limits for a Class B digital device, pursuant to the International Standard for Electromagnetic Interference (CISPR Publ. 22) and Radiocommunications Act 1992 in Australia/New Zealand. These limits are designed to provide reasonable protection against harmful interference in a residential installation. This product generates, uses and can radiate radio frequency energy and, if not installed and used in accordance with the instructions, may cause harmful interference to radio communications. However, there is no guarantee that interference will not occur in a particular installation. If this product does cause harmful interference to radio or television reception, which can be determined by turning this product off and on, the user is encouraged to try to correct the interference by one or more of the following measures:

- Reorient or relocate the receiving antenna.
- Increase the separation between this product and the receiver.
- Connect this product into an outlet on a circuit different from that to which the receiver is connected.
- Consult the dealer or an experienced radio/TV technician for help.

Changes and modifications to this product not specifically approved by Fuji Xerox may void the user's authority to operate this product.

### Product Safety Certification (UL, CB)

---

This product is certified by the following agency using the safety standards listed.

<u>Agency</u>	<u>Standard</u>
NEMKO	IEC60950-1:ed. 1

## Environment

---

---

- For environmental protection and efficient use of resources, Fuji Xerox reuses returned toner cartridges and drum cartridges to make recycle parts, recycle materials or energy recovery.
- Proper disposal is required for toner cartridges and drum cartridges no longer needed. Do not open toner cartridges and drum cartridges. Return them to your local Fuji Xerox representative.

---

## About License

---

This section describes information about licenses. Be sure to read through it.

---

### RSA BSAFE

---



This product includes RSA BSAFE<sup>®</sup> Cryptographic software from RSA Security Inc.

---

### Heimdal

---

Copyright (c)2000 Kungliga Tekniska Högskolan (Royal Institute of Technology, Stockholm, Sweden). All rights reserved.

Redistribution and use in source and binary forms, with or without modification, are permitted provided that the following conditions are met:

1. Redistributions of source code must retain the above copyright notice, this list of conditions and the following disclaimer.
2. Redistributions in binary form must reproduce the above copyright notice, this list of conditions and the following disclaimer in the documentation and/or other materials provided with the distribution.
3. Neither the name of the Institute nor the names of its contributors may be used to endorse or promote products derived from this software without specific prior written permission.

THIS SOFTWARE IS PROVIDED BY THE INSTITUTE AND CONTRIBUTORS "AS IS" AND ANY EXPRESS OR IMPLIED WARRANTIES, INCLUDING, BUT NOT LIMITED TO, THE IMPLIED WARRANTIES OF MERCHANTABILITY AND FITNESS FOR A PARTICULAR PURPOSE ARE DISCLAIMED. IN NO EVENT SHALL THE INSTITUTE OR CONTRIBUTORS BE LIABLE FOR ANY DIRECT, INDIRECT, INCIDENTAL, SPECIAL, EXEMPLARY, OR CONSEQUENTIAL DAMAGES (INCLUDING, BUT NOT LIMITED TO, PROCUREMENT OF SUBSTITUTE GOODS OR SERVICES; LOSS OF USE, DATA, OR PROFITS; OR BUSINESS INTERRUPTION) HOWEVER CAUSED AND ON ANY THEORY OF LIABILITY, WHETHER IN CONTRACT, STRICT LIABILITY, OR TORT (INCLUDING NEGLIGENCE OR OTHERWISE) ARISING IN ANY WAY OUT OF THE USE OF THIS SOFTWARE, EVEN IF ADVISED OF THE POSSIBILITY OF SUCH DAMAGE.

---

### JPEG Code

---

Our printer software uses some of the codes defined by the Independent JPEG Group.

---

### Libcurl

---

COPYRIGHT AND PERMISSION NOTICE

Copyright (c) 1996 - 2006, Daniel Stenberg, <daniel@haxx.se>.

All rights reserved.

Permission to use, copy, modify, and distribute this software for any purpose with or without fee is hereby granted, provided that the above copyright notice and this permission notice appear in all copies.

THE SOFTWARE IS PROVIDED "AS IS", WITHOUT WARRANTY OF ANY KIND, EXPRESS OR IMPLIED, INCLUDING BUT NOT LIMITED TO THE WARRANTIES OF MERCHANTABILITY, FITNESS FOR A PARTICULAR PURPOSE AND NONINFRINGEMENT OF THIRD PARTY RIGHTS. IN NO EVENT SHALL THE AUTHORS OR COPYRIGHT HOLDERS BE LIABLE FOR ANY CLAIM, DAMAGES OR OTHER LIABILITY, WHETHER IN AN ACTION OF CONTRACT, TORT OR OTHERWISE, ARISING FROM, OUT OF OR IN CONNECTION WITH THE SOFTWARE OR THE USE OR OTHER DEALINGS IN THE SOFTWARE.

Except as contained in this notice, the name of a copyright holder shall not be used in advertising or otherwise to promote the sale, use or other dealings in this Software without prior written authorization of the copyright holder.

## FreeBSD

---

This product contains the part of FreeBSD codes.

The FreeBSD Copyright

Copyright 1994-2006 The FreeBSD Project. All rights reserved.

Redistribution and use in source and binary forms, with or without modification, are permitted provided that the following conditions are met:

Redistributions of source code must retain the above copyright notice, this list of conditions and the following disclaimer.

Redistributions in binary form must reproduce the above copyright notice, this list of conditions and the following disclaimer in the documentation and/or other materials provided with the distribution.

THIS SOFTWARE IS PROVIDED BY THE FREEBSD PROJECT "AS IS" AND ANY EXPRESS OR IMPLIED WARRANTIES, INCLUDING, BUT NOT LIMITED TO, THE IMPLIED WARRANTIES OF MERCHANTABILITY AND FITNESS FOR A PARTICULAR PURPOSE ARE DISCLAIMED. IN NO EVENT SHALL THE FREEBSD PROJECT OR CONTRIBUTORS BE LIABLE FOR ANY DIRECT, INDIRECT, INCIDENTAL, SPECIAL, EXEMPLARY, OR CONSEQUENTIAL DAMAGES (INCLUDING, BUT NOT LIMITED TO, PROCUREMENT OF SUBSTITUTE GOODS OR SERVICES; LOSS OF USE, DATA, OR PROFITS; OR BUSINESS INTERRUPTION) HOWEVER CAUSED AND ON ANY THEORY OF LIABILITY, WHETHER IN CONTRACT, STRICT LIABILITY, OR TORT (INCLUDING NEGLIGENCE OR OTHERWISE) ARISING IN ANY WAY OUT OF THE USE OF THIS SOFTWARE, EVEN IF ADVISED OF THE POSSIBILITY OF SUCH DAMAGE.

The views and conclusions contained in the software and documentation are those of the authors and should not be interpreted as representing official policies, either expressed or implied, of the FreeBSD Project.

## OpenLDAP

---

Copyright 1998-2006 The OpenLDAP Foundation All rights reserved.

Redistribution and use in source and binary forms, with or without modification, are permitted only as authorized by the OpenLDAP Public License.

A copy of this license is available in the file LICENSE in the top-level directory of the distribution or, alternatively, at <http://www.OpenLDAP.org/license.html>.

OpenLDAP is a registered trademark of the OpenLDAP Foundation.

Individual files and/or contributed packages may be copyright by other parties and/or subject to additional restrictions.

This work is derived from the University of Michigan LDAP v3.3 distribution. Information concerning this software is available at <http://www.umich.edu/~dirsvcs/ldap/ldap.html>.

This work also contains materials derived from public sources.

Additional information about OpenLDAP can be obtained at <http://www.openldap.org/>.

---

Portions Copyright 1998-2006 Kurt D. Zeilenga.

Portions Copyright 1998-2006 Net Boolean Incorporated.

Portions Copyright 2001-2006 IBM Corporation.

All rights reserved.

Redistribution and use in source and binary forms, with or without modification, are permitted only as authorized by the OpenLDAP Public License.

---

Portions Copyright 1999-2005 Howard Y.H. Chu.

Portions Copyright 1999-2005 Symas Corporation.

Portions Copyright 1998-2003 Hallvard B. Furuseth.

All rights reserved.

Redistribution and use in source and binary forms, with or without modification, are permitted provided that this notice is preserved.

The names of the copyright holders may not be used to endorse or promote products derived from this software without their specific prior written permission. This software is provided "as is" without express or implied warranty.

---

Portions Copyright (c) 1992-1996 Regents of the University of Michigan.

All rights reserved.

Redistribution and use in source and binary forms are permitted provided that this notice is preserved and that due credit is given to the University of Michigan at Ann Arbor. The name of the University may not be used to endorse or promote products derived from this software without specific prior written permission. This software is provided "as is" without express or implied warranty.

-----

The OpenLDAP Public License

Version 2.8, 17 August 2003

Redistribution and use of this software and associated documentation ("Software"), with or without modification, are permitted provided that the following conditions are met:

1. Redistributions in source form must retain copyright statements and notices,
2. Redistributions in binary form must reproduce applicable copyright statements and notices, this list of conditions, and the following disclaimer in the documentation and/or other materials provided with the distribution, and
3. Redistributions must contain a verbatim copy of this document.

The OpenLDAP Foundation may revise this license from time to time.

Each revision is distinguished by a version number. You may use this Software under terms of this license revision or under the terms of any subsequent revision of the license.

THIS SOFTWARE IS PROVIDED BY THE OPENLDAP FOUNDATION AND ITS CONTRIBUTORS "AS IS" AND ANY EXPRESSED OR IMPLIED WARRANTIES, INCLUDING, BUT NOT LIMITED TO, THE IMPLIED WARRANTIES OF MERCHANTABILITY AND FITNESS FOR A PARTICULAR PURPOSE ARE DISCLAIMED. IN NO EVENT SHALL THE OPENLDAP FOUNDATION, ITS CONTRIBUTORS, OR THE AUTHOR(S) OR OWNER(S) OF THE SOFTWARE BE LIABLE FOR ANY DIRECT, INDIRECT, INCIDENTAL, SPECIAL, EXEMPLARY, OR CONSEQUENTIAL DAMAGES (INCLUDING, BUT NOT LIMITED TO, PROCUREMENT OF SUBSTITUTE GOODS OR SERVICES; LOSS OF USE, DATA, OR PROFITS; OR BUSINESS

INTERRUPTION) HOWEVER CAUSED AND ON ANY THEORY OF LIABILITY, WHETHER IN CONTRACT, STRICT LIABILITY, OR TORT (INCLUDING NEGLIGENCE OR OTHERWISE) ARISING IN ANY WAY OUT OF THE USE OF THIS SOFTWARE, EVEN IF ADVISED OF THE POSSIBILITY OF SUCH DAMAGE.

The names of the authors and copyright holders must not be used in advertising or otherwise to promote the sale, use or other dealing in this Software without specific, written prior permission. Title to copyright in this Software shall at all times remain with copyright holders.

OpenLDAP is a registered trademark of the OpenLDAP Foundation.

Copyright 1999-2003 The OpenLDAP Foundation, Redwood City, California, USA. All Rights Reserved. Permission to copy and distribute verbatim copies of this document is granted.

---

## DES

This product includes software developed by Eric Young(eay@mincom.oz.au)

---

## AES

Copyright (c) 2003. Dr Brian Gladman. Worcester. UK. All rights reserved.

This product uses published AES software provided by Dr Brian Gladman under BSD licensing terms.

---

## TIFF (libtiff)

Lib TIFF copyright (c) 1988-1997 Sam leffler

Copyright (c) 1991-1997 Silicon Graphics. Inc.

---

## ICC Profile (Little cms)

Little cms copyright (c) 1988-2004 Marti Maria

---

## XPS (XML Paper Specification)

This product may incorporate intellectual property owned by Microsoft Corporation. The terms and conditions upon which Microsoft is licensing such intellectual property may be found at <http://go.microsoft.com/fwlink/?LinkId=52369>.

---

## EDICT and COMPDIC

The Japanese-English dictionaries (EDICT and COMPDIC) edited by The Electronic Dictionary Research and Development Group under the coordination of Professor James William Breen at Monash University are used in the searchable PDF kit option of Fuji Xerox.

These Japanese-English dictionary files are licensed to customers under the terms and conditions of a Creative Commons Attribution-ShareAlike License. Prior to use, be sure to check the terms and conditions of this license at the URL below. Use of these Japanese-English dictionaries is not permitted unless you agree to the terms and conditions of this license.

Furthermore, care should be taken because at the point in time that you begin to use these Japanese-English dictionaries as specified in the said license, you accept and agree to be bound by the terms and conditions of this license.

The Japanese-English dictionaries are provided to customers on an as-is basis, and Fuji Xerox and the original supplier make no representations of warranties of any kind.

- Original Author Information (extracted from <http://www.csse.monash.edu.au/~jwb/edrdg/licence.html>)  
Copyright over the documents covered by this statement is held by James William BREEN and The Electronic Dictionary Research and Development Group at Monash University.
- Monash University License Information  
<http://www.csse.monash.edu.au/~jwb/edrdg/licence.html>
- Information Regarding EDICT and COMPDIC  
<http://www.csse.monash.edu.au/~jwb/edict.html>  
[http://www.csse.monash.edu.au/~jwb/compdic\\_doc.html](http://www.csse.monash.edu.au/~jwb/compdic_doc.html)
- Information Regarding the Creative Commons Attribution-ShareAlike License  
<http://creativecommons.org/licenses/by-sa/2.5/legalcode>

## Cyrus SASL

---

Copyright (c) 1998-2003 Carnegie Mellon University. All rights reserved.

Redistribution and use in source and binary forms, with or without modification, are permitted provided that the following conditions are met:

1. Redistributions of source code must retain the above copyright notice, this list of conditions and the following disclaimer.
2. Redistributions in binary form must reproduce the above copyright notice, this list of conditions and the following disclaimer in the documentation and/or other materials provided with the distribution.
3. The name "Carnegie Mellon University" must not be used to endorse or promote products derived from this software without prior written permission. For permission or any other legal details, please contact  
Office of Technology Transfer  
Carnegie Mellon University  
5000 Forbes Avenue  
Pittsburgh, PA 15213-3890  
(412) 268-4387, fax: (412) 268-7395  
[tech-transfer@andrew.cmu.edu](mailto:tech-transfer@andrew.cmu.edu)



4. Redistributions of any form whatsoever must retain the following acknowledgment:  
"This product includes software developed by Computing Services at Carnegie Mellon University (<http://www.cmu.edu/computing/>)."

CARNEGIE MELLON UNIVERSITY DISCLAIMS ALL WARRANTIES WITH REGARD TO THIS SOFTWARE, INCLUDING ALL IMPLIED WARRANTIES OF MERCHANTABILITY AND FITNESS, IN NO EVENT SHALL CARNEGIE MELLON UNIVERSITY BE LIABLE FOR ANY SPECIAL, INDIRECT OR CONSEQUENTIAL DAMAGES OR ANY DAMAGES WHATSOEVER RESULTING FROM LOSS OF USE, DATA OR PROFITS, WHETHER IN AN ACTION OF CONTRACT, NEGLIGENCE OR OTHER TORTIOUS ACTION, ARISING OUT OF OR IN CONNECTION WITH THE USE OR PERFORMANCE OF THIS SOFTWARE.

## Legal Notice

---

---

Copying or printing certain documents may be illegal in your country. Penalties of fines or imprisonment may be imposed on those found guilty. The following are examples of items that may be illegal to copy or print in your country.

- Currency
- Banknotes and checks
- Bank and government bonds and securities
- Passports and identification cards
- Copyright material or trademarks without the consent of the owner
- Postage stamps and other negotiable instruments

This list is not inclusive and no liability is assumed for either its completeness or accuracy. In case of doubt, contact your legal counsel.

# 2 Product Overview

This chapter describes the basic information of the machine, such as machine components, how to switch the machine on and off, and how to use the touch screen.

- Machine Components ..... 40
- Power Source ..... 44
- Ground Fault Interrupter ..... 47
- Energy Saver Mode ..... 48
- Control Panel ..... 50
- About the [Services Home] Screen ..... 54
- Entering Text ..... 58

# Machine Components

This following describes machine components and their functions.

## Front, Side, Top, and Rear View

### ■ Front View

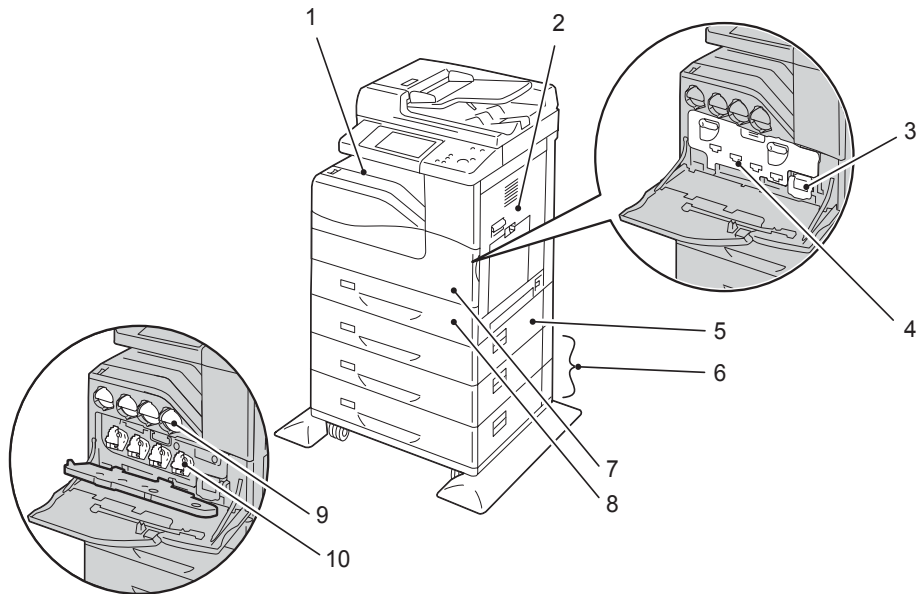

No.	Component	Function
1	Center output tray	Copies and prints are delivered here, facing down.
2	Right hand cover	Open this cover to replace the consumables or clear paper jams.
3	Waste toner bottle	Collects waste toner.
4	Inner cover	Open this cover to replace the consumables.
5	One tray module (optional)	Load paper here. <b>Note</b> • The machine allows for a maximum of 4 trays (Standard tray, One tray module and Two tray module (2 trays)).
6	Two tray module (optional)	Load paper here. <b>Note</b> • The machine allows for a maximum of 4 trays (Standard tray, One tray module and Two tray module (2 trays)).
7	Front cover	Open this cover to replace the consumables.
8	Standard tray	Load paper here.
9	Toner cartridges	Contains Black (K), Cyan (C), Magenta (M), and Yellow (Y) toner (image forming powder).
10	Drum cartridges	Contains Black (K), Cyan (C), Magenta (M), and Yellow (Y) drums.

- Note**
- The following combinations of trays are available:
  - Standard tray
  - Standard tray + One tray module x 1
  - Standard tray + One tray module x 1 + Two tray module x 1

- Standard tray + Two tray module x 1

### ■Right View

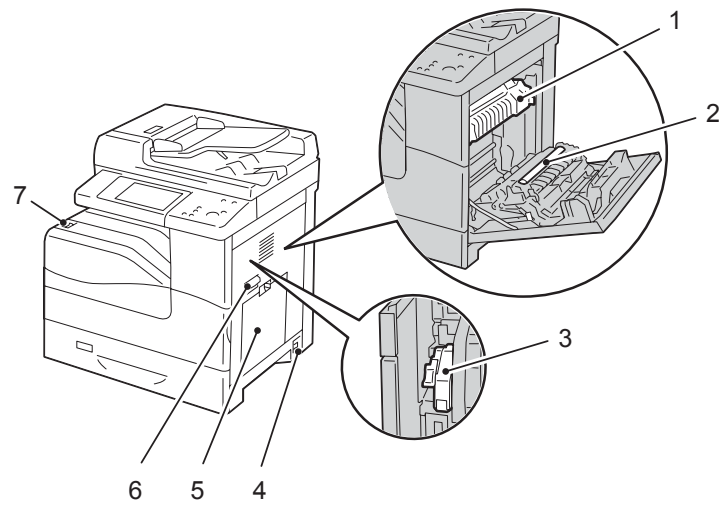

No.	Component	Function
1	Fusing unit	Fuses toner on paper. Do not touch this unit as it is extremely hot.
2	Transfer roller	Transfers toner from the drum to the paper.
3	Paper thickness lever	Used for printing on envelopes.
4	Main power switch	Switches the main power of the machine on and off. Refer to "Power Source" (P.44).
5	Multiple sheet inserter (MSI)	Used for loading non-standard paper, such as thick-stock paper and other special media, that cannot be loaded in trays.
6	Right hand cover handle	Use this handle to open the right hand cover.
7	Power switch	Switches the power of the machine on and off. Refer to "Power Source" (P.44).

■Left View (Finisher-AB1 (Optional))

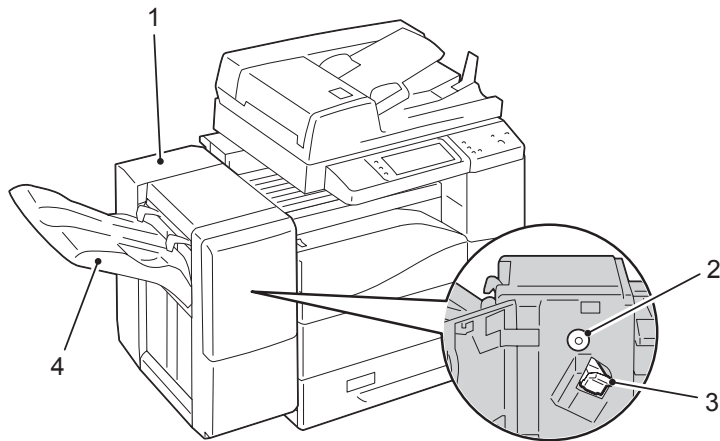

No.	Component	Function
1	Finisher-AB1	Staples copies or prints.
2	Knob	Rotate the knob to clear paper jams.
3	Staple cartridge	Contains staples. Remove this cartridge when replacing or adding staples, or clearing staple jams.
4	Left tray	Stapled outputs are delivered here.

■Rear View

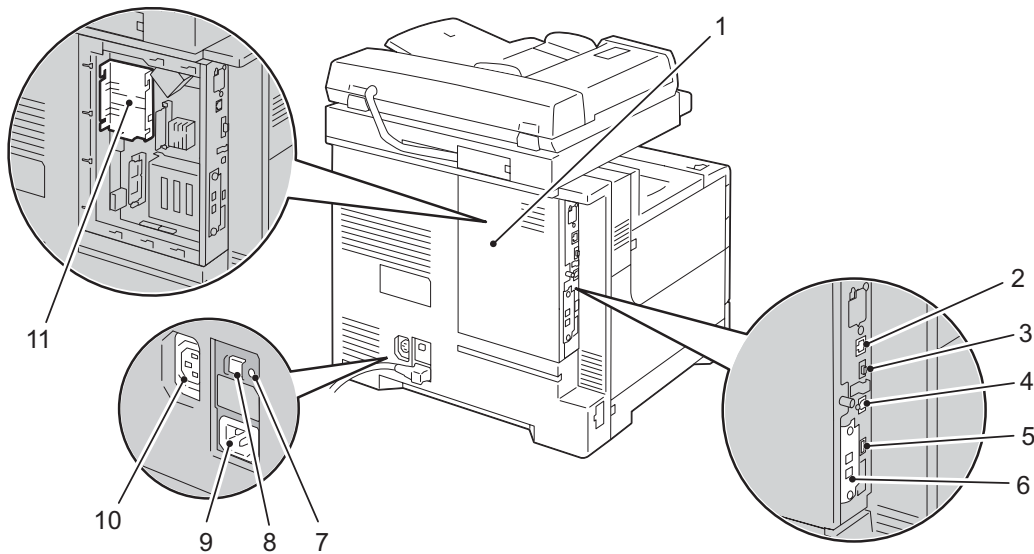

No.	Component	Function
1	Control board cover	Open this cover when installing the optional HDD extension kit.
2	Ethernet connector	Connects to a network cable.
3	EP port	Connects to the IC Card Reader.
4	USB connector (device)	Connects to the cable of the PC.
5	USB connector (host)	Connects to a USB cable.

No.	Component	Function
6	Fax kit (optional)	Enables you to connect the machine to a telephone device.
7	Test button	Used for checking if the Reset button works properly.
8	Reset button	Automatically switches the machine off when a current leakage is detected.
9	Power connector for the machine	Connects to the power cable of the machine.
10	Power connector for the optional Finisher-AB1	Connects to the power cable of the optional Finisher-AB1.
11	HDD extension kit (optional)	Provides the extended copy features and adds the spool and scan features.

### ■Top View (Duplex Automatic Document Feeder)

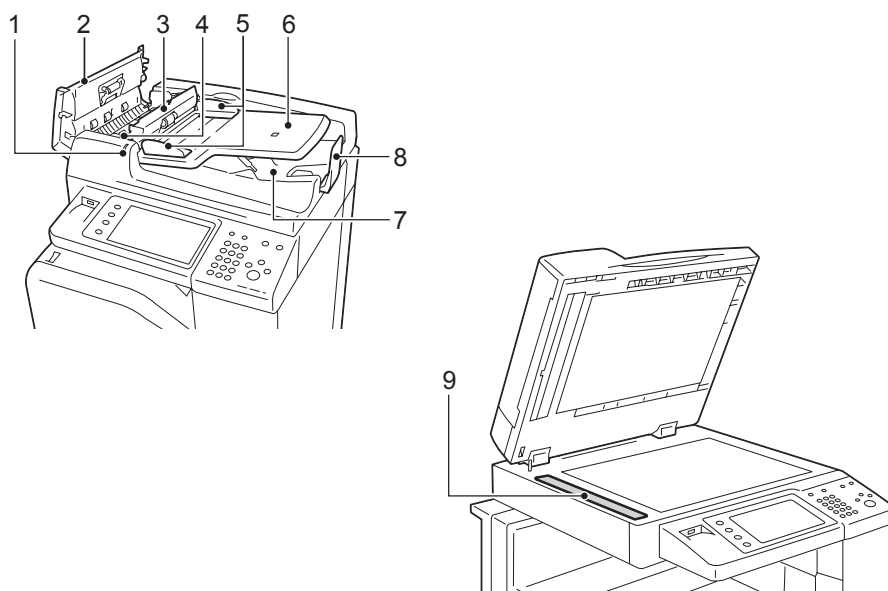

No.	Component	Function
1	Confirmation indicator	Lights up when a document is loaded correctly.
2	Left cover	Open this cover to clear paper jams.
3	Inner cover	Open this cover to clear paper jams.
4	Knob	Turn this lever to clear paper jams.
5	Document guides	Use these guides to align the edges of documents.
6	Document input tray	Load documents here.
7	Document output tray	Scanned documents are delivered here.
8	Document stopper	Prevents outputs from falling off.
9	Constant velocity transport glass	Scans a loaded document.

**Note** • In this guide, the duplex automatic document feeder is referred to as the "document feeder".

## Power Source

The machine is provided with the power switch and the main power switch.

### ■ Power switch

To use the machine, press the power switch to the [ | ] position to switch its power on. You can start operations after the machine warms up.

### ■ Main power switch

Press the main power switch to the [ O ] position. The <Main Power> indicator goes out on the right side of the control panel, and the machine powers off. Do not switch the main power except when you connect a cable to the machine or clean the machine. Switching off the main power may erase the data in the memory when using the Fax service.

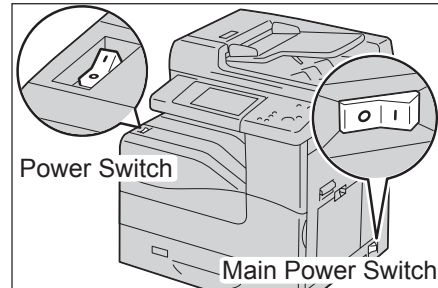

## Switching the Main Power On

The following describes how to switch the main power on.

**Important** • Do not switch off the main power immediately after switching on the main power. This may damage the hard disk and the memory or cause a machine malfunction.

- 1 Make sure that the power cord is plugged in correctly.
- 2 Press the main power switch to the [ | ] position to switch the main power on.

The <Main Power> indicator lights up on the control panel.

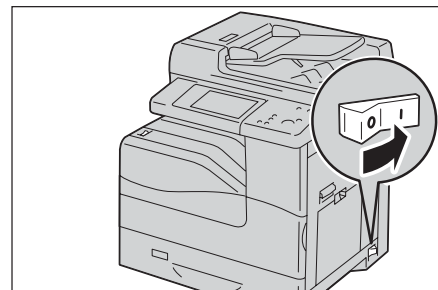

## Switching the Power On

The following describes how to switch the power on.

The machine takes approximately 30 seconds to warm up and to be ready to copy or print after switching the power on. This may take more time depending on your machine configuration.

Switch the power off at the end of the day or when not using the machine for an extended period of time.

Use also the Energy Saver feature to save power consumption while the machine is not in use.

For information on the Energy Saver feature, refer to "Energy Saver Mode" (P.48).

**Important** • If the power is switched off, all the services of the machine will stop. When using the machine throughout the day for jobs such as receiving fax, do not switch the power off.



- 1 Press the power switch to the [ ] position to switch the power on.

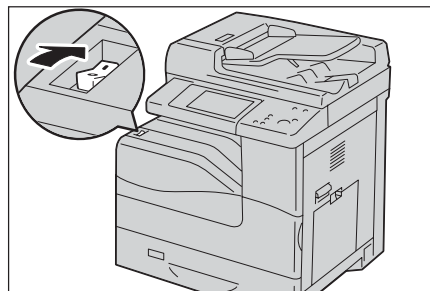

- Note**
- The “Please wait...” message indicates that the machine is warming up. The machine is not available during warming up.
  - If the machine does not power on, check the following:
    - The power cord is plugged in.
    - The main power is switched on.
    - The <RESET> button is in the depressed position.

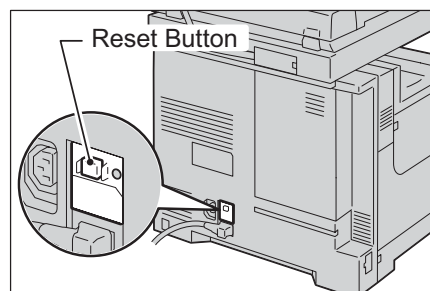

## Switching the Power Off

The following describes how to switch the power off.

- 1 Before switching the power off, make sure that the machine has completed all copy or print jobs. Then, make sure that the <Data> indicator does not light up.

- Note**
- Do not switch the power off in the following situations. If the power is switched off, the processing data may be erased.
    - While data is being received
    - While a job is being printed
    - While a job is being copied
    - While a job is being scanned
  - When switching the power off, wait 5 seconds after outputs have been delivered.

- 2 Press the power switch to the [ ] position.

- Important**
- Power off processing is performed internally on the machine for a while after the power is switched off. Therefore, do not switch the main power off immediately after switching the power off.

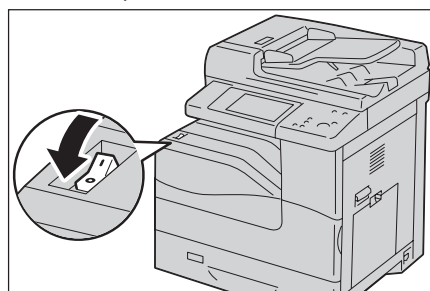

- Note**
- When powering the machine on after it has been switched off, wait 10 seconds after the touch screen has gone dark.

## Switching the Main Power Off

The following describes how to switch the main power off.

- Important**
- Do not switch the main power off while the touch screen displays a screen or the <Energy Saver> button blinks. Switching off the main power may damage the hard disk and the memory or cause a machine malfunction.

- Switch the main power off first when unplugging the power cord. Unplugging the power cord with the main power on may damage the hard disk and the memory or cause a machine malfunction.

- 1** Make sure that the power is switched off.
- 2** Make sure that the touch screen is blank and the <Energy Saver> button does not light up.
- 3** Press the main power switch to the [O] position to switch the main power off.  
The <Main Power> indicator goes out on the control panel.

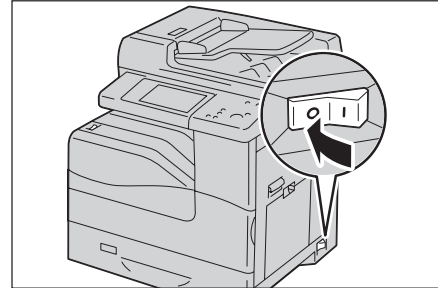

## Ground Fault Interrupter

The machine is provided with a ground fault interrupter.

In the event of a current leakage, the ground fault interrupter will automatically cut off the power circuit to prevent any leakage of fire from occurring.

Check that the ground fault interrupter works properly at least once a month.

Be sure ground fault interrupter may be disabled, causing a risk of electric shock.

If you have any problems with the ground fault interrupter, contact our Customer Support Center.

The following describes how to check the ground fault interrupter.

- 1 Press the power switch to the [⏻] position to switch the power off.

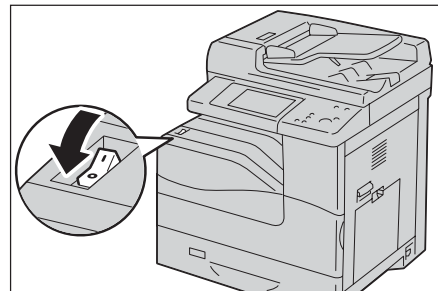

- 2 Make sure that the touch screen is blank and the <Energy Saver> button does not light up.

- 3 Press the main power switch to the [○] position to switch the main power off.

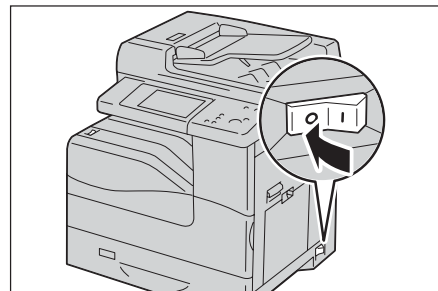

- 4 Press the <RESET> button. The button will be depressed even after the pushing force is released.

- 5 Press the <TEST> button lightly with a sharp edge such as a pen tip. The depressed <RESET> button will stick out again.

This is the end of the check procedure.

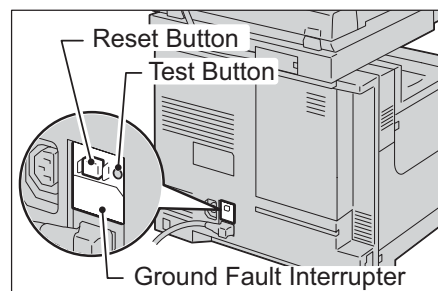

- 6 Press the <RESET> button back to the depressed position.

## Energy Saver Mode

The machine is equipped with the Energy Saver mode that reduces the power consumption by saving the electricity to the machine when no copy or print data is received for a specified time.

The Energy Saver feature has two modes: Low Power mode and Sleep mode.

The machine enters the Low Power mode after the preset time has elapsed if the machine is left unused for a fixed period of time.

The machine then enters the Sleep mode if a further preset time elapses.

To enter the Energy Saver mode, press the <Energy Saver> button on the control panel.

### ■ Low Power Mode

In this mode, the power to the control panel and fusing unit is lowered to save power.

The touch screen goes out, and the <Energy Saver> button on the control panel lights up. To use the machine, press the <Energy Saver> button. The <Energy Saver> button goes out to indicate that the Low Power mode is exited.

### ■ Sleep Mode

In this mode, the power is lowered more than in the Low Power mode.

The touch screen goes out, and the <Energy Saver> button on the control panel lights up. To use the machine, press the <Energy Saver> button. The <Energy Saver> button goes out to indicate that the Sleep mode is exited.

## Entering the Energy Saver Mode

The following describes how to enter the Energy Saver mode.

- Note**
- To enter the Energy Saver mode by pressing the <Energy Saver> button, specify a longer time period in [From Last Operation to Sleep Mode] than in [From Last Operation to Low Power Mode] under [Energy Saver Timers]. For information on [Energy Saver Timers], refer to "5 Tools" > "Common Service Settings" > "Machine Clock/Timers" > "Energy Saver Timers" in the Administrator Guide.

### 1 Press the <Energy Saver> button.

- Note**
- The machine will not enter the Energy Saver mode while a job is being processed. Press the <Energy Saver> button after the job is completed.

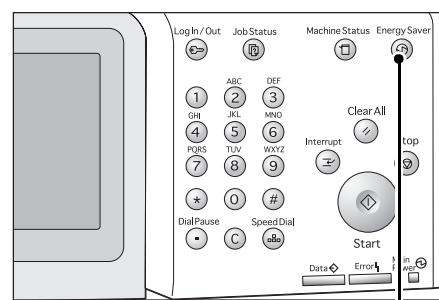

<Energy Saver> button

## Exiting the Energy Saver Mode

The following describes how to exit the Energy Saver mode.

The Energy Saver mode is exited in the following instances:

- Pressing the <Energy Saver> button
- Receiving a job
- Selecting [Apply] in CentreWare Internet Services

- Setting a document in the document feeder
- Opening the document cover

When the following device is connected to the machine and a user performs the following operation, the Low Power mode can be deactivated without pressing the <Energy Saver> button.

- Touch the card to IC Card Reader (optional)

**Note**

- If the machine is in the Sleep mode, however, the Sleep mode will not be deactivated by the operation above. To take full advantage of the feature that deactivate the Low Power mode without pressing the <Energy Saver> button, it is recommended to set the time to elapse until the machine enters the Sleep mode long enough. For more information on how to change the time to elapse until the machine enters the Sleep mode, refer to "1 Before Using the Machine" > "Energy Saver Mode" > "Changing the Interval for Entering Energy Saver Mode" in the Administrator Guide.

**1** Press the <Energy Saver> button.

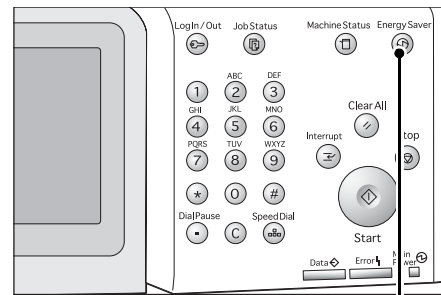

<Energy Saver> button

## Control Panel

The following describes the names and functions of components on the control panel.

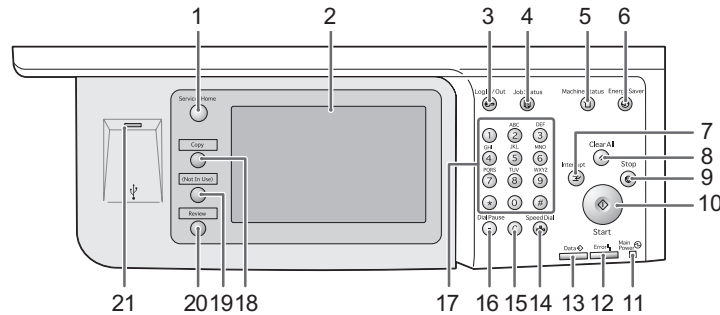

No.	Component	Function
1	<Services Home> button	Press this button to display the [Services Home] screen. You can change the services displayed on the [Services Home] screen. For more information, refer to "1 Before Using the Machine" > "Customizing the Control Panel" > "Customizing the Control Panel" > "Customizing the [Services Home] Screen" in the Administrator Guide.
2	Touch screen	Displays messages required for operation, and buttons for various features. You can directly touch the touch screen to instruct operations and set features.
3	<Log In/Out> button	Lights up when a user is authenticated in the System Administration mode, the Authentication mode, or the Accounting mode. Displays the User ID entry screen for entering the System Administration mode, the Authentication mode, or the Accounting mode. Press this button to exit these modes.
4	<Job Status> button	Press this button to check or cancel the current job, to check or print stored jobs, or to check completed jobs.
5	<Machine Status> button	Press this button to check the machine status and meters, to check the status of consumables, and to print reports.
6	<Energy Saver> button	When the machine is not used for a while, it enters the Energy Saver mode to reduce power consumption. When the Energy Saver mode is active, the <Energy Saver> button lights up. Press this button to enter or exit the Energy Saver mode.
7	<Interrupt> button	Press this button to suspend a copy or print job in progress to have the machine process another job. During the Interrupt mode, the <Interrupt> button lights up. Pressing the <Interrupt> button again exits the Interrupt mode and resumes the suspended job.  Some types of jobs cannot be executed in the Interrupt mode. Refer to "15 Appendix" > "Notes and Restrictions" > "Notes and Restrictions on the Interrupt Mode" in the Administrator Guide.
8	<Clear All> button	Returns the settings you made to the default values. The machine returns to the same state as when it is powered on.
9	<Stop> button	Press this button to pause the current copy job or communications.
10	<Start> button	Press this button to start scanning a document.

No.	Component	Function
11	<Main Power> indicator	<p>Lights up when the main power is switched on.</p> <p><b>Note</b></p> <ul style="list-style-type: none"> <li>If the main power is not switched on, the machine will not be powered on even when the power is switched on.</li> </ul>
12	<Error> indicator	<p>Blinks if a system error occurs.</p> <p>This indicator lights up when a problem other than a system error occurs with the machine, including paper jams and running out of paper.</p> <p>If the &lt;Error&gt; indicator blinks, contact our Customer Support Center.</p> <p>For information on the remedies for paper jams and running out of paper, refer to "14 Problem Solving" in the Administrator Guide.</p>
13	<Data> indicator	<p>Blinks when the machine is sending or receiving data to or from a client. This indicator lights up when data is stored in the machine's memory, when received faxes are waiting to be printed, or when faxes are stored in a folder.</p> <p>You can check stored scan files in a Folder List. For information on the Folder List, refer to "4 Machine Status" &gt; "Machine Information" &gt; "Print Reports" &gt; "Folder List" in the Administrator Guide.</p> <p>You can check stored fax files in a Stored File List. For information on the Stored File List, refer to "4 Machine Status" &gt; "Machine Information" &gt; "Print Reports" &gt; "Job Status/Activity Report" &gt; "Stored File List" in the Administrator Guide.</p> <p>You can change the lighting pattern of the &lt;Data&gt; indicator. For more information, refer to "5 Tools" &gt; "Common Service Settings" &gt; "Other Settings" &gt; "Data Indicator" in the Administrator Guide.</p>
14	<Speed Dial> button	Press this button to specify a recipient with an address number when sending a fax or e-mail.
15	<C (Clear)> button	Press this button to cancel a numerical value you have entered with the numeric keypad.
16	<Dial Pause> button	Press this button to insert a pause into a destination number.
17	Numeric keypad	Use the numeric buttons on the keypad to enter the number of copies, passcodes, and other numerical values.
18	<Copy> button	<p>"Copy" is assigned to this button by default.</p> <p>Press this button to display the [Copy] screen.</p> <p>For information on how to assign a service to the button, refer to "1 Before Using the Machine" &gt; "Customizing the Control Panel" &gt; "Assigning Services to Custom Buttons" in the Administrator Guide.</p>
19	<(Not In Use)> button	<p>Press this button to call its associated service.</p> <p>To the button, you can assign [Language] or any service displayed on the [Services Home] screen.</p> <p>For information on how to assign a service to the button, refer to "1 Before Using the Machine" &gt; "Customizing the Control Panel" &gt; "Assigning Services to Custom Buttons" in the Administrator Guide.</p>
20	<Review> button	<p>"Review" is assigned to this button by default.</p> <p>On the [Review] screen, you can check a list of the status of Copy, Fax, and Scan services whose settings have been changed from the defaults. You can also check the details of fax and e-mail recipients.</p> <p>For information on how to assign a service to the button, refer to "1 Before Using the Machine" &gt; "Customizing the Control Panel" &gt; "Assigning Services to Custom Buttons" in the Administrator Guide.</p>

No.	Component	Function
21	USB memory slot	Insert a USB 2.0 memory device here. <b>Note</b> • This feature is not available for some models. An optional component is required. For more information, contact our Customer Support Center.



---

## Screens and Buttons Displayed

---

You can register or change the services and buttons displayed on the touch screen. You can customize the following screens:

- Note**
- The following screens and buttons may have been changed by the system administrator. Use the machine according to the changes being made.

### Setting the Initial Screen

You can set the screen displayed after switching the power on or exiting the Energy Saver mode.

### Setting the Screen Displayed after Auto Clear

You can select [Last Selection Screen] or [Services Home] for the screen to be displayed after Auto Clear.

### Assigning Services to the Custom Buttons

You can assign services to the Custom buttons on the control pane.

By assigning frequently-used services to the Custom buttons, you can switch to the services without returning to the [Services Home] screen.

- Note**
- By default, "Copy" is assigned to the <Copy> button, and "Review" is assigned to the <Review> button. No service is assigned to the <(Not In Use)> button.

### Customizing the [Services Home] Screen

You can customize the layout of services and buttons on the [Services Home] screen that is displayed when you press the <Services Home> button on the control panel.

For information on how to customize the [Services Home] screen, refer to "1 Before Using the Machine" > "Customizing the Control Panel" > "Customizing the Control Panel" > "Customizing the [Services Home] Screen" in the Administrator Guide.

## About the [Services Home] Screen

This section describes the fields and buttons on the [Services Home] screen which is displayed by pressing the <Services Home> button.

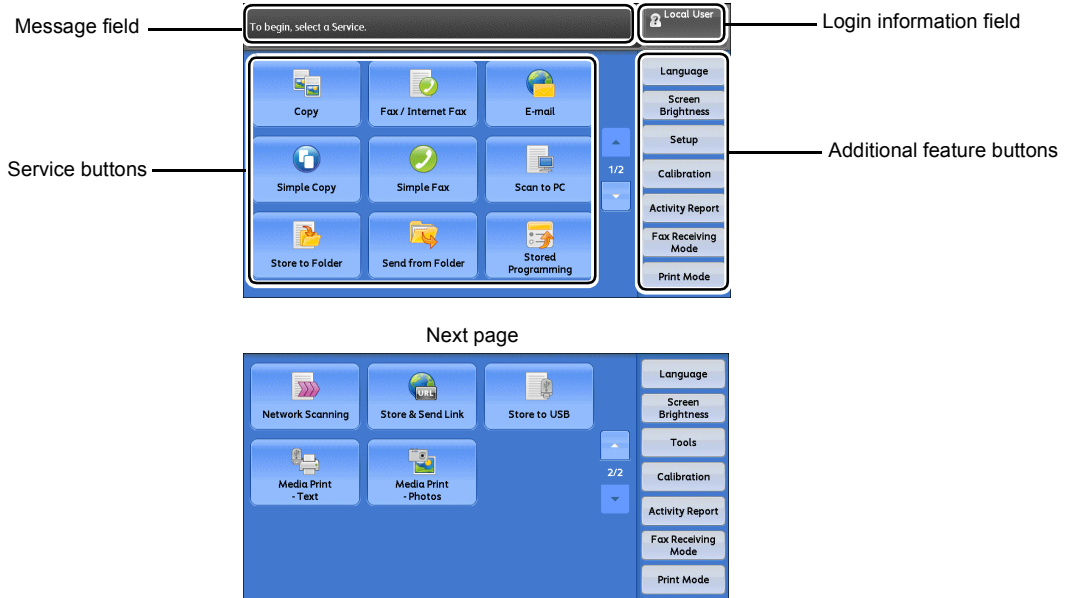

### Message Field

Displays a message.

### Login Information Field

Select this field in the upper right corner of the touch screen to display the User ID entry screen for entering the System Administration mode, the Authentication mode, or the Accounting mode.

When a user is authenticated, the login information is displayed in this field.

- Note**
- You can also press the <Log In/Out> button on the control panel to enter the Authentication mode.
  - To exit the Authentication mode, press the <Log In/Out> button on the control panel. You can also select the login information field in the upper right corner of the touch screen.

For information on the Authentication or Accounting mode, refer to "13 Authentication and Accounting Features" in the Administrator Guide.

### Service Buttons

Allows you to set the features for each service.

#### ■ Copy

You can set the features for the Copy service.

For more information, refer to "Copy" (P.59).

#### ■ Fax/Internet Fax

You can set the features for the Fax service.

For more information, refer to "Fax" (P.141).

### ■E-mail

You can scan documents and send the scanned data as an e-mail attachment.

For more information, refer to "E-mail" (P.232).

### ■Simple Copy

You can set the features for the Copy service. Selecting [Simple Copy] allows you to easily specify the basic copy features on a single screen.

For more information, refer to "Simple Copy" (P.69).

### ■Simple Fax

You can set the features for the Fax service. Selecting [Simple Fax] allows you to easily specify the basic fax features on a single screen.

For more information, refer to "Simple Fax" (P.160).

### ■Scan to PC

You can scan documents and send the scanned data to a network computer via the FTP or SMB protocol.

For more information, refer to "Scan to PC" (P.253).

### ■Store to Folder

You can scan documents and save the scanned data in a folder of the machine.

For more information, refer to "Store to Folder" (P.259).

### ■Send from Folder

You can operate files stored in a folder of the machine.

For more information, refer to "Send from Folder" (P.289).

### ■Stored Programming

You can operate stored programs.

Stored Programming is a service that allows you to store settings that you expect to use frequently and call them with a single button operation.

For more information, refer to "Stored Programming" (P.305).

### ■Network Scanning

You can scan documents after specifying a file (job template) saving scanning conditions, information on the forwarding destination server, and others.

For more information, refer to "Network Scanning" (P.251).

### ■Store & Send Link

After you scan documents, the machine temporarily saves the scanned data and sends you e-mail attached with two URLs: one is for the location to retrieve the scanned data, and the other is for the location to delete the data.

For more information, refer to "Store & Send Link" (P.265).

**Note** • This service appears on the screen when the Authentication feature is enabled.

For information on how to display [Store & Send Link] on the [Services Home] screen, refer to "1 Before Using the Machine" > "Customizing the Control Panel" in the Administrator Guide.

### ■Store to USB

You can scan documents and save the scanned data to a USB memory device.

For more information, refer to "Store & Send Link" (P.265).

**Note** • This service is not available for some models. An optional component is required. For more information, contact our Customer Support Center.

### ■Media Print - Text

You can print document files (PDF, TIFF, and XML Paper Specification (XPS)) after retrieving the files from a CompactFlash card or a USB memory device. You can also print the scan data stored with the Store to USB service.

For more information, refer to "Media Print - Text" (P.324).

- Note**
- This service is not available for some models. An optional component is required. For more information, contact our Customer Support Center.

### ■Media Print - Photos

You can print image data (DCF1.0) taken with a digital camera. You can retrieve the data only from a CompactFlash card.

For more information, refer to "Media Print - Photos" (P.323).

- Note**
- This service is not available for some models. An optional component is required. For more information, contact our Customer Support Center.

## Additional Feature Buttons

Allows you to set the additional features that are not related to jobs.

### ■Language

You can select the language to be displayed on the touch screen.

The language selected here will be invalid when the power is switched off and on.

**Important** • When you select [English], only ASCII characters can be used.

- When you set [Language] to [English] on the [Services Home] screen and an address book entry is entered in double-byte characters, the characters may not be displayed properly.
- When you use CentreWare Internet Services to import a CSV file\* including double-byte characters other than a selected language, the characters in the file may be garbled or the import may fail.

\*: CSV (Comma Separated Values) is a file format that is often used for saving data by spreadsheets and database programs.

- Note**
- Under [Default Language] in the System Administration mode, you can select the standard language displayed on the touch screen when the power is switched on. For more information on how to set [Default Language], refer to "5 Tools" > "Common Service Settings" > "Screen/Button Settings" > "Default Language" in the Administrator Guide.

### ■Screen Brightness

You can adjust the screen brightness of the touch screen.

### ■Lock Out Printer/Release Printer

You can set the machine to temporarily enable printing during the printer lockout period or to temporarily disable printing while [Release Printer] is displayed.

- Note**
- You can assign this button when [Printer Lockout] is set to [On] under [Tools] > [Common Service Settings] > [Machine Clock/Timers] and the [Allow User to Lock Out] check box is selected. For information on how to assign the feature to the button, refer to "5 Tools" > "Common Service Settings" > "Screen/Button Settings" in the Administrator Guide.

### ■Setup

You can create or update folders and the Address Book.

For more information, refer to "5 Tools" > "Setup" in the Administrator Guide.

### ■Calibration

The machine can automatically calibrate colors when the reproducibility of density or color in copies and prints deteriorates.

For more information, refer to "3 Maintenance" > "Executing Calibration" in the Administrator Guide.

■ **Activity Report**

You can print an Activity Report to check if a transmission is successfully completed.  
For information on the contents listed in the Activity Report, refer to "15 Appendix" > "Activity Report" in the Administrator Guide.

■ **Fax Receiving Mode**

You can specify a mode for receiving faxes.  
For more information, refer to "4 Machine Status" > "Machine Information" > "Fax Receiving Mode" in the Administrator Guide.

■ **Print Mode**

You can register a print mode and change its settings.  
For more information, refer to "4 Machine Status" > "Machine Information" > "Print Mode" in the Administrator Guide.

## Entering Text

During operations, a screen for entering text sometimes appears. The following describes how to enter text.

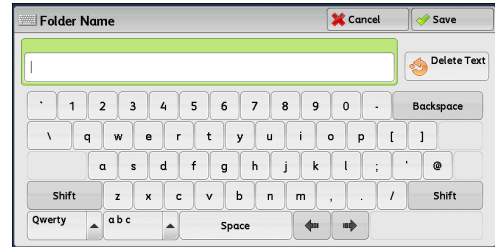

You can enter the following characters: numerals, alphabets, and symbols.

Item	Description
Entering alphabets and numerals	To enter uppercase letters, select [Shift]. To return to the lowercase letters, select [Shift] again.
Entering symbols	Select [More Characters]. <b>Note</b> <ul style="list-style-type: none"> <li>• Depending on the keyboard, you can select a symbol from the pull-up options displayed on the bottom left of the screen.</li> </ul>
Entering a space	Select [Space].
Deleting characters	Select [Backspace] to delete one character at a time.

# 3 Copy

This chapter describes the basic operation and features for the Copy service.

- Copying Procedure ..... 60
- Operations during Copying ..... 66
- Simple Copy ..... 69
- Copy ..... 74
- Image Quality..... 86
- Layout Adjustment ..... 93
- Output Format..... 107
- Job Assembly ..... 121

## Copying Procedure

This section describes the basic copy procedures. The following shows the reference section for each procedure.

Step 1 Loading Documents .....	60
Step 2 Selecting Features .....	62
Step 3 Entering a Quantity .....	63
Step 4 Starting the Copy Job .....	64
Step 5 Confirming the Copy Job in Job Status .....	65

### Step 1 Loading Documents

The following two methods are available to load documents:

#### ■ Document Feeder

- Single sheet
- Multiple sheets

#### ■ Document Glass

- Single sheet
- Bound documents, such as books

#### Document Feeder

The document feeder supports single and multiple sheet documents with sizes from 125 x 85 mm (Standard size: A5, A5 $\square$ ) to 216 x 356 mm (Standard size: A4, 8.5 x 11").

The document feeder automatically detects standard size documents. For non-standard size documents, enter the size on the [Original Size] screen.

**Note** • The minimum supported paper size for 2-sided copying: 125 x 110mm (Standard size: A5, A5 $\square$ ).

For information on document sizes that can be detected automatically and how to enter a non-standard document size, refer to "Original Size (Specifying the Scan Size for the Document)" (P.98).

The standard document sizes that can be detected automatically depend on [Paper Size Settings] in the System Administration mode. For information on [Paper Size Settings], refer to "5 Tools" > "Common Service Settings" > "Other Settings" > "Paper Size Settings" in the Administrator Guide.

The document feeder accepts the following number of sheets.

Document Type (Weight)	Number of Sheets
Lightweight paper (38 - 49 gsm)	110 sheets
Plain paper (50 - 80 gsm)	110 sheets
Heavyweight paper (81 - 128 gsm)	75 sheets

**Important** • To avoid paper jams, use the document glass for folded or wrinkled documents, cut-and-pasted documents, curled paper, or back carbon paper.  
• 2-sided scanning of lightweight paper (38 - 49 gsm) is not supported.

For information on how to copy mixed sized documents, refer to "Mixed Size Originals (Scanning Different Size Documents Simultaneously)" (P.99).

- 1 Remove any paper clips and staples before loading a document.



- 2 Load the document face up (when the document is 2-sided, load the front side up) in the center of the document feeder.

**Note**

- The Confirmation indicator lights up when the document is loaded correctly. If the indicator does not light, load the document again.

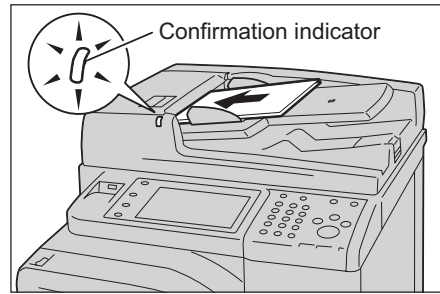

- 3 Adjust the document guides to match the size of the document loaded.

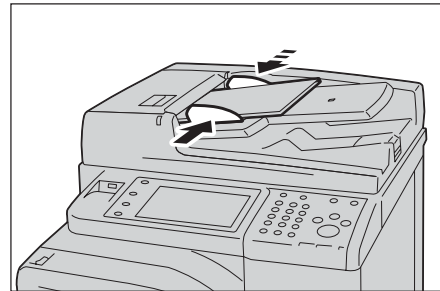

- 4 Raise the document stopper.

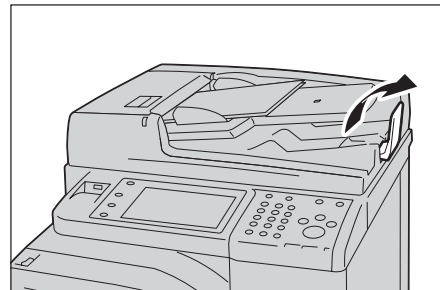

## Document Glass

The document glass supports a single sheet, a book, or other similar documents with sizes from 15 x 15 mm (Standard size: A5, A5□) to 216 x 356 mm (Standard size: A4).

**Important** • Always close the document cover after using the document glass.

The document glass automatically detects standard size documents. For non-standard size documents, enter the size on the [Original Size] screen.

For information on document sizes that can be detected automatically and how to enter a non-standard document size, refer to "Original Size (Specifying the Scan Size for the Document)" (P.98).

The standard document sizes that can be detected automatically depend on [Paper Size Settings] in the System Administration mode. For information on the paper size settings, refer to "5 Tools" > "Common Service Settings" > "Other Settings" > "Paper Size Settings" in the Administrator Guide.

### CAUTION

Do not apply excessive force to hold thick document on the document glass. It may break the glass and cause injuries.

- 1 Open the document cover.

**Important** • Ensure that the touch screen is active, and then load a document. Otherwise, the machine may not properly detect the document size.

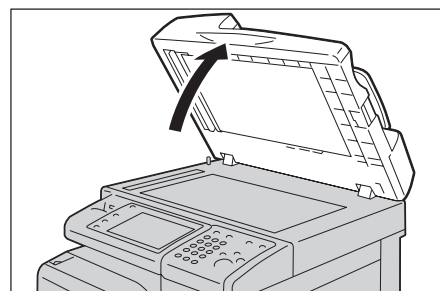

- 2 Load the document face down, and align it against the top left corner of the document glass.

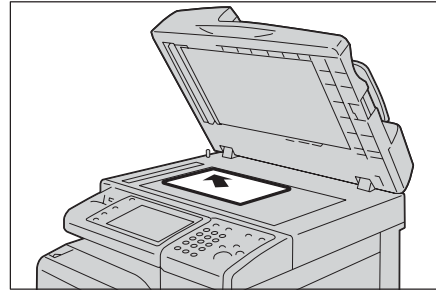

- 3 Close the document cover.

**Note** • When a standard size document is loaded on the document glass, the size of the document is displayed in the message field.

## Step 2 Selecting Features

The following two services are available to copy documents.

### ■ Simple Copy

Allows you to only select basic features to copy documents.

### ■ Copy

Allows you to make detailed settings to copy documents.

The following procedure uses [Copy] to describe how to select features.

For information on Simple Copy, refer to "Simple Copy" (P.69).

**Note** • The features displayed on the screen depend on your machine configuration.  
 • When the Authentication or Accounting feature is enabled, a user ID and passcode may be required. Ask your system administrator for the user ID and passcode.

- 1 Press the <Services Home> button.

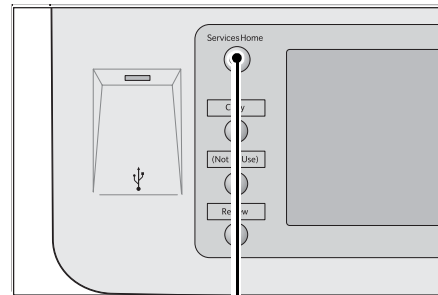

<Services Home> button

- 2 Select [Copy].

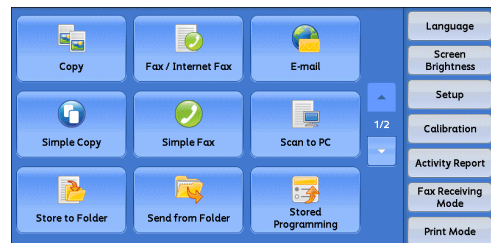

- 3 If the previous settings still remain, press the <Clear All> button.

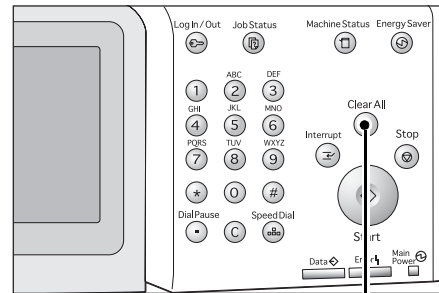

<Clear All> button

- 4 Select each tab, and configure features as necessary.

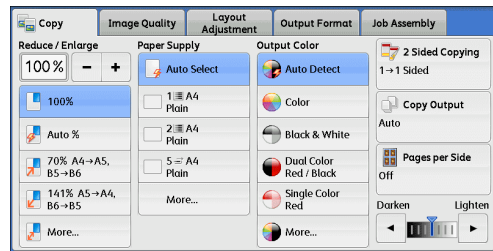

The following shows the reference section for each tab.

- "Copy" (P.74)
- "Image Quality" (P.86)
- "Layout Adjustment" (P.93)
- "Output Format" (P.107)
- "Job Assembly" (P.121)

### Step 3 Entering a Quantity

The following describes how to enter the number of copy sets. You can enter up to 999 sets.

- 1 Enter the number of copies using the numeric keypad. The number of copies entered appears on the upper right of the touch screen.

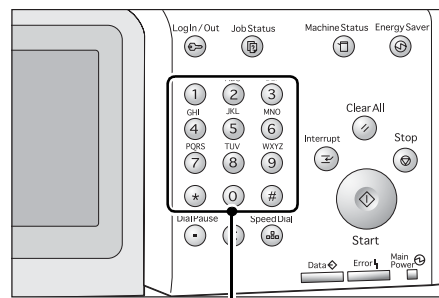

Numeric keypad

- 2 If you have entered an incorrect value, press the <C (Clear)> button and then enter the correct value.

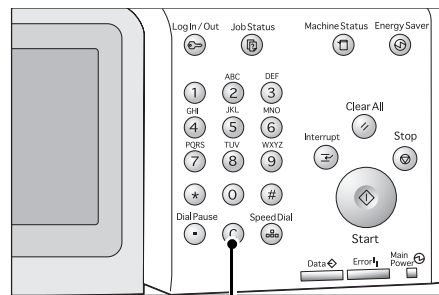

<C (Clear)> button

## Step 4 Starting the Copy Job

The following describes how to start a copy job.

Press the <Start> button.

**Important** • If the document has been loaded in the document feeder, do not hold down the document while it is being conveyed.

**Note** • Move the lever of the fusing unit down to set to the Envelope mode before copying on an envelope. Return the lever to its original position before copying on other types of papers. Any type of paper other than envelope cannot be copied while the lever is set to the Envelope mode position. For information on how to switch the lever of the fusing unit, refer to "2 Paper and Other Media" > "Loading Paper" > "Loading an Envelope in Tray 1 to 4" or "Loading an Envelope in Tray 5" in the Administrator Guide.

- If a problem occurs, an error message appears on the touch screen. Solve the problem according to the message.
- You can set the next job during copying.

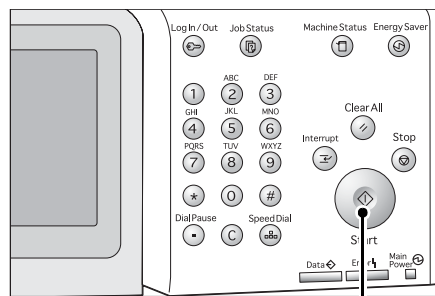

<Start> button

### ■ If you have more documents

If you have more documents to copy, select [Next Original] on the touch screen while the current document is being scanned. This allows you to scan the documents as a single set of data.

Select [Next Original] while scanning is in progress.

**Note**

- When using the document feeder, load the next document after the machine has finished scanning the first document.
- When [Next Original] is displayed on the screen shown on the right and no operation is performed for a certain period of time, the machine automatically assumes that there are no more documents.
- You can change the number of copies by selecting [Change Quantity] that is displayed after selecting [Delete].

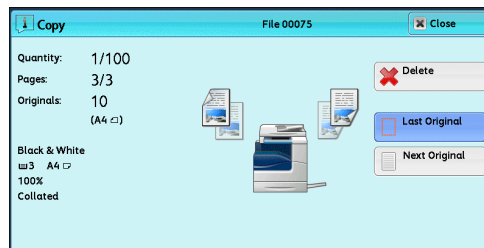

**3** Load the next document.

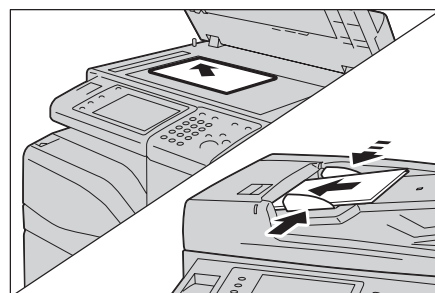

**4** Press the <Start> button.

If you have more documents, repeat steps 3 and 4.

**5** When all documents have been scanned, select [Last Original].

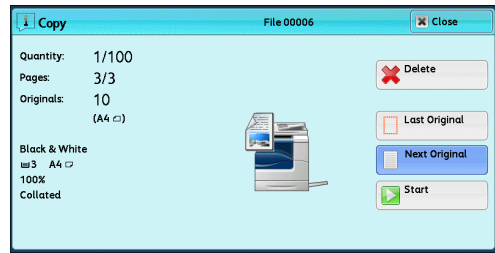

## Step 5 Confirming the Copy Job in Job Status

If copies are not output after you start the copy job, the job may be in pending status. Use the following procedure to confirm the job status.

- 1 Press the <Job Status> button

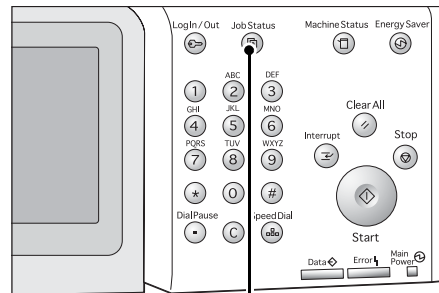

<Job Status> button

- 2 Confirm the job status.

**Note** • Select [▲] to return to the previous screen or [▼] to move to the next screen.

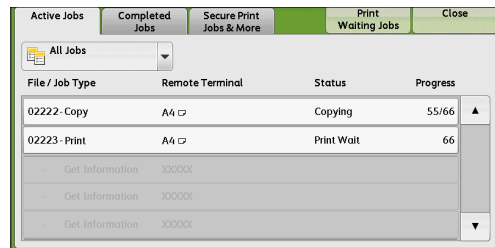

## Operations during Copying

This section describes available operations during copying. The following shows the reference section for each operation.

Stopping the Copy Job .....	66
Changing the Number of Copies.....	67
Interrupting the Copy Job .....	68

### Stopping the Copy Job

To cancel a copy job in progress, use the following procedure.

- 1 Press either the <Stop> button on the control panel or [Delete] on the touch screen.

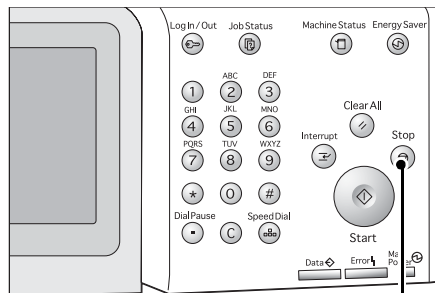

<Stop> button

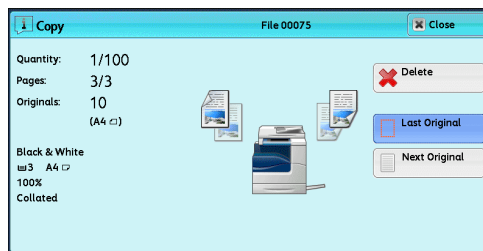

- 2 Select [Delete]

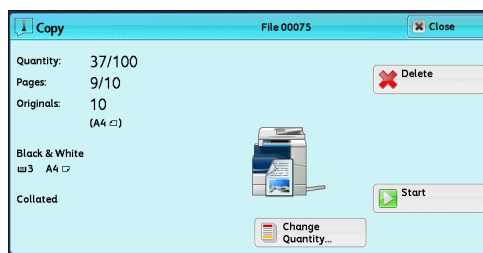

■If [Delete] does not appear on the screen:

- 1 Press the <Job Status> button.

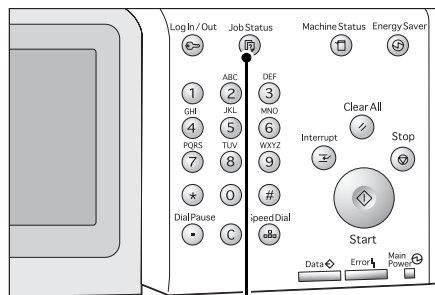

<Job Status> button

**2** Select the job to cancel.

**Note** • Select [▲] to return to the previous screen or [▼] to move to the next screen.

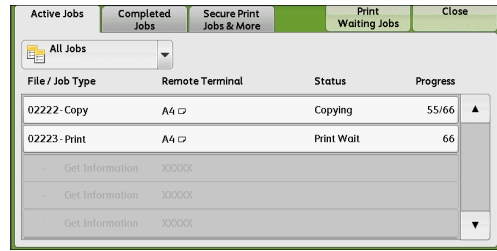

**3** Select [Delete].

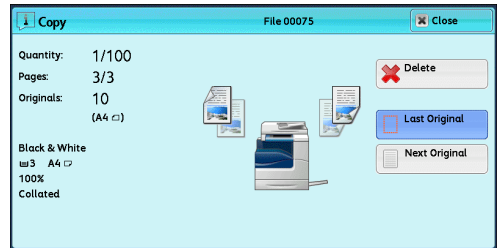

**4** Select [Delete].

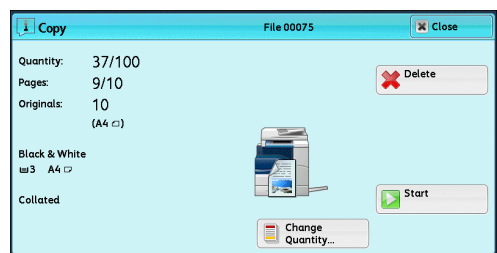

Copy 3

## Changing the Number of Copies

To change the number of copy sets during scanning or copying, use the following procedure.

**1** Press either the <Stop> button on the control panel or [Delete] on the touch screen.

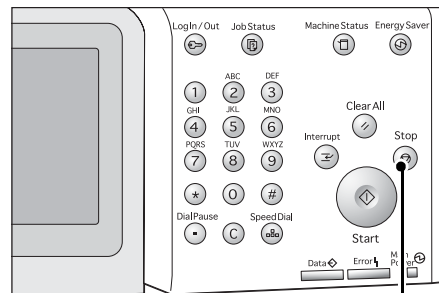

<Stop> button

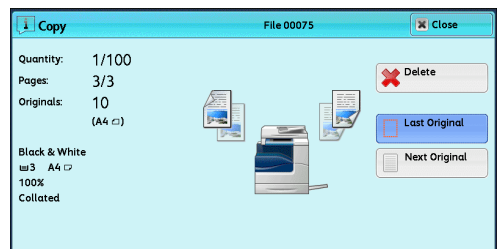

- 2 Select [Change Quantity].

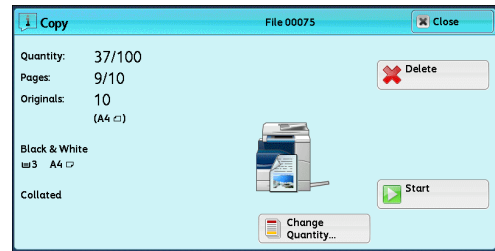

- 3 Specify the number of copy sets with the numeric keypad.  
The new quantity must include the number of copies that have already been printed. You cannot enter a number less than the number of copies that have already been printed.

- 4 Press the <Start> button.

**Note** • If you enter the same value as the number of copies that have already been printed, the machine will not execute a copy job even when you press the <Start> button.

## Interrupting the Copy Job

You can temporarily stop the copy job to have the machine process another job.

**Important** • Press the <Interrupt> button only after all the documents have been scanned. The machine does not accept another job while it is scanning the documents, or [Next Original] has been selected.

- 1 Press the <Interrupt> button.  
The <Interrupt> button lights up to indicate that the machine is in the Interrupt mode.

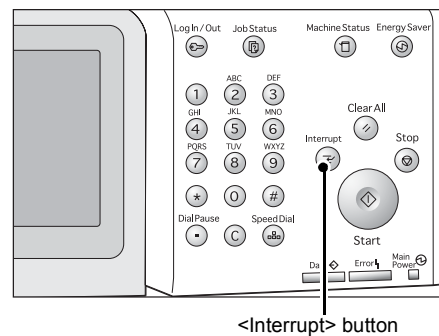

- 2 Load a document and set features if necessary.
- 3 Specify the number of copy sets with the numeric keypad.
- 4 Press the <Start> button.
- 5 After you have finished making the interrupt copy, press the <Interrupt> button.  
The <Interrupt> button goes out to indicate that the Interrupt mode is exited.

**Note** • If you used the document glass to copy the document, remove the document from the document glass.

- 6 Press the <Start> button.  
The suspended copy job is resumed.



## Simple Copy

You can select [Copy] or [Simple Copy] on the [Services Home] screen to set the features for the Copy service.

This section describes the features you can select on the [Simple Copy] screen. [Simple Copy] allows you to use only basic features to easily copy documents. The following shows the reference section for each feature.

Paper Supply (Selecting the Paper for Copying) .....	69
Reduce/Enlarge (Making Enlarged/Reduced Copies).....	70
2 Sided Copying (Making 2 Sided Copies).....	71
Black & White/Color (Selecting the Color for Copying) .....	71
Lighten/Darken (Adjusting the Copy Density) .....	72
2 Pages Up (Copying Two Pages onto One Sheet).....	72
Original Orientation (Specifying the Orientation of Loaded Documents).....	72

- 1 Select [Simple Copy] on the [Services Home] screen.

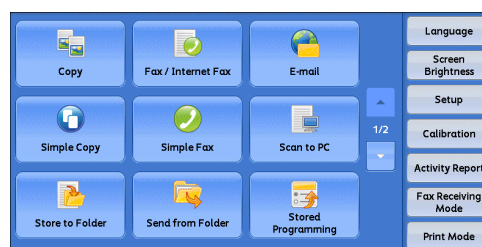

- 2 Select a feature on the [Simple Copy] screen.

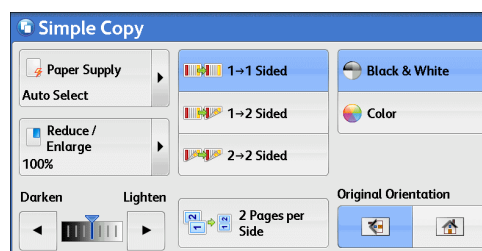

## Paper Supply (Selecting the Paper for Copying)

This feature allows you to select the paper tray for copying.

- 1 Select [Paper Supply].

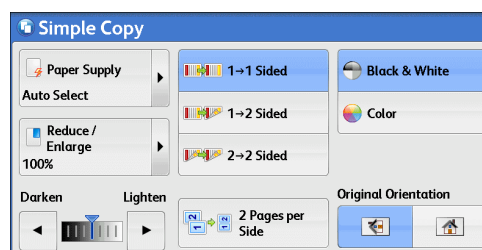

- 2 Select a paper tray to be used.

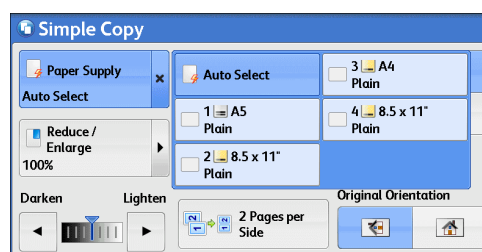

**■Auto Select**

Automatically determines the tray holding the appropriate paper, based on the document size and the specified copy ratio.

**Note** • If you select [Auto Select], an option other than [Auto %] is selected in [Reduce/Enlarge].

**■Tray 1, and Trays 2 to 4 (optional)**

Allows you to directly select the desired tray.

**Checking the Remaining Amount of Paper in a Tray**

The icons displayed in a tray allows you to check the remaining amount of paper loaded in the tray.

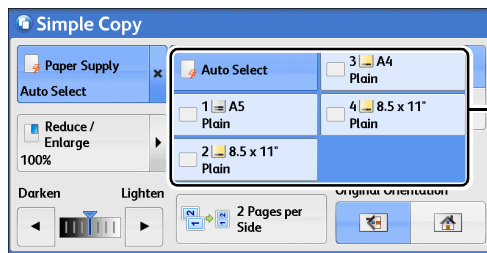

You can view the icons to check the remaining amount of paper in a tray.



: Indicates that the remaining amount of paper is 25 to 100%.



: Indicates that the remaining amount of paper is 25% or less.



: Indicates that the tray runs out of paper, or no paper is loaded in the tray.

**Reduce/Enlarge (Making Enlarged/Reduced Copies)**

This feature allows you to select a copy ratio to enlarge or reduce the size of copies.

**1** Select [Reduce/Enlarge].

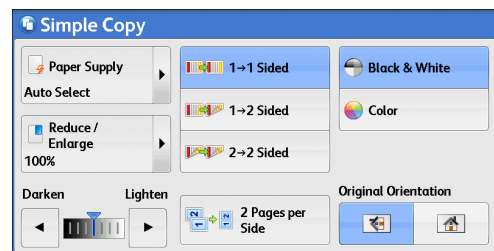

**2** Select a copy ratio.

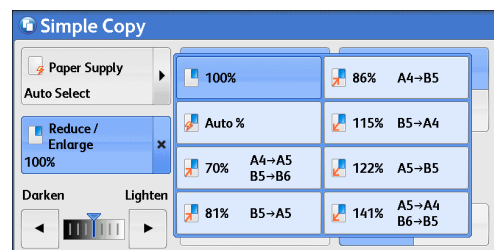

**■100%**

Copies at the same image size as the original document.

### ■Auto %

Automatically determines the copy ratio based on the document size and the paper size specified in [Paper Supply], and copies the document to fit into the paper.

**Note** • If you select [Auto %], an option other than [Auto Select] is selected in [Paper Supply].

### ■Ratios

Allows you to select from preset copy ratios.

## 2 Sided Copying (Making 2 Sided Copies)

This feature allows you to copy 1-sided and 2-sided documents on one side or both sides of paper.

- 1 Select any option.

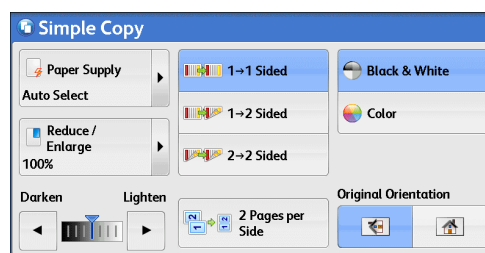

### ■1 → 1 Sided

Makes a copy of a 1-sided document on one side of the paper.

### ■1 → 2 Sided

Makes a copy of a 1-sided document on both sides of the paper.

### ■2 → 2 Sided

Makes a copy of a 2-sided document on both sides of the paper.

## Black & White/Color (Selecting the Color for Copying)

This feature allows you to select a color mode.

- 1 Select [Black & White] or [Color].

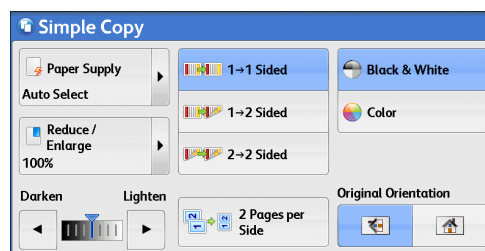

### ■Black & White

Copies in black and white regardless of the colors in the original document.

### ■Color

Copies in full color.

**Note** • If the use of certain colors is not allowed, the available colors will be restricted. For more information, refer to "5 Tools" > "Accounting" > "Create/View User Accounts" > "Account Limit" in the Administrator Guide.

## Lighten/Darken (Adjusting the Copy Density)

This feature allows you to select a copy-density level from seven levels. The copy becomes darker when you move [▼] to the left, and lighter when you move it to the right.

- 1 Use [◀] and [▶] to select a density level.

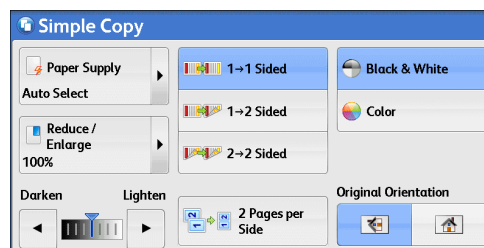

## 2 Pages Up (Copying Two Pages onto One Sheet)

This feature allows you to copy two pages of a document together onto a single sheet of paper.

When you select [2 Pages Up], [Auto %] is automatically selected in [Reduce/Enlarge]. The machine automatically sets the copy ratio and makes copies of the images so that they fit on the selected paper.

- Note**
- When you deselect [Auto %] in [Reduce/Enlarge] (when you select another copy ratio), image loss may occur depending on the image size of the document.
  - Select a tray other than [Auto Select] in [Paper Supply]. When you select [Auto Select], the tray containing A4 paper is selected. If no tray contains A4 paper, the machine select a tray based on the [Auto Paper Off] setting. For information on [Auto Paper Off], refer to "5 Tools" > "Copy Service Settings" > "Copy Control" > "Auto Paper Off" in the Administrator Guide.

For information on how to copy four or eight pages of a document together onto a single sheet of paper, refer to "Pages per Side (Copying Multiple Pages onto One Sheet)" (P.111).

- 1 Select [2 Pages Up].

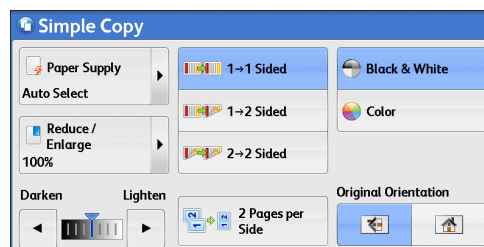

## Original Orientation (Specifying the Orientation of Loaded Documents)

This feature allows you to specify the orientation of a document so that the machine can identify the top of the document.

- Note**
- If the [Original Orientation] setting differs from the actual document orientation, the machine may not detect the top of the document correctly.

- 1 Select [Original Orientation].

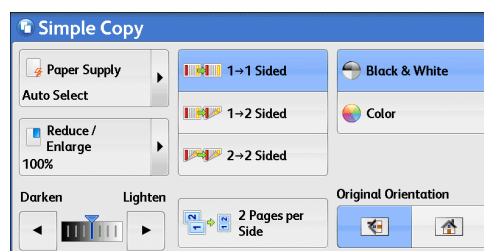

■  **Sideways Images**

Select this option when placing the top edge of the document against the left side of the document glass or document feeder.

■  **Upright Images**

Select this option when placing the top edge of the document against the top side of the document glass or document feeder.

# Copy

You can select [Copy] or [Simple Copy] on the [Services Home] screen to set the features for the Copy service.

This section describes the features you can select on the [Copy] screen. The following shows the reference section for each feature.

- Reduce/Enlarge (Making Enlarged/Reduced Copies) .....74
- Paper Supply (Selecting the Paper for Copying) .....77
- Output Color (Selecting the Color for Copying) .....80
- 2 Sided Copying (Making 2 Sided Copies) .....85
- Copy Output (Specifying Finishing Options).....85
- Pages per Side (Copying Multiple Pages onto One Sheet).....85
- Lighten/Darken (Adjusting the Copy Density).....85

You can customize the layout of the features displayed on the [Copy] screen. For more information, refer to "5 Tools" > "Copy Service Settings" > "Copy Tab - Features Allocation" in the Administrator Guide.

Copy  
3

- 1 Select [Copy] on the [Services Home] screen.

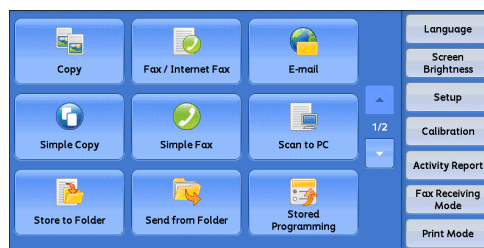

- 2 Select a feature on the [Copy] screen.

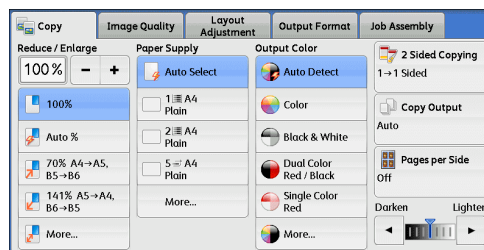

## Reduce/Enlarge (Making Enlarged/Reduced Copies)

This feature allows you to select a copy ratio to enlarge or reduce the size of copies.

- 1 Specify a copy ratio. You can use the numeric keypad to specify a value, or [+] and [-] to specify reduction/enlargement ratios directly.

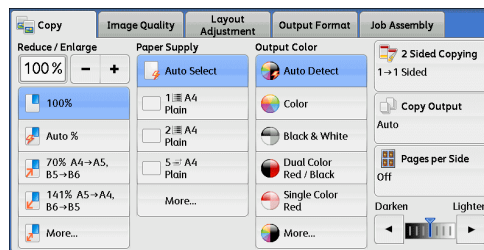

■ **100%**

Copies at the same image size as the original document.

### ■Auto %

Automatically determines the copy ratio based on the document size and the paper size specified in [Paper Supply], and copies the document to fit into the paper.

**Note** • If you select [Auto %], an option other than [Auto Select] is selected in [Paper Supply].

### ■Ratios (3rd and 4th buttons)

Displays preset copy ratios.

You can change the copy ratio associated with each button. For information on the settings, refer to "5 Tools" > "Copy Service Settings" > "Preset Buttons" > "Reduce/Enlarge - Button" in the Administrator Guide.

### ■More

Displays the [Reduce/Enlarge] screen on which you can set [Proportional %], [Independent X - Y%], and [Calculator %].

For information on the settings on the [Reduce/Enlarge] screen, refer to "When [Proportional %] is Selected" (P.75), "When [Independent X - Y%] is Selected" (P.76), or "When [Calculator %] is Selected" (P.77).

## When [Proportional %] is Selected

You can select a ratio from the standard copy ratios, or can enter a ratio directly.

- 1 Select a copy ratio, or specify a value.

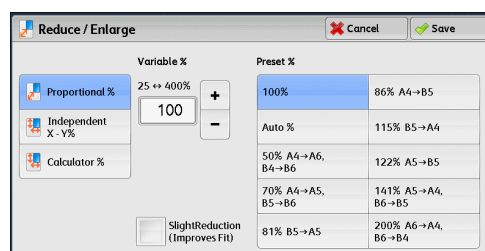

### ■Variable %

Specify a ratio in the range from 25 to 400% in 1% increments. To specify a value, use the numeric keypad or [+] and [-]. Specifying "100 %" allows you to make copies at the same image size as the original document.

When you make enlarged/reduced copies from standard sized documents on standard sized paper, the following copy ratios will be applied.

Copy Original	A5	B5	A4
A5	100%	122%	141%
B5	81%	100%	115%
A4	70%	86%	100%

How to load a document depends on the size and orientation of a document. For more information, refer to "Step 1 Loading Documents" (P.60).

For information on paper that can be loaded, refer to "2 Paper and Other Media" > "Paper Types" in the Administrator Guide.

### ■Preset %

Select a copy ratio from the following options.

- 100%

Copies at the same image size as the original document.

- Auto %

Automatically determines the copy ratio based on the document size and the paper size specified in [Paper Supply], and copies the document to fit into the paper.

**Note** • If you select [Auto %], an option other than [Auto Select] is selected in [Paper Supply].

- Preset ratios

Select from the preset ratios.

You can change the copy ratio associated with each button. For information on the settings, refer to "5 Tools" > "Copy Service Settings" > "Reduce/Enlarge Presets" in the Administrator Guide.

### ■Slight Reduction (Improves Fit)

Select this check box to slightly reduce the specified copy ratio to copy the complete image onto the paper.

**Important** • If you select [Slight Reduction (Improves Fit)] and you do not want to erase the edges of the document, set the amount of edge erase to 0 mm. Note that if the amount is set to 0 mm, the edges of the copied document may get dirty. You can set [Edge Erase] on the [Layout Adjustment] screen. For more information, refer to "Edge Erase (Erasing Edges and Margin Shadows of the Document)" (P.100).

## When [Independent X - Y%] is Selected

You can specify reduction/enlargement ratios for the width and length individually.

- 1 Select any option.

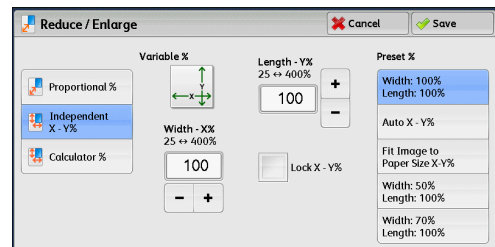

### ■Variable %

- Width - X%, Length -Y%

Allows you to specify reduction/enlargement ratios for the width and length in the range from 25 to 400% in 1% increments. Use [+] and [-] or the numeric keypad to specify a ratio.

### ■Lock X - Y%

Allows you to make the same ratio adjustment for the width and length at the same time.

### ■Preset %

- Width: 100% /Length: 100%

Copies at the same image size as the original document.

- Auto X - Y%

Automatically determines the reduction/enlargement ratios for the width and length so that the document image fits in the paper.



- Fit Image to Paper Size X - Y%

Automatically determines the reduction/enlargement ratios for the width and length so that the document image fits in the paper, and then slightly reduces the ratios so that the complete image is copied onto the paper.

- Width: XX% Length: XX%

Allows you to specify the preset reduction/enlargement ratios.

### When [Calculator %] is Selected

You can specify values for the length and width individually.

If you specify both the original document size and the desired copy size, the copy ratios for the length and width are calculated automatically in the range from 25 to 400% according to the values that you entered.

**Important** • Selecting [Calculator %] allows you to set copy ratios. The values entered in [Original Size] and [Copy Size] are used to calculate ratios, and do not reflect a scan size for the document or the paper size. Be sure to specify a scan size for the document. Also, select a paper tray if necessary.

For information on how to specify a scan size for the document, refer to "Original Size (Specifying the Scan Size for the Document)" (P.98). For information on how to select a paper tray, refer to "Paper Supply (Selecting the Paper for Copying)" (P.77).

- 1 Enter the width of the original document in [Original Size] of [Width X%] using the numeric keypad.

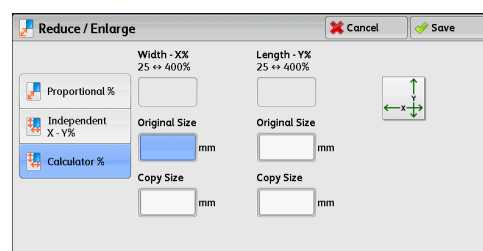

- 2 Enter the width of the output copy in [Copy Size] of [Width X%] using the numeric keypad.
- 3 In the same way, enter the length for [Original Size] and [Copy Size] of [Length Y%].

#### ■Width X% / Length Y%

Displays the ratios that are automatically calculated using the values set in [Original Size] and [Copy Size].

#### ■Original Size

Allows you to enter the width and length of the original document, in the range from 1 to 999 mm in 1 mm increments.

#### ■Copy Size

Allows you to enter the width and length of output copies, in the range from 1 to 999 mm in 1 mm increments.

## Paper Supply (Selecting the Paper for Copying)

This feature allows you to select the tray that holds the paper you want to use.

**1** Select a paper tray.

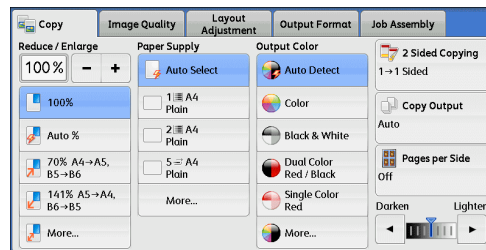

**Auto Select**

Automatically determines the tray holding the appropriate paper, based on the document size and the specified copy ratio.

**Note** • If you select [Auto Select], an option other than [Auto %] is selected in [Reduce/Enlarge].

**Trays (2nd to 5th trays)**

Allows you to directly select the desired tray.

You can change the paper tray associated with each button on the [Copy] screen. For information on the settings, refer to "5 Tools" > "Copy Service Settings" > "Preset Buttons" > "Paper Supply - Button" in the Administrator Guide.

**More**

Displays the [Paper Supply] screen.

Refer to "[Paper Supply] Screen" (P.78).

**Checking the Remaining Amount of Paper in a Tray**

The icons displayed in a tray allows you to check the remaining amount of paper loaded in the tray.

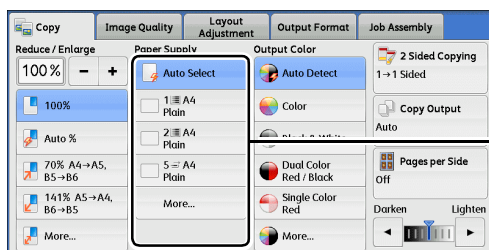

You can view the icons to check the remaining amount of paper in a tray.

: Indicates that the remaining amount of paper is 25 to 100%.

: Indicates that the remaining amount of paper is 25% or less.

: Indicates that the tray runs out of paper, or no paper is loaded in the tray.

**[Paper Supply] Screen**

This screen allows you to select a paper tray from all trays available on the machine.

## 1 Select a paper tray.

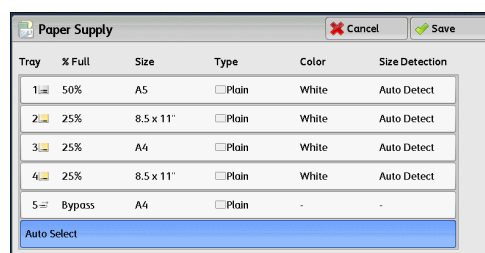

### ■ Tray

Allows you to select a paper tray. When [Tray 5] is selected, the [Tray 5] screen is displayed where you can specify a paper type other than plain paper, and non-standard size paper.

For more information, refer to "[Tray 5] Screen" (P.79).

**Note** • Trays 2, 3, and 4 are optional.

### ■ % Full

Displays the remaining amounts of paper loaded in trays.

### ■ Size

Displays paper sizes.

### ■ Type

Displays paper types.

### ■ Color

Displays paper colors.

For information on how to set [Paper Color], refer to "5 Tools" > "Common Service Settings" > "Paper Tray Settings" > "Paper Tray Attributes" in the Administrator Guide.

### ■ Size Detection

Displays how the machine detects a paper size.

For information on how to set [Size Detection], refer to "5 Tools" > "Common Service Settings" > "Other Settings" > "Paper Size Settings" in the Administrator Guide.

## [Tray 5] Screen

Set the paper loaded in Tray 5.

For information on paper that can be loaded in Tray 5, refer to "2 Paper and Other Media" > "Paper Types" in the Administrator Guide.

## 1 Select a paper size and a paper type.

**Note** • Select [▲] to return to the previous screen or [▼] to move to the next screen.

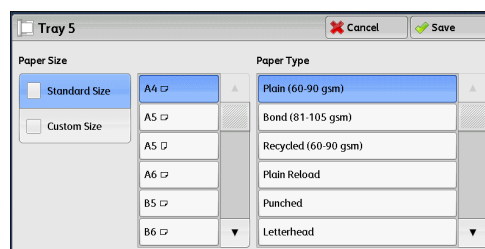

### ■ Paper Size

Select [Standard Size] or [Custom Size].

For more information on how to select the paper type, refer to "When [Standard Size] is Selected" (P.80) or "When [Custom Size] is Selected" (P.80), respectively.

■ Paper Type

Select a paper type.

When [Standard Size] is Selected

Select [Standard Size], and from the lists displayed, select a paper size and then a paper type.

- 1 Select a paper size and a paper type..

**Note** • Select [▲] to return to the previous screen or [▼] to move to the next screen.

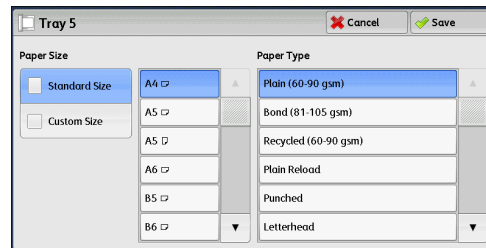

When [Custom Size] is Selected

Enter the width and length of the original document on the fields displayed after selecting [Custom Size].

Specify the X (width) in the range from 127 to 356 mm, and the Y (length) in the range from 76 to 216 mm in 1 mm increments.

- 1 Enter a paper size using [+] and [-] or the numeric keypad.

- 2 Select a paper type.

**Note** • Select [▲] to return to the previous screen or [▼] to move to the next screen.

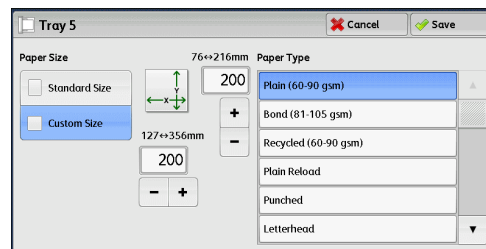

Output Color (Selecting the Color for Copying)

This feature allows you to select copy colors.

**Note** • If the use of certain colors is not allowed, the available colors will be restricted. For more information, refer to "5 Tools" > "Accounting" > "Create/View User Accounts" > "Account Limit" in the Administrator Guide.

- 1 Select a color mode.

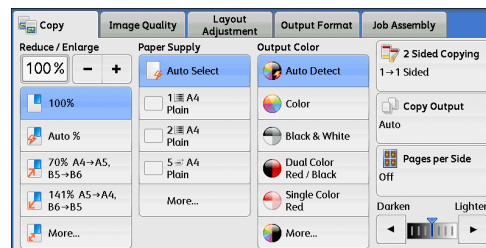

■ Auto Detect

The machine automatically determines the colors of the original document and makes copies in full color if the original document is colored, and in single color (black) if the document is black-and-white.

- Note**
- If a color document is in one of the following conditions, the machine may copy the document in black and white.
    - The colored area is too small.
    - The colors are too light.
 In that case, change a level from the five levels which is used for the machine to recognize color. For more information, refer to "5 Tools" > "Common Service Settings" > "Image Quality Adjustment" > "Image Quality" > "Output Color Recognition" in the Administrator Guide.

### ■Color

Copies in full color.

### ■Black & White

Copies in black and white regardless of the colors in the original document.

### ■Dual Color Red/Black

Copies color documents using two colors.

You can change the two colors. For more information, refer to "5 Tools" > "Copy Service Settings" > "Copy Defaults" > "Dual Color - Target Area Color" and "Dual Color - Non-target Area Color" in the Administrator Guide.

### ■Single Color Red

Copies color documents using one color.

You can change the red color to another one on the screen displayed after selecting [More] > [Single Color] > [Color]. For more information, refer to "5 Tools" > "Copy Service Setting" > "Copy Defaults" > "Single Color" in the Administrator Guide.

### ■More

Displays the [Output Color] screen.

For more information, refer to "[Output Color] Screen" (P.81).

## [Output Color] Screen

This screen allows you to make settings for full color, dual color, and single color.

- 1 Select [More].

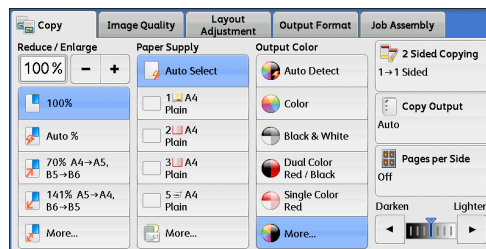

- 2 Select the desired output color mode.

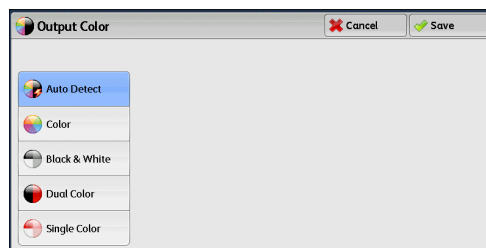

**■Auto Detect**

Automatically determines the color of the original document and makes copies in full color if the original document is colored, or in single color (black) if the document is black-and-white.

**■Color**

Copies in full color using all the four colors of toner: yellow, magenta, cyan, and black.

**■Black & White**

Copies in black and white regardless of the colors in the original document.

**■Dual Color**

Separates the colors of your document into the source colors and the other colors, and then copies the document using two colors. Selecting [Dual Color] allows you to set the following:

- Source Color

Displays the [Source Color] screen on which you can select one or more colors from your document to define them as source colors.

Refer to "[Source Color] Screen" (P.82).

- Target Area Color

Displays the [Target Area Color] screen on which you can select the target color to be used in place of the selected source colors.

Refer to "[Target Area Color] Screen" (P.83).

- Non-target Area Color

Displays the [Non-target Area Color] screen on which you can select the color to be used in place of the colors other than the selected source colors.

Refer to "[Non-target Area Color] Screen" (P.84).

**■Single Color**

Copies in one specified color regardless of the color of the document.

Selecting this option displays [Color] on the screen. Select a color on the [Output Color - Color] screen which is displayed after selecting [Color].

Refer to "[Output Color - Color] Screen" (P.84).

**[Source Color] Screen**

This screen allows you to select one or more colors from your document to define them as source colors.

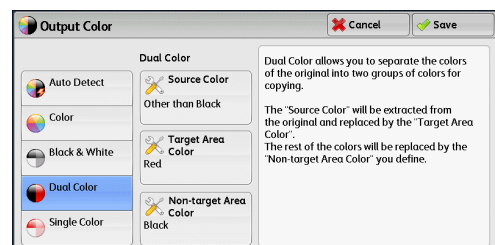
**1** Select [Dual Color].

- 2 Select [Source Color].

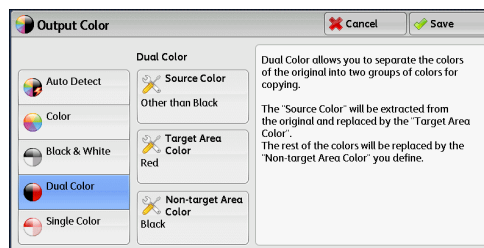

- 3 Select [Other than Black] or [Color].

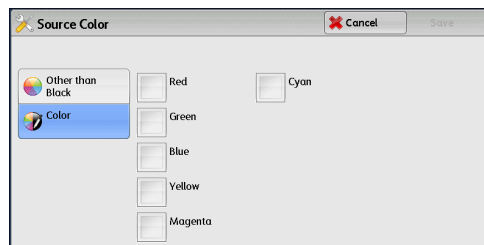

#### ■Other than Black

The colors other than black will be the source colors.

#### ■Color

Allows you to select one or more source colors from six preset options.

### [Target Area Color] Screen

This screen allows you to select the target color to be used in place of the source colors specified in [Source Color]. You can select one color from seven preset and six custom options.

For information on how to set custom colors, refer to "5 Tools" > "Copy Service Settings" > "Custom Colors" in the Administrator Guide.

- 1 Select [Dual Color].

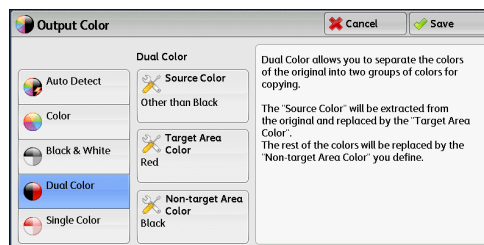

- 2 Select [Target Area Color].

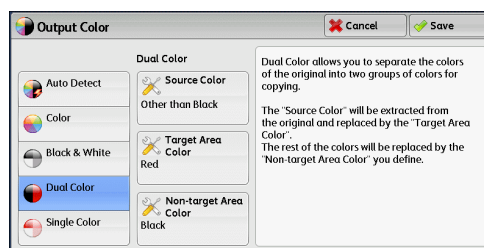

- 3 Select any color.

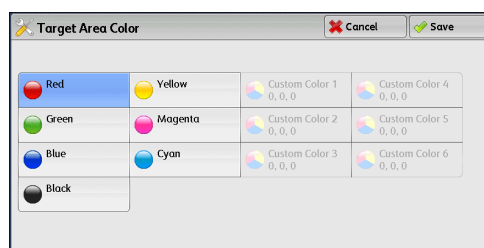

### [Non-target Area Color] Screen

This screen allows you to select the color to be used in place of the colors other than the selected source colors. You can select one color from seven preset and six custom options.

For information on how to set custom colors, refer to "5 Tools" > "Copy Service Settings" > "Custom Colors" in the Administrator Guide.

- 1 Select [Dual Color].

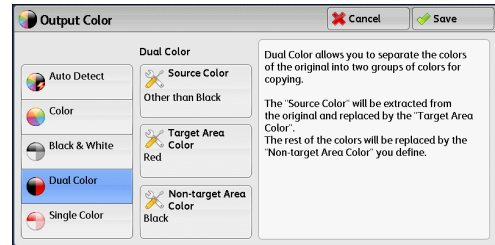

- 2 Select [Non-target Area Color].

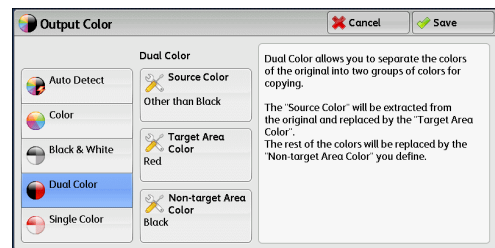

- 3 Select any color.

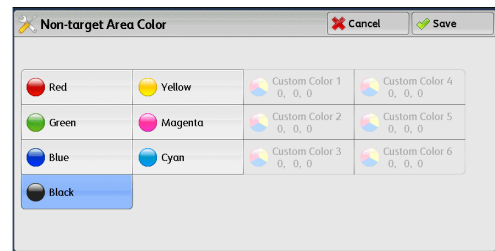

### [Output Color - Color] Screen

This screen allows you to specify the color to be used for single-color copying regardless of the colors in the original document.

You can select one color from six preset and six custom options for [Single Color].

For information on how to set custom colors, refer to "5 Tools" > "Copy Service Settings" > "Custom Colors" in the Administrator Guide.

- 1 Select [Single Color].

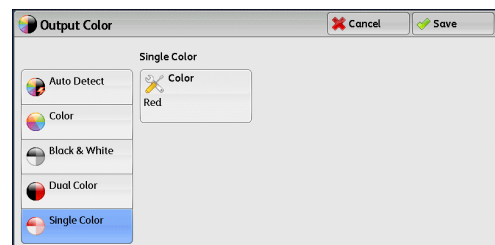



- 2 Select [Color].

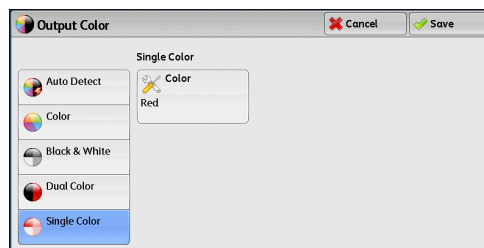

- 3 Select any color.

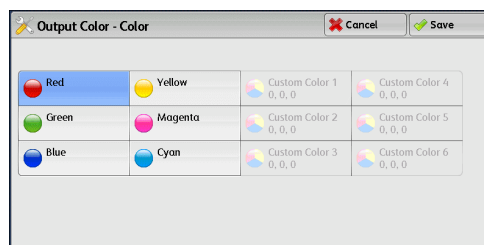

## 2 Sided Copying (Making 2 Sided Copies)

This feature is the same as [2 Sided Copying] on the [Image Quality] screen. For more information, refer to "2 Sided Copying (Making 2 Sided Copies)" (P.93).

## Copy Output (Specifying Finishing Options)

This feature is the same as [Copy Output] on the [Output Format] screen. For more information, refer to "Copy Output (Specifying Finishing Options)" (P.117).

## Pages per Side (Copying Multiple Pages onto One Sheet)

This feature is the same as [Pages per Side] on the [Output Format] screen. For more information, refer to "Pages per Side (Copying Multiple Pages onto One Sheet)" (P.111).

## Lighten/Darken (Adjusting the Copy Density)

This feature allows you to select a copy-density level from seven levels. The copy becomes darker when you move [▼] to the left, and lighter when you move it to the right.

**Note** • [Lighten/Darken] on the [Copy], [Image Quality] and [Simple Copy] screens is the same.

- 1 Use [◀] and [▶] to select from seven density levels.

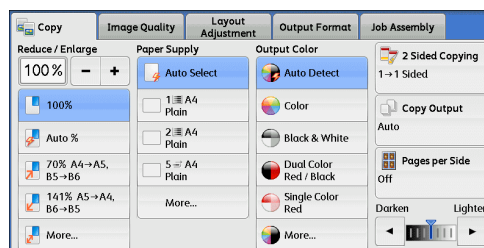

# Image Quality

The section describes the features you can select on the [Image Quality] screen. The following shows the reference section for each feature.

- Original Type (Selecting the Document Type).....86
- Image Options (Adjusting Copy Density/Sharpness/Saturation of Images).....87
- Image Enhancement (Erasing the Background Color of Documents/Adjusting Contrast) .....88
- Color Effects (Selecting an Image Quality).....89
- Color Balance (Adjusting Color Balance) .....90
- Color Shift (Adjusting the Color Tone).....92

**1** Select [Copy] on the [Services Home] screen.

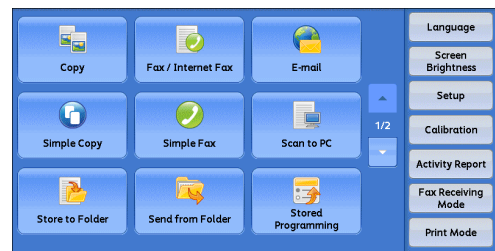

**2** Select a feature on the [Image Quality] screen.

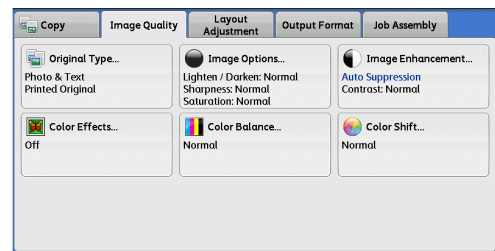

**Note** • If the color reproduction is unsatisfactory, perform calibration. For information on the calibration, refer to "3 Maintenance" > "Executing Calibration" in the Administrator Guide.

## Original Type (Selecting the Document Type)

This feature allows you to select the type of documents, such as text and photos. By selecting a document type, you can make copies at optimum image quality.

**1** Select [Original Type].

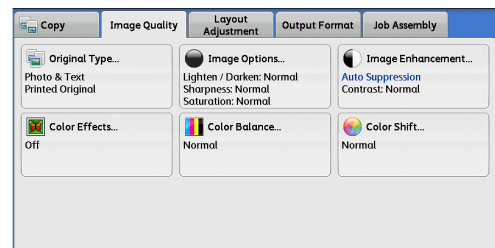

**2** Select any option.

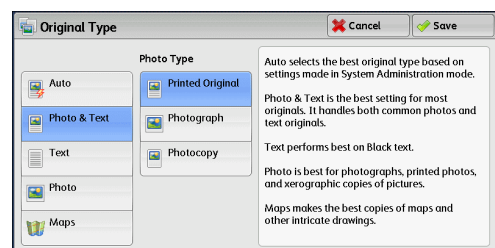

**■Auto**

Automatically sets the document type based on the setting made in the System Administration mode and the setting made in [Output Color] on the [Copy] screen.

**■Photo & Text**

Select this option when the document contains both text and photos. The machine automatically distinguishes the text and photo areas of the document and sets the appropriate image quality for each area. To process photo areas, select the photo type from [Printed Original], [Photograph], and [Photocopied Original].

- Printed Original  
Select this option when the document contains printed photos, such as a brochure.
- Photograph  
Select this option when the document contains pasted photos. This option prevents the copy from being reproduced bluish.
- Photocopied Original  
Select this option when the document is a copy or print made with a color copier such as this machine. This option prevents the copy from being reproduced faintly.

**■Text**

Select this option to copy text areas of the document sharply. This option is suitable for graphs and illustrations.

- Normal Text  
Select this option for printed documents, or for documents written with ink.
- Light Text  
Select this option for text that requires enhancement, such as handwritten pencil text.
- Text on See-Through Paper  
Select this option to reduce blurs of tracing-paper documents or to suppress background shadows of lightweight documents.

[See-Through Paper] may not be displayed depending on the setting in the System Administration mode. For information on how to display [See-Through Paper], refer to "5 Tools" > "Copy Service Settings" > "Copy Control" > "Original Type - See-Through Paper" in the Administrator Guide.

**■Photo**

Select this option to make copies of photos. Select the photo type from the same options as [Photo & Text]: [Printed Original], [Photograph], and [Photocopied Original].

**■Map**

Select this option to make copies of documents that have text placed on color backgrounds, such as maps.

## Image Options (Adjusting Copy Density/Sharpness/Saturation of Images)

This feature allows you to adjust the copy density, sharpness, and saturation levels.

- Note**
- [Lighten/Darken] under [Image Options] is the same as [Lighten/Darken] on the [Copy] screen.
  - If [Lighten/Darken], [Sharpness], or [Saturation] is set concurrently with [Color Effects], the setting made in [Color Effects] will be cleared.

## 1 Select [Image Options].

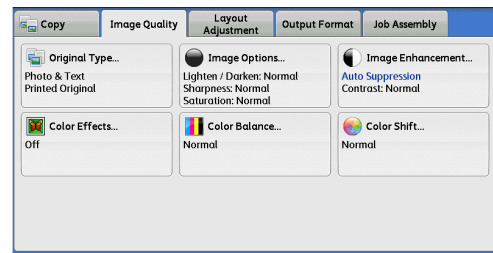

## 2 Adjust options.

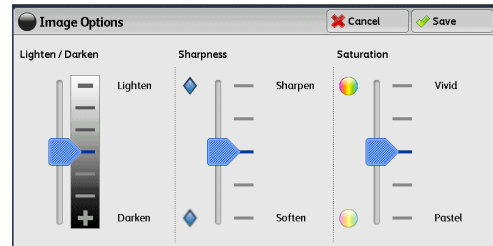

### ■ Lighten/Darken

Allows you to select from seven copy density levels between [Lighten] and [Darken].

Selecting an upper cell on the bar makes the copy density lighter, and selecting a lower cell makes darker.

### ■ Sharpness

Allows you to select from five sharpness levels between [Sharpen] and [Soften].

Selecting an upper cell on the bar makes the contours of images sharper, and selecting a lower cell makes softer.

### ■ Saturation

Allows you to select from five saturation levels between [Vivid] and [Pastel].

Selecting an upper cell on the bar makes colors brighter, and selecting a lower cell makes less bright.

## Image Enhancement (Erasing the Background Color of Documents/ Adjusting Contrast)

This feature allows you to suppress the background color of documents, such as newspaper and colored paper. You can also adjust the contrast.

- Note**
- [Image Enhancement] is not available when [Original Type] is set to [Photo].
  - If [Suppress Background] or [Contrast] is set concurrently with [Color Effects], the setting made in [Color Effects] will be cleared.

## 1 Select [Image Enhancement].

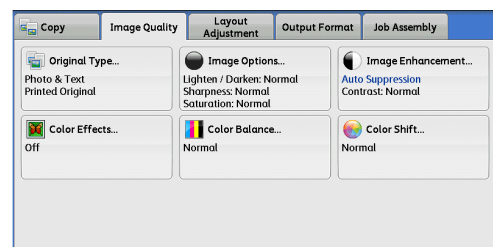

## 2 Set [Suppress Background] and [Contrast].

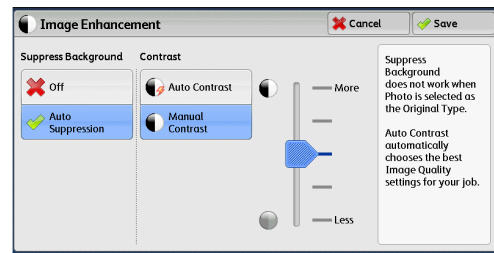

### ■ Suppress Background

- Off

Scans document backgrounds with no filtering.

- Auto Suppression

When [Output Color] is set to [Black & White], the background of a document printed on colored paper, such as newspaper, will be suppressed.

When [Output Color] is set to [Color], [Dual Color], or [Single Color], the background of a document printed on white-color paper will be suppressed.

- Note**
- When [Output Color] is set to [Color], you can change the level of background suppression. For more information, refer to "5 Tools" > "Copy Service Settings" > "Copy Control" > "Background Suppression (Photo & Text)" and "Background Suppression Level (Text)" in the Administrator Guide.

### ■ Contrast

- Auto Contrast

Automatically adjusts the brightness and hue of the original document to sharpen the image.

- Note**
- [Auto Contrast] is not available when you use the document feeder.

- Manual Contrast

Allows you to select from the five levels between [More] and [Less].

Selecting an upper cell on the bar makes the difference between light and dark areas greater; light areas become lighter and dark areas darker. In contrast, selecting a lower cell on the bar makes the difference between light and dark areas smaller.

## Color Effects (Selecting an Image Quality)

If you set this feature, the [Image Enhancement], [Image Options], [Color Shift], and [Color Balance] settings are automatically adjusted and copies are made at the specified quality.

- Important**
- When the Color Effects feature is used, [Auto Contrast] is not available.

- Note**
- If other image-quality settings are made after you set [Color Effects], the setting made in [Color Effects] will be cleared.

## 1 Select [Color Effects].

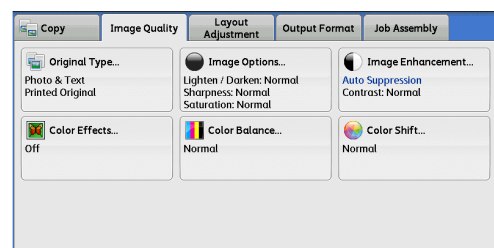

## 2 Select any option.

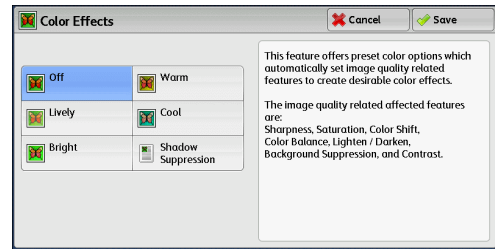

### ■ Off

Copies with the [Image Enhancement], [Image Options], [Color Shift], and [Color Balance] settings at their defaults.

### ■ Lively

Reproduces fresher, livelier images with increased color saturation.

### ■ Bright

Reproduces brighter images with enhanced contrast. This option is suitable for documents that are intended to attract people's attention, such as posters.

### ■ Warm

Reproduces brighter, warmer, more reddish images. This option is suitable when skin tones are to be reproduced more pinkish or when subdued images are to be reproduced more warmly.

### ■ Cool

Reproduces clearer blue colors. This option is suitable for water and sky images, and is also suitable when smoky blue colors are to be reproduced more clearly.

### ■ Shadow Suppression

Suppresses the colors on the reverse side of the original document from being reproduced in the copy.

## Color Balance (Adjusting Color Balance)

This feature allows you to adjust the color balance of the four CMYK toner colors (cyan, magenta, yellow and black). You can select from seven levels for each density level: Highlights, Midtones, and Shadows.

The Color Balance feature finely adjusts the density level for each toner color to fine-tune the color balance, such as a reddish or bluish tint, while the Lighten/Darken feature adjusts the overall density level of four colors.

**Note** • If [Color Balance] is set concurrently with [Color Effects], the setting made in [Color Effects] will be cleared.

## 1 Select [Color Balance].

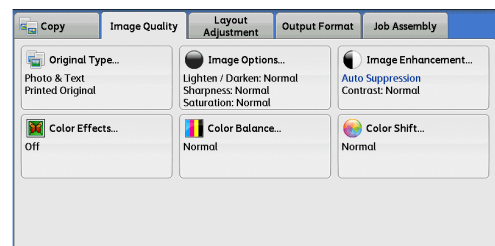

## 2 Select any option.

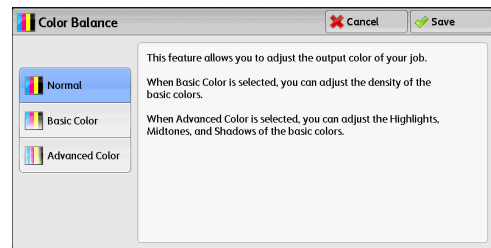

### ■ Normal

Always copies a document with the density balance set to "0" for four toner colors: magenta, cyan, black, and yellow.

### ■ Basic Color

Allows you to adjust the density level for each toner color: yellow, magenta, cyan, black. .

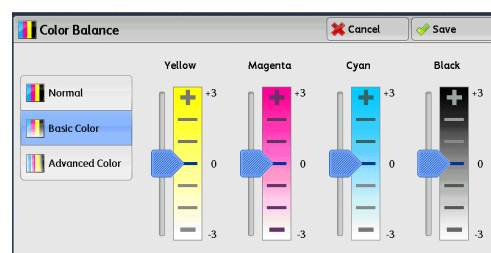

### ■ Advanced Color

Allows you to adjust the density level for each toner color (yellow, magenta, cyan, black) which is divided to [Highlights], [Midtones], and [Shadows].

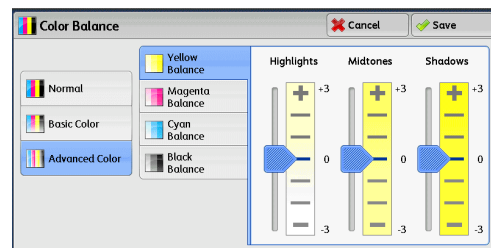

### ■ Highlights

Allows you to adjust the color strength of low-density areas.

Example:

If low-density yellow is printed darker, adjust the color strength in the minus (-) direction under [Yellow Balance] > [Highlights].

### ■ Midtones

Allows you to adjust the color strength of medium-density areas.

Example:

If medium-density yellow is printed lighter, adjust the color strength in the plus (+) direction under [Yellow Balance] > [Midtones].

### ■ Shadows

Allows you to adjust the color strength of high-density areas.

Example:

If high-density yellow is printed lighter, adjust the color strength in the plus (+) direction under [Yellow Balance] > [Shadows].

## Color Shift (Adjusting the Color Tone)

This feature allows you to adjust the tone of the colors to be reproduced in copies, by a maximum of two levels in two directions.

On the screen, the [Original Color] slider represents the color tone of the original document, and the [Copy Color] slider represents the color tone of output copies. Selecting a button on the screen moves the [Original Color] slider to adjust the tone of the colors.

When the [Original Color] slider is moved to the left, the Y (yellow) cell on the [Original Color] slider becomes closer to the R (red) cell on the [Copy Color] slider, and thus a yellow fruit appears more reddish and riper-looking. At the same time, the tone of all the other colors changes. The red color appears more magentish, and the green color appears more yellowish.

Conversely, when the [Original Color] slider is moved to the right, the Y (yellow) cell on the [Original Color] slider becomes closer to the G (green) cell on the [Copy Color] slider, and thus a yellow fruit appears more greenish. At the same time, the tone of all the other colors changes. The magenta color appears more reddish, and the red color appears more yellowish.

- Note**
- Ensure that [Output Color] is set to [Color] on the [Copy] screen. [Color Shift] is not available when [Output Color] is set to [Black & White].
  - If [Color Shift] is set concurrently with [Color Effects], the setting made in [Color Effects] will be cleared.

**1** Select [Color Shift].

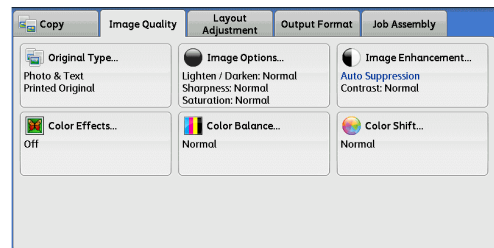

**2** Select a button to adjust the color tone.

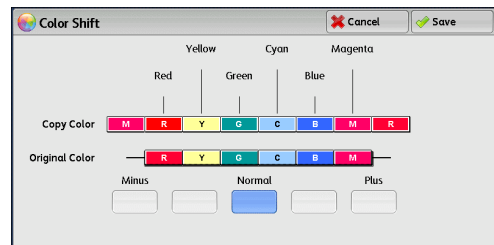



# Layout Adjustment

This section describes the features you can select on the [Layout Adjustment] screen. The following shows the reference section for each feature.

2 Sided Copying (Making 2 Sided Copies).....	93
Book Copying (Copying Facing Pages onto Separate Sheets) .....	95
2 Sided Book Copying (Making 2 Sided Copies of Facing Pages) .....	96
Original Size (Specifying the Scan Size for the Document).....	98
Mixed Size Originals (Scanning Different Size Documents Simultaneously) .....	99
Edge Erase (Erasing Edges and Margin Shadows of the Document) .....	100
Image Shift (Adjusting the Image Position).....	101
Invert Image (Making Reversed Copies of Images) .....	104
Original Orientation (Specifying the Orientation of Loaded Documents).....	104
Image Rotation (Changing the Orientation of Images).....	105

- 1 Select [Copy] on the [Services Home] screen.

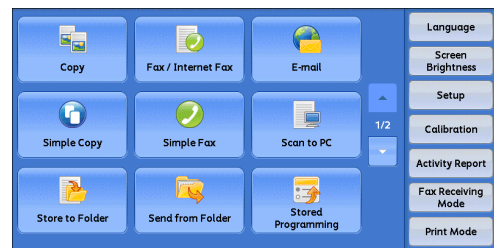

- 2 Select a feature on the [Layout Adjustment] screen.

**Note** • Select [▲] to return to the previous screen or [▼] to move to the next screen.

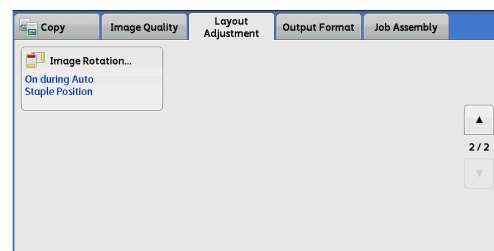
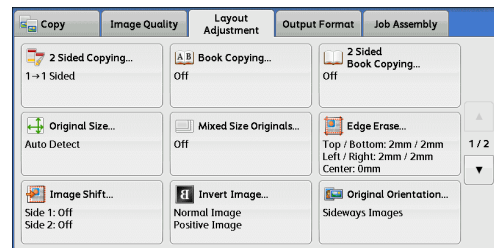

## 2 Sided Copying (Making 2 Sided Copies)

This feature allows you to make copies of 1-sided and 2-sided documents on one side or both sides of paper.

- 1 Select [2 Sided Copying].

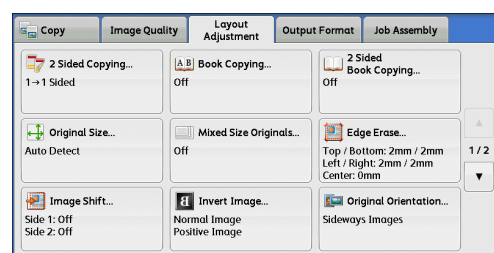

## 2 Select any option.



### ■ 1 → 1 Sided

Makes a copy of a 1-sided document on one side of paper.

### ■ 1 → 2 Sided

Makes a copy of a 1-sided document on both sides of paper.

Select this option when you copy 1-sided documents on both sides of paper.

### ■ 2 → 2 Sided

Makes a copy of a 2-sided document on both sides of paper.

### ■ 2 → 1 Sided

Makes a copy of a 2-sided document on one side of paper.

### ■ Originals

This option is displayed when you select [2 → 2 Sided] or [2 → 1 Sided].

- Head to Head

Select this option when the front and back sides of the document are in the same orientation.

- Head to Toe

Select this option when the front and back sides of the document are in opposite orientations.

### ■ Copies

This option is displayed when you select [1 → 2 Sided] or [2 → 2 Sided].

- Head to Head

Select this option when you want the orientation of the front and back sides of the copy to be the same as that of the document.

- Head to Toe

Select this option when you want the orientation of the front and back sides of the copy to be the opposite of that of the document.

### ■ Original Orientation

Allows you to specify the orientation of the document so that the machine can identify the top of the document.

**Note** • If the [Original Orientation] setting differs from the actual document orientation, the machine may not detect the top of the document correctly.

- Upright Images

Select this option when placing the top edge of the document against the top side of the document glass or document feeder.

- Sideways Images

Select this option when placing the top edge of the document against the left side of the document glass or document feeder.

## Book Copying (Copying Facing Pages onto Separate Sheets)

This feature allows you to copy facing pages of a document on separate sheets of paper in page order.

This is useful when you need to make separate copies of facing pages of a bound document such as a booklet.

- Note**
- You cannot use the document feeder with this feature.
  - A non-standard size document or undetectable-size document may not be separated into two accurately.

1 Select [Book Copying].

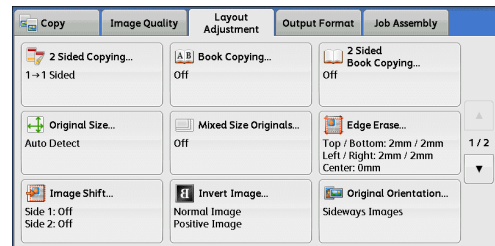

2 Select any option.

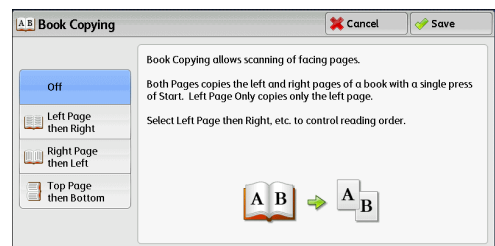

■ **Off**

Does not copy as a bound document.

■ **Left Page then Right**

Copies the left page and then the right page of facing pages.

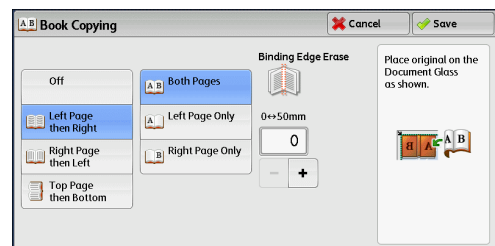

■ **Right Page then Left**

Copies the right page and then the left page of facing pages.

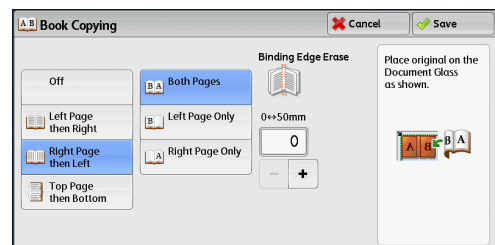

**Top Page then Bottom**

Copies the top page and then the bottom page of facing pages.

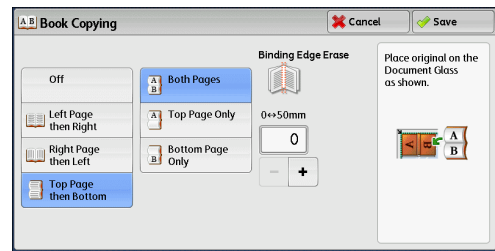

**Both Pages**

Copies both pages in page order.

**Left Page Only**

Copies the left page only. You can select this option when [Left Page then Right] or [Right Page then Left] is selected.

**Right Page Only**

Copies the right page only. You can select this option when [Left Page then Right] or [Right Page then Left] is selected.

**Top Page Only**

Copies the top page only. You can select this option when [Top Page then Bottom] is selected.

**Bottom Page Only**

Copies the bottom page only. You can select this option when [Top Page then Bottom] is selected.

**Binding Edge Erase**

Erases the shadow from the center section of the document. You can set the binding erase width in the range from 0 to 50 mm in 1 mm increments.

**2 Sided Book Copying (Making 2 Sided Copies of Facing Pages)**

This feature allows you to assign pages when making copies of facing pages in a bound document such as a booklet so that pages face each other in the same way as the document. You can also specify the starting and ending pages from the left and right of facing pages.

- Note**
- A non-standard size document or undetectable-size document will not be separated into two accurately.
  - Use the document glass to load a document.

**1** Select [2 Sided Book Copying].

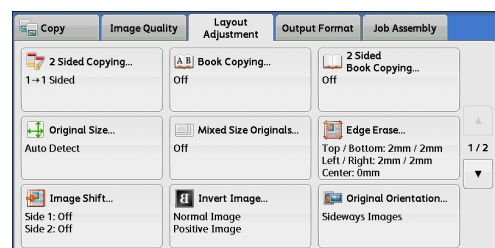

## 2 Select any option.

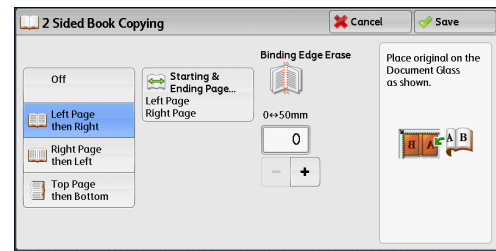

### ■Off

Disables this feature.

### ■Left Page then Right

Scans the left page and then the right page of facing pages, to make 2-sided copies.

### ■Right Page then Left

Scans the right page and then the left page of facing pages, to make 2-sided copies.

### ■Top Page then Bottom

Scans the top page and then the bottom page of facing pages, to make 2-sided copies.

### ■Starting & Ending Page

Displays the [Starting & Ending Page] screen.

Refer to "[Starting & Ending Page] Screen" (P.97).

### ■Binding Edge Erase

Erases the shadow from the center section of the document. You can set the binding erase width in the range from 0 to 50 mm in 1 mm increments.

## [Starting & Ending Page] Screen

This screen allows you to set the starting and ending pages to be copied.

## 1 Set [Starting Page] and [Ending Page].

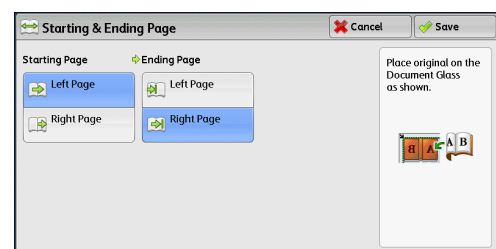

### ■Starting Page

- [Left Page] / [Right Page]

You can select these options when [Left Page then Right] or [Right Page then Left] is selected.

- [Top Page] / [Bottom Page]

You can select these options when [Top Page then Bottom] is selected.

### ■Ending Page

- [Left Page] / [Right Page]

You can select these options when [Left Page then Right] or [Right Page then Left] is selected.

- [Top Page] / [Bottom Page]

You can select these options when [Top Page then Bottom] is selected.

## Original Size (Specifying the Scan Size for the Document)

This feature allows you to specify the scan size for a document.

Use this feature when a document is a non-standard size, or when you want to copy a document at a size different from the original size. You can also add margins, or delete unnecessary margins using this feature.

- 1 Select [Original Size].

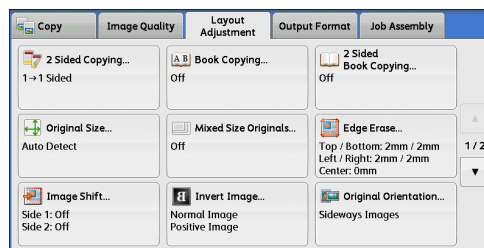

- 2 Select the size of the document. If you select a non-standard size, specify values for the X and Y directions.

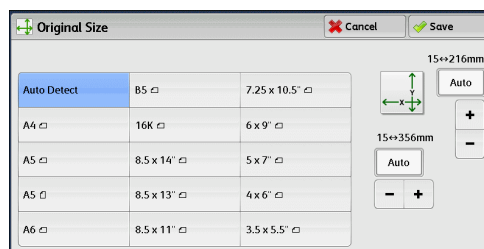

### ■Auto Detect

Detects the document size automatically. The following table shows the document sizes that can be detected automatically.

	Document Feeder	Document Glass
<b>Auto-detectable Document Sizes</b>	B5, A5, A5□, A4, 8.5 x 11", 8.5 x 14"	B5, B6, B6□, A6, A5, A5□, A4, 16K

**Note** • If the document size cannot be detected automatically, a screen to enter the document size appears.

The document sizes that can be automatically detected depend on [Paper Size Settings] in the System Administration mode. For more information, refer to "5 Tools" > "Common Service Settings" > "Other Settings" > "Paper Size Settings" in the Administrator Guide.

### ■Standard Size

Select a document size from preset options.

You can change the sizes displayed on the screen. For information on the settings, refer to "5 Tools" > "Copy Service Settings" > "Original Size Defaults" in the Administrator Guide.

### ■Variable Size

Enter the desired scan size when scanning a non-standard size document or when making copies at a size different from the original document size. You can specify a value in the range from 15 to 356 mm for the width (X), and a value in the range from 15 to 216 mm for the length (Y), in 1 mm increments. To help you specify values, use the scales attached on the upper and left edges of the document glass.

- Important** • When the document is loaded in the document feeder, the base point in the Y (length) direction is the center of the edge. If you specify 100 mm, the scan length will be from 50 mm above to 50 mm below the center of the document.

## Mixed Size Originals (Scanning Different Size Documents Simultaneously)

You can scan documents of various sizes simultaneously and make copies on each size or a single size of paper. To use this feature, load the documents in the document feeder.

- Important** • When loading A5 documents together with A4 documents loaded in landscape orientation, load A5 documents in portrait orientation.
- If the top left corners of the documents are not aligned properly, the documents may not be scanned correctly.
  - The recommended document size combinations are A5 portrait and A4 landscape. If another combination of document sizes is used, the documents can be fed at an angle and may not be copied properly.

### 1 Select [Mixed Size Originals].

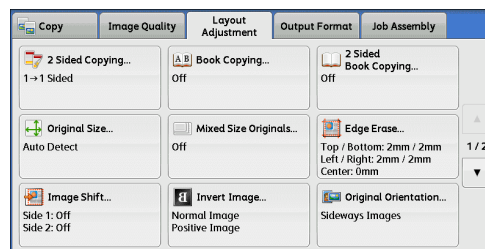

### 2 Select [On].

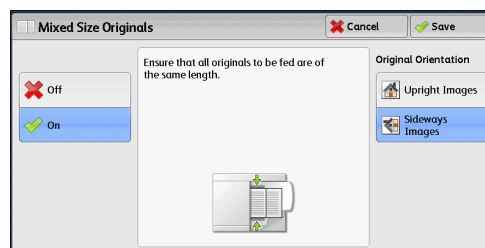

#### ■ Off

Select this option when copying documents of the same size.

#### ■ On

When documents of different sizes are copied, the machine automatically detects the size of each document.

#### ■ Original Orientation

Allows you to specify the orientation of the document so that the machine can identify the top of the document.

- Note**
- The [Original Orientation] setting is based on the orientation of the first page of a document. Load the second and subsequent pages of the document based on this setting.
  - If the [Original Orientation] setting differs from the actual document orientation, the machine may not detect the top of the document correctly.

- Upright Images

Select this option when placing the top edge of the document against the top side of the document glass or document feeder.

- Sideways Images

Select this option when placing the top edge of the document against the left side of the document glass or document feeder.

## Edge Erase (Erasing Edges and Margin Shadows of the Document)

When you copy a document with the document cover open or when you copy a book, the edges and center margin of the document may be printed as black shadows. The Edge Erase feature allows you to erase such shadows.

- Note**
- For 2-sided originals, the same edge erase amounts are set for the front and back sides.
  - If you set [Reduce/Enlarge], the edge erase amounts will be reduced or enlarged in proportion to the ratio you specified.
  - The binding shift specified in [Booklet Creation] will not affect the edge erase amounts.
  - If original is placed on the document glass and [1 g 2 Sided] is selected when using 2 Sided Copying feature, symmetrical edge erase amounts on both sides are not applied to output even if [Individual Edges] is specified and [Mirror Side 1] is selected as [2 Sided Original - Side 2] option. To apply symmetrical edge erase amounts on both sides, select [2 g 2 Sided] for 2 Sided Copying operation.

Even when the edge erase amount is set to 0 mm, full page copying cannot be made. For information on the areas that can actually be printed, refer to "15 Appendix" > "Printable Area" in the Administrator Guide.

### 1 Select [Edge Erase].

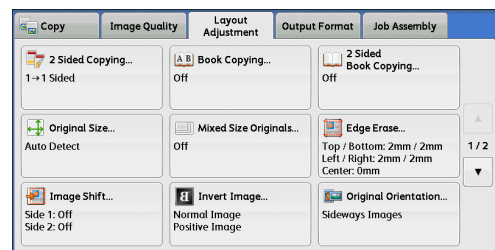

### 2 Select any option.

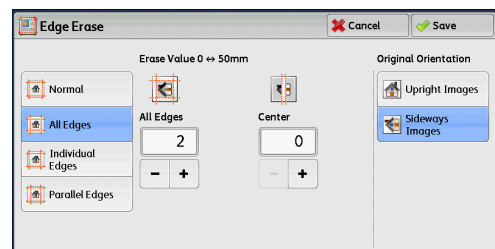

#### ■ Normal

The edge width to erase is set to 2 mm for the top and bottom, and left and right edges.

#### ■ All Edges

Erases the shadows of the four edges of a document, as well as the shadow in the center of the document if it is a bound document or a booklet. You can specify values for [All Edges] and [Center] individually.

#### ■ Individual Edges

Erases the shadows of the top, bottom, left, and right edges of a document, as well as the shadow in the center of the document if it is a bound document or a booklet. You can specify values for [Top], [Bottom], [Left], [Right], and [Center] individually.

#### ■ Parallel Edges

Erases the shadows of the top and bottom edges, and left and right edges of a document, as well as the shadow in the center of the document if it is a bound



document or a booklet. You can specify values for [Top & Bottom], [Left & Right], and [Center] individually.

### ■ Erase Value

Allows you to specify values to erase the edges of a document.

- All Edges

Erases the shadows of the four edges of the document according to the orientation of the loaded document. You can specify the edge width you want to erase in the range from 0 to 50 mm in 1 mm increments.

- Top & Bottom (Top/Bottom)

Erases the shadows of top and bottom edges of the document according to the orientation of the loaded document. You can specify the edge width you want to erase in the range from 0 to 50 mm in 1 mm increments.

- Left & Right (Left/Right)

Erases the shadows of left and right edges of the document according to the orientation of the loaded document. You can specify the edge width you want to erase in the range from 0 to 50 mm in 1 mm increments.

- Center

Erases the shadow in the center of facing pages of a bound document or a booklet. You can set the binding erase width in the range from 0 to 50 mm in 1mm increments.

### ■ Original Orientation

Allows you to specify the orientation of the document so that the machine can identify the top of the document.

**Note** • If the [Original Orientation] setting differs from the actual document orientation, the machine may not detect the top of the document correctly.

- Upright Images

Select this option when placing the top edge of the document against the top side of the document glass or document feeder.

- Sideways Images

Select this option when placing the top edge of the document against the left side of the document glass or document feeder.

### ■ 2 Sided Original - Side 2

You can select this option when [Individual Edges] is selected. Set whether the same value is set to the edge erase amount of Side 1 and Side 2.

- Same as Side 1

The same value is set to the edge erase amount of Side 1 and Side 2.

- Mirror Side 1

The edge erase amounts of Side 1 and Side 2 are set symmetrically.

## Image Shift (Adjusting the Image Position)

This feature allows you to shift the position of document images so that the images are placed on the left, right, top, bottom, or center of paper. You can also adjust the amounts of the left, right, top, and bottom margins. If you make 2-sided copies, you can adjust the image positions for Side 1 and Side 2 individually.

- Note** • The image shift amount is set in accordance with the paper, and does not affect the setting made in [Reduce/Enlarge].

## 1 Select [Image Shift].

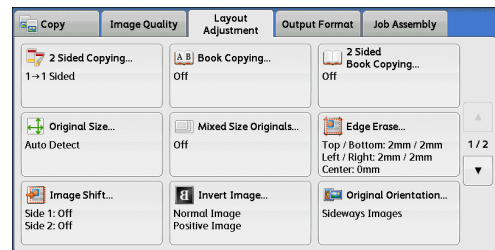

## 2 Select any option.

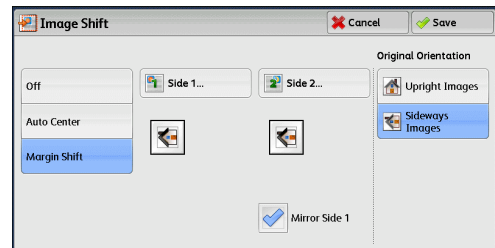

### ■ Off

Does not shift the position of document images.

### ■ Auto Center

Shifts document images so that they are placed in the center of paper.

### ■ Margin Shift

Allows you to specify the amounts of the top and bottom, and left and right margins in the range from 0 to 50 mm in 1 mm increments.

#### • Side 1

Displays the [Image Shift - Side 1] screen.

Refer to "[Image Shift - Side 1] Screen" (P.103).

#### • Side 2

Displays the [Image Shift - Side 2] screen.

Refer to "[Image Shift - Side 2] Screen" (P.103).

#### • Mirror Side 1

Select this check box when you want the positioning of Side 2 to match the positioning of Side 1.

### ■ Original Orientation

Allows you to specify the orientation of the document so that the machine can identify the top of the document.

- Note** • If the [Original Orientation] setting differs from the actual document orientation, the machine may not detect the top of the document correctly.

#### • Upright Images

Select this option when placing the top edge of the document against the top side of the document glass or document feeder.

#### • Sideways Images

Select this option when placing the top edge of the document against the left side of the document glass or document feeder.

**[Image Shift - Side 1] Screen**

This screen allows you to set the image shift for Side 1.

- 1 Select any option.

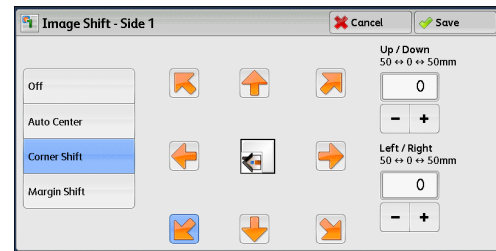
**■Off**

Does not shift the position of document image.

**■Auto Center**

Shifts document images so that they are placed in the center of paper.

Specify the amounts of the top and bottom, and left and right margins in the range from 0 to 50 mm in 1 mm increments.

**■Corner Shift**

Shifts document images so that they are placed at an edge or corner of paper. You can select from 8 shift directions.

Specify the amounts of the top and bottom, and left and right margins in the range from 0 to 50 mm in 1 mm increments.

**■Margin Shift**

Allows you to specify the amounts of the top and bottom, and left and right margins in the range from 0 to 50 mm in 1 mm increments.

**[Image Shift - Side 2] Screen**

This screen allows you to set the image shift for Side 2.

- 1 Select any option.

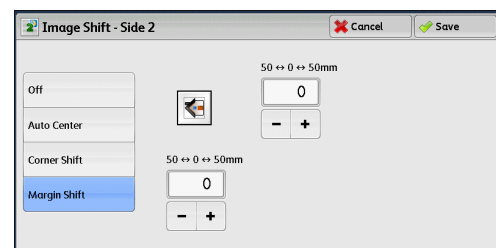
**■Off**

Does not shift the position of document image.

**■Auto Center**

Shifts document images so that they are placed in the center of paper.

Specify the amounts of the top and bottom, and left and right margins in the range from 0 to 50 mm in 1 mm increments.

**■Corner Shift**

Shifts document images so that they are placed at an edge or corner of paper. You can select from 8 shift directions.

Specify the amounts of the top and bottom, and left and right margins in the range from 0 to 50 mm in 1 mm increments.

### ■Margin Shift

Allows you to specify the amounts of the top and bottom, and left and right margins in the range from 0 to 50 mm in 1 mm increments.

## Invert Image (Making Reversed Copies of Images)

This feature allows you to reverse the left and right sides of the document image or to create a negative image of the document when making copies.

- Note**
- When [Output Color] is set to [Black & White] or [Single Color], the black color on the document is inverted to white, and the white color to black.
  - When [Output Color] is set to [Color], the colors are inverted to their complementary colors.
  - When [Negative Image] and [Edge Erase] are set simultaneously, the edge erase area turns to white.

1 Select [Invert Image].

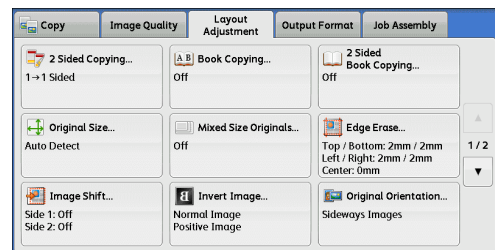

2 Select any option.

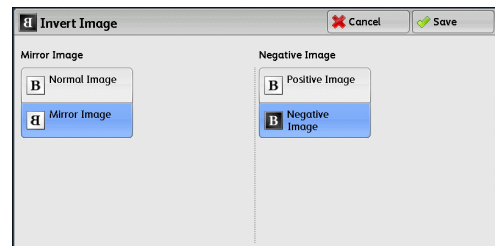

### ■Mirror Image

Reverses the left and right sides of the document image.

### ■Negative Image

Creates a negative image of the document.

## Original Orientation (Specifying the Orientation of Loaded Documents)

This feature allows you to specify the orientation of a document so that the machine can identify the top of the document.

- Note**
- If the [Original Orientation] setting differs from the actual document orientation, the machine may not detect the top of the document correctly.

1 Select [Original Orientation].

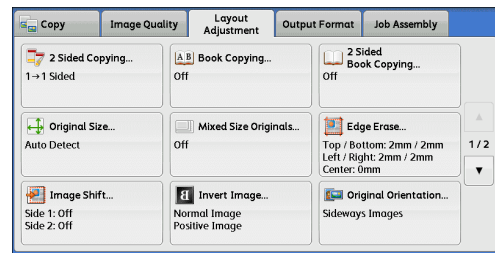

2 Select [Upright Images] or [Sideways Images] according to the orientation of the document loaded.

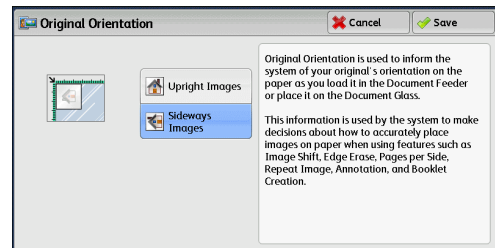

### ■ Upright Images

Select this option when placing the top edge of the document against the top side of the document glass or document feeder.

### ■ Sideways Images

Select this option when placing the top edge of the document against the left side of the document glass or document feeder.

## Image Rotation (Changing the Orientation of Images)

If the orientation of the paper currently loaded in the tray differs from that of the document loaded, the machine automatically rotates the document image so that the orientation of the image matches that of the paper. You can also select a reference position for image rotation if documents are of mixed orientations.

This feature is available only when you make copies on A5 paper.

1 Select [Image Rotation].

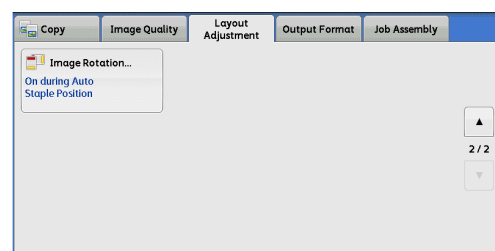

2 Select any option.

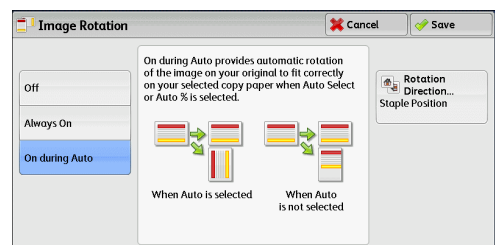

### ■ Off

Copies documents as they are, even if the orientation of the images does not match that of the paper.

### ■Always On

Automatically rotates document images so that the orientation of the images matches that of the paper.

### ■On during Auto

Automatically rotates document images so that the orientation of the images matches that of the paper only when [Auto %] is selected in [Reduce/Enlarge], or when [Auto Select] is selected in [Paper Supply].

### ■Rotation Direction

Displays the [Image Rotation - Rotation Direction] screen.

Refer to "[Image Rotation - Rotation Direction] Screen" (P.106).

## [Image Rotation - Rotation Direction] Screen

This screen allows you to set the reference position for rotation.

- 1 Select any option.

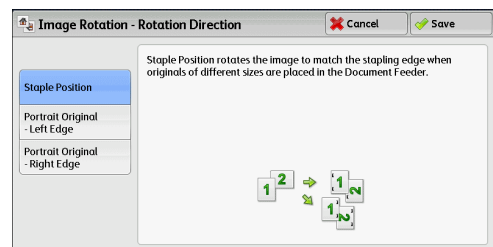

### ■Staple Position

This option is displayed when the finisher is installed. If documents are of mixed orientations, the images will be rotated to match the stapling edge specified in the settings of the Staple feature.

### ■Portrait Original - Left Edge

If documents are of mixed orientations, the images will be rotated so that the top edge of landscape documents is aligned with the left edge of portrait documents.

### ■Portrait Original - Right Edge

If documents are of mixed orientations, the images will be rotated so that the top edge of landscape documents is aligned with the right edge of portrait documents.

# Output Format

This section describes the features you can select on the [Output Format] screen. The following shows the reference section for each feature.

2 Sided Copying (Making 2 Sided Copies).....	107
Booklet Creation (Creating a Booklet).....	108
Covers (Attaching Covers to Copies).....	110
Pages per Side (Copying Multiple Pages onto One Sheet) .....	111
Poster (Making Enlarged Copies Spread over Multiple Sheets).....	112
Repeat Image (Making Multiple Copies on One Sheet) .....	114
Preset Repeat Image (Making Multiple Copies on a Single Sheet).....	115
Transparency Options (Inserting Blank Sheets between Transparencies).....	116
Copy Output (Specifying Finishing Options) .....	117
ID Card Copy (Copying Both Sides of an ID Card) .....	119

- 1** Select [Copy] on the [Services Home] screen.

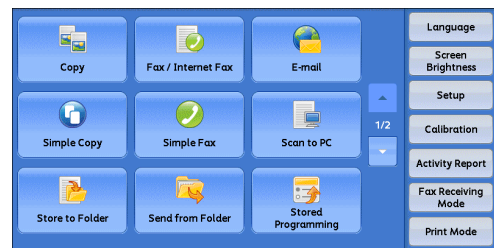

- 2** Select a feature on the [Output Format] screen.

**Note** • Select [▲] to return to the previous screen or [▼] to move to the next screen.

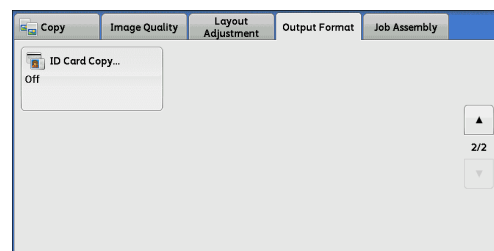
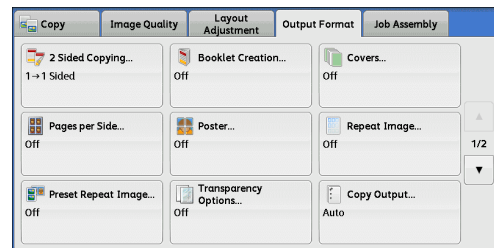

## 2 Sided Copying (Making 2 Sided Copies)

This feature is the same as [2 Sided Copying] on the [Layout Adjustment] screen. For more information, refer to "2 Sided Copying (Making 2 Sided Copies)" (P.93).

## Booklet Creation (Creating a Booklet)

This feature lays out pages so that booklets are formed when the output sheets are folded in half. You can also set the binding shift and attach a cover when making booklets.

- Note**
- The machine copies four pages of the document onto one sheet of paper. If the number of pages in the booklet is not a multiple of four, the remaining pages will be output as blank pages.
  - If [Auto Select] is selected in [Paper Supply], a tray specified in [Auto Paper Off] is automatically selected. Change the setting if necessary. For information on [Auto Paper Off], refer to "5 Tools" > "Copy Service Settings" > "Copy Control" in the Administrator Guide.

- 1 Specify the orientation of the document in [Original Orientation] on the [Layout Adjustment] screen.

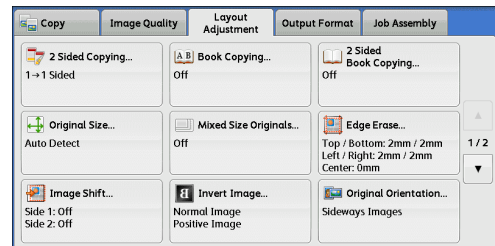

- 2 Select [Booklet Creation] on the [Output Format] screen.

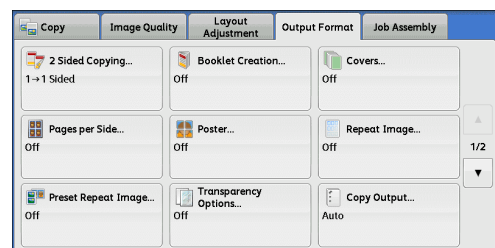

- 3 Select any option.

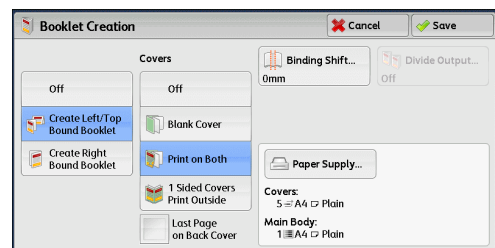

### ■Off

Disables this feature.

### ■Create Left/Top Bound Booklet

Copies are made to enable left binding or top binding.

### ■Create Right Bound Booklet

Copies are made to enable right binding.

### ■Covers

You can attach covers to a booklet.

- Off
  - No cover is attached.
- Blank Cover
  - A blank sheet of paper is attached as the cover.



- **Print on Both**  
The first and second pages of the document are copied on both sides of the cover.
- **1 Sided Covers Print Outside**  
The first and the last pages of the document is copied on the front side of the cover.
- **Last Page on Back Cover**  
Select this check box to copy the image of the last document page onto the last page of the copy sheets as a back cover. When you use [Divide Output] to divide a booklet into subsets, the image of the last document page will be copied onto the last page of the last subset.

**Note** • Depending on the number of pages in the original document, a blank page may be inserted before the last page of a booklet.

### ■ Binding Shift

Displays the [Booklet Creation - Binding Shift] screen.  
Refer to "[Booklet Creation - Binding Shift] Screen" (P.109).

### ■ Divide Output

Displays the [Booklet Creation - Divide Output] screen.  
Refer to "[Booklet Creation - Divide Output] Screen" (P.109).

### ■ Paper Supply

Displays the [Booklet Creation - Paper Supply] screen.

Select the tray to be used for body pages from [Main Body Tray], and the tray for cover pages from [Cover Tray]. Select the same size of paper for [Main Body Tray] and [Cover Tray], and also select the trays with paper loaded in landscape orientation (☐).

When [Tray 5] is selected, the [Tray 5] screen is displayed. For more information, refer to "[Tray 5] Screen" (P.79).

## [Booklet Creation - Binding Shift] Screen

This screen allows you to specify the binding shift value in the range from 0 to 50 mm in 1 mm increments.

- 1 Use [+] and [-] or the numeric keypad to specify a binding shift value.

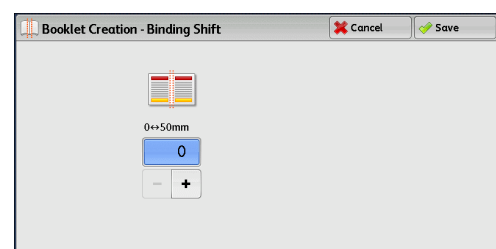

## [Booklet Creation - Divide Output] Screen

When you have a large number of originals, the originals are divided to create subsets to reduce the thickness of each booklet. The machine folds copies in half, and piles them up to form a booklet.

You can specify the number of sheets in the range from 1 to 50 in 1 sheet increments.

- 1 Select [On].

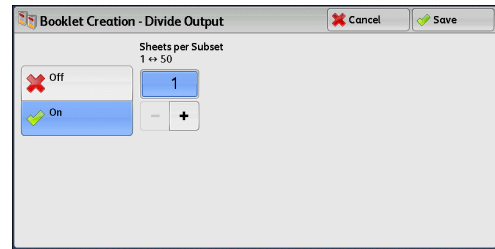

- 2 Specify the number of sheets using [+] and [-] or the numeric keypad.

## Covers (Attaching Covers to Copies)

This feature allows you to attach covers to copies.

You can use different types of paper (such as colored paper and heavyweight paper) as the front and back covers of copies.

**Important** • When you select this feature, if the number of pages scanned by the machine exceeds the maximum, the machine will not print the already-scanned data. In that case, follow the instructions of the message displayed on the screen to cancel the job. The maximum number of pages that the machine can scan is 999 pages per job.

- 1 Select [Covers].

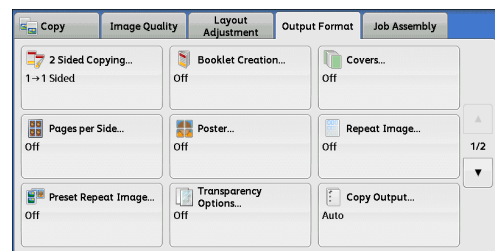

- 2 Select any option.

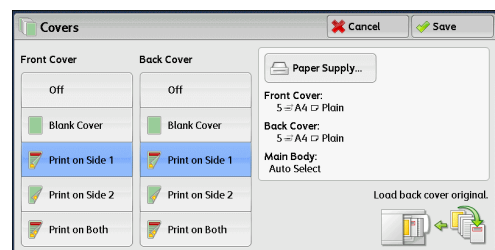

### ■Front Cover

Attaches a front cover to the copies.

- Off  
No front cover is attached.
- Blank Cover  
Blank sheets of paper are attached as front covers.
- Print on Side 1  
The first page of the document is copied on the front side of the front cover.
- Print on Side 2  
The first page of the document is copied on the back side of the front cover.
- Print on Both  
The first and second pages of the document are copied on the front and back sides of the front cover.

**■ Back Cover**

Attaches a back cover to the copies.

- Off  
No back cover is attached.
- Blank Cover  
Blank sheets of paper are attached as back covers.
- Print on Side 1  
The first page of the document is copied on the front side of the back cover.
- Print on Side 2  
The first page of the document is copied on the back side of the back cover.
- Print on Both  
The first and second pages of the document are copied on the front and back sides of the back cover.

**■ Paper Supply**

Displays the [Covers - Paper Supply] screen.

Select a tray to be used.

- Front Cover Tray  
Select the tray used for front covers.
- Back Cover Tray  
Select the tray used for back covers.
- Main Body Tray  
Select the tray used for the body pages of the document.

When you use the bypass tray, select [Tray 5] on the [Covers - Paper Supply] screen. When [Tray 5] is selected, the [Tray 5] screen is displayed. For more information, refer to "[Tray 5] Screen" (P.79).

**■ Front Cover Quantity**

This option is displayed when you select [Blank Covers] in [Front Cover]. Specify the number of blank sheets to be used as front covers.

**■ Back Cover Quantity**

This option is displayed when you select [Blank Covers] in [Back Cover]. Specify the number of blank sheets to be used as back covers.

## Pages per Side (Copying Multiple Pages onto One Sheet)

---

This feature allows you to copy two, four, or eight pages of a document together onto a single sheet of paper.

When you set [Pages per Side], [Auto %] is automatically selected in [Reduce/Enlarge]. The machine automatically sets the copy ratio and makes copies of the images so that they fit on the selected paper.

- Note**
- When you deselect [Auto %] in [Reduce/Enlarge] (when you select another copy ratio), image loss may occur depending on the image size of the document.
  - When [Image Shift] is set, the image shift amounts are applied to the whole document. For this reason, image loss may occur depending on the image size of the document.
  - When [Edge Erase] is set, the edge erase amounts are applied to each document page.

- Select a tray other than [Auto Select] in [Paper Supply] on the [Copy] screen. If [Auto Select] is selected in [Paper Supply], a tray specified in [Auto Paper Off] is automatically selected. Change the setting as necessary. For information on [Auto Paper Off], refer to "5 Tools" > "Copy Service Settings" > "Copy Control" > "Auto Paper Off" in the Administrator Guide.

### 1 Select [Pages per Side].

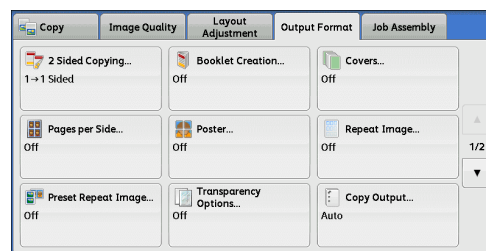

### 2 Select any option.

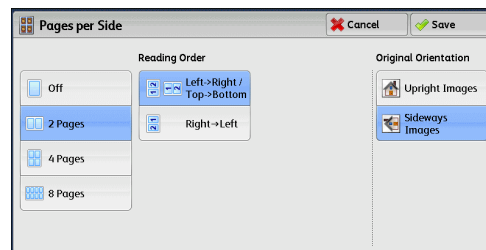

#### ■ Off

Disables this feature.

#### ■ 2 Pages

Copies two document pages onto one side of a single sheet of paper.

#### ■ 4 Pages

Copies four document pages onto one side of a single sheet of paper.

#### ■ 8 Pages

Copies eight document pages onto one side of a single sheet of paper.

#### ■ Reading Order

Allows you to select how to layout images on a page.

#### ■ Original Orientation

Allows you to specify the orientation of the document so that the machine can identify the top of the document.

**Note** • If the [Original Orientation] setting differs from the actual document orientation, the machine may not detect the top of the document correctly.

#### • Upright Images

Select this option when placing the top edge of the document against the top side of the document glass or document feeder.

#### • Sideways Images

Select this option when placing the top edge of the document against the left side of the document glass or document feeder.

## Poster (Making Enlarged Copies Spread over Multiple Sheets)

An enlarged copy of a document can be made spread over multiple sheets.

This feature allows you to create a large poster by pasting together the copies spread over multiple sheets. Copied sheets are provided with a paste margin so that they can be pasted together. The paste margin is fixed to 10 mm.

**Important** • Ensure that the actual orientation of the original document matches the [Original Orientation] setting on the [Layout Adjustment] screen.

**Note** • You cannot use the document feeder with this feature.

1 Select [Poster].

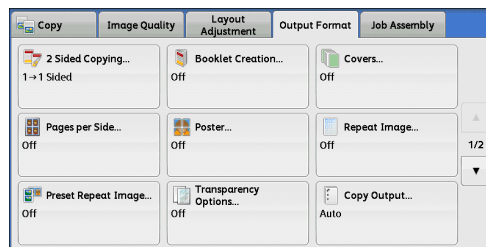

2 Select any option.

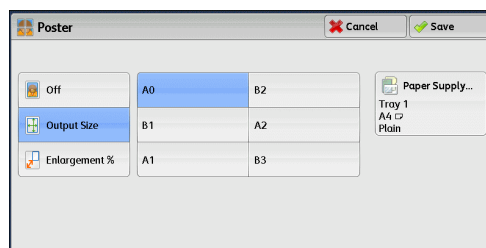

**Off**

No enlarged copies are made.

**Output Size**

Allows you to select the paper size.

**Enlargement %**

Refer to "When [Enlargement %] is Selected" (P.113).

**Paper Supply**

Displays the [Paper Supply] screen.

Select the paper tray to be used.

**Note** • When you use the bypass tray, select [Tray 5] on the [Paper Supply] screen.

When [Tray 5] is selected, the [Tray 5] screen is displayed. For more information, refer to "[Tray 5] Screen" (P.79).

Select the paper tray to be used.

When [Tray 5] is selected, the [Tray 5] screen is displayed. For more information, refer to "[Tray 5] Screen" (P.79).

**When [Enlargement %] is Selected**

This screen allows you to specify a different ratio for the width and length.

1 Use [+] and [-] to specify the copy ratios for the width and length.

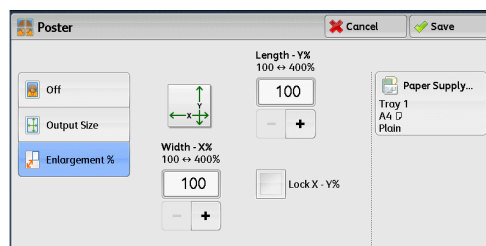

Copy 3

### ■Width - X%/Length - Y%

Allows you to specify the copy ratios for the width and length in the range from 100 to 400% in 1% increments.

### ■Lock X - Y%

Allows you to make the same ratio adjustment for the width and length at the same time.

## Repeat Image (Making Multiple Copies on One Sheet)

This feature allows you to copy a document image on one sheet of paper repeatedly for a specified number of times.

When [Reduce/Enlarge] is set to [Auto %], the repeated copies of the image are reduced to fit on the selected paper. You can also specify how the repeated copies of the image are arranged.

- Note**
- When making copies at the same size as the document image, the number of repeats is specified so that the copies fit on the paper.
  - If [Auto Select] is selected in [Paper Supply], a tray specified in [Auto Paper Off] is automatically selected. Change the setting if necessary. For information on [Auto Paper Off], refer to "5 Tools" > "Copy Service Settings" > "Copy Control" > "Auto Paper Off" in the Administrator Guide.

### 1 Select [Repeat Image].

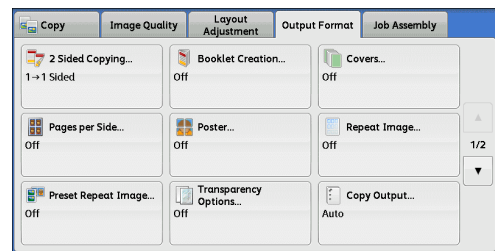

### 2 Select any option.

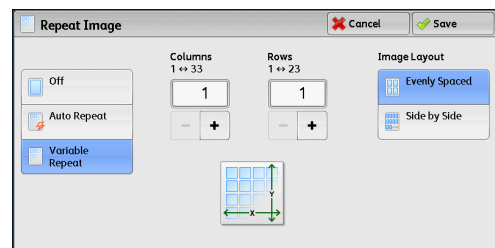

### ■Off

Disables this feature.

### ■Auto Repeat

Automatically determines the number of the repeated copies according to the document size, paper size, and copy ratio, and then repeatedly copies the document image onto the paper.

- Note**
- Copies cannot be made when the document image is larger than the specified paper size.

### ■Variable Repeat

Allows you to specify how many copies to place along each of the long and short edges of paper. You can specify a value between 1 and 23 in the Y direction, and a value between 1 and 33 in the X direction.

### ■Image Layout

- Evenly Spaced  
The specified number of images are evenly arranged on the paper.
- Side by Side  
The specified number of images are arranged with no space on the paper.

## Preset Repeat Image (Making Multiple Copies on a Single Sheet)

This feature allows you to repeatedly copy one original onto equally divided areas according to the specified number of copies. You can select the number of repeat from [2 Times], [4 Times], or [8 Times].

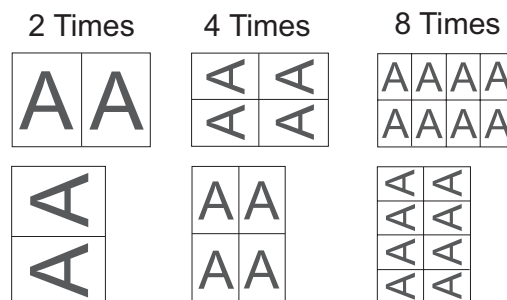

**Note** • When you select an option other than [Auto %] in [Reduce/Enlarge], image loss may occur depending on the image size of the document.

- 1 Select [Preset Repeat Image].

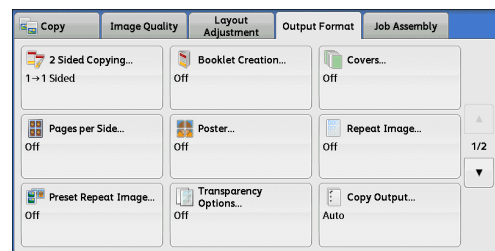

- 2 Select any option.

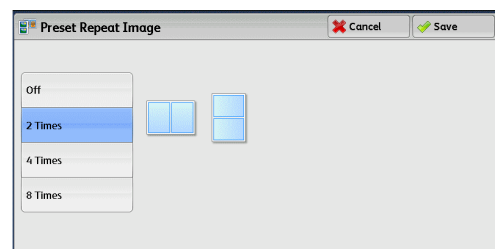

### ■Off

Disables this feature.

### ■2 Times

Makes two copies of the document image on a single sheet of paper.

### ■4 Times

Makes four copies of the document image on a single sheet of paper.

### ■8 Times

Makes eight copies of the document image on a single sheet of paper.

## Transparency Options (Inserting Blank Sheets between Transparencies)

This feature allows you to insert blank separators between output transparency sheets. At the same time, you can make copies for handouts.

**Important** • Using transparency sheets for color (with white border) may cause a malfunction or paper jam.

**Note** • When loading A4 size transparencies on Tray 5 (Bypass), we recommend that you load them in portrait orientation.  
• Load transparency sheets in a tray in the same orientation as the paper to be used for handouts and separators.

1 Select [Transparency Options].



2 Select any option.

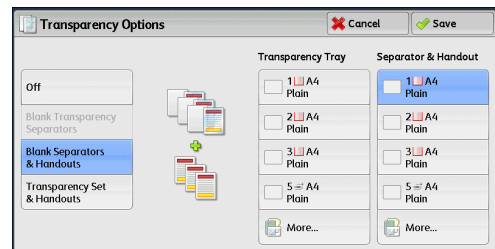

### ■ Off

Does not insert separators.

### ■ Blank Transparency Separators

Inserts a separator each time a transparency is copied. Only one set of copies can be made.

### ■ Blank Separators & Handouts

Inserts a separator each time a transparency is copied. At the same time, the required number of copies is made for handouts.

### ■ Transparency Set & Handouts

Makes copies on transparencies. At the same time, the required number of copies is made for handouts.

### ■ Transparency Tray

Allows you to select the paper tray to be used for the transparencies.

Select [More] to display the [Paper Supply - Transparency] screen on which you can select a tray.

**Note** • When you use the bypass tray, select [Tray 5] on the [Transparency Tray] screen.

When [Tray 5] is selected, the [Tray 5] screen is displayed. For more information, refer to "[Tray 5] Screen" (P.79).

### ■ Separator Tray

Allows you to select the paper tray to be used for the separators.



Select [More] to display the [Paper Supply - Separator] screen on which you can select a tray.

**Note** • When you use the bypass tray, select [Tray 5] on the [Separator Tray] screen.

When [Tray 5] is selected, the [Tray 5] screen is displayed. For more information, refer to "[Tray 5] Screen" (P.79).

### ■ Separator & Handout

Allows you to select the paper tray to be used for the separators and handouts.

Select [More] to display the [Paper Supply - Separator & Handout] screen on which you can select a tray.

**Note** • When you use the bypass tray, select [Tray 5] on the [Separator & Handout Tray] screen.

When [Tray 5] is selected, the [Tray 5] screen is displayed. For more information, refer to "[Tray 5] Screen" (P.79).

### ■ Handout Tray

Allows you to select the paper tray to be used for the handouts.

Select [More] to display the [Handout Tray] screen on which you can select a tray.

**Note** • When you use the bypass tray, select [Tray 5] on the [Handout Tray] screen.

When [Tray 5] is selected, the [Tray 5] screen is displayed. For more information, refer to "[Tray 5] Screen" (P.79).

## Copy Output (Specifying Finishing Options)

This feature allows you to select finishing options.

**Note** • This feature does not appear for some models. An optional component is required. For more information, contact our Customer Support Center.

If the finisher is installed, each set of copies can be stapled, and then output.

### 1 Select [Copy Output].

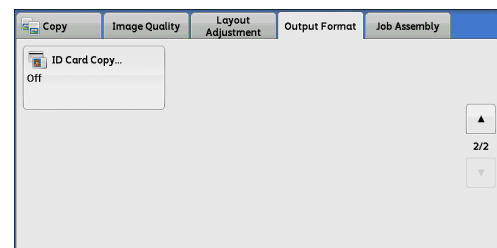

### 2 Select any option.

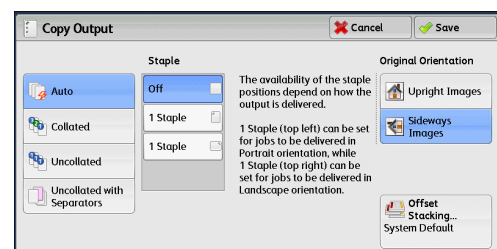

### ■ Auto

Copies are collated when the originals are loaded on the document feeder. Copies are also collated when the originals are loaded on the document glass and any of the following features is used: 2 Sided Book Copying, Covers, Blank Separators & Handouts or Transparency Set & Handouts of Transparency Options, Booklet Creation, Stapling, Build Job, Sample Set, and Combine Original Sets.

**■ Collated**

The machine outputs sheets sorted into sets that are arranged in page order.

**■ Uncollated**

The machine outputs the specified number of copies and sorts sheets by page.

**■ Uncollated with Separators**

The machine outputs copies with inserting blank sheets as a separator and sorts sheets by page.

**■ Separator Tray**

When you select [Uncollated with Separators], select the paper tray to be used for the separators.

**Note** • When you use the bypass tray, select [Tray 5] on the [Separator Tray] screen.

**■ Staple**

Specify the position for stapling. The number of sheets that can be stapled is 2 - 50 (when 80 gsm paper is used). Available paper types are: Plain paper, Recycled paper, Reload paper, Bond paper, Heavyweight paper (106 - 163 gsm), Extra Heavyweight paper (164 - 216 gsm), and Custom paper 1 to 5. If paper heavier than 90 gsm or lighter than 60 gsm is used, outputs may not be stapled correctly even if the number of sheets is 50 or less.

**■ Original Orientation**

Allows you to specify the orientation of the document so that the machine can identify the top of the document.

**Note** • If the [Original Orientation] setting differs from the actual document orientation, the machine may not detect the top of the document correctly.

- Upright Images

Select this option when placing the top edge of the document against the top side of the document glass or document feeder.

- Sideways Images

Select this option when placing the top edge of the document against the left side of the document glass or document feeder.

**■ Offset Stacking**

Allows you to select the output destination tray and offset operation.



The offset is a function for slightly offsetting and outputting each paper stack to allow you to distinguish the separations. You can select from [Offset per Set], [Offset per Job], [Offset Every N Pages], [Offset Every N Sets], and [System Default].

**Note** • This feature does not appear for some models. An optional component is required. For more information, contact our Customer Support Center.

• If you select [System Default], the setting in the System Administration mode will be effective. For information on how to change the setting, refer to "5 Tools" > "Copy Service Settings" > "Copy Defaults" > "Output Destination" in the Administrator Guide.

## Paper Size and Stapling Position

- Finisher-AB1

	1 Staple (Left)	1 Staple (Right)
A4, B5, 7.25 x 10.5", 8.5 x 10", 8.5 x 11", 8.5 x 13", 8.5 x 14", 16K		

\* : The staple orientation displayed on the touch screen differs from the actual staple orientation. Outputs are stapled in the orientation shown in the above table.

\* : When different sized documents are loaded in the document feeder, outputs are stapled only when all the documents match the document guides. For information on how to copy different sized documents simultaneously, refer to "Mixed Size Originals (Scanning Different Size Documents Simultaneously)" (P.99)

## ID Card Copy (Copying Both Sides of an ID Card)

This feature allows you to copy both sides of a small undetectable original, such as an ID card, onto one side of paper.

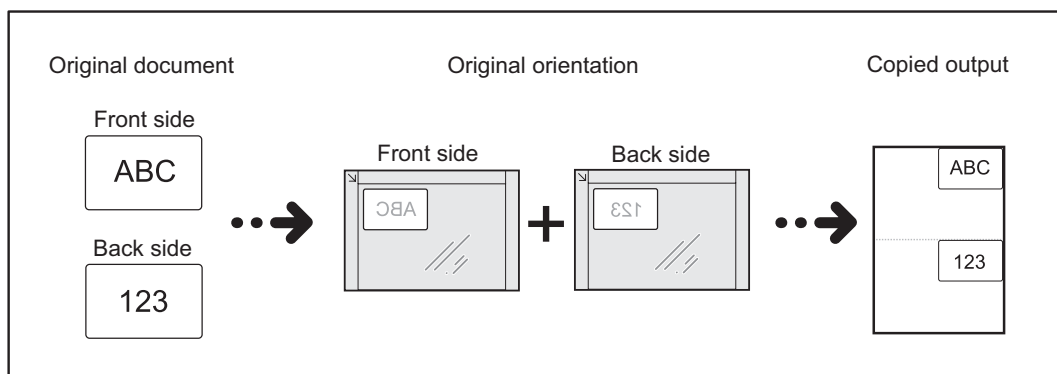

- 1 Specify the orientation of the document in [Original Orientation] on the [Layout Adjustment] screen.

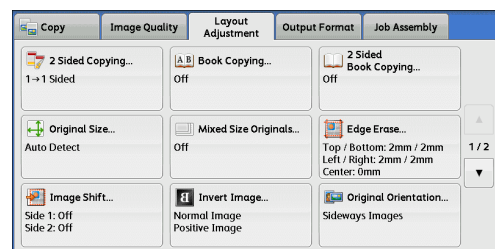

- 2 Place the document slightly away from the top left corner of the document glass, and close the document glass.

- Important**
- Always use the document glass when copying. You cannot use the document feeder with this feature.
  - Specify the orientation of the original document correctly.
  - If the edges of the image are missing, slightly move the card inward on the document glass so that the whole image can be scanned.

- When the reduced size is specified to copy an ID card, the machine may copy the ID card in a different orientation from the original orientation depending on the magnification ratio specified. For information on the copy magnification ratio for ID Card Copy, refer to "5 Tools" > "Copy Service Settings" > "Copy Control" > "ID Card Copy - Reduce/Enlarge" in the Administrator Guide.

For information on how to specify the orientation of a document, refer to "Original Orientation (Specifying the Orientation of Loaded Documents)" (P.104).

**3** Select [ID Card Copy] on the [Output Format] screen.

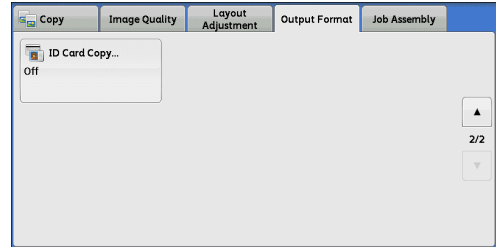

**4** Select [On].

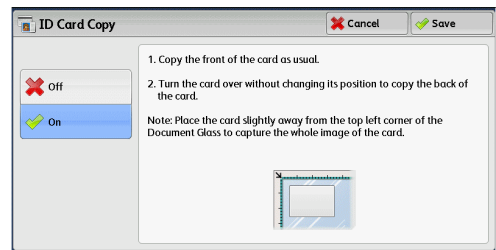

- **Off**  
Disables ID card copying.
- **On**  
Enables ID card copying.

# Job Assembly

This section describes the features you can select on the [Job Assembly] screen. The following shows the reference section for each feature.

Build Job (Processing Documents Scanned with Different Settings as One Job) .....	121
Sample Job (Checking the Finished Output of the Copy).....	125
Combine Original Sets (Adding Originals).....	126
Delete Outside/Delete Inside (Deleting Outside or Inside of the Selected Area).....	128
Stored Programming (Calling a Stored Program for Build Job).....	130

- 1 Select [Copy] on the [Services Home] screen.

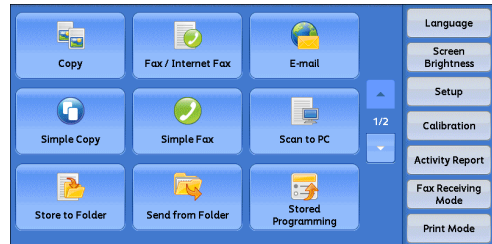

- 2 Select a feature on the [Job Assembly] screen.

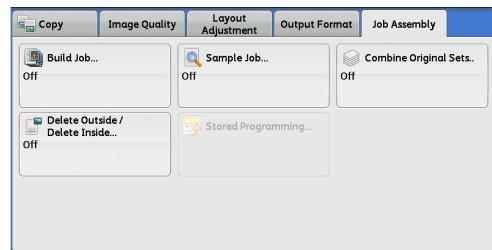

## Build Job (Processing Documents Scanned with Different Settings as One Job)

This feature allows you to apply different copy settings to each document page or each document stack, and then output the copies as one job.

- 1 Select [Build Job].

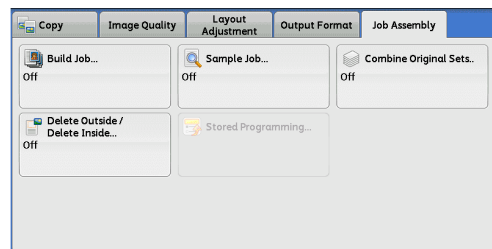

- 2 Select [On].

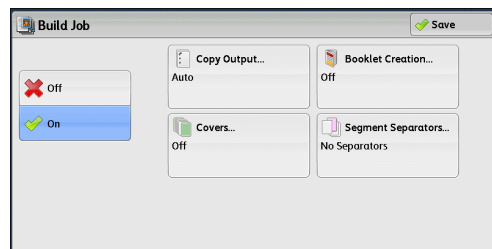

- 3 Select any option.

### ■Off

Build Job is not applied.

### ■On

Build Job is applied. The feature buttons appear. Specify any option if necessary.

**Important** • The features selected here cannot be canceled or changed while the machine executes a copy job.

For information on features available in Build Job, refer to "Features that can be set in Build Job" (P.122).

## Features that can be set in Build Job

### ■Copy Output

For more information, refer to "Copy Output (Specifying Finishing Options)" (P.117).

### ■Booklet Creation

For more information, refer to "Booklet Creation (Creating a Booklet)" (P.108).

### ■Covers

**Important** • The machine does not copy on a cover when using the Build Job feature.

For more information, refer to "Covers (Attaching Covers to Copies)" (P.110).

### ■Segment Separators

For more information, refer to "[Segment Separators] Screen" (P.124).

## [Copy] Screen When Build Job is in Progress

The following describes the screen that appears while the Build Job is being executed.

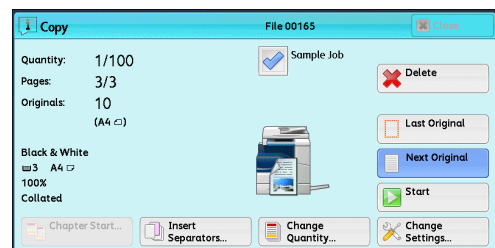

### ■Chapter Start

Displays the [Build Job - Chapter Start] screen.

Refer to "[Build Job - Chapter Start] Screen" (P.123).

### ■Insert Separators

Displays the [Segment Separators] screen.

Refer to "[Segment Separators] Screen" (P.124).

### ■Change Quantity

Displays the [Change Quantity] screen on which you can change the number of copy sets using the numeric keypad.

### ■Change Settings

Displays the [Copy] screen on which you can change the settings for the next document. After changing the settings, press the <Start> button on the control panel to

start scanning of the document. To return to the previous screen, press the < # > button.

When using a stored program for Build Job

While the machine makes copies using the Build Job feature, you can use a stored program.

- 1) Select [Change Settings].
- 2) Select the [Job Assembly] tab.
- 3) Select [Stored Programming].
- 4) Select the number of the stored program that contains the features you want to use.

For information on how to register a stored program, refer to "Registering Stored Programs for Build Job" (P.309).

### ■Delete

Clears the document data stored by the Build Job feature, and cancels the job.

- Note**
- You can also press the <C (Clear)> or <Clear All> button on the control panel to perform the same operation.
  - While the machine is scanning the loaded document, [Delete] is displayed. Select [Delete] to pause scanning. Select [Start] on the touch screen, or press the <Start> button on the control panel to resume scanning.

### ■Last Original

Select this button to end scanning of documents. The build job starts.

### ■Next Original

Select this button when you have another document. This button is always selected when you use the Build Job feature.

### ■Start

After loading the next document, select this button to scan the next document.

- Note**
- You can also press the <Start> button on the control panel to perform the same operation.

### ■Sample Job

When making multiple sets of copies, you can print a sample set to check the finished output and then print the remaining copy sets. You can select to continue or cancel the job after the confirmation.

## [Build Job - Chapter Start] Screen

This screen allows you to set the chapter start.

- 1 Select any option.

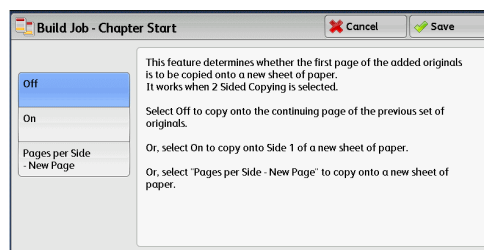

### ■Off

The next stack of documents is copied after the previous stack.

### ■On

The next stack of documents is copied from Side 1 of a new sheet of paper.

### ■Pages per Side - New Page

When [Pages per Side] is set, even if all documents are divided for every chapter before all of them are assembled in the Pages per Side feature, the next stack of document is copied from Side 2 of the paper.

### [Segment Separators] Screen

This screen allows you to insert a sheet of paper as a separator in between each stack of documents. You can specify the number of separators to insert in the range from 1 to 99 as necessary.

**Note** • You can specify different settings for each stack of documents. If you do not specify particular settings for each stack of documents, the previously specified settings are applied.

#### 1 Select any option.

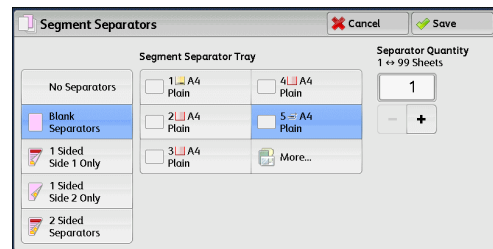

#### 2 Select any option.

##### ■No Separators

Does not insert any separators.

##### ■Blank Separators

Inserts blank separators.

If you select this option, load documents, and press the <Start> button, the blank separators are inserted ahead of the copies of the documents.

##### ■ 1 Sided Side 1 Only

A first page of the loaded documents is copied on the front side of a separator, and the rest of pages are copied on the paper other than a separator.

When [Pages per Side] is set, the number of pages (2 pages, 4 pages, or 8 pages) that you selected to copy onto one side of a single sheet, starting from the first page of the loaded documents, are copied onto the front page of a separator.

When you load a single sheet document, the document is copied onto a separator.

##### ■1 Sided Side 2 Only

A first page of the loaded documents is copied on the back side of a separator, and the rest of pages are copied on the paper other than a separator.

When [Pages per Side] is set, the number of pages (2 pages, 4 pages, 8 pages) that you selected to copy onto one side of a single sheet, starting from the first page of the loaded documents, are copied onto the back side of a separator.

When you load a single sheet document, the document is copied onto a separator.

##### ■2 Sided Separators

First two pages of the loaded documents are copied onto each side of a separator, and the rest of pages starting from the third page are copied onto the paper other than a separator.



When [Pages per Side] is set, the number of pages (2 pages, 4 pages, 8 pages) that you selected to copy onto one side of a single sheet, starting from the first page of the loaded documents, are copied onto each side of a separator.

When you load two-sheet documents, both sheets are copied onto each side of a separator.

- Note**
- When you have two separate documents, a single sheet document and multiple sheet documents, if you want to copy this single sheet document and the first page of the multiple sheet documents onto each side of a separator, when loading the multiple sheet documents, select [No Separator] in [Build Job - Separators]. If you do not select [No Separator], the machine processes these two documents separately under different separator settings, the single-sheet document is copied onto a separator, and the first page (or first two page) of the multiple sheet documents is copied onto another separator.

**■Segment Separator Tray**

Allows you to select the tray, which is loaded with paper to be used as a separator.

When [Tray 5] is selected, the [Tray 5] screen is displayed. For more information, refer to "[Tray 5] Screen" (P.79).

**■Separator Quantity**

This option is available when you select [Blank Separators]. You can specify the number of separators in the range from 1 to 99.

**Sample Job (Checking the Finished Output of the Copy)**

When making multiple sets of copies, you can print a sample set to check the finished output and then print the remaining copy sets. You can select whether to continue or cancel the job after the confirmation. This feature also allows you to change the number of copy sets. The sample copy is included in the total number of copy sets.

- Note**
- After a sample set is output, the machine automatically outputs the data remained if the machine is left uninstructed for the period specified in [Auto Job Release]. For more information on [Auto Job Release], refer to "5 Tools" > "Common Service Settings" > "Machine Clock/Timers" > "Auto Job Release" in the Administrator Guide.

1 Select [Sample Job].

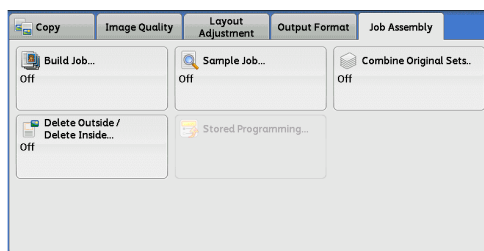

2 Select [On].

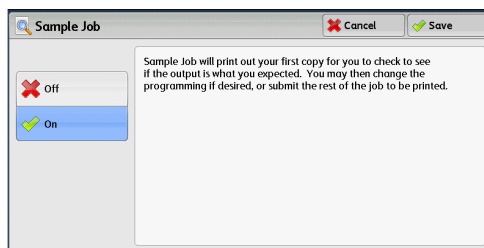

**■Off**

No sample set is made.

**■On**

A sample set is made.

## [Copy] Screen When Sample Job is in Progress

After the sample set is copied, the machine pauses the job and displays the [Copy] screen.

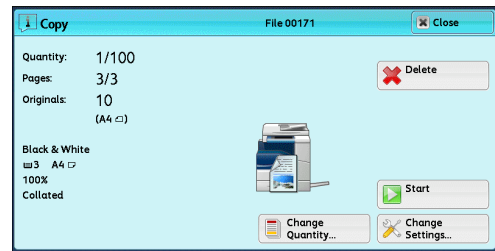

### ■ Change Quantity

Displays the [Change Quantity] screen on which you can change the number of copies entered before. Enter a new quantity using the numeric keypad. The new value must include the number of the sample set that has already been printed. When reducing the quantity, specify a value between 1 (sample set) and the number of copies entered before.

**Note** • If you specify "1" as a new quantity and then press the <Start> button, the machine will not process the job.

### ■ Change Settings

Displays the [Change Settings] screen. To cancel the settings you have made, deselect the check box for the feature you want to cancel.

### ■ Delete

The remaining copies are canceled.

### ■ Start

The remaining copies are made.

**Note** • You can also press the <Start> button on the control panel to perform the same operation.

## Combine Original Sets (Adding Originals)

Use this feature when you copy a document that has too many pages to be loaded in the document feeder at one time, or when you scan each document page using the document glass and have the machine process the pages as one job.

When you use this feature, [Next Original] is always selected on the screen during scanning documents with the document feeder or the document glass.

If [Copy Output] is set to [Auto], the output is automatically sorted.

When all documents have been scanned, select [Last Original].

**Note** • After the first original set is copied, the machine automatically outputs the data remained if the machine is left unused for the period specified in [Auto Clear]. For more information on [Auto Clear], refer to "5 Tools" > "Common Service Settings" > "Machine Clock/Timers" > "Auto Clear" in the Administrator Guide.

## 1 Select [Combine Original Sets].

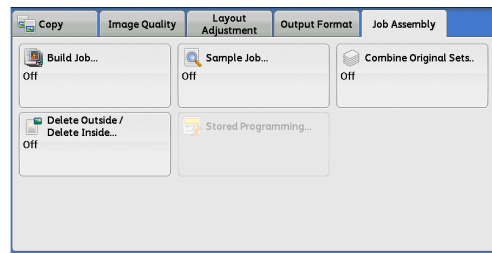

## 2 Select [On].

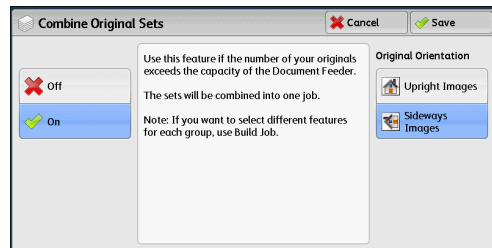

### ■Off

Disables this feature.

### ■On

Enables this feature.

### ■Original Orientation

Allows you to specify the orientation of the document so that the machine can identify the top of the document.

**Note** • If the [Original Orientation] setting differs from the actual document orientation, the machine may not detect the top of the document correctly.

- Upright Images

Select this option when placing the top edge of the document against the top side of the document glass or document feeder.

- Sideways Images

Select this option when placing the top edge of the document against the left side of the document glass or document feeder.

## [Copy] Screen When Combine Original Sets is in Progress

The [Copy] screen is displayed when copying starts.

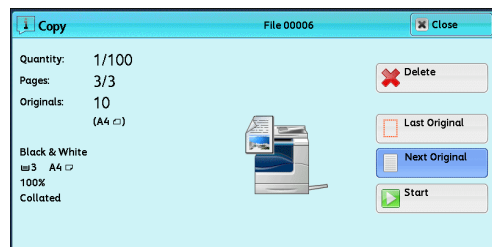

### ■Delete

Clears the document data stored with the Combine Original Sets feature, and cancels copying.

**Note** • You can also press the <C (Clear)> or <Clear All> button on the control panel to perform the same operation.

■ **Last Original**

Select this button to end scanning documents.

■ **Next Original**

Select this button when you have more documents to copy. This button is always selected when the Combine Original Sets feature is used.

■ **Start**

After loading the next document, select this button to scan the next document.

**Note** • You can also press the <Start> button on the control panel to perform the same operation.

**Delete Outside/Delete Inside (Deleting Outside or Inside of the Selected Area)**

This feature allows you specify the areas to be deleted from a document image. Up to three areas can be specified.

- 1 Select [Delete Outside/Delete Inside].

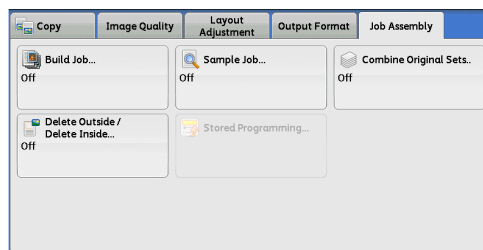

- 2 Select any option.

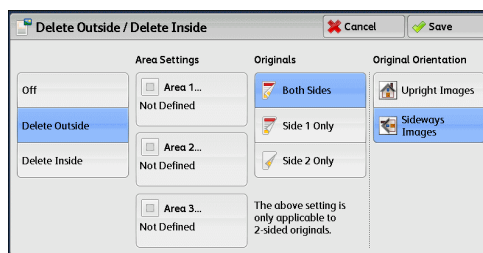

■ **Off**

No area is deleted.

■ **Delete Outside**

Deletes the outside of the selected area.

■ **Delete Inside**

Deletes the inside of the selected area.

■ **Area Settings**

Displays the [Delete Outside/Delete Inside - Area 1 (Area 2 or Area 3)] screen. You can specify up to three areas.

Refer to "[Delete Outside/Delete Inside - Area 1 (Area 2 or Area 3)] Screen" (P.129).

■ **Originals**

When the original document is a 2-sided document, specify from which side the specified area is to be deleted.

- Both Sides  
Applies the settings to both sides of the document.
- Side 1 Only  
Applies the settings to Side 1 of the document.
- Side 2 Only  
Applies the settings to Side 2 of the document.

### ■Original Orientation

Allows you to specify the orientation of the document so that the machine can identify the top of the document.

**Note** • If the [Original Orientation] setting differs from the actual document orientation, the machine may not detect the top of the document correctly.

- Upright Images  
Select this option when placing the top edge of the document against the top side of the document glass or document feeder.
- Sideways Images  
Select this option when placing the top edge of the document against the left side of the document glass or document feeder.

### [Delete Outside/Delete Inside - Area 1 (Area 2 or Area 3)] Screen

This screen allows you to specify the area to be deleted. The area is defined by the rectangle formed between the points X1,Y1 and X2,Y2. The origin point is the top right corner of a document.

You can specify a value in the range from 0 to 356mm for the width (X) and the length (Y) in 1 mm increments.

- Note**
- Specify the 2 coordinates from the top right corner of the document.
  - When specifying multiple areas, the specified areas can overlap each other.
  - When [Reduce/Enlarge] is set, the specified area will be reduced or enlarged accordingly.

- 1 Select [Area 1], [Area 2], or [Area 3].

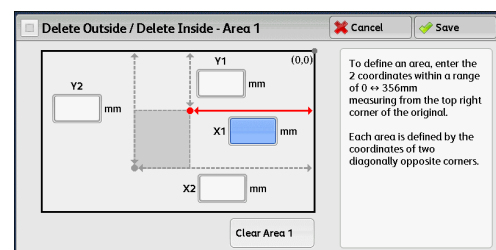

- 2 Enter the value for X1 in [X1] using the numeric keypad.
- 3 Enter the value for Y1 in [Y1] using the numeric keypad.
- 4 Enter the value for X2 in [X2] using the numeric keypad
- 5 Enter the value for Y2 in [Y2] using the numeric keypad.

- Note**
- If all of [X1], [Y1], [X2], and [Y2] are set to [0], the area will be invalid. If no other area is specified, the Delete Outside/Delete Inside feature cannot be used.
  - Pressing the <C (Clear)> button clears the value you have entered.

### ■Clear Area 1 (Area 2 or Area 3)

Clears all the values set for Area 1 (Area 2 or Area 3).

## **Stored Programming (Calling a Stored Program for Build Job)**

---

This feature allows you to call a stored program for Build Job.

This feature is the same as "8. Stored Programming" > "Calling a Stored Program" > "Calling a Stored Program for Build Job". For more information, refer to "Calling a Stored Program for Build Job" (P.314).

























# 4 Fax

This chapter describes the basic operations and features for the Fax services.

- Fax Procedure ..... 142
- Operations during Faxing ..... 149
- About Internet Fax ..... 152
- Simple Fax ..... 160
- Fax/Internet Fax ..... 164
- Layout Adjustment ..... 174
- Fax/Internet Fax Options ..... 179
- More Options ..... 199
- Broadcast ..... 205
- Receiving Faxes ..... 213
- Facsimile Information Services ..... 216

**Note** • The Fax services are not available for some models. An optional component is required. For more information, contact our Customer Support Center.

## Fax Procedure

This section describes the basic fax procedures. The following shows the reference section for each procedure.

Step 1 Loading Documents .....	142
Step 2 Selecting Features .....	144
Step 3 Specifying Destinations .....	145
Step 4 Starting the Fax Job .....	146
Step 5 Confirming the Fax Job in Job Status .....	147

### Step 1 Loading Documents

The following two methods are available to load documents:

■ **Document Feeder**

- Single sheet
- Multiple sheets

■ **Document Glass**

- Single sheet
- Bound documents, such as books

#### Document Feeder

The document feeder supports single and multiple sheet documents with sizes from 125 x 85 mm (Standard size: A5, A5<sup>□</sup>) to 216 x 600 mm (long) (Standard size: A4, 8.5 x 14").

The document feeder automatically detects documents of standard-size widths.

**Note** • The minimum supported paper size for 2-sided copying: 125 x 110mm (Standard size: A5, A5<sup>□</sup>).

The standard document sizes that can be detected automatically depend on [Paper Size Settings] in the System Administration mode. For information on [Paper Size Settings], refer to "5 Tools" > "Common Service Settings" > "Other Settings" > "Paper Size Settings" in the Administrator Guide.

The size on the left is detected as the size shown on the right as follows.

Original Document Size	Document Size Detected by the Document Feeder
8-inch width document	B5 width document

The document feeder accepts the following number of sheets.

Document Type (Weight)	Number of Sheets
Lightweight paper (38 - 49 gsm)	110 sheets
Plain paper (50 - 80 gsm)	110 sheets
Heavyweight paper (81 - 128 gsm)	75 sheets

**Important** • To avoid paper jams, use the document glass for folded or wrinkled documents, cut-and-pasted documents, curled paper, or back carbon paper.  
 • 2-sided scanning of lightweight paper (38 - 49 gsm) is not supported.

For information on how to fax mixed sized documents, refer to "Mixed Size Originals (Scanning Different Size Documents Simultaneously)" (P.175).

- 1 Remove any paper clips and staples before loading a document.
- 2 Load the document face up (when the document is 2-sided, place the front side up) in the center of the document feeder.

**Note**

- The Confirmation indicator lights up when the document is loaded correctly. If the indicator does not light, the machine may be detecting the document on the document glass. Load the document again.

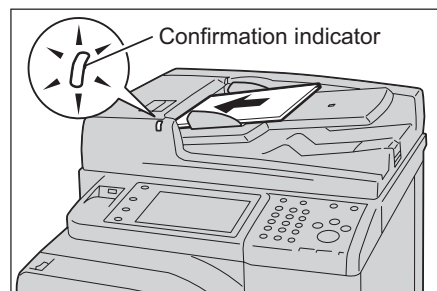

- 3 Adjust the document guides to match the size of the document loaded.

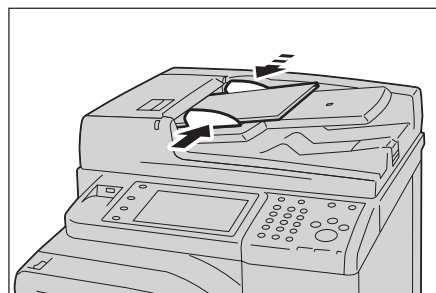

- 4 Raise the document stopper.

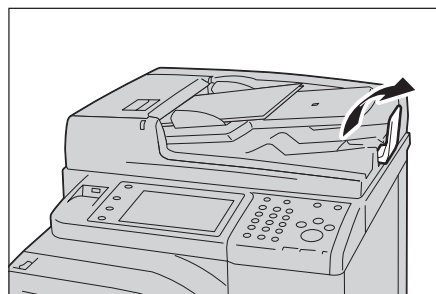

## Document Glass

The document glass supports a single sheet, a book, or other similar documents with size from 15 x 15 mm (Standard size: A5, A5 $\square$ ) to 216 x 356 mm (Standard size: A4).

**Important** • Always close the document cover after using the document glass.

The document glass automatically detects standard size documents.

The standard document sizes that can be detected automatically depend on [Paper Size Settings] in the System Administration mode. For information on [Paper Size Settings], refer to "5 Tools" > "Common Service Settings" > "Other Settings" > "Paper Size Settings" in the Administrator Guide.

### CAUTION

Do not apply excessive force to hold thick document on the document glass. It may break the glass and cause injuries.

**1** Open the document cover.

**Important** • Ensure that the touch screen is active, and then load a document. Otherwise, the machine may not properly detect the document size.

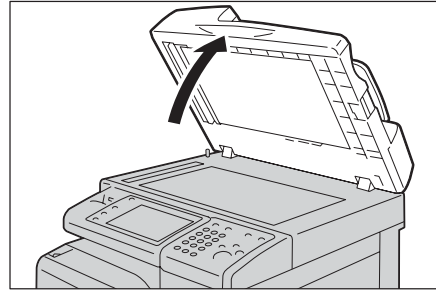
**2** Load the document face down, and align it against the top left corner of the document glass.

**Note** • When you load a A5, B5 or A4 document on the document glass in portrait orientation, the scanned image is transmitted with 180 degrees rotated.

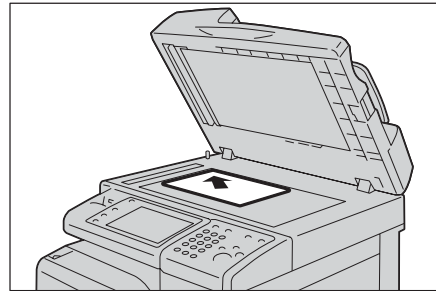
**3** Close the document cover.

**Note** • When a standard size document is loaded on the document glass, the size of the document is displayed in the message field.

## Step 2 Selecting Features

The following two services are available to send faxes.

### ■ Simple Fax

Allows you to only select basic features to send faxes.

### ■ Fax/Internet Fax

Allows you to make detailed settings to send faxes.

The following procedure uses [Fax/Internet Fax] to describe how to select features.

You can select the Fax or Internet Fax service on the [Services Home] screen.

For information on the Simple Fax feature, refer to "Simple Fax" (P.160).

**Note** • The features displayed on the screen depend on your machine configuration.  
• When the Authentication or Accounting feature is enabled, a user ID and passcode may be required. Ask your system administrator for the user ID and passcode.

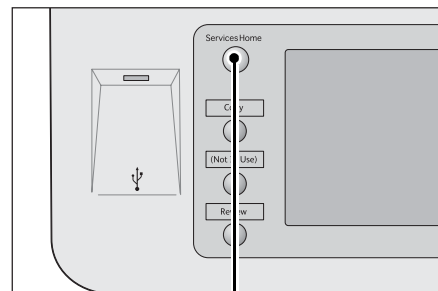
**1** Press the <Services Home> button.

<Services Home> button

2 Select [Fax/Internet Fax].

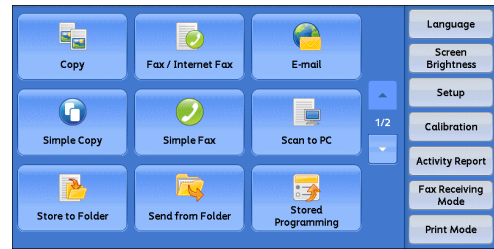

3 If the previous settings still remain, press the <Clear All> button.

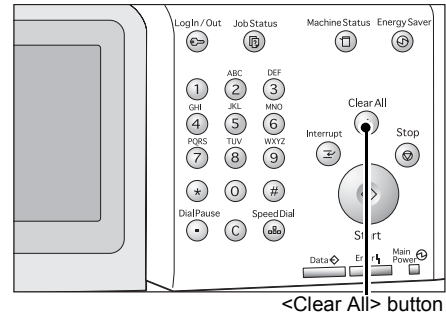

4 Select each tab, and select a feature as necessary.

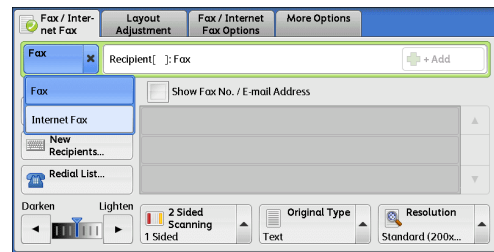

Fax  
4

The following shows the reference section for each tab.

- "Fax/Internet Fax" (P.164)
- "Layout Adjustment" (P.174)
- "Fax/Internet Fax Options" (P.179)
- "More Options" (P.199)

### Step 3 Specifying Destinations

Three methods are available to specify recipients: by phone number, by address number, and by group dial number. The following shows input methods supported by each method.

	Numeric Keypad	Address Book
<b>Phone Number</b>	○	X
<b>Address Number (Speed Dialing)</b>	4 digits (0001 to 2000)	From the list tab and index
	3 digits + * (nnn0 to nnn9) 2 digits + * (nn00 to nn99)	
<b>Group Dial Number</b>	# + 2 digits	○

- Available
- X Not available

You can specify multiple recipients (Broadcast Send) using the above methods. You can also use a combination of the methods.

If the same recipient was specified for several pending documents, you can send the documents with a single phone call. This feature is called Batch Send. Note that you cannot use Batch Send with Broadcast Send, Relay Broadcast, Remote Folder, and Delay Start when prior to the specified time. When using a redial, resend, or delayed start send transmission job, or authentication feature, to send to the same address from different users, then Batch Send is not possible.

**Important** • Confirm recipients before sending a fax.

For information on Broadcast Send, refer to "Broadcast Send (Transmitting to Multiple Recipients)" (P.205).

The following describes how to enter a phone number with the numeric keypad as an example.

- 1 Enter a fax number using the numeric keypad.

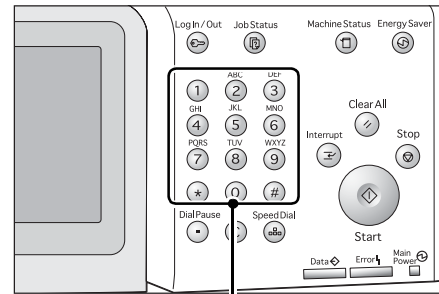

Numeric keypad

- 2 To specify multiple recipients, select [+ Add] on the touch screen.

- Note**
- If you have entered an incorrect value, press the <C (Clear)> button and enter the correct value.
  - Depending on the settings, a screen to re-enter the recipient may be displayed after you specify the recipient and then select [+ Add]. In such case, re-enter the recipient.

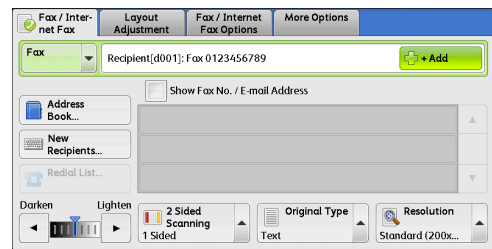

For information how to specify a fax number using the Address Book, refer to "Specifying a Destination Using the Address Book" (P.165).

For information how to specify a fax number using the speed dialing, refer to "Speed Dialing (Specifying a Destination Using an Address Number)" (P.167).

For information on the Internet Fax, refer to "About Internet Fax" (P.152).

## Step 4 Starting the Fax Job

The following describes how to start a fax job.

- 1 Press the <Start> button.

- Important** • If the document has been loaded in the document feeder, do not hold down the document while it is being conveyed.

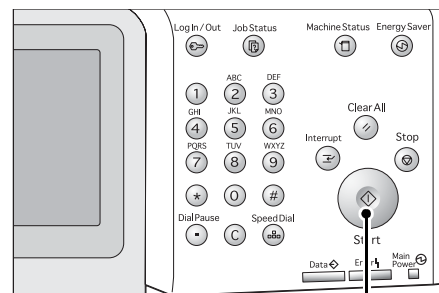

<Start> button

- Note**
- Depending on the settings, the screen to re-enter the recipient may be displayed after pressing the <Start> button. In this case, re-enter the recipient.

- If a problem occurs, an error message appears on the touch screen. Solve the problem according to the message.

### ■If you have more documents

If you have more documents to fax, select [Next Original] on the touch screen while the current document is being scanned. This allows you to send the documents as one set of data.

## 2 While documents are being scanned, select [Next Original].

- Note**
- When using the document feeder, load the next document after the machine has finished scanning the first document.
  - When [Next Original] is displayed on the screen shown on the right and no operation is performed during a certain period of time, the machine automatically assumes that there are no more documents.
  - You can change the scan settings of the next document by selecting [Resolution], [Original Size], and [Lighten/Darken] that are displayed after selecting [Next Original].

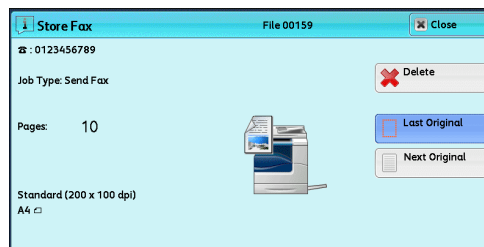

## 3 Load the next document.

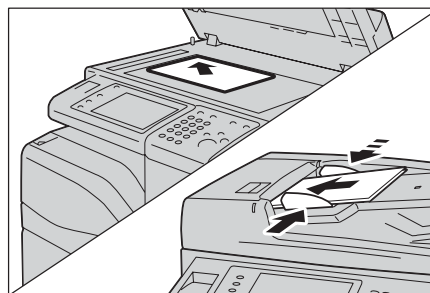

## 4 Press the <Start> button. If you have more documents, repeat steps 3 and 4.

## 5 When all documents have been scanned, select [Last Original].

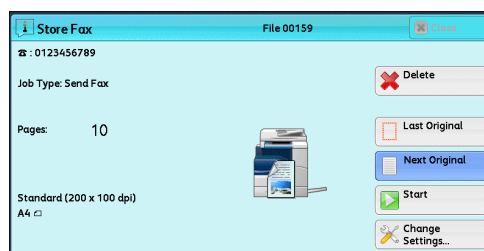

## Step 5 Confirming the Fax Job in Job Status

The following describes how to confirm the status of a fax job.

1 Press the <Job Status> button.

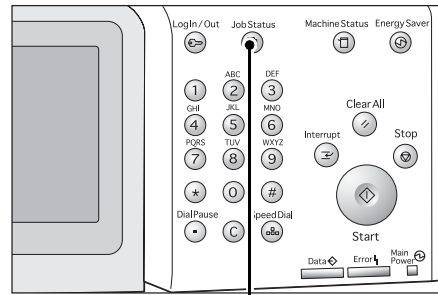

<Job Status> button

2 Confirm the job status.

- Note**
- Select [▲] to return to the previous screen or [▼] to move to the next screen.
  - From the drop-down menu, you can select [Scan, Fax, & Internet Fax Jobs] and display the desired job.

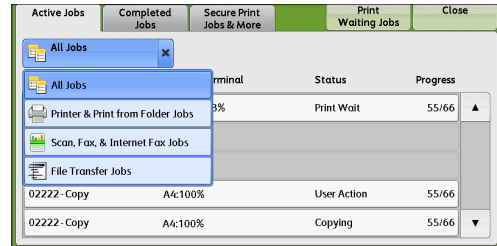

■ If undelivered faxes exist

You can confirm undelivered faxes on the [Job Status] screen or in an Activity Report. For information on how to resend or delete undelivered faxes, refer to "Job Status" (P.327).



# Operations during Faxing

This section describes the available operations during faxing. The following shows the reference section for each operation.

Stopping the Fax Job ..... 149  
 Changing the Scan Settings ..... 150

## Stopping the Fax Job

To cancel scanning a fax document, use the following procedure.

- 1 Press either the <Stop> button on the control panel or [Delete] on the touch screen.

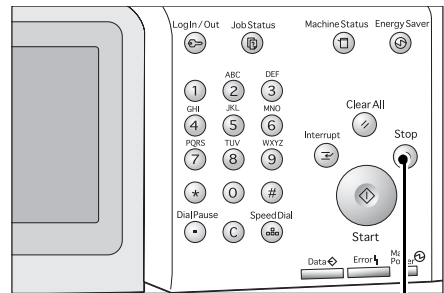

<Stop> button

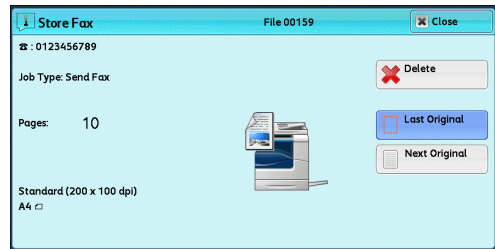

- 2 Select [Delete].

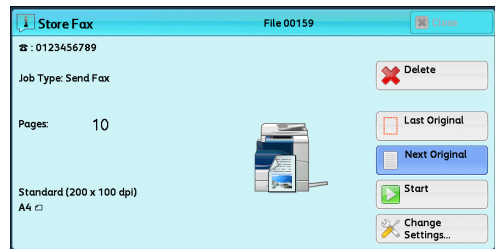

■If [Delete] does not appear on the screen:

- 1 Press the <Job Status> button.

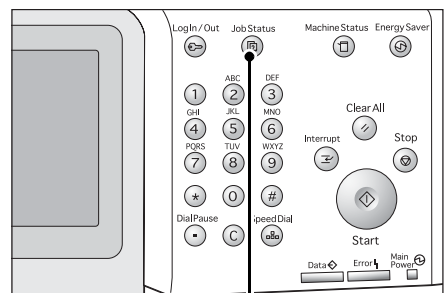

<Job Status> button

**2** Select the job to cancel.

**Note** • Select [▲] to return to the previous screen or [▼] to move to the next screen.

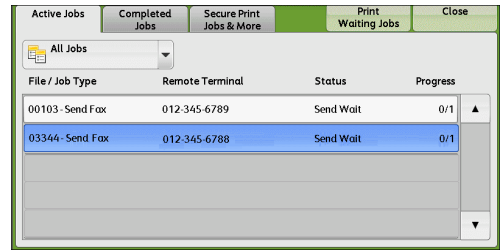

**3** Select [Delete].

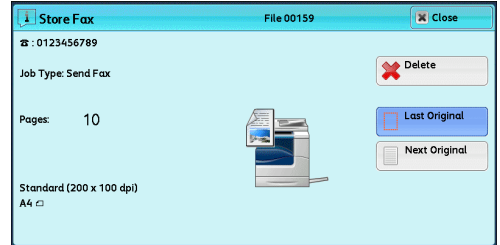

**4** Select [Delete].

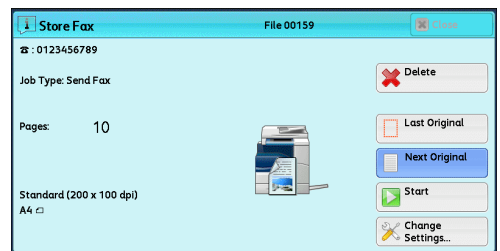

## Changing the Scan Settings

You can change the scan settings while scanning a document.

**1** Select [Next Original].

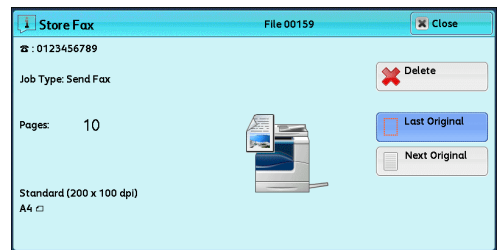

**2** Select [Change Settings].

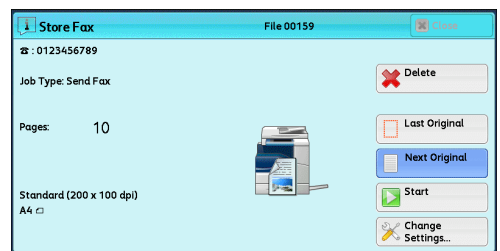

**3** Set [Resolution], [Original Size], and [Lighten/Darken].

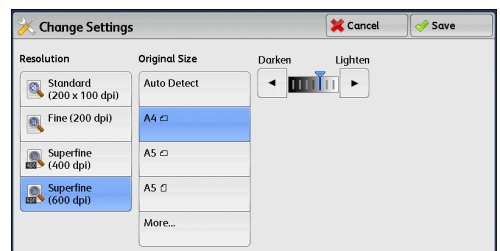

For each setting, refer to "Resolution (Specifying the Scanning Resolution)" (P.172), "Original Size (Specifying the Scan Size for the Original)" (P.174), or "Lighten/Darken (Adjusting Fax Density)" (P.170).

**4** Select [Save].

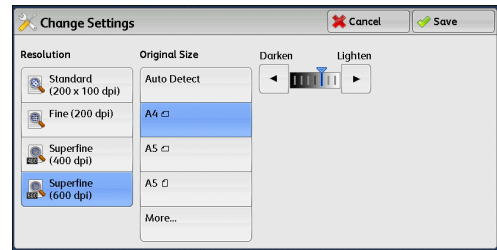

**5** Press the <Start> button.

## About Internet Fax

---

Unlike general fax communications using public phone lines, Internet Fax uses corporate intranets and the Internet to send or receive scanned documents as e-mail attachments.

Because Internet Fax uses existing corporate intranets and the Internet, the transmission is less expensive than general fax transmission.

- Note**
- This feature is not available for some models. An optional component is required. For more information, contact our Customer Support Center.
  - To use Internet Fax, various settings are required to display [Internet Fax] from the drop-down menu on the [Fax/Internet Fax] screen. For more information, consult your system administrator.
  - Internet Fax does not support color documents. If the machine receives color documents for Internet Fax (Profile: TIFF-C), the documents are converted to black-and-white documents and printed. To send and receive color documents, use the E-mail service.

For information on how to connect the machine to a network and how to set the network environment, refer to "5 Tools" > "Connectivity & Network Setup" in the Administrator Guide, and the manual included in the Driver CD Kit.

## Internet Fax Features

---

The following describes the Internet Fax features of the machine.

### Sending Internet Fax

The Internet Fax service allows you to send documents scanned by the machine as TIFF-format attachments to Internet Fax-compatible machines.

- Important**
- The TIFF file profiles that can be processed differ depending on the Internet Fax-compatible machine of the recipient. Confirm the profile that can be processed by the recipient's Internet Fax-compatible machine before specifying a profile. For more information, refer to "Sending Internet Fax" (P.154). For information on profiles, refer to "Internet Fax Profile (Specifying Internet Fax Profiles)" (P.196).
  - If a document is sent to a computer using the Internet Fax service, it cannot be opened in some cases. When you send a document to a computer, use the E-mail service.

#### ■ Using Direct Internet Fax feature

You can send an Internet fax directly to the Internet Fax-compatible machines without going through the SMTP server.

- Note**
- You can switch between Internet Fax and Direct Internet Fax in the System Administration mode. These two features cannot be enabled simultaneously. For information on how to switch them, refer to "5 Tools" > "Fax Service Settings" > "Internet Fax Control" > "Internet Fax Path" in the Administrator Guide.

#### ■ Registering e-mail addresses in address numbers

Once you register a recipient's e-mail address in an address number, you do not need to enter the e-mail address each time you send Internet Fax to the recipient.

- Note**
- To address numbers, you can also register the Internet Fax profile and other settings required for transmission.

For information on how to register address numbers, refer to "5 Tools" > "Setup" > "Add Address Book Entry" in the Administrator Guide.

### ■ Using the Broadcast Send feature

You can send an Internet fax to multiple destinations by specifying multiple e-mail addresses. Also, you can mix regular fax recipients and Internet Fax recipients to send a broadcast transmission for fax and Internet Fax.

**Note** • Up to three broadcast transmissions can be performed. The subsequent jobs will be sent in the sequential order after the former jobs are finished.

For information on how to specify recipients, refer to "Step 3 Specifying Destinations" (P.145) and "Specifying a Destination Using the Address Book" (P.165).

### ■ Forwarding files stored in folders

By enabling the forwarding feature and registering a forwarding e-mail address for a folder in advance, the faxes stored in the folder are automatically forwarded to the specified computer, as e-mail attachments. The user, therefore, does not need to walk up to the machine to pick up the faxes.

For more information, refer to "Forwarding Files Stored in a Folder" (P.158).

### ■ Sending Internet Fax to regular fax machines via a relay station

By specifying e-mail addresses in a specific format, you can send faxes from the machine on the network via an Internet Fax-compatible machine (fax gateway) to fax machines that do not support the Internet Fax service.

**Important** • This feature is available only when the e-mail reception method on the fax gateway is set to SMTP.

For information on the fax gateway feature, refer to "Sending Internet Fax to regular fax machines via a relay station" (P.157).

### ■ Precautions when sending Internet Fax

The message "Files Sent" displayed on the [Job Status] screen of the machine, a Job History Report, and a Transmission Report indicates that the transmission to the SMTP server configured on the machine has been successful. The Internet Fax transmission to the recipient may not complete if there is a problem on the Internet. In such case, the machine will not be notified of such transmission error. After sending an important e-mail, we suggest that you confirm it is received, such as by calling the recipient.

You can receive an e-mail of the transmission result if you set Read Receipts and Delivery Receipt when transmitting. For more information, refer to "Acknowledgement Report (Confirming Transmission Results)" (P.179).

## Receiving Internet Fax (Printing Internet Fax)

The machine automatically prints Internet Fax documents that are sent by e-mail from an Internet Fax-compatible machine.

**Note** • The following TIFF file formats and profiles are available for e-mail reception. File format: TIFF-FX (RFC2301) Profile: TIFF-S, TIFF-F, TIFF-J, and TIFF-C. If an unsupported profile is received, the machine may not be able to print the file. For more information, refer to "Receiving Internet Fax" (P.155).

## Restrictions on the E-mail Server

Depending on the system environment, such as restrictions on the e-mail server, large-size e-mails cannot be sent or received. Before you set the data-split feature, therefore, check the system environments of the sending and receiving ends.

If data is split into multiple data but each data size is still too large, change the image quality or resolution of each data to make its size even smaller.

## Features Unavailable for Sending Internet Fax

The following features are available for regular fax transmission, but are not available for Internet Fax transmission.

- Starting Rate
- Priority Send
- Delay Start
- Cover Page
- Recipient Print Sets
- F Code
- Remote Folder
- Remote Polling
- Manual Send
- Relay Broadcast
- Sorting received faxes by folder (Folder Selector)
- Direct Fax

If you are using the fax gateway feature, you can set Starting Rate and F Code. For more information on the fax gateway feature, refer to "Sending Internet Fax to regular fax machines via a relay station" (P.157).

## Sending Internet Fax

The following describes how to send Internet Fax.

**Important** • The Cc, Bcc, and Reply To features are not available for Internet Fax.

**Note** • The machine converts documents to the TIFF format and then sends them as e-mail attachments.

**1** Select [Internet Fax].

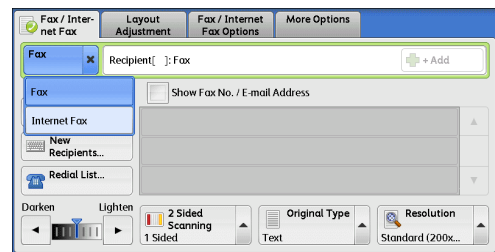

**2** Select [New Recipients].

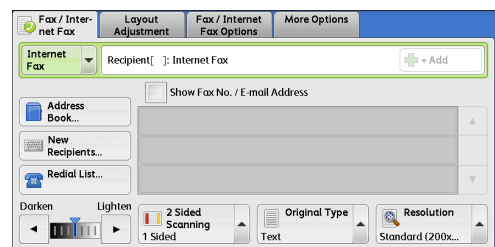

- 3** Specify a recipient with up to 128 characters using the keyboard displayed on the touch screen.

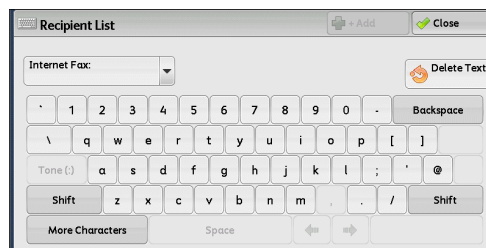

- Important**
- If you specify a fax number, the data will not be sent.
  - To specify an e-mail address for Direct Internet Fax, use the following format:
    - When specifying a host name, enter FQDN to the right of the @ symbol.  
Example: local-part@device.domain.com
    - When specifying an IP address, enter the IP address with brackets ("[" , "]" ) to the right of the @ symbol.  
Example: local-part@[192.168.0.101]
- Note**
- You can use address numbers, group dial numbers, or the Address Book to specify e-mail addresses. For more information, refer to "Speed Dialing (Specifying a Destination Using an Address Number)" (P.167) and "Specifying a Destination Using the Address Book" (P.165).

- 4** Enter a subject and message if necessary.

For information on how to enter the subject, refer to "Internet Fax Subject (Specifying the Internet Fax Subject)" (P.187). For information on how to enter the message, refer to "Internet Fax Message (Editing the Internet Fax Mail Contents)" (P.187).

- Note**
- If the hard disk of the machine becomes full during scanning of a document, a screen appears to prompt you to select whether to send the job up to the stored pages or to cancel the job. Select one of the processes.
  - If the hard disk of the machine becomes full during Internet Fax transmission, the transmission is canceled and the document data is deleted.
  - If TIFF-J is specified for the profile, the recipient's computer may not be able to display the attached TIFF file properly. In this case, specify the TIFF-S or TIFF-F profile.
  - If the Internet Fax-compatible machine of a recipient is not the same model as this machine, it may not print data received from this machine. Confirm the Internet Fax features supported by the destination machine before sending data to it.
  - When specifying an address from the Address Book for Internet Fax, check if the address contains a domain that is not permitted for use. In this case, the address cannot be used.

## Receiving Internet Fax

### ■Reception method

When the machine receives e-mail from an Internet Fax-compatible machine, the received document is printed automatically.

The machine also accepts e-mails addressed to folders on the machine, such as "BOX123@myhost.example.com".

For information on folders, refer to "5 Tools" > "Setup" > "Create Folder" in the Administrator Guide.

- Note**
- If domains for receiving e-mail are restricted by CentreWare Internet Services, you will only receive Internet Fax from the permitted domains. For information on the domain filtering, refer to "5 Tools" > "Connectivity & Network Setup" > "Other Settings" > "Domain Filtering" in the Administrator Guide.
  - You can confirm the domain setting status in a Domain Filter List. For information on the Domain Filter List, refer to "4 Machine Status" > "Machine Information" > "Print Reports" in the Administrator Guide.

### ■Printing size

Internet Fax documents received on the machine are printed at the same size as the original documents of the senders.

**Note** • When [TIFF-S] is selected for the profile, the printing size will be A4.

When the loaded paper is not the same size as the sent document or when the paper tray used for printing received documents is restricted, the receiving process will be the same as that for regular faxes.

### ■Receiving e-mail

Each e-mail header and attachment (TIFF file) of received e-mail will be printed.

- Split documents sent by e-mail

If a document scanned by the machine is split into segments according to the [Maximum Number of Pages per Split Send] setting made with CentreWare Internet Services, each segment will be treated as individual e-mail and attached with the details of split data.

- Attachments (TIFF format)

If an unsupported attachment file is received, the file is deleted. You can confirm the error in a Job History Report.

- When the folder number is not registered

If the specified folder is not registered, the received data is deleted. You can confirm the cause of the problem in a Job History Report.

- Folder operations

If the hard disk space of the machine is insufficient while printing e-mail or storing e-mail to the folder, the page being processed will be deleted at the point in time when the machine runs out of hard disk space.

### ■Restricting incoming e-mail

The machine can be configured to accept or reject e-mails received from specified domains. This feature is called "Domain Filtering". You can register up to 50 domains as permitted or rejected domains.

When receiving an e-mail, the machine checks the Domain Filtering settings. If the domain is registered as a rejected domain, or if the domain is not registered as an accepted domain, the machine will not receive the e-mail. You can confirm the result in the Job History Report. The job history of any rejected e-mail is not stored.

For information on the Domain Filtering, refer to "5 Tools" > "Connectivity & Network Setup" > "Other Settings" > "Domain Filtering" in the Administrator Guide.

## Useful Features

---

### Using an E-mail Address to Send Internet Fax to a Folder

By specifying the e-mail address of a folder on this machine, you can send Internet Fax from an Internet Fax-compatible machine to the folder.

When Internet Fax data is received, the machine stores it in the target folder and prints a Folder Report.

This feature is available only when the recipient's machine can receive e-mail via SMTP. To use this feature, the recipient's machine must have a folder that does not have a passcode. For information on how to create a folder, refer to "5 Tools" > "Setup" > "Create Folder" in the Administrator Guide.



1 Select [Internet Fax].

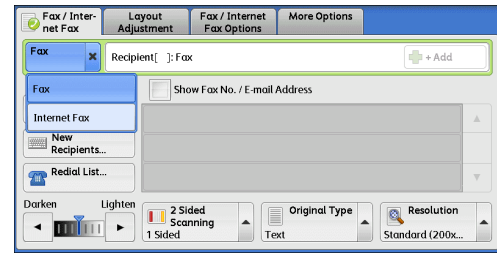

2 Select any option.

3 Enter the e-mail address of the target folder in the following format:

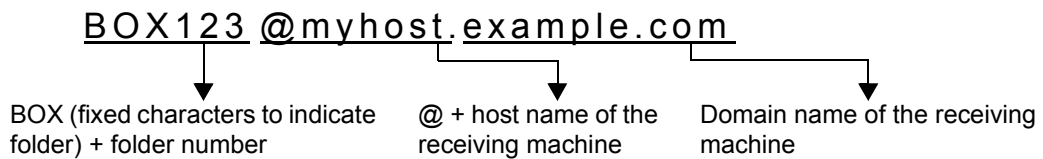

Example Folder number ..... 123  
 (Enter the digits of the folder number to match those of the recipient)  
 Host name of the receiving machine ..... myhost  
 Domain name of the receiving machine ..... example.com

- Important** • If the hard disk of the machine becomes full during Internet Fax transmission, the transmission is canceled and the document data is deleted.
- Note** • If the hard disk of the machine becomes full during scanning of a document, a screen appears to prompt you to select whether to send the job up to the stored pages or to cancel the job. Select one of the processes.

### Sending Internet Fax to regular fax machines via a relay station

By specifying e-mail addresses in a specific format, you can send a document to regular fax machines (that do not support the Internet Fax service) via a network.

This feature enables the machine to first send a document to an Internet Fax-compatible machine (fax gateway) by e-mail via the Internet. The e-mail document is then converted to a fax document on the Internet Fax-compatible machine, and is forwarded to its destinations. If you locate the fax gateway and regular fax machines within an area where the same local rate applies, the fax transmission costs can be reduced.

- Important** • This feature is available only when the fax gateway can receive e-mail via SMTP.
- Note**
- The e-mail received by the fax gateway is deleted even if the fax was not correctly sent.
  - The setting specified in [Starting Rate] on the [Fax/Internet Fax Options] screen is used as the communication mode from the fax gateway to the destination fax machine.
  - You can restrict fax forwarding in [Fax Transfer from Address Book] and [Fax Transfer Maximum Data Size] in the System Administration mode.

1 Select [Internet Fax].

2 Select any option.

3 Enter the e-mail address of the receiving machine in the following format:

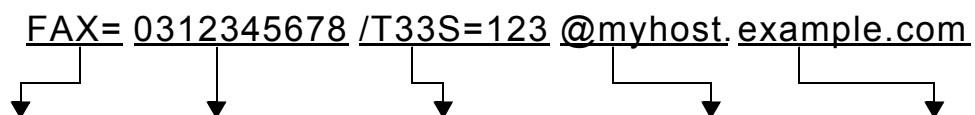

FAX= (fixed characters)	Fax number of the recipient	/T33S= (fixed characters) and F code (if necessary)	@ + host name of the machine that converts and sends the received e-mail as a fax.	Domain name
----------------------------	--------------------------------	-----------------------------------------------------------	------------------------------------------------------------------------------------------------	----------------

Example Fax number ..... 0312345678  
 F code (if necessary)..... /T33S=123  
 Host name of the receiving machine..... myhost  
 Domain name of the receiving machine..... example.com

**Important** • If the hard disk of the machine becomes full during Internet Fax transmission, the transmission is canceled and the document data is deleted.

**Note** • If the hard disk of the machine becomes full during scanning of a document, a screen appears to prompt you to select whether to send the job up to the stored pages or to cancel the job. Select one of the processes.

### Forwarding Files Stored in a Folder

You can automatically forward faxes stored in a folder, as e-mail attachments.

Faxes sent to folders using the fax signal method (proprietary communication procedures), F Code method, or DTMF method, and faxes stored in folders by the Folder Selector feature can be forwarded as e-mail attachments.

**Important** • This feature is available only when the mail receiving protocol is SMTP.

For information on how to forward files in a folder, send files to a folder, use the Folder Selector to receive files in a folder, and print or delete files received in a folder, refer to "Checking/Operating Files in a Folder" (P.293).

For information on how to set the Folder Selector feature, refer to "5 Tools" > "Fax Service Settings" > "Fax Received Options" in the Administrator Guide.

#### ■ Forwarding Internet Fax

The machine can automatically forward faxes received in a folder or faxes stored in a folder by using the Folder Selector feature to the forwarding address specified for the folder as e-mail.

With this forwarding feature, you can receive Internet Fax documents on your computer without having to walk up to the machine to pick them up. You can also save paper by displaying the documents on your computer screen.

#### ■ How to forward Internet Fax

The following operations are required for using the forwarding feature of Internet Fax.

- On the machine sending a fax

Sending faxes to the folder using the fax signal method (proprietary communication procedure), F Code method, or DTMF method.

For information on the transmission method, refer to "More Options" (P.199).

- On the machine receiving the fax in a folder and forwarding an Internet fax

Creating a job flow sheet to specify a forwarding address and then making a link between the job flow sheet and the folder.

For information on how to create a job flow, refer to "5 Tools" > "Setup" > "Create Job Flow Sheet" in the Administrator Guide.

**Important** • Do not set the address of the machine as the forwarding address.

**Note** • You can register up to 100 forwarding addresses.

- [Folder Number] and [Passcode] are required by the sender. Inform the sender of the settings.
- If the fax you received is a JBIG-compressed image, and if the Internet Fax profile of the forwarding destination is set to TIFF-F, the image is converted into MH format when forwarding. Also, if the Internet Fax profile is TIFF-S, the fax image is forwarded as is without changing the size and resolution settings.
- If the hard disk in the machine becomes full while the machine is receiving an Internet fax, the reception is canceled and the partly received file is deleted.
- If there is a problem with the data during Internet Fax forwarding, the forwarding is canceled and the received file is stored in the folder.
- If forwarding using SMTP fails, the received file is stored in the folder.
- You can confirm the forwarding result in a Job History Report.

## Simple Fax

You can select [Fax/Internet Fax] or [Simple Fax] on the [Services Home] screen to set the features for the Fax service.

This section describes the features you can select on the [Simple Fax] screen. [Simple Fax] allows you to use only basic features to easily send faxes. The following shows the reference section for each feature.

Specifying a Destination Using the Numeric Keypad .....	160
Speed Dialing (Specifying a Destination Using an Address Number) .....	161
Resolution (Specifying the Scanning Resolution) .....	162
Original Type (Selecting the Document Type) .....	162
2 Sided Scanning (Transmitting 2-sided Originals) .....	163

- 1 Select [Simple Fax] on the [Services Home] screen.

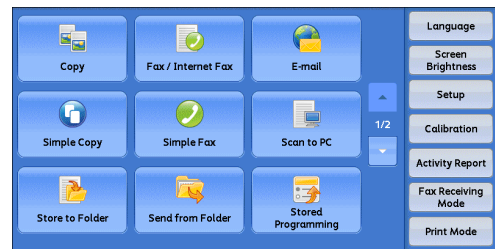

- 2 Select a feature on the [Simple Fax] screen.

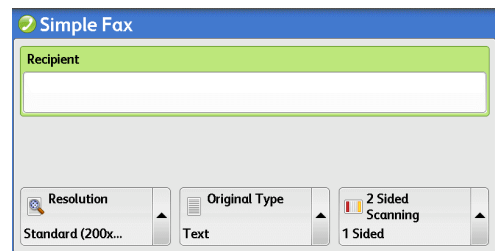

- Note**
- For the Simple Fax service, you can only set [Resolution], [Original Type], and [2 Sided Scanning]. In addition, when you use this service, [Mixed Size Originals] is set to [On], and [Transmission Header Text] is set to [Display Header]. If you want to set the other options, use [Fax/Internet Fax] on the [Services Home] screen to send faxes.
  - You cannot switch between [Fax/Internet Fax] and [Simple Fax]. To switch one to another, you must return to the [Services Home] screen. Once you return to the [Services Home] screen, the settings you have made in [Fax/Internet Fax] or [Simple Fax] will be cleared.

## Specifying a Destination Using the Numeric Keypad

Specify a destination using the numeric keypad.

- 1 Enter a fax number using the numeric keypad.

- Note**
- If you have entered an incorrect value, press the <C (Clear)> button and enter the correct value.

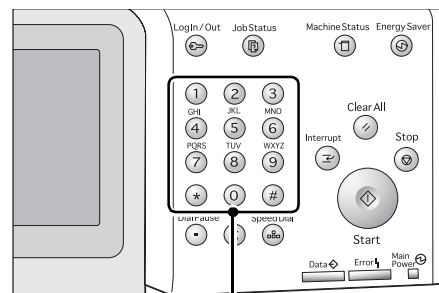

Numeric keypad

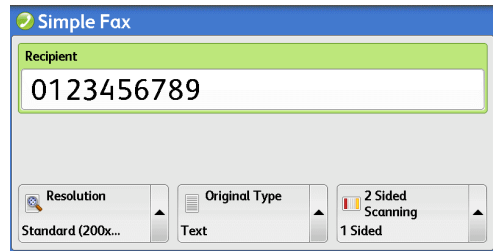

- 2 Press the <Start> button.

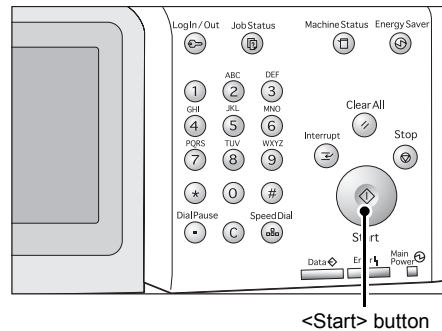

## Speed Dialing (Specifying a Destination Using an Address Number)

You can use address numbers to specify recipients. Register the address numbers for speed dialing in advance.

When you specify address numbers, confirm that the corresponding fax numbers are correctly registered on the machine. For information on how to register address numbers, refer to "5 Tools" > "Setup" > "Add Address Book Entry" in the Administrator Guide.

- Note**
- If you have entered an incorrect value, press the <C (Clear)> button and enter the correct value.
  - You can specify only fax recipients using address numbers for the Simple Fax feature. The numbers registered for the Internet Fax feature cannot be specified.

- 1 Press the <Speed Dial> button, and enter a 4-digit address number.

- Note**
- If you have entered an incorrect value, press the <C (Clear)> button and enter the correct value.

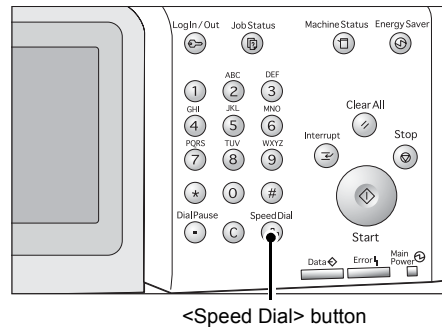

- 2 Press the <Start> button.

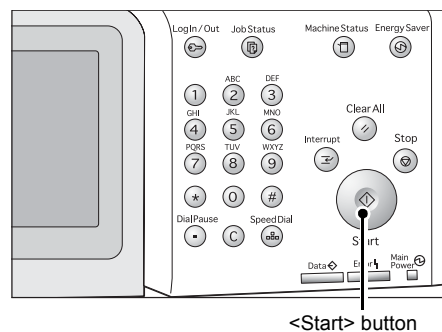

- 3 Confirm the destination displayed on the touch screen, and then select [Yes].

## Resolution (Specifying the Scanning Resolution)

You can set the resolution for the documents to be scanned.

- Note**
- The machine scans a document at the specified resolution, but if the recipient's machine does not support the resolution, the machine automatically changes the resolution to one supported by the recipient's machine and there is a corresponding loss in quality.
  - The higher the resolution, the lower the transmission speed. Usually, we recommend that you select [Superfine (400 dpi)] or lower.

You can specify the resolution for each address number. For information on how to register address numbers, refer to "5 Tools" > "Setup" > "Add Address Book Entry" in the Administrator Guide.

**1** Select [Resolution].

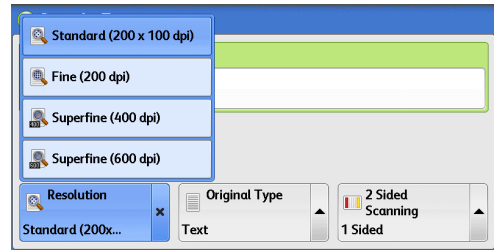

**■Standard (200 x 100 dpi)**

Select this option when transmitting standard documents.  
(200 x 100 pels/25.4 mm)

**■Fine (200 dpi)**

Select this option when transmitting documents with small text or detailed images.  
(200 x 200 pels/25.4 mm)

**■Superfine (400 dpi)**

Select this option when transmitting documents with fine images.  
(400 x 400 pels/25.4 mm)

**■Superfine (600 dpi)**

Select this option when transmitting documents with extremely fine images.  
(600 x 600 pels/25.4 mm)

## Original Type (Selecting the Document Type)

You can select the type of the original document, such as text and photo documents.

**1** Select [Original Type].

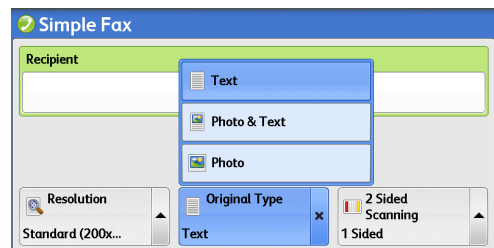

**■Text**

Select this option when transmitting a document that contains only text.

### ■Photo & Text

Select this option when transmitting a document that contains both text and photos. The machine automatically distinguishes the text and photo areas and sets the appropriate image quality for each area of the document.

### ■Photo

Select this option when transmitting a document that contains only photos.

**Note** • If reduced in size, the scan documents may have stripes in their photo areas.

## 2 Sided Scanning (Transmitting 2-sided Originals)

You can scan a 1-sided or 2-sided document on one or both sides of paper for fax transmission.

**Note** • The image on the back side of a 2-sided document is rotated so that it is placed in the same orientation as the image on the front side.

**1** Select [2 Sided Scanning].

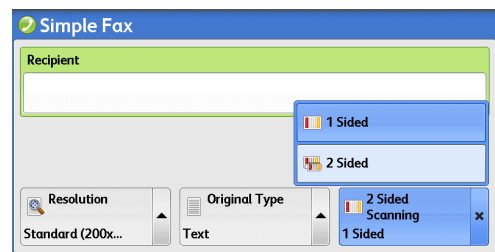

### ■1 Sided

Select this option to scan one side of the document.

### ■2 Sided

Select this option to scan both sides of the document.

## Fax/Internet Fax

You can select [Fax/Internet Fax] or [Simple Fax] on the [Services Home] screen to set the features for the Fax service.

This section describes the features you can select on the [Fax/Internet Fax] screen. The following shows the reference section for each feature.

Internet Fax/Fax (Selecting Internet Fax/Fax).....	164
+ Add (Sending Faxes to Multiple Recipients).....	165
Specifying a Destination Using the Address Book.....	165
Speed Dialing (Specifying a Destination Using an Address Number).....	167
Specifying a Destination Using the Keyboard Screen.....	168
Specifying a Destination Using the Redial Feature.....	168
Entering Specific Symbols.....	169
Removing/Confirming a Recipient.....	170
Lighten/Darken (Adjusting Fax Density).....	170
2 Sided Scanning (Transmitting 2-sided Originals).....	171
Original Type (Selecting the Document Type).....	172
Resolution (Specifying the Scanning Resolution).....	172

You can customize the layout of features displayed on the [Fax/Internet Fax] screen. For more information, refer to "5 Tools" > "Fax Service Settings" > "Screen Defaults" in the Administrator Guide.

- 1 Select [Fax/Internet Fax] on the [Services Home] screen.

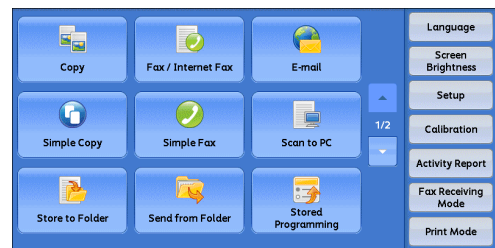

- 2 Select a feature on the [Fax/Internet Fax] screen.

### Internet Fax/Fax (Selecting Internet Fax/Fax)

You can switch between Internet Fax and Fax as necessary.

**Note** • This feature does not appear for some models. An optional component is required. For more information, contact our Customer Support Center.

- 1 Select [Fax] or [Internet Fax] from the drop-down menu.

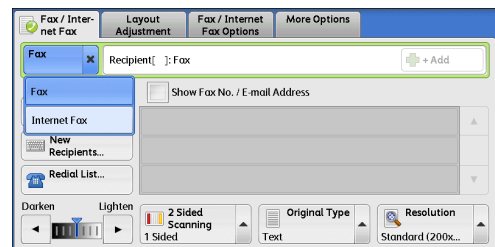



## + Add (Sending Faxes to Multiple Recipients)

The Broadcast Send feature allows you to transmit the same document to multiple recipients in a single operation. There is no need to repeat the same operation for each recipient.

If you specify Broadcast Send, the machine prints a Broadcast/Multi-Poll Report after the Broadcast Send operation finishes.

- Note**
- For Fax and Internet Fax, the maximum number of recipients that you can specify at one time is as follows:  
Using the numeric keypad only: 200 locations; using address numbers only: 600 locations; and using both the numeric keypad and address numbers: 600 locations.
  - When using Broadcast Send, the Cover Page and Remote Folder features are not available even if they are enabled on the control panel. If you want to use [Cover Page] and [Remote Folder], set them when registering each recipient in an address number.
  - You cannot specify [Confirmation Options].

### ■ Show Fax No./E-mail Address

If you select this check box, the recipient's name will not be displayed in the recipient field.

### ■ Enable Broadcast

To prevent missending a fax to multiple recipients, you can set whether to use Broadcast Send prior to specifying multiple recipients. Select the [Enable Broadcast] check box to specify multiple recipients.

[Enable Broadcast] is displayed only when [Broadcast Checkbox on 1st Tab] is set to [Enabled]. For more information on the setting, refer to "5 Tools" > "Fax Service Settings" > "Fax Control" > "Broadcast Checkbox on 1st Tab" in the Administrator Guide.

#### 1 Select the first recipient.

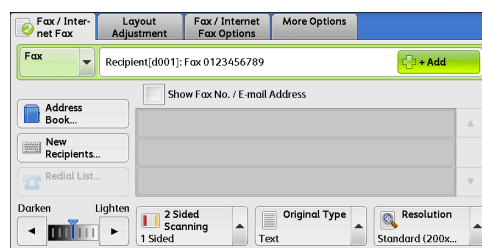

#### 2 Select [+ Add].

- Note**
- Depending on the settings, a screen to re-enter the recipient may be displayed after specifying the recipient and then selecting [+ Add] on the touch screen. In that case, re-enter the recipient.

#### 3 Select the next recipient.

#### 4 Repeat steps 2 and 3.

#### 5 Press the <Start> button.

#### 6 Select [Yes] on the confirmation screen to start transmission.

## Specifying a Destination Using the Address Book

The following describes how to use the Address Book to specify recipients.

The Address Book shows the fax numbers registered in the address numbers.

For information on how to register address numbers, refer to "5 Tools" > "Setup" > "Add Address Book Entry" in the Administrator Guide.

**1** Select [Address Book].

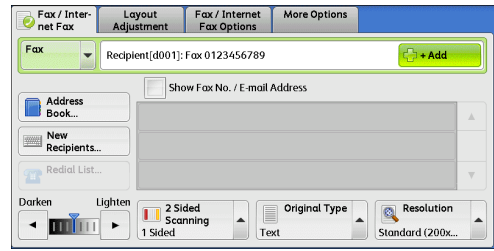

**2** Select the item you want to set for a recipient, and select [Add].

- Note**
- To specify multiple recipients, specify the recipients one after another.
  - To search fax numbers by other methods, select and switch to [List all public entries], [Retrieve fax entries using index], [List all group entries], or [Search Network] from the drop-down menu on the [Fax Address Book] screen. The methods that appear in the drop-down menu depend on the settings in the System Administration mode.
  - You can sort recipients in alphabetical order or address number order.
- Important**
- When specifying an address from the Address Book for Internet Fax, check if the address contains a domain that is not permitted for use. In this case, the address cannot be used.

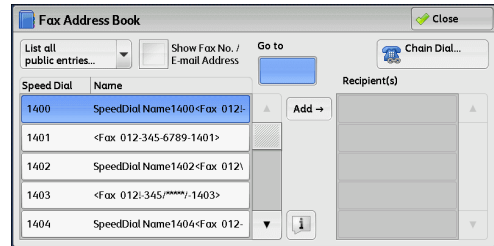

**Using the Address Book**

You can search for the fax numbers of recipients using [List all public entries], [Retrieve fax entries using index], [List all group entries], and [Search Network].

You can set the starting numbers of address numbers in the System Administration mode. For information on how to change the settings, refer to "5 Tools" > "Fax Service Settings" > "Screen Defaults" > "Address Book Speed Dial Default" in the Administrator Guide.

**■ List all public entries**

Displays the list of registered recipients. Select [▲] to return to the previous screen or [▼] to move to the next screen. Select items you want to set for a recipient, and select [Add].

**■ Retrieve fax entries using index**

Allows you to search for the fax numbers or group names of recipients using texts and numbers specified when registering address numbers. Select items you want to set for a recipient, and select [Add].

**■ List all group entries**

Allows you to search for the pre-registered group dial numbers. Select [▲] to return to the previous screen or [▼] to move to the next screen. Select items that you want to specify for a recipient, and select [Add].

For more information on how to register groups dial numbers, refer to "5 Tools" > "Setup" > "Create Fax Group Recipients" in the Administrator Guide.

**■ Search Network**

Allows you to search for fax numbers not in the local address book but the one registered in a server on a network. Set any items for [Name], [Fax Number], [Custom Item], and select [Search]. Select items you want to specify for a recipient, and select [Add].

**■Go to**

Enter the desired speed dial number with the numeric keypad. The corresponding address appears at the top of the list.

**■[1] button**

Select an item of which details you want to check, and select the [1] button.

**■Chain Dial**

Allows you to combine the fax numbers registered in speed dial and address book respectively and the numbers entered using the numeric keypad to specify as one recipient. You do not use the [+ Add] button.

**■Show Fax No./E-mail Address**

When you select this check box, the names of recipients will not be displayed in the recipient fields.

## Speed Dialing (Specifying a Destination Using an Address Number)

You can use address numbers to specify recipients. Register the address numbers for speed dialing in advance.

You can use wildcards (the <\*> button on the numeric keypad or [\*] on the keyboard screen) for the last digit or last two digits of address numbers.

The following tables show examples of using the wildcards to specify multiple recipients.

- When using a wildcard for the last digit

How to Enter Wildcard	Target Address Numbers	The Number of Target Addresses
000*	0001 - 0009	9
001*	0010 - 0019	10
010*	0100 - 0109	10
100*	1000 - 1009	10

- When using wildcards for the last two digits

How to Enter Wildcard	Target Address Numbers	The Number of Target Addresses
00**	0001 - 0099	99
01**	0100 - 0199	100
10**	1000 - 1099	100

When you specify address numbers, confirm that the corresponding fax numbers are correctly registered on the machine. For information on how to register address numbers, refer to "5 Tools" > "Setup" > "Add Address Book Entry" in the Administrator Guide.

- Note**
- The maximum number of recipients that you can specify at one time is as follows:  
Using address numbers only: 600 locations. Using the numeric keypad in combination with address numbers: 600 locations.

- An address number is always displayed in four digits. If [Auto Validation of Speed Dial Entry] is set to [Validate entry after a fixed time] in the System Administration mode, and for example when you enter "\*\*\*", "0" is automatically added to the beginning of the wildcards to display "00\*\*\*". For more information, refer to "5 Tools" > "Common Service Settings" > "Other Settings" > "Auto Validation of Speed Dial Entry" in the Administrator Guide.
- You can use wildcards only for the last digit or last two digits of address numbers. The following is not available: "\*100", "\*\*\*10", and "1\*00"

- 1 Press the <Speed Dial> button, and enter a 4-digit address number. Repeat this step for each additional recipient.

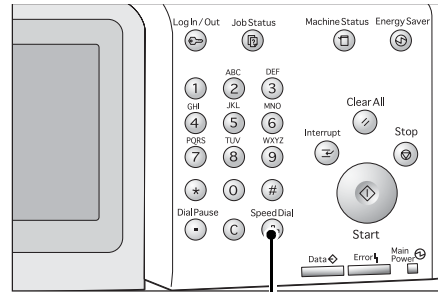

<Speed Dial> button

## Specifying a Destination Using the Keyboard Screen

You can specify recipients using the keyboard screen.

**Important** • When transmission to a certain recipient is prohibited in the System Administration mode, the [New Recipients] button cannot be used.

- 1 Select [New Recipients].

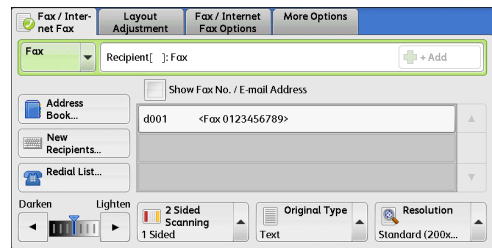

- 2 Specify a recipient with up to 128 characters using the keyboard displayed on the touch screen.



## Specifying a Destination Using the Redial Feature

You can specify recipients using the Redial feature.

**Important** • When transmission to a certain recipient is prohibited in the System Administration mode, the [Redial list] button cannot be used.

1 Select [Redial List].

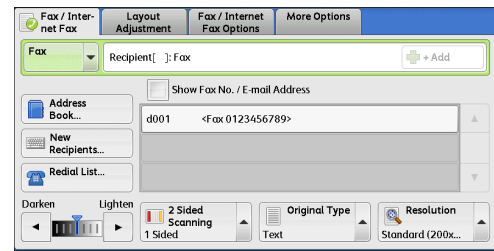

2 Select items you want to specify for a recipient, and select [Close].

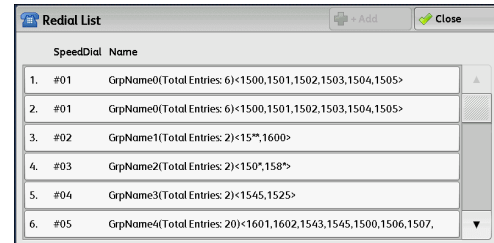

## Entering Specific Symbols

When specifying a recipient, you can use the following features to enter specific symbols on the touch screen.

Feature	Button	Function	Input method
Enter pause	- or <Pause> (-)	Used to enter a pause. One pause is 3 seconds. You can enter pauses of 6 seconds, 9 seconds, etc. with additional button presses.	Press the <Pause> button. (Example) 0-123 ... 0--123 ...
Transmit using a password	S	When a password has been set, transmission will start only if the password matches the ID number on the remote terminal.	1. Select [New Recipients] on the [Fax/Internet Fax] screen to display the keyboard. 2. Select [S]. (Example) 0312345678S12345678
Transmit DTMF signal	!	Used to transmit the DTMF signal.	1. Select [New Recipients] on the [Fax/Internet Fax] screen to display the keyboard. 2. Select [More Characters]. 3. Select [!]. (Example) 0311123456!123#

When using the DTMF method, use specific symbols. For information on the DTMF method, refer to "Remote Folder (Using Remote Folder)" (P.189) and "Broadcast" (P.205).

## Removing/Confirming a Recipient

You can remove or confirm recipients from the pop-up menu.

- 1 Select the recipient to be removed or confirmed from the selected recipients.

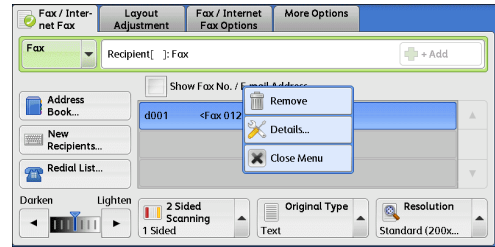

- 2 Select any option from the pop-up menu.

**■ Remove**

Removes the recipient.

**■ Details**

Displays the [Details] screen. You can confirm recipients or address numbers.

**■ Close Menu**

Hides the pop-up menu.

### [Details] Screen

This screen allows you to confirm recipients.

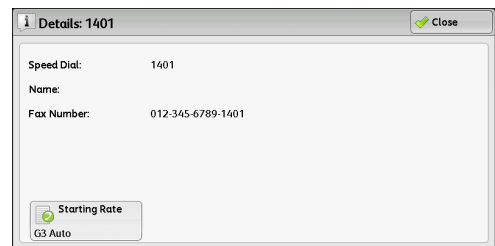

**■ Starting Rate**

Allows you to select a communication mode according to the features of a recipient's machine.

## Lighten/Darken (Adjusting Fax Density)

You can select fax density from seven levels.

- 1 Use [◀] and [▶] to select a density level.

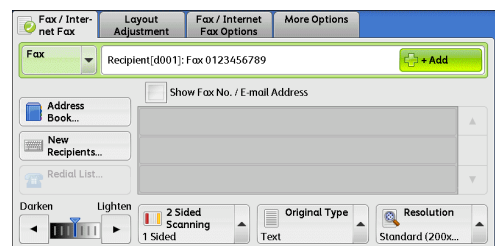

## 2 Sided Scanning (Transmitting 2-sided Originals)

You can scan a 1-sided or 2-sided document on one or both sides of paper for fax transmission.

- Note**
- The image on the back side of a 2-sided document is rotated so that it is placed in the same orientation as the image on the front side.

### 1 Select a scan option.

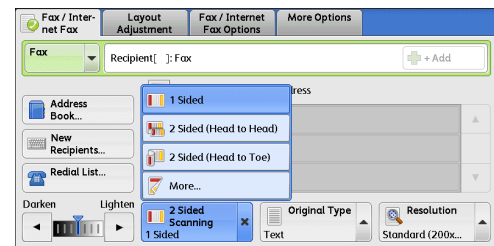

#### ■ 1 Sided

Select this option to scan one side of the document.

#### ■ 2 Sided (Head to Head)

Select this option when both sides of the 2-sided document are in the same orientation.

#### ■ 2 Sided (Head to Toe)

Select this option when both sides of the 2-sided document are in opposite orientations.

#### ■ More

Displays the [2 Sided Scanning] screen.

Refer to "[2 Sided Scanning] Screen" (P.171).

### [2 Sided Scanning] Screen

#### 1 Select whether the document is one-sided or two-sided. When [2 Sided] or [2 Sided (First Page 1 Sided)] is selected, also select the orientation of the document.

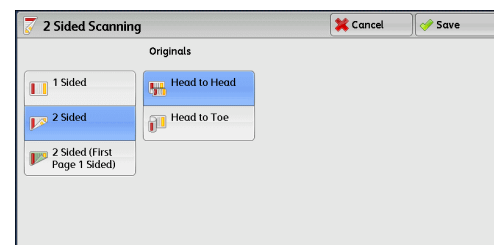

#### ■ 1 Sided

Select this option to scan one side of the document.

#### ■ 2 Sided

Select this option to scan both sides of the document.

#### ■ 2 Sided (First Page 1 Sided)

Select this option to scan the front side of the first page and both sides of the remaining pages. Use this option when the back side of the first page is blank.

**■Originals**

Select [Head to Head] when both sides of the documents are in the same orientation. Select [Head to Toe] when the front and back sides of the documents are in opposite orientations.

**Original Type (Selecting the Document Type)**

You can select the type of the original document, such as text and photo documents.

- 1 Select the original type.

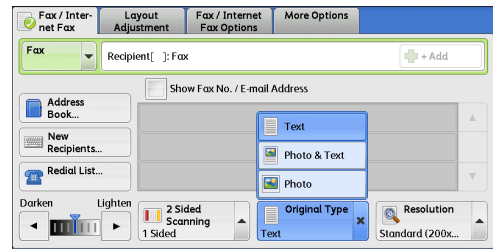

**■Text**

Select this option when transmitting a document that contains only text.

**■Photo & Text**

Select this option when transmitting a document that contains both text and photos. The machine automatically distinguishes the text and photo areas and sets the appropriate image quality for each area of the document.

**■Photo**

Select this option when transmitting a document that contains only photos.

**Note** • If reduced in size, the scan documents may have stripes in their photo areas.

**Resolution (Specifying the Scanning Resolution)**

You can set the resolution for the documents to be scanned.

- Note**
- The machine scans a document at the specified resolution, but if the recipient's machine does not support the resolution, the machine automatically changes the resolution to one supported by the recipient's machine and there is a corresponding loss in quality.
  - The higher the resolution, the lower the transmission speed. Usually, we recommend that you select [Superfine (400 dpi)] or lower.

You can specify the resolution for each address number. For information on how to register address numbers, refer to "5 Tools" > "Setup" > "Add Address Book Entry" in the Administrator Guide.

- 1 Select the resolution.

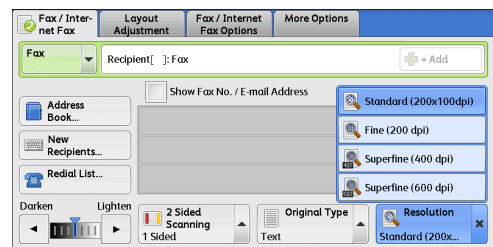

**■Standard (200 x 100dpi)**

Select this option when transmitting standard documents.

(Approx. 200 x 100 pels/25.4 mm)



■ **Fine (200 dpi)**

Select this option when transmitting documents with small text or detailed images.  
(Approx. 200 x 200 pels/25.4 mm)

■ **Superfine (400 dpi)**

Select this option when transmitting documents with fine images.  
(400 x 400 pels/25.4 mm)

■ **Superfine (600 dpi)**

Select this option when transmitting documents with extremely fine images.  
(600 x 600 pels/25.4 mm)

# Layout Adjustment

This section describes the features you can select on the [Layout Adjustment] screen. The following shows the reference section for each feature.

- 2 Sided Scanning (Transmitting 2-sided Originals).....174
- Original Size (Specifying the Scan Size for the Original).....174
- Mixed Size Originals (Scanning Different Size Documents Simultaneously) .....175
- Book Faxing (Scanning Facing Pages onto Separate Sheets).....176
- Reduce/Enlarge (Specifying a Scan Ratio).....177

- 1 Select [Fax/Internet Fax] on the [Services Home] screen.

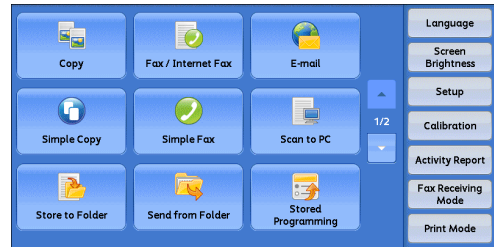

- 2 Select a feature on the [Layout Adjustment] screen.

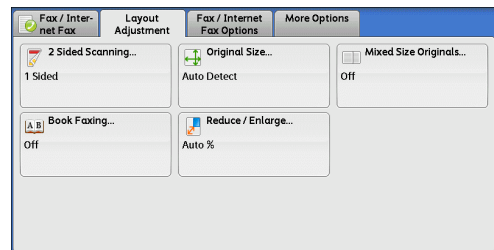

## 2 Sided Scanning (Transmitting 2-sided Originals)

This feature is the same as [2 Sided Scanning] on the [Fax/Internet Fax] screen. For more information, refer to "2 Sided Scanning (Transmitting 2-sided Originals)" (P.171).

## Original Size (Specifying the Scan Size for the Original)

You can specify the scan size for fax transmission.

Use this feature when a document is a non-standard size, or when you want to scan a document at a size different from the original size. You also can add margins, or delete unwanted margins.

You can change the default values for buttons other than [Auto Detect] in the System Administration mode. For information on how to change the default values, refer to "5 Tools" > "Fax Service Settings" > "Original Size Defaults" in the Administrator Guide.

- 1 Select [Original Size].

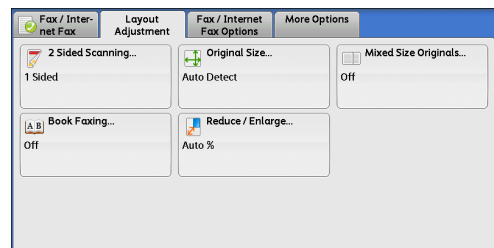

## 2 Select any option.

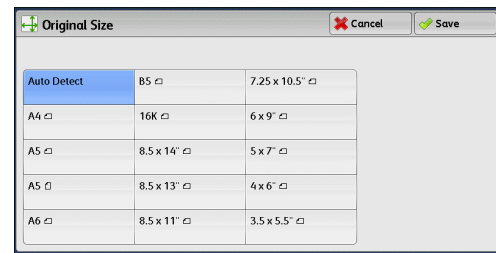

### ■Auto Detect

Detects the document size automatically.

	Document Feeder	Document Glass
<b>Auto-detectable Document size</b>	B5, A5, A5 <sup>l</sup> , A4, 8.5 x 11", 8.5 x 14"	B5, B6, B6 <sup>l</sup> , A6, A5, A5 <sup>l</sup> , A4, 16K

**Note** • If the document size cannot be detected automatically, a screen to enter the document size appears.

The document sizes that can be automatically detected depend on [Paper Size Settings] in the System Administration mode. For information on [Paper Size Settings], refer to "5 Tools" > "Common Service Settings" > "Other Settings" > "Paper Size Settings" in the Administrator Guide.

### ■Standard Size

Select the original size from preset sizes.

You can change the sizes displayed on the screen. For more information, refer to "5 Tools" > "Fax Service Settings" > "Original Size Defaults" in the Administrator Guide.

## Mixed Size Originals (Scanning Different Size Documents Simultaneously)

You can scan documents of various sizes simultaneously and send faxes using each size or a single size of paper. To use this feature, load the documents in the document feeder.

**Important** • When loading documents, align the top left corners of the documents properly. Otherwise, a paper jam may occur.

- The recommended document size combinations are A5 portrait and A4 landscape. If another combination of document sizes is used, the documents can be fed at an angle and may not be scanned properly.

**Note** • Be sure to set [Original Size] to [Auto Detect] on the [Layout Adjustment] screen, when using the Mixed Size Originals feature.

## 1 Select [Original Size].

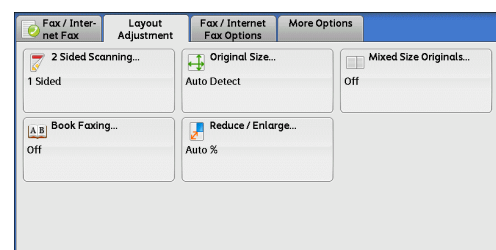

- 2 Confirm that [Auto Detect] is selected, and select [Save]. If [Auto Detect] is not selected, select [Auto Detect] and then [Save].

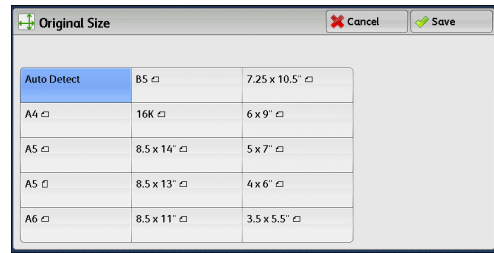

- 3 Select [Mixed Size Originals].

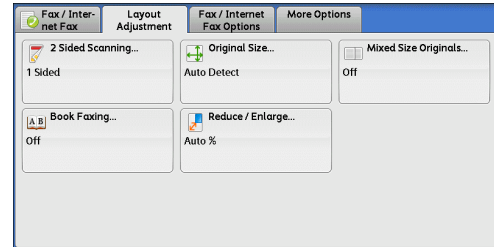

- 4 Select [On].



■ **Off**

Select this option when all documents are of the same size.

■ **On**

When scanning documents of different sizes, the machine automatically detects the size of each document.

## Book Faxing (Scanning Facing Pages onto Separate Sheets)

You can scan the left and right pages of a bound document separately to fax them. This feature is useful if you want to separately scan facing pages of a bound document.

- Note**
- You cannot use the document feeder with this feature.
  - A non-standard size document or undetectable-size document may not be separated into two accurately.

- 1 Select [Book Faxing].

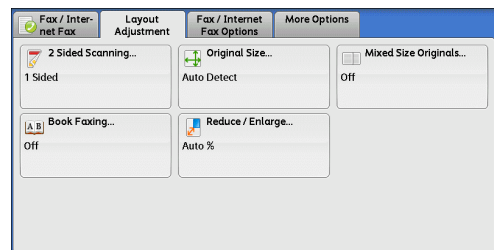

## 2 Select any option.

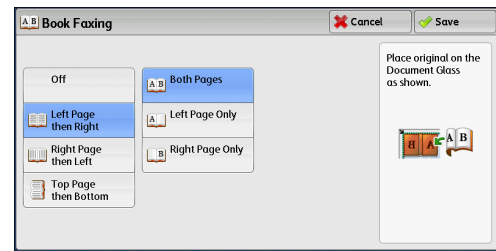

### ■ Off

Does not scan as a bound document.

### ■ Left Page then Right

Scans the left page and then the right page of facing pages.

### ■ Right Page then Left

Scans the right page and then the left page of facing pages.

### ■ Top Page then Bottom

Scans the top page and then the bottom page of facing pages.

### ■ Both Pages

Scans both pages in page order.

### ■ Left Page Only

Scans the left page only. You can select this option when [Left Page then Right] or [Right Page then Left] is selected.

### ■ Right Page Only

Scans the right page only. You can select this option when [Left Page then Right] or [Right Page then Left] is selected.

### ■ Top Page Only

Scans the top page only. You can select this option when [Top Page then Bottom] is selected.

### ■ Bottom Page Only

Scans the bottom page only. You can select this option when [Top Page then Bottom] is selected.

## Reduce/Enlarge (Specifying a Scan Ratio)

This feature enlarges or reduces scanned images with a specified ratio.

**Important** • Some destination machines may not be able to receive faxes at the specified ratio.

**1** Select [Reduce/Enlarge.]

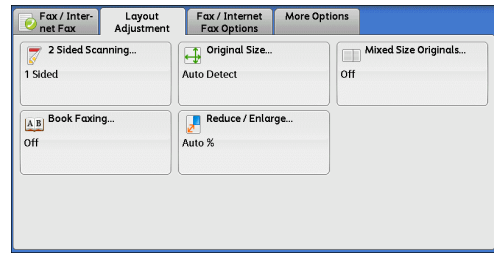

**2** Select a preset ratio, or specify a value.

**Note** • If a magnification is specified in [Reduce/Enlarge], [Rotate 90 degrees] does not function.

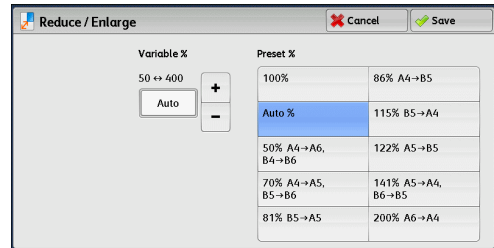

**Variable %**

Specify a ratio in the range from 50 to 400% in 1% increments. To specify a value, use the numeric keypad or [+] and [-].

**Preset %**

- 100%  
Scans at the same size as the original.
- Auto %

If the scan width of the document exceeds the maximum image size, the scanned image is rotated or reduced to fit the maximum size.

When the speed dialing is used, the maximum image size will be the size registered in the Address Number. When speed dialing is not used, the maximum size will be A4.

**Note** • You can specify whether to rotate documents in the System Administration mode. For more information, refer to "5 Tools" > "Fax Service Settings" > "Fax Control" > "Rotate 90 degrees" in the Administrator Guide.

- Preset ratios  
Select from preset scan ratios.

You can change the default values of scan ratios other than [100%] and [Auto %]. For more information, refer to "5 Tools" > "Fax Service Settings" > "Reduce/Enlarge Presets" in the Administrator Guide.

## Fax/Internet Fax Options

This section describes the features you can select on the [Fax/Internet Fax Options] screen. The following shows the reference section for each feature.

Acknowledgement Report (Confirming Transmission Results) .....	179
Starting Rate (Selecting a Communication Mode) .....	181
Priority Send/Delay Start (Specifying Send Priority/Send Time).....	182
Transmission Header Text (Adding Sender Name and Phone Number to Faxes).....	184
Cover Page (Transmitting Documents With a Cover Page) .....	185
Internet Fax Subject (Specifying the Internet Fax Subject) .....	187
Internet Fax Message (Editing the Internet Fax Mail Contents).....	187
Recipient Print Sets (Printing Multiple Sets at the Remote Machine).....	188
Pages per Side (Combining Multiple Pages into One Sheet).....	189
Remote Folder (Using Remote Folder).....	189
F Code (Using F Code Transmission).....	192
Internet Fax Profile (Specifying Internet Fax Profiles).....	196
Encryption (Sending Internet Fax Encrypted by S/MIME) .....	197
Digital Signature (Sending Internet Fax with a Digital Signature by S/MIME).....	198

- 1 Select [Fax/Internet Fax] on the [Services Home] screen.

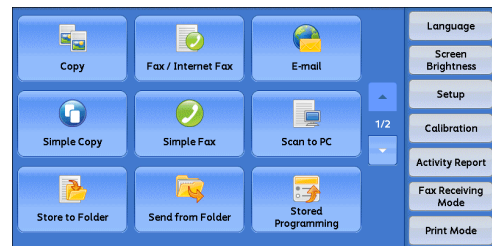

- 2 Select a feature on the [Fax/Internet Fax Options] screen.

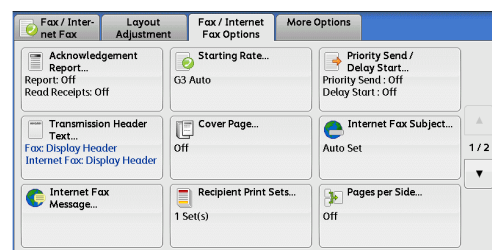

## Acknowledgement Report (Confirming Transmission Results)

You can check fax and Internet Fax transmission results.

To receive fax transmission results, select [On] in [Confirmation Options] on the [Acknowledgement Report] screen. By enabling this feature, the machine automatically prints a Transmission Report when fax transmission completes successfully, and prints a Transmission Report - Job Undelivered when fax transmission ends unsuccessfully.

To confirm Internet Fax transmission results, the following two types are available: [Read Receipts] and [Delivery Receipts].

Selecting [Delivery Receipts] allows you to check whether or not the Internet Fax you sent was delivered successfully to the recipient's folder.

Selecting [Read Receipts] allows you to check whether or not the Internet Fax you sent was correctly delivered and the attached files were correctly processed.

- Note**
- The optional component is required to use the Read Receipts and Delivery Receipts features. For information, contact our Customer Support Center.
  - Read Receipts (MDN) and Delivery Receipts (DSN) are available when the recipient's machine supports MDN and DSN, respectively.
  - You can select either [Read Receipts] or [Delivery Receipts] in the System Administration mode. For more information, refer to "5 Tools" > "Fax Service Settings" > "Internet Fax Control" > "Delivery Confirmation Method" in the Administrator Guide.
  - You can only use the Delivery Receipts (DSN) feature to check the delivery of e-mail to servers that support this feature. Furthermore, if any of the e-mail servers on the transmission route do not support DSN, you cannot verify the delivery of the e-mail, even if the e-mail has been delivered successfully. For this reason, the result of the Delivery Receipts may differ from the actual delivery status.
  - If [Confirmation Options] is set to [On] and the transmission completes unsuccessfully, a Transmission Report - Job Undelivered will be printed.

The following procedure uses the Read Receipts feature as an example. The procedure is the same for the Delivery Receipts feature.

**1** Select [Acknowledgement Report].

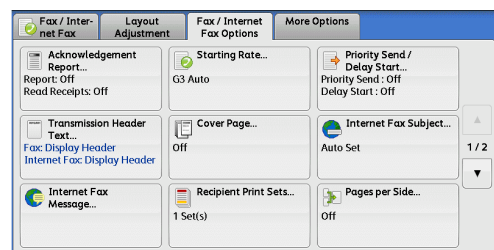

**2** Select any option.

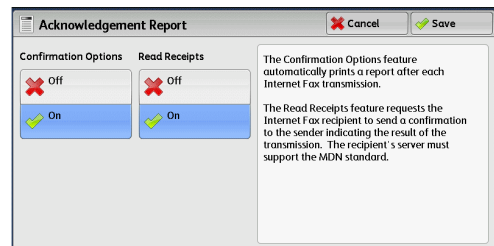

**■Confirmation Options**

- Off  
No Transmission Report is printed.
- On  
A Transmission Report is automatically printed when the transmission completes successfully. If the transmission does not end successfully, a Transmission Report - Job Undelivered is printed.

**■Read Receipts**

- Off  
Disables the Read Receipts feature.
- On  
Enables the Read Receipts feature. You can check whether the Internet Fax you sent was correctly delivered and the attached files were correctly processed.

**■Delivery Receipts**

- Off



Disables the Delivery Receipts feature.

- On

Enables the Delivery Receipts feature. You can check whether the Internet Fax you sent was correctly delivered to the destination folder.

## Starting Rate (Selecting a Communication Mode)

You can select a communication mode based on the features of the remote machine.

G3 is the international standard for facsimile transmissions established by the ITU-T.

When you use speed dialing, group dial number or address book to specify a recipient registered in an address number, the communication mode currently set to the address number is set and cannot be changed. For information on how to register address numbers, refer to "5 Tools" > "Setup" > "Add Address Book Entry" in the Administrator Guide.

You can change the default mode of [Starting Rate] in the System Administration mode. For information on how to change the default mode, refer to "5 Tools" > "Fax Service Settings" > "Fax Defaults" > "Starting Rate" in the Administrator Guide.

- 1 Select [Starting Rate].

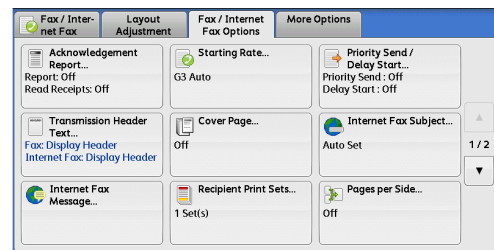

- 2 Select any option.

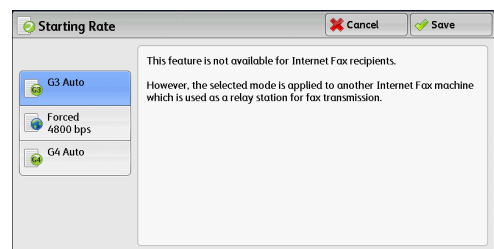

### ■G3 Auto

Select this mode if the remote machine is G3 compatible. This mode is normally selected.

Depending on the reception capabilities of the remote machine, the machine automatically switches modes in the following order: G3 Unique ECM → G3 Unique → ITU-T G3 ECM → ITU-T G3.

### ■Forced 4800 bps

Select this mode when transmitting over noisy or poor telephone lines, as can be the case with overseas calls.

Also select this mode when transmitting over noisy or poor telephone lines domestically.

## About Forced 4800 bps

You can communicate with faxes overseas via telephone company exchanges, etc.

- Note**
- The international telephone networks are originally designed for voice communications. Noise that does not really affect voice communications causes a problem with fax communications. It may result in the deterioration of images quality, the inability to transmit a

fax, or even terminate the transmission. Regardless of whether transmission is successful, you are charged for the call once the line is connected. For information on line trouble and call charges, contact your telephone company.

- If you select [Forced 4800 bps], the transmission time may be longer because transmission is performed at 4800 bps or less to ensure transmission is successful.

**1** Select [Starting Rate].

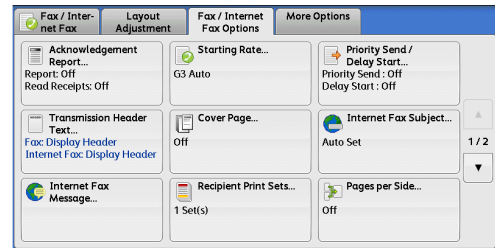

**2** Select [Forced 4800 bps], and then select [Save].

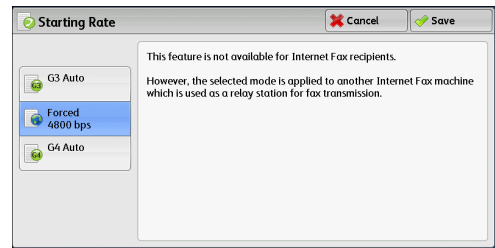

**3** Enter the recipient fax number in the same manner as when you make an international call.

The following is an example:

Telephone company ID	0	0	1	1	Country number	Area code	Fax number of the other party
----------------------	---	---	---	---	----------------	-----------	-------------------------------

- Important** • In some areas, you may need to enter a pause after the telephone company ID number.
- Note** • For information on the telephone company ID number, contact your telephone company.

## Priority Send/Delay Start (Specifying Send Priority/Send Time)

The Priority Send feature allows you to give priority to a fax or polling job over other jobs.

The Delay Start feature allows you to specify when to send your fax. This feature is useful for sending faxes when communication charges are low, such as during night time.

- Note**
- [Priority Send/Delay Start] is not available for Internet Fax.
  - [Priority Send] can be set in combination with [Delay Start]. If both features are set, Priority Send is performed at the time specified in [Delay Start].

**1** Select [Priority Send/Delay Start].

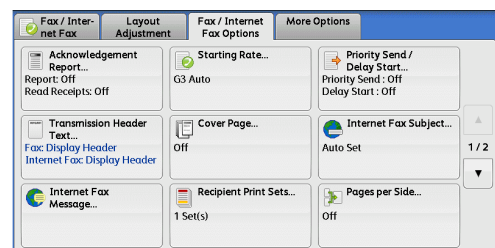

## 2 Select any option.

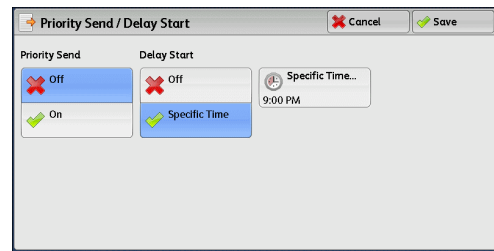

### ■ Priority Send

- Off

Priority Send is not applied.

- On

Priority Send is applied.

- Note**
- If the Priority Send feature is selected during transmission, the fax will be sent after the current transmission ends.
  - In redial mode, the fax will be resent preferentially after the specified redial interval.
  - The Priority Send feature cannot be set separately for each recipient of Broadcast and multipolling jobs.

You can give priority to a pending job. For more information, refer to "Job Status" (P.327).

### ■ Delay Start

- Off

Delay Start is not applied.

- Specific Time

Delay Start is applied.

- Note**
- You can specify a time within 24 hours in 1 minute increments. You cannot specify a date.
  - You can set [Delay Start] independently for each address number. For information on how to register address numbers, refer to "5 Tools" > "Setup" > "Add Address Book Entry" in the Administrator Guide.
  - If you use address numbers or group dial numbers to specify recipients for the Broadcast Send feature, the [Delay Start] setting specified for each address number is invalid.
  - If the fax cannot be sent at the specified time because, for example, the telephone line is busy, it will be sent as soon as the line becomes available.

### ■ Specific Time

Displays the [Delay Start - Specific Time] screen.

Refer to "[Delay Start - Specific Time] Screen" (P.183).

## [Delay Start - Specific Time] Screen

This screen allows you to specify the start time for fax transmission.

- Note**
- You can change the default value of [Specific Time] in the System Administration mode. For more information, refer to "5 Tools" > "Fax Service Settings" > "Fax Defaults" > "Delay Start - Specific Time" in the Administrator Guide.

1 Select [AM] or [PM].

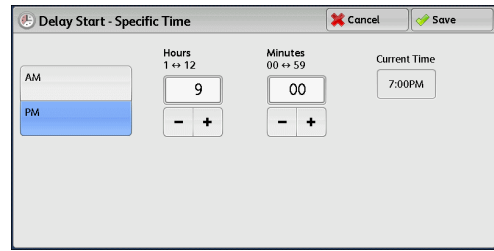

2 Set [Hours] and [Minutes].

**Important** • If you press the <Start> button after the specified time, the stored document will be sent at the specified time on the following day.

## Transmission Header Text (Adding Sender Name and Phone Number to Faxes)

The Transmission Header Text feature adds the start time, sender name, recipient name, G3 ID, and number of pages onto the transmitted document.

This feature enables the recipient to confirm when and from whom the fax was sent.

**Important** • Header information is printed at the top of the document, so an area of about 3 to 5 mm may not be printed at the top of each page at the remote machine.

- Note**
- If the document is resent, "Resend" is printed at the left of the date and time indication.
  - If this feature is enabled for Broadcast Send, header information is attached to faxes for all the recipients.
  - The start time is printed in the format set on the machine (12 or 24 hour clock). For information on how to set the time, refer to "5 Tools" > "Common Service Settings" > "Machine Clock/Timers" in the Administrator Guide.
  - The recipient name is only added if it has been registered in the address number.

For information on the sender name and G3 ID, refer to "5 Tools" > "Fax Service Settings" > "Local Terminal Information" in the Administrator Guide.

You can change the default value of [Transmission Header Text] in the System Administration mode. For information on how to change the default value, refer to "5 Tools" > "Fax Service Settings" > "Fax Defaults" > "Transmission Header Text" in the Administrator Guide.

1 Select [Transmission Header Text].

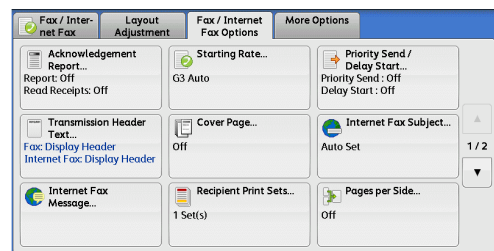

2 Select [Display Header].

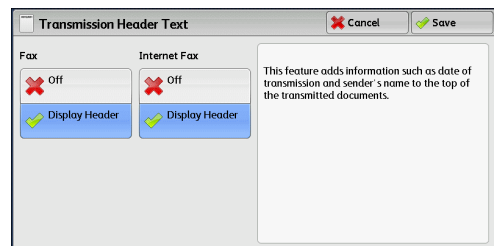

**Off**

No header information is attached.

**■Display Header**

Header information is attached.

**Cover Page (Transmitting Documents With a Cover Page)**

This feature allows you to attach a cover page to the document.

The cover page includes the recipient name, comment, sender name, machine fax number, number of pages, and date and time of transmission.

You can specify whether to attach a cover page for each address number. For information on how to register address numbers, refer to "5 Tools" > "Setup" > "Add Address Book Entry" in the Administrator Guide.

- Note**
- When [Transmission Header Text] is set, the header information is not printed on the cover page.
  - You cannot use the Cover Page feature for Broadcast transmission using the numeric keypad. To use this feature for Broadcast transmission, register recipients to address numbers.
  - The size and resolution of the cover page is based on the first page of the document.

**1** Select [Cover Page].

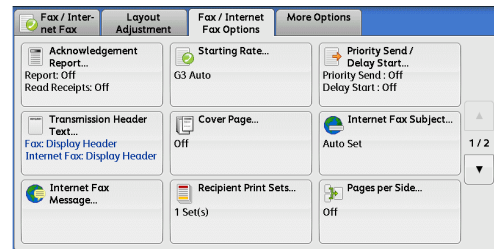

**2** Select [Print Cover Page].

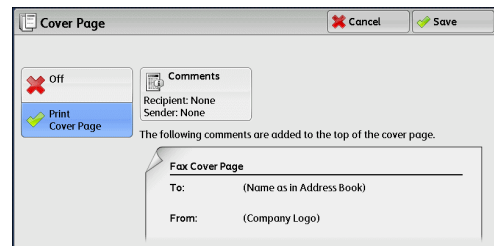

**■Off**

No cover page is attached.

**■Print Cover Page**

A cover page is attached.

**■Comments**

Displays the [Cover Page - Comments] screen.

Refer to "[Cover Page - Comments] Screen" (P.186).

## [Cover Page - Comments] Screen

This screen allows you to select comments to be added to the recipient and sender fields.

- 1 Select any option.

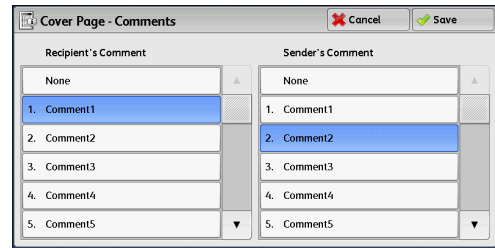

### ■Recipient's Comment

Displays the registered comments in the recipient field. Select a comment to be used. Select [None] when no comment is added to this field.

### ■Sender's Comment

Displays the registered comments in the sender field. Select a comment to be used. Select [None] when no comment is added to this field.

For information on how to register comments, refer to "5 Tools" > "Setup" > "Add Fax Comment" in the Administrator Guide.

## About the Cover Page

### ■To

When an address number is used, the recipient name registered for the address number is printed. This field is blank if no recipient name is registered for the address number.

### ■Recipient's Comment

Prints the comment selected in [Recipient's Comment].

### ■From

Prints the registered sender name.

### ■Sender's Comment

Prints the comment selected in [Sender's Comment].

### ■Fax Number

Prints the fax number of the machine. For G3 communications, "G3 ID" is printed.

### ■Number of Pages

Prints the number of pages.

### ■Send Date and Time

Prints the transmission date and time.

### ■Remarks

Prints remarks when the document is sent using Broadcast, Folder, Relay Broadcast, or Redial Mode.

## Internet Fax Subject (Specifying the Internet Fax Subject)

You can specify an Internet Fax subject. If no subject is specified, the preset subject is automatically entered.

**Note** • This feature is not available for some models. An optional component is required. For more information, contact our Customer Support Center.

**1** Select [Internet Fax Subject].

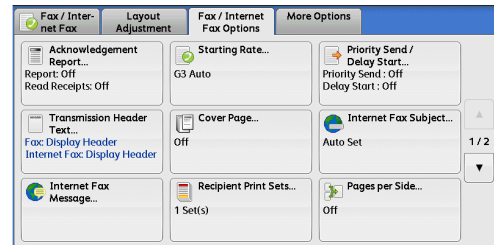

**2** Select [Keyboard].

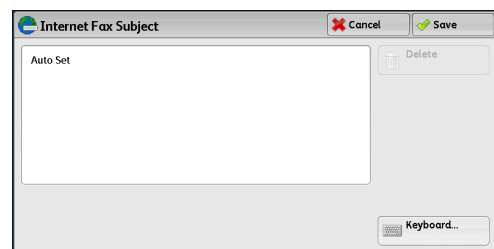

**3** Enter a subject with up to 128 characters using the displayed keyboard.

For information on how to enter characters, refer to "Entering Text" (P.58).

**Note** • If no subject is entered, the following will be automatically entered as a subject: [InternetFAX;<From> ; <Send Date and Time>].

## Internet Fax Message (Editing the Internet Fax Mail Contents)

You can edit Internet Fax comments. Enter text using the keyboard or use a pre-registered comment.

**Note** • This feature may not be available for some models. The optional component is required. For more information, contact our Customer Support Center.

For information on how to register comments, refer to "5 Tools" > "Setup" > "Add Fax Comment" in the Administrator Guide.

**1** Select [Internet Fax Message].

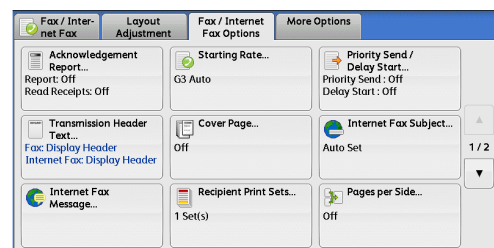

**2** Select any option.

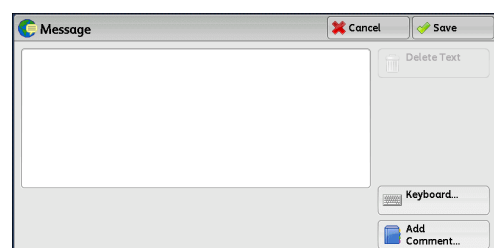

**■Delete Text**

Deletes the comment displayed on the screen.

**■Keyboard**

Allows you to enter body text using the displayed keyboard. Up to 256 characters can be entered.

You can also select [Add Comment] to select a registered comment and edit it.

For information on how to enter characters, refer to "Entering Text" (P.58).

**■Add Comment**

Allows you to insert a registered comment. Select this button to display the [Add Comment] screen.

Refer to "[Add Comment] Screen" (P.188).

**[Add Comment] Screen**

This screen allows you to select a comment to be added.

- 1 Select any option.

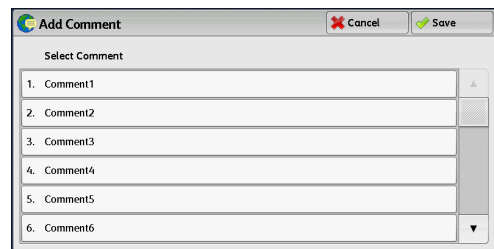

**■Select Comment**

Displays the registered comments.

For information on how to register comments, refer to "5 Tools" > "Setup" > "Add Fax Comment" in the Administrator Guide.

**Recipient Print Sets (Printing Multiple Sets at the Remote Machine)**

This feature allows you to print multiple sets of a fax document at the remote machine.

- 1 Select [Recipient Print Sets].

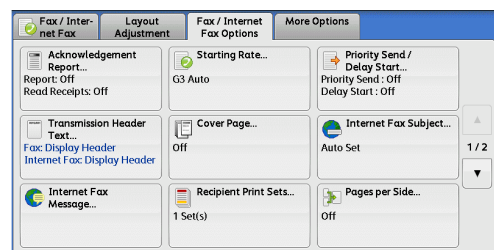

- 2 Select any option.

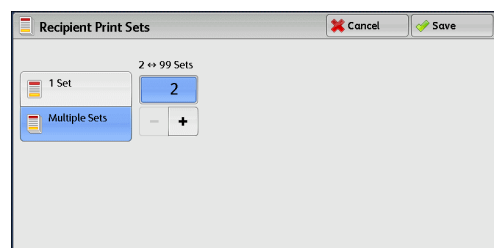



### ■1 Set

The remote machine will output one set of the fax document.

### ■Multiple Sets

Allows you to specify the number of print sets the remote machine will output, in the range from 2 to 99 in 1 set increments.

Use [+] and [-] or the numeric keypad to specify the value.

## Pages per Side (Combining Multiple Pages into One Sheet)

This feature allows you to send a fax by combining multiple pages of a document into one side of a single sheet of paper. For example, if you have a document of 12 pages, and you specify 3, the machine combines the scan data into 4 pages. You can specify a value for [Pages per Side] in the range from 2 to 9.

**Important** • If the length of each resultant page is too long, the output data may be split on the recipient's machine.

• If the number of pages of documents is smaller than the specified pages, the scanned number of pages will be only combined and transmitted.

### 1 Select [Pages per Side].

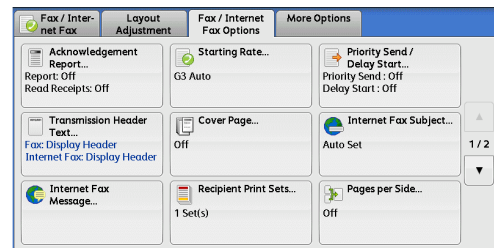

### 2 Select [On].

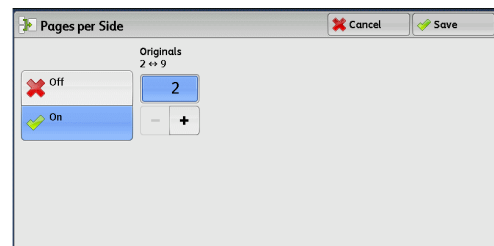

### ■Off

The Pages per Side feature is not applied.

### ■On

Allows you to scan multiple pages of a document onto one side of a single sheet of paper for fax transmission. Specify the number of pages in [Originals] to fit onto one sheet.

Use [+] and [-] or the numeric keypad to specify the value.

## Remote Folder (Using Remote Folder)

This feature allows you to send or receive confidential documents that you do not want others to see.

### ■ Sending to Folder (Fax Signal Method)

This feature allows you to send a file directly to a folder on the remote machine. The file can be printed on the remote machine. To use this feature, you need the folder number and passcode of the remote folder.

### ■ Secure Polling (Fax Signal Method)

This feature allows you to retrieve a file from a folder on a remote machine by sending a polling request from your machine. To use this feature, you need the folder number and passcode of the remote folder.

The retrieved file is stored in a folder on the machine. When a file is received in a folder, the <Data> indicator lights up and a Folder Report is printed. The Folder Report lists the folder number and name.

**Important** • You cannot use polling to retrieve files from multiple remote folders simultaneously.

**Note** • The DTMF method is available for Remote Folder. The supported signals are numerals, "\*", and "#" only.

For information on how to print files received in a folder, refer to "Printing Files in a Folder" (P.296).

Files received in folders can be automatically printed depending on the folder settings. For information on the folder settings, refer to "Configuring/Starting Job Flow" (P.299).

Depending on the report print settings, a Folder Report may not be printed even after a file is received in a folder. For information on the Folder Report setting, refer to "5 Tools" > "Common Service Settings" > "Reports" > "Folder Report" in the Administrator Guide.

### ■ Sending to Folder (DTMF Method)

To send a fax to a folder using the DTMF method, you need the folder number of the remote folder. Two DTMF methods are available: Auto and Manual.

## Sending to Folder (Fax Signal Method)

- 1 Select [Remote Folder].

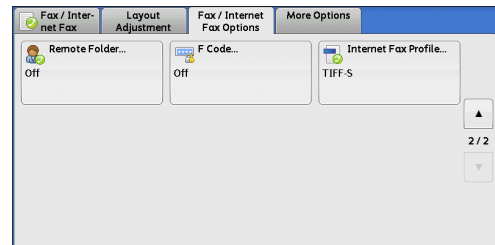

- 2 Select [On].

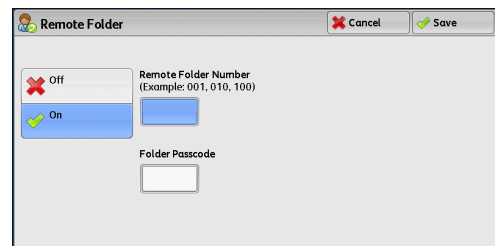

#### ■ Off

Disables the Remote Folder feature.

#### ■ On

Enables the Remote Folder feature. Enter a folder number in [Remote Folder Number].

#### ■ Remote Folder Number

Select the [Remote Folder Number] box, and enter a 3-digit folder number of the remote machine using the numeric keypad.

### ■Folder Passcode

Select the [Folder Passcode] box, and enter the 4-digit passcode of the remote folder using the numeric keypad. If a passcode is not set, leave this box blank.

### Secure Polling (Fax Signal Method)

- 1 Select [More Options] tab to display the [More Options] screen.

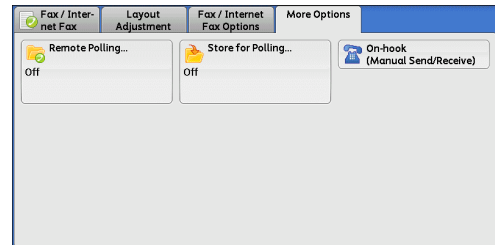

- 2 Select [Remote Polling].
- 3 Select [Poll a Remote Device].

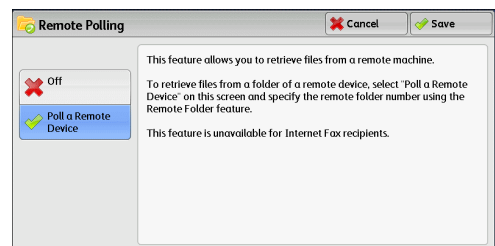

- 4 Select [Save].
- 5 Select the [Fax/Internet Fax Options] tab to display the [Fax/Internet Fax Options] screen, and select [▼] to display the next page.

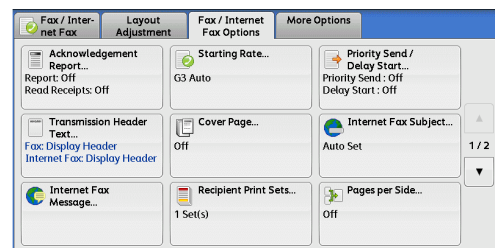

- 6 Select [Remote Folder].

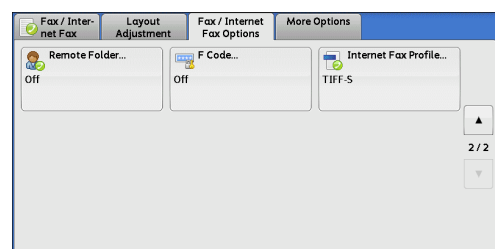

- 7 Select [On].

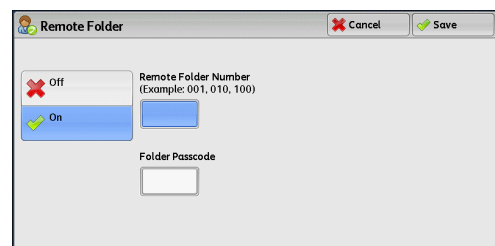

### ■Off

Disables the Secure Polling feature.

### ■On

Enables the Secure Polling feature. Enter a folder number in [Remote Folder Number].

### ■Remote Folder Number

Select the [Remote Folder Number] box, and enter a 3-digit folder number of the remote machine using the numeric keypad.

### ■Folder Passcode

Select the [Folder Passcode] box, and enter the 4-digit passcode of the remote folder using the numeric keypad. If a passcode is not set, leave this box blank.

## Format for Auto Send (DTMF Method)

- 1 Select [New Recipients] on the [Fax/Internet] screen to display the keyboard on the touch screen, and enter the destination and passcode in the following format.

Telephone number of remote machine	!	*	\$	Folder number on remote machine	#	#	\	Passcode of folder on remote machine	\	#	#	\$
------------------------------------------	---	---	----	---------------------------------------	---	---	---	--------------------------------------------	---	---	---	----

## Format for Manual Send (DTMF Method)

- 1 Select [On-hook (Manual Send/Receive)] on the [More Options] screen to display the keyboard on the touch screen, and enter the destination and passcode in the following format.

Telephone number of remote machine	Facsimile tone	*	Beep!	...			
Folder number on remote machine	#	#	Passcode of folder on remote machine	#	#	Beep!	Ready to start

- Note**
- Use the keyboard on the touch screen to enter symbols such as "!" and "\*". For information on how to enter characters, refer to "Entering Text" (P.58).
  - Enter a passcode only if necessary.
  - You can specify any machine that supports our DTMF method feature.

By registering destinations in address numbers using the above dialing formats, you can use the address numbers for the Secure Polling feature. For information on how to register address numbers, refer to "5 Tools" > "Setup" > "Add Address Book Entry" in the Administrator Guide.

## F Code (Using F Code Transmission)

F Code is the transmission procedure set by the Communications and Information Network Association of Japan and is the T.30 (communication protocol) method for using sub-addresses that was standardized by the ITU-T. The F Code feature enables various features to be used with transmission among F Code-compatible machines regardless of their manufacturers.

When using F Code transmission, use an F Code and password. The F Code, which is also called a sub-address by other companies, must be registered (entered). Set the password if necessary.

- Note**
- To use the F Code feature, you need to confirm the F Code of the recipient's machine in advance.
  - If you perform Sending to Folder or Secure Polling between machines of this model, we recommend that you use the fax signal method.

You can set the F Code and password for each address number. For information on how to register address numbers, refer to "5 Tools" > "Setup" > "Add Address Book Entry" in the Administrator Guide.

You can use the Relay Broadcast and Remote Relay Broadcast features with F Code transmission. For information on Relay Broadcast and Remote Relay Broadcast, refer to "Relay Broadcast (Transmitting Documents Through a Relay Station)" (P.205) and "Remote Relay Broadcast (Performing Relay Broadcast to Remote Locations)" (P.209), respectively.

You can use the following features with F Code transmission.

#### ■ Sending to Folder (F Code Method)

When a folder is set on a remote machine, you can send a document directly to the folder by specifying the F code (sub-address) and password (if set up) of the folder.

Obtain the F code (sub-address) and password of the remote folder in advance.

Example of specifying a destination:

F Code (sub-address) : 0 (to designate an F Code transmission) and the folder number of a folder on the remote machine

Password (if set up) : The password of the remote folder

#### ■ Secure Polling (F Code Method)

When a folder is set on a remote machine, you can perform secure polling for the folder by specifying its F code (sub-address) and password (if set up).

If you use your machine to perform secure polling for a folder on a remote machine, obtain the F code (sub-address) and password of the target folder.

If you use a remote machine to perform secure polling for a folder on your machine, give the following information.

F Code (sub-address) : 0 (to designate an F Code transmission) and the folder number of the target folder

Password (if necessary) : The password of the target folder

**Note** • The DTMF method is available for Remote Folder. The supported signals are numerals, "\*", and "#" only.

A file received in the folder can automatically be printed depending on the folder settings. For information on the folder settings, refer to "Configuring/Starting Job Flow" (P.299).

Depending on the report print settings, a Folder Report may not be printed even after a file is received in a folder. For information on the Folder Report setting, refer to "5 Tools" > "Common Service Settings" > "Reports" > "Folder Report" in the Administrator Guide.

For information on how to print files received in a folder, refer to "Printing Files in a Folder" (P.296).

### Sending to Folder (F Code Method)

- 1 Select [F Code].

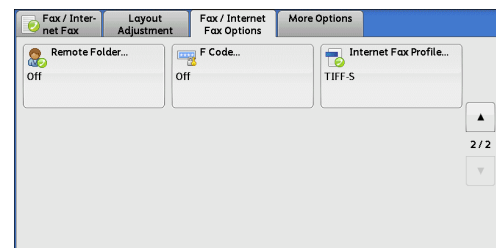

## 2 Select [On].

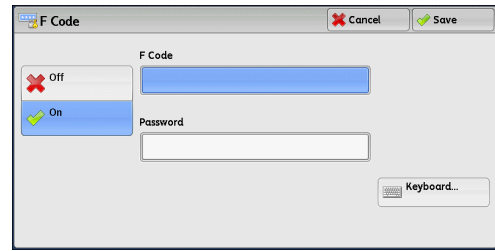

## 3 Select the [F Code] box, and enter an F code using the displayed keyboard or the numeric keypad.

**Note** • You can enter up to 20 digits for the F code.

## 4 If necessary, select the [Password] box, and enter a password using the displayed keyboard or the numeric keypad.

**Note** • You can enter up to 20 digits for the password.

### ■Off

The F code transmission is not used.

### ■On

The F code transmission is used. Enter the F Code.

### ■F Code

Select the [F Code] box, and enter the F code using the displayed keyboard or the numeric keypad.

**Note** • You can enter up to 20 digits for the F Code.

### ■Password

Select the [Password] box, and enter the password using the displayed keyboard or the numeric keypad. If a password is not set, leave this box blank.

**Note** • You can enter up to 20 digits for the password.

### ■Keyboard

Enter the F code or the password using the displayed keyboard.

For information on how to enter characters, refer to "Entering Text" (P.58).

## 5 Specify a destination, and then press the <Start> button.

### Secure Polling (F Code Method)

## 1 Select the [More Options] tab to display the [More Options] screen.

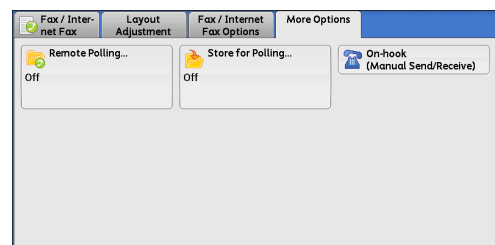

## 2 Select [Remote Polling].

3 Select [Poll a Remote Device].

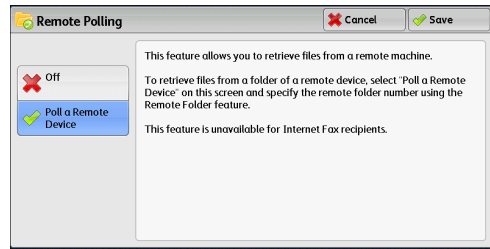

4 Select [Save].

5 Select the [Fax/Internet Fax Options] tab to display the [Fax/Internet Fax Options] screen.

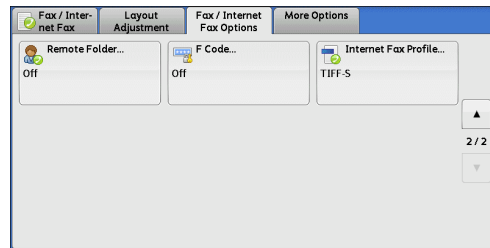

6 Select [F Code].

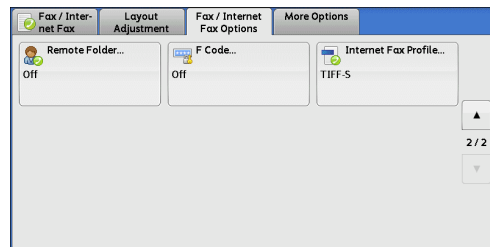

7 Select [On].

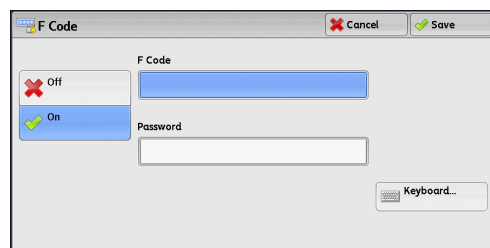

8 Select the [F Code] box, and enter the F Code using the displayed keyboard or the numeric keypad.

**Note** • You can enter up to 20 digits for the F Code.

9 If necessary, select the [Password] box, and enter a password using the displayed keyboard or the numeric keypad.

**Note** • You can enter up to 20 digits for the password.

■ **Off**

Disables the Secure Polling feature.

■ **On**

Enables the Secure Polling feature.

■ **F Code**

Select the [F Code] box, and enter the F code using the displayed keyboard or the numeric keypad.

**Note** • You can enter up to 20 digits for the F Code.

**■ Password**

Select the [Password] box, and enter the password using the numeric keypad. If a password is not set, leave this box blank.

**Note** • You can enter up to 20 digits for the password.

**■ Keyboard**

Enter the F code or the password using the displayed keyboard.

• For information on how to enter characters, refer to "Entering Text" (P.58).

**10** Specify a destination, and then press the <Start> button.

## Internet Fax Profile (Specifying Internet Fax Profiles)

A profile is specified to restrict attribute information such as image resolution and paper size for transmissions between Internet Fax-compatible machines.

- Note**
- The profiles that can be processed differ depending on the Internet Fax-compatible machine of the recipient. Before specifying a profile, confirm the profiles the Internet Fax-compatible machine of the recipient can process.
  - If inconsistency occurs between a profile, and stored document size and resolution, priority is given to the settings specified in the profile.
  - If the profile differs for each recipient when using Broadcast Send, the smallest size becomes the maximum image size.
  - This feature is not available for some models. An optional component is required. For more information, contact our Customer Support Center.

You can set an Internet Fax profile for each address number. For information on how to register address numbers, refer to "5 Tools" > "Setup" > "Add Address Book Entry" in the Administrator Guide.

You can change the default value of [Internet Fax Profile] in the System Administration mode. For information on how to change the default value, refer to "5 Tools" > "Fax Service Settings" > "Fax Defaults" > "Internet Fax Profile" in the Administrator Guide.

**1** Select [Internet Fax Profile].

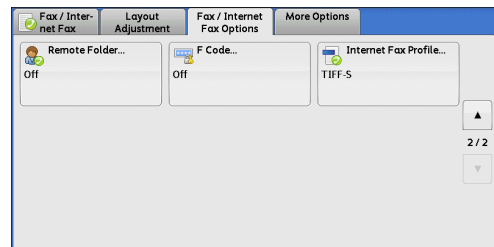

**2** Select any option.

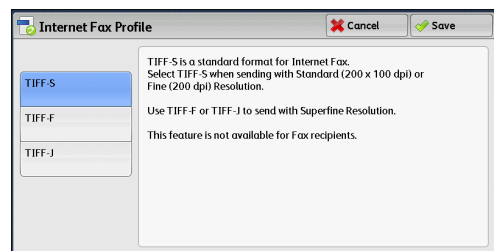



**■TIFF-S**

This profile is the Internet Fax standard. For documents that are larger than A4, the size is reduced automatically to A4 for transmission.

- Encoding method : MH
- Stored document size : A4
- Resolution : Standard (200 x 100 dpi), Fine (200 dpi)

**Note** • [TIFF-S] is not available when [Superfine (400 dpi)] or [Superfine (600 dpi)] is selected in [Resolution] on the [Fax/Internet Fax] screen.

**■TIFF-F**

Select this profile when you specify super-fine for the resolution.

- Encoding method : MMR
- Stored document size : A4
- Resolution : Standard (200 x 100 dpi), Fine (200 dpi), Superfine (400 dpi), Superfine (600 dpi)

**Note** • When a fax is sent to a machine that does not support TIFF-F, the recipient's machine will not be able to display or print the images.

**■TIFF-J**

Select this profile for sending documents in JBIG.

- Encoding method : JBIG
- Stored document size : A4
- Resolution : Standard (200 x 100 dpi), Fine (200 dpi), Superfine (400 dpi), Superfine (600 dpi)

**Note** • When a fax is sent to a machine that does not support TIFF-J, the recipient's machine will not be able to display or print the images.

## Encryption (Sending Internet Fax Encrypted by S/MIME)

You can send Internet Fax encrypted by S/MIME.

When sending encrypted Internet Fax, select an e-mail address associated with a certificate that can be encrypted, from the Address Book.

- Note**
- To send Internet Fax encrypted by S/MIME, register certificates of the machine and the recipient's machine in advance. For information on certificates, refer to "12 Encryption and Digital Signature Settings" > "Configuration of E-mail Encryption/Digital Signature" in the Administrator Guide.
  - You can change the default value of [Internet Fax Encryption] in the System Administration mode. For information on how to change the default value, refer to "5 Tools" > "Fax Service Settings" > "Fax Defaults" > "Internet Fax Encryption" in the Administrator Guide.

**■Off**

Sends Internet Fax without encryption.

**■On**

Sends encrypted Internet Fax.

## Digital Signature (Sending Internet Fax with a Digital Signature by S/MIME)

---

You can send Internet Fax with a digital signature by S/MIME.

Digital Signature allows a recipient to confirm whether the contents of the Internet Fax are changed, or whether the Internet Fax is sent from the proper sender.

- Note**
- To send Internet Fax with a digital signature by S/MIME, register certificates of the machine and the recipient's machine in advance. For information on certificates, refer to "12 Encryption and Digital Signature Settings" > "Configuration of E-mail Encryption/Digital Signature" in the Administrator Guide.
  - When [Digital Signature - Outgoing Internet Fax] is set to [Do not add signature] or [Always add signature] in the System Administration mode, depending the selected option, [On] or [Off] is displayed on the [Digital Signature] screen, which cannot be changed. For information on [Digital Signature - Outgoing Internet Fax], refer to "5 Tools" > "Connectivity & Network Setup" > "Security Settings" > "S/MIME Settings" in the Administrator Guide.

### ■Off

Sends Internet Fax without a digital signature.

### ■On

Sends Internet Fax with a digital signature.

## More Options

This section describes the features you can select on the [More Options] screen. The following shows the reference section for each feature.

Remote Polling (Retrieving Files from Remote Machines).....	199
Store for Polling (Storing Files on the Machine that a Remote Machine can Retrieve).....	202
On-hook (Confirming Remote Machine Response Prior to Transmission).....	203

- 1 Select [Fax/Internet Fax] on the [Services Home] screen.

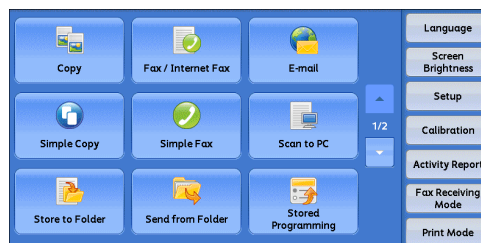

- 2 Select a feature on the [More Options] screen.

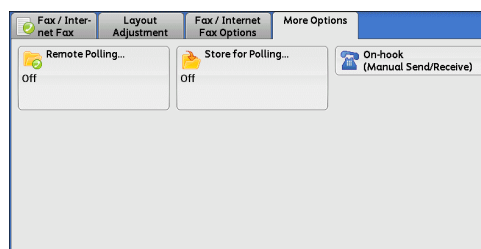

## Remote Polling (Retrieving Files from Remote Machines)

Remote Polling is a feature that allows your machine to retrieve a file stored in a remote machine. You are charged for the transmission fee.

This feature is used for Facsimile Information Services.

For information on Facsimile Information Services, refer to "Receiving Faxes" (P.213).

- Note**
- The Remote Polling feature may be not available depending on the remote machine.
  - When you specify polling in combination with [Delay Start] on the [Fax/Internet Fax Options] screen, you can retrieve a file at a specified time.

### ■ Remote Polling

You can retrieve a file stored on a remote machine by sending a polling request from your machine. You can also retrieve files from multiple machines. This is called Multi-Polling.

### ■ Secure Polling (DTMF Method)

You can retrieve a file from a folder on a remote machine by sending a request from your machine. A folder must be created on the remote machine. If the folder is passcode-protected, you can retrieve a file confidentially.

**Important** • You cannot use polling to retrieve files from multiple remote folders simultaneously.

## Remote Polling

1 Select [Remote Polling].

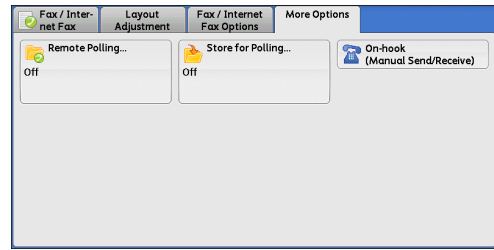

2 Select [Poll a Remote Device].

**Note** • To use Multi-Polling, specify multiple recipients.

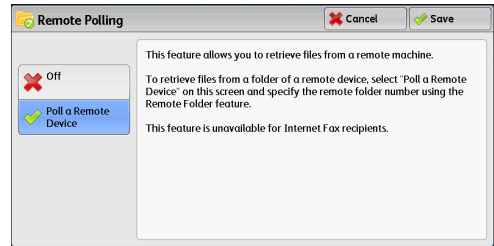

■ **Off**

Disables the Remote Polling feature.

■ **Poll a Remote Device**

Enables the Remote Polling feature.

3 Specify a destination, and then press the <Start> button.

## Secure Polling (DTMF Method)

1 Select [New Recipients] on the [Fax/Internet Fax] screen to display the keyboard on the touch screen.



2 Enter a format corresponding to Auto Send or Manual Send, and then select [Close].

3 Select the [More Options] tab to display the [More Options] screen.

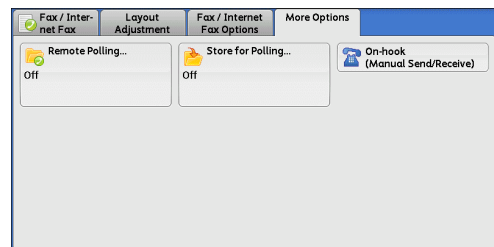

**4** Select [Remote Polling].

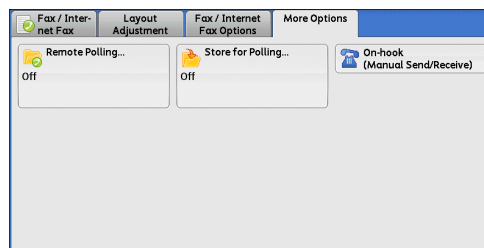

**5** Select [Poll a Remote Device].

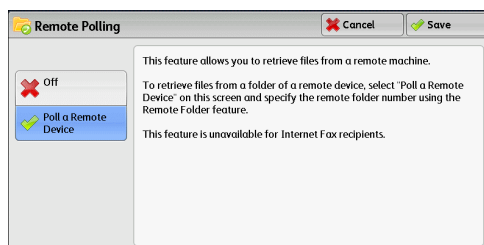

**6** Select [Save].

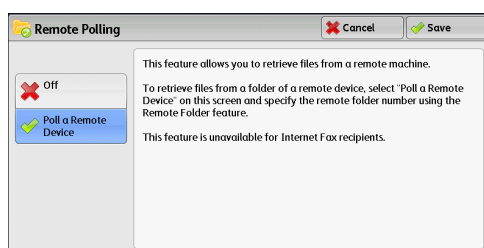

**■Off**

Disables the Secure Polling feature.

**■Poll a Remote Device**

Enables the Secure Poling feature.

**■Format for Auto Send**

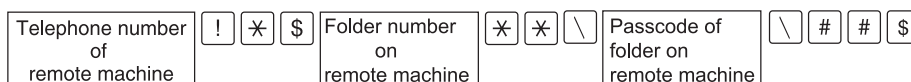

**■Format for Manual Send**

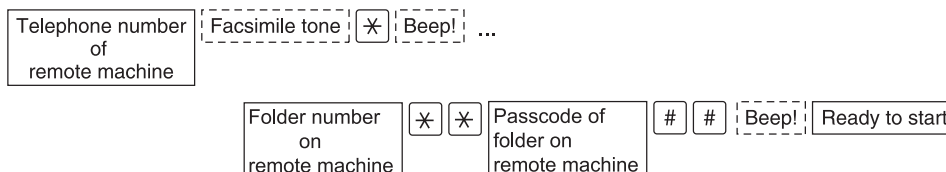

- Note**
- Use the keyboard on the touch screen to enter symbols such as "!" and "\*". For information on how to enter characters, refer to "Entering Text" (P.58).
  - Enter a passcode only if necessary.
  - You can specify any machine that supports our DTMF method feature.

By registering destinations in address numbers using the above dialing formats, you can use the address numbers for the Secure Polling feature. For information on how to register address numbers, refer to "5 Tools" > "Setup" > "Add Address Book Entry" in the Administrator Guide.

## Store for Polling (Storing Files on the Machine that a Remote Machine can Retrieve)

Store for Polling is a feature that store a file on your machine so that a remote machine can retrieve it from your machine. The following two methods are available for Store for Polling: Store for Free Polling and Store for Secure Polling.

The machine can be set to automatically delete files after they are retrieved with polling. For more information, refer to "5 Tools" > "Fax Service Settings" > "Fax Control" > "Polled Files - Auto Delete" in the Administrator Guide.

### 1 Select [Store for Polling].

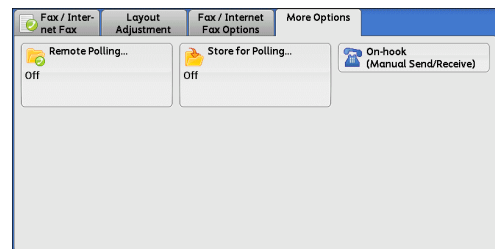

### 2 Select any option.

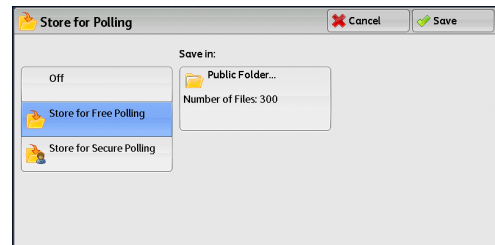

#### ■ Off

Disables the Store for Polling feature.

#### ■ Store for Free Polling

Stores a file in a public folder on the machine. The file in the public folder can be retrieved by a remote machine.

#### ■ Store for Secure Polling

Stores a file in a private folder on the machine. If the folder is passcode-protected, the file can be retrieved by a remote machine confidentially.

You need to create a private folder in advance. For more information on how to create a folder, refer to "5 Tools" > "Setup" > "Create Folder" in the Administrator Guide.

#### ■ Save in:

- When [Store for Free Polling] is selected

The [Public Folder] button is displayed. Selecting this button displays the [Public Folder] screen.

Refer to "[Public Folder] Screen" (P.203).

- When [Store for Secure Polling] is selected

The [Private Folder] button is displayed. Selecting this button displays the [Folder] screen. Select a folder to store files in for Secure Polling.

For information on how to select a folder, refer to "Selecting a Folder" (P.292). For information on how to check files for Secure Polling, refer to "Checking/Operating Files in a Folder" (P.293).

### 3 Press the <Start> button.

## [Public Folder] Screen

This screen allows you to print and delete files stored for Free Polling.

- 1 Select the file to be printed or deleted. You can select either one file or all files.

**Note** • Select [▲] to return to the previous screen or [▼] to move to the next screen.

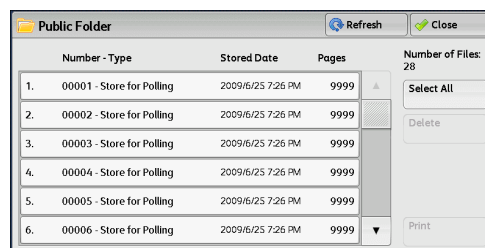

### ■Refresh

Refreshes the information about files stored in the public folder.

### ■Select All

Selects all files stored in the public folder.

### ■Delete

Deletes the selected file. Selecting this button displays a confirmation screen. Select [Delete] on the screen to delete the file.

### ■Print

Prints the selected file.

## On-hook (Confirming Remote Machine Response Prior to Transmission)

Use this feature when using Manual Send.

Manual Send is the transmission method that allows you to send a fax after you make a phone call to a remote machine and then check that the connection is established. This feature can be used with the receiver either off-hook or on-hook.

We recommend that you set the line monitor volume to "Loud".

**Note** • If an error occurs during transmission of, for example, the second page, the transmission of the first page may also end abnormally.

You can change the volume of the line monitor in the System Administration mode. For information on how to change the volume, refer to "5 Tools" > "Common Service Settings" > "Audio Tones" > "Line Monitor Volume" in the Administrator Guide.

- 1 Pick up the telephone receiver, or select [On-hook (Manual Send/Receive)].

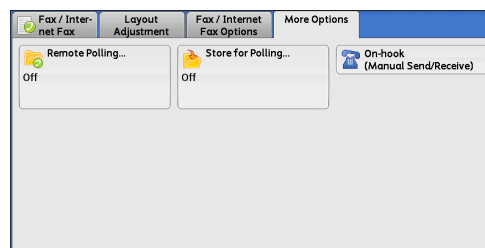

## 2 Select any option.

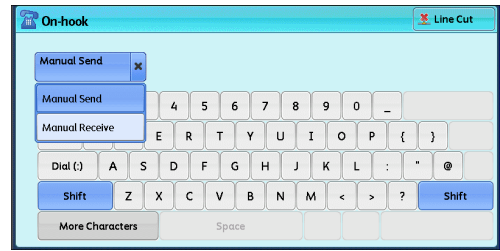

### ■ Manual Receive/Manual Send

Use the drop-down menu to switch between [Manual Receive] and [Manual Send].

- Manual Send : Allows you to check if connection is established before sending a fax.
- Manual Receive : Allows you to receive a fax manually, such as Facsimile Information Services.

### ■ Entering a destination

Use alphanumeric characters to specify a destination.

- Note**
- Some touch-tone services may not be available even if you set your telephone to send tones.
  - When the line type is set to a tone line, [.] (Tone) is not displayed on the screen. If you want to send tones (or to use the touch-tone services) while using a pulse line, select [.] (Tone).

### ■ More Characters

Select this button to display a symbol screen, allowing you to use symbols to specify a destination.

### ■ Line Cut

Cuts the line connected.



## Broadcast

This section describes how to set Broadcast Send and Relay Broadcast.

Broadcast Send (Transmitting to Multiple Recipients).....	205
Relay Broadcast (Transmitting Documents Through a Relay Station).....	205
Remote Relay Broadcast (Performing Relay Broadcast to Remote Locations).....	209

### Broadcast Send (Transmitting to Multiple Recipients)

The Broadcast Send feature allows you to transmit the same document to multiple recipients in a single operation. There is no need to repeat the same operation for each recipient.

If you specify Broadcast Send, the machine prints a Broadcast/Multi-Poll Report after the Broadcast Send operation finishes.

- Note**
- You can use Broadcast Send by specifying recipients from Fax and Internet Fax for a single job. (Mix Broadcast)
  - The maximum number of recipients that you can specify at one time is as follows: Using the numeric keypad: 200 locations; using address numbers: 600 locations; and using the numeric keypad in combination with address numbers: 600 locations.
  - When using Broadcast Send, the Cover Page and Remote Folder features are not available even if they are enabled on the control panel. If you want to use [Cover Page] and [Remote Folder], set them when registering each recipient in an address number.
  - [Confirmation Options] is not available. Check a Broadcast/Multi-Poll Report to see transmission results.

#### 1 Select the first recipient

- Note**
- When you specify recipients from Fax and Internet Fax for a single job (Mix Broadcast), select the fax type for each recipient from the drop-down menu.

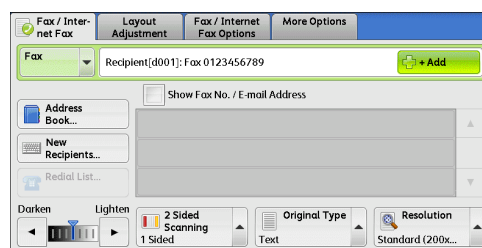

#### 2 Select [+ Add].

#### 3 Select the next recipient.

#### 4 Repeat steps 2 and 3.

#### 5 Press the <Start> button.

#### 6 Select [Yes] on the confirmation screen to start transmission.

### Relay Broadcast (Transmitting Documents Through a Relay Station)

The Relay Broadcast feature transmits documents to multiple recipients via other fax machines (relay stations). When a document is to be transmitted over a long distance to multiple recipients, it is first transmitted to one relay station and from there to multiple recipients. When you transmit documents over a long distance to many recipients, using Relay Broadcast can save on transmission cost.

Furthermore, multiple Relay Broadcast operations can be performed simultaneously. This is called Multiple Relay Broadcast.

The following three methods are available for Relay Broadcast:

**■Fax Signal Method**

This method employs a Fuji Xerox proprietary communication procedure that is only for use with specific machines that have the Relay Broadcast feature.

**■DTMF Method**

G3 fax machines that support Manual Send can perform Relay Broadcast for the machine.

**■F Code Method**

This method can be used among machines that support the F Code and the Relay Broadcast features.

**Before using the Relay Broadcast Feature**

Before using the Relay Broadcast feature, register the following information.

For information on how to register address numbers, refer to "5 Tools" > "Setup" > "Add Address Book Entry" in the Administrator Guide.

Where	Contents
Initiating Station	Fax Signal Method Assign the relay station to an address number (0001 to 2000) to set up the Relay Broadcast feature. <ul style="list-style-type: none"> <li>• Register the last two digits of the address number of the initiating station (which is already registered at a relay station) as a relay station ID for the Relay Broadcast operation.</li> <li>• Register the address numbers or group dial number of the relay recipients (which are registered at a relay station) as broadcast recipients. The wildcard "*" can be used.</li> </ul> DTMF Method (G3)/F Code Method <ul style="list-style-type: none"> <li>• No registration is required. The dialing format can be registered to an address number.</li> </ul>

For information on the setting items to be registered in relay stations, refer to the documentation provided with relay stations.

**Fax Signal Method**

- 1 Select an address number or group dial number to which a relay broadcast is registered, and press the <Start> button.  
To perform Multiple Relay Broadcast, repeat this step.

**DTMF Method**

The following two types are available in the DTMF method: Auto Send and Manual Send.

**■Auto Send (Transmitting without picking up the receiver)**

- 1 Select [New Recipients] to display the keyboard on the touch screen and enter in the following format.

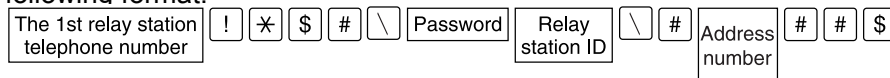

- Password  
A pre-registered 2-digit number

- Note** • By default, no password is set. For setting a password, contact our Customer Support Center. If a password is not set, you do not need to enter one.

• Relay station ID

The last two digits of the initiating station address number registered at the relay station

• Address number

An address number for the relay recipients registered at the relay station

The wildcard "\*" can also be used.

You can register the above dialing format in an address number to send using the address number. For information on how to register address numbers, refer to "5 Tools" > "Setup" > "Add Address Book Entry" in the Administrator Guide.

**2** Select [+ Add] to perform Multiple Relay Broadcast.

- Note** • You can specify up to 20 locations for relay recipients.

**3** Press the <Start> button.

**Manual Send (Transmitting with picking up the receiver or on-hook)**

**1** Select the [More Options] tab to display the [More Options] screen.

**2** Pick up the telephone receiver, or select [On-hook (Manual Send/Receive)].

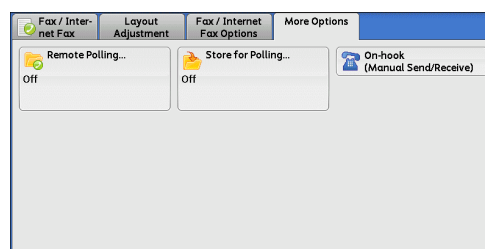

**3** Select [Manual Send] from the drop-down menu.

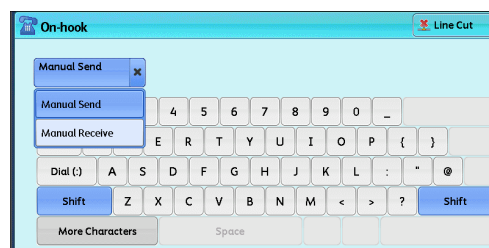

**4** Use the keyboard displayed on the touch screen to enter numbers in the following format.

Relay station telephone number [Facsimile tone] \* [Beep!] # Password Relay station ID # Address number # ... # # [Beep!]

- Note** • You can specify up to 20 locations for relay recipients.

## F Code Method

You can perform Relay Broadcast by registering the relay station's F code and password (if necessary) to the machine.

- Note**
- When performing Relay Broadcast with the F Code method, you can use a password if you set a receive password for the relay station.
  - When performing Relay Broadcast between Fuji Xerox manufactured machines that can be used as both an initiating station and a relay station, we recommend that you use the fax signal method.
  - Confirm the F code (sub-address) and password of the target relay station.

- 1 Select the [Fax/Internet Fax Options] tab to display the [Fax/Internet Fax Options] screen.

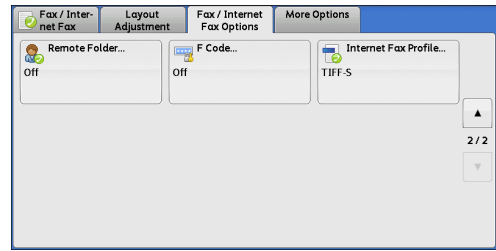

- 2 Select [F Code].

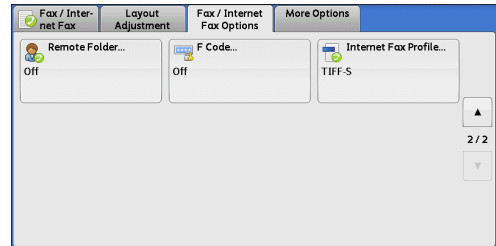

- 3 Select [On].

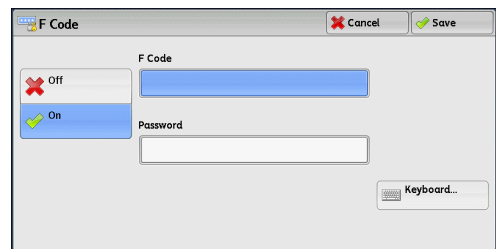

- 4 Select the [F Code] box, and enter the F code with the numeric keypad.

**Note** • You can enter up to 20 digits for the F Code.

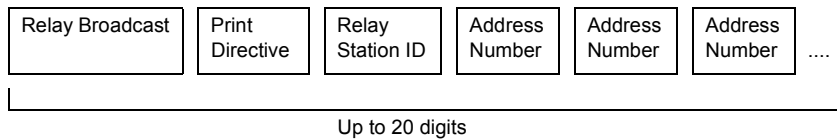

- Relay Broadcast  
The number of digits of the relay station ID:  
1: When the relay station IDs and address numbers are two digits  
2: When the relay station IDs and address numbers are three digits
- Print Directive  
Printing/not printing at the relay station  
1: Printing at the relay station  
0: Not printing at the relay station
- Relay Station ID  
An address number for an initiating station registered at the relay station  
When the relay station ID is set, the initiating station is notified of the results of a Relay Broadcast.  
When the relay station ID is "00" or "000", the initiating station is not notified of the results of a Relay Broadcast.
- Address Number  
The address number assigned to the relay recipient

The following shows an example of F Code that indicates printing at the relay station, notifying the initiating station (100) of the results, and performing Relay Broadcast to relay recipients (200, 201, 202, and 203).

F Code example: 21100200201202203

- 5 If necessary, enter the password using the numeric keypad.

## Remote Relay Broadcast (Performing Relay Broadcast to Remote Locations)

The Remote Relay Broadcast feature combines two or more Relay Broadcast operations and use Broadcast Send.

This feature is more economical than Relay Broadcast in transmitting documents to multiple remote machines.

**Note** • Multiple Relay Broadcast can be performed from a secondary relay station.

The following three methods are available in Remote Relay Broadcast:

### ■Fax Signal Method

This method employs a Fuji Xerox proprietary communication procedure that is only for use with specific machines that support the Relay Broadcast feature.

### ■DTMF Method

G3 fax machines that support Manual Send can perform Remote Relay Broadcast for the machine.

### ■F Code Method

This method can be used among machines that support the F Code and the Relay Broadcast features.

## Fax Signal Method

Register the following information in the address numbers of initiating stations in advance.

For information on how to register address numbers, refer to "5 Tools" > "Setup" > "Add Address Book Entry" in the Administrator Guide.

Where	Contents
Initiating Station	Assign the relay station to an address number (0001 to 2000) to set up the Relay Broadcast feature. <ul style="list-style-type: none"> <li>• Register the last two digits of the address number of the initiating station (which is already registered at a primary relay station) as a relay station ID.</li> <li>• Register the address numbers or group dial number of the secondary relay stations (which are registered at a primary relay station) as broadcast recipients.</li> </ul>

For information on the setting items to be registered in a primary relay station and a secondary relay station, refer to the documentations provided with them.

- 1 Select an address number or group dial number to which a remote relay broadcast is registered, and press the <Start> button.

## DTMF Method

The following two types are available in the DTMF method: Auto Send and Manual Send.

For information on how to register address numbers, refer to "5 Tools" > "Setup" > "Add Address Book Entry" in the Administrator Guide.

For information on the setting items to be registered in a primary relay station and a secondary relay station, refer to the documentations provided with them.

**Note** • You can specify any machine that supports our DTMF method feature.

**■Auto Send (Transmitting without picking up the receiver)**

- 1 Select [New Recipients] to display the keyboard on the touch screen and enter in the following format.

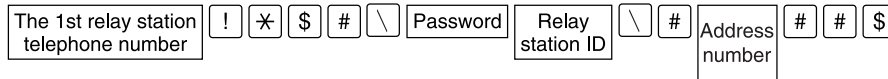

- Password

A pre-registered 2-digit number

**Note** • By default, no password is set. For setting a password, contact our Customer Support Center. If a password is not set, you do not need to enter one.

- Relay Station ID

The last two digits of the initiating station address number registered at the primary relay station

- Address Number

The address number for the secondary relay station registered at the primary relay station

You can register the above dialing format in an address number to send using the address number. For information on how to register address numbers, refer to "5 Tools" > "Setup" > "Add Address Book Entry" in the Administrator Guide.

- 2 Select [+ Add] to perform Multiple Relay Broadcast.

**■Manual Send (Transmitting with picking up the receiver or on-hook)**

- 1 Select the [More Options] tab to display the [More Options] screen.

- 2 Pick up the telephone receiver, or select [On-hook (Manual Send/Receive)].

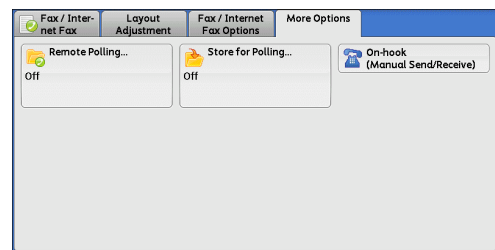

- 3 Select [Manual Send] from the drop-down menu.

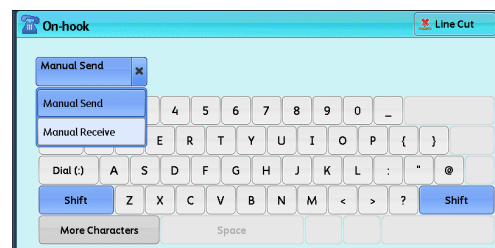

- 4 Use the keyboard displayed on the touch screen to enter numbers in the following format.

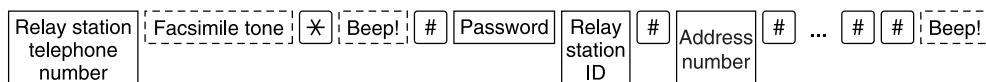

**Note** • You can specify up to 20 locations for relay recipients.

### F Code Method

When using the machine as the initiating station for performing Remote Relay Broadcast, confirm the F Code and the password (if necessary) for the primary relay station.

**Important** • When using the F Code method for Remote Relay Broadcast, the primary relay stations and secondary relay stations must support our F Code method and the Relay Broadcast feature.

**Note** • When performing Relay Broadcast with Fuji Xerox manufactured machines that can be used as both an initiating station and a relay station, we recommend that you use the fax signal method.

- 1 Select the [Fax/Internet Fax Options] tab to display the [Fax/Internet Fax Options] screen.

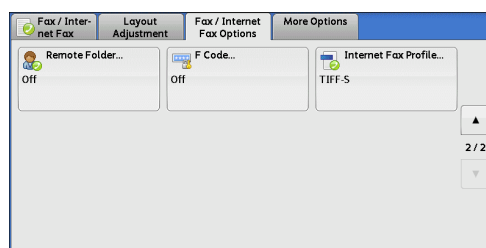

- 2 Select [F Code].

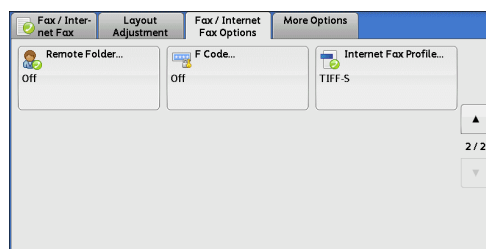

- 3 Select [On].

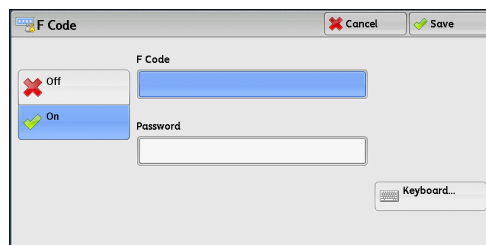

- 4 Select the [F Code] box, and enter the F Code with the numeric keypad.

**Note** • You can enter up to 20 digits for the F Code.

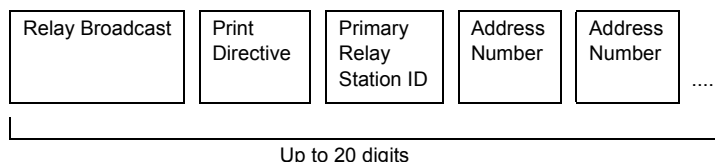

- Relay Broadcast
  - The number of digits of the primary relay station ID:
    - 1: When the primary relay station IDs and address numbers are two digits
    - 2: When the primary relay station IDs and address numbers are three digits
- Print Directive

Printing/not printing at the primary relay station

1: Printing at the primary relay station

0: No printing at the primary relay station

- Primary Relay Station ID

The address number for the initiating station registered at the primary relay station

When the primary relay station ID is set, the initiating station is notified of the results of the Remote Relay Broadcast.

When the primary relay station ID is "00" or "000", the initiating station is not notified of the results of a Remote Relay Broadcast.

- Address Number

The address number assigned to the secondary relay station

**5** If necessary, enter the password using the numeric keypad.



## Receiving Faxes

Two modes are available for receiving faxes: Auto Receive and Manual Receive.

In the Auto Receive mode, reception of a fax from a remote machine begins automatically.

In the Manual Receive mode, reception of a fax from a remote machine is manual. This mode is convenient for confirming the sender or using an external telephone to confirm whether it is a fax before beginning reception.

Using G3-ID allows the machine to reject faxes from specific fax numbers or unknown fax numbers. You can register up to 50 fax numbers as rejected fax numbers.

- Rejecting faxes from specific fax numbers:

The machine rejects faxes when the G3-ID sent from the sender's machine is included in the registered fax numbers to be rejected.

- Rejecting faxes from unknown fax numbers:

The machine rejects faxes when the G3-ID is not sent from the sender's machine.

G3-ID contains a phone number and other information that are registered in the sender's machine.

You can change the default value of [Fax Receiving Mode] in the System Administration mode. For information on how to change the default value, refer to "5 Tools" > "Fax Service Settings" > "Fax Control" > "Fax Receiving Mode" in the Administrator Guide.

For information on how to reject faxes from specific fax numbers or unknown fax numbers, refer to "5 Tools" > "Fax Service Settings" > "Fax Control" > "Block Inbound Faxes" and "Block Unknown Fax Numbers" in the Administrator Guide.

## Switching between Auto Receive and Manual Receive

- 1 Press the <Machine Status> button.
- 2 Select [Fax Receiving Mode] on the [Machine Information] screen.
- 3 Select [Manual Receive] or [Auto Receive].

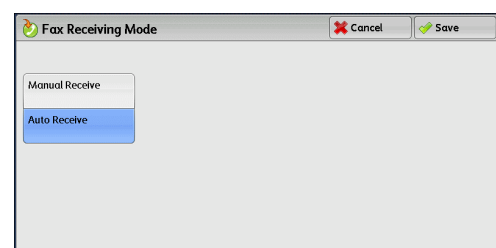
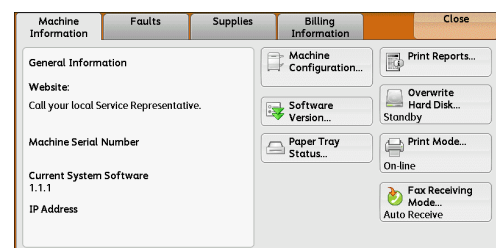

### ■ Manual Receive

Reception of a fax from a remote machine is manual. This mode is convenient for confirming the sender or using an external telephone to confirm whether it is a fax before beginning reception.

### ■Auto Receive

Reception of a fax from a remote machine begins automatically.

## Using Auto Receive

---

When [Fax Receiving Mode] is set to [Auto Receive] on the [Machine Information] screen, the following two methods are available to receive a fax:

### ■When the machine automatically switches to fax reception

When there is an incoming call, the machine automatically receives a fax after it rings for a certain period of time.

### ■When the machine automatically switches between a call and fax reception

When there is an incoming fax, the machine automatically receives a fax. When there is an incoming call, pick up the telephone receiver to talk while the machine is ringing.

## Using Manual Receive

---

When [Fax Receiving Mode] is set to [Manual Receive], and the machine rings to notify of an incoming call, pick up the receiver of the external telephone or select [On-hook] on the screen displayed.

**Note** • We recommend that you set the monitor volume to [Loud] when using the On-hook feature. For information on how to change the volume of the line monitor, refer to "5 Tools" > "Common Service Settings" > "Audio Tones" > "Line Monitor Volume" in the Administrator Guide.

**1** When the machine rings, the receiving screen appears.

If there is a telephone, pick the receiver up. If not, select [On-hook] on the receiving screen.

**2** Confirm whether the call is from a telephone or a fax machine.

If the call is from a telephone, use the receiver to talk.

If the call is from a fax machine, you will hear the sound of a fax machine.

**Note** • If you select [On-hook], you will hear the sound from the machine speaker. However, you cannot talk to the other party.

**3** Press the <Start> button.

**4** If you picked up the receiver, place it back in the cradle when the <Data> indicator lights up on the control panel.

**Important** • Make sure to place the receiver back in the cradle properly. Otherwise, the line will remain "busy" with the receiver being left off the cradle.

## Using Folder Receive

---

Files received using Folder Receive are stored in a folder. After a file is received in a folder, the <Data> indicator lights up and the machine prints a Folder Report. The Folder Report lists the folder number and folder name.

To receive files in a folder using the F Code method, notify the sender of the following information:

- F Code (sub-address): 0 (to designate F Code transmission) and the folder number to store the file in

- Password (if necessary): the passcode of the folder to store the file in
  - The DTMF method is available for Remote Folder. The supported signals are numerals, "\*", and "#" only.

Depending on the report print settings, a Folder Report may not be printed even after a file is received in a folder. For more information on the Folder Report settings, refer to "5 Tools" > "Common Service Settings" > "Reports" > "Folder Report" in the Administrator Guide.

For information on how to print a file stored in a folder, refer to "Printing Files in a Folder" (P.296).

## Facsimile Information Services

For information on subscriptions and advanced operating procedures, contact the corresponding facsimile information service.

### Using the Receiver

- 1 Pick up the telephone receiver.

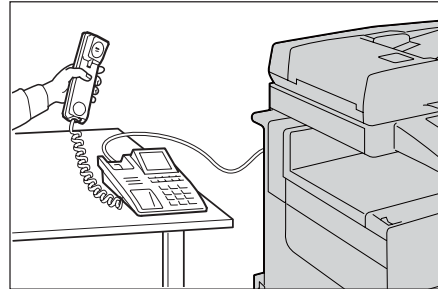

- 2 Select [Manual Receive] from the drop-down menu.
- 3 Specify the fax number of the facsimile information service.
  - You can use the numeric keypad or address numbers to specify the call destination, but cannot use the Address Book.
  - You can use the keyboard displayed on the screen to specify the call destination. Selecting [More Characters] on the screen displays symbols.

**Note**

  - When the line type is set to a tone line, [:] (Tone) is not displayed on the screen. If you want to send tones (or to use the touch-tone services) while using a pulse line, select [:] (Tone).
  - Some touch-tone services may not be available even if you set your telephone to send tones.
- 4 When the machine connects to the service, you will hear voice prompts. Follow the voice prompts to enter the required numbers.
- 5 After entering the numbers, press the <Start> button.
 

**Note**

  - The <Data> indicator lights up on the control panel, and reception begins.
- 6 Place the receiver back in the cradle.
 

**Important**

  - Make sure to place the receiver back in the cradle properly. Otherwise, the line will remain "busy".

### When Not Using a Receiver

- 1 Adjust the volume of the line monitor.  
We recommend that you set the volume of the line monitor to [Loud] so that you can hear the voice prompts clearly.

For information on how to change the volume of the line monitor, refer to "5 Tools" > "Common Service Settings" > "Audio Tones" > "Line Monitor Volume" in the Administrator Guide.

- 2 Select [On-hook (Manual Send/Receive)] on the [More Options] screen.

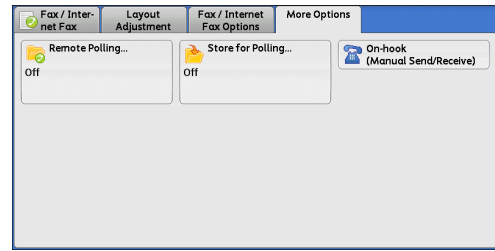

- 3 Select [Manual Receive] from the drop-down menu.
  - 4 Specify the fax number of the facsimile information service.
    - You can use the numeric keypad or address numbers to specify the call destination, but cannot use the Address Book.
    - You can use the keyboard displayed on the screen to specify the call destination. Selecting [More Characters] on the screen displays symbols.
- Note**
- When the line type is set to a tone line, [:] (Tone) does not appear. If you want to send tones (or to use the touch-tone services) while using a pulse line, select [:] (Tone).
  - Some touch-tone services may not be available even if you set your telephone to send tones.
- 5 When the machine connects to the service, you will hear voice prompts. Follow the voice prompts to enter the required numbers.
  - 6 After entering the numbers, press the <Start> button.









# 5 Scan

This chapter describes the basic operations and features for the Scan services. To use the Scan services, network settings are required. For information on the network settings, refer to "9 Scanner Environment Settings" in the Administrator Guide.

- Scanning Procedure ..... 222
- Operations during Scanning ..... 229
- E-mail..... 232
- Network Scanning..... 251
- Scan to PC..... 253
- Store to Folder ..... 259
- Store to USB..... 261
- Store & Send Link..... 265
- Advanced Settings..... 268
- Layout Adjustment ..... 273
- E-mail Options/Filing Options ..... 281

## Scanning Procedure

This section describes the basic scanning procedure. The following shows the reference section for each procedure.

Step 1 Loading Documents .....	222
Step 2 Selecting the Features .....	223
Step 3 Starting the Scan Job.....	226
Step 4 Confirming the Scan Job in Job Status .....	227
Step 5 Saving the Scanned Data .....	228

### Step 1 Loading Documents

The following two methods are available to load documents:

#### ■ Document Feeder

- Single sheet
- Multiple sheets

#### ■ Document Glass

- Single sheet
- Bound documents, such as books

#### Document Feeder

The document feeder supports single and multiple sheet documents with sizes from 125 x 85 mm (Standard size: A5, A5 $\square$ ) to 216 x 356 mm (Standard size: A4, 8.5 x 11").

The document feeder automatically detects standard size documents. For non-standard size documents, enter the size on the [Original Size] screen.

For information on document sizes that can be detected automatically and how to enter a non-standard document size, refer to "Original Size (Specifying a Scan Size)" (P.275).

The standard document sizes that can be detected automatically depend on [Paper Size Settings] in the System Administration mode. For information on paper size settings, refer to "5 Tools" > "Common Service Settings" > "Other Settings" > "Paper Size Settings" in the Administrator Guide.

The document feeder accepts the following number of sheets.

Document Type (Weight)	Number of Sheets
Lightweight paper (38 - 49 gsm)	110 sheets
Plain paper (50 - 80 gsm)	110 sheets
Heavyweight paper (81 - 128 gsm)	75 sheets

- Important**
- To avoid paper jams, use the document glass for folded or wrinkled documents, cut-and-pasted documents, curled paper, or back carbon paper.
  - 2-sided scanning of lightweight paper (38 - 49 gsm) is not supported.

For information on how to scan mixed sized documents, refer to "Mixed Size Originals (Scanning Different Size Documents Simultaneously)" (P.276).

#### Document Glass

The document glass supports a single sheet, a book, or other similar documents with sizes from 15 x 15 mm (Standard size: A5, A5 $\square$ ) to 216 x 356 mm (Standard size: A4).

**Important** • Always close the document cover after using the document glass.

The document glass automatically detects standard size documents. For non-standard size documents, enter the size on the [Original Size] screen.

For information on document sizes that can be detected automatically and how to enter a non-standard document size, refer to "Original Size (Specifying a Scan Size)" (P.275).

The standard document sizes that can be detected automatically depend on [Paper Size Settings] in the System Administration mode. For information on the paper size settings, refer to "5 Tools" > "Common Service Settings" > "Other Settings" > "Paper Size Settings" in the Administrator Guide.

**⚠ CAUTION**

Do not apply excessive force to hold thick document on the document glass. It may break the glass and cause injuries.

**1** Open the document cover.

**Important** • Ensure that the touch screen is active, and then load a document. Otherwise, the machine may not properly detect the document size.

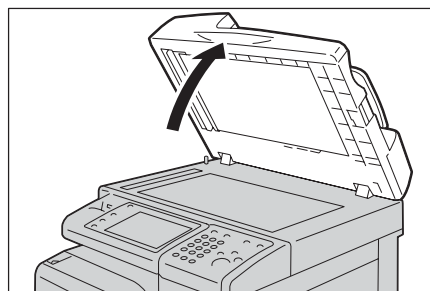

**2** Load the document face down, and align it against the top left corner of the document glass.

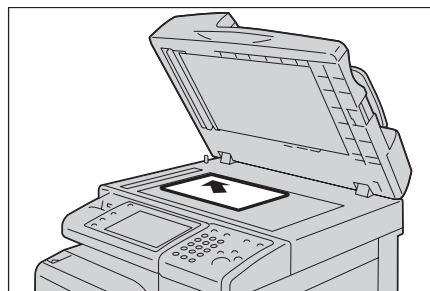

**3** Close the document cover.

## Step 2 Selecting the Features

On the [Services Home] screen, you can select from six Scan services: [E-mail], [Store to Folder], [Network Scanning], [Scan to PC], [Store to USB], and [Store & Send Link]. You can select features for each service.

- Note**
- The features displayed on the screen depend on your machine configuration.
  - When the Accounting feature is enabled, a user ID and passcode may be required. Ask your system administrator for the user ID and passcode.
  - To use the Scan services, network settings are required. For information on the network settings, refer to "9 Scanner Environment Settings" in the Administrator Guide.

### ■E-mail

Scans a document and sends the scanned data as an e-mail attachment after converting the data to TIFF, JPEG, PDF, DocuWorks, or XPS (XML Paper Specification).

### ■Store to Folder

Scans a document and saves the scanned data in a folder on the machine.

You need to create a folder in advance. For information on how to create a folder, refer to "5 Tools" > "Setup" > "Create Folder" in the Administrator Guide.

**■ Network Scanning**

Scans a document using a job template created on CentreWare Internet Services.

When Scan to Home is enabled and the Remote Access feature is available, the scanned data can be transferred to a different destination according to an authenticated user.

For information on how to create a job template, refer to the help of CentreWare Internet Services.

**■ Scan to PC**

Scans a document and sends the scanned data to a network computer via the FTP or SMB protocol.

**■ Store to USB**

Scans a document and saves the scanned data to a USB memory device.

**■ Store & Send Link**

Scans a document and temporarily saves the scanned data on the machine. The user is notified by e-mail of the URL to the location where the scanned data is stored. Then, the user can access the URL to retrieve the scanned data.

The following table shows file formats available for each Scan service.

Scan Service	File Format can be Selected When	File Format				
		PDF	Docu-Works	XPS*1	TIFF	JPEG
E-mail	Using the control panel when scanning	O*2	O*3	O	O	O
Scan to PC		O*2	O*3	O	O	O
Store to USB		O*2	O*3	O	O	O
Store & Send Link		O*2	O*3	O	O	O
Store to Folder	Using CentreWare Internet Services	O*2	O*3	O	O	O
	Using Stored File Manager 3	X	X	X	O	O
	Using DocuWorks*4	X	O*3	X	X	X
	Using EasyOperator	X	X	X	O	O
	Using Adobe Acrobat*4	O*2	X	X	X	X
Network Scanning	Creating a job template	O	X	O	O	O

- O Available
- X Not available
- \*1 XPS stands for XML Paper Specification.
- \*2 Supported on Acrobat 4.0 or later
- \*3 Supported on DocuWorks Ver.4 or later
- \*4 TWAIN compatible application

**Note** • If you do not specify a file name for the document to be saved, a file name is automatically assigned to each file or folder based on a particular rule. For example, the file name "img-123123456" indicates that the document was scanned at 12:34:56 on January 23. X, Y, and Z represent October, November, and December, respectively.

The following describes how to store scanned data into a folder as an example.

- 1 Press the <Services Home> button.

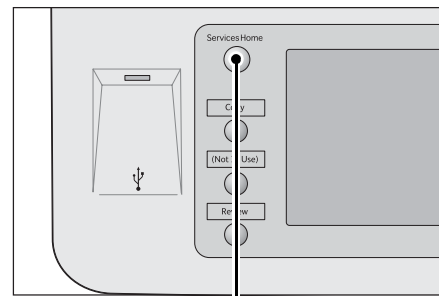

<Services Home> button

- 2 Select [Store to Folder].

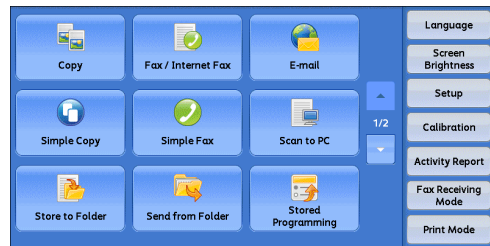

- 3 If the previous settings still remain, press the <Clear All> button.

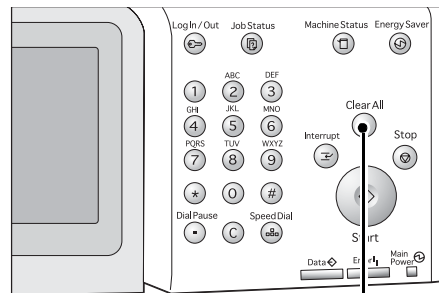

<Clear All> button

- 4 Specify a folder to save the data in.

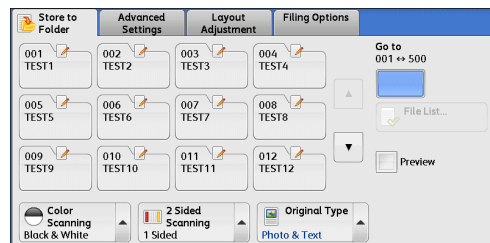

- 5 Select each tab, and configure features as necessary.

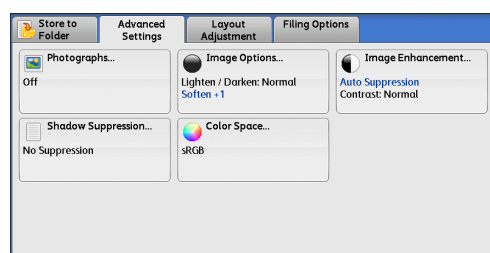

The following shows the reference section for each tab.

- "Store to Folder" (P.259)
- "Advanced Settings" (P.268)
- "Layout Adjustment" (P.273)
- "E-mail Options/Filing Options" (P.281)

When you use another Scan service, [Store to Folder] is replaced with [E-mail], [Network Scanning], [Scan to PC], [Store to USB], or [Store & Send Link].

The following shows the reference section for each service.

- "E-mail" (P.232)
- "Scan to PC" (P.253)
- "Store to USB" (P.261)
- "Store & Send Link" (P.265)
- "Network Scanning" (P.251)

### Step 3 Starting the Scan Job

The following describes how to start a scan job.

**1** Press the <Start> button.

**Important** • If the document has been loaded in the document feeder, do not hold down the document while it is being conveyed.

**Note** • If a problem occurs, an error message appears on the touch screen. Solve the problem according to the message.  
 • You can set the next job during scanning.

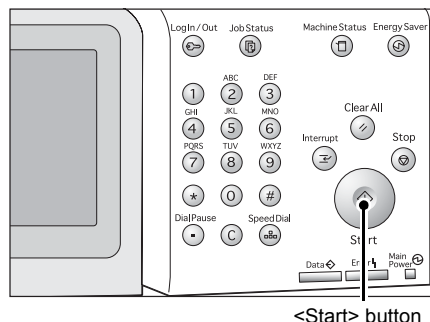

**■ If you have more documents**

If you have more documents to scan, select [Next Original] on the touch screen while the current document is being scanned. This allows you to scan the documents as a single set of data.

Up to 100 pages can be stored.

**Note** • When an optional component is installed in the machine and the setting is changed, up to 999 pages can be stored. For information on how to set the maximum number of pages stored for a scan document, refer to "5 Tools" > "Scan Service Settings" > "Other Settings" > "Maximum Stored Pages" in the Administrator Guide.  
 • If the number of pages scanned by the machine exceeds the maximum, the machine stops scanning. Follow the message displayed on the screen, and either abort the operation or save the already-scanned data as a single set of data.

**2** While documents are being scanned, select [Next Original].

**Note** • When using the document feeder, load the next document after the machine has finished scanning the first document.  
 • When [Next Original] is displayed on the screen shown on the right and no operation is performed for a certain period of time, the machine automatically assumes that there are no more documents.  
 • You can change the scan settings of the next document by selecting [Change Settings] that is displayed after selecting [Next Original].

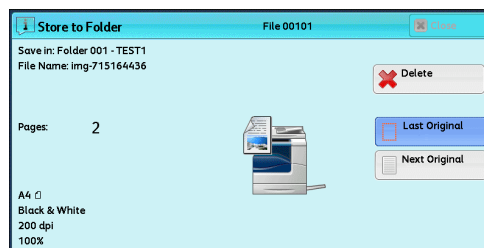

- 3 Load the next document.

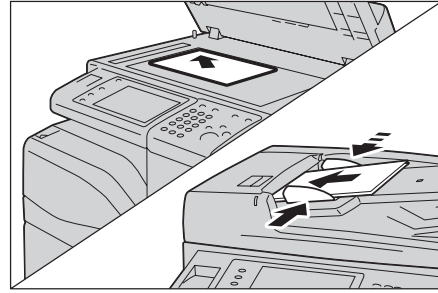

- 4 Press the <Start> button.  
If you have more documents, repeat steps 3 and 4.

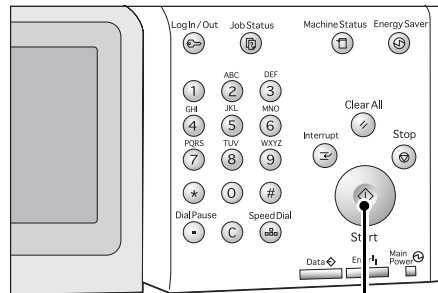

<Start> button

- 5 When all documents have been scanned, select [Last Original].

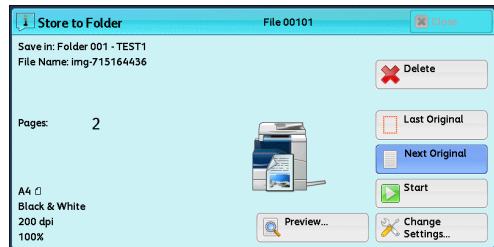

Scan 5

## Step 4 Confirming the Scan Job in Job Status

The following describes how to confirm the status of a scan job.

- 1 Press the <Job Status> button.

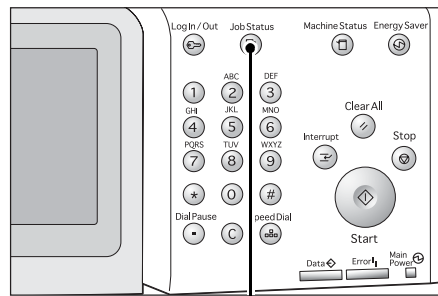

<Job Status> button

- 2 Confirm the job status.

- Note**
- Select [▲] to return to the previous screen or [▼] to move to the next screen.
  - From the drop-down menu, you can select [Scan, Fax, & Internet Fax Jobs] and display the desired job.

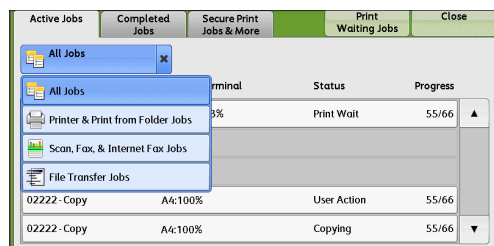

## Step 5 Saving the Scanned Data

---

When you used the Store to Folder service, you can use the following methods to import the file stored in a folder of the machine to your computer:

■ **Import using an application**

Use Network Scanner Driver.

Refer to "Importing to a TWAIN Compatible Application" (P.356).

■ **Import using Stored File Manager 3**

Use Stored File Manager 3 (Fuji Xerox application software).

Refer to "Importing Using Stored File Manager 3" (P.358).

■ **Import using CentreWare Internet Services**

Use CentreWare Internet Services.

Refer to "Importing Using CentreWare Internet Services" (P.360).

■ **Import using EasyOperator**

Use EasyOperator (Fuji Xerox application software).

Refer to "Importing Using EasyOperator" (P.362).



# Operations during Scanning

The following describes the operations available during scanning. The following shows the reference section for each operation.

Stopping the Scan Job .....	229
Previewing the Scanned Images during a Scan Job .....	230
Changing Scan Settings.....	231

## Stopping the Scan Job

To cancel scanning a document, use the following procedure.

- 1 Press either the <Stop> button on the control panel or [Delete] on the touch screen.

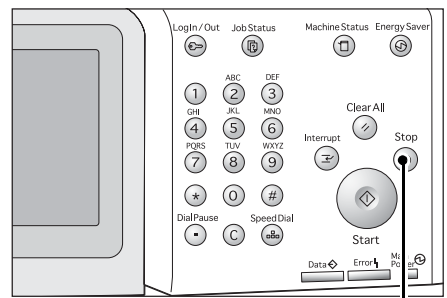

<Stop> button

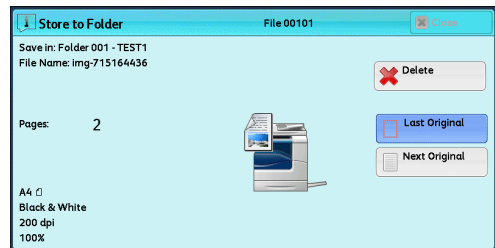

- 2 Select [Delete].

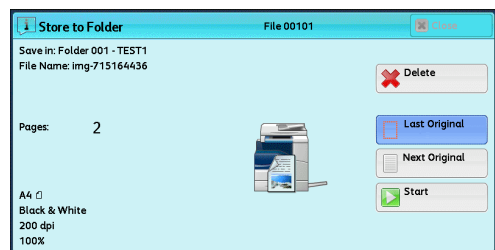

■If [Delete] does not appear on the screen:

- 1 Press the <Job Status> button.

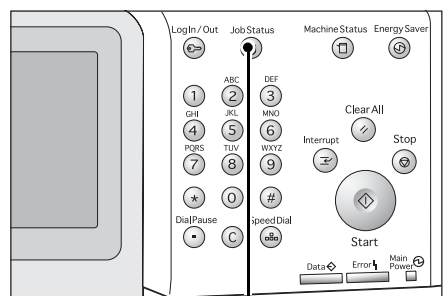

<Job Status> button

2 Select the job to cancel.

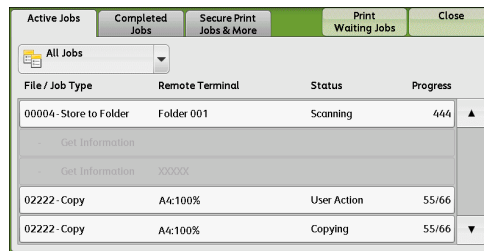

3 Select [Delete].

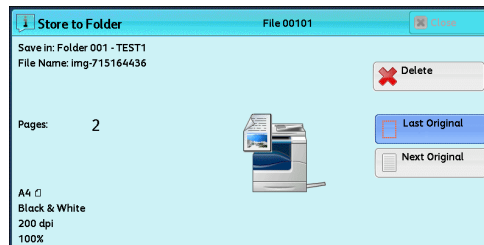

4 Select [Delete].

**Note** • If you cancel the job, the scanned data stored in the folder will also be deleted.

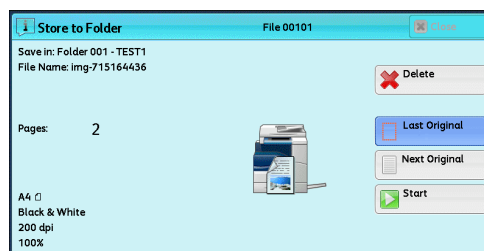

## Previewing the Scanned Images during a Scan Job

You can preview the scanned images while scanning the document.

1 Select [Next Original].

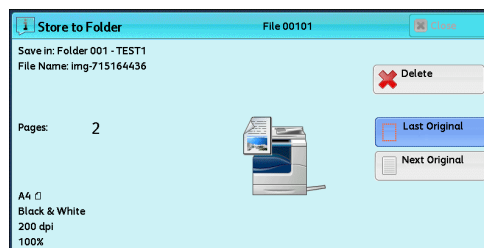

2 Select [Preview] to display a preview screen. The first page of the last scanned document is displayed.

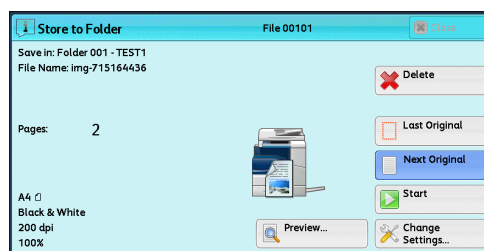

3 From the drop-down menu, specify the view size by selecting [Whole Page] or [Enlarge View], and set [Current Page].

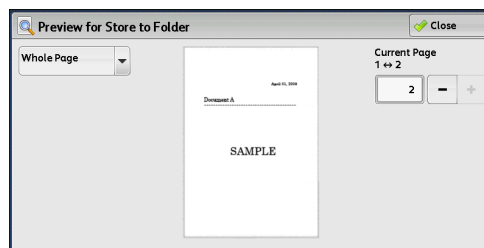

- 4 After the confirmation, select [Close] to close the preview screen.

## Changing Scan Settings

You can change scan settings while scanning the document.

- 1 Select [Next Original].

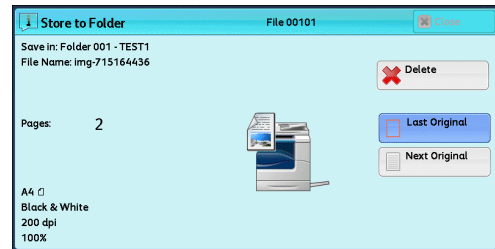

- 2 Select [Change Settings].

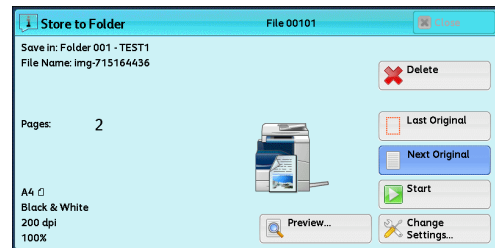

- 3 Set [Color Scanning], [Original Type], [Resolution], [Lighten/Darken], [Original Orientation], [2 Sided Scanning], and [Original size].

The following shows the reference section for each feature.

"Color Scanning (Selecting an Output Color)" (P.239)

"Original Type (Selecting the Document Type)" (P.241)

"Resolution (Specifying a Scanning Resolution)" (P.273)

"Image Options (Adjusting Scan Density and Image Sharpness)" (P.269)

"Original Orientation (Specifying the Orientation of the Loaded Documents)" (P.279)

"2 Sided Scanning (Scanning Both Sides of a Document)" (P.274)

"Original Size (Specifying a Scan Size)" (P.275)

- 4 Press the <Start> button.

# E-mail

This section describes the features you can select on the [E-mail] screen. The E-mail service allows you to scan a document and send the scanned data as an e-mail attachment. The following shows the reference section for each feature.

- Address Book (Specifying an E-mail Address) .....232
- New Recipient (Entering an Address) .....235
- Add Me (Adding the Sender's Address).....236
- Recipient(s) (Editing a Recipient).....236
- From (Setting the Sender's Address) .....238
- Subject (Setting the Subject).....238
- Message (Entering the E-mail Body).....239
- Preview (Previewing the Scanned Images during a Scan Job) .....239
- Color Scanning (Selecting an Output Color) .....239
- 2 Sided Scanning (Scanning Both Sides of a Document).....240
- Original Type (Selecting the Document Type).....241
- File Format (Selecting a File Format for Output Data) .....242

**Note** • You can encrypt e-mail or send it with a digital signature by S/MIME. To use this feature, you need to register certificates of the machine and the recipient's device in advance. For information on certificates, refer to "12 Encryption and Digital Signature Settings" > "Configuration of E-mail Encryption/Digital Signature" in the Administrator Guide.

You can customize the layout of the features displayed on the [E-mail] screen. For more information, refer to "5 Tools" > "Scan Service Settings" > "First Tab" in the Administrator Guide.

**1** Select [E-mail] on the [Services Home] screen.

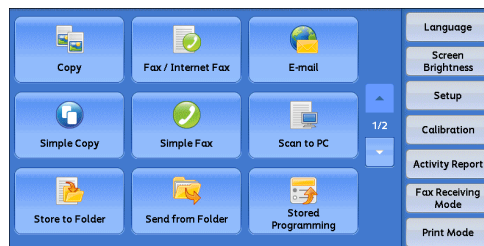

**2** Select a feature on the [E-mail] screen.

**Important** • You can only specify recipients registered for e-mail, but not for faxes.  
 • You cannot use address numbers using the numeric keypad or group numbers to specify recipients.  
 • The [New Recipient] and [Add Me] buttons may not be displayed depending on the settings in the System Administration mode.

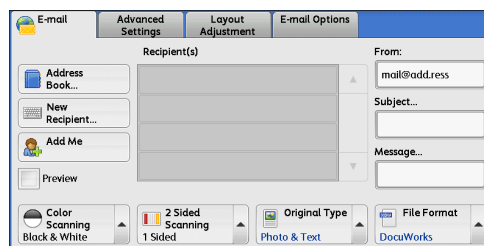

## Address Book (Specifying an E-mail Address)

The following describes how to select a recipient using the Address Book.

When sending an encrypted e-mail, select an e-mail address associated with a certificate that can be encrypted, from the Address Book.

To use this feature, an e-mail address associated with a certificate for S/MIME must be registered in the Address Book in advance. For information on how to set the Address Book, refer to "5 Tools" > "Setup" > "Add Address Book Entry" in the Administrator Guide.

To verify the validity of a certificate, prior settings are required. For information on the settings, refer to "5 Tools" > "Connectivity & Network Setup" > "Security Settings" > "Certificate Revocation Retrieval Settings" in the Administrator Guide.

## 1 Select [Address Book].

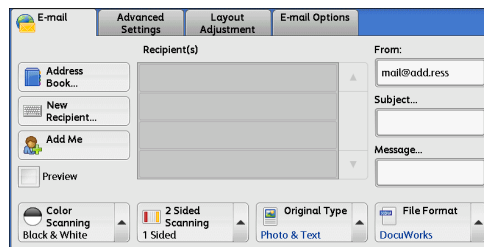

## 2 Select a recipient from the address list, and then select [To], [Cc], or [Bcc].

- Note**
- When specifying multiple recipients, specify them continuously.
  - To search for recipients by other methods, select and switch to [List all public entries], [Search Public], or [Search Network] from the drop-down menu on the [E-mail Address Book] screen. The methods that appear in the drop-down menu depend on the settings in the System Administration mode.

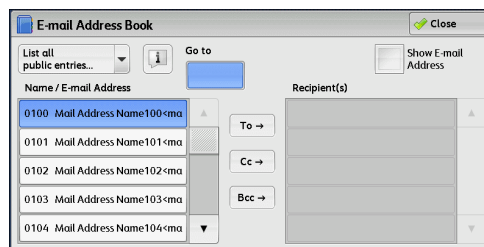

- Important**
- When specifying an e-mail address, check if the address contains a domain that is not permitted for use. In this case, the address cannot be used.

### ■List all public entries

Displays the local address list.

Refer to "When [List all public entries] is Selected" (P.234).

### ■Search Public

Searches recipients in the local address list.

Refer to "When [Search Public] or [Search Network] is Selected" (P.234).

### ■Search Network

Searches recipients in the remote address list.

- Note**
- To display [Search Network], the prior setting is required in the System Administration mode. Refer to "When [Search Public] or [Search Network] is Selected" (P.234).

### ■Name/E-mail Address

Lists names and their e-mail addresses.

### ■To

Sets the selected address as a recipient.

### ■Cc

Sets the selected address as Cc.

### ■Bcc

Sets the selected address as Bcc.

### ■Go to

Enter an address number using the numeric keypad to display the e-mail address at the top of the list.

#### ■ [1] button

Displays detailed information on the selected recipient.

#### ■ Show E-mail Address

Select this check box to display only e-mail addresses in the list.

### When [List all public entries] is Selected

- 1 Select a recipient from a list under [Name/E-mail Address].

- Note**
- Select [▲] to return to the previous screen or [▼] to move to the next screen.
  - You can sort recipients in alphabetical order or address number order.

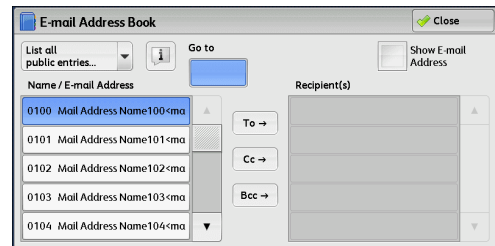

### When [Search Public] or [Search Network] is Selected

- 1 Enter keywords to search for an address.

- Note**
- The screen as shown on the right appears when [Search Public] is selected.
  - When multiple keywords are used, the address is searched with the AND clause.

For information on how to enter characters, refer to "Entering Text" (P.58).

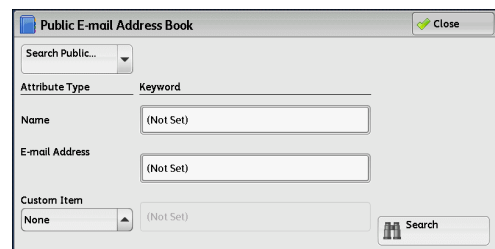

#### ■ Name

Searches with a recipient name as a keyword. Selecting the field for [Name] under [Keyword] displays the screen for entering the keyword. Up to 32 characters are allowed.

Example: John Smith

#### ■ E-mail Address

Searches with an e-mail address as a keyword. Selecting the field for [E-mail Address] under [Keyword] displays the screen for entering the keyword. Up to 128 characters are allowed.

Example: myhost@example.com

#### ■ Custom Item

Select this option to search with a keyword item other than a recipient name and e-mail address.

Select any option from [Custom Item] and then select the box under [Keyword] to display a screen for entering a keyword. You can enter the keyword with up to 60 characters.

- Note**
- You can select only one custom item.

- None  
No custom item is used for the keyword search.
- Custom Item 1 (Telephone Number)

[Telephone Number] is set by default. When selected, a telephone number is used for the keyword search.

- Custom Item 2 (Office)

[Office] is set by default. When selected, an office name is used for the keyword search.

- Custom Item 3 (Department)

[Department] is set by default. When selected, a department name is used for the keyword search.

For information on how to change the settings for the custom items, refer to "5 Tools" > "Connectivity & Network Setup" > "Remote Authentication/Directory Service" in the Administrator Guide.

### ■Keyword

Select a keyword item, and then enter the keyword.

### ■Search

The search starts. The searched results are listed on the screen.

## New Recipient (Entering an Address)

You can enter e-mail addresses using the keyboard.

- 1 Select [New Recipient].

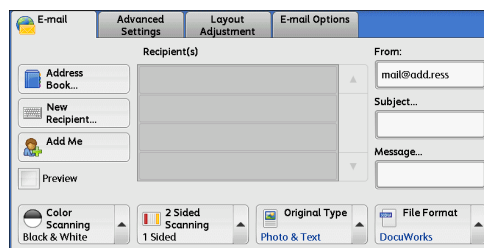

- 2 Use the keyboard displayed on the screen to enter an e-mail address with up to 128 characters.

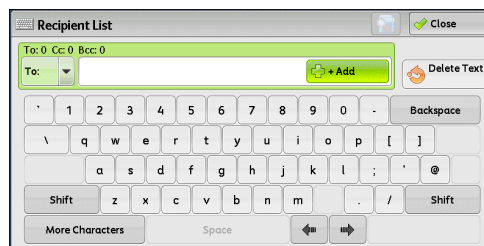

### ■To/Cc/Bcc

Allows you to switch the recipient type (To/Cc/Bcc) from the drop-down menu.

### ■+ Add

Allows you to add e-mail addresses to send e-mails to multiple recipients (Broadcast).

### ■[🔍] button

Searches for names.

### ■Delete Text

Deletes all the entered e-mail addresses.

■ **Backspace**

Moves the cursor back to delete one character.

■ **Shift**

Used for entering uppercase characters.

■ **More Characters**

Displays symbols. Use this button to enter symbols for the e-mail address.

### Add Me (Adding the Sender's Address)

The sender's address can be added to [To], [Cc], or [Bcc].

1 Select [Add Me].

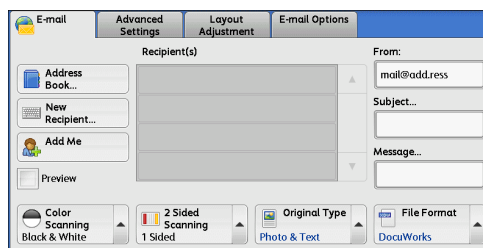

2 Select any option.

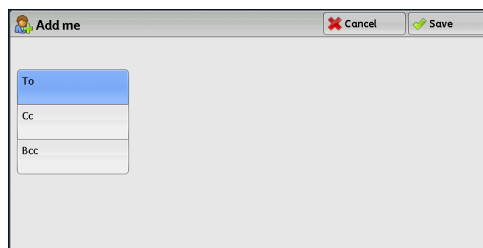

■ **To**

Adds the sender's address to To.

■ **Cc**

Adds the sender's address to Cc.

■ **Bcc**

Adds the sender's address to Bcc.

### Recipient(s) (Editing a Recipient)

You can confirm, delete, or edit recipients using the pop-up menu displayed.

1 From the [Recipient(s)] list, select the recipient to be deleted, confirmed, or edited.

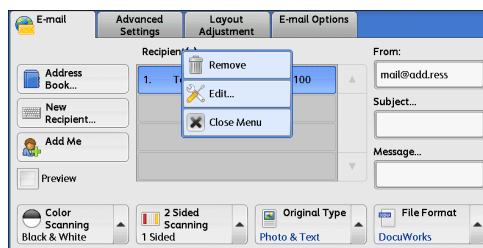

2 Select any option from the pop-up menu.



**■Remove**

Removes the selected recipient.

**■Edit**

Displays the [Edit Recipient] screen on which you can confirm or edit the recipient.  
Refer to "[Edit Recipient] Screen" (P.237).

**■Close Menu**

Hides the pop-up menu.

**[Edit Recipient] Screen**

This screen allows you to confirm and change the settings of the recipient.

- 1 Select the item to be changed.
- 2 Select [Edit].

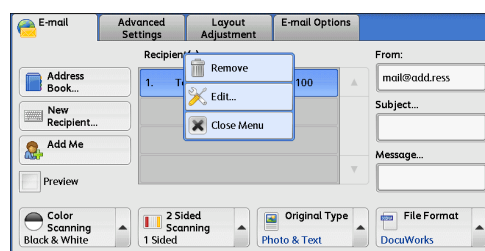

- 3 Select any option.

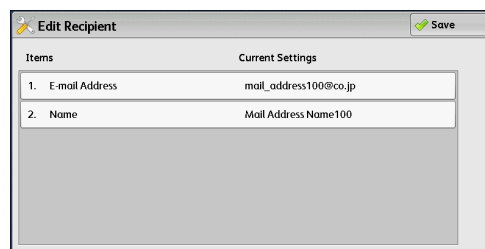
**■E-mail Address**

To change the e-mail address, select [Change Settings] to display the keyboard and enter a new address.

**■Name**

To change the recipient name, select [Change Settings] to display the keyboard and enter a new name.

When the recipient name is registered in the Address Book, that recipient name is displayed.

**■S/MIME Certificate**

To check whether or not any certificate is linked to the e-mail address, select [Change Settings].

If S/MIME is enabled, and a certificate is linked to the e-mail address, you can check the contents of the S/MIME certificate.

For information on S/MIME communication, refer to "12 Encryption and Digital Signature Settings" > "Configuration of E-mail Encryption/Digital Signature" in the Administrator Guide.

## From (Setting the Sender's Address)

Specify a sender's e-mail address. You can specify only one address as a sender's address.

- Note**
- When the Authentication feature is enabled, the e-mail address registered in user information is automatically set as a sender's address. For more information on user information, refer to "5 Tools" > "Accounting" > "Create/View User Accounts" in the Administrator Guide.
  - [From] may not be editable depending on the setting in the System Administration mode.
  - When you send e-mail with a digital signature, the machine's e-mail address becomes the sender's address.

For information on a digital signature, refer to "12 Encryption and Digital Signature Settings" > "Configuration of E-mail Encryption/Digital Signature" in the Administrator Guide.

### 1 Select [From].

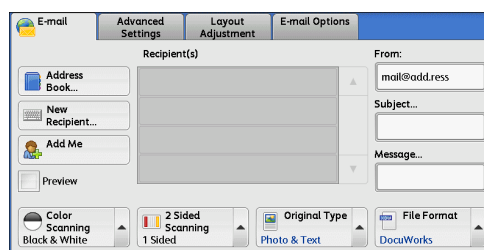

### 2 Select any option from the pop-up menu displayed.

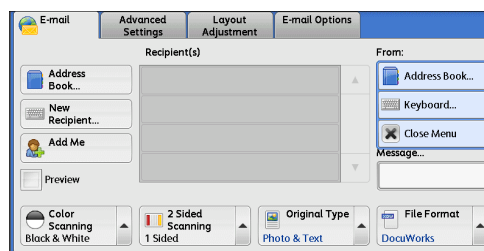

#### ■Address Book

Allows you to select the sender's e-mail address from the Address Book.

For information on the Address Book, refer to "Address Book (Specifying an E-mail Address)" (P.232).

#### ■Keyboard

Allows you to enter the sender's e-mail address with up to 128 characters using the displayed keyboard.

#### ■Close Menu

Hides the pop-up menu.

## Subject (Setting the Subject)

You can specify the e-mail subject using the following procedure.

#### ■Auto Set

Automatically sets the subject to [Scan data from XXX] (where XXX is the host name of the machine).

#### ■To set a user-defined subject

### 1 Select [Subject].

- 2 Enter a subject with up to 128 characters using the displayed keyboard.

For information on how to enter characters, refer to "Entering Text" (P.58).

## Message (Entering the E-mail Body)

You can enter the e-mail body using the following procedure.

- 1 Select [Message].
- 2 Enter a message with up to 512 characters using the displayed keyboard.

For information on how to enter characters, refer to "Entering Text" (P.58).

## Preview (Previewing the Scanned Images during a Scan Job)

You can preview the scanned images while scanning the document.

- 1 Select the [Preview] check box.

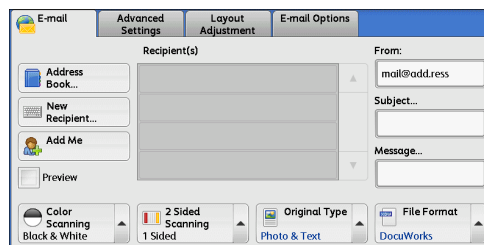

- 2 Preview the scanned images after the document is scanned.

## Color Scanning (Selecting an Output Color)

You can set the output color to scan a document.

- 1 From the menu displayed by selecting [Color Scanning], select any option.

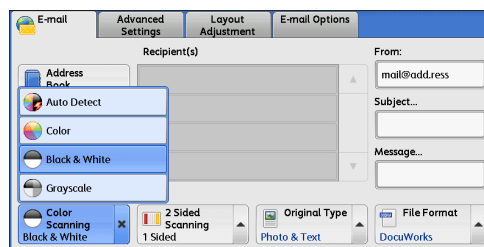

### ■Auto Detect

The color of the document is determined automatically; the machine scans in full color when the document is colored, otherwise scans in monochrome.

- Note**
- When you select [Auto Detect], the available features on the [Advanced Settings] screen are the same as when you select [Color] in [Color Scanning] for color documents, or the same as when you select [Black & White] in [Color Scanning] for monochrome documents.

### ■Color

Select this option to scan a color document.

■ **Black & White**

Scans a document in monochrome two tones. You can select the document type in [Original Type].

■ **Grayscale**

Scans a document in grayscale. Adds shades to monochrome, creating intermediate tones that change gradually. Suited to documents containing gradations that cannot be reproduced with monochrome (2-color tone).

**2 Sided Scanning (Scanning Both Sides of a Document)**

You can scan a 1-sided or 2-sided document on one or both sides of paper. By setting the binding style, both sides are scanned in the same orientation.

- 1 From the menu displayed by selecting [2 Sided Scanning], select any option.

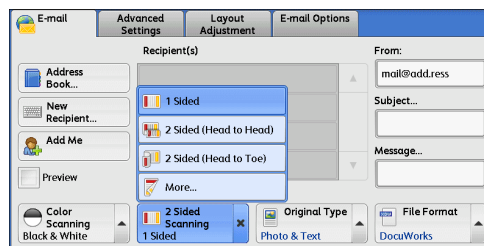

■ **1 Sided**

Select this option to scan only one side of the document.

■ **2 Sided (Head to Head)**

Select this option when both sides of the 2-sided document are in the same orientation.

■ **2 Sided (Head to Toe)**

Select this option when both sides of the 2-sided document are in opposite orientations.

■ **More**

Displays the [2 Sided Scanning] screen.  
Refer to "[2 Sided Scanning] Screen" (P.240).

**[2 Sided Scanning] Screen**

This screen allows you to select the status and orientation of original documents.

- 1 Select any option.

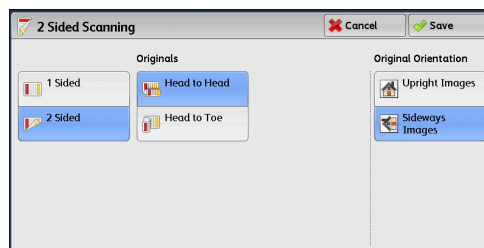

■ **1 Sided**

Select this option to scan only one side of the document.

**■2 Sided**

Select this option to scan both sides of the document.

**■Originals**

This option is displayed when [2 Sided] is selected.

- Head to Head

Select this option when both sides of the 2-sided document are in the same orientation.

- Head to Toe

Select this option when both sides of the 2-sided document are in opposite orientations.

**■Original Orientation**

Specify the orientation of the loaded document.

When you load the top edge of the document against the left side of the document glass or the document feeder, and then select [Sideways Images], the document is displayed in the correct orientation when viewed on your computer screen.

Load the document in the [Sideways Images] orientation when [File Format] is set to [TIFF/JPEG Auto Select], [TIFF], or [JPEG]. The document is displayed in the [Sideways Images] orientation when viewed on your computer screen.

**Note** • If the [Original Orientation] setting differs from the actual document orientation, the machine may not detect the top of the document correctly.

- Upright Images

Select this option when placing the top edge of the document against the top side of the document glass or document feeder.

- Sideways Images

Select this option when placing the top edge of the document against the left side of the document glass or the document feeder.

## Original Type (Selecting the Document Type)

When you select [Black & White] in [Color Scanning], select the document type.

- 1 From the menu displayed by selecting [Original Type], select any option.

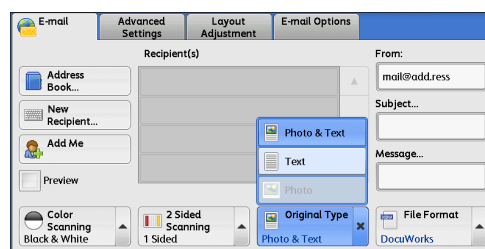
**■Photo & Text**

Select this option when scanning a document that contains both text and photos. The machine automatically identifies text and photo areas to scan each area with optimum quality.

**■Text**

Select this option when scanning text clearly.

■ **Photo**

Select this option when scanning photos.

**Note** • [Photo] is not selectable when [Searchable Text] is set to [Searchable] on the [File Format] screen.

**File Format (Selecting a File Format for Output Data)**

You can select a file format for scanned data.

- 1 From the menu displayed by selecting [File Format], select any option.

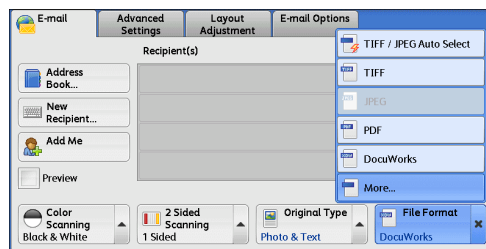

■ **TIFF/JPEG Auto Select**

Automatically selects JPEG or TIFF. The file format is determined for each page: [JPEG] for full-color and grayscale pages, and [TIFF] for monochrome pages.

■ **TIFF**

Saves scanned data in TIFF format.

■ **JPEG**

Saves scanned data in JPEG format. This option is selectable when either [Color] or [Grayscale] is selected in [Color Scanning].

■ **PDF**

Saves scanned data in PDF format.

**Note** • The version of PDF files is Adobe® Acrobat® 4.0 (PDF 1.3).

■ **DocuWorks**

Saves scanned data in DocuWorks format.

**Note** • To browse or print DocuWorks files on a computer, one of the following software is required:

- DocuWorks 4.0 or later
- DocuWorks Viewer Light 4.0 or later
- DocuWorks Viewer Light for Web 4.0 or later

■ **More**

Displays the [File Format] screen.

Refer to "[File Format] Screen" (P.242).

**[File Format] Screen**

This screen allows you to select all available options for File Format.

## 1 Select any option.

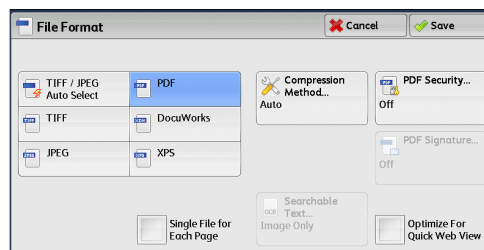

### ■ TIFF/JPEG Auto Select

Automatically selects JPEG or TIFF. The file format is determined for each page: [JPEG] for full-color and grayscale pages, and [TIFF] for monochrome pages.

### ■ TIFF

Saves scanned data in TIFF format.

### ■ JPEG

Saves scanned data in JPEG format. This option is selectable when either [Color] or [Grayscale] is selected in [Color Scanning].

### ■ PDF

Saves scanned data in PDF format.

**Note** • The version of PDF files is Adobe® Acrobat® 4.0 (PDF 1.3).

### ■ DocuWorks

Saves scanned data in DocuWorks format.

**Note** • To browse or print DocuWorks files on a computer, one of the following software is required:

- DocuWorks 4.0 or later
- DocuWorks Viewer Light 4.0 or later
- DocuWorks Viewer Light for Web 4.0 or later

### ■ XPS

Saves scanned data in XPS format.

### ■ Compression Method

Allows you to select a compression method for scanned image data.

**Note** • When you select [Auto], the following compression methods will be used:

- When [Original Type] is set to [Photo & Text] or [Text] for black-and-white images: MMR
- When [Original Type] is set to [Photo] for black-and-white images: MH
- For grayscale and color images: JPEG

• When you select [TIFF], [DocuWorks], or [XPS] and then select [Manual Select] in [Compression Method] under [File Format], you can select a compression method from [MH] and [MMR] under [Black & White Pages].

• If you select [PDF] and then select [Manual Select] in [Compression Method] under [File Format], you can select a compression method from [MH], [MMR], [JBIG2 Arithmetic Encoded], and [JBIG2 Huffman Encoded] under [Black & White Pages], and one from [JPEG] and [Flate] under [Grayscale/Color Pages]. Selecting [Flate] saves the image data with higher compression than [JPEG].

### ■ Searchable Text

Allows you to select whether to perform character recognition in PDF and DocuWorks files.

When [Searchable Text] is set to [Searchable], the following settings are available.

Setting Item		When [MRC High Compression] is Set to [No]	When [MRC High Compression] is Set to [On]
E-mail/ Store to Folder/ Network Scanning/ Scan to PC/ Store & Send Link/ Store to USB	Color Scanning	Black & White <sup>*1</sup> , Auto Detect, Color, Grayscale	Auto Detect, Color, Grayscale
	Original Type	Photo & Text, Text	
	File Format	PDF, DocuWorks	
Advanced Settings	Color Space <sup>*2</sup>	sRGB	
Layout Adjustment	Resolution	200 dpi, 300 dpi	
	Reduce/ Enlarge	100%	<b>Note</b> • [Auto %] is not supported.

\*1 Only [Black & White] is available for some models. An optional component is required to select options other than [Black & White]. For more information, contact our Customer Support Center.

\*2 [Color Space] may not appear for some models, or may not appear on the screen depending on the setting in the System Administration mode. For more information, refer to "5 Tools" > "Scan Service Settings" > "Other Settings" > "Color Space" in the Administrator Guide, and "Color Space (Specifying the Color Space)" (P.271).

#### ■ Add Thumbnail

Allows you to attach thumbnails to DocuWorks and XPS files when [DocuWorks] or [XPS] is selected. A thumbnail is a reduced, small file size image that helps you check the file contents.

#### ■ Single File for Each Page

Saves each page as a single file in the specified format.

**Note** • When you use the Store to Folder or Network Scanning service, files cannot be split.

#### ■ PDF Security

Displays the [File Format - PDF Security] screen.

Allows you to configure security on the data saved as a PDF file to prevent unauthorized access.

Refer to "[File Format - PDF Security] Screen" (P.246).

#### ■ PDF Signature

Displays the [File Format - PDF Signature] screen.

A visible signature added to a file enables to detect alterations in the file, or to prevent impersonation of the sender.

To verify the signature with Adobe Acrobat, select [Digital Signatures] under [Preferences] on Acrobat, and then select the following option for [When Verifying].

- Acrobat 6.0.x : Windows Digital Certificate Security
- Acrobat 7.0.x : Adobe Default Security
- Acrobat 8.0.x : Adobe Default Security

- Off

No visible signature is added.

- On

Adds a visible signature using the certificate of the machine.

- Signature Location



Select the position where the signature is displayed when you select [On] in [PDF Signature].

When you select [Invisible Signature], an invisible signature is added using the certificate of the machine.

- Note**
- The certificate of the machine is used for PDF digital signature. A user certificate cannot be used for the digital signature.

#### ■Optimize For Quick Web View

Optimizes the PDF file so that it is displayed faster on a web browser.

#### ■DocuWorks Security

Displays [File Format - DocuWorks Security] screen.

Allows you to configure security on the data saved as a DocuWorks file to prevent unauthorized access.

Refer to "[File Format - DocuWorks Security] Screen" (P.248).

#### ■DocuWorks Signature

Displays the [File Format - DocuWorks Signature] screen.

A visible signature added to a file enables to detect alterations in the file, or prevent impersonation of the sender.

- Off

No visible signature is added.

- On

Adds a visible signature using the certificate of the machine.

- Signature Location

Select the position where the signature is displayed when you select [On] in [DocuWorks Signature].

- Note**
- The certificate of the machine is used for DocuWorks digital signature. A user certificate cannot be used for the digital signature.

#### ■XPS Signature

Displays the [File Format - XPS Signature] screen.

A visible signature added to a file enables to detect alterations in the file, or prevent impersonation of the sender.

- Off

No visible signature is added.

- On

Adds a visible signature using the certificate of the machine.

#### [File Format - Searchable Text] Screen

Allows you to select whether to make text searchable or not.

1 Select any option.

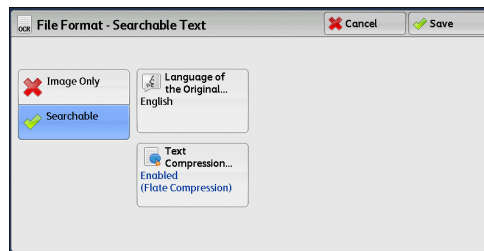

**Language of the Original**

Allows you to select a language to identify the text on the original document.

**Text Compression**

Allows you to select whether to compress the text areas of the document when using the Searchable Text feature.

**Important** • Note the following when [Searchable Text] is set to [Searchable].

- When the text on the document is small (10 points or smaller), scan the document with high resolution (300 dpi).
- Color scanning is recommended when the document has outlined white text, or when it has text placed on a dark background.
- In the following cases, the Searchable Text feature may not function properly.
  - If the document is not loaded correctly and thus the text is slanted, or if the text on the document is in different orientations
  - If the text on the document is decorated (italic, hatching, strike-through, etc.)
  - If the document has background patterns or noise
  - If the text on the document is handwritten

**[File Format - PDF Security] Screen**

This screen allows you to encrypt a PDF file with a password, and assign the access privileges for the file operation.

1 Select any option.

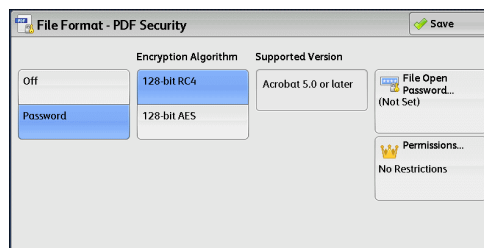

**Off**

The file is not encrypted, and no access privilege is assigned.

**Password**

Encrypts the file using a password.

**Encryption Algorithm**

Allows you to specify the encryption method.

- 128-bit RC4

Encrypts the file by the 128-bit RC4 method. Files encrypted by this method can be opened with Adobe® Acrobat® 5.0 or later.

**Important** • When the 128-bit RC4 method is used to encrypt a file, and [PDF Signature] is selected, files can be opened only with Adobe® Acrobat® 6.0 or later.

- 128-bit AES

Encrypts the file by the 128-bit AES method. Files encrypted by this method can be opened with Adobe® Acrobat® 7.0 or later.

#### ■Supported Version

Displays the supported versions of Adobe® Acrobat® for encryption.

#### ■File Open Password

Displays the [PDF Security - File Open Password] screen.

If you select [On] and set a password, the password is required to open the file.

You can enter a password with up to 32 characters.

#### ■Permissions

Displays the [PDF Security - Permissions] screen.

Refer to "[PDF Security - Permissions] Screen" (P.247).

### [PDF Security - Permissions] Screen

This screen allows you to assign access privileges to a file.

- 1 Select [Permissions].

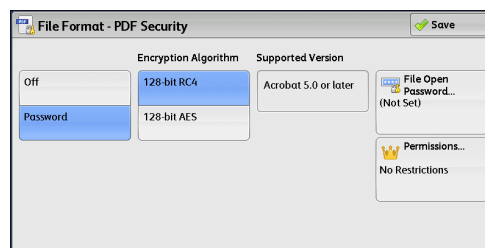

- 2 Select [Security Password].

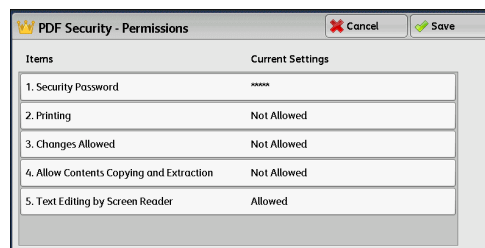

- 3 Select [On].
- 4 Enter the security password, and select [Save].
- 5 Likewise, re-enter the security password, and select [Save].
- 6 Select any option.

#### ■Security Password

Displays the [PDF Security - Security Password] screen.

[Security Password] allows to assign access privileges to files. The password is required to change the access privileges or to perform unauthorized operations.

You can enter a password with up to 32 characters.

#### ■Printing

Displays the [Permissions - Printing] screen.

Specify whether to allow printing the file. If allowed, select the print resolution.

### ■Changes Allowed

Displays the [Permissions - Changes Allowed] screen.

Specify whether to allow changing the file contents, such as inserting pages or adding notes.

### ■Allow Contents Copying and Extraction

Displays the [Allow Contents Copying and Extraction] screen.

Specify whether to allow copying the file contents, such as text and images.

### ■Text Editing by Screen Reader

Displays the [Text Editing by Screen Reader] screen.

Select [Allowed] to use application software, such as a screen reader, that reads out PDF documents for the visually handicapped.

## [File Format - DocuWorks Security] Screen

This screen allows you to encrypt a DocuWorks file with a password, and assign the access privileges for the file operation.

- 1 Select any option.

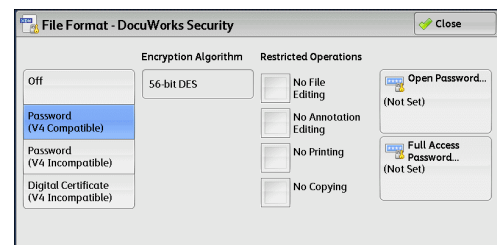

### ■Off

The file is not encrypted, and no access privilege is assigned.

### ■Password (V4 Compatible)

Encrypts the file by the 56 bit DES method using a password. Files encrypted by this method can be opened with DocuWorks Ver. 4.0 or later.

Select [Open Password] to set a password.

### ■Password (V4 Incompatible)

Encrypts the file by the 128 bit AES method using a password. Files encrypted by this method can be opened with DocuWorks Ver. 5.0 or later.

Select [Open Password] to set a password.

### ■Digital Certificate (V4 Incompatible)

Encrypts the file by the 128 bit AES method using a certificate. Files encrypted by this method can be opened with DocuWorks Ver. 5.0 or later.

Select [Certificate] to set a certificate.

- Note**
- If you encrypt a file using a certificate without Basic Constraints, you cannot use DocuWorks Ver. 5.0.1 and Ver. 6.0.1 to open the file. To use such certificates, use DocuWorks Ver. 5.0.2, or Ver. 6.0.2 or later.
  - When you select [Full Access Password] or [Open Password] in [Digital Certificate (V4 Incompatible)], the same certificate name may be redundantly displayed in [Security Settings] of a DocuWorks document to be generated, in the following conditions. However, this does not affect the operation.
    - When you created a job flow on the machine, the same certificate was selected redundantly.

- The certificate data was obtained from an LDAP server, and the same certificate was selected redundantly.

### ■ Encryption Algorithm

Displays the encryption methods.

### ■ Restricted Operations

Select file operations to assign access privileges. When assigning access privileges, set [Full Access Password].

### ■ Open Password

Displays the [DocuWorks Security - Open Password] screen.

If you select [On] and set a password, the file is encrypted. To open the file, the password is required. The access privileges set in [Restricted Operations] are assigned.

You can enter a password with up to 32 characters.

### ■ Full Access Password

Displays the [DocuWorks - Full Access Password] screen.

If a password is set, the password is required to change the access privileges set in [Restricted Operations].

You can enter a password with up to 32 characters.

### ■ Certificate

Displays the [DocuWorks Security - Certificate] screen.

Refer to "[DocuWorks Security - Certificate] Screen" (P.249).

## [DocuWorks Security - Certificate] Screen

This screen allows you to specify parties to whom the encrypted file is disclosed, and addresses to which privileges are assigned.

**Note** • You can specify up to 50 parties to whom the encrypted file is disclosed, on the [DocuWorks Security - Certificate] screen.

### ■ List all public entries

Displays the local address list.

### ■ Search Public

Searches recipients in the local address list.

### ■ Search Network

Searches recipients in the remote address list.

**Important** • To display [Search Network], prior settings are required in the System Administration mode.

### ■ [ ? ] button

Displays the [Certificate Details] screen.

Certificate information, such as issuer, expiration date, and persons to whom the certificate is issued, is displayed.

### ■ Name/E-mail Address/DN

Lists names and their e-mail addresses.

■ **Add**

Select this button to add the certificate as one of the certificates of persons who are allowed to open the file.

■ **Grant full access to this file**

Configure certificates of persons who are allowed to change access privileges including editing or operating the file (full access).

## Network Scanning

This section describes the procedure to select features on the [Network Scanning] screen. On the [Network Scanning] screen, you can scan documents after specifying a file (job template) saving scanning conditions, information on the forwarding destination server, and others.

This feature creates job templates on a computer using CentreWare Internet Services. Scanned data is converted to the format specified in a job template, and is automatically sent to a server. The machine allows you to automatically retrieve job templates stored in a server. The following describes features available on the [Network Scanning] tab.

**Note** • If characters not supported by the machine are used in names or descriptions of job templates, the characters will not be displayed or will be garbled on the screen. For information on characters available for use, refer to "15 Appendix" > "Notes and Restrictions" > "Notes and Restrictions on the Use of the Machine" in the Administrator Guide.

When Scan to Home is enabled, and when the Remote Access feature is available, the scanned document can be transferred to a different destination according to an authenticated user.

**Important** • When using the Scan to Home feature in computer environment earlier than Windows 98/NT, a destination user name in the earlier format (domain name\user name) will not be determined automatically.  
Before scanning, change the user name with which you can log in correctly.

**Note** • You can configure the Scan to Home feature from CentreWare Internet Services.

For information on how to use CentreWare Internet Services, refer to the help of CentreWare Internet Services.

- 1 Select [Network Scanning] on the [Services Home] screen.

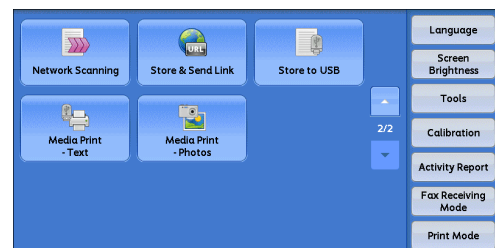

- 2 Select a job template, and then select a feature on the [Network Scanning] screen.

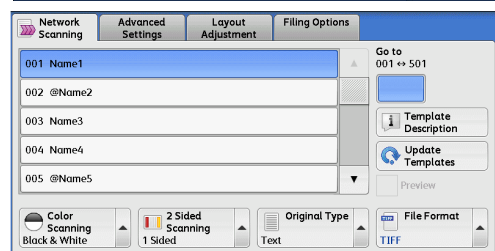

### ■ Job Template

Select a job template for the scan job.

- **DEFAULT** - This is the default job template. This template is used as a base template when a new template is created on CentreWare Internet Services. This template cannot be deleted. It can be edited and returned to the factory-default template only by the system administrator.
- **@S2HOME** - This is the template for the Scan to Home feature. Selecting this template verifies a user and sends scanned data to the folder prespecified for the user.

- Note**
- The job template "@S2HOME" is displayed only when the remote authentication is enabled, and also [Enabled] is selected in [Status] under [Properties] > [Services] > [Scan to Home] on CentreWare Internet Services.
  - The job template name "@S2HOME" can be changed by the system administrator from CentreWare Internet Services.

For information on how to use CentreWare Internet Services, refer to the help of CentreWare Internet Services.

#### ■ Go to

Use the numeric keypad to enter a 3-digit job template number. The job template then appears at the top of the list.

#### ■ Template Description

Displays the [Template Description] screen on which you can view the description of the job template. This button is displayed only when the description has been added to a job template.

#### ■ Update Templates

Refreshes the information. If a created job template has not been displayed, selecting [Refresh] will display the job template.

## Preview (Previewing the Scanned Images during a Scan Job)

---

You can preview the scanned images while scanning the document.

For more information, refer to "Preview (Previewing the Scanned Images during a Scan Job)" (P.239).

## Color Scanning (Selecting an Output Color)

---

You can set the output color to scan a document.

For more information, refer to "Color Scanning (Selecting an Output Color)" (P.239).

## 2 Sided Scanning (Scanning Both Sides of a Document)

---

You can automatically scan both sides of a 2-sided document.

By setting the binding style, both sides are scanned in the same orientation.

For more information, refer to "2 Sided Scanning (Scanning Both Sides of a Document)" (P.240).

## Original Type (Selecting the Document Type)

---

You can select the type of the document.

For more information, refer to "Original Type (Selecting the Document Type)" (P.241).

## File Format (Selecting a File Format for Output Data)

---

You can select a file format for output data.

For more information, refer to "File Format (Selecting a File Format for Output Data)" (P.242).



## Scan to PC

This section describes the procedure to select features on the [Scan to PC] screen. The Scan to PC service allows you to scan documents and send the scanned data to a network computer via the FTP or SMB protocol. The following describes features available on the [Scan to PC] tab. The following shows the reference section for each feature.

Transfer Protocol (Selecting a Transfer Protocol) .....	253
Address Book (Specifying a Destination PC Using the Address Book).....	254
Browse (Specifying a Destination PC by Browsing Your Network).....	255
Specifying a Destination (Specifying a Destination PC Using the Screen Keyboard) .....	256

**Note**

- Before scanning, you must create a shared folder on your computer to save scanned data in. Furthermore, if you use the FTP protocol, you must set the FTP service. For information on the computer settings, refer to the documentation provided with your operating system. For information on supported operating systems, refer to "15 Appendix" > "Specifications" in the Administrator Guide.

You can customize the layout of the features displayed on the [Scan to PC] screen. For more information, refer to "5 Tools" > "Scan Service Settings" > "First Tab" in the Administrator Guide.

- 1 Select [Scan to PC] on the [Services Home] screen.

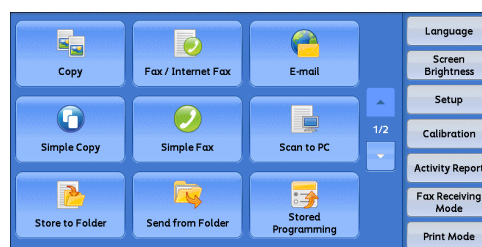

- 2 Select a feature on the [Scan to PC] screen.

**Note**

- Fields displayed on the screen vary depending on the protocol you have selected.

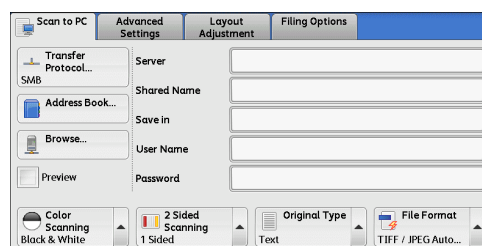

## Transfer Protocol (Selecting a Transfer Protocol)

You can select a transfer protocol using the following procedure.

- 1 Select [Transfer Protocol].

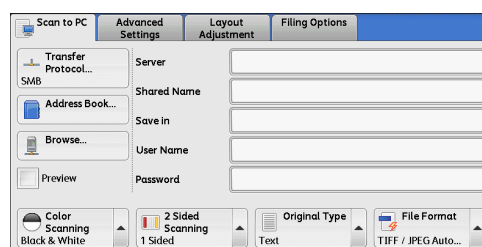

2 Select any option.

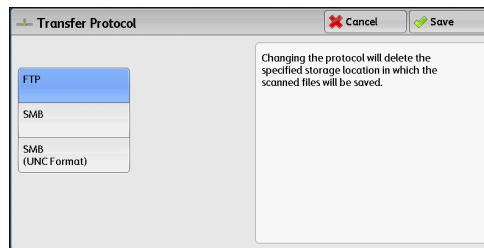

■FTP

Transfers using the FTP protocol.

■SMB

Transfers using the SMB protocol.

■SMB (UNC Format)

Transfers using the SMB protocol (UNC Format).

UNC stands for Universal Naming Convention and its format is as follows:  
\\host name\shared name\directory name

## Address Book (Specifying a Destination PC Using the Address Book)

You can specify the server name, the name of the user who can decrypt an encrypted file, and other information from the Address Book.

For information on how to set the Address Book, refer to "5 Tools" > "Setup" > "Add Address Book Entry" in the Administrator Guide.

1 Select [Address Book].

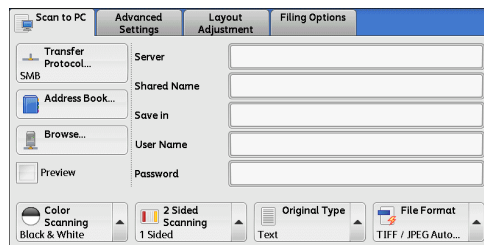

2 Select the destination to store the data in.

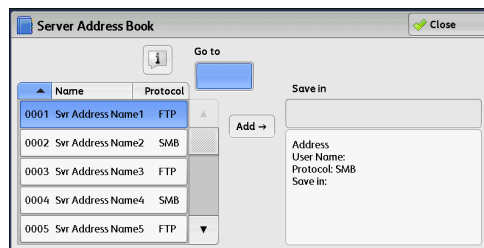

3 Select [Add].

**Important** • You can only use destinations configured for SMB or FTP.

**Note** • Select [▲] to return to the previous screen or [▼] to move to the next screen.

■Name, Protocol

Lists recipient names and protocols.

**■Add**

Adds a selected recipient to the [Save in] box.

**■Save in**

Displays a selected recipient.

**■Go to**

Enter a recipient number using the numeric keypad to display the recipient at the top of the list.

**■[1] button**

Allows you to confirm information, such as [Name] and [Server Name/IP Address], on the screen displayed.

## Browse (Specifying a Destination PC by Browsing Your Network)

This feature displays a hierarchy consisting of server names and folders. You can specify a save destination by tracing the hierarchy.

- 1 Select [Browse].

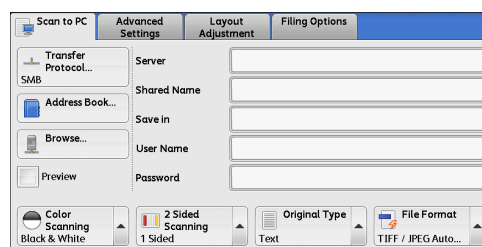

- 2 Select the destination to save the data in. Select [Previous] or [Next] to move to another level.

**Important** • You can specify recipients for SMB only.

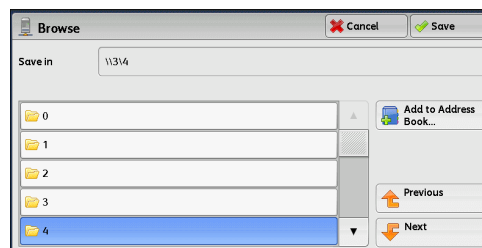
**■Save in**

Shows the current location in the hierarchy.

**■Add to Address Book**

Displays the [Add to Address Book] screen. Refer to "[Add to Address Book] Screen" (P.256).

**■Previous**

Allows you to move to the upper directory.

**Note** • This button is grayed out if there is no upper directory.

**■Next**

Allows you to move to the lower directory.

**Note** • This button is available when a folder is selected.

### [Add to Address Book] Screen

This screen allows you to register the save destination specified in [Browse], in the Address Book.

- 1 Select [Add to Address Book].

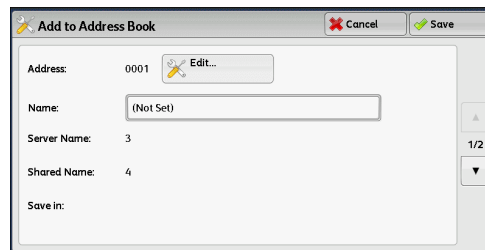

- 2 Select [Save].

#### ■Address

To change the address number, select [Edit] and then the desired number.

#### ■Name

To change the recipient name, enter a new name with the keyboard displayed by selecting [Name].

**Note** • The recipient name may not be displayed depending on the settings.

## Specifying a Destination (Specifying a Destination PC Using the Screen Keyboard)

Enter information in the fields provided for the selected protocol, to specify a forwarding destination.

- 1 Select the item to be set.

**Note** • You can also select [Address Book] to enter information.  
• Fields displayed on the screen vary depending on the selected protocol.

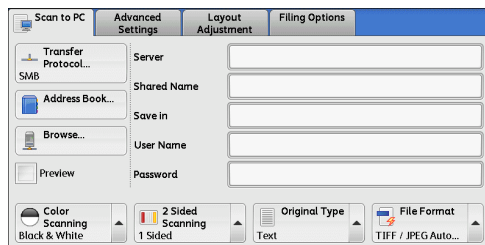

- 2 Enter information using the keyboard displayed on the screen.

For information on how to enter characters, refer to "Entering Text" (P.58).

**Note** • To delete characters, select [Backspace].

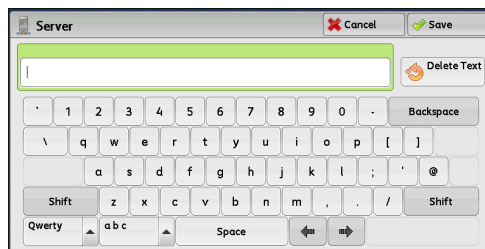

#### ■Server

This option is displayed when you select [FTP] or [SMB] in [Transfer Protocol]. Enter a server name or IP address. When the save location is in the DFS namespace on Windows, enter a domain name or server name. Up to 64 characters are allowed.

The following are examples:

- For [FTP]:  
 Server name: myhost.example.com  
 (myhost: host name, example.com: domain name)  
 IP address: 192.168.1.100
- For [SMB]:  
 Server name: myhost  
 IP address: 192.168.1.100

### ■ Shared Name

This option is displayed when you select [SMB] in [Transfer Protocol]. Enter a shared name. When the save location is in the DFS namespace on Windows, enter a root name. Up to 64 characters are allowed.

### ■ Save in

This option is displayed when you select [FTP] or [SMB] in [Transfer Protocol]. Enter a directory path. When the save location is in the DFS namespace on Windows, enter a folder name. Up to 128 characters are allowed.

- Note**
- The folder name is the same as the link name for Windows Server 2003.
  - When you select [FTP] in [Transfer Protocol] and the save location is Macintosh or Unix at the same time, name a folder to be created as the save location with single-byte characters. Also, enter a folder name with single-byte characters when specifying a destination from the machine.

- For [FTP]:  
 Example: mydoc/Scan
- For [SMB]:  
 Example: mydoc\Scan

### ■ Save in

This option is displayed when you select [SMB (UNC Format)] in [Transfer Protocol].

Enter the following directory path: "\\Host Name\Shared Name\Directory Name". When the save location is in the DFS namespace on Windows, enter "\\Domain Name\Root Name\Folder Name" or "\\Server Name\Root Name\Folder Name". Up to 260 characters are allowed.

### ■ User Name

Enter the user name of the computer you are forwarding to. When a user name is not required for the destination, this field can be skipped.

When you select [FTP] in [Transfer Protocol], up to 97 characters are allowed.

When you select [SMB] in [Transfer Protocol], use one of the following formats:

- For Active Directory:  
 User name@Domain name (user name: up to 32 characters, domain name: up to 64 characters)  
 Example: fuji@example.com (fuji: user name, example.com: domain name)
- For Windows NT Domain:  
 Domain name\User name (domain name: up to 64 characters, user name: up to 32 characters)  
 Example: example\fuji (example: domain name, fuji: user name)

- For workgroups:  
Local user (up to 32 characters)  
Example: Fuji-Taro

■ **Password**

Enter the password for the user name. Up to 32 characters are allowed.

---

## **Preview (Previewing the Scanned Images during a Scan Job)**

---

You can preview the scanned images while scanning the document.

For more information, refer to "Preview (Previewing the Scanned Images during a Scan Job)" (P.239).

---

## **Color Scanning (Selecting an Output Color)**

---

You can set the output color to scan a document.

For more information, refer to "Color Scanning (Selecting an Output Color)" (P.239).

---

## **2 Sided Scanning (Scanning Both Sides of a Document)**

---

You can automatically scan both sides of a 2-sided document.

By setting the binding style, both sides are scanned in the same orientation.

For more information, refer to "2 Sided Scanning (Scanning Both Sides of a Document)" (P.240).

---

## **Original Type (Selecting the Document Type)**

---

You can select the type of the document.

For more information, refer to "Original Type (Selecting the Document Type)" (P.241).

---

## **File Format (Selecting a File Format for Output Data)**

---

You can select a file format for output data.

For more information, refer to "File Format (Selecting a File Format for Output Data)" (P.242).

## Store to Folder

This section describes the procedure to select features on the [Store to Folder] screen. You can scan documents and save the scanned data in a folder of the machine.

The following describes features available on the [Store to Folder] tab.

- Note**
- When [Store to Folder] is selected, [File Format] is disabled.
  - When you use CentreWare Internet Services to retrieve a file from a folder, you can set [Searchable Text] if all scanned images of the file in the folder are set as follows:
    - Image Size: 15 x 15 mm to 309 x 432 mm
    - Original Type: Photo & Text, Text
    - Color Space: sRGB
    - Resolution: 200dpi, 300dpi
    - Reduce/Enlarge: 100%

You need to create a folder in advance. For more information on how to create a folder, refer to "5 Tools" > "Setup" > "Create Folder" in the Administrator Guide.

You can customize the layout of the features displayed on the [Store to Folder] screen. For more information, refer to "5 Tools" > "Scan Service Settings" > "First Tab" in the Administrator Guide.

- 1 Select [Store to Folder] on the [Services Home] screen.

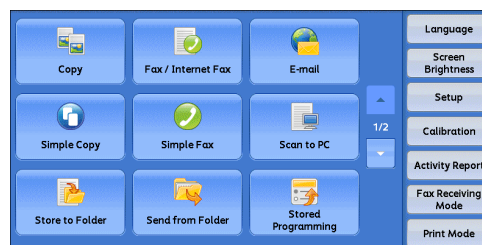

- 2 Select a feature on the [Store to Folder] screen.

- Note**
- If a passcode is set for the folder, the passcode entry screen may appear. Enter the passcode and select [Confirm]. If you have forgotten the passcode, set the folder passcode in the System Administration mode again.

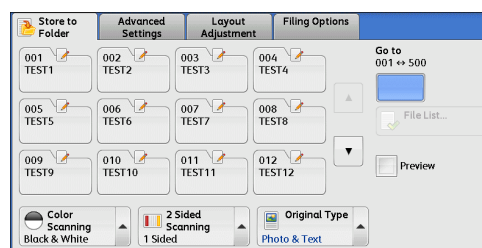

### ■Folder

Select a folder to save the scanned data in.

- Note**
- Select [▲] to return to the previous screen or [▼] to move to the next screen.

### ■Go to

Use the numeric keypad to enter a 3-digit folder number. The folder then appears at the top of the list.

### ■File List

Select a folder and then select this button to display the [File List] screen. You can confirm or delete files stored in the folder.

## Color Scanning (Selecting an Output Color)

You can specify the output color to scan a document.

For more information, refer to "Color Scanning (Selecting an Output Color)" (P.239).

## **2 Sided Scanning (Scanning Both Sides of a Document)**

---

You can automatically scan both sides of a 2-sided document.

By setting the binding style, both sides are scanned in the same orientation.

For more information, refer to "2 Sided Scanning (Scanning Both Sides of a Document)" (P.240).

## **Original Type (Selecting the Document Type)**

---

You can select the type of the document.

For more information, refer to "Original Type (Selecting the Document Type)" (P.241).

## **Preview (Previewing the Scanned Images during a Scan Job)**

---

You can preview the scanned images while scanning the document.

For more information, refer to "Preview (Previewing the Scanned Images during a Scan Job)" (P.239).



## Store to USB

This section describes the procedure to select features on the [Store to USB] screen. The Store to USB service allows you to scan documents and save the scanned data to a USB memory device. The following describes features available on the [Store to USB] tab.

Save in (Specifying a Storage Location in the USB Memory Device).....	262
Details (Displaying the Details of a Storage Location in the USB Memory Device).....	263
Preview (Previewing the Scanned Images during a Scan Job) .....	264
Color Scanning (Selecting an Output Color) .....	264
2 Sided Scanning (Scanning Both Sides of a Document) .....	264
Original Type (Selecting the Document Type) .....	264
File Format (Selecting a File Format for Output Data).....	264

**Important** • Before removing the USB memory device, make sure that the screen indicating that data is being transferred is not displayed. If you remove the USB memory device while the data is being stored, the data in the device may be damaged. You can also view the [Job Status] screen to confirm if the data has been stored to the USB memory device.

**Note**

- An optional component is required to use this service. For more information, contact our Customer Support Center.
- A USB memory device encrypted with software is not supported.
- Use the following USB memory devices:
  - A formatted USB memory device
  - A USB 2.0 compliant memory device (USB 1.1 is not supported.)
  - A USB memory device with a storage capacity of up to 128 GB
- Commercially available Memory Card Reader with single slot <sup>\*1</sup> can be used for this feature, but its safe performance is not guaranteed. When a Memory Card Reader with multi-slot <sup>\*2</sup> is used, only one particular slot is available. And which slot is available differs according to models and slot of media. Memory Card that you want to use is not always available. Safe performance of a Memory Card Reader with multi-slot is not guaranteed, either.

\*1: Media/Memory Card that has one slot. Some allows only one type of media/Memory Card, while others allows more than one types (ex. SD card, xD-Picture Card).

\*2: Media/Memory Card that has two or more slots.

You can customize the layout of the features displayed on the [Store to USB] screen. For more information, refer to "5 Tools" > "Scan Service Settings" > "First Tab" in the Administrator Guide.

- 1 Insert the USB memory device into the USB memory slot on the control panel.
- 2 Select [Store to USB] on the [Services Home] screen.
- 3 Select a feature on the [Store to USB] screen.

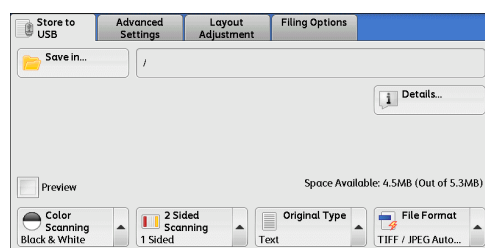
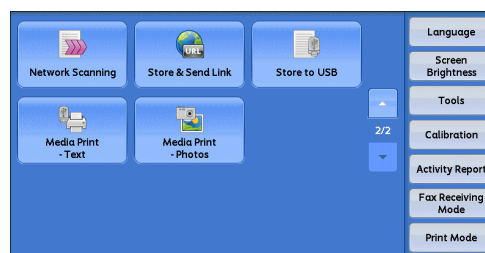

- Important**
- Data stored in a USB memory device may be lost or damaged in the following cases. Make sure to back up the data in the device before use.
    - When ejecting the medium or switching the power off/on by methods other than described in this guide.
    - When receiving the effect of electrical noise or an electrical discharge
    - When a failure occurs or repairing
    - When receiving damage resulting from a natural calamity
  - We assume no responsibility for any direct and indirect damages arising from or caused by such data loss.
- Note**
- If you do not specify the file storage location, the scanned data is saved in the root directory.

## Save in (Specifying a Storage Location in the USB Memory Device)

You can specify a file storage location in the USB memory device.

- 1 Select [Save in].

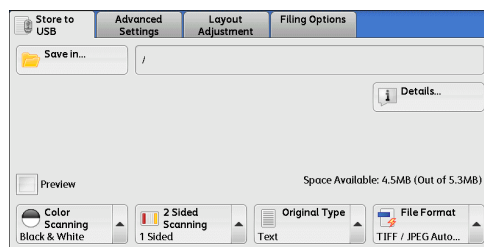

- 2 Select a folder to save the data in.

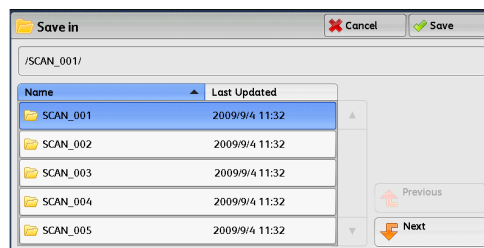

- Note**
- Select [▲] to return to the previous screen or [▼] to move to the next screen.
  - You can sort the order of folders displayed in ascending or descending order by selecting [Name] or [Last Updated].
  - Up to 900 folder names can be displayed in the list of [Save in]. File names are not displayed.
  - If a folder or file name has more than 170 characters long, the folder or file name is not displayed.
  - Folders in the DCIM folder of digital cameras cannot be displayed. Thus, you cannot save files in these folders either.
  - Folder names which include characters that the machine does not support may not be correctly displayed. If you specify the folders as file storage locations, an error occurs. For more information on characters that the machine supports, refer to "Entering Text" (P.58).
  - The machine does not distinguish between upper and lower cases of folder and file names that are created in Windows environment and that consist of eight characters or less. The names for these folders and files are displayed in capital letters.
  - If a full path (a string of folder and file names in all directories) of the file created exceeds 257 characters long, an error occurs.

- 3 Select [Save].

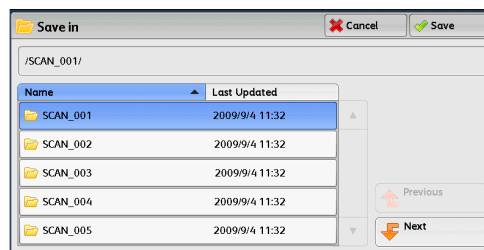

#### ■ Previous

Allows you to move to the upper directory.

**Note** • This button is grayed out if there is no upper directory.

#### ■ Next

Allows you to move to the lower directory.

**Note** • This button is available when a folder is selected.

## Details (Displaying the Details of a Storage Location in the USB Memory Device)

Selecting [Details] displays the [Details] screen.

### [Details] Screen

This screen displays the folder directory in the USB memory device.

- 1 Specify the folder directory, and then select [Save].

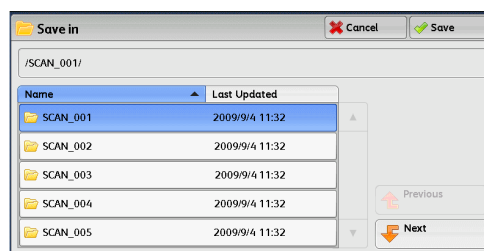

- 2 Select [Details].

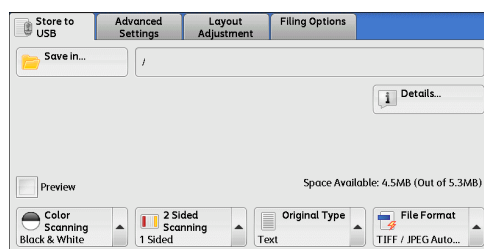

- 3 The folder and file names in all directories to be saved are displayed.

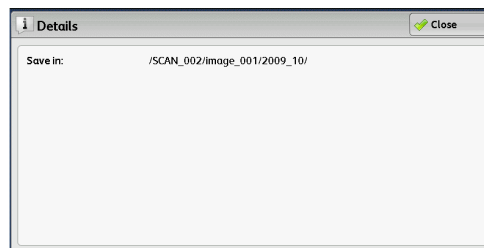

## **Preview (Previewing the Scanned Images during a Scan Job)**

---

You can preview the scanned images while scanning the document.

For more information, refer to "Preview (Previewing the Scanned Images during a Scan Job)" (P.239).

## **Color Scanning (Selecting an Output Color)**

---

You can set the output color to scan a document.

For more information, refer to "Color Scanning (Selecting an Output Color)" (P.239).

## **2 Sided Scanning (Scanning Both Sides of a Document)**

---

You can automatically scan both sides of a 2-sided document.

By setting the binding style, both sides are scanned in the same orientation.

For more information, refer to "2 Sided Scanning (Scanning Both Sides of a Document)" (P.240).

## **Original Type (Selecting the Document Type)**

---

You can select the type of the document.

For more information, refer to "Original Type (Selecting the Document Type)" (P.241).

## **File Format (Selecting a File Format for Output Data)**

---

You can select a file format for output data.

For more information, refer to "File Format (Selecting a File Format for Output Data)" (P.242).

## Store & Send Link

If an authenticated user scans a document, the machine temporarily saves the scanned data, and automatically obtains the user's e-mail address that was registered in advance. Then, the machine sends an e-mail to the user to notify of two URLs: one is for the location to retrieve the scanned data, and the other is for the location to delete the data.

Only the authenticated user who logs in to the machine can be the recipient of an e-mail transmission. The machine cannot send e-mail to multiple recipients.

After receiving the e-mail on a computer, the user can retrieve the scanned data using a web browser.

The following describes features available on the [Store & Send Link] tab.

**Important** • Scan files stored in the machine will be automatically deleted when the retention period expires. This retention period can be specified in [URL File Expiration] by the System Administrator in the range of 1 to 168 hours. The default value is 3 hours. The files are to be always deleted automatically.

- To strengthen security, after retrieving the scanned data, access the URL to delete the scanned data stored in the machine.

**Note**

- An optional component is required to use the Store & Send Link feature. For information, contact our Customer Support Center.
- The Store & Send Link service does not provide document management features, such as backing up/restoring files, deleting all data at one time, listing files, and displaying available storage space.
- The Store & Send Link service allows you to retrieve scanned data without specifying an e-mail address from the Address Book or a folder for each scan job. However, the size of the data and its retention period are restricted on the machine. If you want to avoid these restrictions, use the Scan to PC or E-mail service.

For more information, refer to "5 Tools" > "Scan Service Settings" > "Other Settings" > "Store & Send Link - Maximum File Size" and "URL File Expiration" in the Administrator Guide.

You can customize the layout of the features displayed on the [Store & Send Link] screen. For more information, refer to "5 Tools" > "Scan Service Settings" > "First Tab" in the Administrator Guide.

- 1 Press the <Log In/Out> button on the control panel or select the login information field on the touch screen.
- 2 Enter the user ID.
- 3 Select [Store & Send Link] on the [Services Home] screen.
- 4 Select a feature on the [Store & Send Link] screen.

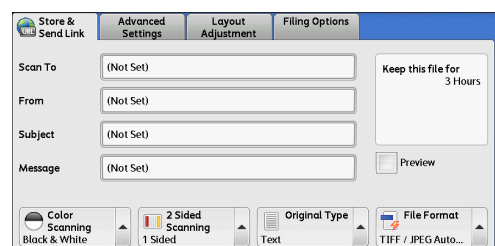
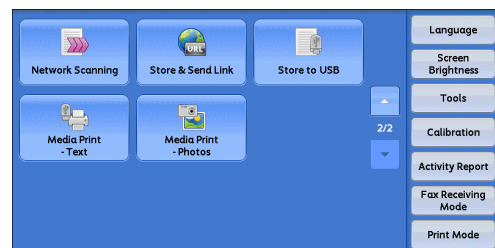

---

## Scan To (Displaying the E-mail Address of the Authenticated User)

---

Automatically obtains the pre-registered e-mail address of the authenticated user.

---

## From (Displaying the E-mail Address of the Authenticated User)

---

Automatically obtains the pre-registered e-mail address of the authenticated user.

---

## Subject (Setting the Subject)

---

You can specify the e-mail subject using the following procedure.

### ■Auto Set

Automatically sets the subject to [Scan Reference from XXX] (where XXX is the host name of the machine).

### ■To set a user-defined subject

- 1 Select [Subject].
- 2 Enter a subject with up to 128 characters using the displayed keyboard.

For information on how to enter characters, refer to "Entering Text" (P.58).

---

## Message (Entering the E-mail Body)

---

You can enter the e-mail body using the following procedure.

- 1 Select [Message].
- 2 Enter a message with up to 512 characters using the displayed keyboard.

For information on how to enter characters, refer to "Entering Text" (P.58).

---

## Color Scanning (Selecting an Output Color)

---

You can set the color mode to scan a document.

For more information, refer to "Color Scanning (Selecting an Output Color)" (P.239).

---

## 2 Sided Scanning (Scanning Both Sides of a Document)

---

You can automatically scan both sides of a 2-sided document.

By setting the binding style, both sides are scanned in the same orientation.

For more information, refer to "2 Sided Scanning (Scanning Both Sides of a Document)" (P.240).

---

## Original Type (Selecting the Document Type)

---

You can select the type of the document.

For more information, refer to "Original Type (Selecting the Document Type)" (P.241).

---

## Preview (Previewing the Scanned Images during a Scan Job)

---

You can preview the scanned images while scanning the document.

For more information, refer to "Preview (Previewing the Scanned Images during a Scan Job)" (P.239).

---

## File Format (Selecting a File Format for Output Data)

---

You can select a file format for output data.

The Store & Send Link service allows you to retrieve scanned data from a computer without password authentication.

To prevent other parties from viewing your scan data, select [PDF] or [DocuWorks] in [File Format] and set a password in [PDF Security] or [DocuWorks Security] before scanning the document.

For more information, refer to "File Format (Selecting a File Format for Output Data)" (P.242).

**Note**

- If you select [TIFF/JPEG Auto Select] or the [Single File for Each Page] check box on the [File Format] screen when scanning a document, a file is downloaded in zip format.

## Advanced Settings

This section describes the features you can select on the [Advanced Settings] screen under [E-mail], [Store to Folder], [Network Scanning], [Scan to PC], [Store & Send Link], or [Store to USB]. The following shows the reference section for each feature.

Photographs (Scanning a Color Photograph).....	268
Image Options (Adjusting Scan Density and Image Sharpness) .....	269
Image Enhancement (Erasing the Background Color of Documents/Adjusting Contrast) .....	270
Shadow Suppression (Suppressing the Document Background).....	270
Color Space (Specifying the Color Space) .....	271

- 1 On the [Services Home] screen, select [E-mail], [Store to Folder], [Network Scanning], [Scan to PC], [Store & Send Link], or [Store to USB]

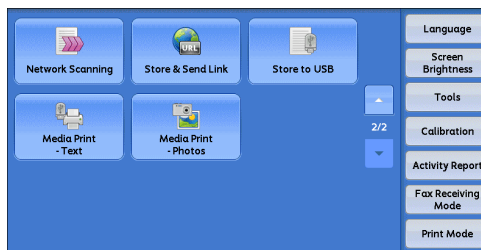
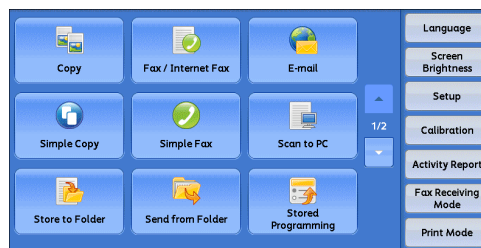

- 2 Select a feature on the [Advanced Settings] screen.

**Note**

- To activate [Color Space], a prior setting must be made in the System Administration mode. For information on the setting procedure, refer to "5 Tools" > "Scan Service Settings" > "Other Settings" > "Color Space" in the Administrator Guide and "Color Space (Specifying the Color Space)" (P.271).

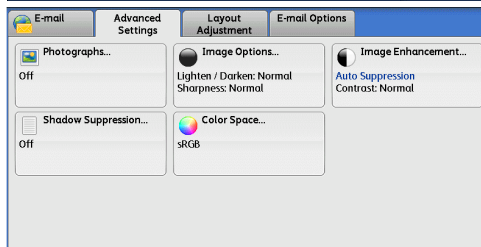

## Photographs (Scanning a Color Photograph)

Use this feature when scanning a color photograph.

This feature is available only when [Color Scanning] is set to [Color].

**Important**

- You cannot use the document feeder with this feature.
- When this feature is enabled, the Shadow Suppression and Background Suppression features cannot be used.



- 1 Select [Photographs].

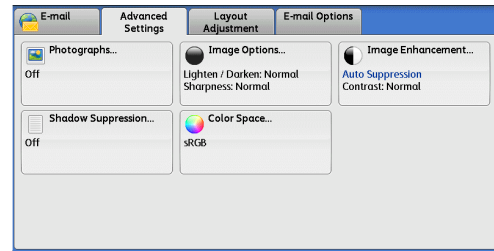

- 2 Select [Enhance Photographs].

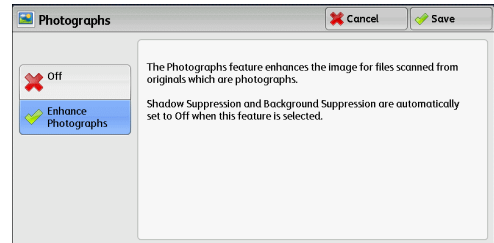

## Image Options (Adjusting Scan Density and Image Sharpness)

This feature allows you to adjust the scan density and image sharpness.

- 1 Select [Image Options].

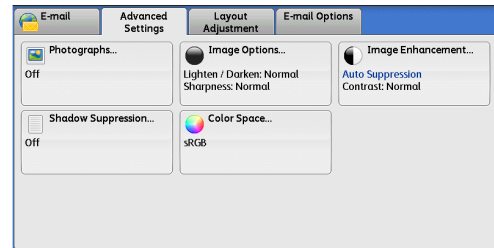

- 2 Select any option.

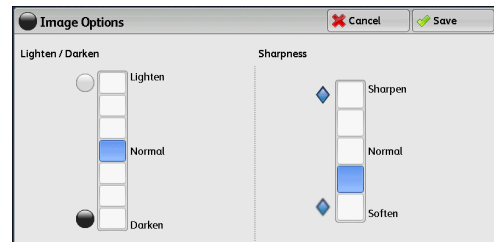

### ■Lighten/Darken

You can select a scan density level from seven levels between [Lighten] and [Darken]. Selecting an upper cell on the bar makes the scan density lighter, and selecting a lower cell makes darker.

### ■Sharpness

You can select a sharpness level from five levels between [Sharpen] and [Soften]. Selecting an upper cell on the bar makes the contours of images sharper, and selecting a lower cell makes softer.

## Image Enhancement (Erasing the Background Color of Documents/ Adjusting Contrast)

This feature allows you to suppress the background color of a document such as newspaper and colored paper. In addition, when [Color Scanning] is set to [Color] or [Grayscale], you can adjust the contrast.

- 1 Select [Image Enhancement].

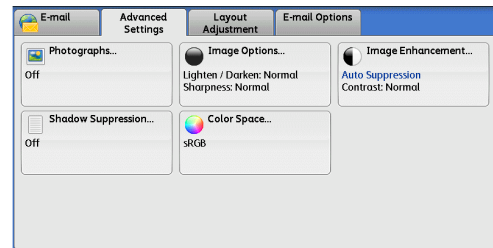

- 2 Set [Background Suppression] and [Contrast].

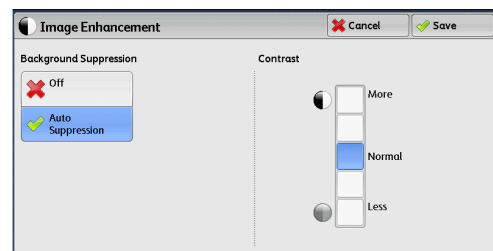

### ■ Background Suppression

- Off  
Scans the document backgrounds with no filtering.
- Auto Suppression  
When [Color Scanning] is set to [Black & White], the background of a document printed on colored paper, such as newspaper, will be suppressed.  
When [Color Scanning] is set to [Color], the background of a document printed on white-color paper will be suppressed.

### ■ Contrast

Allows you to select a contrast level from five levels between [Less] and [More].  
Selecting an upper cell on the bar makes the difference between light and dark areas greater; light areas become lighter and dark areas darker. In contrast, selecting a lower cell on the bar makes the difference between light and dark areas smaller.

## Shadow Suppression (Suppressing the Document Background)

When you scan a 2-sided document printed on thin paper, this feature allows you to suppress the image and colors on the reverse side of each document page from appearing in the scan image.

This feature is available only when [Color Scanning] is set to [Color] or [Grayscale].

**Important** • This feature cannot be used with [Photographs].

1 Select [Shadow Suppression].

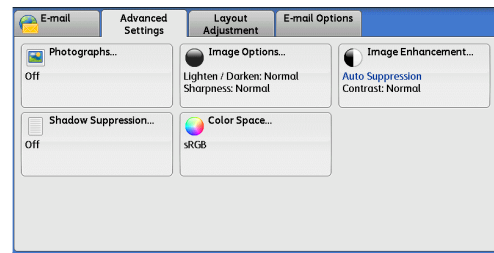

2 Select [Auto Suppression].

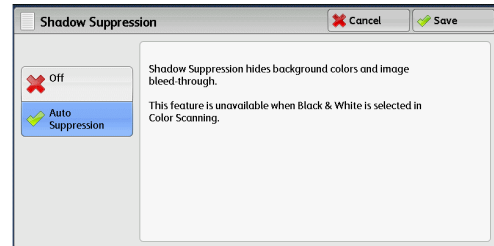

## Color Space (Specifying the Color Space)

This feature allows you to set the color space.

- Note**
- [Color Space] is available when [Color Scanning] is set to [Color].
  - To activate [Color Space] on the [Advanced Settings] screen, a prior setting must be made in the System Administration mode. For more information, refer to "5 Tools" > "Scan Service Settings" > "Other Settings" > "Color Space" in the Administrator Guide.
  - [Device Color Space] is not selectable when [Searchable Text] is set to [Searchable] on the [File Format] screen.

1 Select [Color Space].

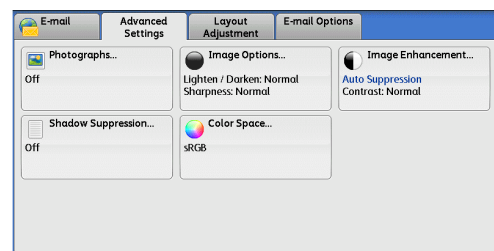

2 Select either [sRGB] or [Device Color Space].

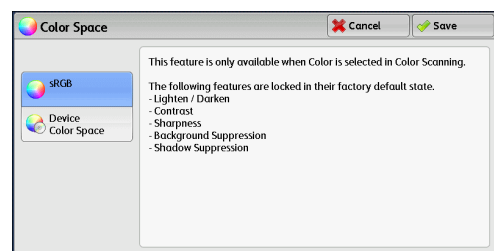

### ■sRGB

Documents are scanned based on color representation (color space) that conforms to sYCC.

### ■Device Color Space

Documents are scanned based on the original color representation (color space) of the machine. Recommended for advanced color processing using high-quality color.

- Note**
- You can find ICC profile data for Device Color Space in the Driver CD Kit. ICC profile is useful when using color processing application and performing special processing of data scanned based on Device Color Space.

- When [Device Color Space] is selected, the following image quality features are changed to their defaults:  
Lighten/Darken, Sharpness, Shadow Suppression, Contrast, Background Suppression
- When [Color Scanning] is set to [Auto Detect], [sRGB] is applied to color pages of the documents.

# Layout Adjustment

This section describes the features you can select on the [Layout Adjustment] screen under [E-mail], [Store to Folder], [Network Scanning], [Scan to PC], [Store & Send Link], or [Store to USB].

The following shows the reference section for each feature.

Resolution (Specifying a Scanning Resolution).....	273
2 Sided Scanning (Scanning Both Sides of a Document) .....	274
Book Scanning (Scanning Facing Pages on Separate Sheets) .....	274
Original Size (Specifying a Scan Size) .....	275
Mixed Size Originals (Scanning Different Size Documents Simultaneously) .....	276
Edge Erase (Erasing Edges and Margin Shadows in the Document) .....	277
Reduce/Enlarge (Specifying a Scanning Ratio).....	279
Original Orientation (Specifying the Orientation of the Loaded Documents).....	279

- 1 On the [Services Home] screen, select [E-mail], [Store to Folder], [Network Scanning], [Scan to PC], [Store & Send Link], or [Store to USB]

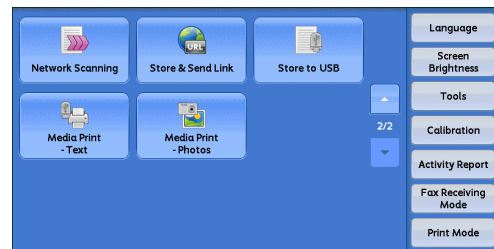
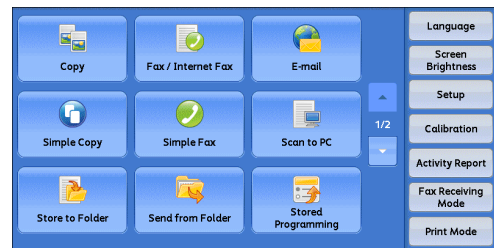

- 2 Select a feature on the [Layout Adjustment] screen.

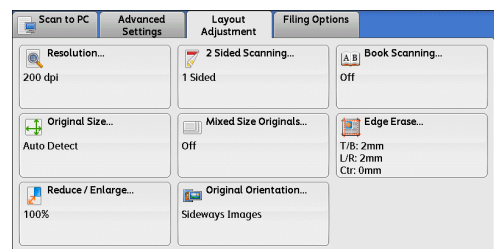

## Resolution (Specifying a Scanning Resolution)

This feature allows you to set the resolution to scan a document.

As the value increases, the scan becomes more detailed, but the data size also increases. The scanning and transfer time increases as well.

1 Select [Resolution].

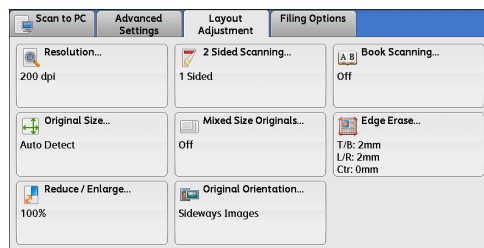

2 Select any option.

**Important** • Select either [200 dpi] or [300 dpi] when [Searchable Text] is set to [Searchable] for PDF or DocuWorks files on the [File Format] screen.

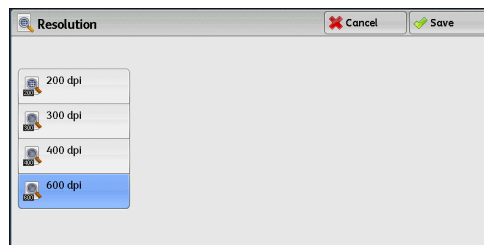

## 2 Sided Scanning (Scanning Both Sides of a Document)

This feature is the same as [2 Sided Scanning] on the [E-mail] screen.

For more information, refer to "2 Sided Scanning (Scanning Both Sides of a Document)" (P.240).

## Book Scanning (Scanning Facing Pages on Separate Sheets)

This feature allows you to scan facing pages of a document onto separate sheets of paper in page order.

It is useful if you want to separately scan facing pages of a bound document such as a booklet.

**Note**

- You cannot use the document feeder with this feature.
- A non-standard size document or undetectable-size document may not be separated into two accurately.

1 Select [Book Scanning.]

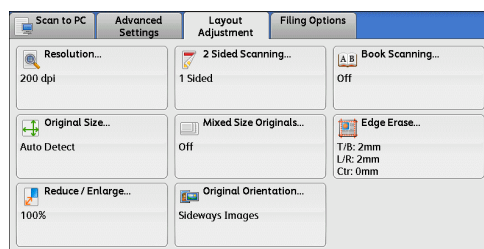

2 Select any option.

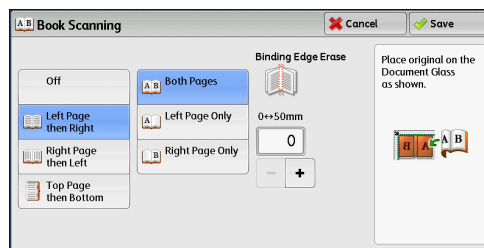

■Off

Does not scan as a bound document.

**■Left Page then Right**

Scans the left page and then the right page of facing pages.

**■Right Page then Left**

Scans the right page and then the left page of facing pages.

**■Top Page then Bottom**

Scans the top page and then the bottom page of facing pages.

**■Both Pages**

Scans both pages in page order.

**■Left Page Only**

Scans the left page only in page order. You can select this option when [Left Page then Right] or [Right Page then Left] is selected.

**■Right Page Only**

Scans the right page only in page order. You can select this option when [Left Page then Right] or [Right Page then Left] is selected.

**■Top Page Only**

Scans the top page only in page order. You can select this option when [Top Page then Bottom] is selected.

**■Bottom Page Only**

Scans the bottom page only in page order. You can select this option when [Top Page then Bottom] is selected.

**■Binding Edge Erase**

Erases the shadow from the center section of the document. You can specify the binding erase width in the range from 0 to 50 mm in 1 mm increments.

## Original Size (Specifying a Scan Size)

This feature allows you to set the scan size for a document.

Use this feature when a document is a non-standard size, or when you want to scan a document at a size different from the original size. You can also add margins, or delete unnecessary margins using this feature.

- 1 Select [Original Size.]

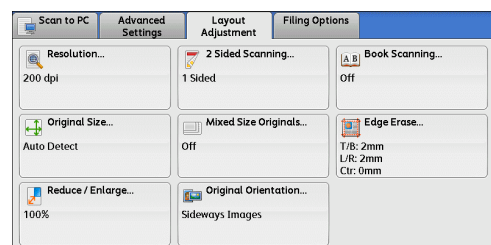

- 2 Select any option.  
When you select a non-standard size, specify values for the X and Y directions.

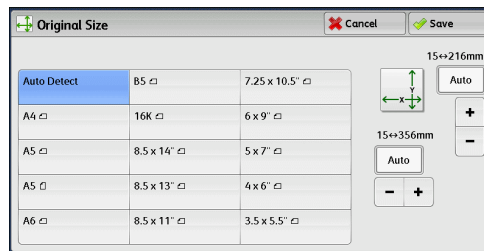

**Auto Detect**

Detects the document size automatically. The following table shows the document sizes that can be detected automatically.

	Document feeder	Document glass
<b>Auto-detectable Document Sizes</b>	B5, A5, A5, A4, 8.5 x 11", 8.5 x 14"	B6, B6, B5, A6, A5, A5, A4, 16K

**Note** • If the document size cannot be detected automatically, a screen to enter the document size appears.

The standard document sizes that can be detected automatically depend on [Paper Size Settings] in the System Administration mode. For information on [Paper Size Settings], refer to "5 Tools" > "Common Service Settings" > "Other Settings" > "Paper Size Settings" in the Administrator Guide.

**Standard Size**

Allows you to select from preset sizes.

**Variable Size**

Allows you to enter the desired scan size when scanning a non-standard size document or when scanning at a size different from the original document size. You can specify a value in the range from 15 to 356 mm for the scan width (X), and a value in the range from 15 to 216 mm for the scan length (Y), in 1 mm increments. The scales attached on the upper and left edges of the document glass are helpful for you to specify values.

**Important** • When the document is loaded in the document feeder, the base point in the Y (length) direction is the center of the edge. If you specify 100 mm, the scan length will be from 50 mm above to 50 mm below the center of the document.

## Mixed Size Originals (Scanning Different Size Documents Simultaneously)

You can scan documents of various sizes simultaneously with the respective sizes or with the same size. To use this feature, load the documents in the document feeder.

- Important**
- When you select [Color] in [Color Scanning], and [2 Sided] in [2 Sided Scanning], set [Resolution] to [400dpi] or lower.
  - When loading documents, align the top left corners of the documents properly. Otherwise, a paper jam may occur.
  - The recommended document size combinations are A5 portrait and A4 landscape. If another combination of document sizes is used, the documents can be fed at an angle and may not be scanned properly.

**Note** • When you select [Enter Output Size] in [Reduce/Enlarge] and specify the output size in [Output Size], the scanned data is automatically reduced/enlarged to the specified size. However, since the scanned image is not rotated, the image will be reduced/enlarged to fit



the specified size while keeping its orientation. For example, when an A4 landscape original is loaded and the output size is set to A5 portrait, the scanned image is reduced to A6 landscape and printed on A5 portrait paper.

- If the document size cannot be detected automatically, a screen to enter the document size appears.

## 1 Select [Mixed Size Originals].

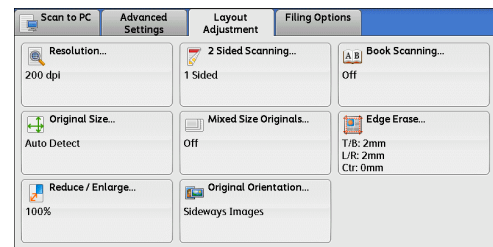

## 2 Select any option.

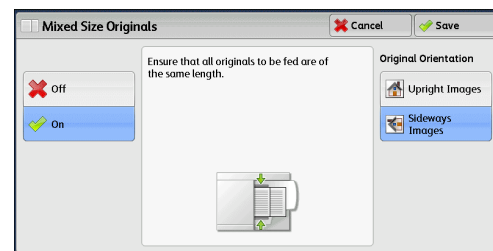

### ■ Off

Select this option when all documents are of the same size.

### ■ On

When scanning documents of different sizes, the machine automatically detects the size of each document.

### ■ Original Orientation

Specify the orientation of the loaded document.

When you load the top edge of the document against the left side of the document glass or the document feeder, and then select [Sideways Images], the document is displayed in the correct orientation when viewed on your computer screen.

**Note** • If the [Original Orientation] setting differs from the actual document orientation, the machine may not detect the top of the document correctly.

#### • Upright Images

Select this option when placing the top edge of the document against the top side of the document glass or document feeder.

#### • Sideways Images

Select this option when placing the top edge of the document against the left side of the document glass or document feeder.

## Edge Erase (Erasing Edges and Margin Shadows in the Document)

When you scan a document with the document cover open or when you scan a book, the edges and center margin of the document may be scanned as black shadows. The Edge Erase feature allows you to erase such shadows.

**Note** • For 2-sided originals, the same edge erase amounts are set for the front and back sides.  
• If you set [Reduce/Enlarge], the edge erase amounts will be reduced or enlarged in proportion to the ratio you specified.

**1** Select [Edge Erase].

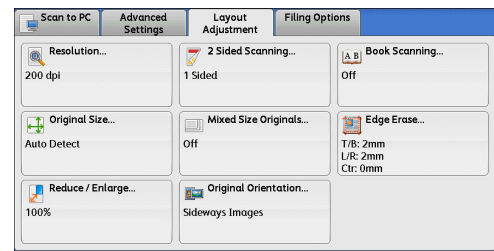

**2** Select any option.

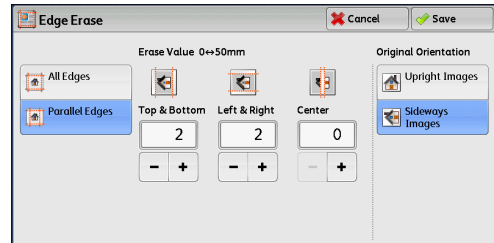

**3** If you select [Parallel Edges], use [+] and [-] to specify the erase widths of top and bottom, left and right, and center of the document.

**4** Select [Original Orientation].

■ **All Edges**

The edge width to erase is set to 2 mm for the top and bottom, and left and right edges.

■ **Parallel Edges**

Allows you to adjust the edge erase amounts.

• Top & Bottom

Erases the shadows of top and bottom edges of the document according to the orientation of the loaded document. You can specify the edge width to erase in the range from 0 to 50 mm in 1 mm increments.

• Left & Right

Erases the shadows of left and right edges of the document according to the orientation of the loaded document. You can specify the edge width to erase in the range from 0 to 50 mm in 1 mm increments.

• Center

Erases the shadow in the center of facing pages of a bound document. You can specify the center erase width in the range from 0 to 50 mm in 1 mm increments.

■ **Original Orientation**

Specify the orientation of the loaded document.

When you load the top edge of the document against the left side of the document glass or the document feeder, and then select [Sideways Images], the document is displayed in the correct orientation when viewed on your computer screen.

**Note** • If the [Original Orientation] setting differs from the actual document orientation, the machine may not detect the top of the document correctly.

• Upright Images

Select this option when placing the top edge of the document against the top side of the document glass or document feeder.

• Sideways Images

Select this option when placing the top edge of the document against the left side of the document glass or document feeder.

## Reduce/Enlarge (Specifying a Scanning Ratio)

This feature allows you to set the scanning ratio for the document to be scanned.

**Note** • When [Searchable Text] is set to [Searchable] and the [Specific Color] check box is selected on the [File Format] screen, [Reduce/Enlarge] is [100%].

1 Select [Reduce/Enlarge].

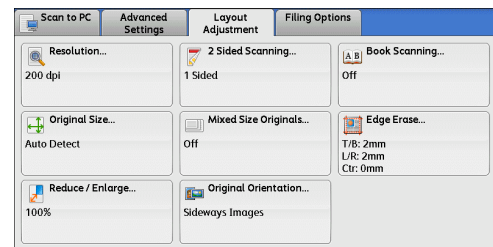

2 Select any option.

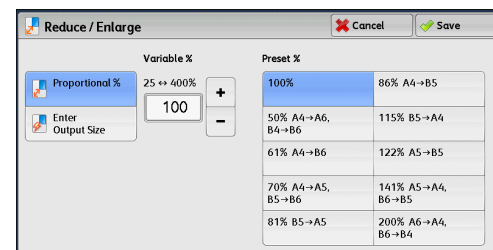

### ■Proportional %

Allows you to select a preset ratio, or enter a value in the range from 25 to 400% in 1% increments.

Use the numeric keypad or [+] and [-] to enter a value.

#### • Variable %

Enter the scanning ratio. Specifying "100%" scans at the same image size as the original document.

#### • Preset %

Select from preset ratios.

You can change the default values of scan ratios other than [100%]. For information on the settings, refer to "5 Tools" > "Scan Service Settings" > "Reduce/Enlarge Presets" in the Administrator Guide.

### ■Enter Output Size

In [Output Size], select the output size of the scanned document. The machine automatically calculates the scanning ratio based on the selected output size and the original document size.

**Note** • Selecting [Enter Output Size] may generate blank margin areas.

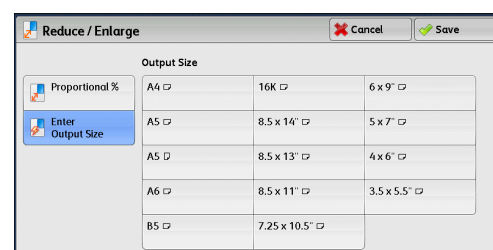

## Original Orientation (Specifying the Orientation of the Loaded Documents)

This feature allows you specify the orientation of the loaded document.

When you load the top edge of the document against the left side of the document glass or the document feeder, and then select [Sideways Images], the document is displayed in the correct orientation when viewed on your computer screen.

**Note** • If the [Original Orientation] setting differs from the actual document orientation, the machine may not detect the top of the document correctly.

- Upright Images

Select this option when placing the top edge of the document against the top side of the document glass or document feeder.

- Sideways Images

Select this option when placing the top edge of the document against the left side of the document glass or document feeder.

## E-mail Options/Filing Options

This section describes the features you can select on the [E-mail Options]/[Filing Options] screen under [E-mail], [Store to Folder], [Network Scanning], [Scan to PC], [Store & Send Link], or [Store to USB].

The following shows the reference section for each feature.

Quality/File Size (Specifying an Image Compression Ratio When Scanning).....	281
Read Receipts (Specifying Read Receipts).....	282
Split Send (Sending in Sections).....	283
File Name (Specifying a Name for the File to be Sent).....	283
Reply To (Specifying a Reply Address).....	284
File Name Conflict (Setting the Action to be Taken for File Name Conflict).....	285
File Name (Specifying a Name for the File to be Saved).....	285
Encryption (Sending E-mail Encrypted by S/MIME).....	286
Digital Signature (Sending E-mail with a Digital Signature by S/MIME).....	286
Login Name.....	286
Password.....	286
Meta Data.....	287

- 1 On the [Services Home] screen, select [E-mail], [Store to Folder], [Network Scanning], [Scan to PC], [Store & Send Link], or [Store to USB].

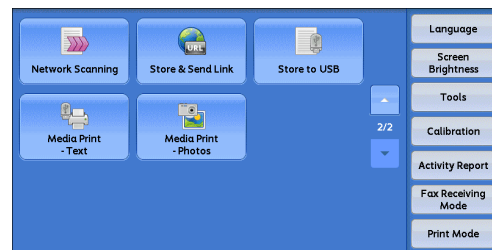
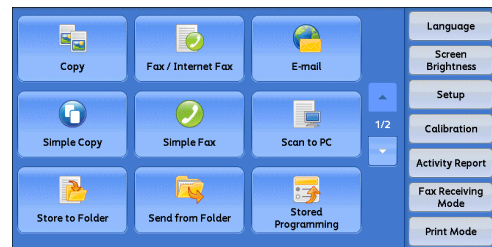

- 2 Select a feature on the [E-mail Options]/[Filing Options] screen.

**Note**

- The features displayed on the screen depend on the Scan service selected on the [Services Home] screen. The screen as shown on the right appears when [E-mail] is selected.

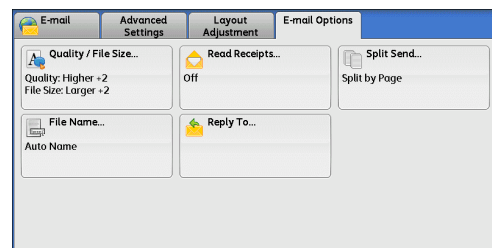

### Quality/File Size (Specifying an Image Compression Ratio When Scanning)

This feature allows you to select an image compression level when [Color Scanning] is set to [Color] or [Grayscale].

1 Select [Quality/File Size].

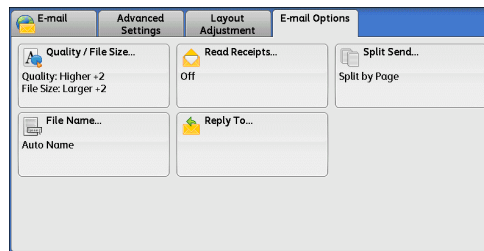

2 Select any button.

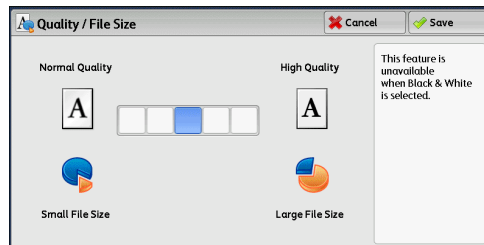

**Normal Quality**

The image is saved with high compression. Image quality degrades, but the file size decreases.

**High Quality**

The image is saved with low compression. Image quality improves, but the file size increases.

**Read Receipts (Specifying Read Receipts)**

When using the E-mail service, you can receive read receipts from e-mail recipients. This feature is available only when recipients support the MDN feature.

- Note**
- [Read Receipts] is displayed only when [Tools] > [System Settings] > [E-mail/Internet Fax Settings] > [E-mail Control] > [Read Receipts] is set to [On].
  - When multiple e-mails are sent using [Split Send], a read receipt is requested for each e-mail.
  - Read receipts are returned to the address specified in [Reply To], or they are returned to the address specified in [From] on the [E-mail] screen if [Reply To] is not set.
  - This feature is only available when the recipient also sets to return read receipts.

1 Select [Read Receipts].

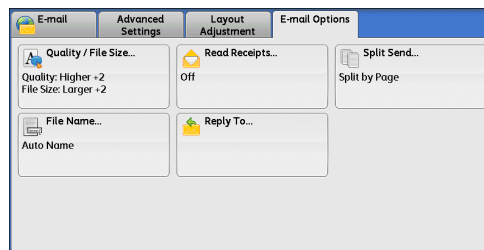

2 Select [On].

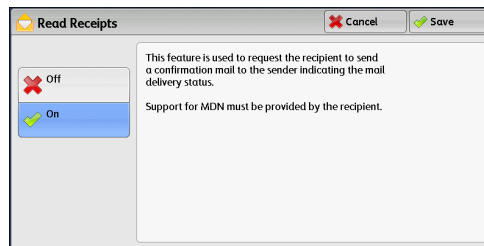

### ■Off

Select this option when you do not request read receipts.

### ■On

Select this option when you request read receipts.

## Split Send (Sending in Sections)

When using the E-mail service, and the size of the data to be attached is large, you can split the data at page breaks or by a certain data size and then send the data.

For information on [Split Send], refer to "5 Tools" > "E-mail/Internet Fax Service Settings" > "E-mail Control" > "Split Send Method" in the Administrator Guide.

### 1 Select [Split Send].

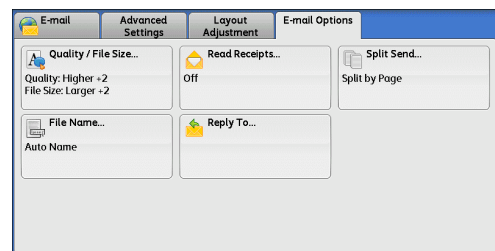

### 2 Select any option.

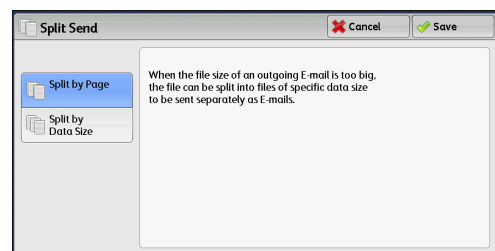

### ■Split by Page

The data is split at page breaks.

**Note**

- [Split by Page] is available only when [File Format] on the [E-mail] screen is set to [PDF], [DocuWorks], or [XPS], or when [File Format] is set to [TIFF] with [Single File for Each Page] check box not selected.

### ■Split by Data Size

The data is split by a certain data size.

**Note**

- Select this option if your e-mail application supports message/partial.

## File Name (Specifying a Name for the File to be Sent)

When using the E-mail, Scan to PC, Network Scanning, or Store & Send Link service, you can specify a name for the file to be sent.

### ■Auto Name

The file name is "img-xxx-yyy.zzz" (where xxx is the date and time, yyy is the page number, and zzz is the extension).

The extension depends on the setting in [File Format].

- When [TIFF] is selected in [File Format]: tif
- When [JPEG] is selected in [File Format]: jpeg

- When [PDF] is selected in [File Format]: pdf
- When [XPS] is selected in [File Format]: xps
- When [DocuWorks] is selected in [File Format]: xdw

**■To set the file name**

- 1 Select [File Name].
- 2 Enter a file name using the displayed keyboard.

For information on how to enter characters, refer to "Entering Text" (P.58).

- Note**
- When each page is saved as one file, the page number is added to the end of each file name.
  - Up to 128 characters can be entered as a file name for the Scan to PC service.
  - When you select [FTP] in [Transfer Protocol] for scanning to PC and the save location is Macintosh or Unix at the same time, enter a file name with single-byte characters.
  - Up to 28 characters can be entered as a file name for the E-mail service.
  - Up to 28 characters can be entered as a file name for the Store & Send Link service.
  - Up to 40 characters can be entered as a file name for the Network Scanning service.

## Reply To (Specifying a Reply Address)

When using the E-mail service, you can specify the address for reply.

- 1 Select [Reply To].

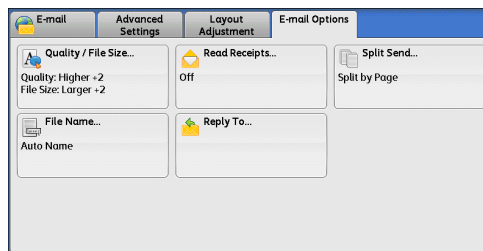

- 2 Enter an address for reply.

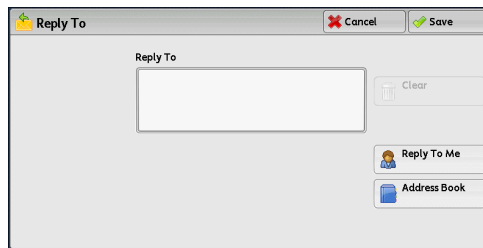

**■Reply To**

Select the [Reply To] box to display the keyboard screen on which you can enter an address for reply.

**■Clear**

Deletes the address entered in [Reply To].

**■Reply To Me**

Uses the address specified in [From] on the [E-mail] screen as a reply address.

- Note**
- [Reply To Me] is selectable only when an address is specified in [From] on the [E-mail] screen.



### ■Address Book

Allows you to select a reply address from the Address Book.

For more information, refer to "Address Book (Specifying an E-mail Address)" (P.232).

## File Name Conflict (Setting the Action to be Taken for File Name Conflict)

When using the Scan to PC service, you can set the action to be taken when the file name conflicts with another file stored in the destination.

- 1 Select [File Name Conflict].

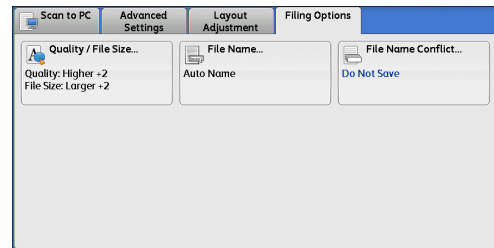

- 2 Select any option.

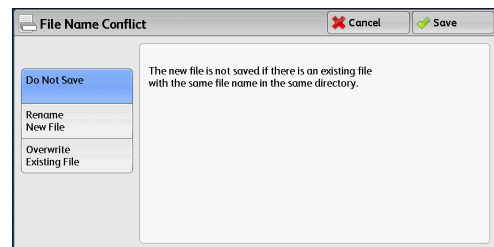

### ■Do Not Save

Cancels the job without saving the file.

### ■Rename New File

Automatically changes the file name by appending a number (0001 - 9999) to the file name, and saves the file.

### ■Overwrite Existing File

Replaces the existing file with the new one.

## File Name (Specifying a Name for the File to be Saved)

When using the Store to Folder service, you can specify a name for the file to be saved.

### ■Auto Name

The file name is "img-xxx" (where xxx is the date and time).

**Note** • If a file name is deleted, [(Auto Set)] is displayed.

### ■To set the file name

- 1 Select [File Name].

- 2 Enter a file name with up to 28 characters using the displayed keyboard.

**Note** • If a document stored in a folder of the machine is imported to a computer, the specified name may not be reflected on it depending on import method.

For information on how to enter characters, refer to "Entering Text" (P.58).

## Encryption (Sending E-mail Encrypted by S/MIME)

---

When using the E-mail service, you can send e-mail encrypted by S/MIME.

When sending encrypted e-mail, select an e-mail address associated with a certificate that can be encrypted, from the Address Book.

**Note** • You can change the default value of [E-mail Encryption] in the System Administration mode. For information on how to change the default value, refer to "5 Tools" > "Scan Service Settings" > "Scan Defaults" > "E-mail Encryption" in the Administrator Guide.

### ■Off

Sends e-mail without encryption.

### ■On

Sends e-mail with encryption.

## Digital Signature (Sending E-mail with a Digital Signature by S/MIME)

---

When using the E-mail service, you can send e-mail with a digital signature by S/MIME.

Digital Signature allows a recipient to confirm whether contents of the e-mail are changed, or whether the e-mail is sent from the proper sender.

To use this feature, the machine's mail address must be linked to a certificate.

For information on how to link a certificate to the machine's e-mail address, refer to "12 Encryption and Digital Signature Settings" > "Configuration of E-mail Encryption/Digital Signature" in the Administrator Guide.

### ■Off

Sends e-mail without a digital signature.

### ■On

Sends e-mail with a digital signature.

## Login Name

---

You can enter the login name for a destination server.

**Note** • This feature is displayed only when [Network Scanning] is selected on the [Services Home] screen.

- 1** Select [Login Name].
- 2** Enter the login name using the keyboard displayed on the screen.  
For information on how to enter characters, refer to "Entering Text" (P.58).

## Password

---

You can enter the password for a destination server.

**Note** • This feature is displayed only when [Network Scanning] is selected on the [Services Home] screen.

- 1** Select [Password].
- 2** Enter the password using the keyboard displayed on the screen.

For information on how to enter characters, refer to "Entering Text" (P.58).

## Meta Data

---

You can change the values of the Document Management Field (DMF) if they are specified for a selected job template.

- Note**
- This feature is displayed only when [Network Scanning] is selected on the [Services Home] screen.



# 6 Send from Folder

This chapter describes the basic operations and features to use folders.

- Folder Operating Procedure .....290
- Selecting a Folder .....292
- Checking/Operating Files in a Folder .....293
- Checking File Details .....295
- Printing Files in a Folder .....296
- Configuring/Starting Job Flow.....299



## Folder Operating Procedure

This section describes the basic procedure to operate files in folders.

You can store print files submitted by a computer, scan files, and fax files in folders on the machine.

These files stored in a folder can be sent by e-mail and be retrieved from a network computer.

You can also automate routine tasks, or register private folders and shared folders separately.

Two types of folders are available: [Scan & Other Jobs] and [Copy & Print Jobs]. The folders under [Scan & Other Jobs] allow you to store print files submitted by a computer and scan files. These files stored in a folder can be sent by e-mail and be retrieved from a network computer. You can also automate routine tasks, or register private folders and shared folders separately.

The folders under [Copy & Print Jobs] allow you to store copy files and print files. You can also save the files again and reprint them in a folder after editing the files or changing their settings.

The following shows the reference section for each procedure.

Step 1 Opening the [Send from Folder] Screen .....	290
Step 2 Selecting a Folder .....	291
Step 3 Checking/Selecting Files in a Folder .....	291
Step 4 Operating Files in a Folder .....	291

### Step 1 Opening the [Send from Folder] Screen

The following describes how to select features on the [Send from Folder] screen.

**Note** • The features displayed on the screen depend on your machine configuration.

- 1 Press the <Services Home> button.

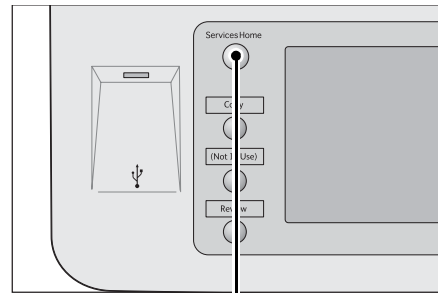

<Services Home> button

- 2 Select [Send from Folder].

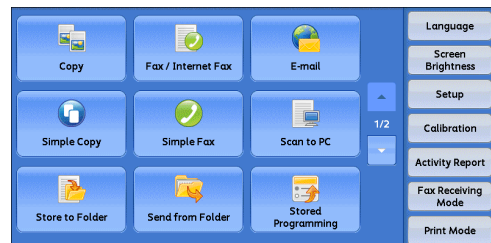

## Step 2 Selecting a Folder

Access to some folders may be restricted, depending on the settings of the Authentication feature.

For information on selectable folders depending on the Authentication feature, refer to "13 Authentication and Accounting Features" > "Authentication for Job Flow Sheets and Folders" in the Administrator Guide.

- 1 Select a folder to operate on.

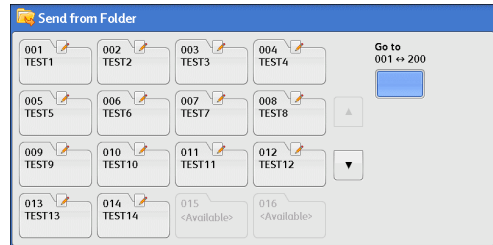

- 2 If a passcode is set for the folder, enter the passcode and select [Confirm].

## Step 3 Checking/Selecting Files in a Folder

- 1 Select the display style from [List] and [Thumbnail].

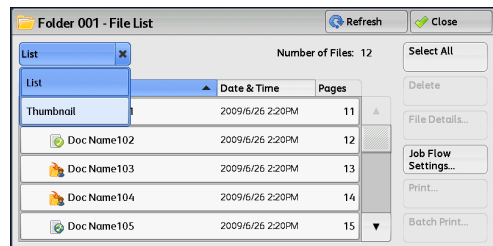

- 2 Select a file to send by e-mail or to print.

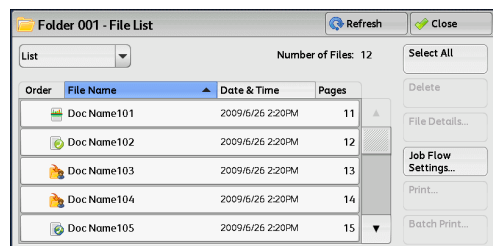

For information on the [File List] screen, refer to "Checking/Operating Files in a Folder" (P.293).

## Step 4 Operating Files in a Folder

The following shows the reference sections for operations available on the [Send from Folder] screen.

Selecting a Folder .....	292
Checking/Operating Files in a Folder .....	293
Checking File Details .....	295
Printing Files in a Folder .....	296
Configuring/Starting Job Flow .....	299

## Selecting a Folder

The following describes how to select a folder.

Access to some folders may be restricted, depending on the settings of the Authentication feature.

For information on selectable folders depending on the Authentication feature, refer to "13 Authentication and Accounting Features" > "Authentication for Job Flow Sheets and Folders" in the Administrator Guide.

### 1 Select a folder on the [Send from Folder] screen.

- Note**
- Select [▲] to return to the previous screen or [▼] to move to the next screen.
  - An arrow is displayed next to each folder which has a link to a job flow sheet and for which the auto start is set.
  - If the passcode entry screen appears, enter the passcode and select [Confirm].

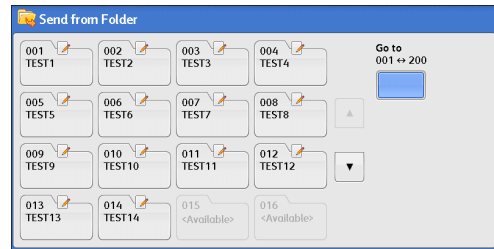

### ■Go to

Displays a folder at the top when you enter the 3-digit folder number with the numeric keypad.





## Checking/Operating Files in a Folder

You can check or operate files stored in a folder.

**Note** • When selecting print files, [Job Flow Settings] cannot be selected.

- 1 Select a folder on the [Send from Folder] screen.

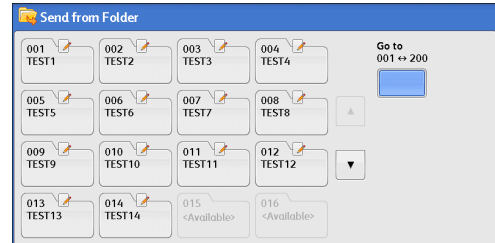

- 2 Select the display style from [List] and [Thumbnail].

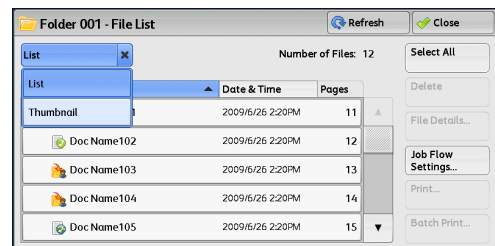

- 3 Select a file.

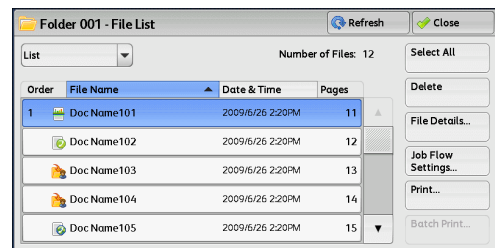

- Note**
- Select [▲] to return to the previous screen or [▼] to move to the next screen.
  - You can sort files in ascending or descending order by selecting either [File Name] or [Date & Time].
  - At the left of each file name, an icon is displayed to show the file type.
    - : Scan file
    - : Print file
    - : File for Secure Polling
    - : Fax file
    - : Internet Fax file
  - You can select up to 100 files separately, or select all files at a time. If you select files separately, a number appears to the left of the icon indicating the order in which it was selected. Files are processed in this order.

- 4 Select any option.

■ **Refresh**

Displays the updated information.

■ **List**

Lists the files stored in the folder, with their stored dates and pages.

■ **Thumbnail**

Displays the images and names of the files stored in the folder

**Important** • If the power is cut off immediately after a scanned file is stored in a folder, or if the hard disk space is insufficient to display thumbnails, files in the folder may not be displayed in thumbnail view. In that case, display them in list view.

- Characters and images in thumbnail view may not be correctly displayed because they are scaled down from the actual sizes.

**Note** • The orientation of an image displayed in thumbnail view depends on which orientation the document was stored in.

■ **Number of Files**

Displays the number of files stored in the selected folder.

■ **Select All**

Selects all the files in the folder. To deselect all the files, select this button again while all the files are being selected.

■ **Delete**

Deletes the selected files in the folder.

■ **File Details**

Previews the selected file to allow you to check its details.

Refer to "Checking File Details" (P.295).

■ **Job Flow Settings**

Displays the [Job Flow Settings] screen on which you can create, link, and execute job flows.

Refer to "Configuring/Starting Job Flow" (P.299).

**Note** • Files stored in a folder by specifying [Store in Remote Folder] on a print driver are called "print files". Job flows are not available for print files. If print files are included in the selected files, a job flow can be executed for the files other than the print files.

■ **Print**

Allows you to print the selected files separately.

Refer to "Print" (P.296).

■ **Batch Print**

Allows you to print the selected multiple files as one file.

Refer to "Batch Print" (P.297).



# Checking File Details

You can preview the selected file to check its details.

**Note** • Monochrome images with high gradation levels may appear bluish when previewed.

**1** Select a file on the [Folder - File List] screen.

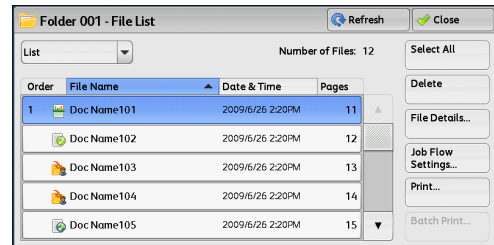

**2** Click [File Details].

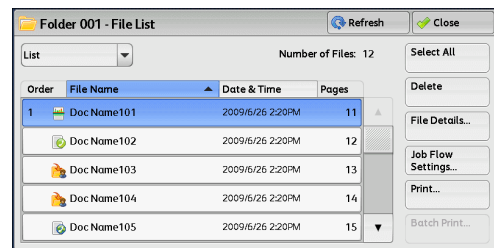

**3** Select any option.

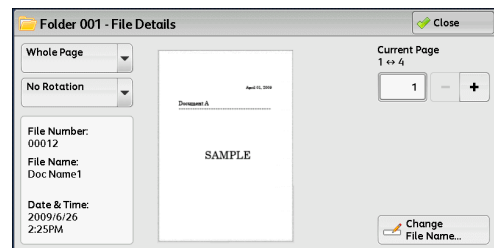

### ■Whole Page

Allows you to select whether to display the whole page or to enlarge the image by 200%. You can select the view size from [Whole Page] and [Enlarged View].

**Note** • A small size of a document may not be enlarged even if you select [Enlarged View].  
 • You can rotate or enlarge the image of the file in a folder in preview, but cannot save the file with the image rotated or enlarged.

### ■No Rotation

Allows you to select an angle to preview the image from [Right 90 degrees], [Left 90 degrees], and [180 degrees].

**Note** • You can rotate or enlarge the image of the file in a folder in preview, but cannot save the file with the image rotated or enlarged.

### ■Change File Name

Allows you to change the file name. Use the displayed keyboard to enter a new name.

### ■Current Page

Specify a page to preview on the screen.

## Printing Files in a Folder

You can print selected files in a folder.

- 1 Select files on the [Folder - File List] screen.

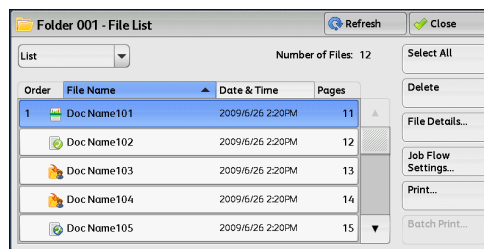

- 2 Select [Print] or [Batch Print].

**Note**

- When multiple files are selected, [Batch Print] allows you to print the selected files as a single file, while [Print] allows you to print them as separate files.

For information on [Print] and [Batch Print], refer to "Print" (P.296) and "Batch Print" (P.297).

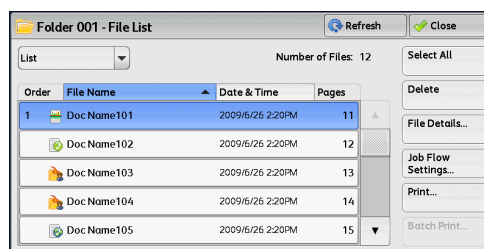

- 3 Select any option. Enter the number of print sets using the numeric keypad, if necessary.

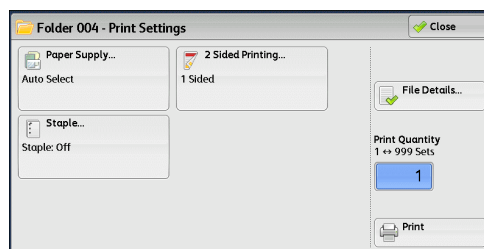

- 4 Select [Print]

**Note**

- When a file stored by [Store in Remote Folder] of a print driver is printed, the settings specified on the control panel or CentreWare Internet Services will override the settings specified on the print driver except the [Pages Per Sheet (N-Up)], [Skip Blank Page], and [Print Position] settings.

### Print

Allows you to set printing.

#### ■ Paper Supply

Allows you to select paper.

#### ■ 2 Sided Printing

Allows you to set 2-sided printing.

#### ■ Staple

Allows you to set stapling.

**Note**

- This feature does not appear for some models. An optional component is required. For more information, contact our Customer Support Center.

For examples of the settings of stapling, refer to "When stapling" (P.297)

#### ■ File Details

Displays the [File Details] screen. Select a file from the list to check its preview image.

For information on how to preview a file, refer to "Checking File Details" (P.295).

#### ■Print Quantity

Specify the number of print sets.

#### ■Print

Prints the selected file.

### Batch Print

Allows you to set batch printing.

You can print multiple files as one file. Up to 100 files can be bound in the selected order.

- Note**
- For 2-sided printing, the last page becomes blank when the total number of printed pages is odd. For printing of multiple files, a blank page is inserted after the final page of each file.
  - If a different size document is included in multiple files, it may be printed in improper orientation.
  - [Batch Print] is not available while interrupting another job.
  - [Batch Print] is not available for files received by fax or Internet Fax, or files for Secure Polling. When the selected files contain fax or Internet Fax files, the machine will not print the fax or Internet Fax files but only the scan and print files.

#### ■Paper Supply

Allows you to select paper.

#### ■2 Sided Printing

Allows you to set 2-sided printing.

#### ■Staple

Allows you to set stapling. The number of sheets that can be stapled is 2-50 (when 80gsm paper is use).

- Note**
- This feature does not appear for some models. An optional component is required. For more information, contact our Customer Support Center.

For example of the settings of stapling, refer to "When stapling" (P.297)

#### ■File Details

Displays the [File Details] screen. Select a file from the list to check its preview image. For information on how to preview a file, refer to "Checking File Details" (P.295).

#### ■Print Quantity

Specify the number of print sets.





#### ■Print

Prints the selected file.

### When stapling







The following table shows the stapling positions for print files stored in a folder by specifying [Store in Remote Folder] on a print driver, and for scan files. The following uses the example of [1 Staple].

- For print files in a folder stored by specifying [Store in Remote Folder] on a print driver

<b>Original</b>		
<b>Stapling Position</b>		

- For scan files stored in a folder

**Important** • Ensure that the actual orientation of the original document matches the [Original Orientation] setting in [Edge Erase] or in [2 Sided Scanning] on the [Layout Adjustment] screen.

<b>Original</b>		
<b>Original Orientation</b>		
<b>Stapling Position</b>		



## Configuring/Starting Job Flow

Job Flow is a feature that allows you to register transfer settings of scan data, such as a transfer method and destination, to simplify data-transfer tasks. You can register a maximum of 200 job flows.

Job flow sheets targets files stored in folders. A job flow operates files stored in a folder in either of the following ways:

- 1) Automatically start a job flow when a file is stored in a folder
- 2) Manually start a job flow by selecting a job flow linked to files stored in a folder
- 3) Manually start a job flow by selecting a file stored in a folder and a job flow
- 4) Manually start a job flow by selecting a job flow in the [Job Flow Sheets] Screen

To automatically start a job flow, you must make a link with a folder and a job flow sheet in advance. Files are automatically processed with the job flow sheet when they are stored in the linked folder.

- Note**
- When the Authentication feature is disabled, a job flow created in [Send from Folder] can only be used/edited/duplicated/deleted through the folder where the job flow is created. This type of job flow is not displayed on the [Create Job Flow Sheet] screen. When the Authentication feature is enabled, job flows whose owners are authenticated are displayed on the [Create Job Flow Sheet] screen.
  - When you use the optional HDD, you can register job flows up to 1000.

You can register the following features:

- Forward
- E-mail Notification
- Print

For information on the restrictions on the combination of features, refer to "5 Tools" > "Setup" > "Create Job Flow Sheet" in the Administrator Guide.

### ■ Forward

Multiple forwarding recipients can be configured for each forwarding method.

- FTP  
Forwards via FTP. Up to 2 recipients can be specified.
- SMB  
Forwards via SMB. Up to 2 recipients can be specified.
- Mail  
Forwards via E-mail. Up to 100 recipients can be specified.
- Fax  
Forwards via fax. Up to 100 recipients can be specified.
- Internet Fax  
Forwards via Internet Fax. Up to 100 recipients can be specified.

### ■ E-mail Notification

You can receive the job results by e-mail.

For more information, refer to "5 Tools" > "Setup" > "Create Job Flow Sheet" > "Create New Job Flow Sheet" in the Administrator Guide.

### ■ Print

Files in a folder can be printed.

1 Select files on the [Folder - File List] screen.

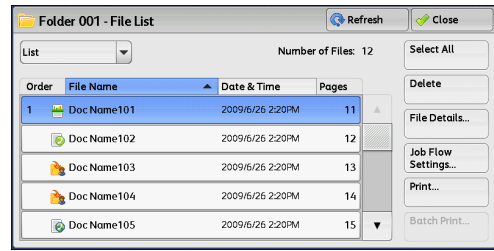

2 Select [Job Flow Settings].

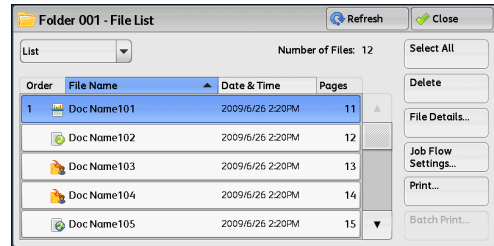

3 Select any option.

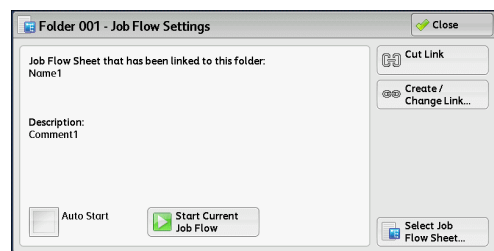

**Auto Start**

This sets auto start of the job flow for files stored in the folder. The job flow automatically starts when a file is stored.

**Start Current Job Flow**

Select files in the folder, and then select this button to start the job flow linked to this folder.

**Important** • After executing the job flow, confirm the [Job Status] screen or print a Job History Report to check the result. For information on the Job History Report, refer to "5 Tools" > "Common Service Settings" > "Reports" > "Job History Report" in the Administrator Guide.

**Cut Link**

Cancels the link between a folder and the linked job flow sheet.

**Create/Change Link**

Displays the [Link Job Flow Sheet to Folder] screen.  
Refer to "[Link Job Flow Sheet to Folder] Screen" (P.301).

**Select Job Flow Sheet**

Select this button while files are selected to display the [Select Job Flow Sheet] screen.  
Refer to "[Select Job Flow Sheet] Screen" (P.303).



## [Link Job Flow Sheet to Folder] Screen

You can change the link between the folder and its job flow sheet.

**Note** • Linking, delinking, and auto start settings can be also performed when you create a folder.

**1** Select a job flow sheet to link to.

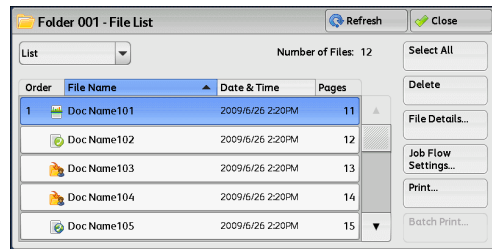

**Important** • Selecting [Save] without selecting a job flow sheet does not set a link. If the selected job flow sheet is already linked, the link is canceled.

**Note** • Select [▲] to return to the previous screen or [▼] to move to the next screen.  
• You can sort the list in ascending or descending order by selecting either [Name] or [Updated].

**2** Select [Job Flow Settings].

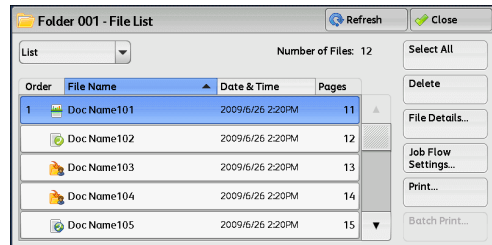

**3** Select [Create/Change Link].

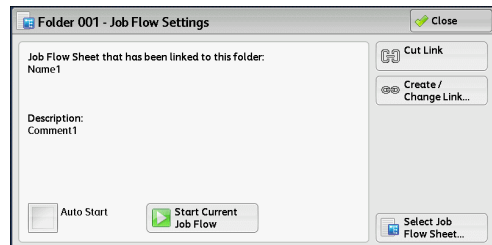

**4** Select any option.

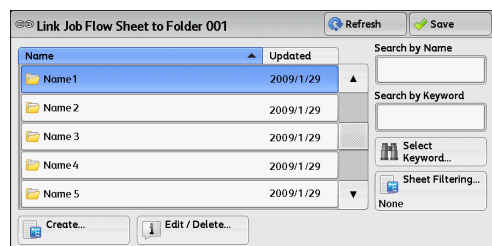

### ■ Refresh

Displays the updated information.

### ■ Create

Displays the [Create New Job Flow Sheet] screen.

For more information, refer to "5 Tools" > "Setup" > "Create Job Flow Sheet" > "Create New Job Flow Sheet" in the Administrator Guide.



■ **Edit/Delete**

Displays the [Details] screen.

For more information, refer to "5 Tools" > "Setup" > "Create Job Flow Sheet" > "Edit/Delete" in the Administrator Guide.

■ **Search by Name**

Searches for job flows that partially match the entry. The machine searches through job flow names that were registered upon each job flow creation. The entry can be up to 128 characters long.

For information on how to enter characters, refer to "Entering Text" (P.58).

■ **Search by Keyword**

Searches for job flows that fully match the entry. The machine searches through keywords that were registered upon each job flow creation. The entry can be up to 12 characters long. You can select from preset keywords if they have been registered in the System Administration mode.

For information on how to enter characters, refer to "Entering Text" (P.58).

■ **Select Keyword**

Displays the [Select Keyword] screen. Select a keyword registered in the System Administration mode to search for job flows. Job flows that fully match the entry are searched. The machine searches through keywords that were registered upon each job flow creation.

■ **Sheet Filtering**

Displays the [Sheet Filtering] screen.

Refer to "[Sheet Filtering] Screen" (P.302).

**[Sheet Filtering] Screen**

This screen allows you to filter the job flow sheets displayed.

Displayed job flow sheets may vary depending on the Authentication feature. For more information, refer to "13 Authentication and Accounting Features" > "Authentication for Job Flow Sheets and Folders" in the Administrator Guide.

- 1 Select the filtering conditions, and select [Save].

**Note**

- The job flows that can be displayed on [Send from Folder] are those whose [Target] is [Folder], and those stored in the machine.

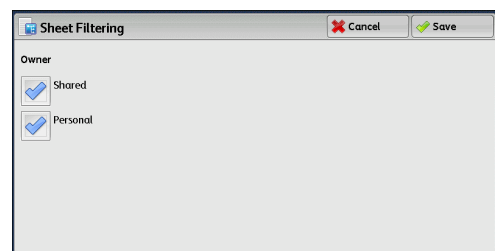

■ **Owner**

Select the owner of job flow sheets to filter.

## [Select Job Flow Sheet] Screen

This screen allows you to select and execute a job flow for the selected files.

- 1 Select a job flow, and select [Start].

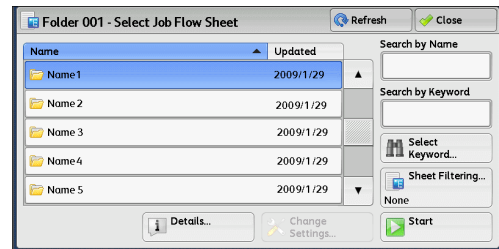

- Note**
- Select [▲] to return to the previous screen or [▼] to move to the next screen.
  - You can sort the list in ascending or descending order by selecting either [Name] or [Updated].

### ■Start

Executes the selected job flow sheet.

### ■Refresh

Displays the updated information.

### ■Details

Displays the [Details] screen.

For more information, refer to "5 Tools" > "Setup" > "Create Job Flow Sheet" > "Edit/Delete" in the Administrator Guide.

### ■Change Settings

If the selected job flow sheet setting is editable, the [Change Settings] screen appears. You can temporarily change the settings.

### ■Search by Name

Searches for job flows that partially match the entry. The machine searches through job flow names that were registered upon each job flow creation. The entry can be up to 128 characters long.

For information on how to enter characters, refer to "Entering Text" (P.58).

### ■Search by Keyword

Searches for job flows that fully match the entry. The machine searches through keywords that were registered upon each job flow creation. The entry can be up to 12 characters long. You can select from preset keywords if they have been registered in the System Administration mode.

For information on how to enter characters, refer to "Entering Text" (P.58).

### ■Select Keyword

Displays the [Select Keyword] screen. Select a keyword registered in the System Administration mode to search for job flows. Job flows that fully match the entry are searched. The machine searches through keywords that were registered upon each job flow creation.

### ■Sheet Filtering

Displays the [Sheet Filtering] screen.

Refer to "[Sheet Filtering] Screen" (P.302).

## Job Flow Restrictions

---

A job flow sheet can be used by only one user, can be shared by multiple users, or can be used for only certain folders.

Job flow restrictions may vary depending on the Authentication feature. For more information, refer to "13 Authentication and Accounting Features" > "Authentication for Job Flow Sheets and Folders" in the Administrator Guide.



# 7 Stored Programming

This chapter describes the Stored Programming service that enables you to store customized job settings.

- Stored Programming Overview.....306
- Registering/Deleting/Renaming Stored Programs .....307
- Calling a Stored Program .....313

## Stored Programming Overview

---

---

The Stored Programming service allows you to store settings that you expect to use frequently and call them with a single button operation. You can also assign a screen to a stored program button, to use the button as a short-cut to the screen.

A stored program can store not only settings of a feature, but a flow of settings configured on multiple screens.

For example, this service is available when you want to record a procedure starting from pressing the <Machine Status> button, to displaying the screen under [Print Reports] to print a Job History Report.

In addition, while Build Job is running, this service can be used for the remaining document stacks.

For information on Build Job, refer to "Build Job (Processing Documents Scanned with Different Settings as One Job)" (P.121).

The following shows the reference section for each feature.

Registering/Deleting/Renaming Stored Programs .....	307
Calling a Stored Program .....	313



# Registering/Deleting/Renaming Stored Programs

You can register and delete stored programs on the [Stored Programming] screen.

- 1 Press the <Services Home> button.

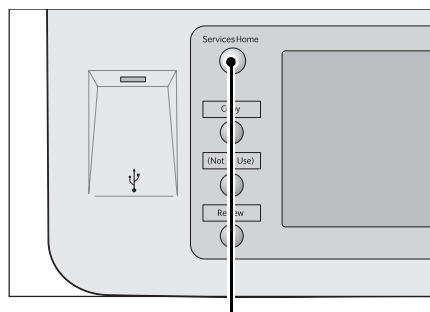

<Services Home> button

- 2 Select [Setup].

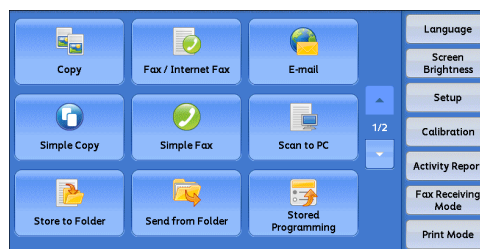

- 3 Select [Stored Programming].

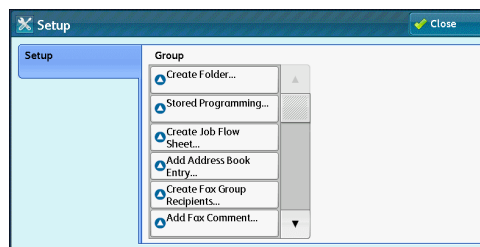

- 4 Select a feature.

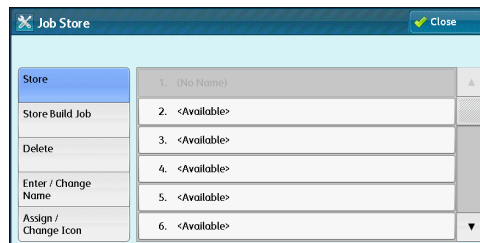

### ■Store

Register a stored program.  
Refer to "Registering Stored Programs" (P.308).

### ■Store Build Job

Register a stored program for Build Job.  
Refer to "Registering Stored Programs for Build Job" (P.309).

### ■Delete

Deletes a stored program. Select the stored program number to be deleted.  
Refer to "Deleting Stored Programs" (P.310).

### ■Enter/Change Name

Enter or change the name of a stored program.

Refer to "Entering/Changing a Stored Program Name" (P.311).

### ■Assign/Change Icon

Specify an icon for a registered stored program.

Refer to "Assigning/Changing Icons for Stored Programs" (P.311).

## Registering Stored Programs

Up to 100 actions can be registered with one stored program. Up to 40 stored programs can be registered in the machine.

The following describes how to register actions with stored programs.

**Important** • If registered settings such as tray paper size and comments, or default values in the System Settings are changed after a stored program is registered, the program's content also changes.

**Note** • Services using System Settings, Network Scanning, or Address Book cannot be registered.  
• The registering procedure for a stored program is canceled when the <Interrupt> button is pressed, the Auto Clear feature causes a time-out, or a pop-up window (paper jam, etc.) appears.

### 1 Select [Store].

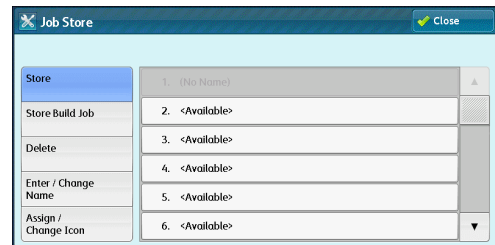

### 2 Select a number to register a stored program.

**Note** • Once a job is stored to a button, it cannot be overwritten.  
• Select [▲] to return to the previous screen or [▼] to move to the next screen.

### 3 Set the feature you want to register.

**Note** • The machine sounds an audible tone while a stored program is being registered.  
• Press the <Interrupt> button to cancel registration.

You can change the volume of the sound that notifies that a stored program is being registered. For information on the setting, refer to "5 Tools" > "Common Service Settings" > "Audio Tones" > "Stored Programming Tone" in the Administrator Guide.

### 4 Press the <Start> or <Clear All> button.

**Note** • If no name is entered for a registered stored program, the name becomes "(No Name)".  
For information on how to name a registered stored program, refer to "Entering/Changing a Stored Program Name" (P.311).

## Notes and Restrictions on Registering Stored Programs

The following notes and restrictions applies when you register stored programs.

- When registering a stored program to select a paper size or type loaded on the bypass tray, register both the paper size and the paper type. If only the paper size or type is registered, the stored program may not be called properly.
- If any of the following operations is performed while a stored program is being registered, the stored program may not be registered or may not work correctly.



- Removing or inserting a paper tray
- Loading or reloading paper in the bypass tray
- If any of the following operations is performed after a stored program is registered, the registered stored program may not be called properly.
  - If the stored program has the Watermark feature and the default values of that feature are changed.
  - If the stored program has an operation for a folder and the folder passcode is changed.
  - If the settings of the control panel are changed.
  - If the services assigned to the custom buttons are changed.
  - If any setting is changed under [Tools] > [System Settings] > [Copy Service Settings] > [Preset Buttons].
  - If the selection is made from a list of the Address Book.
  - If any optional components installed on the machine, such as a finisher, are changed, and thereby the associated buttons become no longer available.
  - If the measurement unit, millimeters or inches, is changed.
  - If a job is selected from the list of the stored jobs in [Secure Print Jobs & More] under Job Status.
- The following features and operations cannot be registered in Stored Programming.
  - Registration and call of a stored program
  - System Settings
  - The [Media Print - Text] and [Media Print - Photos] buttons on the [Services Home] screen
  - The [Store to USB] button on the [Services Home] screen
  - The [Network Scanning] buttons on the [Services Home] screen.
  - The Custom button to which the Network Scanning is assigned.
  - The Address Book for the Fax/Internet Fax, E-mail, and Scan to PC services
  - Unselectable buttons
  - The [Language] button on the [Services Home] screen
  - The [Screen Brightness] button on the [Services Home] screen
  - Selecting items using the scroll bar
  - Scrolling operation while previewing
  - The [Browse] button for the Scan to PC service
  - Operations to edit e-mail addresses for the E-mail service (the pop-up menu [Keyboard], [Remove], and [Edit] displayed by selecting [Recipient(s)] or [From]).
  - The <Energy Saver> button
- A stored program registration is canceled when the <Interrupt> button is pressed, the Auto Clear feature causes a time-out, or a pop-up window (such as a paper jam window) appears.

## Registering Stored Programs for Build Job

Up to 100 actions can be registered with one stored program for Build Job. Up to 40 stored programs can be registered in the machine.

The following describes how to register actions with stored programs.

**1** Select [Store Build Job].

- Note**
- Once a job is stored to a button, it cannot be overwritten.
  - Select [▲] to return to the previous screen or [▼] to move to the next screen.

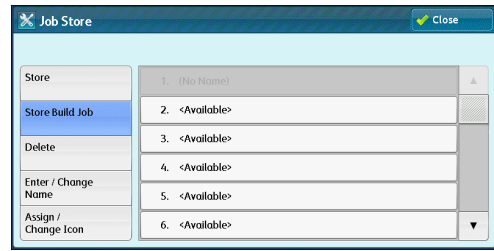

**2** Select a number to register a stored program.

- Note**
- Once a job is stored to a button, it cannot be overwritten.
  - Select [▲] to return to the previous screen or [▼] to move to the next screen.

**3** Set the feature you want to register.

- Note**
- The machine sounds an audible tone while a stored program is being registered.
  - Press the <Interrupt> button to cancel registration.

You can change the volume of the sound that notifies that a stored program is being registered. For information on the settings, refer to "5 Tools" > "Common Service Settings" > "Audio Tones" > "Stored Programming Tone" in the Administrator Guide.

**4** Press the <Start> or <Clear All> button.

- Note**
- An icon is displayed to the left of each registered stored program for Build Job.
  - If no name is entered for a registered stored program, the name becomes "No Name".

For information on how to name a registered stored program, refer to "Entering/Changing a Stored Program Name" (P.311).

## Deleting Stored Programs

The following describes how to delete stored programs.

**1** Select [Delete].

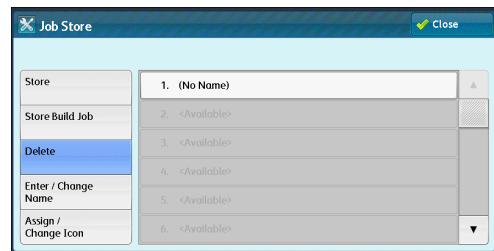

**2** Select the number to be deleted.

- Note**
- Select [▲] to return to the previous screen or [▼] to move to the next screen.

**3** Select [Delete].

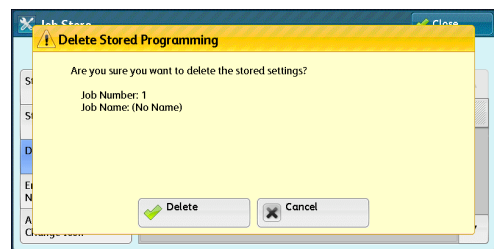

**■Delete**

Deletes the stored program.

**Note** • Deleted stored programs cannot be restored.

■ **Cancel**

Cancels deleting the stored program.

## Entering/Changing a Stored Program Name

The following describes how to enter or change the name of a stored program.

Up to 18 characters are allowed for a stored program's name.

For information on how to enter characters, refer to "Entering Text" (P.58).

- 1 Select [Enter/Change Name].

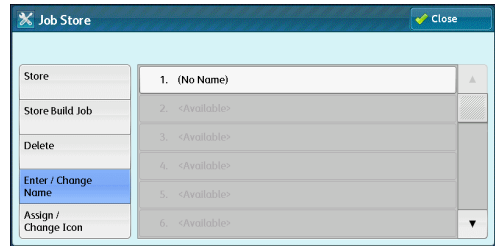

- 2 Select the number to register or change a name.

**Note** • Select [▲] to return to the previous screen or [▼] to move to the next screen.

- 3 Enter a name, and select [Save].

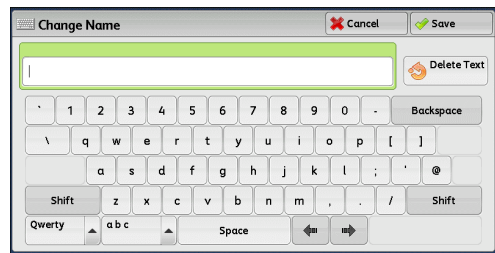

## Assigning/Changing Icons for Stored Programs

The following describes how to assign or change an icon of a stored program.

You can select from 12 icons.

- 1 Select [Assign/Change Icon].

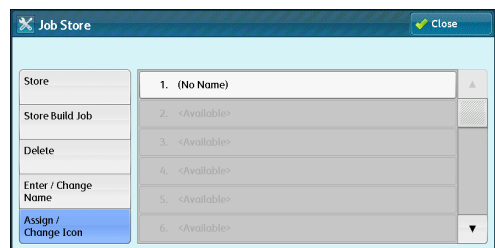

- 2 Select the number to assign or change an icon.

**Note** • Select [▲] to return to the previous screen or [▼] to move to the next screen.

**3** Select an icon, and select [Save].

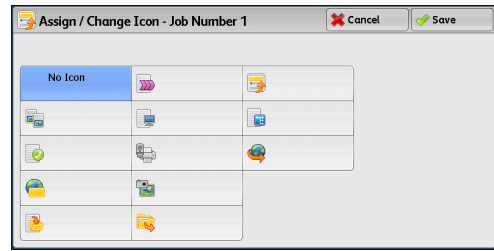

■ **No Icon**

No icon is assigned to a registered stored program.

■ **Icon**

Select an icon according to the content of the registered stored program.

# Calling a Stored Program

The following describes how to call a stored program.

When you call a specified stored program, the last screen shown when you registered the stored program appears.

- 1 Press the <Services Home> button.

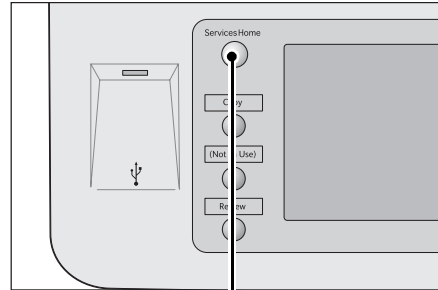

<Services Home> button

- 2 Select [Stored Programming].

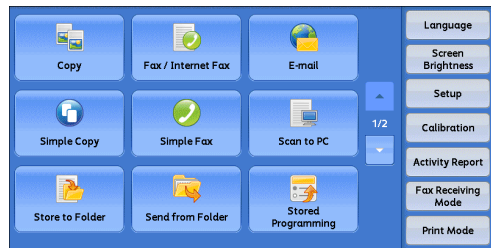

- 3 Select a number of a stored program containing the features you want to use.

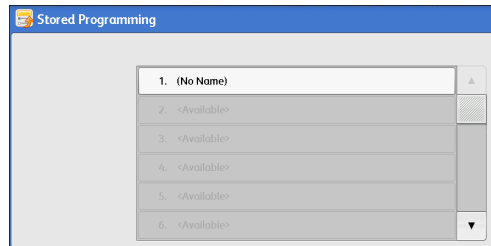

- Note**
- You can only select registered numbers.
  - Select [▲] to return to the previous screen or [▼] to move to the next screen.
  - After the stored program has been called, the machine sounds an audible tone. If a failure occurs, the machine sounds a fault tone.

For information on how to change the volume of the sound that notifies that a stored program has been called, refer to "5 Tools" > "Common Service Settings" > "Audio Tones" > "Stored Programming Complete Tone" in the Administrator Guide.

- 4 After the stored program is called, select other features if necessary.
- 5 Press the <Start> button.

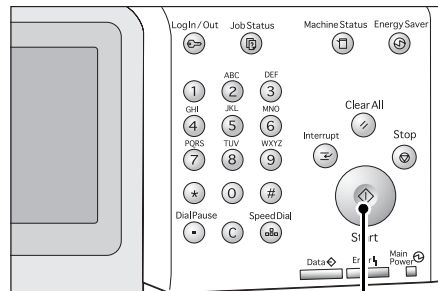

<Start> button

## Calling a Stored Program for Build Job

You can call a stored program for Build Job on the [Copy] screen displayed while Build Job is running.

- 1 Select [Change Settings].

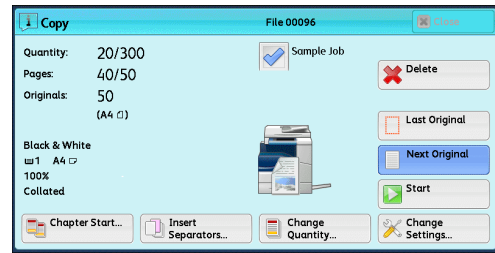

- 2 Select the [Job Assembly] tab.
- 3 Select [Stored Programming].
- 4 Select a number of a stored program containing the features you want to use.

- Note**
- You can only select registered numbers.
  - After the stored program has been called, the machine sounds an audible tone. If a failure occurs, the machine sounds a fault tone.

For information on how to change the volume of the sound that notifies that a stored program has been called, refer to "5 Tools" > "Common Service Settings" > "Audio Tones" > "Stored Programming Complete Tone" in the Administrator Guide.

# 8 Media Print (Text and Photos)

This chapter describes the basic procedures and features of Media Print - Text and Media Print - Photos when a USB memory device is connected.

**Note** • This service is not available for some models. An optional component is required. For more information, contact our Customer Support Center.

• Overview of Media Print.....	316
• Media Print - Text .....	319
• Media Print - Photos .....	321
• Selecting the Printing Options .....	323

## Overview of Media Print

If a USB memory device is connected to the machine, the data stored in the USB memory device can also be printed. You can also print scanned data stored with the Store to USB service.

The installation of commercially available Memory Card Reader allows the machine to retrieve and print image data (DCF1.0) taken with a digital camera as well as document files (PDF, TIFF, XPS, XDW, XBD and JPEG (JFIF)).

**Important** • Data stored in USB memory device may be lost or damaged in the following cases. Make sure to back up data in media before use.

- When disconnecting/connecting the USB memory device by methods other than described in this guide.
- When receiving the effect of electrical noise or an electrical discharge.
- When a fault or failure occurs during operation.
- If the USB memory device receives mechanical damage.
- We assume no responsibility for any direct and indirect damages arising from or caused by such data loss.
- When you use the Media Print - Text service to print scanned data stored with the Store to USB service, the data cannot be printed if they are saved in DocuWorks format.
- For Media Print - Photos, images can be displayed in thumbnail view, but cannot be previewed. For Media Print - Text, files cannot be displayed in thumbnail view and cannot be previewed either.

**Note** • For using commercially available Memory Card Reader, contact our Customer Support Center.

• Commercially available Memory Card Reader with single slot <sup>\*1</sup> can be used for Media Print feature (text/photo), but its safe performance is not guaranteed. When a Memory Card Reader with multi-slot <sup>\*2</sup> is used, only one particular slot is available. And which slot is available differs according to models and slot of media. Memory Card that you want to use is not always available. Safe performance of a Memory Card Reader with multi-slot is not guaranteed, either.

<sup>\*1</sup>: Media/Memory Card that has one slot. Some allows only one type of media/Memory Card, while others allows more than one types (ex. SD card, xD-Picture Card).

<sup>\*2</sup>: Media/Memory Card that has two or more slots.

- For using media other than USB memory device, contact our Customer Support Center.
- "Exif" is a file format that embeds information required to print the image data taken with a digital camera. The machine supports Exif 2.0 to 2.2.
- The Store to USB service is not available for some models. An optional component is required. For more information, contact our Customer Support Center.

The Media Print feature comprises two modes: Media Print - Photos and Media Print - Text. The Media Print - Photo mode prints data stored in the standard digital camera format, while the Media Print - Text mode prints data stored in text format. The feature also includes Index Printing that prints a list of files retrieved in the both modes.

## Supported Media and File Formats

The machine supports USB memory devices.



Supported media and file formats are as follows.

Supported Media	Supported File Format	
	Media Print - Photos	Media Print - Text
<ul style="list-style-type: none"> <li>• USB 2.0 memory</li> </ul>	<ul style="list-style-type: none"> <li>• JPEG files</li> <li>• TIFF files</li> </ul> <p>Supports DCF1.0-compliant JPEG/TIFF files (Exif2.0, Exif2.1, Exif2.2)</p>	<ul style="list-style-type: none"> <li>• PDF files</li> </ul> <p>Extension: pdf, PDF 1.3 or later</p> <ul style="list-style-type: none"> <li>• TIFF files</li> </ul> <p>Extension: tif, Grayscale 4-bit/8-bit uncompressed, 8-bit/24-bit JPEG compressed, MH/MMR compressed</p> <ul style="list-style-type: none"> <li>• XPS files</li> </ul> <p>Extension: xps</p> <ul style="list-style-type: none"> <li>• JPEG (JFIF)</li> </ul> <p>Extension: jpg</p>

- Important**
- When you specify the save location, only folder names are displayed in the list. File names and shortcuts (symbolic link or alias) are not displayed.
  - Folders that comply with the Design rule for Camera File system (DCF) standard used for digital cameras are not displayed.
  - If a full path (a string of folder and file names in all directories) of the file created exceeds 257 characters long, an error occurs.
  - If the medium contains more than 900 folders, the machine may not be able to recognize the medium correctly.
  - PDF files saved on Mac OS cannot be displayed on the screen and cannot be printed.
  - If a file name contains characters that are not supported by the machine, the file name will not be displayed on the screen.

- Note**
- In the Media Print - Photos mode, only 8 characters can be recognized as a file name. In the Media Print - Text mode, up to 255 characters can be recognized.
  - Up to 900 files can be processed with Media Print.
  - Use media formatted with digital cameras or computers (FAT12, FAT16, FAT32 only).
  - Use USB 2.0 compliant memory devices with the size up to 128GB only. (USB 1.1 compliant memory devices are not supported.)
  - The use of media recommended by Fuji Xerox is suggested. For information on recommended media, contact our Customer Support Center.
  - If a file name contains machine-dependent codes, the file may not be recognized or displayed on the screen correctly.

## Notes and Restrictions on Media Print

The following notes and restrictions apply on the use of the Media Print service.

- Use the Media Print - Photos service with a medium inserted. Otherwise, an error code (016-794/116-212) is displayed on the screen.
- Image files other than files in Exif format (JPEG/TIFF files created on computers) cannot be printed.
- Once an image file in Exif format is edited or saved on a computer, the file format is no longer the Exif format.
- If the medium fails, the process is terminated within a few minutes, and an error message is displayed.
- Eject the medium before switching off the power.

- Be sure to wait until printing is completed and then eject the medium by following the procedure described in this chapter.
- Always back up data in a medium before use.
- Printing data may take from a few minutes to several tens of minutes, depending on the size and number of files in the medium.
- Before storing document files, format the USB memory with a computer. (FAT12, FAT16, FAT32 only)
- When you print a PDF file using Media Print, [PDF Bridge] is selected regardless of the [Print Processing Mode] setting in [PDF Direct Print].  
For more information on [Print Processing Mode], refer to "15 Appendix" > "PDF Direct Print" in the Administrator Guide.
- You can use a USB host adapter to print from your USB memory device or via your USB cable (as necessary), but the operation is not guaranteed.
- Multiple USB memory devices cannot be used simultaneously.
- Use USB 2.0 compliant memory devices only. USB 1.1 compliant memory devices are not supported.  
The following USB memory devices are not supported:
  - A USB memory device with multiple media partitions that require other utilities to access to the contents therein.
  - A USB memory device connected via an external hub.
- Do not use a medium if it stores data that cannot be backed up, such as music data with the copyright protection function. We assume no responsibility for any direct and indirect damages arising from or caused by such data loss.
- The machine does not display a menu to prevent you from removing a USB memory device while it is being accessed.

## Media Print - Text

### Selecting Files

You can select files using any of the following three methods:

- Selecting all files
- Selecting the desired files on the [Select From List] screen
- Selecting one file or a range of files with index numbers

**Note** • You can select up to 32 files simultaneously.

- 1 Press the <Services Home> button.

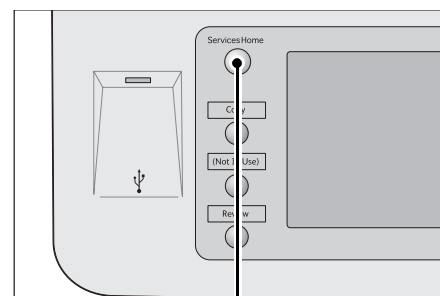

<Services Home> button

- 2 Select [Media Print - Text].

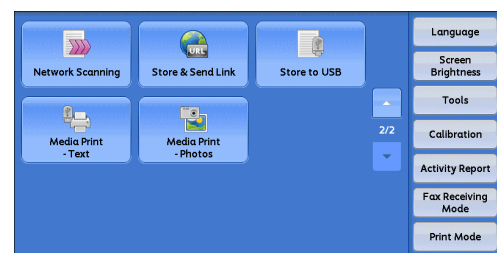

The machine starts retrieving files from the medium.

During the retrieval, a screen appears on the control panel indicating that the files are being transferred.

**Note** • Index numbers from 001 to 900 are automatically assigned to the files retrieved.

- 3 After the files are retrieved, select either [Select All] or [Select From List] to specify files.

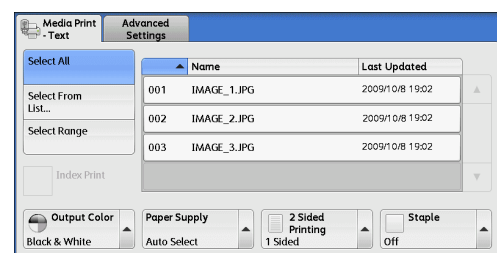

- 4 After selecting the files to be printed, select the printing options.

For more information on the printing options, refer to "Selecting the Printing Options" (P.323).

**Note**

- On the pop-up menu displayed when selecting files, you can cancel the selection or display details.
- Select [▲] to return to the previous screen or [▼] to move to the next screen.

#### ■Select All

Selects all document files to be printed.

**Note** • Depending on the type of files stored in the medium or the directory configuration, some files may not be printed.

**■Select From List**

Displays the [Select From List] screen.  
Refer to "[Select From List] Screen" (P.320).

**■Select Range**

Use [+] and [-] to specify the range of files to be printed in [First File] and [Last File] under [Media Print - Text].

**Note** • Select [Select From List] to display a list of files, and reference the list when selecting the range.

**■Index Print**

Prints a list of the selected files with the index numbers automatically assigned.  
For more information on Index Print, refer to "Index Print" (P.324).

**[Select From List] Screen**

This screen displays a list of files with their folder and file names and stored dates and times.

You can select the desired files from a list of files.

**1** Select the desired files from a list of files.

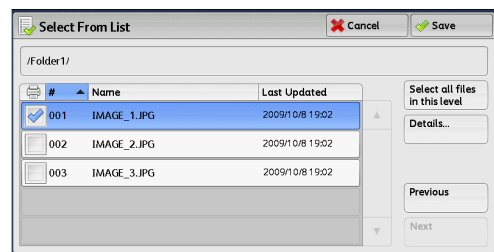

**Note**

- Select [▲] to return to the previous screen or [▼] to move to the next screen.
- You can sort the list in ascending or descending order by selecting [# ▲], [Name], or [Last Updated].
- A check mark is placed in the check box for each file selected. To deselect the file, select the file again while the file is selected (highlighted).
- If a folder or file name has more than 170 characters long, the folder or file name is not displayed.
- Folder names which include characters that the machine does not support may not be correctly displayed. If you specify the folders as file storage locations, an error occurs. For more information on characters that the machine supports, refer to "Entering Text" (P.58).
- The machine does not distinguish between upper and lower cases of folder and file names that are created in Windows environment and that consist of eight characters or less. The names for these folders and files are displayed in capital letters.

**■Details**

Displays detailed information on the selected (highlighted) file. To print the file, select the [Print] check box on the [Details] screen.

# Media Print - Photos

## Selecting Files

You can select files using any of the following three methods:

- Selecting all files
- Selecting the desired files on the [Select From List] screen. You can select up to 100 files simultaneously
- Selecting one file or a range of files with index numbers

**1** Press the <Services Home> button.

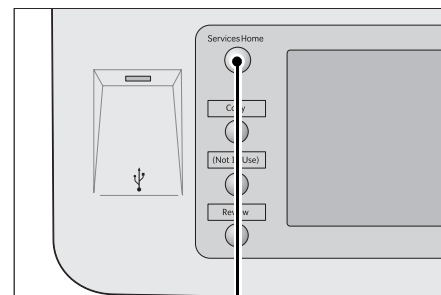

<Services Home> button

**2** Select [Media Print - Photos].

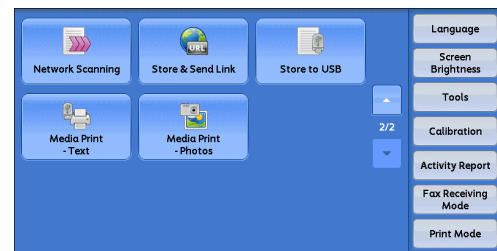

The machine starts retrieving files from the medium.

During the retrieval, a screen appears on the control panel indicating that the files are being transferred.

**Note** • Index numbers from 001 to 900 are automatically assigned to the files retrieved.

**3** After the files are retrieved, select either [Select All] or [Select From List] to specify files.

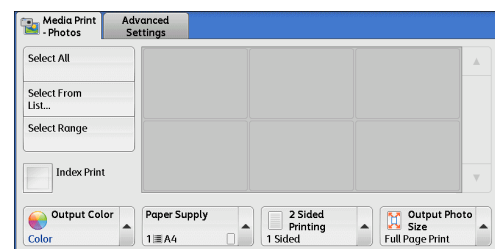

**4** After selecting the files to be printed, select the printing options.

For more information on the printing options, refer to "Selecting the Printing Options" (P.323).

**Note** • On the pop-up menu displayed when selecting files, you can cancel the selection or display details.  
• Select [▲] to return to the previous screen or [▼] to move to the next screen.

### ■Select All

Selects all image data to be printed.

- Note**
- Depending on the type of files stored in the medium or the directory configuration, some files may not be printed.

### ■ Select From List

Displays the [Select From List] screen.

Refer to "[Select From List] Screen" (P.322).

### ■ Select Range

Use [+] and [-] to specify the range of files to be printed in [First picture] and [Last picture] under [Media Print - Photos].

- Note**
- Select [Select From List] to display a list of files, and reference the list when selecting the range.

### ■ Index Print

Prints a list of the selected files with the index numbers automatically assigned.

For more information on Index Print, refer to "Index Print" (P.324).

## [Select From List] Screen

You can select the desired files from a list of files.

- Note**
- Select [▲] to return to the previous screen or [▼] to move to the next screen.
  - A check mark is placed in the check box for each file selected. To deselect the file, select the file again while the file is selected (highlighted).

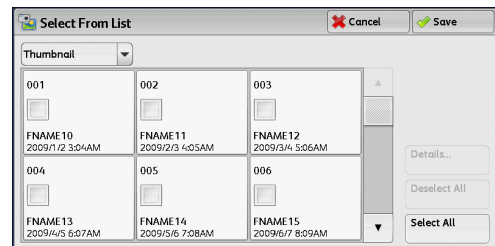

### ■ List

Display a list of files with their names and stored dates and times.

- Note**
- You can sort the list in ascending or descending order by selecting [# ▲], [Name], or [Date & Time]. The number of files selected appears on the top on the screen.

### ■ Thumbnail

Displays a list of the images and names of the files.

- Note**
- The thumbnail view may not be available for some files. If a file is not displayed in thumbnail view, display it in list view or in Index Print.
  - Characters and images may not be correctly displayed in thumbnail view because they are reduced in size.

- Note**
- An image is displayed in thumbnail view in the orientation with which the file was stored.

### ■ Details

Displays detailed information on the selected (highlighted) file. To print the file, select the [Print] check box on the [Details] screen.

### ■ Deselect All

Deselects all selected files.

### ■ Select All

Selects all files.

## Selecting the Printing Options

You can set the printing options on the [Media Print - Text] or [Media Print - Photos], and [Advanced Settings] tabs.

By default, pressing the <Custom 3> (Review) button on the control panel allows you to view a list of the setting values.

### Media Print - Photos

Tab	Item	Setting Value
-	Quantity	Specify the number of print sets in the range of 1 - 999, using the numeric keypad.
Media Print Photos	Output Color	Color, Black & White
	Paper Supply	Trays 1 - 5 <b>Note</b> • Select [Auto Paper Select] or the tray in which any of the following sizes of paper is loaded: A4, 8.5 x 11", B5 • When the desired tray is not displayed, select [More], and on the screen displayed, select the tray. When you select [More] and then [Tray 5], you can set [Paper Size] and [Paper Type]. • Paper Size Select the paper size to be used from the list: A4, 8.5 x 11", B5, 100 x 148 mm • Paper Type Select the paper type to be used from the list.
	2 Sided Printing	Off, Long Edge Flip, Short Edge Flip
	Output Photo Size	• Full Page Print • 5 x 7" When you select [Output Size] on the screen displayed after selecting [More], the following sizes are selectable: A4, 8.5 x 11", 100 x 148 mm, 3.5 x 5", 5 x 7" <b>Note</b> • According to the size selected here and the paper size, only the photos fitting on one sheet of paper are aligned and printed. If you select [1 Picture per Page], one sheet of paper is used for one file and printed. • 3 Pictures per Page (Center) When you select [Pictures per Page] on the screen displayed after selecting [More], the following options are available: 2 Pictures, 3 Pictures (Center), 3 Pictures (Left), 4 Pictures, 6 Pictures, 8 Pictures
Advanced Settings	Bitmap Smoothing	Off, On

- Note**
- When you select a paper size smaller than the image size, the image is automatically reduced. When you select a paper size larger than the image size, the image is printed at its original size.
  - The features displayed on the [Media Print - Photos] and [Advanced Settings] screens may vary depending on the combination of the optional components installed on the machine.

## Media Print - Text

Tab	Item	Setting Value
-	Quantity	Specify the number of print sets in the range of 1 - 999, using the numeric keypad.
Media Print Text	Output Color	Color, Black & White
	Paper Supply	Trays 1 - 5 <b>Note</b> • Select [Auto Paper Select] or the tray in which any of the following sizes of paper is loaded: A4, A5, B5, 8.5 x 11", 8.5 x 14" • When you select [Auto Select], the machine automatically selects a tray that contains the same size of paper as the document, and prints the document at its original size. • When the desired tray is not displayed, select [More], and on the screen displayed, select the tray. When you select [More] and then [Tray 5], you can set [Paper Size] and [Paper Type]. • Paper Size Select the paper size to be used from the list: A4, A5, A5, B5, 8.5 x 11", 8.5 x 14" • Paper Type Select the paper type to be used from the list.
	2 Sided Printing	Off, Long Edge Flip, Short Edge Flip
	Staple	Specify the stapling positions. When the desired stapling/punching positions are not displayed, select [More]. <b>Important</b> • If you select and print multiple documents, all of the documents are stapled together. To staple only one document, print only that document.
Advanced Settings	Pages per Side	Off, 2 Pages, 4 Pages
	Bitmap Smoothing	Off, On

- Note**
- When you select a paper size smaller than the document size, the document image is automatically reduced. When you select a paper size larger than the document size, the document is printed at its original size.
  - The features displayed on the [Media Print - Text] and [Advanced Settings] screens may vary depending on the combination of the optional components installed on the machine.

## Index Print

- In the Media Print - Photos mode, a list of 30 x 40 mm reduced images, plus index numbers, file names, and dates when images were stored in the medium are printed.
- In the Media Print - Text mode, names (up to 2 lines and 100 characters), dates when files were stored in the medium, and the total number of files are printed.

You can specify only the number of print sets for Index Print, in the range from 1 - 999 sets in 1 set increments. For other printing options, the settings you have specified for



Media Print - Text or Media Print - Photos before selecting the [Index Print] check box will be effective. To change these settings, deselect the [Index Print] check box, change the print settings, and then perform Index Print. The setting values return to the defaults if the machine is rebooted.

The following setting items are restricted when you select Index Print.

Setting Item	Value
Output Color	In the Media Print - Photos mode <ul style="list-style-type: none"> <li>• Color, Black &amp; White</li> </ul> In the Media Print - Text mode <ul style="list-style-type: none"> <li>• Black &amp; White only</li> </ul>
Paper Supply	Trays 1 - 5 <b>Note</b> • Select the tray in which any of the following sizes of paper is loaded: A4, 8.5 x 11"
2 Sided Printing	Off, Long Edge Flip, Short Edge Flip
Staple	Not available
Pages per Side	Not available



# 9 Job Status

This chapter describes how to check the status of jobs and operate the jobs.

- Job Status Overview ..... 328
- Checking Current/Pending Jobs ..... 329
- Checking Completed Jobs ..... 331
- Printing and Deleting Stored Jobs ..... 332
- Printing Pending Jobs ..... 345
- Handling Error Terminations ..... 346

## Job Status Overview

The Job Status feature allows you to check current, pending, and completed jobs. You can also cancel printing and print jobs that are waiting to be output or resumed.

- 1 Press the <Job Status> button.

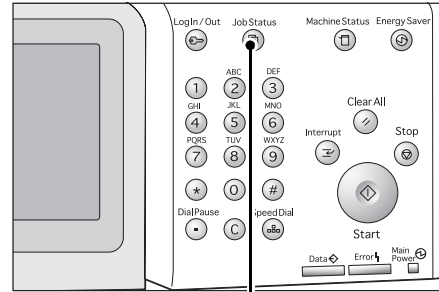

<Job Status> button

You can operate the following on the [Job Status] screen.

### ■Checking current/pending jobs

Lists current and pending jobs, and displays their details. Also allows you to cancel current or pending jobs.

For more information, refer to "Checking Current/Pending Jobs" (P.329).

### ■Checking completed jobs

Displays the status of completed jobs, and their details.

For more information, refer to "Checking Completed Jobs" (P.331).

### ■Checking stored jobs

Prints or deletes jobs stored using the Charge Print, Secure Print, Private Charge Print, Sample Set, and Delayed Print features.

For more information, refer to "Printing and Deleting Stored Jobs" (P.332).

### ■Printing Pending Jobs

Prints jobs that are waiting to be output or resumed.

For more information, refer to "Printing Pending Jobs" (P.345).

# Checking Current/Pending Jobs

This section describes how to check current or pending jobs. On the status screen, you can cancel or preferentially execute jobs.

- 1 Press the <Job Status> button.

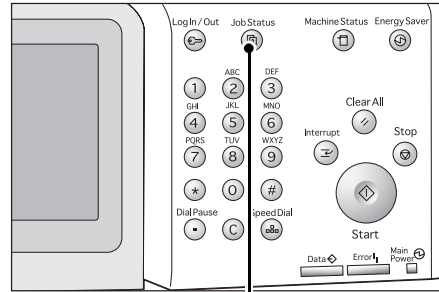

<Job Status> button

- 2 Select the job to be canceled or preferentially executed.

- Note**
- Select [▲] to return to the previous screen or [▼] to move to the next screen.
  - From the drop-down menu, you can select and display the desired type of jobs.

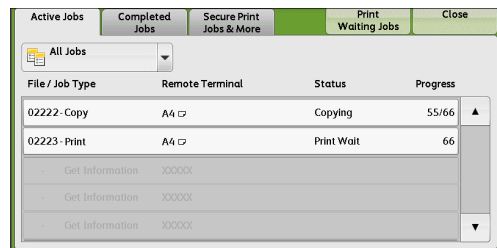

- 3 Select [Cancel] or [Promote Job].

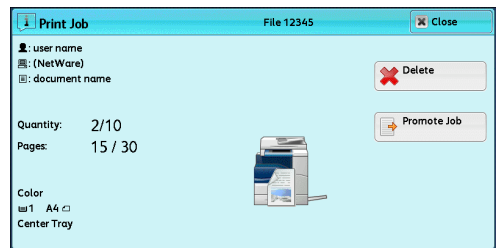

### ■Print Waiting Jobs

Prints the jobs that are waiting to be output or resumed.  
For more information, refer to "Printing Pending Jobs" (P.345).

### ■Delete

Cancels the current or pending job.

### ■Promote Job

Preferentially executes the selected job.  
If you select this button, [👉] appears under the [Status] of the selected job.

### ■Delete

Stops processing the job.

### ■Last Original

Select this button to end scanning of documents. The job is then executed.

### ■Next Original

Select this button when you have another document to scan.

■ **Start**

Resumes the suspended job.

■ **Change Quantity**

Displays the [Change Quantity] screen on which you can change the number of copies entered before. Enter a new quantity using the numeric keypad.

# Checking Completed Jobs

This section describes how to check completed jobs.

You can check whether a job has been completed successfully. Selecting a job allows you to see its details.

**1** Press the <Job Status> button.

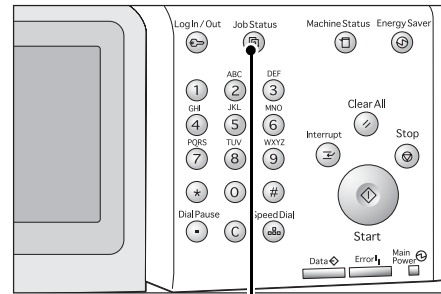

<Job Status> button

**2** Select the [Completed Jobs] tab.

- Note**
- Select [▲] to return to the previous screen or [▼] to move to the next screen.
  - From the drop-down menu, you can select and display the desired type of jobs.

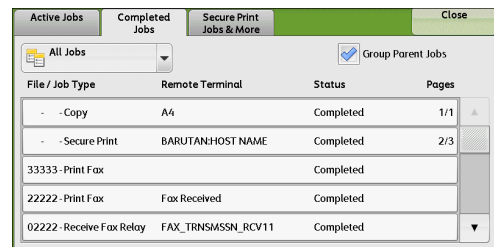

**3** Select a job to see the details.

**4** Select [Close] after the confirmation.

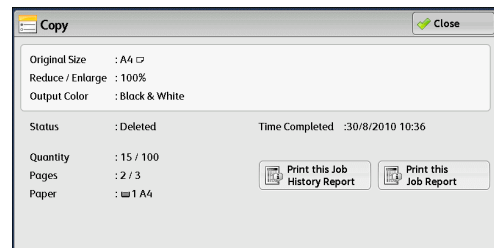

**■Group Parent Jobs**

Allows you to check the list or history of related jobs.

**■Show Children Jobs**

Displays a job list.

**■Print this Job History Report**

Prints the Job History Report.

**■Print this Job Report**

Prints the Job Report.

## Printing and Deleting Stored Jobs

This section describes how to print or delete jobs stored with the Secure Print or Sample Set feature, or stored with the [Receive Control] setting of the Charge Print feature. The [Secure Print Jobs & More] screen allows you to print or delete stored jobs.

The following shows the reference section for each feature.

Public Folder.....342  
 Undelivered Faxes.....343

**1** Press the <Job Status> button.

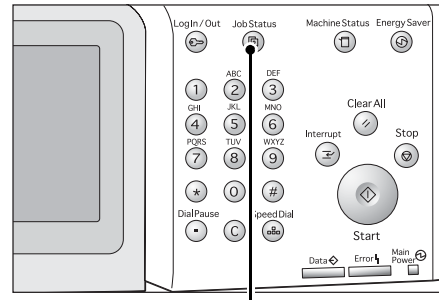

<Job Status> button

**2** Select the [Secure Print Jobs & More] tab.

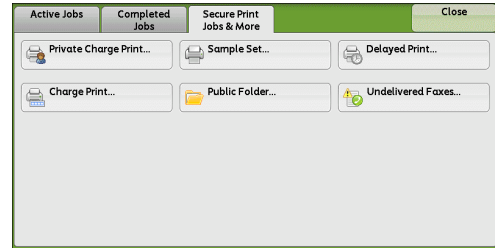

[Secure Print] and [Private Charge Print] are not displayed simultaneously on the screen. For more information on the settings, refer to "5 Tools" > "Authentication/Security Settings" > "Authentication" > "Charge/Private Print Settings" in the Administrator Guide.

### Secure Print

This feature allows you to temporarily store print data in the machine to print it with the print command from the machine. The feature also enables you to set a passcode, which is helpful to print confidential documents.

The following describes how to print or delete jobs stored with the Secure Print feature.

- Note**
- This feature does not appear when [Receive Control] in [Charge/Private Print Settings] is set to either of the following:
    - Select [According to Print Auditor], and then select [Save as Private Charge Print Job] in [Job Login Success].
    - Select [Save as Private Charge Print Job].

When [Save as Private Charge Print Job] or [Save as Charge Print Job] is selected in [Receive Control] under [Charge/Private Print Settings], jobs will not be saved in [Secure Print] under [Secure Print Jobs & More] even if you select [Secure Print] on the print driver. For more information, refer to "5 Tools" > "Authentication/Security Settings" > "Authentication" > "Charge/Private Print Settings" in the Administrator Guide.

For information on how to operate a Secure Print job, refer to the print driver's help.

**1** Select [Secure Print].



**2** Select the user to be checked, and select [Job List].

- Note**
- Select [Refresh] to display the updated information.
  - Select [▲] to return to the previous screen or [▼] to move to the next screen.
  - You can enter a user ID in [Go to] using the numeric keypad to display the user ID at the top of the list.

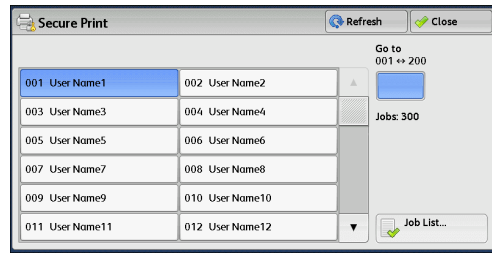

**3** Enter the passcode, and select [Confirm].

- Note**
- If the passcode is not set, the passcode entry screen does not appear.

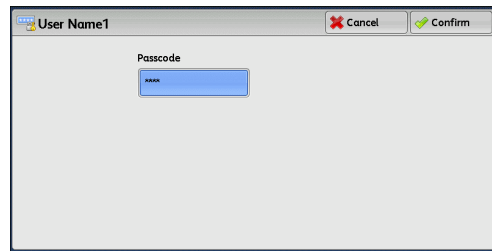

**4** Select the job to be printed or deleted.

- Note**
- You can select up to 100 files simultaneously to print or delete the files. If you select multiple files, they are printed in the selected order.

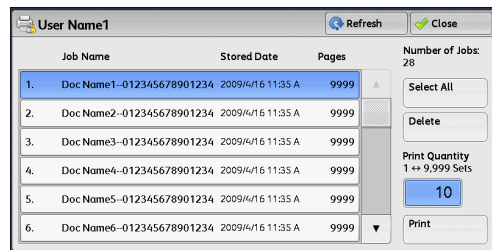

**5** Select any option.

**6** When printing, specify the number of print sets using the numeric keypad.

**■Select All**

Selects all jobs. To deselect all the jobs, select this button again.

**■Delete**

Deletes the Secure Print job.

- Note**
- If jobs with the same Billing ID are all deleted, the Billing ID will be deleted. Refer to "When [Delete] is Selected" (P.334).

**■Print Quantity**

Specify the number of print sets.

**■Print**

Prints the Secure Print job. After printing, the job is deleted.

Refer to "When [Print] is Selected" (P.334).

### When [Delete] is Selected

- 1 Select [Delete].

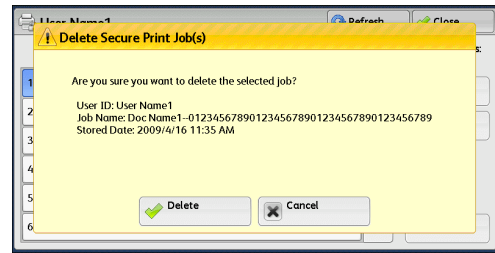

**■Delete**

Deletes the job.

**Important** • Once the job is deleted, it cannot be restored.

**■Cancel**

Cancels deleting the job.

### When [Print] is Selected

- 1 Specify how to process the job after printing.

**Note** • The screen as shown on the right does not appear if [Print Job Confirmation Screen] is set to [Disabled] in the System Administration mode. If [Disabled] is selected, the machine automatically deletes the job after printing without displaying the confirmation screen. For more information, refer to "5 Tools" > "Stored File Settings" > "Print Job Confirmation Screen" in the Administrator Guide.

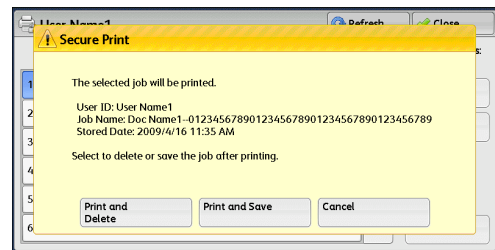

**■Print and Delete**

Starts printing the job. After printing, the job is deleted.

**■Print and Save**

Starts printing the job. After printing, the job remains undeleted.

**■Cancel**

Cancels printing the job.

### Sample Set

Before printing multiple sets of a document, you can first print one set for trial, and then print the remaining sets from the machine.

The following describes how to print or delete jobs stored with the Sample Set feature.

For information on how to operate a Sample Set job, refer to the print driver's help.

**Note** • When [Save as Private Charge Print Job] or [Save as Charge Print Job] is selected in [Receive Control] under [Charge/Private Print Settings], jobs will not be saved in [Sample Set] under [Secure Print Jobs & More] even if you select [Sample Set] on the print driver.

For more information, refer to "5 Tools" > "Authentication/Security Settings" > "Authentication" > "Charge/Private Print Settings" in the Administrator Guide.

- 1 Select [Sample Set].

2 Select the user you want to check, and select [Job List].

- Note**
- Select [Refresh] to display the updated information.
  - Select [▲] to return to the previous screen or [▼] to move to the next screen.
  - You can enter a user ID in [Go to] using the numeric keypad to display the user ID at the top of the list.

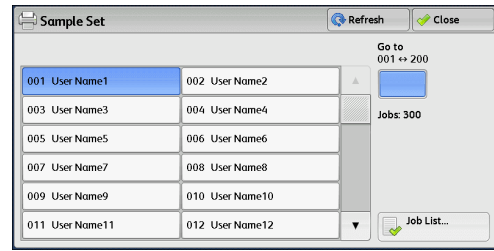

3 Select the job to be printed or deleted.

- Note**
- You can select up to 100 files simultaneously to print or delete the files. If you select multiple files, they are printed in the selected order.

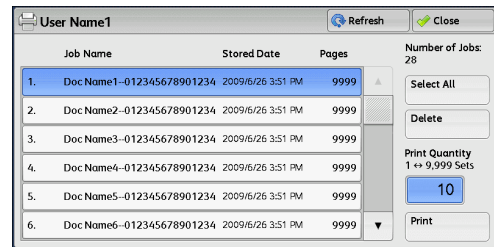

4 Select any option.

5 When printing, specify the number of print sets using the numeric keypad.

**■Select All**

Selects all jobs. To deselect all the jobs, select this button again.

**■Delete**

Deletes the Sample Set job.  
Refer to "When [Delete] is Selected" (P.335).

**■Print Quantity**

Specify the number of print sets using the numeric keypad.

**■Print**

Prints the Sample Set job. After printing the remaining sets of the job, the job is deleted.  
Refer to "When [Print] is Selected" (P.336).

**When [Delete] is Selected**

1 Select [Delete].

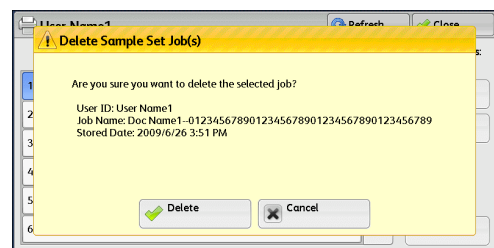

**■Delete**

Deletes the job.  
**Important** • Once the job is deleted, it cannot be restored.

**■Cancel**

Cancels deleting the job.

## When [Print] is Selected

### 1 Select [Yes].

- Note**
- The screen as shown on the right does not appear if [Print Job Confirmation Screen] is set to [Disabled] in the System Administration mode. If [Disabled] is selected, the machine automatically deletes the job after printing without displaying the confirmation screen. For more information, refer to "5 Tools" > "Stored File Settings" > "Print Job Confirmation Screen" in the Administrator Guide.

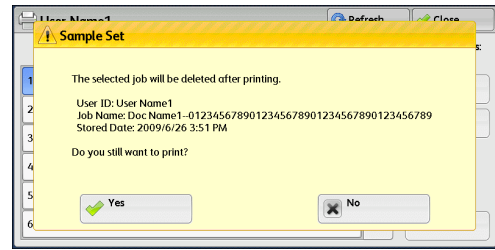

#### ■Yes

Starts printing the job. After printing, the job is deleted.

- Note**
- After a sample set is output, the remaining sets will automatically be output if the machine is not instructed for the period specified in [Auto Job Release]. To prevent the remaining sets from being output automatically, set [Auto Job Release] to [Off]. For information on how to set [Auto Job Release], refer to "5 Tools" > "Common Service Settings" > "Machine Clock/Timers" > "Auto Job Release" in the Administrator Guide.

#### ■No

Cancels printing the job.

## Delayed Print

This feature allows you to temporarily store print data on the machine to print it at specified time.

Up to 100 jobs can be stored (queued) simultaneously for the Delayed Print feature. If the power is switched off when jobs are in queue (before the specified print time), the jobs whose print time has elapsed will automatically be printed immediately after the power is switched on again.

The following describes how to print or delete jobs stored with the Delayed Print feature.

For information on how to operate a Delayed Print job, refer to the print driver's help.

- Note**
- When [Save as Private Charge Print Job] or [Save as Charge Print Job] is selected in [Receive Control] under [Charge/Private Print Settings], jobs will not be saved in [Delayed Print] under [Secure Print Jobs & More] even if you select [Delayed Print] on the print driver. For more information, refer to "5 Tools" > "Authentication/Security Settings" > "Authentication" > "Charge/Private Print Settings" in the Administrator Guide.

### 1 Select [Delayed Print].

### 2 Select the job to be printed or deleted.

- Note**
- Select [Refresh] to display the updated information.
  - Select [▲] to return to the previous screen or [▼] to move to the next screen.
  - [Print Time] shows the time to start printing.

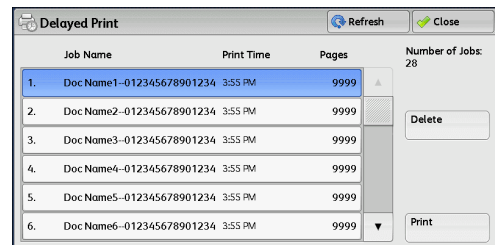

### 3 Select any option.

#### ■Delete

Deletes the Delayed Print job.

Refer to "When [Delete] is Selected" (P.337).

**■Print**

Prints the Delayed Print job. After printing, the job is deleted. If printed manually, the job will not be printed at the specified time.

Refer to "When [Print] is Selected" (P.337).

**When [Delete] is Selected**

- 1 Select [Delete].

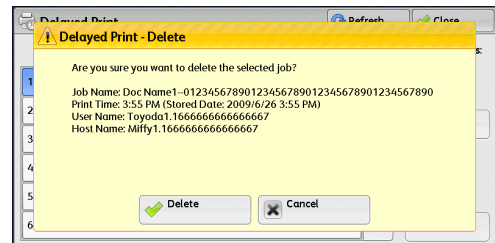

**■Delete**

Deletes the job.

**Important** • Once the job is deleted, it cannot be restored.

**■Cancel**

Cancels deleting the job.

**When [Print] is Selected**

- 1 Select [Yes].

**Note** • The screen as shown on the right does not appear if [Print Job Confirmation Screen] is set to [Disabled] in the System Administration mode. If [Disabled] is selected, the machine automatically deletes the job after printing without displaying the confirmation screen. For more information, refer to "5 Tools" > "Stored File Settings" > "Print Job Confirmation Screen" in the Administrator Guide.

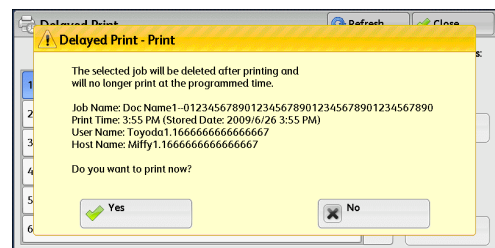

**■Yes**

Starts printing the job. After printing, the job is deleted.

**■No**

Cancels printing the job.

**Charge Print**

This feature authenticates users on the machine to prevent unauthorized users from operating print jobs. When this feature is enabled, the machine prints only the jobs of authenticated users. You can also configure the machine to store print jobs temporarily, and then print them from the machine's control panel.

If received print jobs are set to be saved as Charge Print under [Tools] > [Authentication/Security Settings] > [Authentication] > [Charge/Private Print Settings] > [Receive Control], the jobs are saved for each Billing ID. Any jobs that were not given a Billing ID on the print driver are saved in [No User ID].

For more information on how to register user IDs on the machine, refer to "5 Tools" > "Accounting" > "Create/View User Accounts" in the Administrator Guide.

- Note**
- Unlike the Private Charge Print feature, the Charge Print feature can store jobs without a user ID, such as e-mail printing and print jobs sent from ContentsBridge or CentreWare Internet Services, and can print the jobs after authenticating users.
  - [Charge Print] appears when [Save as Charge Print Job] is selected by using one of the following procedures in the System Administration mode:
    - Select [Save as Charge Print Job] in [Receive Control].
    - Select [According to Print Auditor] in [Receive Control], and then select [Save as Charge Print Job] in [Job Login Failure].
    - Select [According to Print Auditor] or [Save as Private Charge Print Job] in [Receive Control], and then select [Save as Charge Print Job] in [Job without User ID].

For information on how to set Charge Print, refer to "5 Tools" > "Authentication/Security Settings" > "Authentication" > "Charge/Private Print Settings" in the Administrator Guide.

The following describes how to print and delete a job stored with the Charge Print feature.

**1** Press the <Log In/Out> button on the control panel, or select the login information field on the touch screen.

**2** Enter the user ID, and select [Enter].

- Note**
- When the passcode is set, enter the user ID and select [Next]. Then, enter the passcode and select [Enter].
  - While a user is authenticated, the <Log In/Out> button lights up on the control panel.
  - To log out of the machine, press the <Log In/Out> button on the control panel.

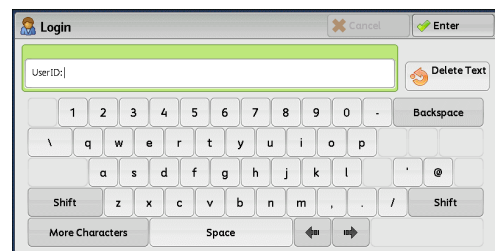

**3** Select [Charge Print].

**4** Select the user to be checked, and select [Job List].

- Note**
- Select [Refresh] to display the updated information.
  - Select [▲] to return to the previous screen or [▼] to move to the next screen.
  - You can enter a user ID in [Go to] using the numeric keypad to display the user ID at the top of the list.

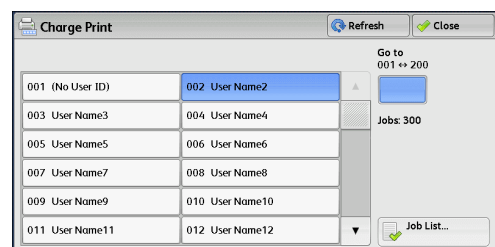

**5** Enter the passcode, and select [Confirm].

- Note**
- If the passcode is not set, the passcode entry screen does not appear.

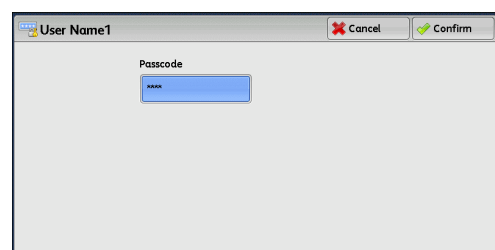

6 Select the job to be printed or deleted.

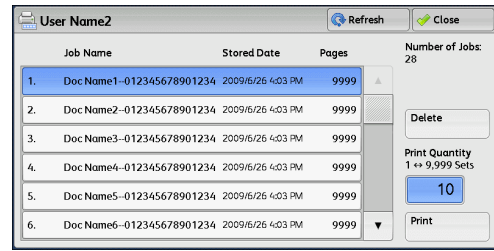

7 Select any option.

8 When printing, specify the number of print sets using the numeric keypad.

■Delete

Deletes the Charge Print job.  
Refer to "When [Delete] is Selected" (P.339).

■Print Quantity

Specify the number of print sets using the numeric keypad.

■Print

Prints the Charge Print job. After printing, the job is deleted.  
Refer to "When [Print] is Selected" (P.339).

When [Delete] is Selected

1 Select [Delete].

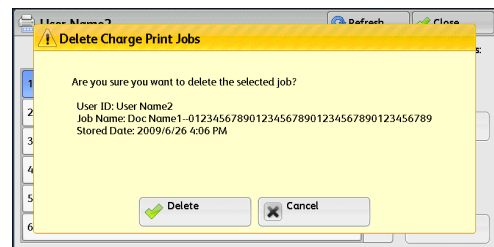

■Delete

Deletes the job.  
**Important** • Once the job is deleted, it cannot be restored.

■Cancel

Cancels deleting the job.

When [Print] is Selected

1 Specify how to process the job after printing.

**Note** • The screen as shown on the right does not appear if [Print Job Confirmation Screen] is set to [Disabled] in the System Administration mode. If [Disabled] is selected, the machine automatically deletes the job after printing without displaying the confirmation screen. For more information, refer to "5 Tools" > "Stored File Settings" > "Print Job Confirmation Screen" in the Administrator Guide.

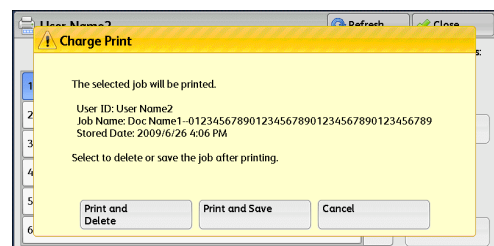

### ■Print and Delete

Starts printing the job. After printing, the job is deleted.

### ■Print and Save

Starts printing the job. After printing, the job remains undeleted.

### ■Cancel

Cancels printing the job.

## Private Charge Print

This feature allows you to temporarily store print data in the machine for each authentication user ID, and request on the machine's control panel to print the data. As the feature enables you to select and print only necessary jobs, you can avoid printing unnecessary jobs. Furthermore, the machine displays only the jobs of authenticated users and their associated sub users to securely protect the privacy of the users. The Private Print feature is suitable for authenticating and managing specific users managed by the system administrator.

If received print jobs are set to be saved with Private Charge Print, the jobs are saved for each authentication user ID.

- Note**
- An application (sold separately) is required to use the feature that associates sub users with the user ID of a login user. For more information, contact our Customer Support Center.
  - [Private Charge Print] is displayed when [Receive Control] in [Charge/Private Print Settings] is set to either of the following:
    - Select [According to Print Auditron] in [Receive Control], and then select [Save as Private Charge Print Job] in [Job Login Success].
    - Select [Save as Private Charge Print Job] in [Receive Control].
  - When the Private Charge Print feature is selected, you cannot specify normal print, Secure Print, Sample Set, Delayed Print on the print driver.

The Private Charge Print feature restricts the use of the machine through either user ID authentication or card authentication (only the IC Card Reader (optional) is available), or the combination of both. For information on the types of authentication, refer to "13 Authentication and Accounting Features" > "Authentication" > "Types of Authentication" in the Administrator Guide.

To delete a print job instructed with an invalid user ID, display the list of print jobs after logging in as a system administrator, and then select the job to be deleted. For more information, refer to "3 Maintenance" > "Deleting a Private Charge Print Job with an Invalid User ID" in the Administrator Guide. For information on how to set a User ID, refer to "5 Tools" > "Authentication/Security Settings" > "Authentication" > "Charge/Private Print Settings" in the Administrator Guide.

The following describes how to print or delete a job stored with the Private Charge Print feature.

- 1 Press the <Log In/Out> button on the control panel, or select the login information field on the touch screen.
- 2 Enter the user ID, and select [Enter].

- Note**
- When the passcode is set, enter the user ID and select [Next]. Then, enter the passcode and select [Enter].
  - While the user is authenticated, the <Log In/Out> button lights up on the control panel.
  - To log out of the machine, press the <Log In/Out> button on the control panel.

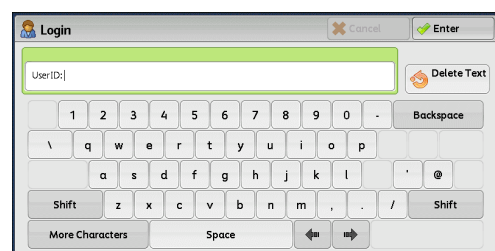

- 3 Select [Private Charge Print].



- Note** • If you are authenticated as a system administrator, selecting [Private Charge Print] will display a list of authentication user IDs. Select a user ID from the list, and then select [Job List] to display a list of jobs stored for the selected user.

**4** Select the job to be printed or deleted.

- Note** • You can select up to 100 files simultaneously to print or delete the files. If you select multiple files, they are printed in the selected order.

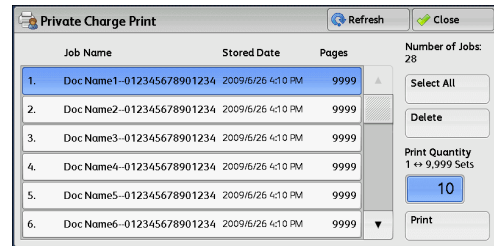

**5** Select any option.

**6** When printing, specify the number of print sets using the numeric keypad.

**■Select All**

Selects all jobs. To deselect all the jobs, select this button again.

**■Delete**

Deletes the Private Charge Print job.

- Note** • If jobs with the same user ID are all deleted, the user ID will be deleted. Refer to "When [Delete] is Selected" (P.341).

**■Print Quantity**

Specify the number of print sets using the numeric keypad.

**■Print**

Prints the Private Charge Print job. After printing, the job is deleted.

Refer to "When [Print] is Selected" (P.342).

**When [Delete] is Selected**

**1** Select [Delete].

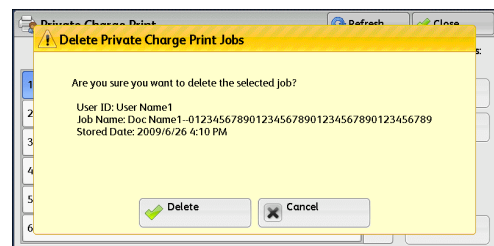

**■Delete**

Deletes the job.

**Important** • Once the job is deleted, it cannot be restored.

**■Cancel**

Cancels deleting the job.

## When [Print] is Selected

### 1 Specify how to process the job after printing.

- Note**
- The screen as shown on the right does not appear if [Print Job Confirmation Screen] is set to [Disabled] in the System Administration mode. If [Disabled] is selected, the machine automatically deletes the job after printing without displaying the confirmation screen. For more information, refer to "5 Tools" > "Stored File Settings" > "Print Job Confirmation Screen" in the Administrator Guide.

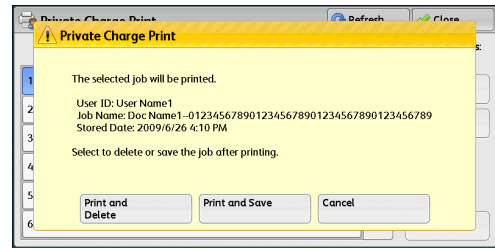

#### ■Print and Delete

Starts printing the job. After printing, the job is deleted.

#### ■Print and Save

Starts printing the job. After printing, the job remains undeleted.

#### ■Cancel

Cancels printing the job.

## Public Folder

This feature allows you to store data in the machine and send the data by operating on a remote machine.

The following describes how to print or delete a job stored in a public folder.

For information on how to operate public folders, refer to "Store for Polling (Storing Files on the Machine that a Remote Machine can Retrieve)" (P.202).

- Note**
- This feature does not appear for some models. An optional component is required. For more information, contact our Customer Support Center.

### 1 Select [Public Folder].

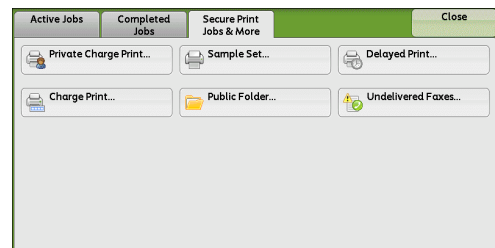

### 2 Select the job to be printed or deleted.

- Note**
- Select [Refresh] to display the updated information.
  - Select [▲] to return to the previous screen or [▼] to move to the next screen.

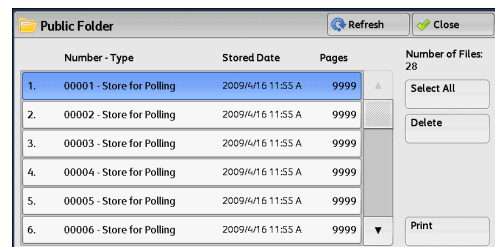

### 3 Select any option.

#### ■Select All

Selects all jobs. To deselect all the jobs, select this button again.

#### ■Delete

Deletes the selected job stored in the public folder.

Refer to "When [Delete] is Selected" (P.343).

■ **Print**

Prints the selected job stored in the public folder.

Refer to "When [Print] is Selected" (P.343).

**When [Delete] is Selected**

- 1 Select [Delete].

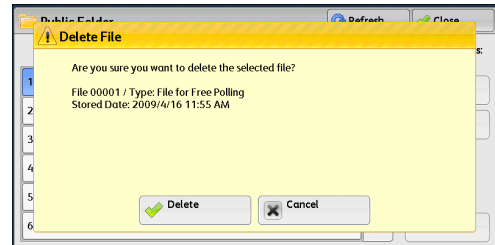

■ **Delete**

Deletes the job.

**Important** • Once the job is deleted, it cannot be restored.

■ **Cancel**

Cancels deleting the job.

**When [Print] is Selected**

Starts printing the job.

**Undelivered Faxes**

The following describes how to re-send or delete an undelivered fax job.

- Note**
- This feature may not appear depending on the settings in the System Administration mode.
  - This feature does not appear for some models. An optional component is required. For more information, contact our Customer Support Center.

- 1 Select [Undelivered Faxes].
- 2 Select the job to be re-sent or deleted.

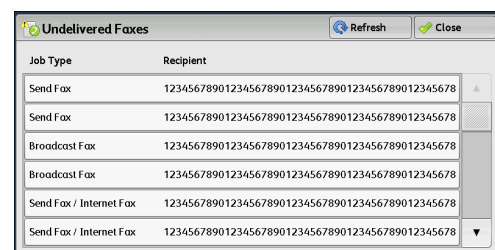

- Note**
- Select [Refresh] to display the updated information.
  - Select [▲] to return to the previous screen or [▼] to move to the next screen.

- 3 Select any option.  
To re-send to the previously specified fax number, press the <Start> button.

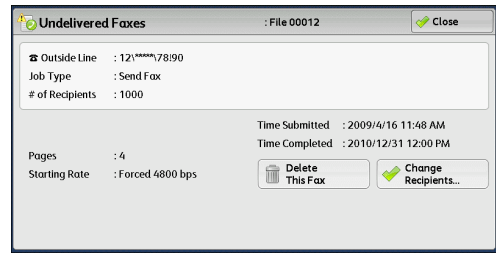

■Delete This Fax

Deletes the undelivered fax job.  
Refer to "When [Delete This Fax] is Selected" (P.344).

■Change Recipients

Allows you to change the fax recipient and re-send the undelivered fax job.  
Refer to "When [Change Recipients] is Selected" (P.344).

When [Delete This Fax] is Selected

- 1 Select [Delete].

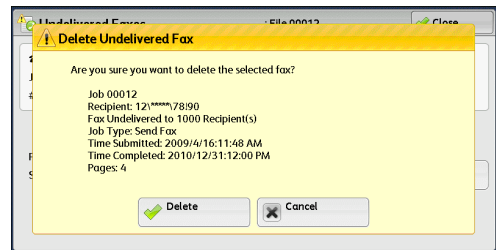

■Delete

Deletes the undelivered fax job.

■Cancel

Cancels deleting the undelivered fax job.

When [Change Recipients] is Selected

Specify a fax recipient for the undelivered fax job.

Besides the fax recipient, the following features can be changed on the control panel:

- Fax type
- Starting Rate

**Important** • If the fax recipient has been changed, header information will not be added even if [Transmission Header Text] is set to [Display Header].

For information on how to specify fax recipients, refer to "Step 3 Specifying Destinations" (P.145).

# Printing Pending Jobs

After the last user operation on the control panel of the machine, a job is waiting to be printed until the period of time specified in [Auto Print] elapses, instead of being printed immediately. You can forcibly print this pending job without waiting for this time period to elapse.

If a job is paused by the <Stop> button and is waiting to be resumed, you can also resume the job. If there are multiple jobs, subsequent jobs are printed after the paused job has been printed.

**Note** • If there are no pending jobs, the [Print Waiting Jobs] button is disabled.

For information on how to set [Auto Print], refer to "5 Tools" > "Common Service Settings" > "Machine Clock/Timers" > "Auto Print" in the Administrator Guide.

- 1 Press the <Job Status> button.

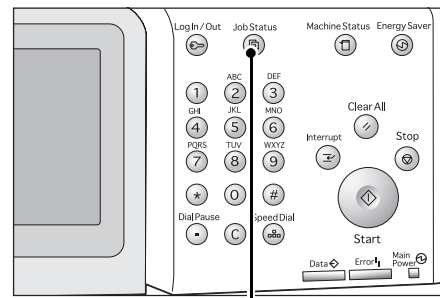

<Job Status> button

- 2 Select [Print Waiting Jobs].

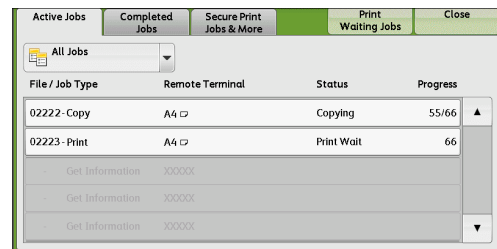

---

## Handling Error Terminations

---

This section describes how to handle error terminations.

### ■For a Print Job

Select a job shown as an error termination on the [Completed Jobs] tab to check the error code. Follow the instructions of the error code to solve the problem.

If an error occurs during a print job, the machine can be configured either to pause the print job until the error is confirmed by the user, or to automatically cancel the error job so that subsequent jobs can be printed.

For more information on the setting, refer to "5 Tools" > "Print Service Settings" in the Administrator Guide.

For information on error codes, refer to "14 Problem Solving" > "Error Code" in the Administrator Guide.

### ■For a Fax Job

A Transmission Report - Job Undelivered is printed.

For more information on the Transmission Report - Job Undelivered, refer to "4 Machine Status" > "Machine Information" > "Automatically Printed Reports/Lists" > "Transmission Report - Job Undelivered" in the Administrator Guide. For more information on how to print the Transmission Report - Job Undelivered automatically, refer to "5 Tools" > "Common Service Settings" > "Reports" > "Transmission Report - Job Undelivered" in the Administrator Guide.

### ■For a Scan Job

A Transmission Report - Job Undelivered is printed.

For more information on the Transmission Report - Job Undelivered, refer to "4 Machine Status" > "Machine Information" > "Automatically Printed Reports/Lists" > "Transmission Report - Job Undelivered" in the Administrator Guide. For more information on how to print the Transmission Report - Job Undelivered automatically, refer to "5 Tools" > "Common Service Settings" > "Reports" > "Transmission Report - Job Undelivered" in the Administrator Guide.

### ■For Other Jobs

Print a Job History Report, and check the execution results.

For information on the Job History Report, refer to "5 Tools" > "Common Service Settings" > "Reports" > "Job History Report" in the Administrator Guide.

When an error code is listed in the Transmission Report - Job Undelivered or the Job History Report, refer to "14 Problem Solving" > "Error Code" in the Administrator Guide.

# 10 Computer Operations

This chapter describes how to print documents, import scanned files, use Direct Fax, and operate CentreWare Internet Services on your computer.

- Note**
- Some models do not support the features described in this chapter. An optional component is required. For more information, contact our Customer Support Center.
  - The computer screen images shown in this chapter are as of December 2010.
  - The procedures in this chapter may vary depending on the driver and utility software being used due to the upgrades.

• Features Overview.....	348
• Print .....	349
• E-mail Printing .....	352
• Sending Fax.....	354
• Importing Scanned Data .....	356
• CentreWare Internet Services .....	364

## Features Overview

---

---

This section describes an overview of features you can perform from a computer.

### ■ Printing

Submits a print job to the machine from a computer.

For more information, refer to "Print" (P.349).

### ■ E-mail Printing

Submits a print job to the machine from a computer by sending e-mail attached with a document. The received e-mail is automatically printed from the machine according to the settings on the machine.

For more information, refer to "E-mail Printing" (P.352).

### ■ Sending Fax

Sends a fax directly from a computer.

For more information, refer to "Sending Fax" (P.354).

### ■ Importing Scanned Data

Imports files stored in a folder of the machine to a computer.

For more information, refer to "Importing Scanned Data" (P.356).

### ■ CentreWare Internet Services

Displays the machine status and job status. The feature also allows you to change settings as well as to import files stored in a folder.

For more information, refer to "CentreWare Internet Services" (P.364).

For information on how to import scanned data stored in a folder, refer to "Importing Using CentreWare Internet Services" (P.360).



---

# Print

---

This section describes how to print with the machine by operating on a computer.

## Print Features

---

The main print features of the machine are as follows:

### Printing Using a Print Driver

For more information on print features, click [Help] on the print driver screen to view the print driver's help. For information on printing, refer to "Printing" (P.351).

**Note** • Some features become available after you make option settings on the [Configuration] tab. The unavailable features are grayed out.

#### ■Pages Per Sheet (N-Up)

Prints multiple pages onto one sheet of paper.

#### ■2-Sided Print

Prints data on both sides of paper.

#### ■Poster

Splits one page of print data into multiple sheets of paper and enlarges the printed image to fit the size of each sheet. Used to create large posters.

#### ■Booklet Creation

Performs 2-sided printing and page allocation for printing a booklet in the correct page order.

**Important** • The following features are not available for the machine:

- Fold the output sheets in half
- Staple the folded output sheets

#### ■Transparency Separators

Automatically inserts a blank sheet of paper as a separator each time a transparency is printed.

**Note** • When [Printed Separators] is specified as separator option, output positions of transparency sheets and separators do not align.

#### ■Watermark

Prints preset text, such as "Confidential", over the print data.

#### ■Secure Print

Temporarily stores the print data on the machine, to print it with the print command from the machine. This feature allows you to set a passcode, which is helpful to print confidential documents.

For information on how to print a Secure Print job, refer to "Secure Print" (P.332).

#### ■Sample Set

Before printing multiple sets of a document, you can first print one set for trial, and then print the remaining sets from the machine.

For information on how to print a Sample Set job, refer to "Sample Set" (P.334).

**■Delayed Print**

Temporarily stores the print data on the machine to print it at specified time.

For information on how to print a Delayed Print job, refer to "Delayed Print" (P.336).

**■Store in Remote Folder**

Temporarily stores the print data in a registered folder, to print the data with the print command from the machine.

**Important** • The print result of the Store in Remote Folder feature may be inferior to the other print results in quality.

For information on how to print files in a folder, refer to "Printing Files in a Folder" (P.296).

**Direct Printing**

Allows you to directly send TIFF, PDF, JPEG, XPS, XDW (DocuWorks), or XBD (DocuWorks binder) format files from a computer to the machine without using a print driver.

For information on Direct Printing, refer to "Print" > "Job Submission" in the help of CentreWare Internet Services.

**E-mail Printing**

Allows you to send e-mail with the TIFF, PDF, JPEG (JFIF), XPS, XDW (DocuWorks), or XBD (DocuWorks binder) format documents attached from a computer to the machine. The received e-mail is automatically printed from the machine.

**Note** • If the Authentication feature is enabled, received e-mails are not printed automatically.

For information on how to use E-mail Printing, refer to "E-mail Printing" (P.352).

**Print Features Using Authentication Information****■Charge Print**

This feature authenticates users on the machine to prevent unauthorized users from operating print jobs. When this feature is enabled, the machine prints only the jobs of authenticated users. The machine can also be configured to store multiple print jobs temporarily until the user requests to print them on the control panel.

In addition, by registering an authentication user ID and passcode on the machine in advance, only the registered user can print the jobs.

**Note** • To prohibit other users from operating jobs, register a passcode for your Billing ID on the print driver.

For information on how to set Charge Print, refer to "5 Tools" > "Authentication/Security Settings" > "Authentication" > "Charge/Private Print Settings" in the Administrator Guide. For information on how to print a Charge Print job, refer to "Charge Print" (P.337).

**■Private Charge Print**

This feature allows you to temporarily store print data in the machine for each authentication user ID, and request on the machine's control panel to print the data. As the feature enables you to select and print only necessary jobs, you can avoid printing unnecessary jobs. Furthermore, the machine displays only the jobs of authenticated users and their associated sub users to securely protect the privacy of the users. This feature is suitable for authenticating and managing specific users managed by the system administrator.

**Note** • If you do not want to store unnecessary jobs, you can configure the machine to store only the jobs whose authentication succeeded.  
• An application (sold separately) is required to use the feature that associates sub users with the User ID of a login user. For more information, contact our Customer Support Center

For information on how to set Private Charge Print, refer to "5 Tools" > "Authentication/Security Settings" > "Authentication" > "Charge/Private Print Settings" in the Administrator Guide. For information on how to print a Private Charge Print job, refer to "Private Charge Print" (P.340).

## Setup

To print from your computer, your computer must have a print driver installed.

For information on how to install the print driver, refer to the manual included in the Driver CD Kit.

**Note** • When printing using authentication information, you must configure the printer settings on your computer. Make the necessary settings on the [Configuration] tab of the printer's properties. For more information, refer to the print driver's help.

## Printing

This following describes how to print documents.

The printing procedure depends on the application software you use. For more information, refer to the documentation provided with the application.

For more information on print features, click [Help] on the print driver screen to view the print driver's help.

Move the lever of the fusing unit down to set to the Envelope mode before printing on an envelope. Return the lever to its original position before printing on other types of papers. Any type of paper other than envelope cannot be printed while the lever is set to the Envelope mode position. For information on how to switch the lever of the fusing unit, refer to "2 Paper and Other Media" > "Loading Paper" > "Loading an Envelope in Tray 1 to 4" or "Loading an Envelope in Tray 5" in the Administrator Guide.

- 1 Select [Print] from the [File] menu on the application.
- 2 Confirm [Printer Name] and click [Properties] if necessary.
- 3 Set the properties if necessary.

**Note** • You can change the print feature in [Job Type].

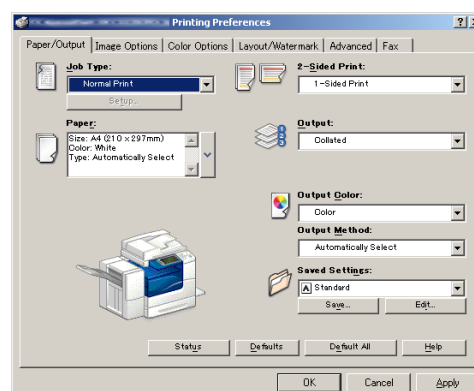

- 4 Click [OK].
- 5 Click [OK] in the [Print] dialog box.

## E-mail Printing

You can send e-mail with documents attached from a computer to the machine. The received e-mail is automatically printed from the machine according to the settings on the machine. This feature is called "E-mail Printing".

- Note**
- If the Authentication feature is enabled, received e-mails are not printed automatically.
  - The following file formats can be used: TIFF, PDF, JPEG (JFIF), XPS, XDW (DocuWorks), or XBD (DocuWorks binder).

### Setup

To use the E-mail Printing feature, the following settings are required. Check with your system administrator or network administrator whether these settings have been completed.

#### ■ E-mail Account Registration

Registering an e-mail account in advance.

#### ■ Configuration on the Machine

Configuring the required settings on the machine.

For information on E-mail Environment Settings, refer to "8 E-mail Environment Settings" in the Administrator Guide.

### Receiving E-Mail

The following describes how to receive e-mails from Outlook Express on a computer as an example.

- 1 Use your e-mail software to create an e-mail body, and then attach a document to the e-mail if necessary.

**Important**

- Only plain text is available for the e-mail body. Change the body text format to plain text on your e-mail application.

- Any forwarded e-mail (that is attached to another e-mail) cannot be printed.

**Note**

- If the extension of the attached file is other than ".tif", ".tiff", ".pdf", ".jpeg", ".jpg", ".jpe", ".jfif", ".xps", ".xdw", and ".xbd", the file may not be printed correctly.

- Up to 31 documents can be attached.

- 2 Enter the machine's e-mail address as a recipient.

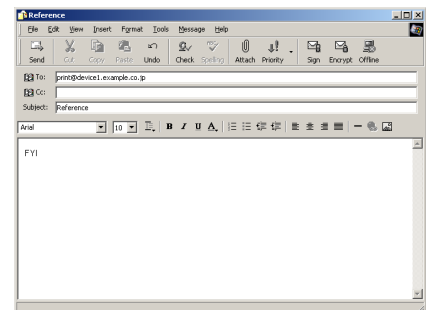

- 3 Send the e-mail.

**Note**

- The machine prints the e-mail body and the attached documents according to the following settings. The offset output setting is disabled in all cases.

- E-mail body:

Default values of the PCL print driver for this machine which is installed on the computer

- TIFF or JPEG formatted attached file:  
Default values of the logical printer set in [Memory Settings] of [TIFF/JPEG] in [Language Emulations] of CentreWare Internet Services
- PDF formatted attached file:  
Settings of PDF Direct Print when [Print Processing Mode] is set to [PDF Bridge] in PDF Direct Print.  
Default values of the logical printer configured under [Language Emulations] > [PostScript] > [Logical Printer Number] in CentreWare Internet Services when [Print Processing Mode] is set to [PS] in PDF Direct Print.

## Sending Fax

This section describes how to send a fax using the Direct Fax feature. The following procedure uses Windows XP WordPad as an example.

The Direct Fax procedure depends on the application you use. For more information, refer to the documentation provided with the application.

For more information on the Direct Fax feature, click [Help] on the print driver screen to view the print driver's help.

**Important** • The Direct Fax feature is not available when the Server Fax service is enabled.

**Note** • This feature does not appear for some models. To use the feature, an optional component is required. For more information, contact our Customer Support Center.

- 1 Select [Print] from the [File] menu on the application.
- 2 Select a fax printer from [Printer Name].
- 3 Click [Properties], and select [Fax] in [Job Type].
- 4 Click [OK].
- 5 Click [OK] in the [Print] dialog box.
- 6 Specify a destination in the [Fax Recipient] dialog box.
- 7 Click [OK].

The [Fax Job Confirmation] dialog box appears after you have sent a fax job. A list of recipients to whom the fax job is being sent will be displayed.

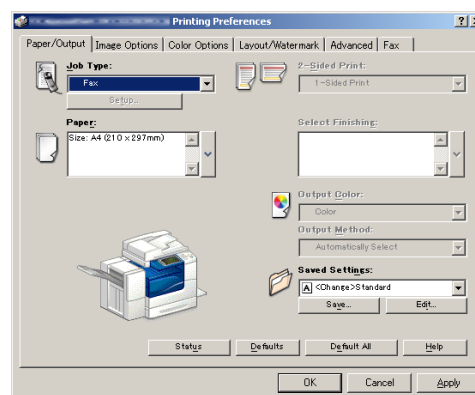

## Registering Destinations

The following describes how to register fax destinations from the machine to another machine of the same model in a single operation through a computer.

You can use the same procedure to register fax destinations from another machine of the same model to this machine.

Use CentreWare Internet Services to register fax destinations.

For information on CentreWare Internet Services, refer to "6 CentreWare Internet Services Settings" > "Configuring Machine Settings Using CentreWare Internet Services" in the Administrator Guide.

You can register fax destinations separately on the control panel. For more information, refer to "5 Tools" > "Setup" > "Add Address Book Entry" in the Administrator Guide.

**Important** • Because CentreWare Internet Services is accessible by multiple users simultaneously, the registered data will have a risk to be overwritten if a system administrator ID and passcode are not set. We recommend that data edit is permitted only by a system administrator with a passcode.

- Be sure not to perform this operation simultaneously with the address number registration from the control panel.
- If a number is duplicated, the existing number will be overwritten by the new one.
- A file in CSV format exported by CentreWare Internet Services (address book data) is not designed to be edited or changed by editing software. The data may be damaged when it is edited or changed. Due to the altered data, fax may be sent to undesired recipients. Therefore, do not edit or change the file in CSV format (address book data) with software such as Microsoft® Excel.

- Note**
- Using CentreWare Internet Services, you can import a CSV format file which is created by other than the machine to the Address Book of the machine. For more information, refer to the help of CentreWare Internet Services. This feature is not available depending on the version of the CSV format file or the model of the machine.
  - Using CentreWare Internet Services, you can download a blank form of the Address Book (CSV format file) to a computer. After completing the form on a computer, batch registration of it (a CSV format file) on the machine is available via CentreWare Internet Services. For more information, refer to the help of CentreWare Internet Services.

**1** Start up the computer, and a web browser.

**2** Enter the machine's IP address or Internet address in the browser address field, and press the <Enter> key.

- Note**
- If your network uses DNS (Domain Name System) and the machine's host name is registered in the domain name server, you can access the machine using the URL with the combination of the host name and the domain name. For example, if the host name is "myhost", and the domain name is "example.com", then the URL is "myhost.example.com".
  - Ask your system administrator for the IP address or Internet address.
  - When specifying a port number, add ":" and the port number after the address. The default port number is "80".
  - When the Authentication feature is enabled on the machine, enter a user ID and passcode in the [User Name] and [Password] fields respectively. Ask your system administrator for the user ID and passcode.
  - If communications are encrypted, you must specify an address that starts with "https" instead of "http" to access CentreWare Internet Services.

**3** Click the [Properties] tab, and select [Services] > [E-mail] > [Public Address Book] in the left frame on the screen.

**4** Click [Map Existing Address Book] in [Export Public Address Book].

**5** Click [Save] in the Security Warning dialog box.

**6** Specify the destination to save the file in.

**7** Enter the IP address or Internet address of another machine of the same model in the browser address field, and press the <Enter> key.

**8** Click the [Properties] tab, and select [Public Address Book] in the left frame on the screen.

- Note**
- Batch registration feature of the [Properties] tab is not available for the Address Book data created based on CSV file which is downloaded from the [Address Book] tab. For the Address Book data, perform batch registration on the [Address Book] tab.

**9** Click [Browse] in [Import Public Address Book] to specify the file saved in step 6.

**10** Click [Import Now].

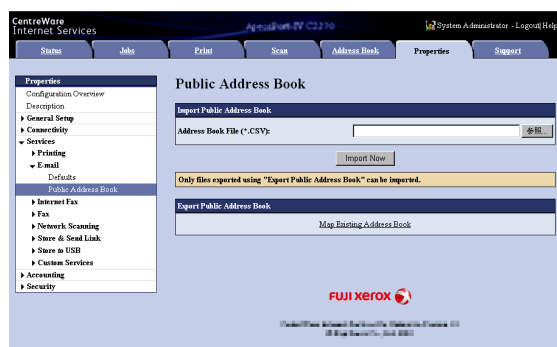

## Importing Scanned Data

This section describes how to import files from a machine's folder to your computer. The following four methods are available. The following shows the reference section for each procedure.

Importing to a TWAIN Compatible Application.....	356
Importing Using Stored File Manager 3 .....	358
Importing Using CentreWare Internet Services.....	360
Importing Using EasyOperator .....	362

### Importing to a TWAIN Compatible Application

The following describes how to import files from a machine's folder to application software.

Network Scanner Driver is used to import stored files.

Network Scanner Driver is software that allows a client-side application to import stored files (scan data) from a machine's folder via a network.

To use Network Scanner Driver, you must have Network Scanner Utility 3 installed on your computer.

**Note** • Install Network Scanner Utility 3 from the Driver CD Kit.

To import files stored in a folder, prior settings are required, such as enabling ports. For more information, refer to "9 Scanner Environment Settings" > "Configuration of Store to Folder" in the Administrator Guide. For information on the operation of the application, refer to the documentation provided with the application.

For information on how to install Network Scanner Driver, refer to the manual included in the Driver CD Kit.

To learn about fields in the displayed dialog box, click [Help] to view the Network Scanner Driver's help.

- 1 Launch application software to which files are imported.

**Important** • The application must support TWAIN. TWAIN is a standard for scanners and other input devices.

**Note** • For notes and restrictions on the use of application software, refer to the "Readme" included in Network Scanner Utility 3.

- 2 From the [File] menu, select the command for selecting the scanner (source).

- 3 Select [FX Network Scanner 3 TWAIN], and click [Select].

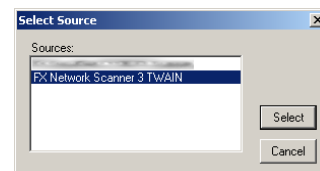

- 4 From the [File] menu, select the command for importing the image from the scanner.



**5** From the displayed list, click the scanner name of the machine, and click [Next].

- Note**
- If no scanners are shown in the list, click [Search Again]. The application searches for scanners.
  - To change the display of scanner names, use the dialog box that appears by clicking [Search/Display Settings]. For more information, refer to "Changing the display of scanner names" (P.358).
  - Only scanners on the network are automatically listed. To view a scanner on another network, click [Search/Display Settings], and register the IP Address and scanner name. For information on how to register a scanner, refer to "Changing the display of scanner names" (P.358).

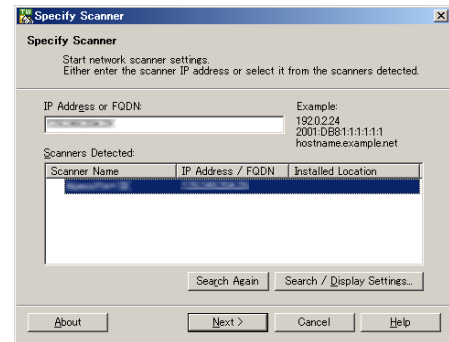

**6** In the [Folder Number] field, enter the number of the folder (001 - 200) that contains the file to be imported. In the [Passcode] field, enter a passcode (up to 20 digits).

- Note**
- You can also select a folder number from [Registered Folders].
  - Clicking [Select Scanner] returns to step 5, where you can reselect a scanner.

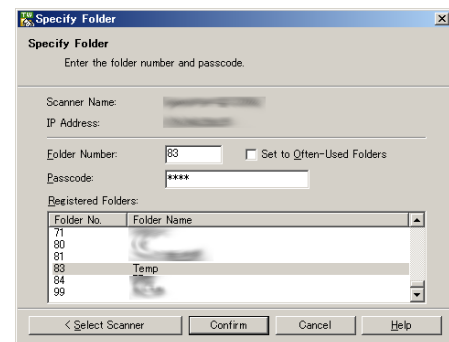

**7** Click [Confirm].

**8** Select a file to be imported from the list, and click [Import].

- Note**
- You can select multiple files.
  - [Import], [Refresh], and [Delete] are available from the menu that appears when you right-click on the list.

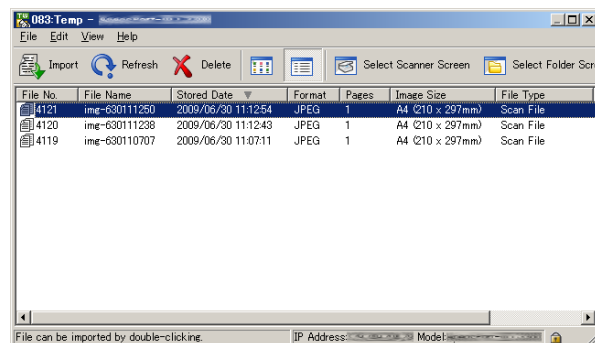

When the import starts, the scan data is forwarded from the folder to the computer.

After being forwarded, the data is loaded onto the application software and is deleted from the folder.

- Note**
- An icon is displayed next to a file that is scanned in pages and whose forwarding operation has not been completed.
  - For most applications except DocuWorks, Network Scanner Driver expands the compressed data and transfers the data to the applications in BMP format. For DocuWorks, on the other hand, Network Scanner Driver transfers the data without data expansion processing. For this reason, it does not take much time for data transfer.
  - The machine can be configured not to delete files from a folder after forwarding them. For information on the setting, refer to "5 Tools" > "Setup" > "Create Folder" in the Administrator Guide.

## Changing Network Scanner Driver Settings

To learn about fields in the displayed dialog box, click [Help] to view the Network Scanner Driver's help.

### ■ Changing the display of scanner names

You can change the display of scanner names listed.

To change the display of scanner names, use the dialog box that appears by clicking [Search/Display Settings] in the scanner selection dialog box.

Under [Scanner Name Display], you can change the method in which scanner names are displayed in [Scanner for Searching].

Specify scanners to search for under [Search Target Settings].

- Note**
- If you click [Add] and then register a scanner, you can display scanners from other networks.

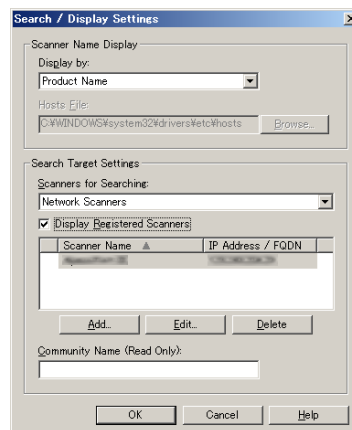

### ■ Import method for scanned files

You can change the display and the import settings for files scanned from a folder.

To change the import method, click [Import Settings] from [File] menu in the file selection dialog box, and configure the settings in the dialog box that appears.

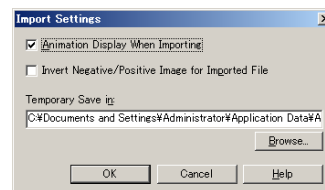

## Importing Using Stored File Manager 3

The following describes how to use Stored File Manager 3 to import files from a machine's folder.

Stored File Manager 3 is software to import files from a machine's folder to a computer without using any client-side application.

To use Stored File Manager 3, your computer must have Network Scanner Utility 3 installed.

- Note**
- Install Network Scanner Utility 3 from the Driver CD Kit.

To import files stored in a folder, prior settings are required, such as enabling ports. For more information, refer to "9 Scanner Environment Settings" > "Configuration of Store to Folder" in the Administrator Guide. For information on the operation of the application, refer to the documentation provided with the application.

For information on how to install Stored File Manager 3, refer to the manual included in the Driver CD Kit.

To learn about fields in the displayed dialog box, click [Help] to view the Stored File Manager 3 help.

- 1 Click [Start] and select [Programs] > [Fuji Xerox] > [Network Scanner Utility 3] > [Stored File Manager 3].

- Note**
- If you used another directory for installation, specify the directory instead.

2 From the displayed list, click the scanner name of the machine, and click [Next].

- Note**
- If no scanners are shown in the list, click [Search Again]. The application searches for scanners.
  - To change the display of scanner names, use the dialog box that appears by clicking [Search/Display Settings]. For more information, refer to "Changing the display of scanner names" (P.360).
  - Only when the machine is connected to the network, the scanner name is automatically listed. To view the machine connected to another network, click [Search/Display Settings] and register the IP address and scanner name. For information on how to change the settings, refer to "Changing the display of scanner names" (P.360).

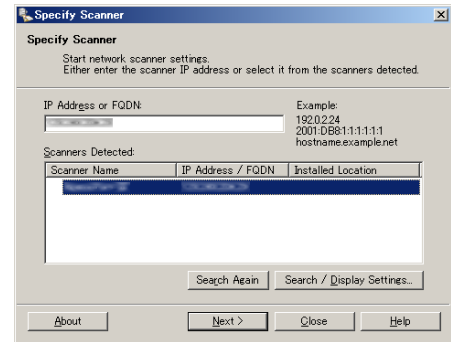

3 In the [Folder Number] field, enter the number of the folder (001 - 200) that contains the file to be imported. In the [Passcode] field, enter a passcode (up to 20 digits).

- Note**
- You can also select a folder number from [Registered Folders].
  - Clicking [Select Scanner] returns to step 2, where you can reselect a scanner.

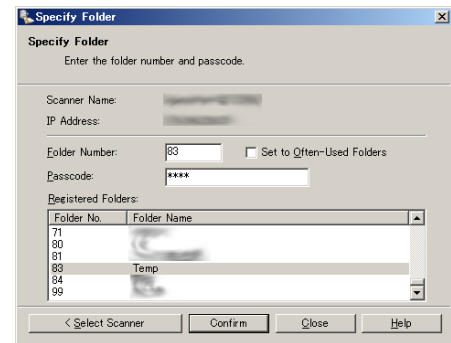

4 Click [Confirm].

5 Select a file to be imported from the list, and click [Import].

- Note**
- You can select multiple files.
  - When [File Saving Options] is set to [Set Destination for Each File] under the import settings, a dialog box for specifying a save destination is displayed. When the dialog box appears, specify a save destination, and click [OK]. For information on the import settings, refer to "Import settings for scanned files" (P.360).

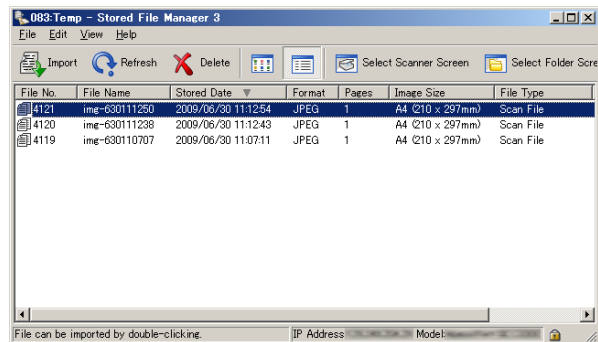

6 The file is imported to the specified directory.

- Note**
- When [File Saving Options] is set to [Save in Fixed Destination] under the import settings, a file is saved in the specified directory. For information on the import settings, refer to "Import settings for scanned files" (P.360).

## Changing Stored File Manager 3 Settings

To learn about fields in the displayed dialog box, click [Help] to view the Stored File Manager 3 help.

### ■ Changing the display of scanner names

You can change the display of scanner names listed.

To change the display of scanner names, use the dialog box that appears by clicking [Search/Display Settings] in the scanner selection dialog box.

Under [Scanner Name Display], you can change the method in which scanner names are displayed in [Scanner for Searching].

Specify scanners to search for under [Search Target Settings].

- Note**
- If click [Add] and then register a scanner, you can display scanners from other networks.

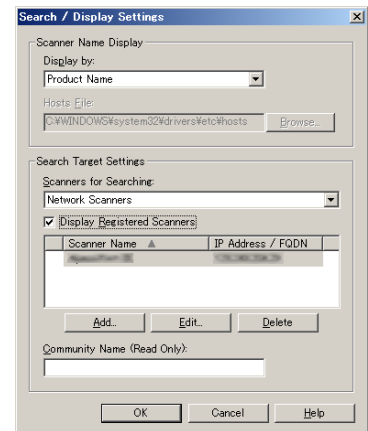

### ■ Import settings for scanned files

You can change the display and the import settings for files scanned from a folder.

To change the import method, click [Details] from [File] menu in the file selection dialog box, and configure the settings in the dialog box that appears.

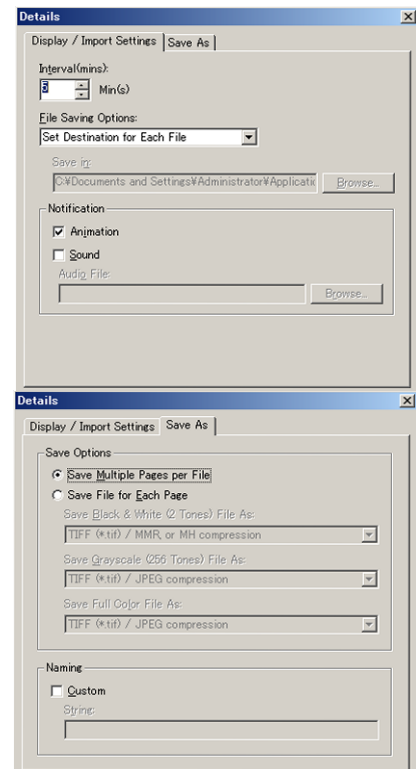

## Importing Using CentreWare Internet Services

This following describes how to import files stored in a machine's folder using CentreWare Internet Services.

When the machine is installed in a TCP/IP environment, CentreWare Internet Services allows you to import files stored in a machine's folder by accessing the machine from a computer via a web browser. You can also use a Macintosh computer to import files via a web browser.

- Note**
- You can retrieve scanned data in DocuWorks or PDF format, but cannot encrypt the DocuWorks or PDF files and cannot attach a signature to the files when retrieving them.

For information on an overview of CentreWare Internet Services, refer to "CentreWare Internet Services" (P.364).

For more information on this operation, click [Help] in the top frame to view the help.

- 1 Start up the computer, and a web browser.
- 2 Enter the machine's IP address or Internet address in the browser address field, and press the <Enter> key.

- Note**
- If your network uses DNS (Domain Name System) and the machine's host name is registered in the domain name server, you can access the machine using the Internet address with the combination of the host name and the domain name. For example, if the host name is "myhost", and the domain name is "example.com", then the Internet address is "myhost.example.com".
  - Ask your system administrator for the IP address or Internet address.
  - When specifying a port number, add ":" and the port number after the IP address or the Internet address.
  - If the authentication feature is enabled on the machine, enter a user ID and passcode in the [User Name] and [Password] fields. Ask your system administrator for the user ID and passcode.
  - If communications are encrypted, you must specify an address that starts with "https" instead of "http" to access CentreWare Internet Services.

- 3 Select [Folder] on the [Scan] tab.
- 4 Click [File List] of the folder that contains the files to be imported.

- Note**
- If a passcode is set, enter the passcode in the [Passcode] field (up to 20 digits).

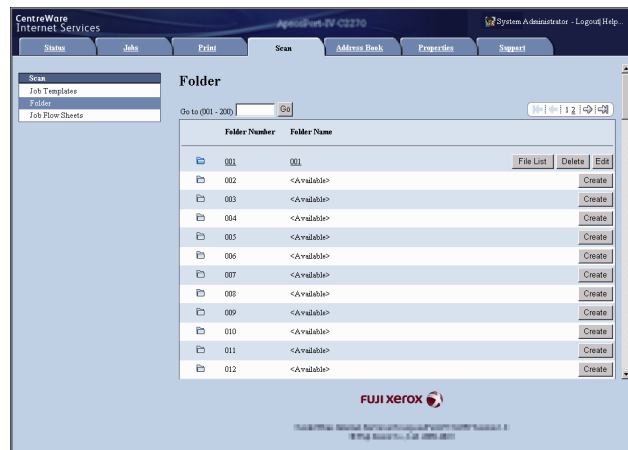

- 5 Place a check mark next to each file to be imported, set the necessary items, and then click [Retrieve].

- Note**
- When you import files in PDF format from a folder, they cannot be optimized for web view.

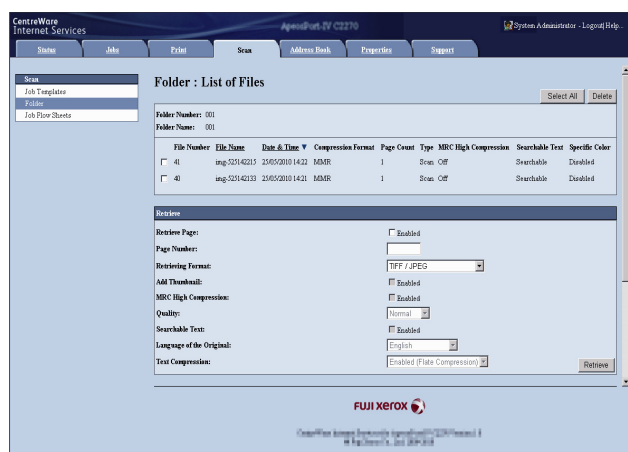

6 Click a file name and save a link.



7 Click [Save].

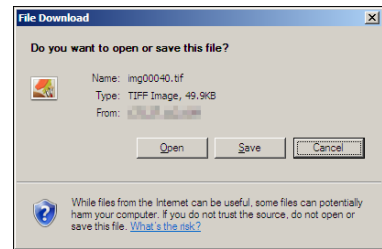

## Importing Using EasyOperator

When you use Fuji Xerox applications such as EasyOperator, you can import files stored in a machine's folder to your computer without using Network Scanner Driver. The files in a folder can also be listed or displayed in thumbnail view.

To import files stored in a folder, prior settings are required, such as enabling ports. For more information, refer to "9 Scanner Environment Settings" > "Configuration of Store to Folder" in the Administrator Guide. For information on the operation of the application, refer to the documentation provided with the application.

The following describes how to import files stored in a machine's folder by using EasyOperator as an example.

1 Click the [Start] menu, and select [Programs] > [Fuji Xerox] > [CentreWare EasyOperator] > [EasyOperator].

**Note** • If you used another directory for installation, specify the directory instead.

2 In the left frame of the window displayed, add a machine's folder to [Mailbox].

Add the folder in which files to be imported are stored. For more information on how to add a folder, refer to the EasyOperator's help.

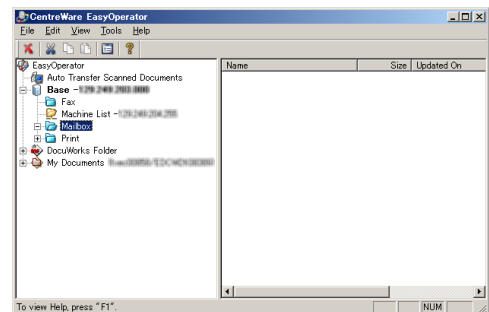

3 Select [Refresh] from the [View] menu.

- 4 Click [+] to the left of [Folder] to display the added folder.  
When you select the added folder, the file will be displayed in the right frame.

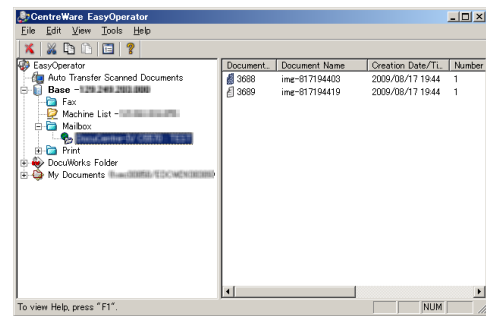

- 5 Select [Show Thumbnail] in the [View] menu to display the file in thumbnail view.
- 6 Check the thumbnails of the file to be retrieved, and select the file.

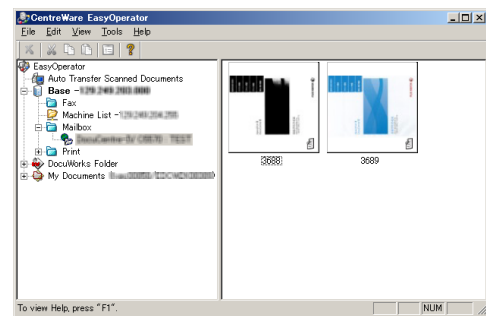

- 7 Select [Retrieve] from the [Tools] menu.
- 8 Select a save destination in the [Browse For Folder] dialog box, and click [OK].

## CentreWare Internet Services

CentreWare Internet Services requires a TCP/IP environment, and enables you to view the status of the machine and its jobs, as well as change settings via a web browser. You can also import files stored in a folder.

For information on how to import files, refer to "Importing Using CentreWare Internet Services" (P.360).

For information on the settings of CentreWare Internet Services, refer to "6 CentreWare Internet Services Settings" in the Administrator Guide.

### CentreWare Internet Services Screen

The [CentreWare Internet Services] screen consists of five frames (divided windows). The information displayed in each frame depends on the feature selected: [Status], [Jobs], [Print], [Scan], [Address Book], [Properties], or [Support].

**Note** • Clicking [Help] in the top frame displays the help for CentreWare Internet Services.

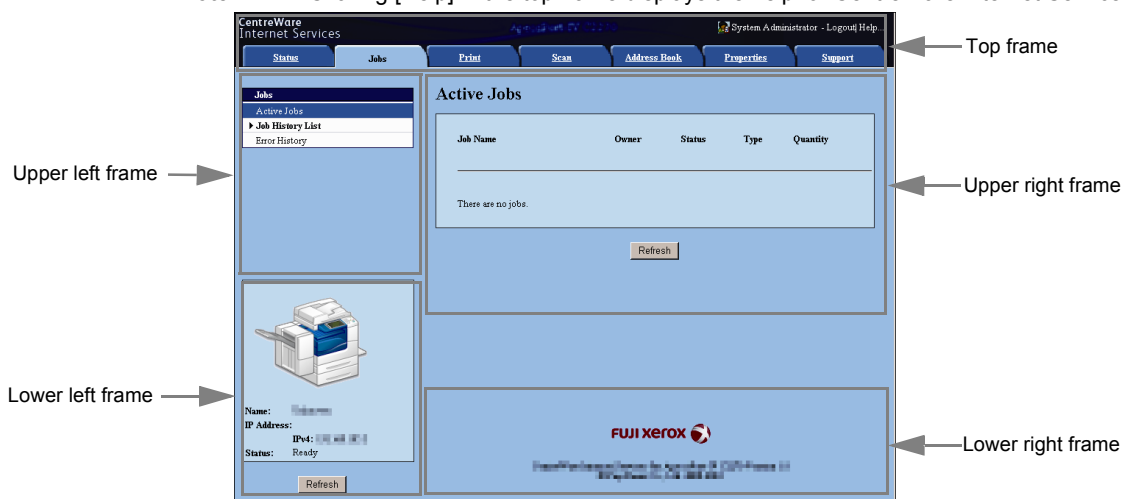

#### ■ Top Frame

Displayed at the top of the window. This frame includes the machine model name, a link to the help, user information, and tabs (links) leading to each feature.

For information on each feature provided by CentreWare Internet Services, click [Help] in this frame to view the help.

#### ■ Upper Left Frame/Upper Right Frame

Information appearing in the upper left and upper right frames changes depending on the feature. Selecting a feature displays its available features and information in these frames.

#### ■ Lower Left Frame

Displays the machine information and status, and the [Refresh] button. Clicking [Refresh] updates the information.

#### ■ Lower Right Frame

Clicking the logo opens the Fuji Xerox home page.



Main features of CentreWare Internet Services are listed below.

Tab Name	Main Features
Status	<ul style="list-style-type: none"> <li>• Displaying the machine status Displaying the status of the paper trays, output trays, and consumables such as toner cartridges.</li> <li>• Usage Counters Displays the total number of pages used for each feature and cumulative numbers.</li> <li>• Total Runtime Displays [Output Device Runtime], [Scanner Runtime], [Standby Time], [Low Power Time], [Sleep Time], [Warm-up Time], and [Power Off Time] by minutes.</li> </ul>
Jobs	<ul style="list-style-type: none"> <li>• Listing active jobs and allowing you to delete the jobs, and displaying completed jobs and error information</li> </ul>
Print	<ul style="list-style-type: none"> <li>• Job Submission Allows you to specify and print a file stored on your computer.</li> </ul>
Scan	<ul style="list-style-type: none"> <li>• Job Templates Allows you to create, edit, copy, and delete job templates.</li> <li>• Folder Allows you to create and set folders. You can also import files in a folder and print the files.</li> </ul>
Address Book	<ul style="list-style-type: none"> <li>• Allows you to add, edit, and delete recipients in the Address Book.</li> <li>• Address Book Allows you to view a list of the Address Book, delete the Address Book data, and restrict users to access to the Address Book.</li> <li>• CSV file Allows you to import a CSV file which is created by other than the machine, and download the sample CSV file and a blank CSV file.</li> </ul>
Properties	<ul style="list-style-type: none"> <li>• Displaying and setting the items such as Machine configuration, Interface, and Emulation settings.</li> </ul>
Support	<ul style="list-style-type: none"> <li>• Displaying support information</li> </ul>

- Note**
- Some field settings take effect after a reboot (after switching the power off and then on again, or after changing the System Settings from the control panel).
  - If a setting is changed by CentreWare Internet Services during operation on the control panel, the updated information does not appear on the control panel. In that case, switch the power off and then on again.
  - To change the settings of items set by the system administrator, you need to enter the user ID and passcode. Ask your system administrator for the user ID and passcode.

## Browser

CentreWare Internet Services supports the following browsers:

### ■ For Windows 7

- Microsoft Internet Explorer 8.0

### ■ For Windows Vista

- Microsoft Internet Explorer 7.0

### ■ For Windows XP

- Mozilla Firefox 3.0

- Microsoft Internet Explorer 6.0 Service Pack 2

#### ■ For Windows 2000

- Microsoft Internet Explorer 6.0 Service Pack 2

#### ■ For Mac OS X 10.6

- Safari 4
- Mozilla Firefox 3.0

#### ■ For Mac OS X 10.5

- Mozilla Firefox 3.0

#### ■ For Mac OS X 10.4

- Mozilla Firefox 3.0
- Safari 1.3

#### ■ For Mac OS X 10.3.9

- Mozilla Firefox 3.0

## Browser Settings

Before using this service, ensure the following settings on your browser.

The following describes the setting procedure for Internet Explorer 6.0 SP2.

- 1 Select [Internet Options] from the [Tools] menu.
- 2 On the [General] tab, click [Settings] for [Temporary Internet Files].
- 3 In the [Settings] dialog box, select [Every visit to the page] or [Every time you start Internet Explorer] for [Check for newer versions of stored pages:].
- 4 Click [OK].

## Proxy Server and Port Number

The following describes proxy server settings and a port number required for this service.

### ■ Proxy Server

We recommend that you access this service directly, not through a proxy server.

**Note** • If using a proxy server, specifying the machine's IP address in the browser results in slower responses, and could prevent some screens from appearing. In this case, set the machine's IP address on the browser not to use a proxy server. For information on the setting instructions, refer to the documentation provided with your browser.

### ■ Port Number

The default port number of this service is "80". The port number can be changed in [Properties] > [Connectivity] > [Protocols] > [HTTP]. Usable ports are "1" to "65535".

If you set the port to a number other than 80, you must add ":" and the port number after the IP address or the Internet address when entering the address into your browser.

For example, if the port number is 8080, the URL is:

http://[the machine's IP address]:8080/

or

http://[the machine's Internet address]:8080/

You can check the port number in a Configuration Report. For information on the Configuration Report, refer to "4 Machine Status" > "Machine Information" > "Print Reports" in the Administrator Guide.

- Note**
- If communications are encrypted, you must specify an address that starts with "https" instead of "http" to access CentreWare Internet Services.

## Starting CentreWare Internet Services

To use this service, perform the following procedure on your computer.

- 1** Start up the computer, and a web browser.
- 2** Enter the machine's IP address or Internet address in the browser address field, and press the <Enter> key.

- Note**
- If your network uses DNS (Domain Name System) and the machine's host name is registered in the domain name server, you can access the machine using the URL with the combination of the host name and the domain name. For example, if the host name is "myhost", and the domain name is "example.com", then the Internet address is "myhost.example.com".
  - Ask your system administrator for the IP address or Internet address.
  - When specifying a port number, add ":" and the port number after the IP address or the Internet address.
  - If the Authentication feature is enabled on the machine, enter a user ID and passcode in the [User Name] and [Password] fields. Ask your system administrator for the user ID and passcode.
  - If communications are encrypted, you must specify an address that starts with "https" instead of "http" to access CentreWare Internet Services.
  - If authentication of the system administrator fails, the following message is displayed in the right frame of web browser:  
"Login failed."
  - If the number of times that authentication fails exceeds the specified number, the following message is displayed in the right frame of web browser:  
"Switch the machine Off and then On for System Administrator login."



# 11 Appendix

This chapter contains a glossary of terms used in this guide.

- Glossary.....370

## Glossary

Term	Description
A3	420 x 297 mm paper
A4	297 x 210 mm paper
A5	210 x 148 mm paper
Alias	An alternative name of the machine's e-mail address. For example, when the e-mail address for the machine is ifax@mb1.abc.fujixerox.com, you can use ifax@fuji-xerox.com (alias) to reach the same location.
Auto Center	A feature that automatically moves an image to the center of paper when copying.
Auto Clear	A feature that automatically returns the touch screen to its default display when the machine is inactive for a certain period of time.
Auto Select	Based on the document loaded and the magnification selected, the machine automatically selects an appropriate paper size.
Auto Tray Switching	When paper runs out during copying, another tray of identical paper size and orientation automatically begins supplying paper.
B4	364 x 257 mm paper
B5	257 x 182 mm paper
Binding Shift	When creating a booklet, this feature adds margins to the center binding area of documents.
Book Scanning	A feature that copies the left and right pages of an unfolded document onto two separate sheets of paper.
Border Limit (Page split threshold value)	One more sheet is used when the length of the transmitted document exceeds the length of paper installed on the receiving terminal. A margin at the bottom of a received document can be eliminated so that the data can be printed on one page. The amount of space that can be removed from the bottom of a document is the border limit. When the border limit value is small, the data is printed on the next page. But when it is large, a larger space can be cut so that data can be printed on one page.
Calibration	This refers to smoothness of colors. Calibration levels are shown in gradation steps. The greater the step, the smoother the color will be.
CMS	An abbreviation of Color Management System. It corrects device-dependent color differences to match the colors printed on your output with the colors displayed on your screen.
Collate	A feature where each copy set is delivered in the same order the documents were copied.
Communication(s)	A communications network that can offer voice data (telephone), image data (fax), video data (videotex) and PC data (PC communication service) over the same channel. In this guide, it is mostly referred to as transmitting/receiving images as well as speaking with a remote user.

Term	Description
CSV File	CSV (Comma Separated Values) is a file format that is often used for saving data by spreadsheets and database programs.
Cut Paper	Standard paper sizes, such as A4 and B5.
Default Screen	A screen displayed on the touch screen immediately after switching the power on, or pressing the <Clear All> button. The screen is also displayed when the Auto Clear feature is used.
Default Value	A factory default value, or a value set in the System Administration mode.
Dial	In this guide, it refers to entering a recipient's fax number. The methods of dialing provided by the machine include: manual dialing using the numeric keypad, speed dialing, one touch dialing, and using the address book, etc.
Dial Tone	A tone generated from the telephone line. It indicates that you are connected to the line.
Dial Type	The dial type of connected line. The machine offers two dial types: Tone (push circuit) and 10PPS (dial circuit / 10PPS).
Direct Internet Fax	Allows you to send e-mail directly to the Internet Fax-compatible machines without going through the SMTP server, while Internet Fax uses the SMTP server to send e-mail.
Document Image	An image of a document scanned by the machine.
DPI	An abbreviation of Dots Per Inch. A unit used to describe printing resolution in terms of the number of dots printed in one inch. Used as a unit to describe resolution.
ECM	An abbreviation of Error Correction Mode. A type of G3 transmission. ECM transmission sends the document image data in segments and retransmits segments that the remote machine receives incorrectly. "ECM" described on the Activity Report shows that the communication was processed using ECM.
Edge Erase	A feature that erases the top/bottom, left/right or center edge of a document image when copying.
Emulation	This refers to operating the printer to achieve the same print results as when printing with other manufacturers' printers. This mode is called the Emulation Mode.
Energy Saver Feature	A feature that switches the machine status to standby after a period of inactivity. The following energy saver features can be set for the machine. Low Power Mode: The power to the fusing unit and motor is lowered when the machine is left unused for a fixed amount of time. The touch screen goes out, and the <Energy Saver> button lights up. Sleep Mode: Most of the units in the machine are in standby status. The machine consumes the least power.
Error Code	A code is displayed on the touch screen or a report when a problem occurs.

Term	Description
F Code	A transmission method defined by Communications and Information Network Association of Japan (CIAJ) for use of T.30* sub-addresses standardized by ITU-T. Between the machines with the F Code feature, including those manufactured by other companies, various features making use of F Code can be used. (*: Communication standard) With the Internet Fax feature of the machine, you can use F Code to forward fax documents received in folders by e-mail.
F4800	This refers to communicating with a remote terminal outside the country. It is also one of the Transmission Mode selections that reduces transmission speed to enable reliable communications even under poor line conditions.
Fax Gateway	Connects the Internet network to regular telephone lines, enabling e-mail documents to be sent as fax documents to regular fax machines.
G3	A facsimile communication system standardized by the advisory committee for International Telecommunications (CCITT, now the ITU-T).
Header	A record of the sender. It is printed on the top edge of a received document.
ICM	An abbreviation of Image Color Matching. A color management software used with Windows 2000, Windows XP, and Windows Server 2003. It corrects device-dependent color differences to match the colors printed on your output with the colors displayed on your screen.
Image Enhancement	A feature which makes the border between black and white smooth, with rough edges reduced, giving the appearance of a higher resolution.
Image Rotation	This feature rotates a document image by 90 degrees when the document orientation is not the same as the paper supply orientation.
Independent X - Y%	A feature that transforms a document image horizontally or vertically.
Internet	A worldwide communications network that combine miscellaneous networks.
Internet Fax	Unlike a regular fax machine, Internet Fax uses corporate networks or the Internet to send or receive e-mail (TIFF attachments).
Job Offset	This feature outputs sheets in alternating offsets to make each set easier to recognize.
Line Monitor	Allows you to audibly monitor a transmission through the speaker after dialing and until you are connected.
Low Toner Alert Tone	A tone the machine sounds when the drum/toner cartridge needs to be replaced.
Machine Ready Tone	A tone produced when the status of the machine changes from standby to ready, such as when the power is switched on.
MIME Type	Multipurpose Internet Mail Extension. A method for determining what kind of data was received by e-mail. A MIME type refers to the type of data.



Term	Description
NV Memory	A non-volatile memory, which stores the settings information of the printer even when the power is switched off.
Off-hook Dialing	Dialing with the receiver off the hook.
On-hook Dialing	Dialing with the receiver on the cradle.
Optional component	This refers to a product that is sold separately. In addition to the machine's basic configuration, various optional features are available as separately-sold optional components. (For more information on optional components, contact our Customer Support Center.)
Pages per Side	A feature that copies two or four documents onto one sheet of paper.
PCL	An abbreviation of Printer Control Language. A page description language developed by Hewlett Packard.
PJM	An abbreviation of Printer Job Language. A command language for controlling printers developed by Hewlett Packard.
Polling	A feature that allows you to retrieve a file from a remote machine.
POP3	An abbreviation of Post Office Protocol Version 3. One of the commonly used communications protocols used for receiving e-mail. It sets up a private mailbox on a provider's e-mail server, and receives messages when a communication is made. POP3 is for receiving only. SMTP is used for sending e-mail.
Print Page Buffer	The memory area where printing images are stored.
Printable Area	The actual area on paper which can be printed.
Profile	A protocol controlling image resolution, paper size, and other attributes when sending or receiving faxes using Internet Fax. The profiles that can be used vary with the Internet Fax of the remote terminal. When specifying a profile, check that it can be handled by the other party's Internet Fax-compatible machine.
RAM	An abbreviation of Random Access Memory. It is a storage device (memory) where information can be retrieved as well as stored.
Receive Buffer	The area in the machine's memory or hard disk drive. Data sent from client computers is stored in this area.
Receiving Paper Size	A feature that specifies the output paper size for received fax documents. The specified paper size will be declared to recipients from the sender.
Recipient	The person or terminal you send a document to. "Dialing" indicates the operation of entering a recipient's telephone number. For Internet Fax, this refers to the recipient's e-mail address.
Remote Terminal	A terminal with which you want to communicate. This is a general term for terminals such as telephones, facsimile machines and personal computers.

Term	Description
Resolution	Represents a fineness of detail that can be distinguished on an image. It is usually described in terms of the number of dots per square inch (dpi), and a higher value indicates a higher resolution (finely represented).
ROM	An abbreviation of Read Only Memory. It is a storage device (memory) specific for the retrieval of information.
ROS	An abbreviation of Raster Output Scanner. It is a device for writing image signals to a drum (light sensitive). A ROS is often referred to as a laser beam scanner.
Scan	Sensing or reading a paper document and converting the optical image of the document to an electronic image. The machine offers two scanning devices: document glass and document feeder.
Screen	The screen that is displayed on the touch screen. It displays messages and feature buttons.
Select	In this document, "Select" refers to highlighting a feature selection by touching the feature button on the touch screen with your finger.
Send Password	This feature requires to enter an "S" and the ID of a remote terminal after entering its fax number. This prevents transmission errors.
Sender	Originator of a communication. It is used as opposed to "recipient".
Separator	A blank, colored, or copied paper inserted between two copy sets.
SMTP	An abbreviation of Simple Mail Transfer Protocol. A communications protocol (an agreement governing the way data is transmitted) commonly used for sending and receiving e-mail.
Start Reservation	In this guide, this refers to loading a document, selecting features, and pressing the <Start> button immediately after switching the power on. Once the machine is warmed up and ready, it will automatically start copying.
Status Display Code	A code that indicates the machine status. When an error occurs on the machine, a status display code appears on the touch screen.
Store	In this guide, it is referred to as scanning an image of a document and saving the image on the machine.
Stored Programming	By registering a series of operations, the machine executes the operations with just one press of [Stored Programming] on the touch screen.
Transmission Interval	The period between transmissions.
Transparency Copy	A feature that copies on transparency films or inserts a sheet of blank or copied paper between transparency films.

Term	Description
UNC	<p>An abbreviation of Universal Naming Convention. UNC is a way to specify a path describing the location of a network resource, such as shared folders, or shared printers, on a network, Microsoft Network (SMB).</p> <p>The UNC syntax uses "\\" before the hostname, hostname and resource name are delimited by "\".</p> <p>If the hostname is "myhost", and if its host shared folder name is "sharefolder", the UNC syntax is described as follows: \\myhost\sharefolder</p>



# Index

## Symbols

(Not In Use) buttons .....	51
+ Add .....	165

## Numerics

2 Pages Up (Simple Copy) .....	72
2 Sided Book Copying .....	96
2 Sided Copying (Simple Copy) .....	71
2 Sided Scanning .....	163, 171, 240
2-Sided Print .....	349

## A

Activity Report .....	57
Add Me .....	236
adding originals .....	126
adding sender name and phone number to faxes .....	184
adding the sender's address .....	236
additional feature buttons .....	56
Address Book .....	165, 232, 254
adjusting color balance .....	90
adjusting contrast .....	88, 270
adjusting copy density/sharpness/saturation of images .....	87
adjusting fax density .....	170
adjusting scan density and image sharpness ...	269
adjusting the color tone .....	92
adjusting the copy density .....	85
adjusting the image position .....	101
Advanced Settings .....	268
attaching covers to copies .....	110
Auto Detect .....	175, 276
Auto Receive .....	213

## B

Background Suppression .....	270
Batch Print .....	297
Black & White/Color (Simple Copy) .....	71
Book Copying .....	95

Book Faxing .....	176
Book Scanning .....	274
Booklet .....	108
Booklet Creation .....	108, 349
Broadcast .....	205
Broadcast Send .....	153, 165, 209
Browse .....	255
Build Job .....	121

## C

<C (Clear)> button .....	51
Calculator % .....	77
Calibration .....	56
calling a stored program .....	313
calling a stored program for Build Job .....	314
Cancel .....	329
center output tray .....	40
CentreWare Internet Services .....	360, 364
Change Quantity .....	330
changing a stored program name .....	311
changing the orientation of images .....	105
Chapter Start .....	123
Charge Print .....	337, 350
checking completed jobs .....	331
checking the finished output of the copy .....	125
checking/selecting files in a folder .....	291
<Clear All> button .....	50
Color Balance .....	90
Color Effects .....	89
Color Scanning .....	239
Color Shift .....	92
Color Space .....	271
Combine Original Sets .....	127
combining multiple pages into one sheet .....	189
Compression Method .....	243
confirmation indicator .....	43
confirming a recipient .....	170
confirming remote machine response prior to transmission .....	203
confirming the fax job in Job Status .....	147
Constant velocity transport glass .....	43
Contrast .....	270

control board cover .....	42	editing the Internet Fax mail contents .....	187
Copies .....	94	E-mail .....	232
Copy buttons .....	51	E-mail Printing .....	350, 352
Copy Output .....	117	Encryption .....	286
copying both sides of an ID card .....	119	<Energy Saver> button .....	50
copying facing pages onto separate sheets .....	95	Energy Saver mode .....	48
copying multiple pages onto one sheet .....	111	enlarged copies .....	74
Cover Page .....	185	Enter Output Size .....	279
Covers .....	110	entering a stored program name .....	311
creating a booklet .....	108	entering an address .....	235
<b>D</b>			
<Data> indicator .....	51	entering specific symbols .....	169
Delay Start .....	182	entering text .....	58
Delayed Print .....	336, 350	entering the e-mail body .....	239, 266
Delete Outside/Delete Inside .....	128	EP port .....	42
deleting Charge Print jobs .....	339	erasing edges and margin shadows in the document .....	277
deleting Delayed Print jobs .....	337	erasing edges and margin shadows of the document .....	100
deleting outside or inside of the selected area ..	128	erasing the background color of documents .....	88, 270
deleting Private Charge Print jobs .....	341	<Error> indicator .....	51
deleting Sample Set jobs .....	335	error terminations .....	346
deleting Secure Print jobs .....	333	ethernet connector .....	42
deleting stored jobs .....	332	<b>F</b>	
deleting stored programs .....	310	F Code .....	192
density levels .....	269	Facsimile Information Services .....	199, 204, 216
<Dial Pause> button .....	51	Fax .....	164
Digital Signature .....	286	fax kit .....	43
Direct Fax .....	354	Fax Receiving Mode .....	57
Direct Printing .....	350	Fax/Internet Fax .....	164
Disable Auto Printing/Release Printer .....	56	Fax/Internet Fax Options .....	179
document feeder .....	60, 142, 222	File Format .....	242, 267
document glass .....	61, 143, 222	File Name .....	283, 285
document guides .....	43	File Name Conflict .....	285
document input tray .....	43	Finisher-AB1 .....	42
document output tray .....	43	Folder Receive .....	214
Document stopper .....	43	Forced 4800 bps .....	181
DocuWorks .....	242, 243	From .....	238
DocuWorks Security .....	245	front cover .....	40
DocuWorks Signature .....	245	fusing unit .....	41
Drum cartridges .....	40	<b>G</b>	
<b>E</b>			
Edge Erase .....	100, 277	G3 .....	181
editing a recipient .....	236		

- H**
- HDD extension kit ..... 43
- I**
- ID Card Copy ..... 119
  - Image Enhancement ..... 88, 270
  - Image Options ..... 88, 269
  - Image Rotation ..... 105
  - Image Shift ..... 101
  - importing scanned data ..... 356
  - Independent X - Y% ..... 76
  - Index Print ..... 324
  - inner cover ..... 40, 43
  - inserting blank sheets between transparencies 116
  - Internet Fax ..... 164
  - Internet Fax Message ..... 187
  - Internet Fax Profile ..... 196
  - Internet Fax Subject ..... 187
  - Internet Fax transmission ..... 154
  - <Interrupt> button ..... 50
  - Invert Image ..... 104
- J**
- Job Assembly ..... 121
  - Job Status ..... 328
  - <Job Status> button ..... 50
  - job template ..... 251
  - JPEG ..... 242, 243
- K**
- knob ..... 42
- L**
- Language ..... 56
  - Language of the Original ..... 246
  - Last Original ..... 329
  - Layout Adjustment ..... 93, 174, 273
  - left cover ..... 43
  - left tray ..... 42
  - lever ..... 43
  - license ..... 31
- Lighten/Darken ..... 85, 88, 170
  - Lighten/Darken (Simple Copy) ..... 72
  - loading documents ..... 222
  - Lock Out Printer ..... 56
  - <Log In/Out> button ..... 50
  - login information field ..... 54
  - Login Name ..... 286
  - Low Power mode ..... 48
- M**
- machine components ..... 40
  - <Machine Status> button ..... 50
  - <Main Power> indicator ..... 51
  - main power switch ..... 41
  - making 2-sided copies of facing pages ..... 96
  - making enlarged copies spread over multiple sheets ..... 112
  - making enlarged/reduced copies ..... 74
  - making multiple copies on a single sheet ..... 115
  - making multiple copies on one sheet ..... 114
  - making reversed copies of images ..... 104
  - Manual Receive ..... 213
  - Manual Send ..... 203
  - Media Print ..... 316
  - Media Print - Photos ..... 323
  - Media Print - Text ..... 324
  - Message ..... 239, 266
  - message field ..... 54
  - Meta Data ..... 287
  - Mirror Image ..... 104
  - Mixed Size Originals ..... 99, 175, 276
  - More Options ..... 199
  - Multiple sheet inserter (MSI) ..... 41
- N**
- Negative Image ..... 104
  - Network Scanner Driver ..... 358
  - Network Scanning ..... 251
  - New Recipient ..... 235
  - Next Original ..... 329
  - non-standard size document ..... 98
  - Non-target Area Color ..... 84
  - numeric keypad ..... 51

**O**

one tray module .....	40
On-hook .....	203
Optimize For Quick Web View .....	245
Original Orientation .....	72, 94, 99, 101, 102, 105, 112, 279
Original Size .....	98, 174, 275
Original Type .....	86, 162, 172, 241
Originals .....	94
Output Color .....	80
Output Format .....	107

**P**

Pages Per Sheet (N-Up) .....	349
Pages per Side .....	111, 189
Paper Supply .....	78
Paper Supply (Simple Copy) .....	69
Paper thickness lever .....	41
Password .....	258, 286
PDF .....	242, 243
PDF Security .....	244
PDF Signature .....	244
Photo .....	242
Photo & Text .....	241
Photographs .....	268
Poster .....	112, 349
power connector for Finisher AB .....	43
Power connector for main unit .....	43
power switch .....	41
Preset Repeat Image .....	115
print driver .....	351
Print Mode .....	57
Printing .....	296
printing .....	351
printing Charge Print jobs .....	339
printing Delayed Print jobs .....	337
printing files in a folder .....	296
printing multiple sets at the remote machine .....	188
printing pending jobs preferentially .....	345
printing Private Charge Print jobs .....	342
printing Sample Set jobs .....	336
printing Secure Print jobs .....	334
printing stored jobs .....	332

Priority Send .....	182
Private Charge Print .....	340, 350
processing documents scanned with different settings as one job .....	121
Promote Job .....	329
Proportional % .....	75, 279
Public Folder .....	342

**Q**

Quality/File Size .....	282
-------------------------	-----

**R**

Read Receipts .....	282
receiver .....	203
Recipient Print Sets .....	188
Recipient(s) .....	236
Reduce/Enlarge .....	74, 177, 279
Reduce/Enlarge (Simple Copy) .....	70
reduced copies .....	74
registering stored programs .....	308
Release Printer .....	56
Remote Folder .....	189
Remote Polling .....	199
removing a recipient .....	170
Repeat Image .....	114
Reply To .....	284
reset button .....	43
Resolution .....	162, 172, 273
retrieving files from remote machines .....	199
Review buttons .....	51
right hand cover .....	40
Right Hand Cover Handle .....	41
RSA BSAFE .....	31

**S**

Sample Job .....	125
Sample Set .....	334, 349
Saturation .....	88
Save in .....	257
saving the scanned data .....	228
scan density .....	269
Scan To .....	266
Scan to Home .....	251



- Scan to PC ..... 253
- scanning a color photograph ..... 268
- scanning both sides of a document ..... 240
- scanning different size documents
- simultaneously ..... 99, 175, 276
- scanning facing pages on separate sheets ..... 176, 274
- Screen Brightness ..... 56
- Searchable Text ..... 243
- Secure Print ..... 332, 349
- Segment Separators ..... 124
- selecting a communication mode ..... 181
- selecting a file format for output data ..... 242, 267
- selecting a folder ..... 291, 292
- selecting a transfer protocol ..... 253
- selecting an image quality ..... 89
- selecting an output color ..... 239
- selecting files ..... 319, 321
- selecting Internet Fax/Fax ..... 164
- selecting the color for copying ..... 80
- selecting the document type ..... 86, 162, 172, 241
- selecting the paper for copying ..... 77
- selecting the printing options ..... 323
- sending e-mail encrypted by S/MIME ..... 286
- sending e-mail with a digital signature
- by S/MIME ..... 286
- Sending faxes to multiple recipients ..... 165
- sending in sections ..... 283
- sending Internet Fax with a digital signature by S/MIME ..... 198
- Server ..... 256
- service buttons ..... 54
- <Services Home> button ..... 50
- [Services Home] screen ..... 54
- setting the action to be taken for file name conflict ..... 285
- setting the sender's address ..... 238
- setting the subject ..... 238, 266
- Setup ..... 56
- Shadow Suppression ..... 270
- Shared Name ..... 257
- sharpness ..... 88, 269
- Sideways Images ..... 241
- Simple Copy ..... 69
- Single File for Each Page ..... 244
- Sleep mode ..... 48
- Source Color ..... 83
- specifying a destination PC by browsing your network ..... 255
- specifying a destination PC using
- the address book ..... 254
- specifying a destination PC using the screen keyboard ..... 256
- specifying a destination using
- an address number ..... 167
- specifying a destination using
- the address book ..... 165
- Specifying a destination
- using the numeric keypad ..... 160
- specifying a name for the file to be saved ..... 285
- specifying a name for the file to be sent ..... 283
- specifying a reply address ..... 284
- specifying a scan ratio ..... 177
- specifying a scan size ..... 275
- specifying a scanning ratio ..... 279
- specifying a scanning resolution ..... 273
- specifying an e-mail address ..... 232
- specifying an image compression ratio
- when scanning ..... 281
- specifying destination using the
- keyboard screen ..... 168
- specifying destinations ..... 145
- specifying finishing options ..... 117
- specifying Internet Fax profiles ..... 196
- specifying read receipts ..... 282
- specifying send priority ..... 182
- specifying send time ..... 182
- specifying the color space ..... 271
- specifying the Internet Fax subject ..... 187
- specifying the orientation
- of the loaded documents ..... 72, 104, 279
- specifying the scan size for the document ..... 98
- specifying the scan size for the original ..... 174
- specifying the scanning resolution ..... 162, 172
- <Speed Dial> button ..... 51
- Speed Dialing ..... 167
- Split Send ..... 283
- Standard Size ..... 175, 276
- standard tray ..... 40
- stapler cartridge ..... 42
- stapling ..... 118
- <Start> button ..... 50

Starting Rate .....	181
<Stop> button .....	50
stopping a copy job .....	66
stopping a fax job .....	149
stopping a scan job .....	229
Store & Send Link .....	265
Store for Polling .....	202
Store in Remote Folder .....	350
Store to Folder .....	259
Store to USB .....	261
Stored File Manager 3 .....	228, 358
storing files on the machine that a remote machine can retrieve .....	202
Subject .....	238, 266
suppressing the document background .....	270

## T

Target Area Color .....	83
test button .....	43
Text .....	241
Text Compression .....	246
TIFF .....	242, 243
TIFF/JPEG Auto Select .....	242, 243
TIFF-F .....	197
TIFF-J .....	197
TIFF-S .....	197
Toner Cartridges .....	40
touch screen .....	50
Transfer Protocol .....	253
transfer roller .....	41
Transmission Header Text .....	184
transmitting 2-sided originals .....	163, 171
transmitting documents with a cover page .....	185
Transparency Options .....	116
Transparency Separators .....	349
two tray module .....	40

## U

Undelivered Faxes .....	343
Upright Images .....	241
USB connector (device) .....	42
USB connector (host) .....	42
User Name .....	257
using F Code transmission .....	192

using remote folder .....	189
---------------------------	-----

## V

Variable Size .....	276
---------------------	-----

## W

waste toner bottle .....	40
Watermark .....	349

## X

XPS .....	243
XPS Signature .....	245

**DocuPrint CM505 da  
User Guide**

Fuji Xerox Co., Ltd.

ME5079E2-1 (Edition 1)

December 2010

Copyright © 2010 by Fuji Xerox Co., Ltd.

## Free Manuals Download Website

<http://myh66.com>

<http://usermanuals.us>

<http://www.somanuals.com>

<http://www.4manuals.cc>

<http://www.manual-lib.com>

<http://www.404manual.com>

<http://www.luxmanual.com>

<http://aubethermostatmanual.com>

Golf course search by state

<http://golfingnear.com>

Email search by domain

<http://emailbydomain.com>

Auto manuals search

<http://auto.somanuals.com>

TV manuals search

<http://tv.somanuals.com>