

DocuPrint CP205 / CP205 w



User Guide

Contents

Preface	5
Trademarks and Document Disclaimer	6
Types of Manuals	7
Using This Guide	8
Organization	9
Conventions	10
Safety Notes	11
Electrical Safety	12
Machine Installation	14
Operational Safety	16
Consumable	18
Warning and Caution Labels	19
Environment	20
Regulation	21
Radio Frequency Emissions (Class B)	21
Product Safety Certification (CB)	21
Illegal Copies and Printouts	22
Product Features	23
1 Specifications	25
2 Basic Operation	29
Main Components	30
Front View	31
Rear View	32
Operator Panel	33
Turning On the Printer	34
Printing a Panel Settings Page	35
The Operator Panel	36
The Printer Setting Utility	37
Power Saver Mode	38
Exiting the Power Saver Mode	39
3 Printer Management Software	41
Print Driver	42
CentreWare Internet Services	43
Creating an Administrative Password	44
Printer Setting Utility (Windows Only)	45
SimpleMonitor (Windows Only)	46
Launcher (Windows Only)	47
User Setup Disk Creating Tool (Windows Only)	48

4	Network Basics	49
	Overview of Network Setup and Configuration.....	50
	Connecting Your Printer	51
	Connecting Printer to Computer or Network.....	52
	Setting the IP Address.....	55
	TCP/IP and IP Addresses.....	56
	Automatically Setting the Printer's IP Address	57
	Dynamic Methods of Setting the Printer's IP Address	58
	Assigning an IP Address (for IPv4 Mode).....	59
	Verifying the IP Settings	62
	Printing and Checking the Printer Settings Page.....	63
	Installing Print Driver on Computers Running Windows.....	64
	Identifying Print Driver Pre-install Status (for Network Connection Setup).....	65
	Inserting the Software Pack CD-ROM	67
	USB Connection Setup.....	68
	Network Connection Setup.....	69
	Configuring Wireless Settings (DocuPrint CP205 w Only)	70
	Setting Up for Shared Printing	95
	Installing Print Driver on Computers Running Mac OS X.....	103
	Installing the Driver	104
5	Printing Basics	111
	About Print Media	112
	Print Media Usage Guidelines	113
	Print Media That Can Damage Your Printer	114
	Print Media Storage Guidelines	115
	Supported Print Media.....	116
	Usable Print Media	117
	Loading Print Media.....	122
	Capacity.....	123
	Print Media Dimensions.....	124
	Loading Print Media in the Multipurpose Feeder (MPF)	125
	Loading Print Media in the Priority Sheet Inserter (PSI).....	134
	Manual Duplex Printing (Windows Print Driver Only)	140
	Using the Output Tray Extension.....	144
	Printing	145
	Sending a Job to Print	146
	Canceling a Print Job.....	147
	Selecting Printing Options	148
	Printing Custom Size Paper.....	153
	Checking Status of Print Data.....	155
	Printing a Report Page	156
	Printer Settings	157
	Printing with Web Services on Devices (WSD)	159
	Adding Roles of Print Services	160

	Printer Setup.....	161
6	Using the Operator Panel Menus	163
	Understanding the Printer Menus.....	164
	Information Pgs.....	165
	Billing Meters	166
	Admin Menu.....	167
	Panel Lock Function.....	179
	Enabling the Panel Lock.....	180
	Disabling the Panel Lock.....	181
	Setting the PowerSaver Time Option	182
	Resetting to Factory Defaults	183
7	Troubleshooting	185
	Clearing Jams.....	186
	Avoiding Jams	187
	Identifying the Location of Paper Jams.....	188
	Clearing Paper Jams From the Front of the Printer.....	189
	Clearing Paper Jams From the Back of the Printer	190
	Clearing Paper Jams From the Center Output Tray.....	192
	Jam Problems.....	194
	Basic Printer Problems.....	195
	Display Problems.....	196
	Printing Problems	197
	Print Quality Problems.....	199
	The Output Is Too Light.....	200
	Toner Smears or Print Comes Off/Stain on Back Side.....	201
	Random Spots/Blurred Images.....	202
	The Entire Output Is Blank.....	203
	Streaks Appear on the Output	204
	Pitched Color Dots.....	205
	Vertical Blanks	206
	Mottle	207
	Ghosting	208
	Fog.....	209
	Bead-Carry-Out (BCO)	210
	Auger Mark	211
	Wrinkled/Stained Paper.....	212
	The Top Margin Is Incorrect.....	213
	Color Registration Is out of Alignment	214
	Protrudent/Bumpy Paper	215
	Adjusting Color Registration	216
	Performing Auto Correct.....	217
	Printing the Color Registration Chart.....	218
	Determining Values	219

Entering Values	220
Noise	222
Other Problems	223
Understanding Printer Messages	224
Contacting Service	228
Getting Help.....	229
LCD Panel Messages	230
SimpleMonitor Alerts.....	231
Obtaining the Product Information	232
Non Genuine Toner Mode.....	233
The Operator Panel	234
The Printer Setting Utility	235
8 Maintenance	237
Cleaning the Printer.....	238
Cleaning Inside the Printer	239
Cleaning the Color Toner Density (CTD) Sensor	242
Replacing Toner Cartridges.....	243
Overview	244
Removing the Toner Cartridges.....	245
Installing a Toner Cartridge	246
Ordering Supplies.....	248
Consumables.....	249
When to Order Toner Cartridges	250
Recycling Supplies	251
Storing Consumables	252
Managing the Printer	253
Checking or Managing the Printer with CentreWare Internet Services	
254	
Checking Printer Status with SimpleMonitor (Windows Only)	255
Checking Printer Status Through E-mail	256
Conserving Supplies.....	259
Checking Page Counts.....	260
Moving the Printer	261
Contacting Fuji Xerox	265
Technical Support.....	266
Online Services	267

Preface

Thank you for purchasing the DocuPrint CP205/CP205 w.

This guide is intended for users who use the printer for the first time, and provides all the necessary operating information about the printer function.

Please read this guide to achieve the best performance from this printer.

This guide assumes you are familiar with computers and the basics of network operation and configuration.

After reading this guide, keep it safe and handy for future reference.

DocuPrint CP205/CP205 w User Guide Help

Copyright© 2010 by Fuji Xerox Co., Ltd.

Fuji Xerox Co., Ltd.

October 2010 (Edition 1)

No. ME5047E2-1

Trademarks and Document Disclaimer

Apple®, Bonjour®, ColorSync®, Macintosh®, and Mac OS® are trademarks of Apple Inc. in the United States and/or other countries.

Microsoft®, Windows Vista®, Windows®, and Windows Server® are trademarks of Microsoft Corporation in the United States and/or other countries.

All product/brand names are trademarks or registered trademarks of the respective holders.

In this manual, safety instructions are preceded by the symbol . Always read and follow the instructions before performing the required procedures.

It may be a legal offence to print currency notes, certificates of stocks and securities, or any other documents of similar nature, regardless of whether they will be used.

Fuji Xerox is not responsible for any breakdown of machines due to infection of computer virus or computer hacking.

IMPORTANT:

1. This manual is copyrighted with all rights reserved. Under the copyright laws, this manual may not be copied or modified in whole or part, without the written consent of the publisher.
2. Parts of this manual are subject to change without prior notice.
3. We welcome any comments on ambiguities, errors, omissions, or missing pages.
4. Never attempt any procedure on the machine that is not specifically described in this manual. Unauthorized operation can cause faults or accidents. Fuji Xerox is not liable for any problems resulting from unauthorized operation of the equipment.
5. Decompiling this manual is prohibited.

An export of this product is strictly controlled in accordance with Laws concerning Foreign Exchange and Foreign Trade of Japan and/or the export control regulations of the United States.

XEROX, the sphere of connectivity design, and DocuPrint are trademarks or registered trademarks of Xerox Corporation in the U.S. or Fuji Xerox Co., Ltd.

DocuWorks is a trademark of Fuji Xerox Co., Ltd.

All Xerox and Fuji Xerox product names are either registered trademarks or trademarks of Xerox Corporation or Fuji Xerox Co., Ltd.

Types of Manuals

Safety Guide	Describes the information you need to know before using the printer and to operate the printer safely.
Setup Guide	Provides step-by-step instructions on how to set up your printer.
User Guide (HTML files) (this guide)	Describes how to get ready to print and set various features. It also covers the operator panel menus, troubleshooting tips, and maintenance information. This guide is on the <i>Software Pack CD-ROM</i> .
Operator Panel Guide	Describes the icons assigned to the buttons or indicators on the operator panel.

Using This Guide

This section includes:

- ["Organization" on page 9](#)
- ["Conventions" on page 10](#)

■ Organization

This guide is organized into the following chapters. The summary of each chapter is as follows:

1 Specifications	Describes the printer specifications.
2 Basic Operation	Describes the main components of the printer, the power saver mode, and how to turn on the printer.
3 Printer Management Software	Describes the software available for the printer.
4 Network Basics	Describes the basic information about how to connect the printer to your computer via the network or USB and how to install the print driver.
5 Printing Basics	Describes the supported paper, how to load paper, and how to print data using various print features.
6 Using the Operator Panel Menus	Describes the setting items available on the operator panel, and their setup procedures.
7 Troubleshooting	Describes the troubleshooting tips for printer problems such as paper jams.
8 Maintenance	Describes how to clean the printer, how to replace toner cartridges, and how to see the printer status.
9 Contacting Fuji Xerox	Describes support information.

■ Conventions

1 In this guide, personal computers and workstations are collectively called “computers”.

2 The following terms are used throughout this guide:

IMPORTANT:

- Important information that must be read and followed.



NOTE:



- Additional information that merits emphasis.

See also:

- References within this guide.

3 Orientation of documents or paper is described in this guide as follows:

 , Long Edge Feed (LEF): Loading the document or paper in portrait orientation.

 , Short Edge Feed (SEF): Loading the document or paper in landscape orientation.

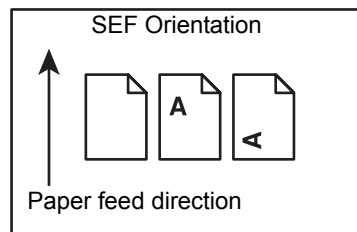
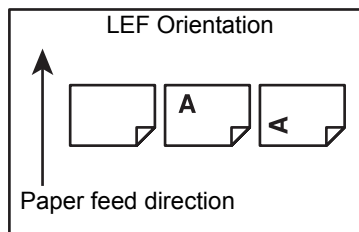

Safety Notes

























































Before using this product, read “Safety Notes” carefully for safety use.

This product and recommended supplies have been tested and found to comply with strict safety requirements including safety agency approvals and compliance with environmental standards. Follow the following instructions for safety use.

 **WARNING:**

- Any unauthorized alteration including an addition of new functions or connection to external devices may not be covered by the product warranty. Contact your local Fuji Xerox representative for more information.

Follow all warning instructions marked on this product. The warning marks stand for the followings:

 DANGER	Used for item that if not followed strictly, can lead death or severe or fatal injuries and the possibility to do it is comparatively high.														
 WARNING	Used for items that if not followed strictly, can lead to severe or fatal injuries.														
 CAUTION	Used for items that if not followed strictly, can cause injuries to user or damages to machine.														
<p>: A symbol for items to pay attention to when handling machine. Follow instructions carefully to use machine safely.</p>															
<table border="0"> <tr> <td></td> <td></td> <td></td> <td></td> <td></td> <td></td> <td></td> </tr> <tr> <td>Caution</td> <td>Flammable</td> <td>Explodable</td> <td>Electric shock</td> <td>Heated surface</td> <td>Moving object</td> <td>Pinched fingers</td> </tr> </table>									Caution	Flammable	Explodable	Electric shock	Heated surface	Moving object	Pinched fingers
															
Caution	Flammable	Explodable	Electric shock	Heated surface	Moving object	Pinched fingers									
<p>: A symbol for prohibited items. Follow instructions carefully to avoid any dangerous acts.</p>															
<table border="0"> <tr> <td></td> <td></td> <td></td> <td></td> <td></td> <td></td> <td></td> </tr> <tr> <td>Prohibited</td> <td>No fire</td> <td>Do not touch</td> <td>Do not use in bathroom</td> <td>Do not tear down</td> <td>Keep away from wet</td> <td>Never touch with wet hand</td> </tr> </table>									Prohibited	No fire	Do not touch	Do not use in bathroom	Do not tear down	Keep away from wet	Never touch with wet hand
															
Prohibited	No fire	Do not touch	Do not use in bathroom	Do not tear down	Keep away from wet	Never touch with wet hand									
<p>: A symbol for items that must be performed. Follow instructions carefully to carry out these essential tasks.</p>															
<table border="0"> <tr> <td></td> <td></td> <td></td> </tr> <tr> <td>Instructions</td> <td>Unplug</td> <td>Ground/Earth</td> </tr> </table>					Instructions	Unplug	Ground/Earth								
															
Instructions	Unplug	Ground/Earth													

■ Electrical Safety

WARNING

This product shall be operated by the power source as indicated on the product's data plate. Consult your local power company to check if your power source meets the requirements.



WARNING:

- **Connect this product to a protective earth circuit.**

This product is supplied with a plug that has a protective earth pin. The plug fits only into an earthed electrical outlet. This is a safety feature. If the plug doesn't fit to the outlet, contact an electrician to replace the outlet to avoid risk of electric shock. Never use an earthed adapter plug to connect the product to the electrical outlet that has no earth connection terminal.

Improper connection of a grounding conductor may cause electric shock.



Plug the power cord directly into a grounded electrical outlet. To prevent overheat and a fire accident, do not use an extension cord, a multi-plug adaptor or a multiple connector. Consult your local Fuji Xerox representative to check if an outlet is grounded.



Connect this product to a branch circuit or an outlet that has larger capacity than the rated ampere and voltage of this product. See the data plate on the rear panel of this product for its rated ampere and voltage.



Never touch the power cord with wet hands. It may cause electric shock.



Do not place an object on the power cord.



Always keep the plug connection free of dust. The dusty and damp environment may bring about minute electric current in a connector. It may generate heat and eventually cause a fire accident.



To avoid the risk of electric shock and a fire accident, only use the power cord supplied with this product or the ones designated by Fuji Xerox.

The power cord is exclusive use for this product. Do not use it for any other product.

Do not damage or alter the power cord. Damage and alteration may generate heat and eventually cause electric shock or a fire accident.

If the power cord is damaged or insulated wires are exposed, contact your local Fuji Xerox representative for its replacement. Do not use a damaged or uninsulated cord to avoid the risk of electric shock and a fire accident.

CAUTION



When cleaning this product, always switch off and unplug it. Access to a live machine interior may cause electric shock.



Do not unplug or re-plug this product with the switch on. Plugging and unplugging a live connector may deform the plug and generate heat, and eventually cause a fire accident.



Hold the plug not the cord when unplugging this product, or it may damage the cord and cause electric shock or a fire accident.



Always switch off and unplug the machine when it is not used over weekends or long holidays. It may cause deterioration of insulations and eventually electric shock or a fire accident.



Once a month, switch off this product and check if

- the power cord is plugged firmly into an electrical outlet;
- the plug is not excessively heated, rusted or bent;
- the plug and electrical outlet are free of dust; and
- the power cord is not cracked or worn down.

Once you notice any unusual condition, switch off and unplug this product first and contact your local Fuji Xerox representative.

■ Machine Installation

⚠ WARNING



Do not locate this product where people might step on or trip over the power cord. Friction or excessive pressure may generate heat and eventually cause electric shock or a fire accident.

⚠ CAUTION



Never locate this product in the following places:

- Near radiators or any other heat sources
- Near volatile flammable materials such as curtains
- In the hot, humid, dusty or poorly ventilated environment
- In the place receiving direct sunlight
- Near cookers or humidifiers



Locate this product on a level and sturdy surface that can withstand a weight of 10.55 Kg. Otherwise, if tilted, the product may fall over and cause injuries.



Locate this product in a well-ventilated area. Do not obstruct ventilation openings of the product.

Keep the minimum clearance as follows for ventilation and an access to the power plug. Unplug the product if an abnormal condition is noted.

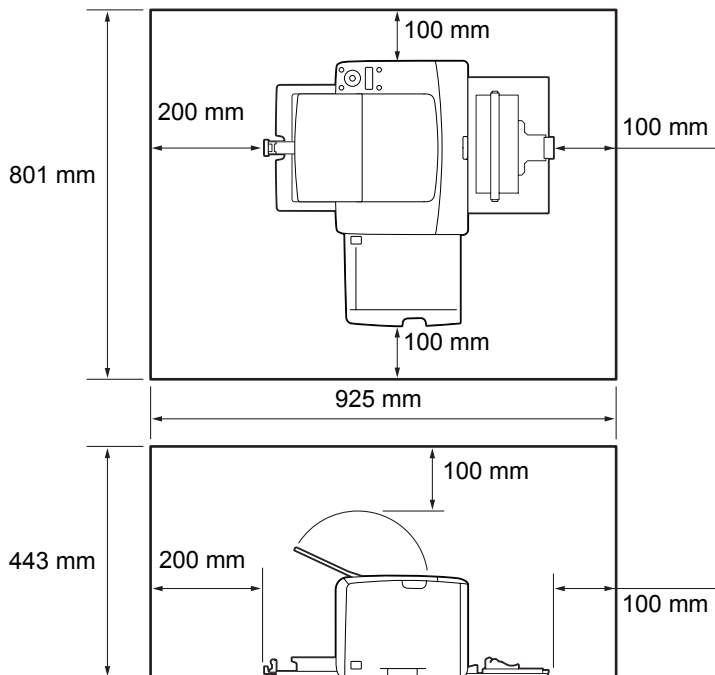



Do not incline the product at more than 10 degree angle. Otherwise, it may fall over and cause injuries.

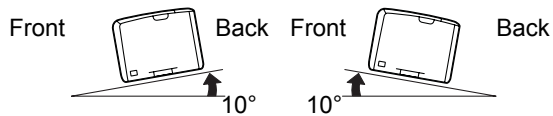
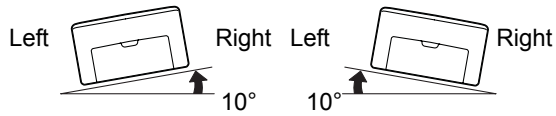

To bundle wires and cables, always use the cable ties and spiral tubes that Fuji Xerox supplies. Otherwise, it may cause some defects.

Others



To keep this product in a good performance and condition, always use it in the following environment:

- Temperature: 10 – 32 °C
- Humidity: 10 – 85%

When the product is left in a chilly room and the room is rapidly warmed up by heater, dew condensation may form inside the product and cause a partial deletion on printing.

■ Operational Safety

WARNING



The operator's product maintenance procedures are described in the customer documentation supplied with this product. Do not carry out any other maintenance procedures not described in the documentation.



This product features safety design not to allow operators access to hazard areas. The hazard areas are isolated from operators by covers or protectors which require a tool to remove. To prevent electric shock and injuries, never remove those covers and protectors.



To avoid the risk of electric shock and a fire accident, switch off and unplug the product promptly in the following conditions, then contact your local Fuji Xerox representative.

- The product emits smoke or its surface is unusually hot.
- The product emits unusual noise or odor.
- The power cord is cracked or worn down.
- A circuit breaker, fuse or any other safety device is activated.
- Any liquid is spilled into the product.
- The product is soaked in water.
- Any part of the product is damaged.



Do not insert any object into slots or openings of this product.
Do not place any of the followings on the product:

- Liquid container such as flower vases or coffee cups
- Metal parts such as staples or clips
- Heavy objects

If liquid is spilled over or metal parts are slipped into the product, it may cause electric shock or a fire accident.



Do not use conductive paper such as origami paper, carbonic paper or conductively-coated paper. When paper jam occurs, it may cause short-circuit and eventually a fire accident.



When cleaning this product, use the designated cleaning materials exclusive to it. Other cleaning materials may result in poor performance of the product. Never use aerosol cleaners, or it may catch fire and cause explosion.



Never play the CD-ROM supplied with the product on an audio player. Always use a CD-ROM player. Otherwise, large sound may damage audio players or your ears.

CAUTION



Always follow all warning instructions marked on or supplied with this product.

To avoid the risk of burn injuries and electric shock, never touch the area with the "High Temperature" or "High Voltage" marks on.



Keep electrical and mechanical safety interlocks active. Keep the safety interlocks away from magnetic materials. Magnetic materials may accidentally activate the product and cause injuries or electric shock.



Do not attempt to remove a paper jammed deeply inside the product, particularly a paper wrapped around a Fusing Unit or a heat roller. Otherwise, it may cause injuries or burns. Switch off the product promptly and contact your local Fuji Xerox representative.



Ventilate well during extended operation or mass copying. It may affect the office air environment due to odor such as ozone in a poorly ventilated room.

Provide proper ventilation to ensure the comfortable and safe environment.

■ Consumable

WARNING



Store all consumables in accordance with the instructions given on its package or container.



Use a broom or a wet cloth to wipe off spilled toner. Never use a vacuum cleaner for the spills. It may catch fire by electric sparks inside the vacuum cleaner and cause explosion. If you spill a large volume of toner, contact your local Fuji Xerox representative.



Never throw a toner cartridge into an open flame. Remaining toner in the cartridge may catch fire and cause burn injuries or explosion.

If you have a used toner cartridge no longer needed, contact your local Fuji Xerox representative for its disposal.

CAUTION



Keep toner cartridges out of the reach of children. If a child accidentally swallows toner, spit it out, rinse mouth with water, drink water and consult a physician immediately.



When replacing toner cartridges, be careful not to spill the toner. In case of any toner spills, avoid contact with clothes, skin, eyes and mouth as well as inhalation.



If toner spills onto your skin or clothing, wash it off with soap and water.

If you get toner particles in your eyes, wash it out with plenty of water for at least 15 minutes until irritation is gone. Consult a physician if necessary.

If you inhale toner particles, move to a fresh air location and rinse your mouth with water.

If you swallow toner, spit it out, rinse your mouth with water, drink plenty of water and consult a physician immediately.

■ Warning and Caution Labels

Always follow all warning instructions marked on or supplied with this product.

To avoid the risk of burn injuries and electric shock, never touch the area with the "High Temperature" or "High Voltage" marks on.

FUJI XEROX 

To ensure optimum quality and performance of your printer, we recommend only using genuine Fuji Xerox toner. Not for sale in Japan.

 

PRODUCT CODE: XXXXXXXX
[TYPE- xxx]

BLACK
黒色

 **K**

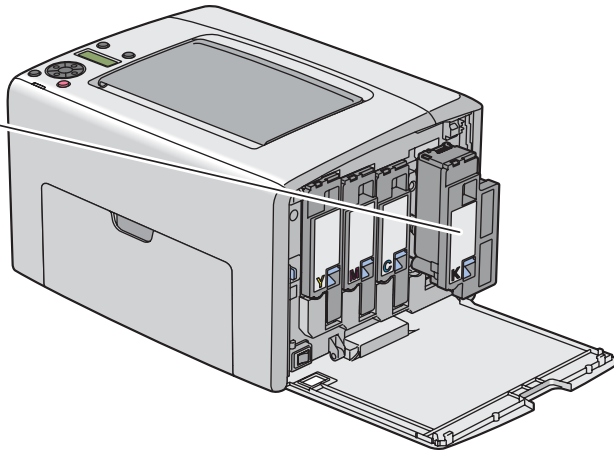

 **CAUTION 注意**
주의 ข้อควรระวัง

 **155°C**
311°F  **00:40⁰⁰** 

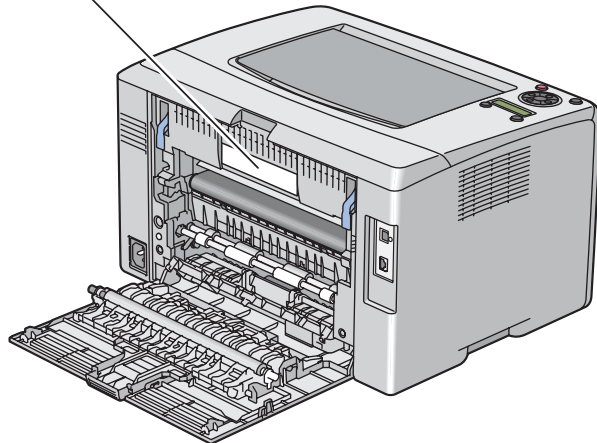

Environment

- For environmental protection and efficient use of resources, Fuji Xerox reuses returned toner cartridges to make recycle parts, recycle materials or energy recovery.
- Proper disposal is required for toner cartridges no longer needed. Do not open toner cartridges containers. Return them to your local Fuji Xerox representative.

Regulation

■ Radio Frequency Emissions (Class B)



This product has been tested and found to comply with the limits for a Class B digital device, pursuant to the International Standard for Electromagnetic Interference (CISPR Publ. 22) and Radiocommunications Act 1992 in Australia/New Zealand. These limits are designed to provide reasonable protection against harmful interference in a residential installation. This product generates, uses and can radiate radio frequency energy and, if not installed and used in accordance with the instructions, may cause harmful interference to radio communications. However, there is no guarantee that interference will not occur in a particular installation. If this product does cause harmful interference to radio or television reception, which can be determined by turning this product off and on, the user is encouraged to try to correct the interference by one or more of the following measures:

- Reorient or relocate the receiving antenna.
- Increase the separation between this product and the receiver.
- Connect this product into an outlet on a circuit different from that to which the receiver is connected.
- Consult the dealer or an experienced radio/TV technician for help.

Changes and modifications to this product not specifically approved by Fuji Xerox may void the user's authority to operate this product.

■ Product Safety Certification (CB)

This product is certified by the following agency using the safety standards listed.

Agency	Standard
TUV-Rh	IEC60950-1:ed. 2

Illegal Copies and Printouts

Copying or printing certain documents may be illegal in your country. Penalties of fines or imprisonment may be imposed on those found guilty. The following are examples of items that may be illegal to copy or print in your country.

- Currency
- Banknotes and checks
- Bank and government bonds and securities
- Passports and identification cards
- Copyright material or trademarks without the consent of the owner
- Postage stamps and other negotiable instruments

This list is not inclusive and no liability is assumed for either its completeness or accuracy. In case of doubt, contact your legal counsel.

Product Features

This chapter describes the product features and indicates their links.

2 Sided Print (Manual)

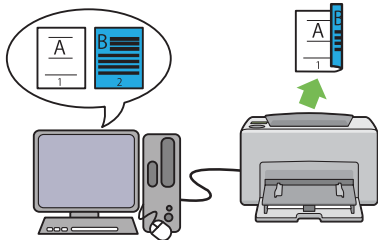

2 Sided Print is to print two or more pages on the front and back sides of a single sheet of paper manually. This feature allows you to reduce the paper consumption.

For more information, see ["Manual Duplex Printing \(Windows Print Driver Only\)"](#) on page 140.

Printing Through Wireless Connection (Wireless Print) (DocuPrint CP205 w Only)

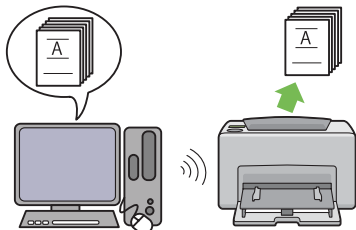

The Wireless LAN feature on your printer allows you to install the printer at any location, and enables printing without a wired connection to your computer.

The Wireless LAN feature is unavailable depending on the region you purchased.

For more information, see ["Configuring Wireless Settings \(DocuPrint CP205 w Only\)"](#) on page 70.

Multiple-Up Print

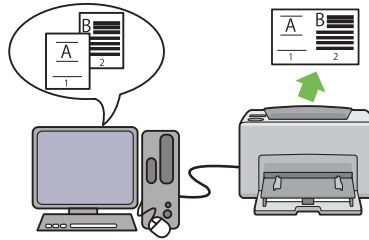

Multiple-Up enables you to print multiple pages on a single sheet of paper. This feature allows you to reduce the paper consumption.

For more information, see the print driver's Help.

Priority Sheet Inserter (PSI)

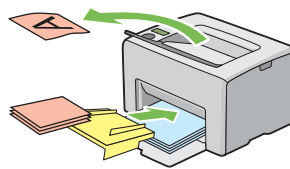





Print media loaded on the PSI is given precedence over those loaded on the multipurpose feeder (MPF). Using the PSI allows you to use other types or sizes of print media preferentially over the regular print media loaded on the MPF.

For more information, see ["Loading Print Media in the Priority Sheet Inserter \(PSI\)"](#) on page 134.

Specifications

This chapter lists the main specifications of the printer. Note that the specifications of the product may change without prior notice.

Items	Description
Product Code	DocuPrint CP205 220V: TL300597 DocuPrint CP205 220V CHINA: TL300596 DocuPrint CP205 110V: TL300598 DocuPrint CP205 w 220V: TL300599
Type	Desktop
Printing method	LED Xerography IMPORTANT: <ul style="list-style-type: none"> LED + LED electrophotographic system
Fusing system	Thermal fusing system using a belt
Warm-up Time	Less than 25 seconds (after powering on at 22 °C temperature)
Continuous print speed ^{*1}	A4  : When plain paper fed is from the multipurpose feeder Color 1 Sided ^{*2} : 12 sheets/min Monochrome 1 Sided: 15 sheets/min IMPORTANT: *1 Print speed may decrease due to factors such as paper type, paper size, and printing conditions. *2 When continuously printing a single document of A4  .
First print	Color 27 seconds (A4  /Fed from the multipurpose feeder) Monochrome 22 seconds (A4  /Fed from the multipurpose feeder) IMPORTANT: <ul style="list-style-type: none"> Measurements based on Fuji Xerox test pattern. Time from printer startup until output of the first page is complete. Except the time when the printer controller receives or processes the print data.
Resolution	Data Processing Resolution: 600 × 600 dpi Output Resolution: 1200 × 2400 dpi
Tone/Color	256 tones/color (16.7 million colors)

Items	Description
Paper Size	<p>Multipurpose feeder: A4, B5, A5, Legal (8.5 × 14"), Folio (8.5 × 13"), Letter (8.5 × 11"), Executive, #10 Env, Monarch, DL, C5, Postcard (100 × 148 mm), Postcard (148 × 200 mm), Yougata 2, Yougata 3, Yougata 4, Younaga 3, Nagagata 3, Custom Size (Width: 76.2 – 215.9 mm, Length: 127 – 355.6 mm)</p> <p>Priority sheet inserter: A4, B5, A5, Legal (8.5 × 14"), Folio (8.5 × 13"), Letter (8.5 × 11"), Executive, #10 Env, Monarch, DL, C5, Postcard (148 × 200 mm), Yougata 4, Younaga 3, Nagagata 3, Custom Size (Width: 98.4 – 215.9 mm, Length: 190.5 – 355.6 mm)</p> <p>Image loss: 4.1 mm from the top, bottom, left, and right edges</p>
Paper Type	<p>Plain, Bond, Lightweight Cardstock, Japanese Glossy Cardstock, Lightweight Glossy Cardstock, Recycled, Labels, Envelope, Postcard, Letterhead, Pre-Printed, Hole Punched, Colored, Special, Custom Type</p> <p>IMPORTANT:</p> <ul style="list-style-type: none"> • Fuji Xerox P paper (64 gsm) • Use only the recommended paper. Using paper other than that recommended for the printer can cause printing problems. Do not use special ink jet paper. • Note that poor printing quality due to paper-related printing problems can occur when using the printer in an environment that is dry, cold, or very humid. • Printing over the printed side or on the reverse side of paper that already has been printed on can result in poor print quality. • When printing on envelopes, use envelopes that do not have adhesive applied. • The type of paper being used and environmental conditions can affect printing quality. Because of this, it is recommended that you test print and confirm proper print quality before using the printer.
Paper capacity	<p>Standard: Multipurpose feeder: 150 sheets; Priority sheet inserter: 10 sheets</p> <p>IMPORTANT:</p> <ul style="list-style-type: none"> • Fuji Xerox P paper (64 gsm)
Output tray capacity	<p>Standard: approximately 100 sheets (face down)</p> <p>IMPORTANT:</p> <ul style="list-style-type: none"> • Fuji Xerox P paper (64 gsm)
2-sided Printing Feature	Standard (Manual)
CPU	ARM9 384MHz
Memory capacity	<p>Standard: 128 MB (Onboard)</p> <p>IMPORTANT:</p> <ul style="list-style-type: none"> • The above memory capacity does not guarantee print quality depending on the type and content of print data.
Hard disk	—
Page Description Language	— (Host-based)

Items	Description
Supported OS ^{*1}	<p>Windows® XP, Windows® XP x64 Edition, Windows Vista®, Windows Vista® x64 Edition, Windows Server® 2003, Windows Server® 2003 x64 Edition, Windows Server® 2008, Windows Server® 2008 x64 Edition, Windows Server® 2008 R2 x64 Edition, Windows® 7, Windows® 7 x64 Edition, Mac OS®^{*2}</p> <p>IMPORTANT:</p> <p>*1 For the latest information about the supported operating systems, contact our Customer Support Center or your dealer. *2 Mac OS® X 10.3.9 – 10.6 are supported.</p>
Interface	<p>DocuPrint CP205:</p> <p>Standard: USB 1.1/2.0 (Hi-Speed), Ethernet (10Base-T, 100Base-TX)</p> <p>DocuPrint CP205 w:</p> <p>Standard: USB 1.1/2.0 (Hi-Speed), Ethernet (10Base-T, 100Base-TX), IEEE802.11b/g/n</p>
Supported protocol	TCP/IP (LPR, Port9100, WSD, HTTP, SMTP, RARP, AutoIP), SNMP, DHCP, BOOTP, Bonjour (mDNS)
Power	<p>AC 100 – 127 V ± 10%; 10.5 A; both 50/60 Hz ± 3 Hz AC 220 – 240 V ± 10%; 4.5 A; both 50/60 Hz ± 3 Hz</p> <p>IMPORTANT:</p> <ul style="list-style-type: none"> Power outlets that provide the above power level is recommended. Maximum machine measured current: 7.0 A (AC 100 – 127 V)/4.0 A (AC 220 – 240 V)
Operating noise (main unit only)	<p>During operation:</p> <p>Color: 6.35 B; 48 dB (A) Monochrome: 6.35 B; 49 dB (A)</p> <p>During stand-by: 4.3 B; 21 dB (A)</p> <p>IMPORTANT:</p> <ul style="list-style-type: none"> Measurements based on ISO7779 Unit B: acoustic power level (LwAd) Unit dB (A): radiated sound pressure (bystander position)
Power consumption	<p>Maximum: 340 W, During Mode 2 of Power Saver Mode: 7 W or less</p> <p>Average:</p> <p>During standby: 69 W, During continuous color printing: 340 W, During continuous monochrome printing: 340 W</p> <p>IMPORTANT:</p> <ul style="list-style-type: none"> Mode 1 of Power Saver Mode: 14 W average (The printer does not use electricity when the power is switched off even with the power cord is plugged in.)
Dimensions (main unit only)	<p>394 (W) × 300 (D)^{*1} × 225 (H) mm</p> <p>IMPORTANT:</p> <p>^{*1} When the front cover is closed.</p>

Items	Description
Weight	Main Unit: 10.55 kg (main unit only, including toner cartridges)
Usage Environment	<p data-bbox="540 198 1249 256">During Use: Temperature: 10 – 32 °C; Humidity: 10 – 85% (except malfunctions due to dew condensation)</p> <p data-bbox="540 266 1215 324">Non-Use: Temperature: -10 – 40 °C; Humidity: 5 – 85% (except malfunctions due to dew condensation)</p> <p data-bbox="540 343 705 372">IMPORTANT:</p> <ul data-bbox="550 382 1263 465" style="list-style-type: none"> <li data-bbox="550 382 1263 465">• Until the conditions (temperature and humidity) inside the printer become acclimated to the installation environment, certain qualities of the paper can cause poor printing.

Basic Operation

This chapter includes:

- ["Main Components" on page 30](#)
- ["Turning On the Printer" on page 34](#)
- ["Printing a Panel Settings Page" on page 35](#)
- ["Power Saver Mode" on page 38](#)

Main Components

This section provides an overview of your DocuPrint CP205/CP205 w.

This section includes:

- ["Front View" on page 31](#)
- ["Rear View" on page 32](#)
- ["Operator Panel" on page 33](#)

■ Front View

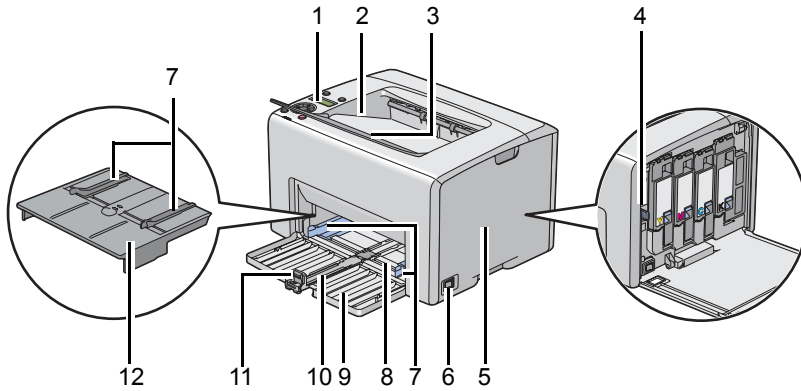

1	Operator Panel	2	Center Output Tray
3	Output Tray Extension	4	Print Head Cleaning Rod
5	Toner Access Cover	6	Power Switch
7	Paper Width Guides	8	Multipurpose feeder (MPF)
9	Front Cover	10	Slide Bar
11	Length Guide	12	Priority Sheet Inserter (PSI)

■ Rear View

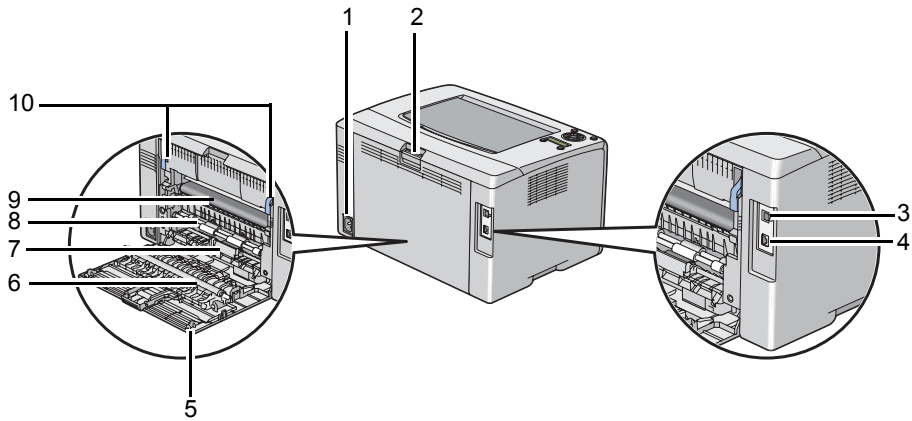







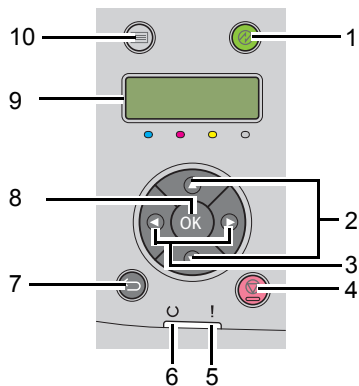



1	Power Connector	2	Rear Cover Handle
3	USB Port	4	Ethernet Port
5	Rear Door	6	Transfer Roller
7	Paper Chute	8	Paper Feed Roller
9	Transfer Belt	10	Levers

■ Operator Panel

The operator panel has a liquid crystal display (LCD), buttons, and indicators.



- 1  **(Energy Saver)** Button/Indicator
 - Lights up in the Mode 2 for the Power Saver Mode. Press this button to exit the Power Saver Mode.
- 2   Buttons
 - Scrolls through menus or items in the Menu mode. To enter numbers or passwords, press these buttons.
- 3   Buttons
 - Selects submenus or setting values in the Menu mode.
- 4  **(Cancel Job)** Button
 - Cancels the current print job.
- 5  **(Error)** Indicator
 - Lights up when an error occurs and blinks when an unrecoverable error occurs.
- 6  **(Ready)** Indicator
 - Lights up when the printer is ready or the printer is in the Mode 1 for the Power Saver Mode and blinks when data is being received.
- 7  **(Back)** Button
 - Switches to the print mode from the top menu of the Menu mode.
 - Returns to the upper hierarchy of the menu from the submenu of the Menu mode.
- 8  **OK** Button
 - Displays the selected menu or item and determines the selected value in the Menu mode.
- 9 LCD Panel
 - Displays various settings, instructions, and error messages.
- 10  **(Menu)** Button
 - Moves to the top menu.

Turning On the Printer

IMPORTANT:

- Do not use extension cords or power strips.
- The printer should not be connected to an uninterruptible power supply (UPS) system.

- 1 Connect the power cord to the power connector on the rear of your printer (see ["Rear View" on page 32](#)).

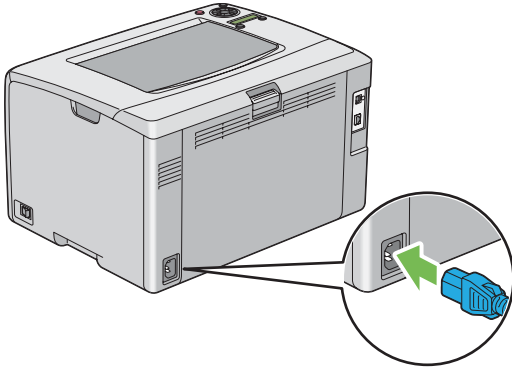

- 2 Connect the other end of the cord to the power source.
- 3 Turn on the printer.

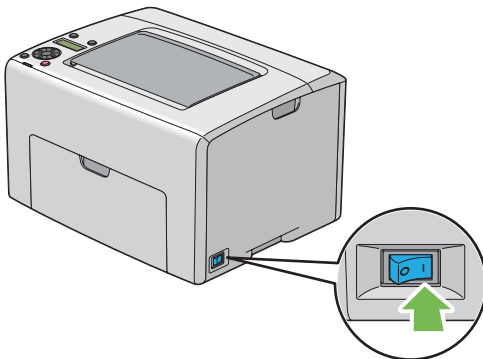



Printing a Panel Settings Page

The Panel Settings page shows current settings for the operator panel menus.

This section includes:

- ["The Operator Panel" on page 36](#)
- ["The Printer Setting Utility" on page 37](#)

■ The Operator Panel

- 1 Press the  (**Menu**) button.
- 2 Select `Information Pgs`, and then press the  button.
- 3 Select `Panel Settings`, and then press the  button.
The Panel Settings page is printed.

■ The Printer Setting Utility

The following procedure uses Microsoft® Windows® XP as an example.

- 1 Click **start** → **All Programs** → **Fuji Xerox** → **Fuji Xerox Printer Software for Asia-Pacific** → **FX DocuPrint CP205/FX DocuPrint CP205 w** → **Printer Setting Utility**.

NOTE:

- The **Select Printer** window appears in this step, when multiple print drivers are installed on your computer. In this case, click the name of the desired printer listed in **Printer Name**.

The Printer Setting Utility appears.

- 2 Click the **Printer Settings Report** tab.
- 3 Select **Information Pages** from the list at the left side of the page.
The **Information Pages** page is displayed.
- 4 Click the **Panel Settings** button.
The Panel Settings page is printed.

Power Saver Mode

The printer has a power saving feature which reduces power consumption during periods of inactivity. This feature operates in two modes: the Mode 1 and Mode 2. The power consumption of the printer in Mode 2 is lower than in Mode 1. As delivered, the printer switches to the Mode 1 five minutes after the last print job is printed. The printer then switches to the Mode 2 after another six minutes of inactivity. When the printer is in the Mode 1, the display shows *Ready/Standby*. In the Mode 2, all lamps on the operator panel except for the  (**Energy Saver**) button go out. The display also goes blank and displays nothing.

The factory default settings of five minutes (Mode 1) and six minutes (Mode 2) are changeable within the range of 5 to 30 minutes (Mode 1) and 1 to 6 minutes (Mode 2). The printer returns to the ready-to-print state in about 25 seconds when re-activated.



See also:

- ["Setting the PowerSaver Time Option" on page 182](#)

■ Exiting the Power Saver Mode

The printer automatically exits the Power Saver Mode when it receives a print job from a computer. To manually exit the Mode 1, press any button on the operator panel. To exit the Mode 2, press the  (**Energy Saver**) button.

NOTE:

- Opening and closing the rear door will cause the printer to exit the Mode 1.
- When the printer is in the Mode 2, all buttons on the operator panel except for the  (**Energy Saver**) button do not function. To use the buttons on the operator panel, press the  (**Energy Saver**) button to exit the Power Saver Mode.

See also:

- ["Setting the PowerSaver Time Option" on page 182](#)

Printer Management Software

Use the *Software Pack CD-ROM* that shipped with your printer to install a combination of software programs, depending on your operating system.

This chapter includes:

- ["Print Driver" on page 42](#)
- ["CentreWare Internet Services" on page 43](#)
- ["Printer Setting Utility \(Windows Only\)" on page 45](#)
- ["SimpleMonitor \(Windows Only\)" on page 46](#)
- ["Launcher \(Windows Only\)" on page 47](#)
- ["User Setup Disk Creating Tool \(Windows Only\)" on page 48](#)

Print Driver

To access all of your printer's features, install the print driver from the *Software Pack CD-ROM*.

The Print driver enables your computer and printer to communicate and provides access to your printer features.

See also:

- ["Installing Print Driver on Computers Running Windows" on page 64](#)
- ["Installing Print Driver on Computers Running Mac OS X" on page 103](#)

CentreWare Internet Services

This section provides information on CentreWare Internet Services, a hyper text transfer protocol (HTTP)-based web page service that is installed with your print driver and is accessed through your web browser.

These pages give you instant access to printer status, and printer configuration options. Anyone on your network can access the printer using their web browser software. In administrative mode you can change the configuration of the printer, and manage your printer settings without leaving your computer.

NOTE:

- Users who are not given passwords by the administrator can still view the configuration settings and options in user mode. They will not be able to save or apply any changes to the current configuration.

■ Creating an Administrative Password

- 1 Launch your web browser.
- 2 Enter the IP address of the printer in the address bar, and then press the **Enter** key.
- 3 Click the **Properties** tab.
- 4 In the left navigation panel, scroll down to **Security** and select **Administrator Settings**.
- 5 Select **Enabled** for **Administrator Mode**.
- 6 In the **Administrator Login ID** field, enter a name for the administrator.
NOTE:
 - The default ID and password are “11111” and “x-admin” respectively.
- 7 In the **Administrator Password** and **Re-enter Password** fields, enter a password for the administrator.
- 8 In the **Maximum Login Attempts** field, enter the number of login attempts allowed.
- 9 Click **Apply**. Your new password has been set and anyone with the administrator name and password can log in and change the printer configuration and settings.

Printer Setting Utility (Windows Only)

The Printer Setting Utility allows you to view or specify the system settings. You can also diagnose the system settings by using the Printer Setting Utility.

The Printer Setting Utility consists of the **Printer Settings Report**, **Printer Maintenance**, and **Diagnosis** tabs.

The Printer Setting Utility is installed with your Fuji Xerox print driver.

NOTE:

- The **Password** dialog box appears the first time you try to change settings on Printer Setting Utility when Panel Lock is set on the printer. In this case, enter the password you specified, and click **OK** to apply the settings.

SimpleMonitor (Windows Only)

You can check the printer status with SimpleMonitor. Double-click the SimpleMonitor printer icon on the taskbar at the bottom right of the screen. The **Select Printer** window appears, which displays the printer name, printer connection ports, and printer status. Check the column **Status** to know the current status of your printer.

Status Settings button: Displays the **Status Settings** screen and allows you to modify the SimpleMonitor settings.

Click the name of the desired printer listed on the **Select Printer** window. The **Status Monitor** window appears.

The **Status Monitor** window alerts you when there is a warning or when an error occurs, for example, when a paper jam occurs or toner is running low.

By default, the **Status Monitor** window launches automatically when printing starts. You can specify the conditions for starting the **Status Monitor** window in **Auto start setup**.

To change the pop-up settings for the **Status Monitor** window:

The following procedure uses Microsoft® Windows® XP as an example.

- 1 Click **start** → **All Programs** → **Fuji Xerox** → **SimpleMonitor for Asia-Pacific** → **Activate SimpleMonitor**.
The **Select Printer** window appears.
- 2 Click **Status Settings**.
The **Status Settings** dialog box appears.
- 3 Select the **Pop-up Settings** tab, and then select the type of the pop-up from **Auto start setup**.

You can also check the toner level of your printer and the job information on the **Status Monitor** window.

The SimpleMonitor is installed with your Fuji Xerox print driver.

Launcher (Windows Only)

Using the **Launcher** window, you can open the **Status Window**, **Printer Setting Utility**, and **Troubleshooting**.

To use the **Launcher**, select to install the **Launcher** when you install the Fuji Xerox print driver.

The following procedure uses Windows XP as an example.

To open the **Launcher** window:

- 1 Click **start** → **All Programs** → **Fuji Xerox** → **Fuji Xerox Printer Software for Asia-Pacific** → **Launcher**.

The **Launcher** dialog box appears.

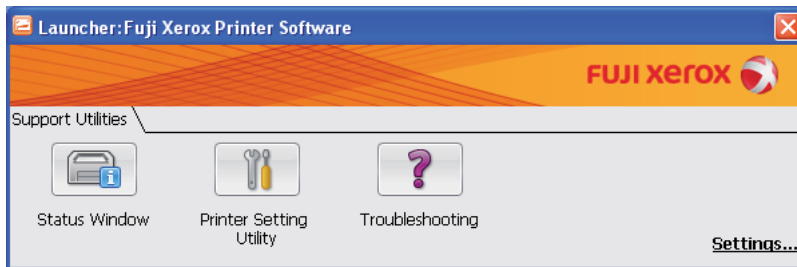

- 2 The **Launcher** window provides three buttons; **Status Window**, **Printer Setting Utility**, and **Troubleshooting**.

To exit, click the **X** button at the top-right of the window.

For details, click the **Help** button/icon of each application.

Status Window	Click to open the Status Monitor window. See also: <ul style="list-style-type: none">• "SimpleMonitor (Windows Only)" on page 46
Printer Setting Utility	Click to open the Printer Setting Utility. See also: <ul style="list-style-type: none">• "Printer Setting Utility (Windows Only)" on page 45
Troubleshooting	Click to open the Troubleshooting guide, which allows you to resolve issues by yourself.

User Setup Disk Creating Tool (Windows Only)

The User Setup Disk Creating Tool program located in the **MakeDisk** folder of the **Utilities** folder on the *Software Pack CD-ROM* and the print driver located on the *Software Pack CD-ROM* are used to create driver installation packages that contain custom driver settings. A driver installation package can contain a group of saved print driver settings and other data for things such as:

- Print orientation and Multiple-UP (document settings)
- Watermarks

If you want to install the print driver with the same settings on multiple computers running on the same operating system, create a setup disk in a floppy disk or in a server on the network. Using the setup disk that you have created will reduce the amount of work required when installing the print driver.

- Install the DocuPrint CP205/CP205 w print driver in the computer on which the setup disk is to be created.
- The setup disk can only be used on the operating system on which the disk was created or computers running the same operating system. Create a separate setup disk for each of the operating systems.

Network Basics

This chapter includes:

- ["Overview of Network Setup and Configuration" on page 50](#)
- ["Connecting Your Printer" on page 51](#)
- ["Setting the IP Address" on page 55](#)
- ["Installing Print Driver on Computers Running Windows" on page 64](#)
- ["Installing Print Driver on Computers Running Mac OS X" on page 103](#)

Overview of Network Setup and Configuration

To set up and configure the network:

- 1 Connect the printer to the network using the recommended hardware and cables.
- 2 Turn on the printer and the computer.
- 3 Print the Printer Settings page and keep it for referencing network settings.
- 4 Install the driver software on the computer from the *Software Pack CD-ROM*. For information on driver installation, see the section in this chapter for the specific operating system you are using.
- 5 Configure the printer's TCP/IP address, which is required to identify the printer on the network.
 - Microsoft® Windows® operating systems: Run the Installer on the *Software Pack CD-ROM* to automatically set the printer's Internet Protocol (IP) address if you connect the printer to an established TCP/IP network. You can also manually set the printer's IP address on the operator panel.
 - Mac OS® X systems: Manually set the printer's TCP/IP address on the operator panel.
- 6 Print a Printer Settings page to verify the new settings.

NOTE:

- If the *Software Pack CD-ROM* is not available, you can download the latest driver from the Fuji Xerox Web Site: <http://www.fujixeroxprinters.com/>

See also:

- "Printing a Printer Settings Page" on page 156

Connecting Your Printer

Your DocuPrint CP205/CP205 w interconnection cables must meet the following requirements:

Connection Type	Connection Specifications
Ethernet	10 Base-T/100 Base-TX compatible
USB	USB 1.1/2.0 compatible
Wireless (DocuPrint CP205 w only)	IEEE 802.11b/802.11g/802.11n

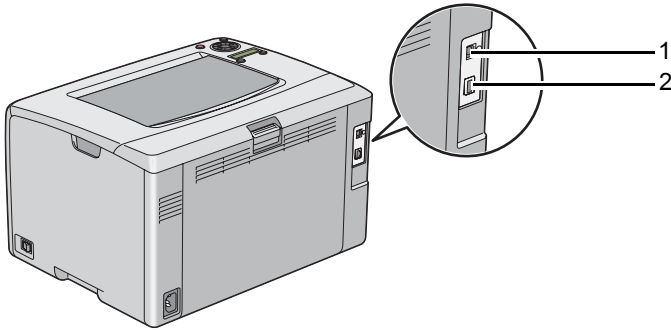

1 USB Port



2 Ethernet Port



■ Connecting Printer to Computer or Network

Connect the printer via Ethernet or USB. A USB connection is a direct connection and is not used for networking. An Ethernet connection is used for networking. Hardware and cabling requirements vary for the different connection methods. Ethernet cable and hardware are generally not included with your printer and must be purchased separately.

The available feature for each connection type is shown in the following table.

Connection Type	Available Feature
USB	When connected via USB, you can instruct print jobs from a computer.
Ethernet	When connected via Ethernet, you can instruct print jobs from a computer on the network.

USB Connection

A local printer is a printer which is directly attached to your computer using the USB cable. If your printer is attached to a network instead of your computer, skip this section and go to "[Network Connection](#)" on page 54.

The following operating systems support USB connection:

- Windows XP
- Windows XP 64-bit Edition
- Windows Server® 2003
- Windows Server 2003 x64 Edition
- Windows Server 2008
- Windows Server 2008 64-bit Edition
- Windows Server 2008 R2
- Windows Vista®
- Windows Vista 64-bit Edition
- Windows 7
- Windows 7 64-bit Edition
- Mac OS X 10.3.9/10.4.11/10.5.8 -10.6

To attach the printer to a computer:

- 1 Ensure that the printer, computer, and any other attached devices are turned off and unplugged from the power source/outlet.
- 2 Connect the smaller USB connector into the USB port at the back of the printer and the other end of the cable into a USB port of the computer.

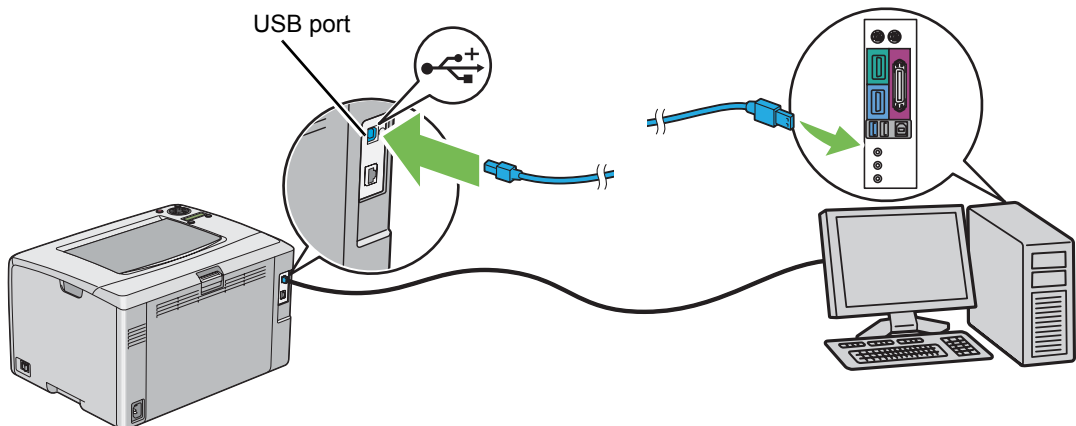

NOTE:

- Do not connect the printer USB cable to the USB connector available on the keyboard.

Network Connection

To connect the printer to a network:

- 1 Ensure that the printer, computer and any other connected devices have been turned off and all cables have been disconnected.
- 2 Connect one end of an Ethernet cable into the Ethernet port at the rear of the printer, and the other end to a LAN drop or hub.

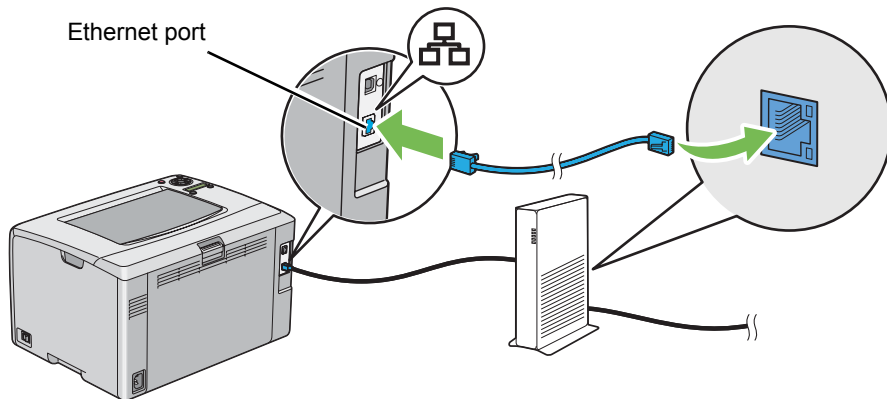

NOTE:

- Connect the Ethernet cable, only if you need to setup a wired connection.

See also:

- ["Configuring Wireless Settings \(DocuPrint CP205 w Only\)" on page 70](#)

Setting the IP Address

This section includes:

- ["TCP/IP and IP Addresses" on page 56](#)
- ["Automatically Setting the Printer's IP Address" on page 57](#)
- ["Dynamic Methods of Setting the Printer's IP Address" on page 58](#)
- ["Assigning an IP Address \(for IPv4 Mode\)" on page 59](#)
- ["Verifying the IP Settings" on page 62](#)
- ["Printing and Checking the Printer Settings Page" on page 63](#)

■ TCP/IP and IP Addresses

If your computer is on a large network, contact your network administrator for the appropriate TCP/IP addresses and additional system settings information.

If you are creating your own small Local Area Network or connecting the printer directly to your computer using Ethernet, follow the procedure for automatically setting the printer's IP address.

Computers and printers primarily use TCP/IP protocols to communicate over an Ethernet network. With TCP/IP protocols, each printer and computer must have a unique IP address. It is important that the addresses are similar, but not the same; only the last digit needs to be different. For example, your printer can have the address 192.168.1.2 while your computer has the address 192.168.1.3. Another device can have the address 192.168.1.4.

Many networks have a Dynamic Host Configuration Protocol (DHCP) server. A DHCP server automatically programs an IP address into every computer and printer on the network that is configured to use DHCP. A DHCP server is built into most cable and Digital Subscriber Line (DSL) routers. If you use a cable or DSL router, see your router's documentation for information on IP addressing.

■ Automatically Setting the Printer's IP Address

If the printer is connected to a small established TCP/IP network without a DHCP server, use the installer on the *Software Pack CD-ROM* to detect or assign an IP address to your printer. For further instructions, insert the *Software Pack CD-ROM* into your computer's CD-ROM drive. After the Installer launches, follow the prompts for installation.

NOTE:

- For the automatic installer to function, the printer must be connected to an established TCP/IP network.



■ Dynamic Methods of Setting the Printer's IP Address

There are two protocols available for dynamically setting the printer's IP address:

- DHCP (enabled by default)
- AutoIP







You can turn on/off both protocols using the operator panel, or use CentreWare Internet Services to turn on/off DHCP.

NOTE:

- You can print a report that includes the printer's IP address. On the operator panel, press the  (**Menu**) button, select *Information Pgs*, press the  button, select *Printer Settings*, and then press the  button. The IP address is listed on the Printer Settings page.

Using the Operator Panel

To turn on/off either the DHCP or AutoIP protocol:

- 1 On the operator panel, press the  (**Menu**) button.
- 2 Select *Admin Menu*, and then press the  button.
- 3 Select *Network Setup*, and then press the  button.
- 4 Select *TCP/IP*, and then press the  button.
- 5 Select *IPv4*, and then press the  button.
- 6 Select *Get IP Address*, and then press the  button.
- 7 Select *DHCP/AutoIP*, and then press the  button.

Using CentreWare Internet Services

To turn on/off the DHCP protocol:

- 1 Launch your web browser.
- 2 Enter the IP address of the printer in the address bar, and then press the **Enter** key.
- 3 Select **Properties**.
- 4 Select **TCP/IP** from the **Protocol Settings** folder on the left navigation panel.
- 5 In the **Get IP Address** field, select the **DHCP / Autonet** option.
- 6 Click the **Apply** button.

























■ Assigning an IP Address (for IPv4 Mode)

NOTE:

- When you assign an IP address manually in **IPv6** mode, use the CentreWare Internet Services. To display the CentreWare Internet Services, use the link local address. To check a link local address, see "[Printing and Checking the Printer Settings Page](#)" on page 63.
- Assigning an IP address is considered as an advanced function and is normally done by a system administrator.
- Depending on the address class, the range of the IP address assigned may be different. On Class A, for example, an IP address in the range from 0.0.0.0 to 127.255.255.255 will be assigned. For assignment of IP addresses, contact your system administrator.

You can assign the IP address by using the operator panel or using the Printer Setting Utility.

The Operator Panel

- 1** Turn on the printer.
Ensure that `Ready` message appears on the LCD panel.
- 2** On the operator panel, press the  (**Menu**) button.
- 3** Select `Admin Menu`, and then press the  button.
- 4** Select `Network Setup`, and then press the  button.
- 5** Select `TCP/IP`, and then press the  button.
- 6** Select `IPv4`, and then press the  button.
- 7** Select `Get IP Address`, and then press the  button.
- 8** Ensure that `Panel` is selected, and then press the  (**Back**) button.
- 9** Ensure that `Get IP Address` is selected.
- 10** Select `IP Address`, and then press the  button.
The cursor is located at the first digit of the IP address.
- 11** Enter the value of the IP address using the  or  button.
- 12** Press the  button.
The next digit is selected.
- 13** Repeat steps **11** to **12** to enter all of the digits in the IP address, and then press the  button.
- 14** Press the  (**Back**) button, and then ensure that `IP Address` is selected.
- 15** Select `Network Mask`, and then press the  button.
The cursor is located at the first digit of the network mask.
- 16** Enter the value of the network mask using the  or  button.
- 17** Press the  button.
The next digit is selected.
- 18** Repeat steps **16** to **17** to set network mask, and then press the  button.
- 19** Press the  (**Back**) button, and then ensure that `Network Mask` is selected.
- 20** Select `Gateway Address`, and then press the  button.
The cursor is located at the first digit of the gateway address.
- 21** Enter the value of the gateway address using the  or  button.
- 22** Press the  button.
The next digit is selected.
- 23** Repeat steps **21** to **22** to set gateway address, and then press the  button.

24 Turn off and turn on the printer.

See also:

- "Operator Panel" on page 33

The Printer Setting Utility

The following procedure uses Windows XP as an example.

NOTE:

- When you use IPv6 mode for network printing, you cannot use the Printer Setting Utility to assign an IP address.

1 Click **start** → **All Programs** → **Fuji Xerox** → **Fuji Xerox Printer Software for Asia-Pacific** → **FX DocuPrint CP205/FX DocuPrint CP205 w** → **Printer Setting Utility**.

NOTE:

- The **Select Printer** window appears in this step, when multiple print drivers are installed on your computer. In this case, click the name of the desired printer listed in **Printer Name**.

The Printer Setting Utility appears.

2 Click the **Printer Maintenance** tab.

3 Select **TCP/IP Settings** from the list at the left side of the page.

The **TCP/IP Settings** page is displayed.

4 Select the mode from **IP Address Mode**, and then enter the values in **IP Address**, **Network Mask**, and **Gateway Address**.

5 Click the **Restart printer to apply new settings** button to take effect.

The IP address is assigned to your printer. To verify the setting, display the web browser on any computer connected to the network and enter the IP address into the address bar on the browser. If the IP address is set up correctly, the CentreWare Internet Services displays in your browser.

You can also assign the IP address to the printer when installing the print drivers with installer. When you use the network installation feature, and the `Get IP Address` is set to `DHCP/AutoIP` on the operator panel menu, you can set the IP address from `0.0.0.0` to the desired IP address on the printer selection window.

■ Verifying the IP Settings

The following procedure uses Windows XP as an example.

- 1 Print the Printer Settings page.
- 2 Look under the **IPv4** heading on the Printer Settings page to ensure that the IP address, network mask, and gateway address are appropriate.

To verify if the printer is active on the network, run the ping command in your computer:

- 1 Click **start**, and select **Run**.
- 2 Enter **cmd**, and then click **OK**.
A black window is displayed.
- 3 Enter **ping xx.xx.xx.xx** (where **xx.xx.xx.xx** is the IP address of your printer), and then press the **Enter** key.
- 4 Reply from the IP address denotes printer is active on the network.

See also:

- ["Printing and Checking the Printer Settings Page" on page 63](#)



■ Printing and Checking the Printer Settings Page

Print the Printer Settings page and check your printer's IP address.

This section includes:

- ["The Operator Panel" on page 63](#)
- ["The Printer Setting Utility" on page 63](#)

The Operator Panel

- 1 Press the  (**Menu**) button.
- 2 Select `Information Pgs`, and then press the  button.
- 3 Select `Printer Settings`, and then press the  button.
The Printer Settings page is printed.
- 4 Confirm the IP address next to **IP Address** under **Network Setup** on the Printer Settings page. If the IP address is **0.0.0.0**, wait for a few minutes to resolve the IP address automatically, and then print the Printer Settings page again.
If the IP address is not resolved automatically, see ["Assigning an IP Address \(for IPv4 Mode\)" on page 59](#).

The Printer Setting Utility

The following procedure uses Windows XP as an example.

- 1 Click **start** → **All Programs** → **Fuji Xerox** → **Fuji Xerox Printer Software for Asia-Pacific** → **FX DocuPrint CP205/FX DocuPrint CP205 w** → **Printer Setting Utility**.

NOTE:

- The **Select Printer** window appears in this step, when multiple print drivers are installed on your computer. In this case, click the name of the desired printer listed in **Printer Name**.

The Printer Setting Utility appears.

- 2 Click the **Printer Settings Report** tab.
- 3 Select **Information Pages** from the list at the left side of the page.
The **Information Pages** page is displayed.
- 4 Click the **Printer Settings** button.
The Printer Settings page is printed.

If the IP address is **0.0.0.0** (the factory default) or **169.254.xx.xx**, an IP address has not been assigned.

See also:

- ["Assigning an IP Address \(for IPv4 Mode\)" on page 59](#)

Installing Print Driver on Computers Running Windows

This section includes:

- ["Identifying Print Driver Pre-install Status \(for Network Connection Setup\)"](#) on page 65
- ["Inserting the Software Pack CD-ROM"](#) on page 67
- ["USB Connection Setup"](#) on page 68
- ["Network Connection Setup"](#) on page 69
- ["Configuring Wireless Settings \(DocuPrint CP205 w Only\)"](#) on page 70
- ["Setting Up for Shared Printing"](#) on page 95

■ Identifying Print Driver Pre-install Status (for Network Connection Setup)



Before installing the print driver on your computer, print the Printer Settings page to check the IP address of your printer.

The following procedure uses Windows XP as an example.

This section includes:

- ["The Operator Panel" on page 65](#)
- ["The Printer Setting Utility" on page 65](#)
- ["Disabling the Firewall Before Installing Your Printer" on page 66](#)

The Operator Panel

- 1 Press the  (**Menu**) button.
- 2 Select `Information Pgs`, and then press the  button.
- 3 Select `Printer Settings`, and then press the  button.
The Printer Settings page is printed.
- 4 Find the IP address under **Network Setup/Wireless Setup** on the Printer Settings page.
If the IP address is `0.0.0.0`, wait for a few minutes to resolve the IP address automatically, and then print the Printer Settings page again.
If the IP address is not resolved automatically, see ["Assigning an IP Address \(for IPv4 Mode\)" on page 59](#).

The Printer Setting Utility

- 1 Click **start** → **All Programs** → **Fuji Xerox** → **Fuji Xerox Printer Software for Asia-Pacific** → **FX DocuPrint CP205/FX DocuPrint CP205 w** → **Printer Setting Utility**.

NOTE:

- The **Select Printer** window appears in this step, when multiple print drivers are installed on your computer. In this case, click the name of the desired printer listed in **Printer Name**.

The Printer Setting Utility appears.

- 2 Select **TCP/IP Settings** from the list on the left side of the page.
The **TCP/IP Settings** page appears.

If the IP address shows **0.0.0.0** (the factory default) or **169.254.xx.xx**, an IP address has not been assigned. To assign one for your printer, see ["Assigning an IP Address \(for IPv4 Mode\)" on page 59](#).

Disabling the Firewall Before Installing Your Printer

NOTE:

- For Windows XP, Service Pack 2 or 3 must be installed.

If you are running one of the following operating systems, you must disable the firewall before installing the Fuji Xerox printer software:

- Windows 7
- Windows Vista
- Windows Server 2008 R2
- Windows Server 2008
- Windows XP

The following procedure uses Windows XP as an example.

- 1 Click **start** → **Help and Support**.

NOTE:

- For Windows Vista, Windows Server 2008, Windows Server 2008 R2 and Windows 7 operating systems, if you use **Online Help**, switch to **Offline Help** on **Windows Help and Support** window.

- 2 In the **Search** box, enter **firewall** and then press the **Enter** key.

In the list, click **Turn Windows Firewall on or off** and then follow the instructions on the screen.

Enable the firewall after the installation of the Fuji Xerox printer software is complete.

■ Inserting the Software Pack CD-ROM

- 1 Insert the *Software Pack CD-ROM* into your computer to start **Easy Install Navi**.

NOTE:

- If the CD does not automatically launch, click **Start** (**start** for Windows XP) → **All Programs** (for Windows Vista and Windows 7) → **Accessories** (for Windows Vista and Windows 7) → **Run**, and then enter **D:\setup.exe** (where D is the drive letter of your CD), and then click **OK**.

■ USB Connection Setup

The following procedure uses Windows XP as an example.

• When the Printer is Connected to Computer With a USB Cable

1 Turn on the printer.

NOTE:

- If **Found New Hardware Wizard** appears, click **Cancel** at this time.

2 Click **Installing Drivers and Software**.

3 Select **Personal Installation (USB)**, and then click **Next**.

4 If you agree to the terms of the **License Agreement**, click **I accept the terms of the license agreement** to continue the installation process, and then click **Next**.

5 Follow the on-screen instructions.

The Plug and Play installation starts and the installation software proceeds to the next page automatically.

6 Click **Finish** to exit the wizard when the "Congratulations!" screen appears. If necessary, click **Print Test Page** to print a test page.

• When the Printer is not Connected to Computer With a USB Cable

1 Turn off the printer.

2 Click **Installing Drivers and Software**.

3 Select **Personal Installation (USB)**, and then click **Next**.

4 If you agree to the terms of the **License Agreement**, click **I accept the terms of the license agreement** to continue the installation process, and then click **Next**.

5 Follow the on-screen instructions to connect the computer and the printer with the USB cable, and then turn on the printer.

6 Click **Finish** to exit the wizard.

7 Proceed the Plug and Play installation.

• USB Printing

A personal printer is a printer attached to your computer or a print server using a USB. If your printer is attached to a network and not your computer, see "[Network Connection Setup](#)" on page 69.

■ Network Connection Setup

- 1 Click **Installing Drivers and Software**.
- 2 Select **Network Installation**, and then click **Next**.
- 3 If you agree to the terms of the **License Agreement**, click **I accept the terms of the license agreement** to continue the installation process, and then click **Next**.
- 4 Select the printer you want to install from the printer list, and then click **Next**. If the target printer is not displayed on the list, click **Refresh** to refresh the list or click **Manually add using IP address** to add a printer to the list manually. You may specify the IP address and port name at this point.

If you have installed this printer on the server computer, select **I am setting up this printer on a server** check box.

NOTE:

- When using AutoIP, **0.0.0.0** is displayed in the installer. Before you can continue, you must enter a valid IP address.
- 5 Specify the printer settings, and then click **Next**.
 - a Enter the printer name.
 - b If you want other users on the network to access this printer, select **Share this printer with other computers on the network**, and then enter a share name that users can identify.
 - c If you want to set a printer as the default, select the **Set this printer as default** check box.
 - 6 Select the software and documentation you want to install, and then click **Install**. You can specify folders in which to install the software and documentation. To change the folders, click **Browse**.
 - 7 Click **Finish** to exit the wizard when the "Congratulations!" screen appears. If necessary, click **Print Test Page** to print a test page.

■ Configuring Wireless Settings (DocuPrint CP205 w Only)

This section describes how to configure wireless settings through **Easy Install Navi**.

IMPORTANT:

- The Wireless LAN feature is unavailable depending on the region you purchased.

The specifications of wireless setting function are described below:

Item	Specification
Connectivity	Wireless
Connectivity Standard	IEEE 802.11b/g/n compliant
Bandwidth	2.4 GHz
Data Transfer Rate	IEEE 802.11b mode: 11, 5.5, 2, 1 Mbps IEEE 802.11g mode: 54, 48, 36, 24, 18, 12, 9, 6 Mbps IEEE 802.11n mode: 65 Mbps
Security	64 (40-bit key)/ 128 (104-bit key) WEP, WPA- PSK (TKIP, AES), WPA2-PSK (AES)(IEEE802.1x attestation function of WPA 1x non-corresponds)
Certifications	Wi-Fi, WPA2.0 (Personal)
Wi-Fi Protected Setup (WPS)	Push Button Configuration (PBC), Personal Identification Number (PIN)

You can select a method to configure a wireless setting from the following:

Wizard Setup Through USB Connection	
Advanced Setup Through	Ethernet connection
	Operator Panel
	CentreWare Internet Services
	WPS-PIN ^{*1}
	WPS-PBC ^{*2}

^{*1} WPS-PIN (Wi-Fi[®] Protected Setup-Personal Identification Number) is a method to authenticate and register devices required for wireless configuration, by entering PIN assignments in the printer and computer. This setting, performed through access point, is available only when the access points of your wireless router supports WPS.

^{*2} WPS-PBC (Wi-Fi Protected Setup-Push Button Configuration) is a method to authenticate and register devices required for wireless configuration, by pressing the button provided on the access point via wireless routers, and then performing WPS-PBC setting on the operator panel. This setting is available only when the access point supports WPS.

NOTE:

- For information on how to install a wireless, see ["Using Wizard Setup to Configure Wireless Settings" on page 71](#) or ["Using Advanced Setup to Configure Wireless Settings" on page 73](#).

Using Wizard Setup to Configure Wireless Settings

The following procedure uses Windows XP as an example.

- 1 Insert the *Software Pack CD-ROM* provided with the printer in your computer. The **Easy Install Navi** launches automatically.

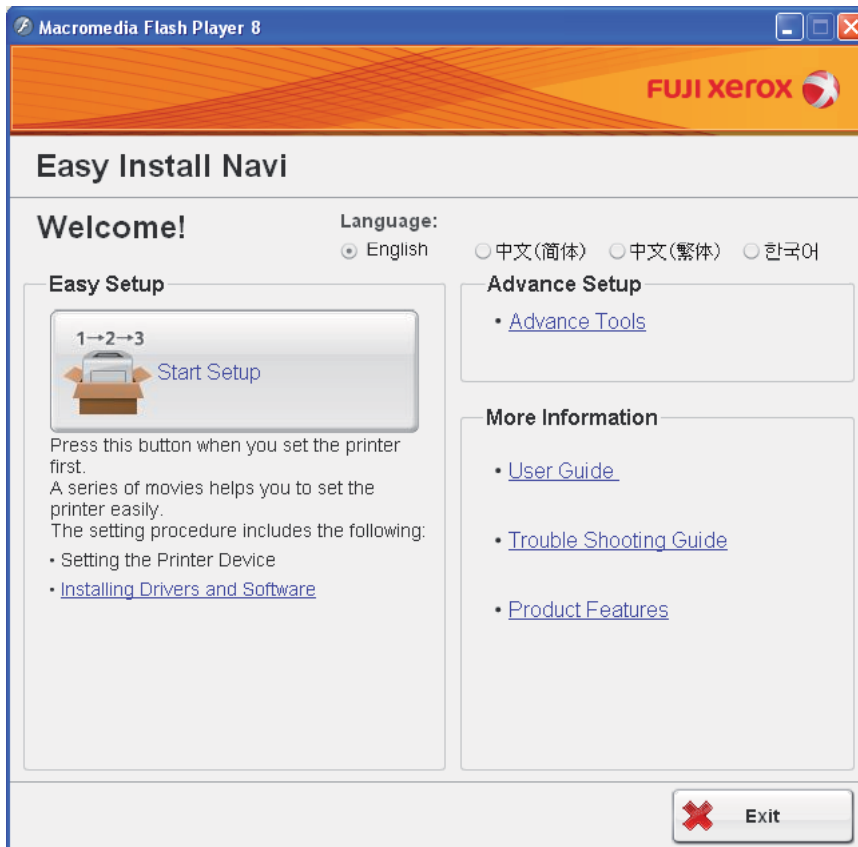

- 2 Click **Start Setup**.
- 3 Click **Connect Your Printer**.
Select your type of connection screen appears.
- 4 Select **Wireless Connection**, and then click **Next**.
The setting method selection window appears.
- 5 Ensure that **Wizard** is selected, and then click **Next**.

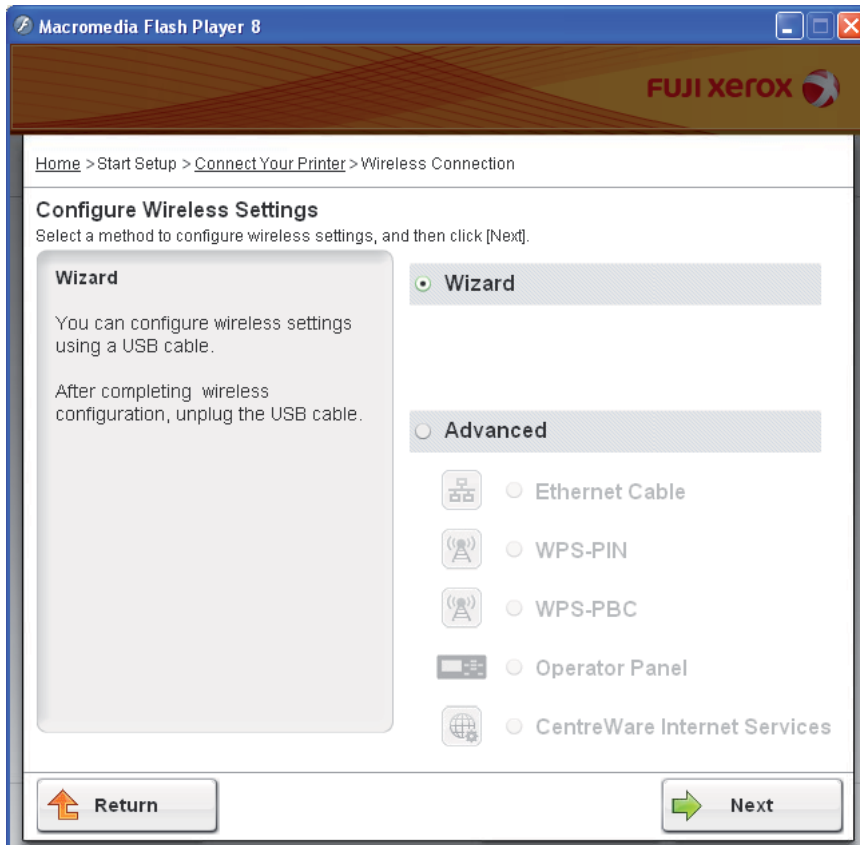

- 6 Follow the instructions until the **Check Setup** screen appears.
 - 7 Confirm there are no errors displayed on the LCD panel, and then click **Start Installation**. If you see any errors, click **Trouble Shooting Guide** and follow the instruction.
 - 8 If you agree to the terms of the **License Agreement**, click **I accept the terms of the license agreement** to continue the installation process, and then click **Next**.
 - 9 Check if the printer to be installed is listed in the **Select Printer** screen, and then click **Next**.
- NOTE:**
- If the printer to be installed is not listed in the **Select Printer** screen, try the following steps:
 - Click **Refresh** to update the information.
 - Click **Manually add using IP address**, and then enter the details of the printer manually.
- 10 Select the required items on the **Enter Printer Settings** screen, and then click **Next**.
 - 11 Select the software to be installed, and then click **Install**.
The "Congratulations!" screen appears.
 - 12 Click **Finish** to exit this tool.
The wireless configuration is complete.

Using Advanced Setup to Configure Wireless Settings

To use the Advanced setup, display the Configure Wireless Settings screen.

The following procedure uses Windows XP as an example.

• Displaying Configure Wireless Settings Screen

- 1 Insert the *Software Pack CD-ROM* provided with the printer in your computer. The **Easy Install Navi** launches automatically.

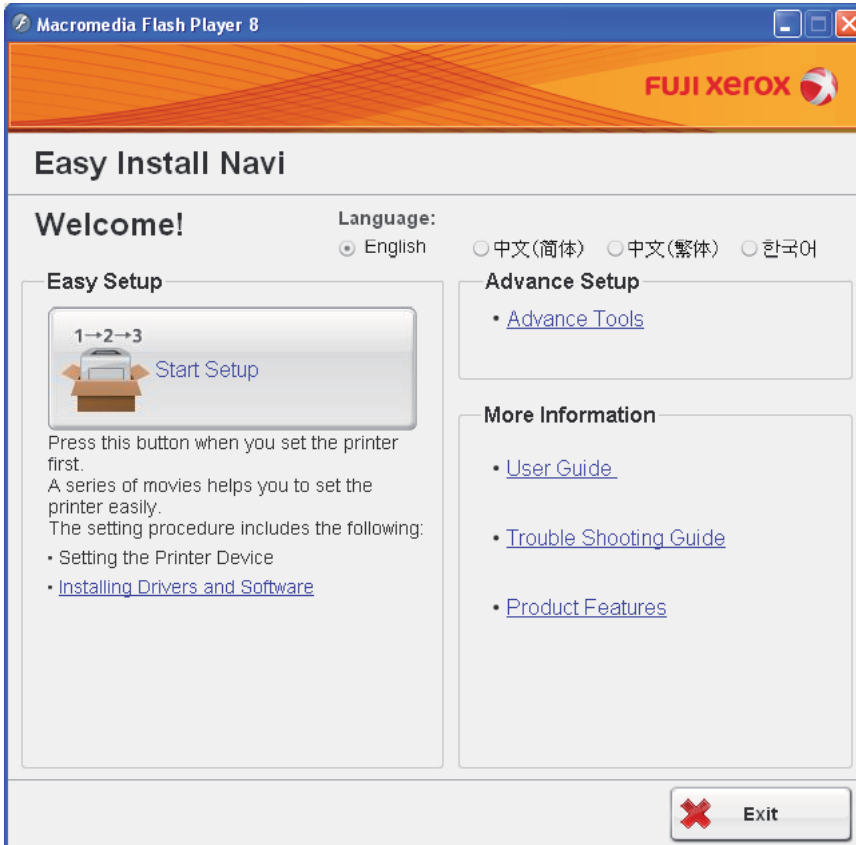

- 2 Click **Start Setup**.
- 3 Click **Connect Your Printer**.
- 4 Select **Wireless Connection**, and then click **Next**.
The setting method selection window appears.
- 5 Select **Advanced**.

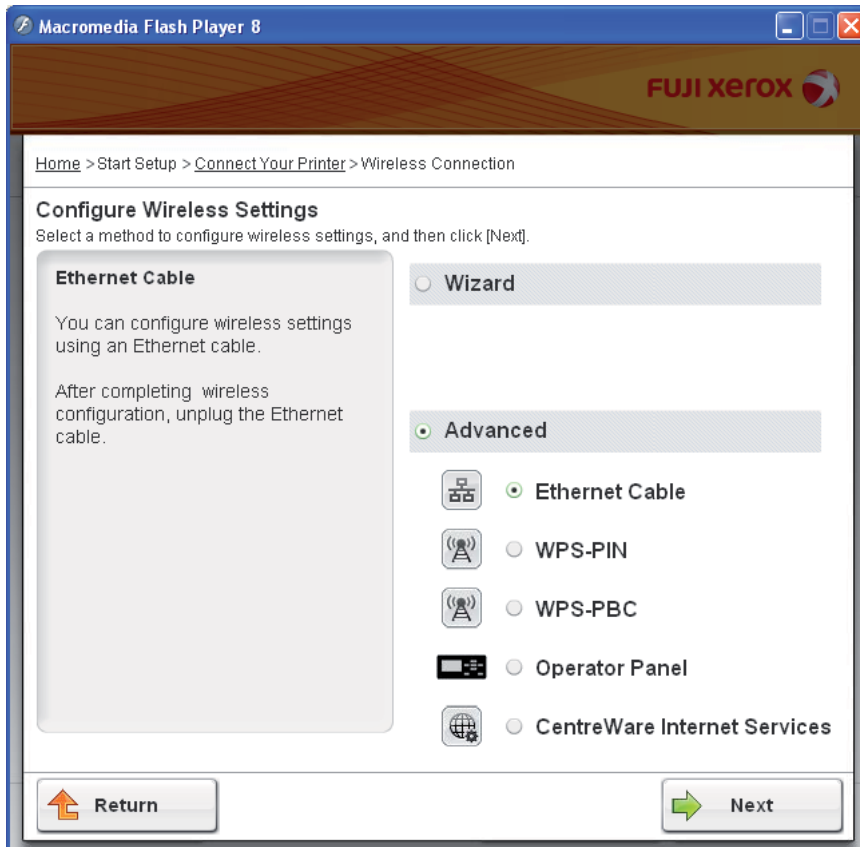

- **Select a connection method from the following**

- ["Ethernet Cable" on page 76](#)
- ["WPS-PIN" on page 79](#)
- ["WPS-PBC" on page 81](#)
- ["Operator Panel" on page 83](#)
- ["CentreWare Internet Services" on page 84](#)

• Ethernet Cable

- 1 Select **Ethernet Cable**, and then click **Next**.
- 2 Follow the instructions, and then click **Next**.
The **Printer Setup Utility** screen appears.
- 3 Select the printer to be configured in the **Select Printer** screen, and then click **Next**.

NOTE:

- If the printer to be configured is not listed in the **Select Printer** screen, try the following steps:
 - Click **Refresh** to update the information.
 - Click **Enter IP Address**, and then enter the IP address of your printer.

- 4 Enter the SSID.
- 5 Select **Type of wireless network**.
- 6 Configure the security setting, and then click **Next**.
The **IP Address Settings** screen appears.
- 7 Select **IP Mode** depending on your network scheme.

When **IPv4** is selected:

- Configure the following:
 - a Select **Type**.
 - b Enter the following items:
 - **IP Address** of your printer
 - **Network Mask**

- **Gateway Address**

When **IPv6** is selected:

- Configure the following:
 - a Select **Use Manual Address**.
 - b Enter IP address of your printer.
 - c Enter the gateway address of your network.

When **Dual Stack** is selected:

Configure the **IPv4 Settings** and **IPv6 Settings**.

- 8 Click **Next**.
- 9 Ensure that the wireless settings are displayed, and then click **Apply**. The **Complete configuration** screen appears.
- 10 Click **Next**.
- 11 Follow the instructions until the **Check Setup** screen appears.
- 12 Confirm there are no errors displayed on the LCD panel, and then click **Start Installation**. If you see any errors, click **Trouble Shooting Guide** and follow the instruction.

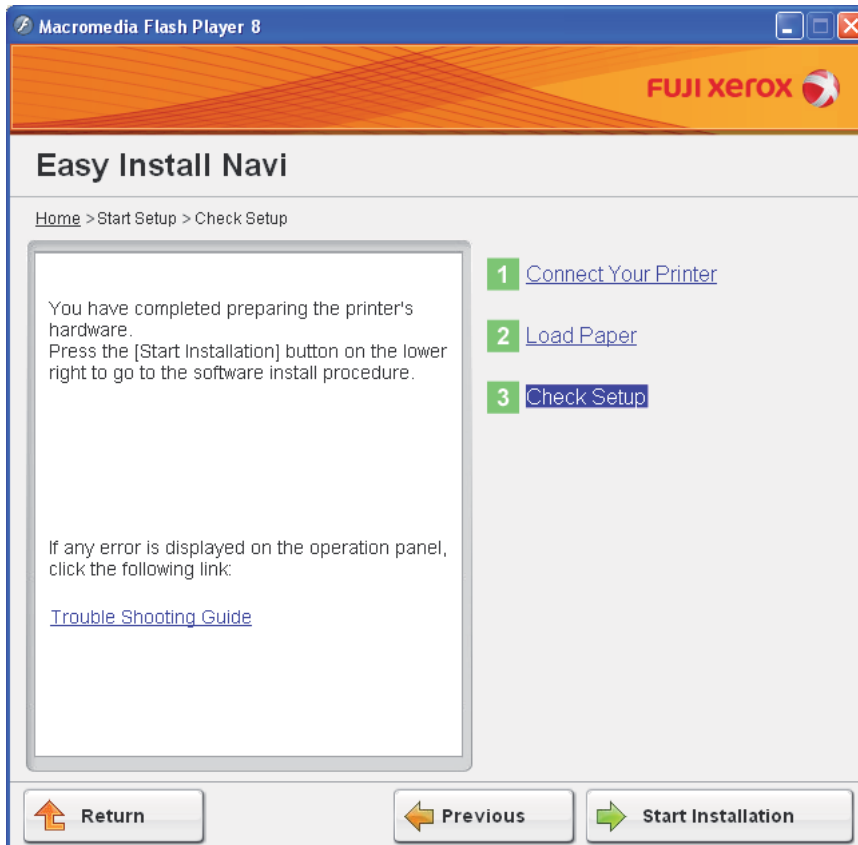

- 13 If you agree to the terms of the **License Agreement**, click **I accept the terms of the license agreement** to continue the installation process, and then click **Next**.
- 14 Check if the printer to be installed is listed in the **Select Printer** screen, and then click **Next**.

NOTE:

- If the printer to be installed is not listed in the **Select Printer** screen, try the following steps:
 - Click **Refresh** to update the information.
 - Click **Manually add using IP address**, and then enter the details of the printer manually.

15 Configure the required items on the **Enter Printer Settings** screen, and then click **Next**.

16 Select the software to be installed, and then click **Install**.

The "Congratulations!" screen appears.

17 Click **Finish** to exit this tool.

The wireless configuration is complete.

• WPS-PIN

NOTE:

- WPS-PIN (Wi-Fi Protected Setup-Personal Identification Number) is a method to authenticate and register devices required for wireless configuration, by entering PIN assignments to a printer and computer. This setting, performed through access point, is available only when the access points of your wireless router supports WPS.

- 1 Select **WPS-PIN**, and then click **Next**.
- 2 Follow the instructions until the **Check Setup** screen appears.
- 3 Confirm there are no errors displayed on the LCD panel, and then click **Start Installation**.
If you see any errors, click **Trouble Shooting Guide** and follow the instruction.

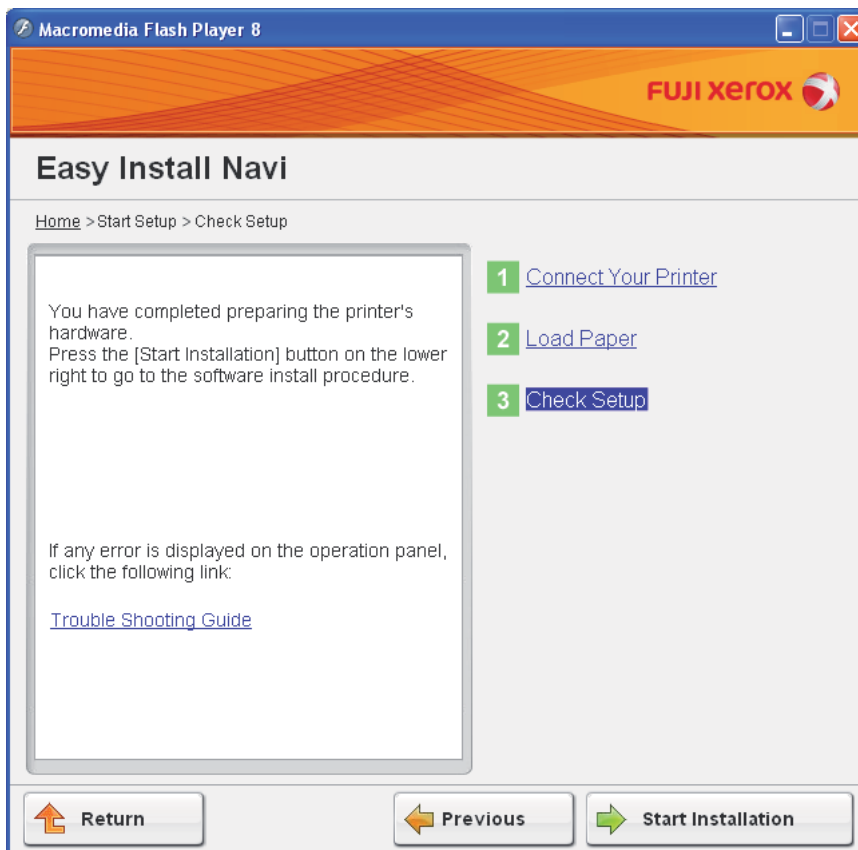

- 4 If you agree to the terms of the **License Agreement**, click **I accept the terms of the license agreement** to continue the installation process, and then click **Next**.
- 5 Check if the printer to be installed is listed in the **Select Printer** screen, and then click **Next**.

NOTE:

- If the printer to be installed is not listed in the **Select Printer** screen, try the following steps:
 - Click **Refresh** to update the information.
 - Click **Manually add using IP address**, and then enter the details of the printer manually.

- 6 Configure the required items on the **Enter Printer Settings** screen, and then click **Next**.
- 7 Select the software to be installed, and then click **Install**.

The "Congratulations!" screen appears.

8 Click **Finish** to exit this tool.

The wireless configuration is complete.

When the **WPS-PIN** operation is successful and the printer is rebooted, wireless LAN connection is completed.

• WPS-PBC

NOTE:

- WPS-PBC (Wi-Fi Protected Setup-Push Button Configuration) is a method to authenticate and register devices required for wireless configuration, by pressing the button provided on the access point via wireless routers, and then performing WPS-PBC setting on the operator panel. This setting is available only when the access point supports WPS.

- 1 Select **WPS-PBC**, and then click **Next**.
- 2 Follow the instructions until the **Check Setup** screen appears.
- 3 Confirm there are no errors displayed on the LCD panel, and then click **Start Installation**.
If you see any errors, click **Trouble Shooting Guide** and follow the instruction.

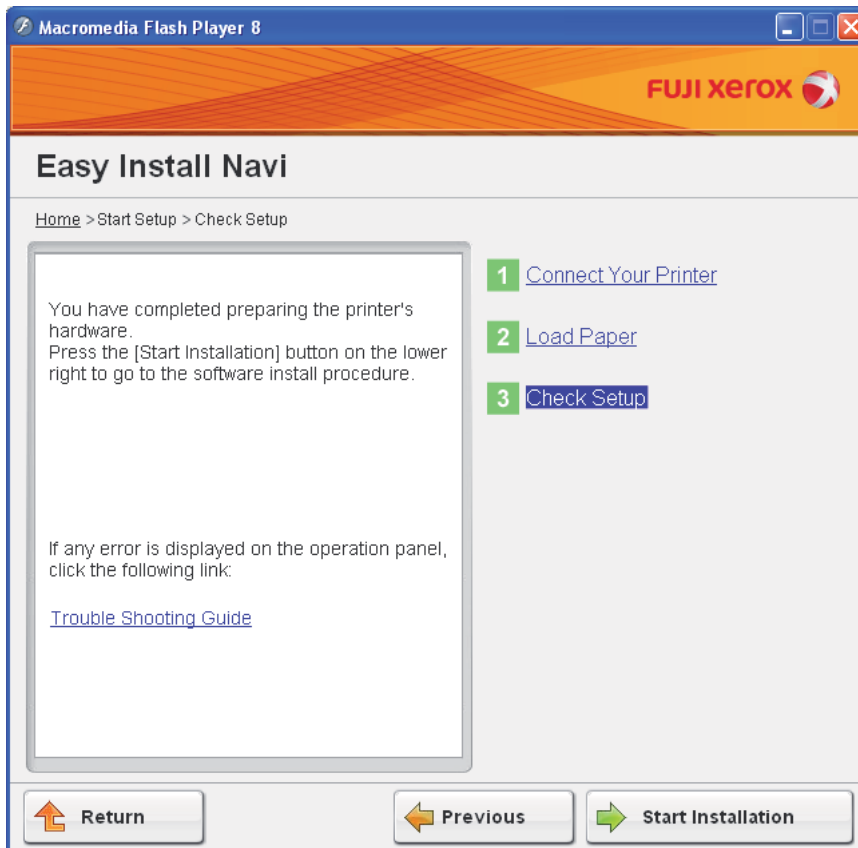

- 4 If you agree to the terms of the **License Agreement**, click **I accept the terms of the license agreement** to continue the installation process, and then click **Next**.
- 5 Check if the printer to be installed is listed in the **Select Printer** screen, and then click **Next**.

NOTE:

- If the printer to be installed is not listed in the **Select Printer** screen, try the following steps:
 - Click **Refresh** to update the information.
 - Click **Manually add using IP address**, and then enter the details of the printer manually.

- 6 Configure the required items on the **Enter Printer Settings** screen, and then click **Next**.
- 7 Select the software to be installed, and then click **Install**.

The "Congratulations!" screen appears.

8 Click **Finish** to exit this tool.

The wireless configuration is complete.

NOTE:

- For **WPS-PBC** operation on the wireless LAN access point, refer to the manual supplied with the wireless LAN access point.

When the **WPS-PBC** operation is successful and the printer is rebooted, wireless LAN connection is completed.

• Operator Panel

- 1 Select **Operator Panel**, and then click **Next**.
- 2 Follow the instructions until the **Check Setup** screen appears.
- 3 Confirm there are no errors displayed on the LCD panel, and then click **Start Installation**.
If you see any errors, click **Trouble Shooting Guide** and follow the instruction.

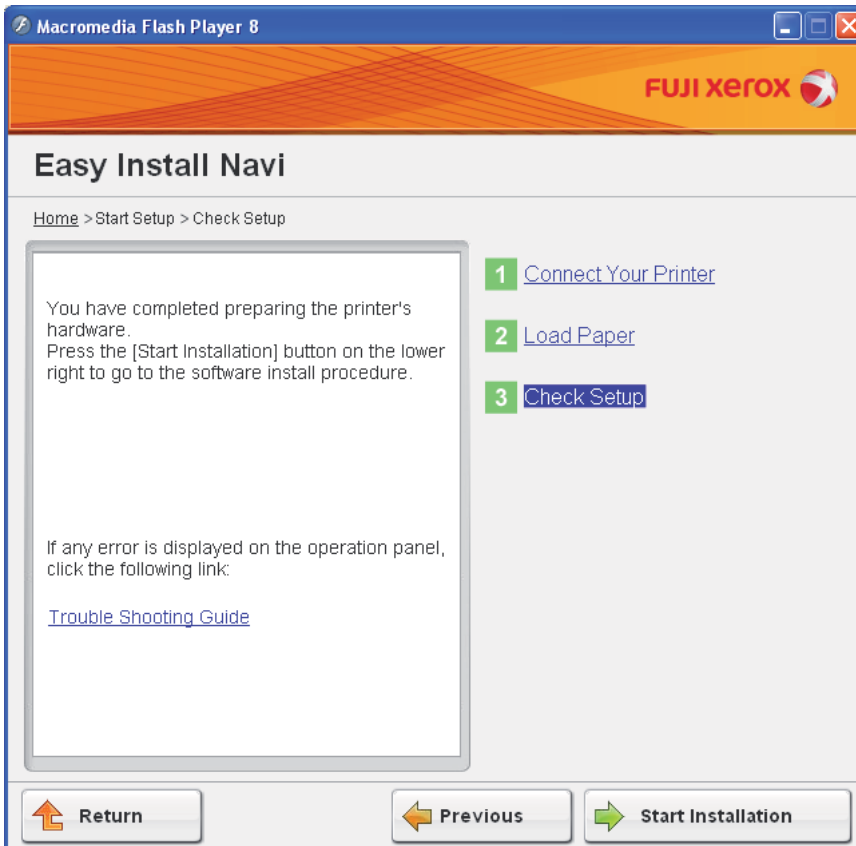

- 4 If you agree to the terms of the **License Agreement**, click **I accept the terms of the license agreement** to continue the installation process, and then click **Next**.
- 5 Check if the printer to be installed is listed in the **Select Printer** screen, and then click **Next**.
NOTE:
 - If the printer to be installed is not listed in the **Select Printer** screen, try the following steps:
 - Click **Refresh** to update the information.
 - Click **Manually add using IP address**, and then enter the details of the printer manually.
- 6 Configure the required items on the **Enter Printer Settings** screen, and then click **Next**.
- 7 Select the software to be installed, and then click **Install**.
The "Congratulations!" screen appears.
- 8 Click **Finish** to exit this tool.
The wireless configuration is complete.

• CentreWare Internet Services

- 1 Select **CentreWare Internet Services**, and then click **Next**.
- 2 Follow the instructions until the **Check Setup** screen appears.
- 3 Confirm there are no errors displayed on the LCD panel, and then click **Start Installation**.
If you see any errors, click **Trouble Shooting Guide** and follow the instruction.

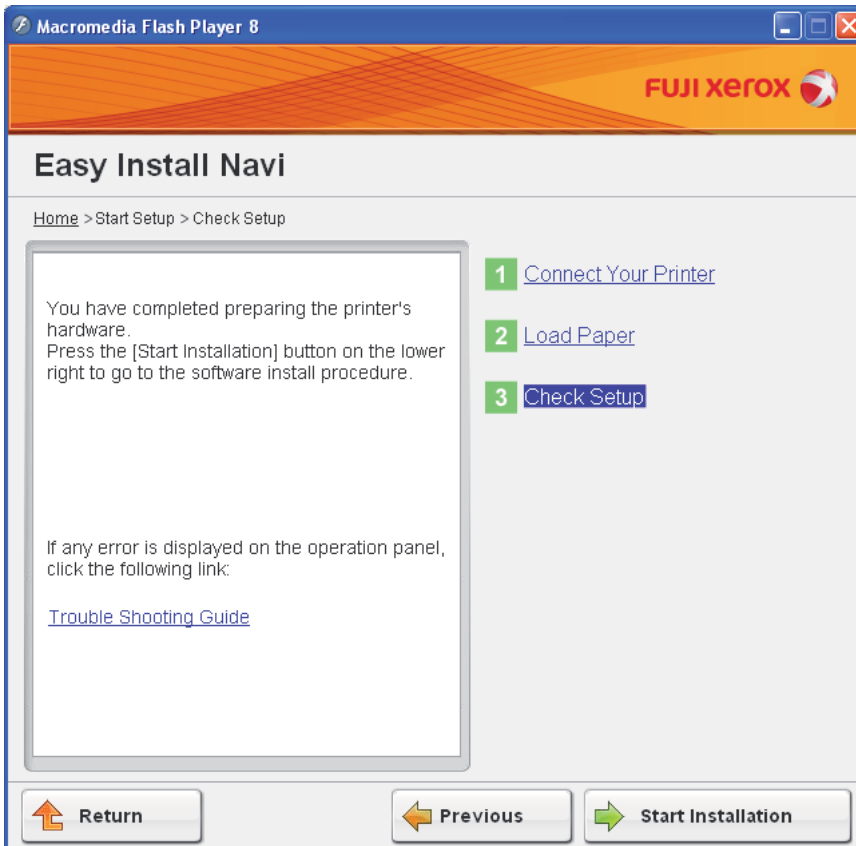

- 4 If you agree to the terms of the **License Agreement**, click **I accept the terms of the license agreement** to continue the installation process, and then click **Next**.
- 5 Check if the printer to be installed is listed in the **Select Printer** screen, and then click **Next**.
NOTE:
 - If the printer to be installed is not listed in the **Select Printer** screen, try the following steps:
 - Click **Refresh** to update the information.
 - Click **Manually add using IP address**, and then enter the details of the printer manually.
- 6 Configure the required items on the **Enter Printer Settings** screen, and then click **Next**.
- 7 Select the software to be installed, and then click **Install**.
The "Congratulations!" screen appears.
- 8 Click **Finish** to exit this tool.
The wireless configuration is complete.

When the CentreWare Internet Services operation is successful and the printer is rebooted, wireless LAN connection is completed.

Setting up a New Wireless Network Environment for Your Computer (When You Need to Setup Your Wireless Connectivity With Your Computer)

• For DHCP Network:

1 Setting up your computer for wireless connectivity:

NOTE:

- You can also change the wireless settings using the wireless application that may be installed in your computer.

For Windows XP and Windows Server 2003:

- a Select **Network Connections** from **Control Panel**.
- b Right-click **Wireless Network Connection** and select **Properties**.
- c Select the **Wireless Networks** tab.
- d Ensure that the check box for **Use Windows to configure my wireless network settings** is selected.

NOTE:

- Make note of the wireless settings on the **Advanced** window (step f) and the **Wireless network properties** window (step h). You may require these settings later.
- e Click the **Advanced** button.
 - f Select **Computer-to-computer (ad hoc) networks only** and close the **Advanced** dialog box.
 - g Click the **Add** button to display **Wireless network properties**.
 - h On the **Association** tab, enter the following information and click **OK**.

Network name (SSID): xxxxxxxx (xxxxxxx indicates a wireless device's SSID which you use)

Network Authentication: Open

Data encryption: Disabled

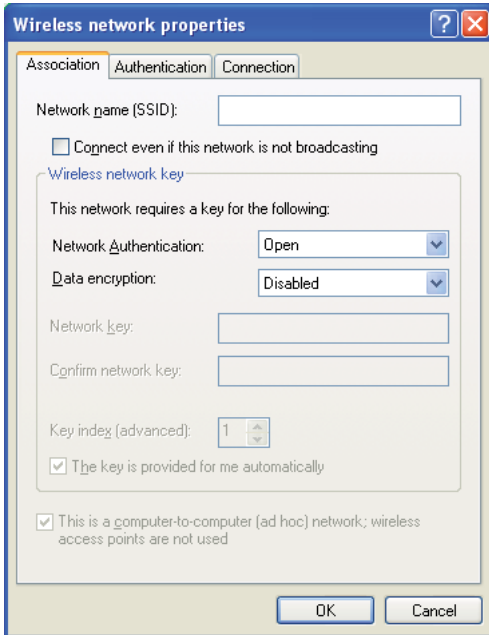

- i Click the **Move up** button to move the newly added SSID to the top of the list.
- j Click **OK** to close the **Wireless Network Connection Properties** dialog box.

For Windows Vista:







- a Display **Control Panel**.
- b Select **Network and Internet**.
- c Select **Network and Sharing Center**.
- d Select **Connect to a network**.
- e Select **xxxxxxxx** (xxxxxxxx indicates a wireless device's SSID which you use) from the network items listed in the available network list, and click **Connect**.
- f Click **Close** in the dialog box after confirming the connection is a success.

For Windows Server 2008:

- a Display **Control Panel**.
- b Select **Network and Internet**.
- c Select **Network and Sharing Center**.
- d Select **Connect to a network**.
- e Select **xxxxxxxx** (xxxxxxxx indicates a wireless device's SSID which you use) from the network items listed in the available network list, and click **Connect**.
- f Click **Close** in the dialog box after confirming the connection is a success.

For Windows Server 2008 R2 and Windows 7:

- a Display **Control Panel**.
- b Select **Network and Internet**.
- c Select **Network and Sharing Center**.
- d Select **Connect to a network**.
- e Select **xxxxxxxx** (xxxxxxxx indicates a wireless device's SSID which you use) from the network items listed in the available network list, and click **Connect**.

- 2 Check the IP address assigned by AutoIP on the printer.
 - a On the operator panel, press the  (**Menu**) button.
 - b Select `Admin Menu`, and then press the  button.
 - c Select `Network Setup`, and then press the  button.
 - d Select `TCP/IP`, and then press the  button.
 - e Select `IPv4`, and then press the  button.
 - f Select `IP Address`, and then press the  button.
(Default IP address range: 169.254.xxx.yyy)

```
IP Address  
169.254.000.041*
```

- 3 Ensure that the IP Address on your computer is assigned by DHCP.

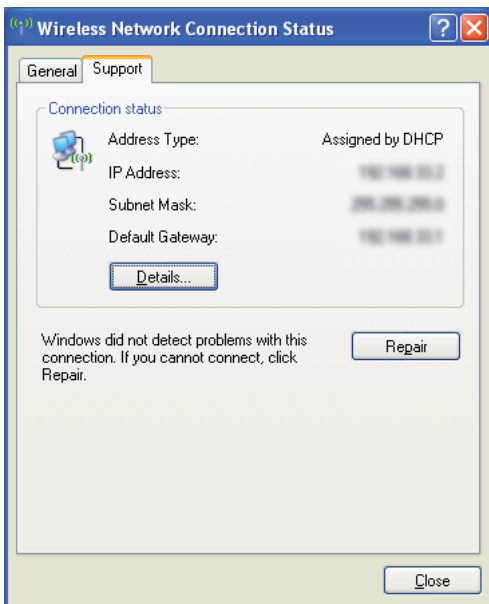

- 4 Launch your web browser.
- 5 Enter the IP address of the printer in the address bar, and then press the **Enter** key. CentreWare Internet Services page appears.

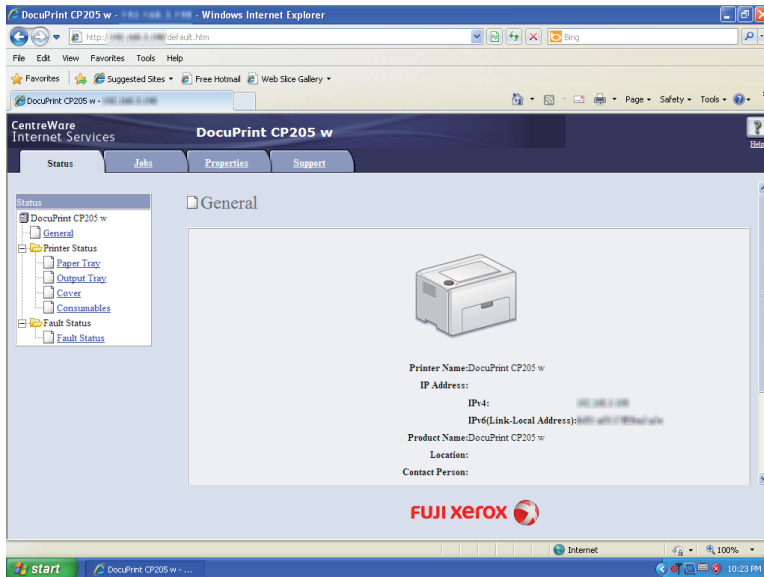

- 6 Create wireless setting of the printer on CentreWare Internet Services.
- 7 Reboot the printer.
- 8 Restore the wireless settings on your computer.

NOTE:

- If the operating system on your computer provides a wireless configuration software, use it to change the wireless settings. See the instructions below.

For Windows XP and Windows Server 2003:

- a Select **Network Connections** from **Control Panel**.
- b Right-click **Wireless Network Connection** and select **Properties**.
- c Select **Wireless Networks** tab.
- d Ensure that the check box for **Use Windows to configure my wireless network settings** is selected.
- e Click **Advanced**.
- f You can either set the printer to the ad-hoc mode or the infrastructure mode.
 - For Ad hoc mode:
 - Select **Computer-to-computer (ad hoc) networks only** and close the dialog box.
 - For Infrastructure mode:
 - Select **Access point (Infrastructure) networks only** and close the dialog box.
- g Click **Add** to display **Wireless network properties**.
- h Enter the setting that you will send to the printer and click **OK**.
- i Click **Move up** to move the setting to the top of the list.
- j Click **OK** to close the **Wireless Network Connection Properties** dialog box.

For Windows Vista:

- a Display **Control Panel**.
- b Select **Network and Internet**.
- c Select **Network and Sharing Center**.

- d Select **Connect to a network**.
- e Select the network, and then click **Connect**.
- f Click **Close** in the dialog box after confirming the connection is a success.

For Windows Server 2008:

- a Display **Control Panel**.
- b Select **Network and Internet**.
- c Select **Network and Sharing Center**.
- d Select **Connect to a network**.
- e Select the network, and then click **Connect**.
- f Click **Close** in the dialog box after confirming the connection is a success.

For Windows Server 2008 R2 and Windows 7:

- a Display **Control Panel**.
- b Select **Network and Internet**.
- c Select **Network and Sharing Center**.
- d Select **Connect to a network**.
- e Select the network, and then click **Connect**.

• For Fixed IP Networks:

1 Set up your computer for wireless connectivity:

NOTE:

- If the operating system on your computer provides a wireless configuration software, use it to change the wireless settings. See the instructions below.

For Windows XP and Windows Server 2003:

- a Select **Network Connections** from **Control Panel**.
- b Right-click **Wireless Network Connection** and select **Properties**.
- c Select the **Wireless Networks** tab.
- d Ensure that the check box for **Use Windows to configure my wireless network settings** is selected.

NOTE:

- a Be sure to write down the current wireless computer settings in step f and step h so that you can restore them later.
- b Click the **Advanced** button.
- c Select **Computer-to-computer (ad hoc) networks only** and close the **Advanced** dialog box.
- d Click the **Add** button to display **Wireless network properties**.
- e On the **Association** tab, enter the following information and click **OK**.

Network name (SSID): xxxxxxxx (xxxxxxx indicates a wireless device's SSID which you use)

Network Authentication: Open

Data encryption: Disabled

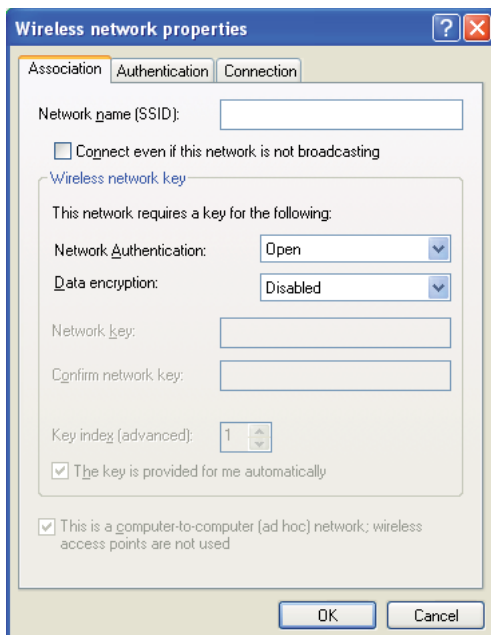

- f Click the **Move up** button to move the newly added SSID to the top of the list.
- g Click **OK** to close the **Wireless Network Connection Properties** dialog box.

For Windows Vista:

- a Display **Control Panel**.
- b Select **Network and Internet**.
- c Select **Network and Sharing Center**.
- d Select **Connect to a network**.
- e Select **xxxxxxxx** (xxxxxxxx indicates a wireless device's SSID which you use) from the network items listed in the available network list, and click **Connect**.
- f Click **Close** in the dialog box after confirming the connection is a success.

For Windows Server 2008:

- a Display **Control Panel**.
- b Select **Network and Internet**.
- c Select **Network and Sharing Center**.
- d Select **Connect to a network**.
- e Select **xxxxxxxx** (xxxxxxxx indicates a wireless device's SSID which you use) from the network items listed in the available network list, and click **Connect**.
- f Click **Close** in the dialog box after confirming the connection is a success.

For Windows Server 2008 R2 and Windows 7:

- a Display **Control Panel**.
- b Select **Network and Internet**.
- c Select **Network and Sharing Center**.
- d Select **Connect to a network**.
- e Select **xxxxxxxx** (xxxxxxxx indicates a wireless device's SSID which you use) from the network items listed in the available network list, and click **Connect**.

- 2 Check the IP address on your computer.

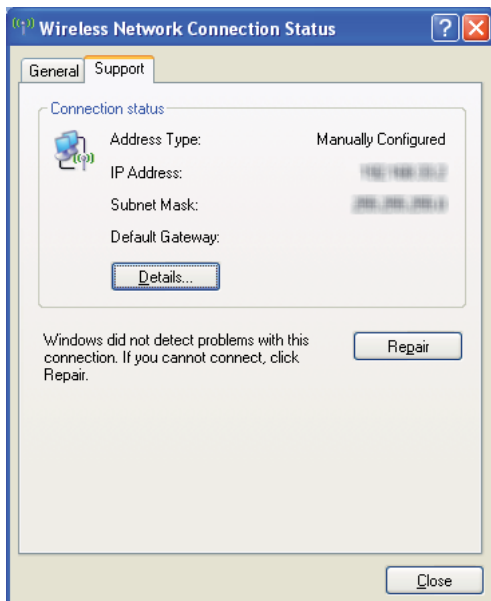

- 3 Set the IP address on the printer.
See "[Assigning an IP Address \(for IPv4 Mode\)](#)" on page 59.
- 4 Launch your web browser.

- 5 Enter the IP address of the printer in the address bar, and then press the **Enter** key. CentreWare Internet Services page appears.

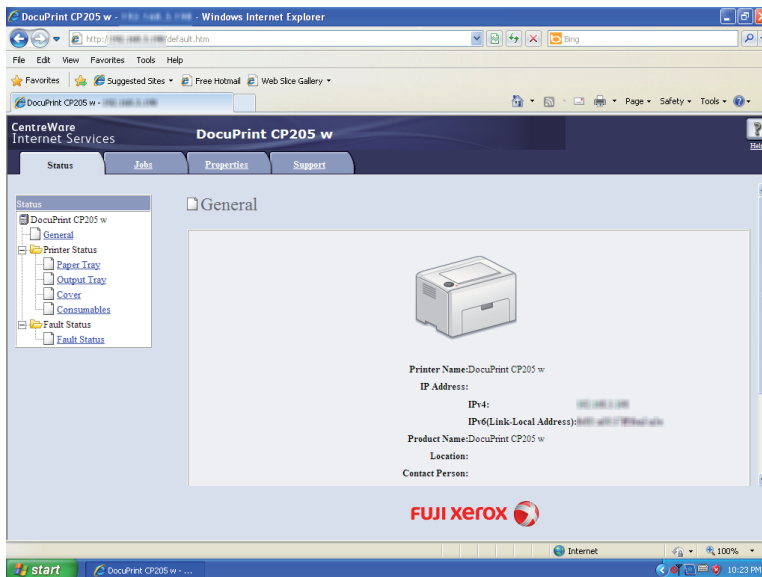

- 6 Change the wireless setting of the printer on CentreWare Internet Services.
- 7 Reboot the printer.
- 8 Restore the wireless settings on your computer.

NOTE:

- If the operating system on your computer provides a wireless configuration software, use it to change the wireless settings. Or you can change the wireless settings using the tool provided with the operating system. See the instructions below.

For Windows XP and Windows Server 2003:

- a Select **Network Connections** from **Control Panel**.
 - b Right-click **Wireless Network Connection** and select **Properties**.
 - c Select **Wireless Networks** tab.
 - d Ensure that the check box for **Use Windows to configure my wireless network settings** is selected.
 - e Click **Advanced**.
 - f You can either set the printer to the ad-hoc mode or the infrastructure mode.
- For Ad hoc mode:
Select **Computer-to-computer (ad hoc) networks only** and close the dialog box.
 - For Infrastructure mode:
Select **Access point (Infrastructure) networks only** and close the dialog box.
- g Click **Add** to display **Wireless network properties**.
 - h Enter the setting that you will send to the printer and click **OK**.
 - i Click **Move up** to move the setting to the top of the list.
 - j Click **OK** to close the **Wireless Network Connection Properties** dialog box.

For Windows Vista:

- a Display **Control Panel**.
- b Select **Network and Internet**.
- c Select **Network and Sharing Center**.
- d Select **Connect to a network**.
- e Select the network, and then click **Connect**.
- f Click **Close** in the dialog box after confirming the connection is a success.

For Windows Server 2008:

- a Display **Control Panel**.
- b Select **Network and Internet**.
- c Select **Network and Sharing Center**.
- d Select **Connect to a network**.
- e Select the network, and then click **Connect**.
- f Click **Close** in the dialog box after confirming the connection is a success.

For Windows Server 2008 R2 and Windows 7:

- a Display **Control Panel**.
- b Select **Network and Internet**.
- c Select **Network and Sharing Center**.
- d Select **Connect to a network**.
- e Select the network, and then click **Connect**.

■ Setting Up for Shared Printing

You can share your new printer on the network using the *Software Pack CD-ROM* that shipped with your printer, or using Windows Point and Print or peer-to-peer method. However, if you use either of the Microsoft methods you will not get features such as the SimpleMonitor and other printer utilities, which will get installed with the *Software Pack CD-ROM*.

If you want to use the printer on a network, share the printer and install its drivers on all the computers on the network.

NOTE:

- You need to purchase a Ethernet cable separately for shared printing.
- **For Windows XP, Windows XP 64-bit Edition, Windows Server 2003, and Windows Server 2003 x64 Edition**

- 1 Click **Start** (**start** for Windows XP) → **Printers and Faxes**.
- 2 Right-click this printer icon and select **Properties**.
- 3 From the **Sharing** tab, select the **Share this printer** check box, and then enter a name in the **Share name** text box.
- 4 Click **Additional Drivers** and select the operating systems of all network clients using this printer.
- 5 Click **OK**.
If the files are not present in your computer, and then you will be prompted to insert the server operating system CD.
- 6 Click **Apply**, and then click **OK**.

- **For Windows Vista and Windows Vista 64-bit Edition**

- 1 Click **Start** → **Control Panel** → **Hardware and Sound** → **Printers**.
- 2 Right-click the printer icon and select **Sharing**.
- 3 Click **Change sharing options** button.
- 4 The "**Windows needs your permission to continue**" appears.
- 5 Click **Continue** button.
- 6 Select the **Share this printer** check box, and then enter a name in the **Share name** text box.
- 7 Select **Additional Drivers** and select the operating systems of all network clients using this printer.
- 8 Click **OK**.
- 9 Click **Apply**, and then click **OK**.

• For Windows Server 2008 and Windows Server 2008 64-bit Edition

- 1 Click **Start** → **Control Panel** → **Hardware and Sound** → **Printers**.
- 2 Right-click the printer icon and select **Sharing**.
- 3 Select the **Share this printer** check box, and then enter a name in the **Share name** text box.
- 4 Click **Additional Drivers** and select the operating systems of all network clients using this printer.
- 5 Click **OK**.
- 6 Click **Apply**, and then click **OK**.

• For Windows 7, Windows 7 64-bit Edition, and Windows Server 2008 R2

- 1 Click **Start** → **Devices and Printers**.
- 2 Right-click the printer icon and select **Printer properties**.
- 3 On the **Sharing** tab, select the **Share this printer** check box, and then enter a name in the **Share name** text box.
- 4 Click **Additional Drivers** and select the operating systems of all network clients using this printer.
- 5 Click **OK**.
- 6 Click **Apply**, and then click **OK**.

To check that the printer is shared:

- Ensure that the printer object in the **Printers, Printers and Faxes** or **Devices and Printers** folder is shared. The share icon is shown under the printer icon.
- Browse **Network** or **My Network Places**. Find the host name of the server and look for the shared name you assigned to the printer.

Now that the printer is shared, you can install the printer on network clients using the Point and Print method or the peer-to-peer method.

Point and Print

Point and Print is a Microsoft Windows technology that allows you to connect to a remote printer. This feature automatically downloads and installs the print driver.

- **For Windows XP, Windows XP 64-bit Edition, Windows Server 2003, and Windows Server 2003 x64 Edition**

- 1 On the Windows desktop of the client computer, double-click **My Network Places**.
- 2 Locate the host name of the server computer, and then double-click the host name.
- 3 Right-click the shared printer name, and then click **Connect**.

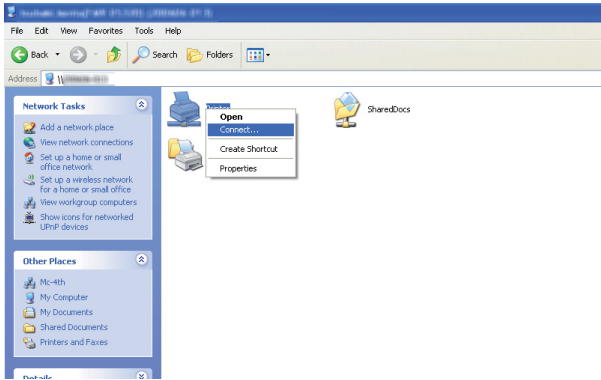

Wait for the driver information to be copied from the server computer to the client computer, and for a new printer object to be added to the **Printers and Faxes** folder. The time taken to copy varies based on the network traffic.

Close **My Network Places**.

- 4 Print a test page to verify installation.
 - a Click **start** (**Start** for Windows Server 2003/Windows Server 2003 x64 Edition) → **Printers and Faxes**.
 - b Select the printer you have installed.
 - c Click **File** → **Properties**.
 - d On the **General** tab, click **Print Test Page**.

When a test page is printed successfully, installation is complete.

• For Windows Vista and Windows Vista 64-bit Edition

- 1 Click **Start** → **Network**.
- 2 Locate and double-click the host name of the server computer.
- 3 Right-click the shared printer name, and then click **Connect**.
- 4 Click **Install driver**.
- 5 Click **Continue** in the **User Account Control** dialog box.
Wait until the driver is copied from the server to the client computer. A new printer object is added to the **Printers** folder. The duration of this procedure may vary based on the network traffic.
- 6 Print a test page to verify installation.
 - a Click **Start** → **Control Panel** → **Hardware and Sound**.
 - b Select **Printers**.
 - c Right-click the printer you just created and select **Properties**.
 - d On the **General** tab, click **Print Test Page**.
When a test page is printed successfully, installation is complete.

• For Windows Server 2008 and Windows Server 2008 64-bit Edition

- 1 Click **Start** → **Network**.
- 2 Locate the host name of the server computer, and then double-click the host name.
- 3 Right-click the shared printer name, and then click **Connect**.
- 4 Click **Install driver**.
- 5 Wait until the driver is copied from the server to the client computer. A new printer object will be added to the **Printers** folder. The time taken for these activities varies based on network traffic.
- 6 Print a test page to verify installation.
 - a Click **Start** → **Control Panel**.
 - b Select **Hardware and Sound**.
 - c Select **Printers**.
 - d Right-click the printer you just created and select **Properties**.
 - e On the **General** tab, click **Print Test Page**.
When a test page is printed successfully, installation is complete.

• For Windows 7, Windows 7 64-bit Edition, and Windows Server 2008 R2

- 1 Click **Start** → **Network**.
- 2 Locate the host name of the server computer, and then double-click the host name.
- 3 Right-click the shared printer name, and then click **Connect**.
- 4 Click **Install driver**.
- 5 Wait until the driver is copied from the server to the client computer. A new printer object will be added to the **Devices and Printers** folder. The time taken for these activities varies based on network traffic.
- 6 Print a test page to verify installation.
 - a Click **Start** → **Devices and Printers**.
 - b Right-click the printer you just created and select **Printer properties**.
 - c On the **General** tab, click **Print Test Page**.When a test page is printed successfully, installation is complete.

Peer-to-Peer

If you use the peer-to-peer method, the print driver is installed on each client computer. The client computers can modify the driver and handle the print jobs.

- **For Windows XP, Windows XP 64-bit Edition, Windows Server 2003, and Windows Server 2003 x64 Edition**

- 1 Click **start** (**Start** for Windows Server 2003/Windows Server 2003 x64 Edition) → **Printers and Faxes**.
- 2 Click **Add a printer** (**Add Printer** for Windows Server 2003/Windows Server 2003 x64 Edition) to launch the **Add Printer Wizard**.
- 3 Click **Next**.
- 4 Select **A network printer, or a printer attached to another computer**, and then click **Next**.
- 5 Click **Browse for a printer**, and then click **Next**.
- 6 Select the printer, and then click **Next**. If the printer is not listed, click **Back** and enter in the path of the printer in the text box.

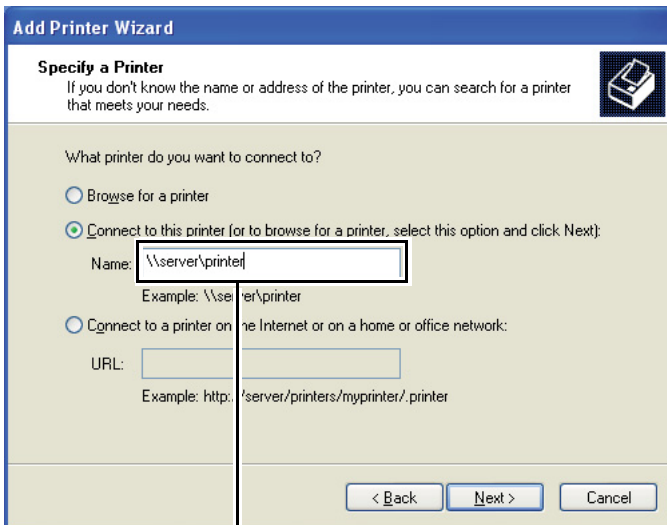

For example: \\<server host name>\<shared printer name>

The server host name is the name of the server computer that identifies it to the network. The shared printer name is the name assigned during the server installation process.

If this is a new printer, you may be prompted to install a print driver. If no system driver is available, specify the location where the driver is available.

- 7 Select **Yes** if you want this printer to be set as the default printer, and then click **Next**.
- 8 Click **Finish**.

• For Windows Vista and Windows Vista 64-bit Edition

- 1 Click **Start** → **Control Panel** → **Hardware and Sound** → **Printers**.
- 2 Click **Add a printer** to launch the **Add Printer** wizard.
- 3 Select **Add a network, wireless or Bluetooth printer**. If the printer is listed, select the printer and click **Next**, or select **The printer that I want isn't listed** and enter in the path of the printer in the **Select a shared printer by name** text box and click **Next**.

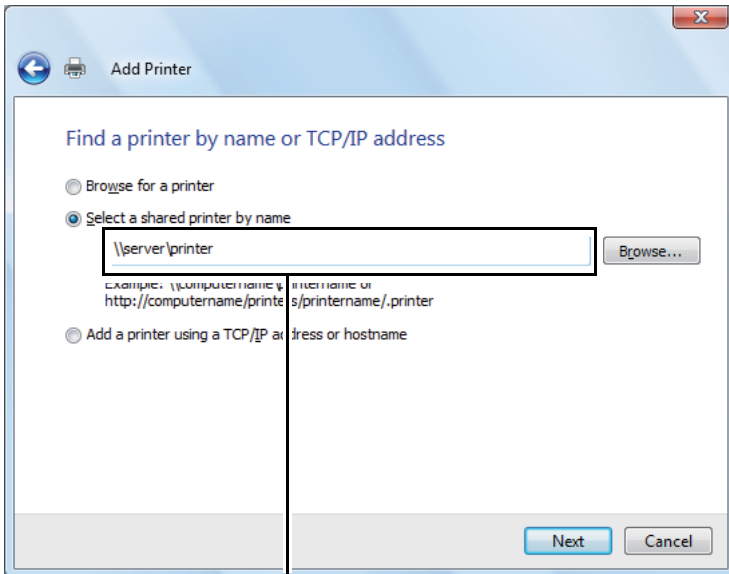

For example: \\<server host name>\<shared printer name>

The server host name is the name of the server computer that identifies it on the network. The shared printer name is the name assigned during the server installation process.

- 4 If this is a new printer, you may be prompted to install a print driver. If no system driver is available, specify the location where the driver is available.
- 5 Confirm the printer name, and then select whether to use this printer as the default printer and click **Next**.
- 6 If you want to verify installation, click **Print a test page**.
- 7 Click **Finish**.

When a test page is printed successfully, installation is complete.

• For Windows Server 2008 and Windows Server 2008 64-bit Edition

- 1 Click **Start** → **Control Panel** → **Hardware and Sound** → **Printers**.
- 2 Click **Add a printer** to launch the **Add Printer** wizard.
- 3 Select **Add a network, wireless or Bluetooth printer**. If the printer is listed, select the printer and click **Next**, or select **The printer that I want isn't listed** and enter in the path of the printer in the **Select a shared printer by name** text box and click **Next**.
For example: \\<server host name>\<shared printer name>
The server host name is the name of the server computer that identifies it on the network. The shared printer name is the name assigned during the server installation process.
- 4 If this is a new printer, you may be prompted to install a print driver. If no system driver is available, specify the location where the driver is available.
- 5 Confirm the printer name, and then select whether to use this printer as the default printer and click **Next**.
- 6 Select whether to share this printer or not.
- 7 If you want to verify installation, click **Print a test page**.
- 8 Click **Finish**.
When a test page is printed successfully, installation is complete.

• For Windows 7, Windows 7 64-bit Edition, and Windows Server 2008 R2

- 1 Click **Start** → **Devices and Printers**.
- 2 Click **Add a printer** to launch the **Add Printer** wizard.
- 3 Select **Add a network, wireless or Bluetooth printer**. If the printer is listed, select the printer and click **Next**, or select **The printer that I want isn't listed**. Click **Select a shared printer by name** and enter in the path of the printer in the text box, and then click **Next**.
For example: \\<server host name>\<shared printer name>
The server host name is the name of the server computer that identifies it to the network. The shared printer name is the name assigned during the server installation process.
- 4 If this is a new printer, you may be prompted to install a print driver. If no system driver is available, you need to specify the path to the available drivers.
- 5 Confirm the printer name, and then click **Next**.
- 6 Select whether to use this printer as the default printer, and then click **Next**.
- 7 If you want to verify installation, click **Print a test page**.
- 8 Click **Finish**.
When a test page is printed successfully, installation is complete.

Installing Print Driver on Computers Running Mac OS X

This section includes:

- ["Installing the Driver" on page 104](#)

■ Installing the Driver

The following procedure uses Mac OS X 10.6 as an example.

- 1 Run the *Software Pack CD-ROM* on the Mac OS X.
- 2 Double-click the **CP205 CP105 Print Installer** icon.
- 3 Click **Continue** on the **Introduction** screen.
- 4 Select a language for the **Software License Agreement**.
- 5 After reading the **Software License Agreement**, click **Continue**.
- 6 If you agree to the terms of the **Software License Agreement**, click **Agree** to continue the installation process.
- 7 Click **Install** to perform the standard installation.
- 8 Enter the administrator's name and password, and then click **OK**.
- 9 Click **Close** to complete installation.

Adding a Printer on Mac OS X 10.5.8/10.6 or Later Version(s)

• When Using a USB connection

- 1 Turn off the printer and your computer.
- 2 Connect the printer and your computer with the USB cable.
- 3 Turn on the printer and your computer.
- 4 Display **System Preferences**, and then click **Print & Fax**.
- 5 Confirm your USB printer is added to **Print & Fax** in **System Preferences**.
If your USB printer is not displayed, execute the following procedures.
- 6 Click the plus (+) sign, and then click **Default**.
- 7 Select the printer connected via USB from the **Printer Name** list.
Name, **Location**, and **Print Using** are automatically entered.
- 8 Click **Add**.

• When Using Bonjour

- 1 Turn on the printer.
- 2 Ensure that your computer is connected to the network.
If you use wired connection, ensure that the Ethernet cable is connected between the printer and the network.
If you use wireless connection, ensure that wireless connection is configured properly on your computer and printer.
- 3 Display **System Preferences**, and then click **Print & Fax**.
- 4 Click the plus (+) sign, and then click **Default**.
- 5 Select the printer connected via Bonjour from the **Printer Name** list.
Name and **Print Using** are automatically entered.
- 6 Click **Add**.

• When Using IP Printing

- 1 Turn on the printer.
- 2 Ensure that your computer is connected to the network.
If you use wired connection, ensure that the Ethernet cable is connected between the printer and the network.
If you use wireless connection, ensure that wireless connection is configured properly on your computer and printer.
- 3 Display **System Preferences**, and then click **Print & Fax**.
- 4 Click the plus (+) sign, and then click **IP**.
- 5 Select **Line Printer Daemon - LPD** for **Protocol**.
- 6 Enter the IP address of the printer in the **Address** area.
- 7 Select the model of your printer for **Print Using**.
NOTE:
 - When the printing is set up using IP printing, the queue name is displayed as blank. You do not need to specify it.
- 8 Click **Add**.

Adding a Printer on Mac OS X 10.4.11

• When Using a USB Connection

- 1 Turn off the printer and your computer.
- 2 Connect the printer and your computer with the USB cable.
- 3 Turn on the printer and your computer.
- 4 Start **Printer Setup Utility**.

NOTE:

- You can find **Printer Setup Utility** in the **Utilities** folder in **Applications**.

- 5 Confirm your USB printer is added to **Printer List**.
If your USB printer is not displayed, execute the following procedures.
- 6 Click **Add**.
- 7 Click **Default Browser** in the **Printer Browser** dialog box.
- 8 Select the printer connected via USB from the **Printer Name** list.
Name, **Location** and **Print Using** are automatically entered.
- 9 Click **Add**.

• When Using Bonjour

- 1 Turn on the printer.
- 2 Ensure that your computer is connected to the network.
If you use wired connection, ensure that the Ethernet cable is connected between the printer and the network.
If you use wireless connection, ensure that wireless connection is configured properly on your computer and printer.

- 3 Start **Printer Setup Utility**.

NOTE:

- You can find **Printer Setup Utility** in the **Utilities** folder in **Applications**.

- 4 Click **Add**.
- 5 Click **Default Browser** in the **Printer Browser** dialog box.
- 6 Select the printer connected via Bonjour from the **Printer Name** list.
Name and **Print Using** are automatically entered.
- 7 Click **Add**.

• When Using IP Printing

1 Turn on the printer.

2 Ensure that your computer is connected to the network.

If you use wired connection, ensure that the Ethernet cable is connected between the printer and the network.

If you use wireless connection, ensure that wireless connection is configured properly on your computer and printer.

3 Start **Printer Setup Utility**.

NOTE:

- You can find **Printer Setup Utility** in the **Utilities** folder in **Applications**.

4 Click **Add**.

5 Click **IP Printer** in the **Printer Browser** dialog box.

6 Select **Line Printer Daemon - LPD** for **Protocol**.

7 Enter the IP address of the printer in the **Address** area.

8 Select **FX** for **Print Using**, and then select the model of your printer.

NOTE:

- When the printing is set up using IP printing, the queue name is displayed as blank. You do not need to specify it.

9 Click **Add**.

Adding a Printer on Mac OS X 10.3.9

• When Using a USB Connection

- 1 Turn off the printer and your computer.
- 2 Connect the printer and your computer with the USB cable.
- 3 Turn on the printer and your computer.
- 4 Start **Printer Setup Utility**.

NOTE:

- You can find **Printer Setup Utility** in the **Utilities** folder in **Applications**.

- 5 Confirm your USB printer is added to **Printer List**.
If your USB printer is not displayed, execute the following procedures.
- 6 Click **Add**.
- 7 Select **USB** from the menu.
- 8 Select the printer from the **Product** list.
Printer Model is automatically selected.
- 9 Click **Add**.

• When Using Rendezvous (Bonjour)

- 1 Turn on the printer.
 - 2 Ensure that your computer is connected to the network.
If you use wired connection, ensure that the Ethernet cable is connected between the printer and the network.

If you use wireless connection, ensure that wireless connection is configured properly on your computer and printer.
 - 3 Start **Printer Setup Utility**.
- #### **NOTE:**
- You can find **Printer Setup Utility** in the **Utilities** folder in **Applications**.
- 4 Click **Add**.
 - 5 Select **Rendezvous** from the menu.
 - 6 Select the printer you want to install from the **Name** list.
Printer Model is automatically selected.
 - 7 Select the printer model from the **Model Name** list.
 - 8 Click **Add**.

• When Using IP Printing

1 Turn on the printer.

2 Ensure that your computer is connected to the network.

If you use wired connection, ensure that the Ethernet cable is connected between the printer and the network.

If you use wireless connection, ensure that wireless connection is configured properly on your computer and printer.

3 Start **Printer Setup Utility**.

NOTE:

- You can find **Printer Setup Utility** in the **Utilities** folder in **Applications**.

4 Click **Add**.

5 Click **IP Printing** from the menu.

6 Select **LPD/LPR** for **Printer Type**.

7 Enter the IP address of the printer in the **Printer Address** area.

8 Select **FX** for **Printer Model**, and then select the model of your printer.

NOTE:

- When the printing is set up using IP printing, the queue name is displayed as blank. You do not need to specify it.

9 Click **Add**.

Printing Basics

This chapter includes:

- ["About Print Media" on page 112](#)
- ["Supported Print Media" on page 116](#)
- ["Loading Print Media" on page 122](#)
- ["Printing" on page 145](#)
- ["Printing with Web Services on Devices \(WSD\)" on page 159](#)

About Print Media

This section includes:

- ["Print Media Usage Guidelines" on page 113](#)
- ["Print Media That Can Damage Your Printer" on page 114](#)
- ["Print Media Storage Guidelines" on page 115](#)

Using paper that is not appropriate for the printer can cause paper jams, image quality problems, or printer failure. To achieve the best performance from your printer, we recommend you to use only the paper described in this section.

When using paper other than that recommended, contact the Fuji Xerox local representative office or an authorised dealer.

■ Print Media Usage Guidelines

The printer tray accommodates most sizes and types of paper and other specialty media. Follow these guidelines when loading paper and media in the tray:

- Envelopes can be printed from the multipurpose feeder (MPF) and priority sheet inserter (PSI).
- Fan paper or other specialty media before loading in the paper tray.
- Do not print on label stock once a label has been removed from a sheet.
- Use only paper envelopes. Do not use envelopes with windows, metal clasps, or adhesives with release strips.
- Print all envelopes single-sided only.
- Some wrinkling and embossing may occur when printing envelopes.
- Do not overload the paper tray. Do not load print media above the fill line on the inside of the paper width guides.
- Adjust the paper width guides to fit the paper size.
- If excessive jams occur, use paper or other media from a new package.



WARNING:

- **Do not use conductive paper such as origami paper, carbonic paper or conductively-coated paper. When paper jam occurs, it may cause short-circuit and eventually a fire accident.**

See also:

- ["Loading Print Media in the Multipurpose Feeder \(MPF\)" on page 125](#)
- ["Loading Print Media in the Priority Sheet Inserter \(PSI\)" on page 134](#)
- ["Loading Envelope in the Multipurpose Feeder \(MPF\)" on page 129](#)
- ["Loading Envelope in the Priority Sheet Inserter \(PSI\)" on page 136](#)
- ["Printing on Custom Size Paper" on page 153](#)

■ Print Media That Can Damage Your Printer

Your printer is designed to use a variety of media types for print jobs. However, some media can cause poor output quality, increased paper jams, or damage to your printer.

Unacceptable media includes:

- Rough or porous media
- Plastic media
- Paper that has been folded or wrinkled
- Paper with staples
- Envelopes with windows or metal clasps
- Padded envelopes
- Non-laser glossy or coated paper
- Perforated media



WARNING:

- **Do not use conductive paper such as origami paper, carbonic paper or conductively-coated paper. When paper jam occurs, it may cause short-circuit and eventually a fire accident.**

■ Print Media Storage Guidelines

Providing good storage conditions for your paper and other media contributes to optimum print quality.

- Store print media in dark, cool, relatively dry locations. Most paper items are susceptible to damage from ultraviolet (UV) and visible light. UV radiation, which is emitted by the sun and fluorescent bulbs, is particularly damaging to paper items. The intensity and length of exposure to visible light on paper items should be reduced as much as possible.
- Maintain constant temperatures and relative humidity.
- Avoid attics, kitchens, garages, and basements for storing print media.
- Store print media flat. Print media should be stored on pallets, cartons, shelves, or in cabinets.
- Avoid having food or drinks in the area where print media is stored or handled.
- Do not open sealed packages of paper until you are ready to load them into the printer. Leave paper in the original packaging. For most commercial cut-size grades, the ream wrapper contains an inner lining that protects the paper from moisture loss or gain.
- Leave the media inside the bag until you are ready to use it; reinsert unused media in the bag and reseal it for protection. Some specialty media is packaged inside resealable plastic bags.

Supported Print Media

Using unsuitable print media may lead to paper jams, poor print quality, breakdown and damage to your printer. To use the features of this printer effectively, use the suggested print media that is recommended here.

IMPORTANT:

- The toner may come off the print media, if it gets wet by water, rain, steam and so on. For details, contact the Fuji Xerox local representative office or an authorized dealer.

■ Usable Print Media

The types of print media that can be used on this printer are as follows:

Multipurpose Feeder (MPF)

Paper Size	A4 SEF (210 × 297 mm) B5 SEF (182 × 257 mm) A5 SEF (148 × 210 mm) Letter SEF (8.5 × 11 inches) Legal SEF (8.5 × 14 inches) Folio SEF (8.5 × 13 inches) Executive SEF (7.25 × 10.5 inches) C5 SEF (162 × 229 mm) Monarch SEF (3.875 × 7.5 inches) Monarch LEF (7.5 × 3.875 inches) ^{*1} # 10 Env SEF (4.125 × 9.5 inches) DL SEF (110 × 220 mm) DL LEF (220 × 110 mm) ^{*1} Yougata 2 SEF (114 × 162 mm) Yougata 2 LEF (162 × 114 mm) ^{*1} Yougata 3 SEF (98 × 148 mm) Yougata 3 LEF (148 × 98 mm) ^{*1} Yougata 4 SEF (105 × 235 mm) Younaga 3 SEF (120 × 235 mm) Nagagata 3 SEF (120 × 235 mm) Postcard SEF (100 × 148 mm) Postcard SEF (148 × 200 mm) Custom Size: Width: 76.2–215.9 mm (3–8.5 inches) ^{*2} Length: 127–355.6 mm (5 –14 inches) ^{*3}
Paper Type (Weight)	Plain Bond Lightweight Cardstock Japanese Glossy Cardstock Lightweight Glossy Cardstock Labels Envelope Recycled Postcard Letterhead Pre-Printed Hole Punched Colored Special Custom Type

Loading Capacity

150 sheets of standard paper

*1 Monarch, DL, Yougata 2, and Yougata 3 envelopes can be supported by LEF with their flap open.

*2 The maximum width is 220 mm for DL LEF.

*3 The minimum length is 3.875 inches for Monarch LEF, 110 mm for DL LEF, 114 mm for Yougata 2 LEF, and 98 mm for Yougata 3 LEF.

Priority Sheet Inserter (PSI)

Paper Size	A4 SEF (210 × 297 mm) B5 SEF (182 × 257 mm) A5 SEF (148 × 210 mm) Letter SEF (8.5 × 11 inches) Legal SEF (8.5 × 14 inches) Folio SEF (8.5 × 13 inches) Executive SEF (7.25 × 10.5 inches) C5 SEF (162 × 229 mm) Monarch SEF (3.875 × 7.5 inches) # 10 Env SEF (4.125 × 9.5 inches) DL SEF (110 × 220 mm) Yougata 4 SEF (105 × 235 mm) Younaga 3 SEF (120 × 235 mm) Nagagata 3 SEF (120 × 235 mm) Postcard SEF (148 × 200 mm) Custom Size: Width: 98.4–215.9 mm (3.875–8.5 inches) Length: 190.5–355.6 mm (7.5 –14 inches)
Paper Type (Weight)	Plain Bond Lightweight Cardstock Japanese Glossy Cardstock Lightweight Glossy Cardstock Labels Envelope Recycled Postcard Letterhead Pre-Printed Hole Punched Colored Special Custom Type
Loading Capacity	10 sheets of standard paper

NOTE:

- SEF and LEF indicate the paper feed direction; SEF stands for short-edge feed. LEF stands for long-edge feed.
- Use only laser print media. Do not use ink jet paper in this printer.

See also:

- ["Loading Print Media in the Multipurpose Feeder \(MPF\)" on page 125](#)
- ["Loading Print Media in the Priority Sheet Inserter \(PSI\)" on page 134](#)

- ["Loading Envelope in the Multipurpose Feeder \(MPF\)" on page 129](#)
- ["Loading Envelope in the Priority Sheet Inserter \(PSI\)" on page 136](#)
- ["Loading Postcard in the Multipurpose Feeder \(MPF\)" on page 132](#)
- ["Loading W-Postcard in the Priority Sheet Inserter \(PSI\)" on page 138](#)
- ["Loading Letterhead in the Multipurpose Feeder \(MPF\)" on page 133](#)
- ["Loading Letterhead in the Priority Sheet Inserter \(PSI\)" on page 139](#)

Printing on print media that differs from the paper size or paper type selected on the print driver may lead to paper jams. To ensure that printing is correctly done, select the correct paper size and paper type.

Loading Print Media

Loading print media properly helps prevent jams and ensures trouble-free printing.

Before loading print media, identify the recommended print side of the print media. This information is usually on the print media package.

NOTE:

- After loading paper in the feeder, specify the same paper type on the print driver.

■ Capacity

Multipurpose feeder (MPF) can hold:

- 150 sheets of standard paper
- 16.2 mm (0.64 inches) of thick paper
- One sheet of coated paper
- 16.2 mm (0.64 inches) of post cards
- Five envelopes
- 16.2 mm (0.64 inches) of labels

Priority sheet inserter (PSI) can hold:

- 10 sheets of standard paper or one sheet of other paper

■ Print Media Dimensions

The MPF accepts print media within the following dimensions:

- Width: 76.2–215.9 mm (3.00–8.50 inches)
- Length: 127–355.6 mm (5.00–14.00 inches)

NOTE:

- The maximum width is 220 mm for DL LEF.
- The minimum length is 3.875 inches for Monarch LEF, 110 mm for DL LEF, 114 mm for Yougata 2 LEF, and 98 mm for Yougata 3 LEF.

The PSI accepts print media within the following dimensions:

- Width: 98.4–215.9 mm (3.875–8.50 inches)
- Length: 190.5–355.6 mm (7.50–14.00 inches)

■ Loading Print Media in the Multipurpose Feeder (MPF)

NOTE:

- To avoid paper jams, do not remove the priority sheet inserter (PSI) while printing is in progress.
- Use only laser print media. Do not use ink jet paper in this printer.

- 1 Open the front cover.

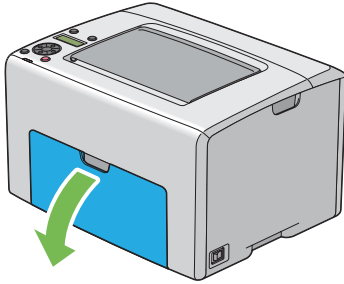

NOTE:

- When you use the MPF for the first time, open the front cover by pulling out the instruction sheet.

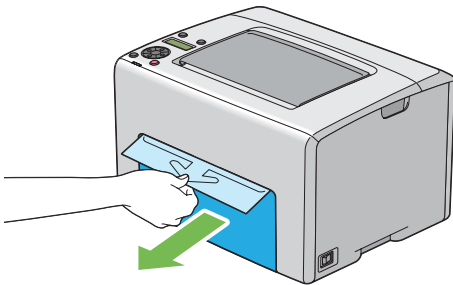

- 2 Pull the PSI out.

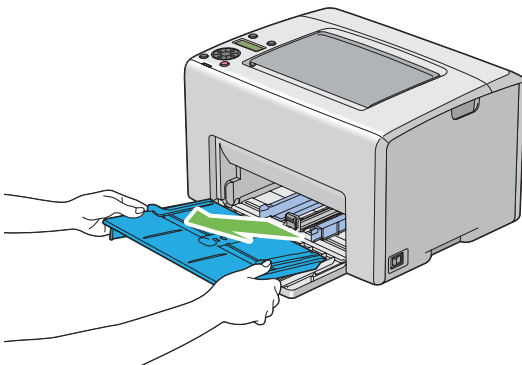

NOTE:

- When you use the MPF for the first time, remove the instruction sheet attached to the PSI with adhesive tape.

- Read the instruction sheet before you use the PSI.

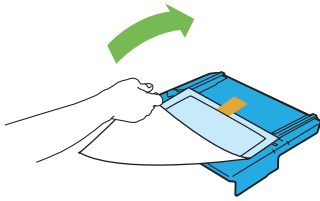

- 3 Pull the slide bar forward until it stops.

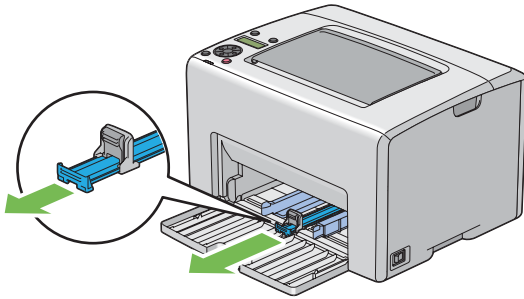

- 4 Pull the length guide forward until it stops.

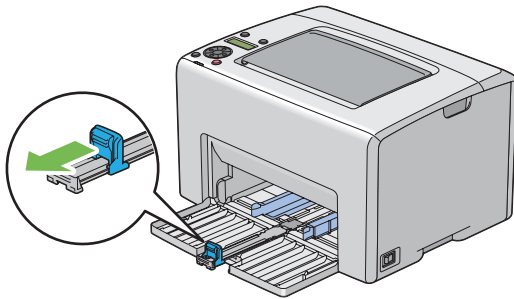

- 5 Adjust the paper width guides to their maximum width.

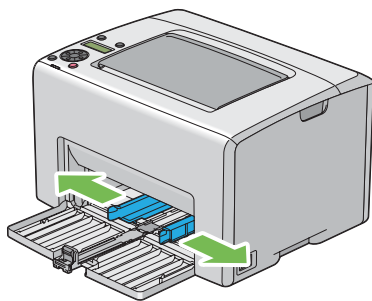

- 6 Before loading the print media, flex the sheets back and forth, and then fan them. Straighten the edges of the stack on a level surface.

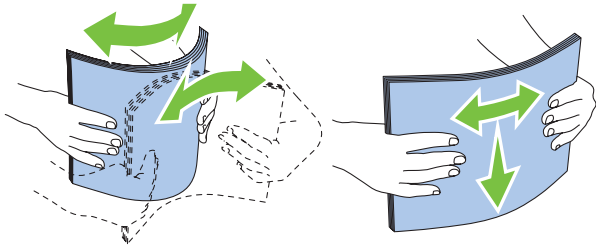

- 7** Load print media on the MPF with the top edge first and with the recommended print side facing up.

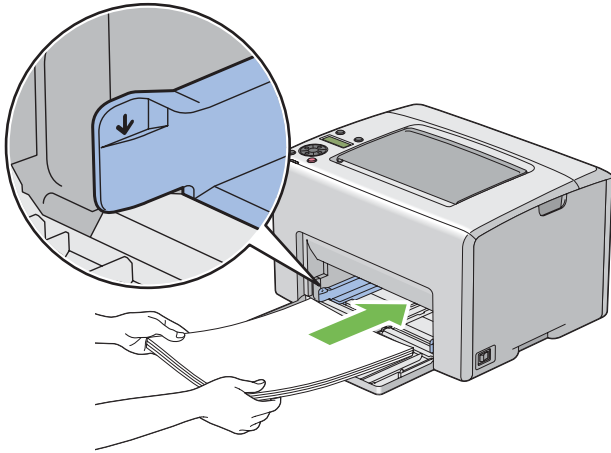

- 8** Adjust the paper width guides until they rest lightly against the edges of the stack of print media.

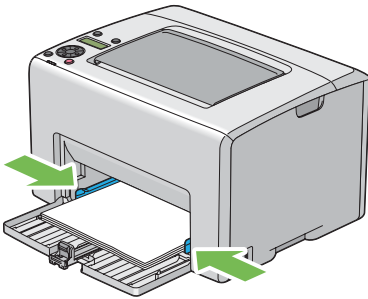

- 9** Slide the length guide towards the printer until it touches the print media.

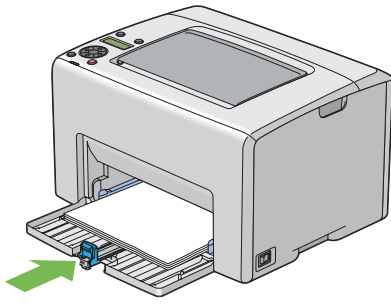

NOTE:

- Depending on the size of print media, first slide the slide bar backward until it stops, and then pinch the length guide and slide it backward until it touches print media.

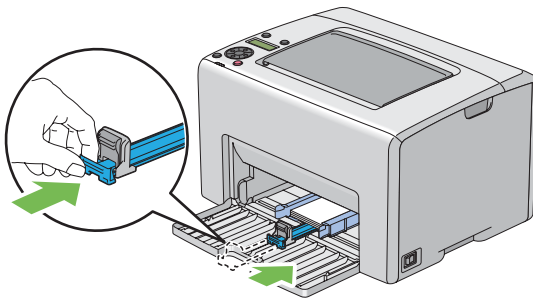

- 10** Insert the PSI into the printer and then align the PSI to the marking on the MPF.

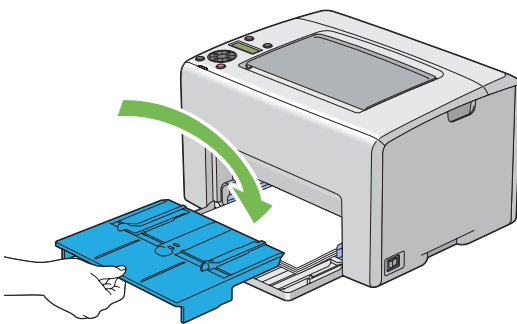

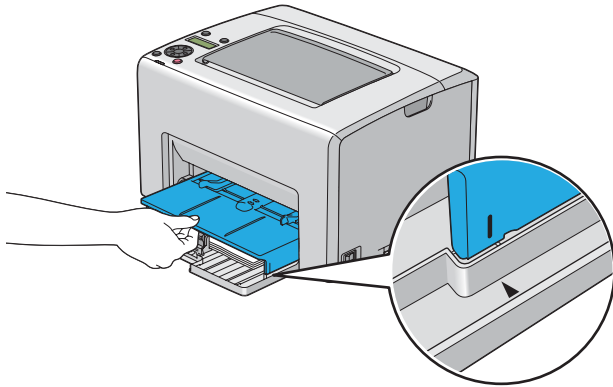

11 Open the output tray extension.

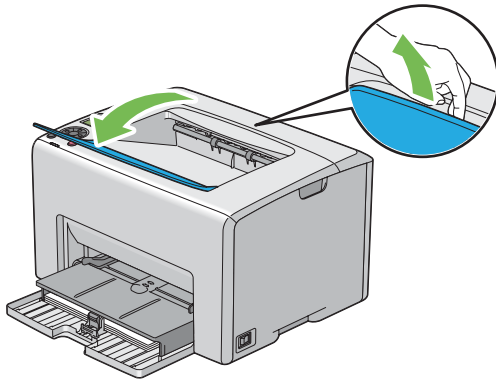

12 Select the paper type from the print driver if the loaded print media is not standard plain paper. If a user-specified print media is loaded in the MPF, you must specify the paper size setting by using the print driver.

NOTE:

- For more information about setting the paper size and type on the print driver, refer to the online Help provided for the print driver.

NOTE:

- For standard-size paper, adjust the guides first and then set paper.

Loading Envelope in the Multipurpose Feeder (MPF)

NOTE:

- When you print on envelopes, be sure to specify the envelope setting on the print driver. If not specified, the print image will be rotated 180 degrees.

• When Loading # 10, DL, Monarch, Yougata 2/3/4, or Younaga 3

Load envelopes with the side to be printed on facing up, the flap side facing down, and the flap turned to the right.

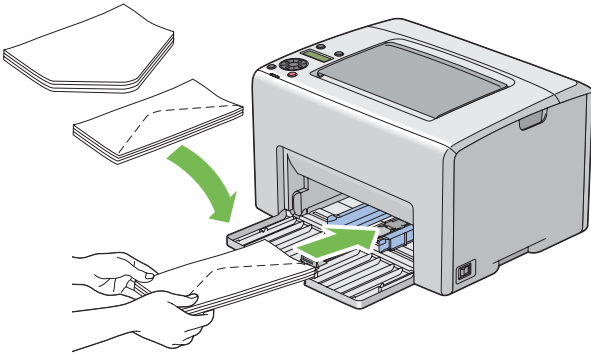

To prevent DL, Monarch, Yougata 2, and Yougata 3 from being wrinkled, they are recommended to be loaded with the print-side facing up, flap opened, and facing you.

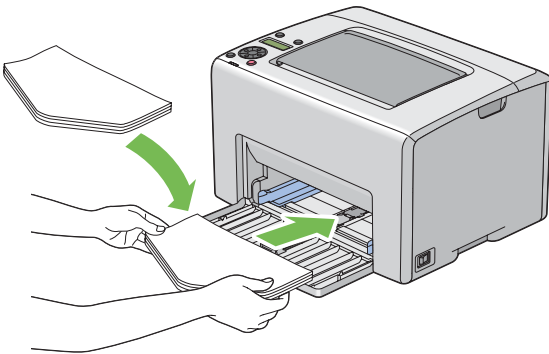

NOTE:

- When you load the envelopes in the long-edge feed (LEF) orientation, be sure to specify the landscape orientation on the print driver.

• When Loading C5 or Nagagata 3

Load envelopes with the side to be printed on facing up, flap opened, and facing you.

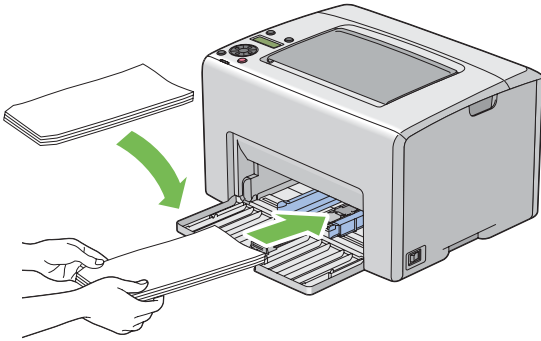

IMPORTANT:

- Never use envelopes with windows, or coated linings. These lead to paper jams and can cause damage to the printer.

NOTE:

- If you do not load envelopes in the MPF right after they have been removed from the packaging, they may bulge. To avoid jams, flatten them as shown below when loading them in the MPF.

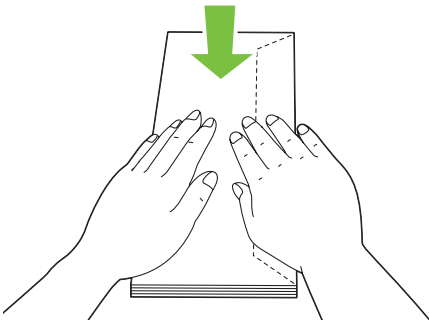

- If envelopes are still not fed correctly, add some bending to the flap of the envelopes as shown in the following illustration. The amount of the bending shall be 5 mm (0.20 inches) or less.

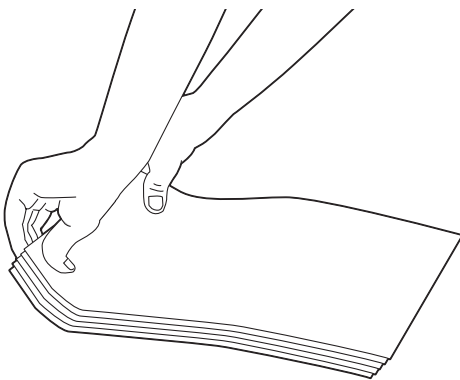

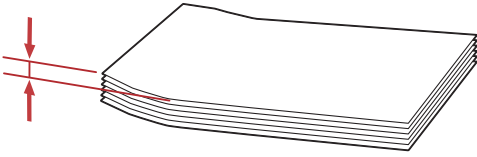

- To confirm the correct orientation of each print media such as envelopes, see the instruction on the Envelope/Paper Setup Navigator on the print driver.

Loading Postcard in the Multipurpose Feeder (MPF)

NOTE:

- When you print on postcards, be sure to specify the postcard setting on the print driver to get the optimum print result.

• When Loading Postcard

Load the postcard with the side to be printed on facing up, and the top edge of the postcard in first.

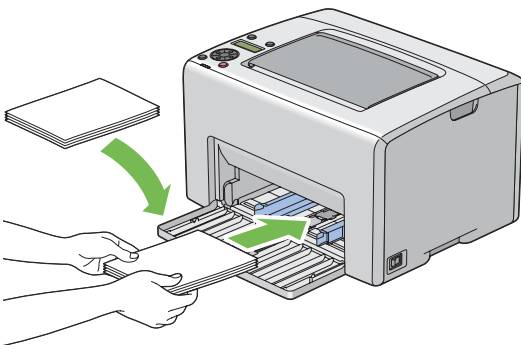

• When Loading W-Postcard

Load the w-postcard with the side to be printed on facing up, and the left edge of the w-postcard in first.

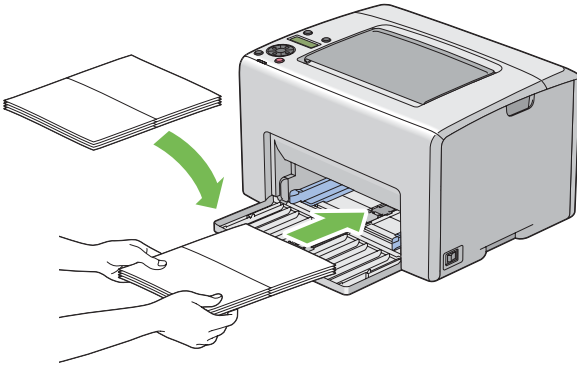

NOTE:

- To confirm the correct orientation of each print media such as postcards, see the instruction on the Envelope/Paper Setup Navigator on the print driver.

Loading Letterhead in the Multipurpose Feeder (MPF)

Load the letterhead in the printer with the print side facing up. Ensure that the title on the letterhead enters the printer first.

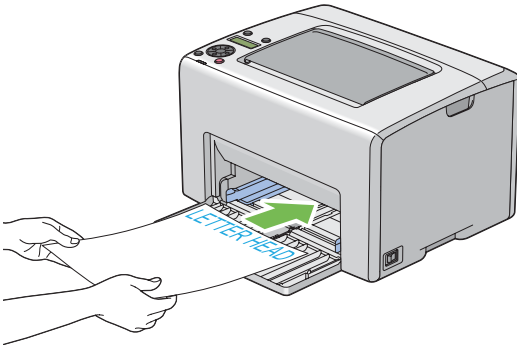

■ Loading Print Media in the Priority Sheet Inserter (PSI)

NOTE:

- To avoid paper jams, do not remove the PSI while printing is in progress.
- Use only laser print media. Do not use ink jet paper in this printer.

- 1 Open the front cover.

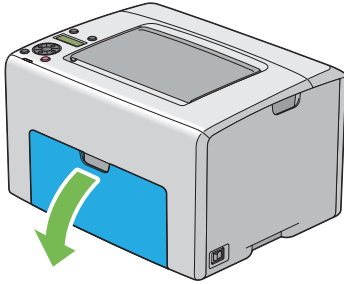

- 2 Slide the PSI forward, and then align the PSI to the marking on the MPF.

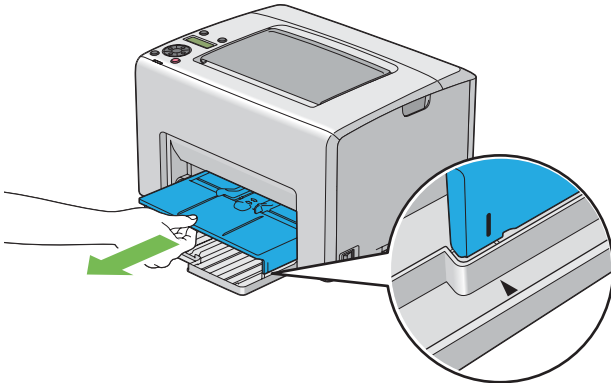

- 3 Adjust the paper width guides to their maximum width.

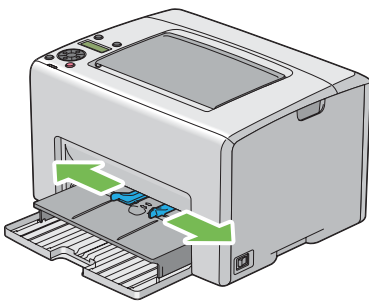

- 4 Before loading the print media, flex the sheets back and forth, and then fan them. Straighten the edges of the stack on a level surface.

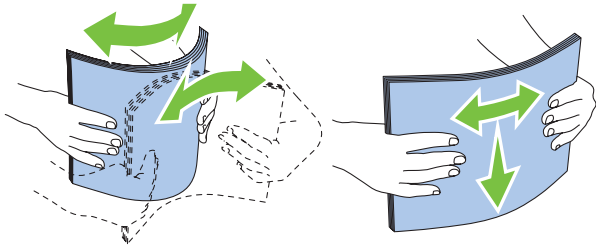

- 5** Load print media on the PSI with the top edge first and with the recommended print side facing up.

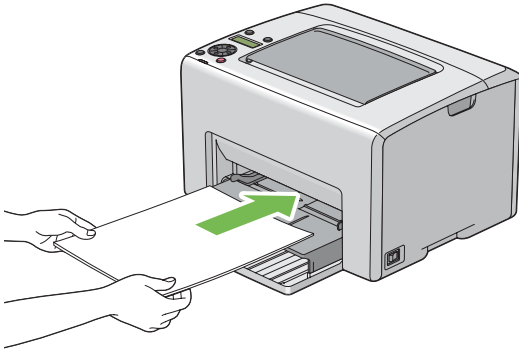

- 6** Adjust the paper width guides until they rest lightly against the edges of the stack of print media.

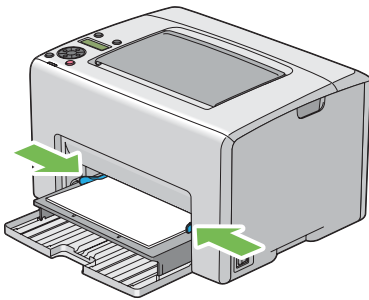

- 7** Open the output tray extension.

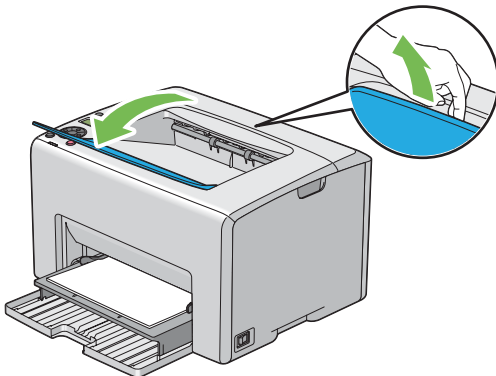

- 8** Select the paper type from the print driver if the loaded print media is not standard plain paper. If

a user-specified print media is loaded in the PSI, you must specify the paper size setting by using the print driver.

NOTE:

- For more information about setting the paper size and type on the print driver, refer to the online Help provided for the print driver.

Loading Envelope in the Priority Sheet Inserter (PSI)

NOTE:

- Be sure to fully insert the envelope until it stops. Otherwise, print media that is loaded on the MPF will be fed.
- When you print on envelopes, be sure to specify the envelope setting on the print driver. If not specified, the print image will be rotated 180 degrees.

• When Loading # 10, DL, Monarch, Yougata 4, or Younaga 3

Load the envelope with the side to be printed on facing up, the flap side facing down, and the flap turned to the right.

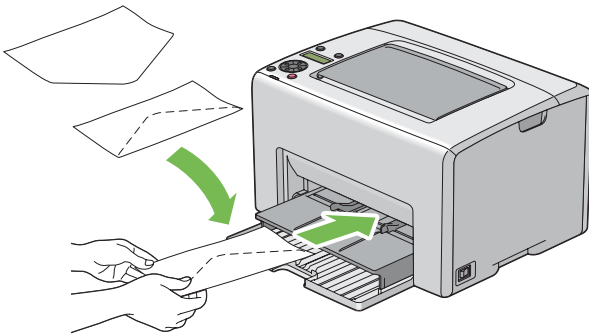

• When Loading C5 or Nagagata 3

Load the envelope with the side to be printed on facing up, flap opened, and facing you.

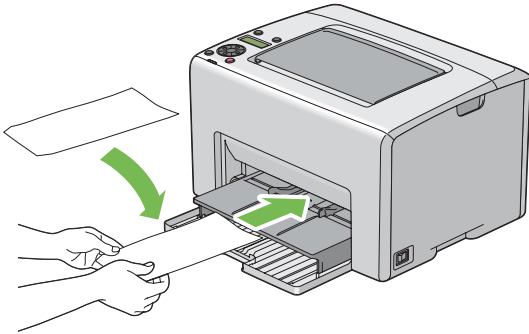

IMPORTANT:

- Never use envelopes with windows, or coated linings. These lead to paper jams and can cause damage to the printer.

NOTE:

- If you do not load envelopes in the PSI right after they have been removed from the packaging, they may bulge. To avoid jams, flatten them as shown below when loading them in the PSI.

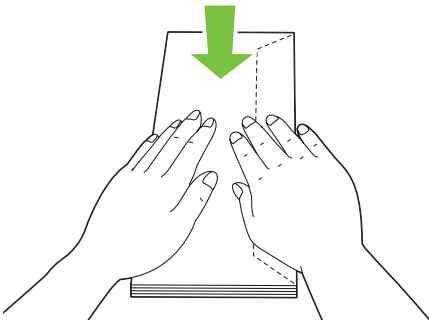

- If envelopes are still not fed correctly, add some bending to the flap of the envelopes as shown in the following illustration. The amount of the bending shall be 5 mm (0.20 inches) or less.

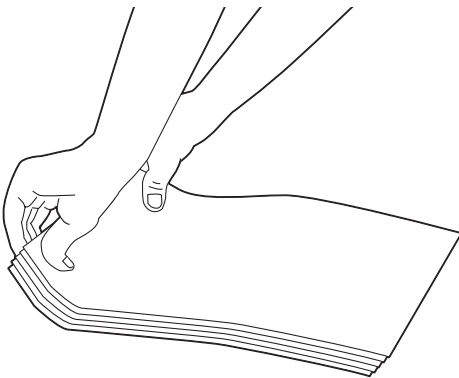

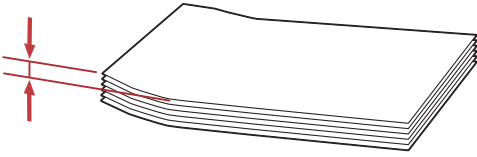

- To confirm the correct orientation of each print media such as envelopes, see the instruction on the Envelope/Paper Setup Navigator on the print driver.

Loading W-Postcard in the Priority Sheet Inserter (PSI)

NOTE:

- When you print on the w-postcard, be sure to specify the w-postcard setting on the print driver to get the optimum print result.

Load the w-postcard with the side to be printed on facing up, and the left edge of the w-postcard in first.

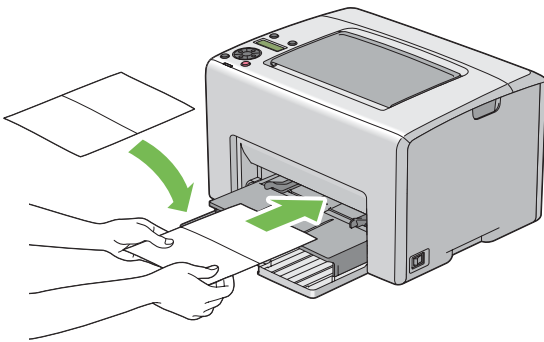

NOTE:

- To confirm the correct orientation of each print media such as w-postcards, see the instruction on the Envelope/Paper Setup Navigator on the print driver.

Loading Letterhead in the Priority Sheet Inserter (PSI)

Load the letterhead in the printer with the print side facing up. Ensure that the title on the letterhead enters the printer first.

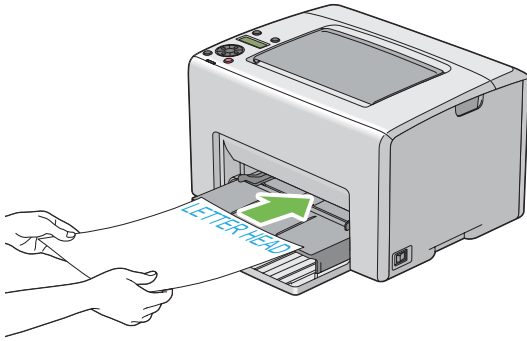

■ Manual Duplex Printing (Windows Print Driver Only)

This section includes:

- ["Operations on Your Computer" on page 141](#)
- ["Loading Print Media in the Multipurpose Feeder \(MPF\)" on page 142](#)
- ["Loading Print Media in the Priority Sheet Inserter \(PSI\)" on page 143](#)

NOTE:

- When printing on curled paper, straighten the paper and then insert it into the feeder.

When you start manual duplex printing, the instruction window appears. Note that the window cannot be reopened once it is closed. Do not close the window until duplex printing is complete.

Manual duplex printing can be done using the multipurpose feeder (MPF) or the priority sheet inserter (PSI).

Operations on Your Computer

The following procedure uses Microsoft® Windows® XP WordPad as an example.

NOTE:

- The way to display the printer **Properties/Printing Preferences** dialog box differs according to the application software. Refer to the manual of your respective application software.

- 1 From the **File** menu, select **Print**.
- 2 Select the printer from the **Select Printer** list box, and then click **Preferences**.
- 3 The **Paper / Output** tab appears.

From **2 Sided Print**, select either **2 Sided**, **Flip on Short Edge** or **2 Sided Print** to define the way 2-sided print pages are bound.

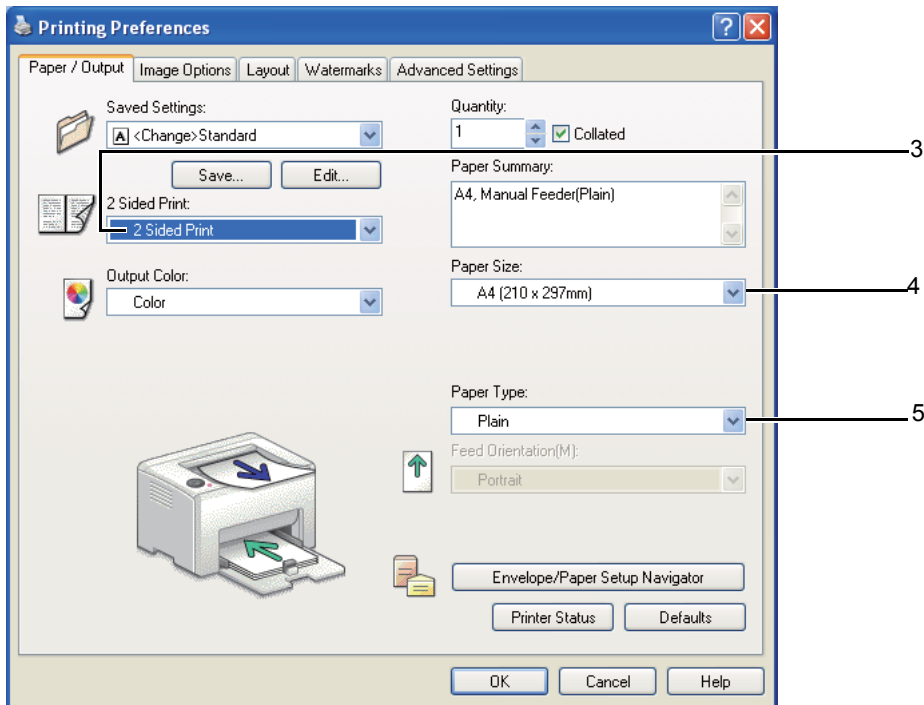

- 4 From **Paper Size**, select the size of the document to be printed.
- 5 From **Paper Type**, select the paper type to be used.
- 6 Click **OK** to close the **Printing Preferences** dialog box.
- 7 Click **Print** in the **Print** dialog box to start printing.

IMPORTANT:

- When you start manual duplex printing, the instruction window appears. Note that the window cannot be reopened once it is closed. Do not close the window until duplex printing is complete.

Loading Print Media in the Multipurpose Feeder (MPF)

- 1 First print the even pages (rear sides).

For a six page document, rear sides are printed in the order of page 6, page 4, then page 2.

The **!** (**Error**) indicator lights and the `Insert Output into paper tray` message appears on the LCD panel when the even pages finish printing.

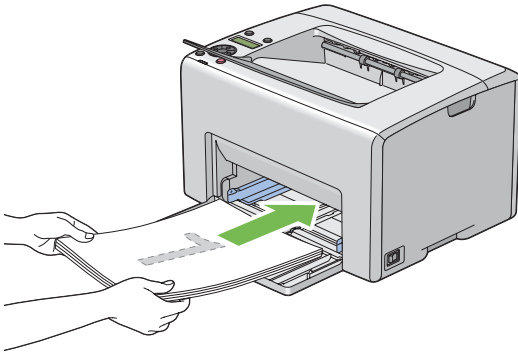

- 2 After the even pages are printed, remove the paper stack from the center output tray.

NOTE:

- Warped or curled prints can cause paper jams. Straighten them before setting them.

- 3 Stack the prints and set them as they are (with the blank side facing up) into the MPF, and then press the **OK** button.

Pages are printed in the order of page 1 (rear of page 2), page 3 (rear of page 4), and then page 5 (rear of page 6).

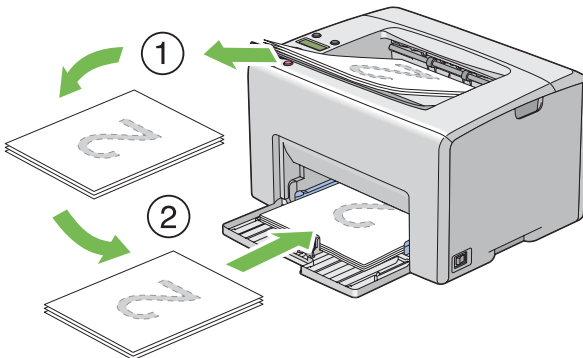

NOTE:

- Printing on both sides of the paper is not possible if the document consists of various sizes of paper.

Loading Print Media in the Priority Sheet Inserter (PSI)

- 1 First print the even pages (rear sides).

For a six page document, even pages are printed in the order page 6, page 4, then page 2.

The **!** (**Error**) indicator lights and the `Insert Output into paper tray` message appears on the LCD panel when the even pages finish printing.

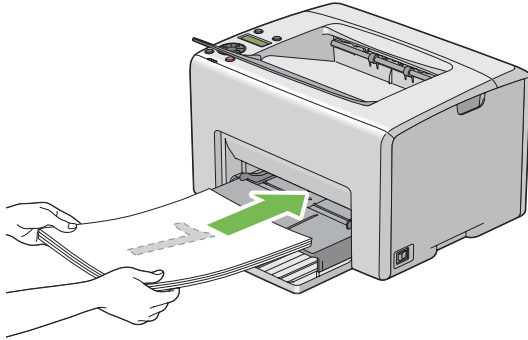

- 2 After the even pages are printed, remove the paper stack from the center output tray.

NOTE:

- Warped or curled prints can cause paper jams. Straighten them before setting them.

- 3 Stack the prints and set them as they are (with the blank side face up) into the PSI, and then press the **OK** button.

Pages are printed in order of page 1 (rear of page 2), page 3 (rear of page 4), and then page 5 (rear of page 6).

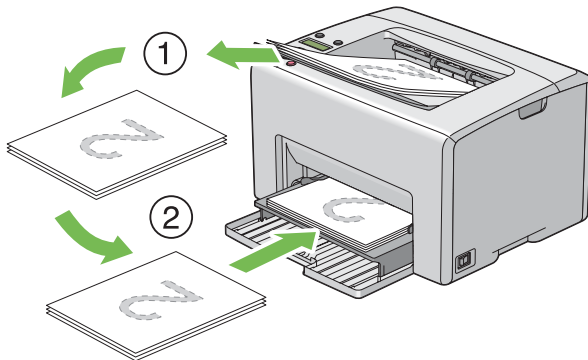

NOTE:

- Printing on both sides of the paper is not possible if the document consists of various sizes of paper.

■ Using the Output Tray Extension

The output tray extension is designed to prevent print media from falling from the printer after the print job is complete.

Before printing a document, ensure that the output tray extension is opened.

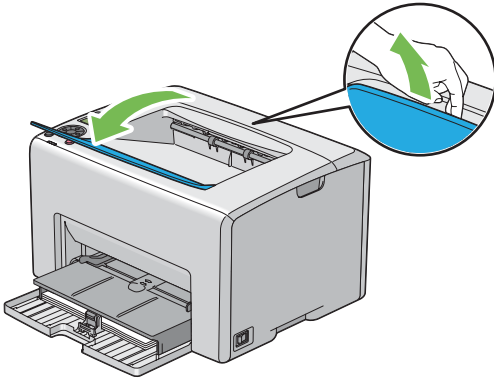

Printing

This section covers how to print certain lists of information from your printer and how to cancel a job.

This section includes:

- ["Sending a Job to Print" on page 146](#)
- ["Canceling a Print Job" on page 147](#)
- ["Selecting Printing Options" on page 148](#)
- ["Printing Custom Size Paper" on page 153](#)
- ["Checking Status of Print Data" on page 155](#)
- ["Printing a Report Page" on page 156](#)
- ["Printer Settings" on page 157](#)

■ Sending a Job to Print

Install the print driver to use all the features of the printer. When you choose **Print** from a software program, a window representing the print driver opens. Select the appropriate settings for the specific job you are sending to print. Print settings selected from the driver have precedence over the default menu settings selected from the operator panel or Printer Setting Utility.

You may need to click **Preferences** from the initial **Print** dialog box to see all the available system settings you can change. If you are not familiar with a feature in the print driver window, open the online Help for more information.

To print a job from a typical Windows application:

- 1 Open the file you want to print.
- 2 From the **File** menu, select **Print**.
- 3 Verify that the correct printer is selected in the dialog box. Modify the system settings as needed (such as the pages you want to print or the number of copies).
- 4 To adjust system settings not available from the first screen, such as **Quantity**, **Paper Size**, or **Feed Orientation**, click **Preferences**.
The **Printing Preferences** dialog box appears.
- 5 Specify the print settings. For more information, click **Help**.
- 6 Click **OK** to close the **Printing Preferences** dialog box.
- 7 Click **Print** to send the job to the selected printer.

■ Canceling a Print Job

There are several methods for canceling a print job.

This section includes:

- ["Canceling From the Operator Panel" on page 147](#)
- ["Canceling a Job From the Computer Running Windows" on page 147](#)

Canceling From the Operator Panel

To cancel a job after it has started printing:

- 1 Press the  (**Cancel Job**) button.

NOTE:

- Printing is canceled only for the current job. All the following jobs will continue to print.

Canceling a Job From the Computer Running Windows

• Canceling a Job From the Taskbar

When you send a job to print, a small printer icon appears in the right corner of the taskbar.

- 1 Double-click the printer icon.
A list of print jobs appears in the printer window.
- 2 Select the job you want to cancel.
- 3 Press the **Delete** key.

• Canceling a Job From the Desktop

- 1 Minimize all programs to reveal the desktop.
Click **start** → **Printers and Faxes** (for Windows XP).
Click **Start** → **Printers and Faxes** (for Windows Server[®] 2003).
Click **Start** → **Devices and Printers** (for Windows 7 and Windows Server 2008 R2).
Click **Start** → **Control Panel** → **Hardware and Sound** → **Printers** (for Windows Vista[®]).
Click **Start** → **Control Panel** → **Printer** (for Windows Server 2008).
A list of available printers appears.
- 2 Double-click the printer you selected when you sent the job.
A list of print jobs appears in the printer window.
- 3 Select the job you want to cancel.
- 4 Press the **Delete** key.

■ Selecting Printing Options

This section includes:

- ["Selecting Printing Preferences \(Windows\)" on page 148](#)
- ["Selecting Options for an Individual Job \(Windows\)" on page 149](#)
- ["Selecting Options for an Individual Job \(Mac OS X\)" on page 151](#)

Selecting Printing Preferences (Windows)

Printer preferences control all of your print jobs, unless you override them specifically for a job. For example, if you want to use duplex printing for most jobs, set this option in printer settings.

To select printer preferences:

- 1** Click **start** → **Printers and Faxes** (for Windows XP).
Click **Start** → **Printers and Faxes** (for Windows Server 2003).
Click **Start** → **Devices and Printers** (for Windows 7 and Windows Server 2008 R2).
Click **Start** → **Control Panel** → **Hardware and Sound** → **Printers** (for Windows Vista).
Click **Start** → **Control Panel** → **Printer** (for Windows Server 2008).
A list of available printers appears.
- 2** Right-click the icon for your printer, and then select **Printing Preferences**.
The **FX DocuPrint CP205/FX DocuPrint CP205 w Printing Preferences** screen appears.
- 3** Make selections on the driver tabs, and then click **OK** to save your selections.

NOTE:

- For more information about Windows print driver options, click **Help** on the print driver tab to view the online Help.

Selecting Options for an Individual Job (Windows)

If you want to use special printing options for a particular job, change the driver settings before sending the job to the printer. For example, if you want to use Photo print-quality mode for a particular graphic, select this setting in the driver before printing that job.

- 1 With the desired document or graphic open in your application, access the **Print** dialog box.
- 2 Select the DocuPrint CP205/CP205 w and click **Preferences** to open the print driver.
- 3 Make selections on the driver tabs. See the following table for specific printing options.

NOTE:

- In Windows, you can save current printing options with a distinctive name and apply them to other print jobs. Make selections on the **Paper / Output**, **Image Options**, **Layout**, **Watermarks**, or **Advanced Settings** tab, and then click **Save** under **Saved Settings** on the **Paper / Output** tab. Click **Help** for more information.

- 4 Click **OK** to save your selections.
- 5 Print the job.

See the following table for specific printing options:

Printing Options for Windows

Operating System	Driver Tab	Printing Options
Windows XP, Windows XP x 64bit, Windows Server 2003, Windows Server 2003 x 64bit, Windows Vista, Windows Vista x 64bit, Windows Server 2008, Windows Server 2008 x 64bit, Windows Server 2008 R2, Windows 7, or Windows 7 x 64bit	Paper / Output tab	<ul style="list-style-type: none"> • Saved Settings • 2 Sided Print • Output Color • Quantity • Collated • Paper Summary • Paper Size • Paper Type • Feed Orientation • Envelope/Paper Setup Navigator • Printer Status • Defaults
	Image Options tab	<ul style="list-style-type: none"> • Output Color • Output Recognition • Image Adjustment Mode • Image Types • Image Auto Correction • Image Settings • Color Balance • Profile Settings • Defaults
	Layout tab	<ul style="list-style-type: none"> • Image Orientation • Multiple-Up • Booklet / Poster / Mixed Document / Rotation • Fit to New Paper Size • Specify Zoom • Image Shift / Print Position • Defaults
Windows XP, Windows Server 2003, Windows Vista, Windows Server 2008, or Windows 7	Watermarks tab	<ul style="list-style-type: none"> • Watermarks <ul style="list-style-type: none"> – New Watermark – Edit Watermark – Delete Watermark – Apply to First Page Only • Annotation • Defaults
Windows XP, Windows XP x 64bit, Windows Server 2003, Windows Server 2003 x 64bit, Windows Vista, Windows Vista x 64bit, Windows Server 2008, Windows Server 2008 x 64bit, Windows Server 2008 R2, Windows 7, or Windows 7 x 64bit	Advanced Settings tab	<ul style="list-style-type: none"> • Skip Blank Pages • Draft Mode • Other Settings (Graphics Settings) <ul style="list-style-type: none"> – Items – Settings for – Paper Tray Selection Method • About • Defaults

Selecting Options for an Individual Job (Mac OS X)

To select print settings for a particular job, change the driver settings before sending the job to the printer.

- 1 With the document open in your application, click **File**, and then click **Print**.
- 2 Select the DocuPrint CP205/CP205 w from **Printer**.
- 3 Select the desired printing options from the menus and drop-down lists that are displayed.

NOTE:

- In Mac OS® X, click **Save As** on the **Presets** menu screen to save the current printer settings. You can create multiple presets and save each with its own distinctive name and printer settings. To print jobs using specific printer settings, click the applicable saved preset in the **Presets** list.

- 4 Click **Print** to print the job.

Mac OS X Print Driver Printing Options:

The table shown below uses Mac OS X 10.6 TextEdit as an example.

Printing options for Mac OS X

Item	Printing Options
	<ul style="list-style-type: none">• Copies• Collated• Pages• Paper Size• Orientation
Layout	<ul style="list-style-type: none">• Pages per Sheet• Layout Direction• Border• Two-Sided
Color Matching	<ul style="list-style-type: none">• ColorSync• Vendor Matching
Paper Handling	<ul style="list-style-type: none">• Pages to Print• Page Order• Destination Paper Size
Cover Page	<ul style="list-style-type: none">• Print Cover Page• Cover Page Type• Billing Info
Scheduler	<ul style="list-style-type: none">• Print Document• Priority
Job Accounting	<ul style="list-style-type: none">• Account Mode
Image Settings	<ul style="list-style-type: none">• Brightness• Contrast• Chroma

Item	Printing Options
Printer Features	<ul style="list-style-type: none">• Basic<ul style="list-style-type: none">– Output Color– Paper Type• Detailed Settings 1<ul style="list-style-type: none">– Image Type– Image Rotation (180deg)– Skip Blank Pages– Draft Mode– Trapping– Image Enhancement• Detailed Settings 2<ul style="list-style-type: none">– Sharpness Adjustment– Screen• Color Balance (C/M/Y/K)<ul style="list-style-type: none">– Low Density– Medium Density– High Density
Summary	

■ Printing Custom Size Paper

This section explains how to print on custom size paper using the print driver.

Custom size paper can be loaded in the multipurpose feeder (MPF) and priority sheet inserter (PSI). The way to load custom size paper in the MPF is the same as the one to load standard size paper. The way to load custom size paper in the PSI is the same as the one to load standard size paper.

See also:

- ["Loading Print Media in the Multipurpose Feeder \(MPF\)" on page 125](#)
- ["Loading Print Media in the Priority Sheet Inserter \(PSI\)" on page 134](#)

Defining Custom Paper Sizes

Before printing, set the custom size on the print driver.

NOTE:

- When setting the paper size on the print driver, be sure to specify the same size as the actual print media used. Setting the wrong size for printing can cause printer failure. This is especially true if you configure a bigger size when using a narrow width paper.

• Using the Windows Print Driver

On the Windows print driver, set the custom size in the **Custom Paper Size** dialog box. This section explains the procedure using Windows XP as an example.

For Windows XP or later, an administrator's password only allows users with administrator rights to change the settings. Users without the rights of administrator can only view the contents.

- 1 Click **start** → **Printers and Faxes**.
- 2 Right-click the icon for your printer, and then select **Properties**.
- 3 Select the **Configuration** tab.
- 4 Click **Custom Paper Size**.
- 5 Select the custom setup you want to define from **Details**.
- 6 Specify the length of the short edge and long edge under **Settings for**. You can specify the values either by entering them directly or using the up arrow and down arrow buttons. The length of the short edge cannot be longer than the long edge, even if it is within the specified range. The length of the long edge cannot be shorter than the short edge, even if it is within the specified range.
- 7 To assign a paper name, select the **Name Paper Size** check box, and then enter the name in **Paper Name**. Up to 14 characters can be used for the paper name.
- 8 If necessary, repeat steps 5 to 7 to define another custom size.
- 9 Click **OK** twice.

Printing on Custom Size Paper

Use the following procedures to print using either the Windows or Mac OS X print drivers.

• Using the Windows Print Driver

This section explains the procedure using Windows XP WordPad as an example.

NOTE:

- The way to display the printer **Properties/Printing Preferences** dialog box differs according to the application software. Refer to the manual of your respective application software.

- 1 From the **File** menu, select **Print**.
- 2 Select the printer as the printer to be used and click **Preferences**.
- 3 Select the **Paper / Output** tab.
- 4 Select the size of the original document from **Paper Size**.
- 5 Select the appropriate paper type from **Paper Type**.
- 6 Click the **Layout** tab.
- 7 From **Fit to New Paper Size**, select the custom size you defined. If you have selected the custom size from **Paper Size** in step 4, select **Same as Paper Size**.
- 8 Click **OK**.
- 9 Click **Print** in the **Print** dialog box to start printing.

• Using the Mac OS X Print Driver

This section explains the procedure using Mac OS X 10.6 TextEdit as an example.

- 1 From the **File** menu, select **Page Setup**.
- 2 Select the printer as the printer to be used from **Format For**.
- 3 From **Paper Size**, select **Manage Custom Sizes**.
- 4 In the **Custom Paper Sizes** window, click **+**.
A newly created setting "Untitled" is displayed in the list.
- 5 Double-click "Untitled" and enter a name for the setting.
- 6 Enter the size of the original document in the **Width** and **Height** boxes of **Paper Size**.
- 7 Specify **Non-Printable Area** if necessary.
- 8 Click **OK**.
- 9 Make sure that the newly created paper size is chosen in **Paper Size**, and then click **OK**.
- 10 From the **File** menu, select **Print**.
- 11 Click **Print** to start printing.

■ Checking Status of Print Data

This section includes:

- ["Checking Status \(Windows Only\)" on page 155](#)
- ["Checking Status in CentreWare Internet Services \(Windows & Mac OS X\)" on page 155](#)

Checking Status (Windows Only)

You can check the printer status with SimpleMonitor. Double-click the SimpleMonitor printer icon on the taskbar at the bottom right of the screen. The **Select Printer** window appears, which displays the printer name, printer connection ports, and printer status. Check the column **Status** to know the current status of your printer.

Status Settings button: Displays the **Status Settings** screen and allows you to modify the SimpleMonitor settings.

Click the name of the desired printer listed on the **Select Printer** window. The **Status Monitor** window appears. You can check the printer status and print job status.

For more information about SimpleMonitor, see Help. The following procedure uses Windows XP as an example:

- 1 Click **start** → **All Programs**.
- 2 Select **Fuji Xerox**.
- 3 Select **SimpleMonitor for Asia-Pacific**.
- 4 Select **SimpleMonitor Help**.

See also:

- ["SimpleMonitor \(Windows Only\)" on page 46](#)

Checking Status in CentreWare Internet Services (Windows & Mac OS X)

You can check the status of the print job sent to the printer at the **Jobs** tab of CentreWare Internet Services.

See also:

- ["Printer Management Software" on page 41](#)

■ Printing a Report Page

You can print a variety of settings for your printer including Printer Settings, Panel Settings, Job History Report, Error History Report, and Demo Page. This section describes two methods of printing a report page.



Printing a Printer Settings Page

To verify detailed printer settings, print a Printer Settings page.

See also:

- ["Understanding the Printer Menus" on page 164](#)

The Operator Panel

- 1 Press the  (**Menu**) button.
- 2 Select `Information Pgs`, and then press the  button.
- 3 Select `Printer Settings`, and then press the  button.
The Printer Settings page is printed.

The Printer Setting Utility

The following procedure uses Windows XP as an example.

- 1 Click **start** → **All Programs** → **Fuji Xerox** → **Fuji Xerox Printer Software for Asia-Pacific** → **FX DocuPrint CP205/FX DocuPrint CP205 w** → **Printer Setting Utility**.

NOTE:

- The **Select Printer** window appears in this step, when multiple print drivers are installed on your computer. In this case, click the name of the desired printer listed in **Printer Name**.

The Printer Setting Utility appears.

- 2 Click the **Printer Settings Report** tab.
- 3 Select **Information Pages** from the list at the left side of the page.
The **Information Pages** page is displayed.
- 4 Click **Printer Settings**.
The Printer Settings page is printed.

■ Printer Settings

This section includes:

- "Using the Operator Panel to Change the Printer Settings" on page 157
- "Using the Printer Setting Utility to Change the Printer Settings" on page 158

Using the Operator Panel to Change the Printer Settings

You can select menu items and corresponding values from the operator panel.

When you first enter the menus from the operator panel, you see an asterisk (*) next to a value in the menus. This asterisk indicates the factory default menu setting. These settings are the original printer settings.





NOTE:

- Factory defaults may vary for different countries.

When you select a new setting from the operator panel, an asterisk appears next to the setting to identify it as the current user default menu setting.

These settings are active until new ones are selected or the factory defaults are restored.



To select a new value as a setting:

- 1 Press the  (**Menu**) button.
- 2 Select `Admin Menu`, and then press the  button.
- 3 Select the desired menu, and then press the  button.
- 4 Select the desired menu or menu item, and then press the  button.
 - If the selection is a menu, the menu is opened and the first menu item in the menu appears.
 - If the selection is a menu item, the default menu setting for the menu item appears.



Each menu item has a list of values for the menu item. A value can be:

- A phrase or word to describe a setting
- A numerical value that can be changed
- An On or Off setting

NOTE:

- Press the  and  button at the same time. This will display the factory default menu settings.

- 5 Select the desired value.
- 6 Press the  button.

This enables the setting value, which is indicated by an asterisk (*) next to the setting value.
- 7 Press the  (**Back**) or  button to return to the previous menu.

To continue setting other items, select the desired menu. To quit setting new values, press the  (**Menu**) button to return to the main screen.

Driver settings may have precedence over changes previously made. In such case, change the defaults of the operator panel.

Using the Printer Setting Utility to Change the Printer Settings

You can select menu items and corresponding values from the Printer Setting Utility.

The following procedure uses Windows XP as an example.

NOTE:

- Factory defaults may vary for different countries.
These settings are active until new ones are selected or the factory defaults are restored.

To select a new value as a setting:

- 1 Click **start** → **All Programs** → **Fuji Xerox** → **Fuji Xerox Printer Software for Asia-Pacific** → **FX DocuPrint CP205/FX DocuPrint CP205 w** → **Printer Setting Utility**.

NOTE:

- The **Select Printer** window appears in this step, when multiple print drivers are installed on your computer. In this case, click the name of the desired printer listed in **Printer Name**.

The Printer Setting Utility appears.

- 2 Click the **Printer Maintenance** tab.

- 3 Select the desired menu item.

Each menu item has a list of values for the menu item. A value can be:

- A phrase or word to describe a setting
- A numerical value that can be changed
- An On or Off setting

- 4 Select the desired value, and then click the associated button with each menu item.

Driver settings may have precedence over changes previously made and may require you to change the Printer Setting Utility defaults.

Printing with Web Services on Devices (WSD)

This section provides information for network printing with WSD, the new Windows Vista, Windows Server 2008, Windows Server 2008 R2, and Windows 7 protocol of Microsoft.

This section includes:

- ["Adding Roles of Print Services" on page 160](#)
- ["Printer Setup" on page 161](#)

■ Adding Roles of Print Services

When you use Windows Server 2008 or Windows Server 2008 R2, you need to add the roles of print services to the Windows Server 2008 or Windows Server 2008 R2 client.

• For Windows Server 2008:

- 1 Click **Start** → **Administrative Tools** → **Server Manager**.
- 2 From the **Action** menu, select **Add Roles**.
- 3 Select the **Print Services** check box on the **Server Roles** window in the **Add Roles Wizard**, and then click **Next**.
- 4 Click **Next**.
- 5 Select the **Print Server** check box, and then click **Next**.
- 6 Click **Install**.

• For Windows Server 2008 R2:

- 1 Click **Start** → **Administrative Tools** → **Server Manager**.
- 2 From the **Action** menu, select **Add Roles**.
- 3 Select the **Print and Document Services** check box on the **Server Roles** window in the **Add Roles Wizard**, and then click **Next**.
- 4 Click **Next**.
- 5 Select the **Print Server** check box, and then click **Next**.
- 6 Click **Install**.

■ Printer Setup

You can install your new printer on the network using the *Software Pack CD-ROM* that shipped with your printer, or using **Add Printer Wizard**.

Installing a Print Driver Using the Add Printer Wizard

- 1 Click **Start** → **Control Panel** → **Hardware and Sound** → **Printers** (**Start** → **Devices and Printers** for Windows Server 2008 R2 and Windows 7).
- 2 Click **Add a printer** to launch the **Add Printer Wizard**.
- 3 Select **Add a network, wireless or Bluetooth printer**.
- 4 In the list of available printers, select the one you want to use, and then click **Next**.

NOTE:

- In the list of available printers, the WSD printer is displayed in the form of **http://IP address/ws/**.
 - If no WSD printer is displayed in the list, enter the printer's IP address manually to create a WSD printer. To enter the printer's IP address manually, follow the instructions below. For Windows Server 2008 R2, to create a WSD printer, you must be a member of Administrators group.
 - 1 Click **The printer that I want isn't listed**.
 - 2 Select **Add a printer using a TCP/IP address or hostname** and click **Next**.
 - 3 Select **Web Services Device** from **Device type**.
 - 4 Enter the printer's IP address in the **Hostname or IP address** text box and click **Next**.
 - Before installing the driver using the **Add Printer** wizard on Windows Server 2008 R2 or Windows 7, perform one of the followings:
 - Establish the Internet connection so that Windows Update can scan your computer.
 - Add the print driver to your computer in advance.
- 5 If prompted, install the print driver on your computer. If you are prompted for an administrator password or confirmation, type the password or provide confirmation.
 - 6 Complete the additional steps in the wizard, and then click **Finish**.
 - 7 Print a test page to verify print installation.
 - a Click **Start** → **Control Panel** → **Hardware and Sound** → **Printers** (**Start** → **Devices and Printers** for Windows Server 2008 R2 and Windows 7).
 - b Right-click the printer you just created, and then click **Properties** (**Printer properties** for Windows Server 2008 R2 and Windows 7).
 - c On the **General** tab, click **Print Test Page**. When a test page is printed successfully, installation is complete.

Using the Operator Panel Menus

This chapter includes:

- ["Understanding the Printer Menus" on page 164](#)
- ["Panel Lock Function" on page 179](#)
- ["Setting the PowerSaver Time Option" on page 182](#)
- ["Resetting to Factory Defaults" on page 183](#)

Understanding the Printer Menus

When your printer is configured as a network printer available to a number of users, the access to the operator panel menus can be limited. This prevents unauthorized users from using the operator panel to inadvertently change the default menu settings that has been set by the administrator. However, you can use settings for individual print jobs using the print driver. Print settings selected from the print driver have precedence over the default menu settings selected from the operator panel.

■ Information Pgs

Use the `Information Pgs` menu to print the settings and history information of your printer.

NOTE:

- A password is required to enter the operator panel menus when `Panel Lock Set` is set to `Enable`. In this case, enter the password you specified, and press the  button.

Printer Settings

Purpose:

To print a list of the information such as the printer name, the status of the printer, and the network settings.

Panel Settings

Purpose:

To print a detailed list of all the settings on the operator panel menus.

Job History

Purpose:

To print a detailed list of the print jobs that have been processed. This list contains the last 10 jobs.

Error History

Purpose:

To print a detailed list of paper jams and fatal errors.

Demo Page

Purpose:

To print a test page.

■ Billing Meters

Use `Billing Meters` to check the total number of printed pages.

NOTE:

- A password is required to enter the operator panel menus when `Panel Lock Set` is set to `Enable`. In this case, enter the password you specified, and press the  button.

Values:

Meter 1	Displays the total number of color prints.
Meter 2	Displays the total number of monochrome prints.
Meter 3	Displays the total number of large size color prints.
Meter 4	Displays the total number of color and monochrome prints (Meter 1 + Meter 2).

■ Admin Menu

Use the `Admin Menu` menu to configure a variety of printer features.

NOTE:

- A password is required to enter the operator panel menus when `Panel Lock Set` is set to `Enable`. In this case, enter the password you specified, and press the  button.

Network Setup

Use the `Network Setup` menu to change the printer settings affecting jobs sent to the printer through the wired or wireless network.

NOTE:

- Values marked by an asterisk (*) are the factory default menu settings.

• Ethernet

Purpose:

To specify the communication speed and the duplex settings of Ethernet. The change becomes effective after the printer is turned off and then on.

Values:

Auto*	Detects the Ethernet settings automatically.
10Base Half	Uses 10base-T half-duplex.
10Base Full	Uses 10base-T full-duplex.
100Base Half	Uses 100base-TX half-duplex.
100Base Full	Uses 100base-TX full-duplex.

NOTE:

- This item is displayed only when the printer is connected with a wired network.

• Wireless Status (DocuPrint CP205 w Only)

Purpose:

To display the information on the wireless signal strength. No changes can be made on the operator panel to improve the status of the wireless connection.

Values:

Good	Indicates good signal strength.
Acceptable	Indicates marginal signal strength.
Low	Indicates insufficient signal strength.
No Reception	Indicates that no signal is received.

NOTE:

- This item is displayed only when the printer is connected with a wireless network.

• Wireless Setup (DocuPrint CP205 w Only)

Purpose:

To configure the wireless network interface.

Values:

Manual Setup	Enter (SSID)	Specify a name to identify the wireless network. Up to 32 alphanumeric characters can be entered.
	Infrastructure	Select when you configure the wireless setting through the access point such as a wireless router.
	No Security	Specify No Security to configure the wireless setting without specifying a security method from WEP, WPA-PSK-TKIP, and WPA2-PSK-AES.
	WEP(64Bit)	Specify the WEP 64bit Key to use through the wireless network. Enter 10 hexadecimal characters.
	Transmit Key	Specify the transmit key from WEP Key 1, WEP Key 2, WEP Key 3, and WEP Key 4.
	WEP(128Bit)	Specify the WEP 128bit Key to use through the wireless network. Enter 26 hexadecimal characters.
	Transmit Key	Specify the transmit key from WEP Key 1, WEP Key 2, WEP Key 3, and WEP Key 4.
	WPA-PSK-TKIP	Select to configure the wireless setting with the security method of WPA-PSK-TKIP.
	PassPhraseEn try	Specify the pass phrase of alphanumeric characters from 8 to 63 only when WPA-PSK-TKIP is selected for Encryption Type.
	WPA2-PSK-AES	Select to configure the wireless setting with the security method of WPA2-PSK-AES.
	PassPhraseEn try	Specify the pass phrase of alphanumeric characters from 8 to 63 only when WPA2-PSK-AES is selected for Encryption Type.
	Ad-hoc	Select to configure the wireless setting without the access point such as a wireless router.
	No Security	Specify No Security to configure the wireless setting without specifying the security method from WEP.
	WEP(64Bit)	Specify the WEP 64bit Key to use through the wireless network. Enter 10 hexadecimal characters.
	Transmit Key	Specify the transmit key from WEP Key 1, WEP Key 2, WEP Key 3, and WEP Key 4.
	WEP(128Bit)	Specify the WEP 128bit Key to use through the wireless network. Enter 26 hexadecimal characters.
	Transmit Key	Specify the transmit key from WEP Key 1, WEP Key 2, WEP Key 3, and WEP Key 4.

WPS	Push Btn. Ctrl	Configures the wireless setting with the security method of WPS-PBC.	
	PIN Code	Start Config.	Configures the wireless setting using the PIN code assigned automatically by the printer.
		Print PIN Code	Prints the PIN code. Confirm it when you enter the PIN code to your computer.

NOTE:

- This item is displayed only when the printer is connected with a wireless network.

• Init Wireless (DocuPrint CP205 w Only)

Purpose:

To initialize wireless network settings. After executing this function and rebooting the printer, all wireless network settings are reset to their factory default values.

NOTE:

- This item is displayed only when the printer is connected with a wireless network.

• TCP/IP

Purpose:

To configure TCP/IP settings. The change becomes effective after the printer is turned off and then on.

Values:

IP Mode	Dual Stack*	Uses both IPv4 and IPv6 to set the IP address.	
	IPv4 Mode	Uses IPv4 to set the IP address.	
	IPv6 Mode	Uses IPv6 to set the IP address.	
IPv4	Get IP Address	DHCP/AutoIP*	Automatically sets the IP address.
		BOOTP	Uses BOOTP to set the IP address.
		RARP	Uses RARP to set the IP address.
		DHCP	Uses DHCP to set the IP address.
		Panel	Enables the IP address entered on the operator panel.
	IP Address	Manually sets the IP address allocated to the printer.	
	Network Mask	Manually sets the subnet mask.	
Gateway Address	Manually sets the gateway address.		

• Protocol

Purpose:

To enable or disable each protocol. The change becomes effective after the printer is turned off and then on.

Values:

LPR	Disable	Disables the Line Printer Daemon (LPR) port.
	Enable*	Enables the LPR port.

Port9100	Disable	Disables the Port9100 port.
	Enable*	Enables the Port9100 port.
WSD	Disable	Disables the WSD port.
	Enable*	Enables the WSD port.
SNMP	Disable	Disables the Simple Network Management Protocol (SNMP) UDP port.
	Enable*	Enables the SNMP UDP port.
Email Alerts	Disable	Disables the Email Alerts feature.
	Enable*	Enables the Email Alerts feature.
InternetServices	Disable	Disables an access to CentreWare Internet Services embedded in the printer.
	Enable*	Enables an access to CentreWare Internet Services embedded in the printer.
Bonjour (mDNS)	Disable	Disables the Bonjour (mDNS).
	Enable*	Enables the Bonjour (mDNS).

• Host Access List

Purpose:

To control the access from the specified IP addresses. The change becomes effective after the printer is turned off and then on.

Values:

No.1-5/Address	Specifies the IP address which you want to control the access to your printer.	
No.1-5/Mask	Sets the subnet mask for the specified IP address.	
No.1-5/Mode	OFF*	Selects whether to accept or reject the access from the specified IP address.
	Accept	
	Reject	

• Reset Defaults

Purpose:

To initialize wired network data stored in Non-Volatile Memory (NVM). After executing this function and rebooting the printer, all wired network settings are reset to their default values.

• Wireless LAN (DocuPrint CP205 w Only)

Purpose:

To enable the wireless connection.

Values:

Enable*	Enables the wireless connection.
Disable	Disables the wireless connection.

USB Setup

Use the `USB Setup` menu to change printer settings affecting a USB port.

NOTE:

- Values marked by an asterisk (*) are the factory default menu settings.

• Port Status

Purpose:

To change the USB settings on your printer. The change becomes effective after the printer is turned off and then on.

Values:

Disable	Disables the USB interface.
Enable*	Enables the USB interface.

System Setup

Use the `System Setup` menu to configure the power saving mode, time-out time, job log auto print, mm/inch setting, default paper size setting, and low toner alert setting.

NOTE:

- Values marked by an asterisk (*) are the factory default menu settings.

• PowerSaver Time

Purpose:

To specify the time for transition to Power Saver Mode.

Values:

Mode1	5min.*	Specifies the time taken by the printer before it enters Mode1 after it finishes a job.
	5–30min.	
Mode2	6min.*	Specifies the time taken by the printer before it enters Mode2 after it goes into Mode1.
	1–6min.	

Enter **5** in `Mode 1` to put the printer in Mode1 five minutes after it finishes a job. This uses less energy, but requires more warm-up time for the printer. Enter **5** if your printer shares an electrical circuit with room lighting and you notice lights flickering.

Select a high value if your printer is in constant use. In most circumstances, this keeps the printer ready to operate with minimum warm-up time. Select a value between 5 and 30 minutes for Mode1 if you want a balance between energy consumption and a shorter warm-up period.

The printer automatically returns to the standby mode from the Power Saver Mode when it receives data from the computer. In Mode1, you can also return the printer to the standby mode by pressing any button on the operator panel. In Mode2, you can return the printer to the standby mode by pressing the  (**Energy Saver**) button.

• Fault Time-Out

Purpose:

To specify the time taken by the printer before it cancels jobs that stop abnormally. The print job is cancelled if it times out.

Values:

Off		Disables the fault time-out.
On	60sec.* 3–300sec.	Specifies the time taken by the printer before it cancels for jobs that stop abnormally.

• Time-Out

Purpose:

To specify the amount of time that the printer waits for data to arrive from the computer. The print job is cancelled if it times out.

Values:

Off		Disables the job time-out.
On	30sec.* 5–300sec.	Specifies the amount of time that the printer waits for data to arrive from the computer.

• Auto Log Print

Purpose:

To automatically print a job history report after every 10 jobs.

Values:

Off*	Does not automatically print a job history report.
On	Automatically prints a job history report.

NOTE:

- The Job History report can also be printed using the `Information Pgs` menu.

• mm/ inch

Purpose:

To specify the measurement unit displayed after the numeric value on the operator panel.

Values:

millimeter (mm)*	Specifies the default measurement unit.
inch (")	

• Def. Paper Size

Purpose:

To specify the default paper size.

Values:

A4 - 210x297*

Letter - 8.5x11

• Low Toner Msg

Purpose:

To specify whether to show the alert message when the toner is low.

Values:

Off Does not show the alert message when the toner is low.

On* Shows the alert message when the toner is low.

Maintenance Mode

Use the `Maintenance Mode` menu to initialize Non-Volatile Memory (NVM), configure the plain paper quality adjustment settings, and configure the security settings.

NOTE:

- Values marked by an asterisk (*) are the factory default menu settings.

• F/W Version

Purpose:

To display the version of the controller.

• Adjust PaperType

Purpose:

To adjust the paper type.

Values:

Plain

Light

Normal*

Labels

Light

Normal*

• Adjust BTR

Purpose:

To specify the optimum voltage settings for printing for the transfer roller (BTR). To lower the voltage, set negative values. To increase, set positive values.

The default settings may not give the best output on all paper types. If you see mottles on the print output, try to increase the voltage. If you see white spots on the print output, try to decrease the voltage.

NOTE:

- The print quality changes depending on the values you select for this item.

Values:

Plain	0*
	-3 – +3
Bond	0*
	-3 – +3
Light Card	0*
	-3 – +3
Labels	0*
	-3 – +3
JP Gloss Card	0*
	-3 – +3
LW Gloss Card	0*
	-3 – +3
Envelope	0*
	-3 – +3
Recycled	0*
	-3 – +3
Postcard	0*
	-3 – +3

• Adj. Fusing Unit

Purpose:

To specify the optimum temperature settings for printing for the fusing unit. To lower the temperature, set negative values. To increase, set positive values.

The default settings may not give the best output on all paper types. When the printed paper has curled, try to lower the temperature. When the toner does not fuse on the paper properly, try to increase the temperature.

NOTE:

- The print quality changes depending on the values you select for this item.

Values:

Plain	0*
	-3 – +3

Bond	0*
	-3 – +3
Light Card	0*
	-3 – +3
Labels	0*
	-3 – +3
JP Gloss Card	0*
	-3 – +3
LW Gloss Card	0*
	-3 – +3
Envelope	0*
	-3 – +3
Recycled	0*
	-3 – +3
Postcard	0*
	-3 – +3

• Auto Regi Adj

Purpose:

To specify whether to automatically adjust color registration.

Values:

Off	Does not automatically adjust color registration.
On*	Automatically adjusts color registration.

• Adjust ColorRegi

Purpose:

To specify whether to manually adjust color registration.

Color registration adjustments need to be made during the initial setup of the printer or when the printer is moved to a different location.

Values:

Auto Adjust	Automatically corrects color registration.
Color Regi Chart	Prints a color registration chart. The color registration chart prints a lattice pattern of yellow, magenta, and cyan lines. On the chart, find the values on the right side that are next to the line that is perfectly straight for each of the three colors. If the value for this line is 0, color registration is not needed. If the value for this line is any value other than 0, specify the adjustment values under Enter Number .

Enter Number	Enter (Y,M,C)	0, 0, 0* -5 – +5	Specifies lateral (perpendicular to paper feed direction) color adjustment values individually for Y (Yellow), M (Magenta) and C (Cyan).
	Enter (LY,LM,L C)	0, 0, 0* -5 – +5	Specifies process (paper feed direction) color adjustment values individually for LY (Left Yellow), LM (Left Magenta) and LC (Left Cyan).
	Enter (RY,RM, RC)	0, 0, 0* -5 – +5	Specifies process (paper feed direction) color adjustment values individually for RY (Right Yellow), RM (Right Magenta) and RC (Right Cyan).

• Clear Developer

Purpose:

To rotate the developer motor and stir the toner in the toner cartridge.

• Toner Refresh

Purpose:

To use up a toner cartridge when you need to replace it before the end of its life, or to stir the toner in a new toner cartridge.

Values:

Yellow	Cleans the toner in the yellow toner cartridge.
Magenta	Cleans the toner in the magenta toner cartridge.
Cyan	Cleans the toner in the cyan toner cartridge.
Black	Cleans the toner in the black toner cartridge.

• BTR Refresh

Purpose:

Specify whether to execute counter measures for curling/separating discharge of the paper.

Values:

Off*	Does not automatically execute counter measures for curling/separating discharge of the paper.
On	Automatically executes counter measures for curling/separating discharge of the paper.

• Chart

Purpose:

To print various charts that can be used for diagnosing your printer.

Values:

Ghost	Prints a chart to check for ghost printing.
4Colors	Prints bands of yellow, magenta, cyan, and black with varying density.
Alignment	Prints a chart, and then check for proper alignment of the print image on the paper.
Drum Refresh	Prints a chart to check the light fatigue of the drum cartridge.

• Initialize NVM

Purpose:

To initialize NVM for system parameters. After executing this function and rebooting the printer, all the menu parameters, except the parameters for the network, are reset to their factory default values.

See also:

- ["Resetting to Factory Defaults" on page 183](#)

• Non-GenuineToner

Purpose:

To use toner cartridge of another manufacturer.

NOTE:

- Using non-genuine toner cartridges may make some printer features unusable, reduce print quality and decrease the reliability of your printer. Fuji Xerox recommends only new Fuji Xerox brand toner cartridges for your printer. Fuji Xerox does not provide warranty coverage for problems caused by using accessories, parts, or components not supplied by Fuji Xerox.
- Before you use toner cartridge of another manufacturer, be sure to restart the printer.

Values

Off*	Does not use toner cartridge of another manufacturer.
On	Uses toner cartridge of another manufacturer.

• Adjust Altitude

Purpose:

To specify the altitude of the location where the printer is installed.

The discharge phenomenon for charging the photo conductor varies with barometric pressure.

Adjustments are performed by specifying the altitude of the location where the printer is being used.

NOTE:

- An incorrect altitude adjustment setting leads to poor printing quality, incorrect indication of remaining toner.

Values:

0m*	Specifies the altitude of the location where the printer is installed.
1000m	
2000m	
3000m	

Secure Settings

Use the `Secure Settings` menu to set a password to limit access to the menus. This prevents items from being changed accidentally.

NOTE:

- Values marked by an asterisk (*) are the factory default menu settings.

• Panel Lock

Panel Lock Set

Purpose:

To restrict access to the operator panel menus.

See also:

- ["Panel Lock Function" on page 179](#)

Values:

Disable*	Does not restrict access to the operator panel menus.
Enable	Restricts access to the operator panel menus with a password.
New Password	Sets a password required to access the operator panel menus.
Re-enter	Enters the new password again to confirm.

Change Password

Purpose:

To change a password to limit access to the operator panel menus.

Values:

Current Password	Enter the current password to change the password.
New Password	Enter the new password.
Re-enter	Enter the new password again to confirm.

NOTE:

- This item is displayed only when `Panel Lock Set` is set to `Enable`.

• Login Error

Purpose:

To set the maximum number of failed login attempts before an administrator is denied access to the operator panel menus.

Values:

Off*	Does not set the maximum number of failed login attempts.
On	5times 1 - 10









Panel Lock Function

This feature prevents unauthorized users from changing settings made by the administrator. However, you can select settings for individual print jobs using the print driver.









This section includes:

- ["Enabling the Panel Lock" on page 180](#)
- ["Disabling the Panel Lock" on page 181](#)









■ Enabling the Panel Lock

- 1 Press the  (**Menu**) button.
- 2 Select `Admin Menu`, and then press the  button.
- 3 Select `Secure Settings`, and then press the  button.
- 4 Select `Panel Lock`, and then press the  button.
- 5 Select `Panel Lock Set`, and then press the  button.
- 6 Select `Enable`, and then press the  button.
- 7 Enter the new password, and then press the  button.
- 8 Re-enter the password to confirm the password that you entered, and then press the  button.

NOTE:









- If you forget your password, turn off the printer. Then, while holding the  (**Menu**) button, turn on the printer. Continue to hold the  (**Menu**) button until the display indicates to enter the new password. Release the  (**Menu**) button and enter the new password, and then press the  button. Re-enter the password to confirm, and then press the  button. The display will briefly indicate the password has been changed.
- If you change the password, perform steps 1. Enter the current password, and then press the  button. Perform steps 2 to 4. Select `Change Password`, and then press the  button. Enter the current password, and then press the  button. Perform steps 7 and 8. This will change the password.

■ Disabling the Panel Lock

- 1 Press the  (**Menu**) button.
- 2 Enter the password, and then press the  button.
- 3 Select `Admin Menu`, and then press the  button.
- 4 Select `Secure Settings`, and then press the  button.
- 5 Select `Panel Lock`, and then press the  button.
- 6 Select `Panel Lock Set`, and then press the  button.
- 7 Select `Disable`, and then press the  button.
- 8 Enter the current password, and then press the  button.





Setting the PowerSaver Time Option

You can set the power saver time for the printer. The printer switches to the Power Saver Mode after the specified time.

- 1 Press the  (**Menu**) button.
- 2 Select `Admin Menu`, and then press the  button.
- 3 Select `System Setup`, and then press the  button.
- 4 Select `PowerSaver Time`, and then press the  button.
- 5 Select `Mode 1` or `Mode 2`, and then press the  button.
- 6 Press the  or  button to select the desired value, and then press the  button.
You can select from 5–30 minutes for `Mode 1` or 1–6 minutes for `Mode 2`.
- 7 To return to the previous screen, press the  (**Back**) button.

Resetting to Factory Defaults

After executing `Initialize NVM` and rebooting the printer, all the menu parameters or data, except the parameters for the network are reset to their factory default values.

- 1 Press the  (**Menu**) button.
- 2 Select `Admin Menu`, and then press the  button.
- 3 Select `Maintenance Mode`, and then press the  button.
- 4 Select `Initialize NVM`, and then press the  button.
- 5 Ensure that `Are you sure?` appears, and then press the  button. The printer starts initializing the Non-Volatile Memory (NVM).
- 6 When the `Initialized.` message appears, turn off and then on the printer to apply the settings.

Troubleshooting

This chapter includes:

- "Clearing Jams" on page 186
- "Basic Printer Problems" on page 195
- "Display Problems" on page 196
- "Printing Problems" on page 197
- "Print Quality Problems" on page 199
- "Adjusting Color Registration" on page 216
- "Noise" on page 222
- "Other Problems" on page 223
- "Understanding Printer Messages" on page 224
- "Contacting Service" on page 228
- "Getting Help" on page 229
- "Non Genuine Toner Mode" on page 233

Clearing Jams

This section includes:

- ["Avoiding Jams" on page 187](#)
- ["Identifying the Location of Paper Jams" on page 188](#)
- ["Clearing Paper Jams From the Front of the Printer" on page 189](#)
- ["Clearing Paper Jams From the Back of the Printer" on page 190](#)
- ["Clearing Paper Jams From the Center Output Tray" on page 192](#)
- ["Jam Problems" on page 194](#)

Careful selection of appropriate print media and proper loading allow you to avoid most jams.

See also:

- ["About Print Media" on page 112](#)
- ["Supported Print Media" on page 116](#)

NOTE:

- Before buying large quantities of any print media, it is recommended that you try a sample first.

■ Avoiding Jams

- Use only recommended print media.
- See ["Loading Print Media in the Multipurpose Feeder \(MPF\)" on page 125](#) and ["Loading Print Media in the Priority Sheet Inserter \(PSI\)" on page 134](#) to load print media properly.
- Do not overload the print media sources. Ensure that the stacked print media does not exceed the maximum height indicated on the paper width guides.
- Do not load wrinkled, creased, damp, or curled print media.
- Flex, fan, and straighten print media before you load it. If a jam occurs with print media, try feeding one sheet at a time through the MPF or the PSI.
- Do not use print media that you have cut or trimmed.
- Do not mix print media sizes, weights, or types in the same print media source.
- Ensure that the recommended print side is face up when you insert the print media.
- Keep print media stored in an acceptable environment.
- Do not remove the PSI during a print job.
- Ensure that all cables that connect to the printer are correctly attached.
- Overtightening the guides may cause jams.

See also:

- ["About Print Media" on page 112](#)
- ["Supported Print Media" on page 116](#)
- ["Print Media Storage Guidelines" on page 115](#)

■ Identifying the Location of Paper Jams

CAUTION:

- Do not attempt to remove a paper jammed deeply inside the product, particularly a paper wrapped around a Fusing Unit or a heat roller. Otherwise, it may cause injuries or burns. Switch off the product promptly and contact your local Fuji Xerox representative.

IMPORTANT:

- Do not attempt to clear any jams using tools or instruments. This may permanently damage the printer.

The following illustration shows where paper jams may occur along the print media path.

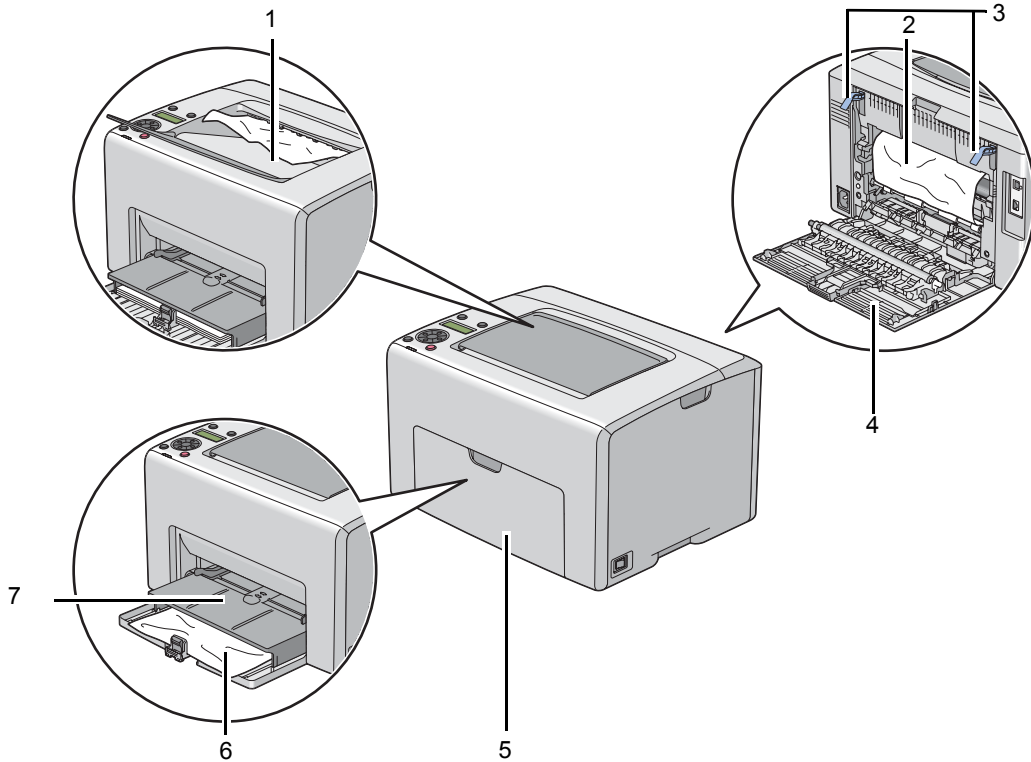

1 Center Output Tray

2 Transfer Belt

3 Levers

4 Rear Door

5 Front Cover

6 Multipurpose feeder (MPF)

7 Priority Sheet Inserter (PSI)

■ Clearing Paper Jams From the Front of the Printer

NOTE:

- To resolve the error displayed on the LCD panel, you must clear all print media from the print media path.

- 1 Pull the PSI out.

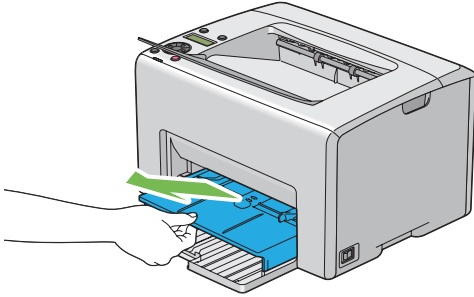

- 2 Remove any paper jammed from the front of the printer.

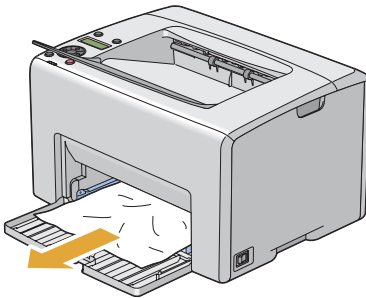

- 3 Replace the PSI in the printer.

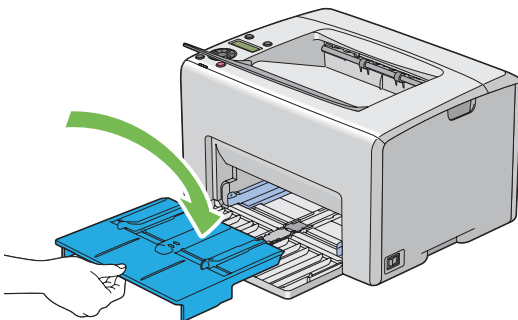

IMPORTANT:

- Do not use excessive force on the PSI. Doing so could damage it or the inside of the printer.

■ Clearing Paper Jams From the Back of the Printer

IMPORTANT:

- To prevent electric shock, always turn off the printer and disconnect the power cord from the grounded outlet before performing maintenance.
- To avoid burns, do not clear paper jams immediately after printing. The fusing unit becomes extremely hot during use.

NOTE:

- To resolve the error displayed on the LCD panel, you must clear all print media from the print media path.

- 1 Push the rear cover handle and open the rear door.

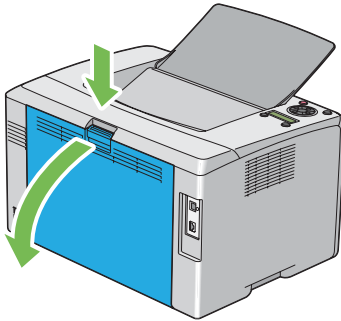

- 2 Lift up the levers.

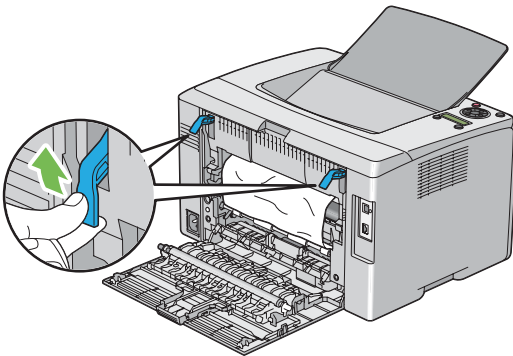

- 3 Remove any paper jammed from the back of the printer.

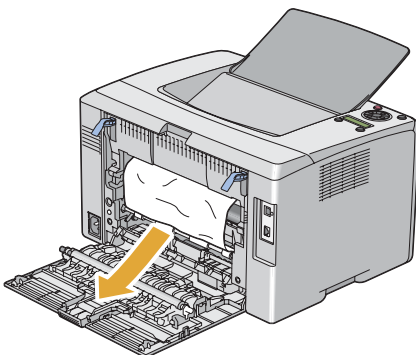

4 Lower the levers to their original position.

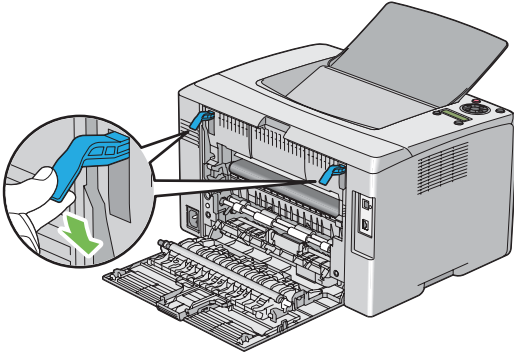

5 Close the rear door.

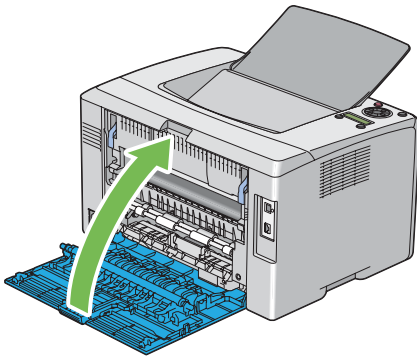

■ Clearing Paper Jams From the Center Output Tray

IMPORTANT:

- To prevent electric shock, always turn off the printer and disconnect the power cord from the grounded outlet before performing maintenance.
- To avoid burns, do not clear paper jams immediately after printing. The fusing unit becomes extremely hot during use.

NOTE:

- To resolve the error displayed on the LCD panel, you must clear all print media from the print media path.

- 1 Push the rear cover handle and open the rear door.

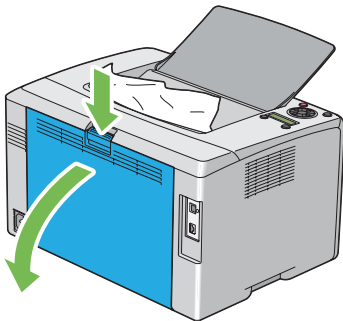

- 2 Lift up the levers.

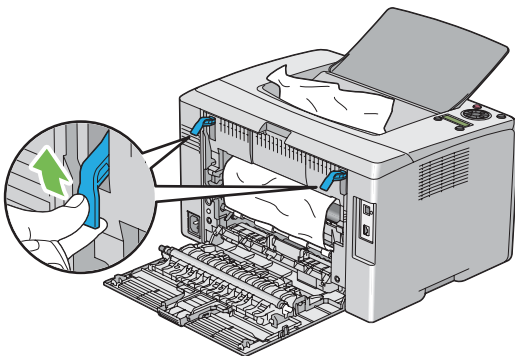

- 3 Remove any paper jammed from the back of the printer. If no paper is found in the paper path, then remove any paper jammed out of the center output tray.

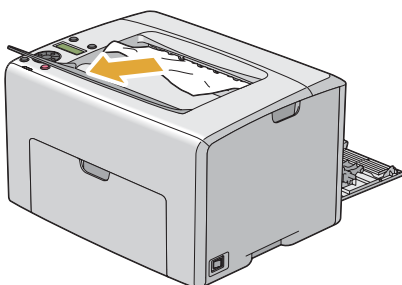

4 Lower the levers to their original position.

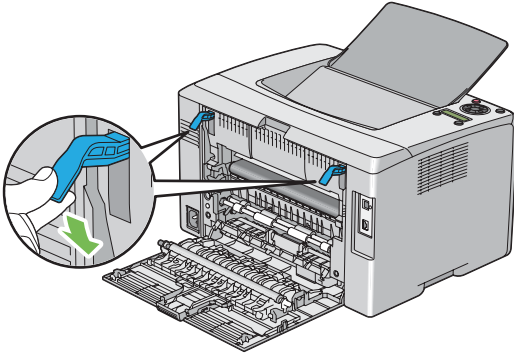

5 Close the rear door.

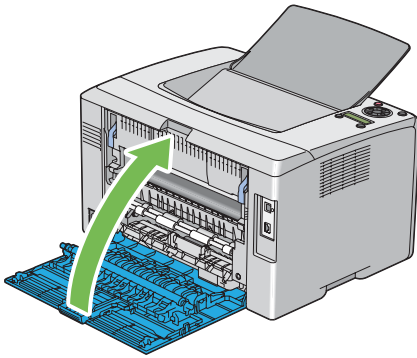

■ Jam Problems

This section includes:

- ["Misfeed jam" on page 194](#)
- ["Multi-feed jam" on page 194](#)

Misfeed jam

Problem	Action
Print media misfeeds occur.	Remove the paper from the PSI, and then ensure that the paper is properly inserted in the MPF.
	Depending on the print media you use, take any of the following actions: <ul style="list-style-type: none">• For thick paper, use the one that is 216 gsm or less.• For thin paper, use the one that is 60 gsm or more.• For the envelope, ensure that it is properly loaded in the MPF or the PSI as instructed in "Loading Envelope in the Multipurpose Feeder (MPF)" on page 129 or "Loading Envelope in the Priority Sheet Inserter (PSI)" on page 136.
	If the envelope is deformed, correct it or use another envelope.
	If performing manual duplex printing, ensure that the print media is not curled.
	Fan the print media.
	If the print media is damp, turn over the print media.
	If the problem continues, use print media that is not damp.

NOTE:

- If the problem continues even though you have taken suggested actions described above, contact the Fuji Xerox local representative office or an authorised dealer.

Multi-feed jam

Problem	Action
Print media multiple feeds occur.	Remove the paper from the PSI, and then ensure that the paper is inserted properly in the MPF.
	If the print media is damp, use print media that is not damp.
	Fan the print media.

NOTE:

- If the problem continues even though you have taken suggested actions described above, contact the Fuji Xerox local representative office or an authorised dealer.

Basic Printer Problems

Some printer problems can be easy to resolve. If a problem occurs with your printer, check each of the following:



- The power cord is connected to the printer, and to a properly grounded electrical outlet.
- The printer is turned on.
- The electrical outlet is not turned off at any switch or breaker.
- Other electrical equipment plugged into the outlet is working.
- When your printer is connected to the computer with the Wireless connection, the Ethernet cable is not connected between the printer and the network.

If you have checked all of the above and still have a problem, turn off the printer, wait for 10 seconds, and then turn on the printer. This often fixes the problem.

Display Problems

Problem	Action
After the printer is turned on, the display on the LCD panel is blank, keeps showing <code>Please wait...</code> , or the back light is not lit.	Turn off the printer, wait for 10 seconds, and turn on the printer. Self Test Message appears on the LCD panel. When the test is completed, <code>Ready</code> is displayed.
Menu settings changed from the operator panel have no effect.	Settings in the software program, the print driver, or the printer utilities have precedence over the settings made on the operator panel. Change the menu settings from the print driver, the printer utilities, or the software program instead of the operator panel.

Printing Problems

Problem	Action
Job did not print or incorrect characters printed.	<p>Ensure that Ready appears on the LCD panel before you send a job to print. Press the  (Menu) button to return to Ready.</p> <p>Ensure that print media is loaded in the printer. Press the  (Menu) button to return to Ready.</p> <p>Verify that you are using the correct print driver.</p> <p>Ensure that you are using the correct Ethernet or USB cable and that it is securely connected to the printer.</p> <p>Verify that the correct print media size is selected.</p> <p>If you are using a print spooler, verify that the spooler has not stalled.</p> <p>Check the interface of your printer from Admin Menu.</p> <p>Determine the host interface you are using. Print a Printer Settings page to verify that the current interface settings are correct. Refer to "Printing a Printer Settings Page" on page 156 for details on how to print a Printer Settings page.</p>
Print media misfeeds or multiple feeds occur.	<p>Ensure that the print media you are using meets the specifications for your printer.</p> <p>See also:</p> <ul style="list-style-type: none">• "Usable Print Media" on page 117 <p>Fan the print media before loading it.</p> <p>Ensure that the print media is loaded correctly.</p> <p>Ensure that the paper width guides and length guide are adjusted correctly.</p> <p>Ensure that the PSI is securely inserted.</p> <p>Do not overfill the print media sources.</p> <p>Do not force print media into the PSI or the MPF when you load it. Otherwise, it may skew or buckle.</p> <p>Ensure that the print media is not curled.</p> <p>Load the recommended print side correctly for the type of print media you are using.</p> <p>See also:</p> <ul style="list-style-type: none">• "Loading Print Media" on page 122 <p>Turn the print media over or around and try printing again to see if feeding improves.</p> <p>Do not mix print media types.</p> <p>Do not mix reams of print media.</p> <p>Remove the top and bottom curled sheets of a ream before loading the print media.</p> <p>Load a print media source only when it is empty.</p>
The envelope is creased after printing.	<p>Ensure that the envelope is loaded as instructed in "Loading Envelope in the Multipurpose Feeder (MPF)" on page 129 or "Loading Envelope in the Priority Sheet Inserter (PSI)" on page 136.</p>

Problem	Action
Page breaks in unexpected places.	Increase the value for Job Time-Out in the System Settings menu, that is on the Printer Maintenance tab in the Printer Setting Utility. Increase the time-out value in the Protocol Settings menu on CentreWare Internet Services.
Print media does not stack neatly in the center output tray.	Turn the print media stack over in the PSI and MPF.
Job prints from the wrong source or on the wrong print media.	Check Paper Type in the print driver.

Print Quality Problems

This section includes:

- ["The Output Is Too Light" on page 200](#)
- ["Toner Smears or Print Comes Off/Stain on Back Side" on page 201](#)
- ["Random Spots/Blurred Images" on page 202](#)
- ["The Entire Output Is Blank" on page 203](#)
- ["Streaks Appear on the Output" on page 204](#)
- ["Pitched Color Dots" on page 205](#)
- ["Vertical Blanks" on page 206](#)
- ["Mottle" on page 207](#)
- ["Ghosting" on page 208](#)
- ["Fog" on page 209](#)
- ["Bead-Carry-Out \(BCO\)" on page 210](#)
- ["Auger Mark" on page 211](#)
- ["Wrinkled/Stained Paper" on page 212](#)
- ["The Top Margin Is Incorrect" on page 213](#)
- ["Color Registration Is out of Alignment" on page 214](#)
- ["Protrudent/Bumpy Paper" on page 215](#)

NOTE:

- In this section, some procedures use the Printer Setting Utility or SimpleMonitor. Some procedures that use the Printer Setting Utility can also be performed using the operator panel.

See also:

- ["Understanding the Printer Menus" on page 164](#)
- ["Printer Setting Utility \(Windows Only\)" on page 45](#)
- ["SimpleMonitor \(Windows Only\)" on page 46](#)

■ The Output Is Too Light

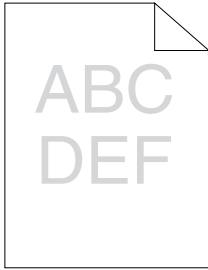

Problem	Action
The output is too light.	<p>The toner cartridges may be low or need to be replaced. Confirm the amount of toner in each toner cartridge.</p> <ol style="list-style-type: none"><li data-bbox="552 581 1208 639">1 Check the toner level in the Status tab in the Status Monitor window.<li data-bbox="552 645 1023 670">2 Replace the toner cartridges as necessary. <hr/> <p>Verify that the print media is dry and the correct print media is used. If not, use the print media recommended for the printer.</p> <p>See also:</p> <ul style="list-style-type: none"><li data-bbox="552 813 937 838">• "Usable Print Media" on page 117 <hr/> <p>Try changing the Paper Type setting in the print driver.</p> <ol style="list-style-type: none"><li data-bbox="552 884 1245 942">1 On the Paper / Output tab in Printing Preferences of the print driver, change the Paper Type setting. <hr/> <p>Disable Draft Mode in the print driver.</p> <ol style="list-style-type: none"><li data-bbox="552 1031 1270 1089">1 On the Advanced Settings tab in Printing Preferences of the print driver, ensure that the Draft Mode check box is not selected.

NOTE:

- If the problem continues even though you have taken suggested actions described above, contact the Fuji Xerox local representative office or an authorised dealer.

■ Toner Smears or Print Comes Off/Stain on Back Side

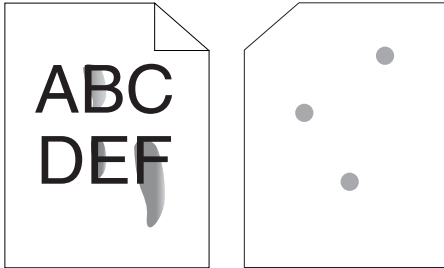

Problem	Action
Toner smears or print comes off. The output has stain on the back side.	The print media surface may be uneven. Try changing the Paper Type setting in the print driver. For example, change Plain to Lightweight Cardstock. <ol style="list-style-type: none">1 On the Paper / Output tab in Printing Preferences of the print driver, change the Paper Type setting.
	Verify that the correct print media is being used. If not, use the print media recommended for the printer.
	See also: <ul style="list-style-type: none">• "Usable Print Media" on page 117
	Adjust the temperature of the fusing unit. <ol style="list-style-type: none">1 Launch the Printer Setting Utility, and click Adjust Fusing Unit on the Printer Maintenance tab.2 Adjust the fixing temperature by turning up the value for your printing media.3 Click the Apply New Settings button.

NOTE:

- If the problem continues even though you have taken suggested actions described above, contact the Fuji Xerox local representative office or an authorised dealer.

■ Random Spots/Blurred Images

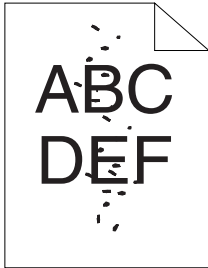

Problem	Action
The printed result has random spots or is blurred.	<p>Ensure that the toner cartridges are installed correctly.</p> <p>See also:</p> <ul style="list-style-type: none">• "Installing a Toner Cartridge" on page 246 <hr/> <p>If you use non-genuine brand toner cartridges, install genuine brand toner cartridges.</p> <hr/> <p>Clean up the fusing unit.</p> <ol style="list-style-type: none">1 Load one sheet of paper on the MPF, and then print a solid image all over paper.2 Load the printed sheet with the side to be printed on facing down, and then print a blank sheet of paper.

NOTE:

- If the problem continues even though you have taken suggested actions described above, contact the Fuji Xerox local representative office or an authorised dealer.

■ The Entire Output Is Blank

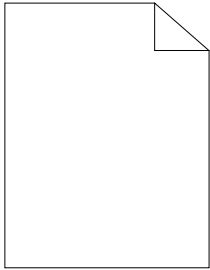

If this trouble happens, contact the Fuji Xerox local representative office or an authorised dealer.

■ Streaks Appear on the Output

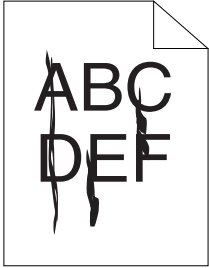

If this trouble happens, contact the Fuji Xerox local representative office or an authorised dealer.

■ Pitched Color Dots

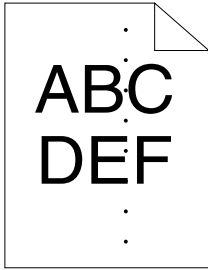

If this trouble happens, contact the Fuji Xerox local representative office or an authorised dealer.

■ Vertical Blanks

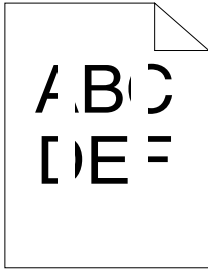

Problem	Action
The printed result has vertical blanks.	Clean inside the printer and perform test print. 1 Clean inside the printer by using the print head cleaning rod. 2 Click Print Test Page in the Properties window of the print driver. See also: <ul style="list-style-type: none">• "Cleaning Inside the Printer" on page 239

NOTE:

- If the problem continues even though you have taken suggested actions described above, contact the Fuji Xerox local representative office or an authorised dealer.

■ Mottle

Problem	Action
The printed result has mottled appearance.	Adjust the transfer bias. 1 Launch the Printer Setting Utility, click Adjust BTR on the Printer Maintenance tab. 2 Adjust the setting for the type of print media being used. 3 Click the Apply New Settings button.
	If you use non-recommended print media, use the print media recommended for the printer.

NOTE:

- If the problem continues even though you have taken suggested actions described above, contact the Fuji Xerox local representative office or an authorised dealer.

■ Ghosting

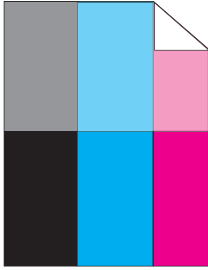

Problem	Action
The printed result has ghosting.	<p>Adjust the transfer bias.</p> <ol style="list-style-type: none">1 Launch the Printer Setting Utility, and click Chart Print on the Diagnosis tab.2 Click the Ghost Configuration Chart button. The Ghost Configuration Chart is printed.3 Click BTR Refresh Mode on the Printer Maintenance tab.4 Select the check box next to On, and then click the Apply New Settings button.5 Click Chart Print on the Diagnosis tab.6 Click the Ghost Configuration Chart button. The Ghost Configuration Chart is printed.
	<p>The print media surface may be uneven. Try changing the Paper Type setting in the print driver. For example, change Plain to Lightweight Cardstock.</p> <ol style="list-style-type: none">1 On the Paper / Output tab in Printing Preferences of the print driver, change the Paper Type setting.
	<p>Adjust the temperature of the fusing unit.</p> <ol style="list-style-type: none">1 Launch the Printer Setting Utility, and click Adjust Fusing Unit on the Printer Maintenance tab.2 Adjust the fixing temperature by turning up the value for your printing media.3 Click the Apply New Settings button.
	<p>If you use non-recommended print media, use the print media recommended for the printer.</p>

NOTE:

- If the problem continues even though you have taken suggested actions described above, contact the Fuji Xerox local representative office or an authorised dealer.

■ Fog



Problem	Action
The printed result is foggy.	When the whole is printed light, contact the Fuji Xerox local representative office or an authorised dealer. When the printed page is partly light, start Developer Stir Mode . 1 Launch the Printer Setting Utility, and click Developer Stir Mode on the Diagnosis tab. 2 Click the Start button.

NOTE:

- If the problem continues even though you have taken suggested actions described above, contact the Fuji Xerox local representative office or an authorised dealer.

■ Bead-Carry-Out (BCO)

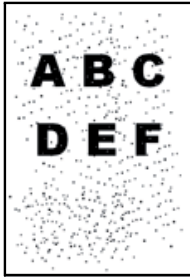

Problem	Action
Bead-Carry-Out (BCO) is happening.	<p>If the printer is installed in a high altitude location, set the altitude of the location.</p> <ol style="list-style-type: none">1 Launch the Printer Setting Utility, and click Adjust Altitude on the Printer Maintenance tab.2 Select the value close to the altitude of the location where the printer is installed.3 Click the Apply New Settings button.

NOTE:

- If the problem continues even though you have taken suggested actions described above, contact the Fuji Xerox local representative office or an authorised dealer.

■ Auger Mark

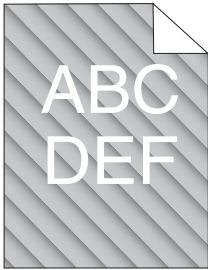

Problem	Action
The printed result has auger mark.	<p>The toner cartridges may be low or need to be replaced. Confirm the amount of toner in each toner cartridge.</p> <ol style="list-style-type: none"><li data-bbox="552 581 1208 639">1 Check the toner level in the Status tab in the Status Monitor window.<li data-bbox="552 645 1023 670">2 Replace the toner cartridges as necessary. <hr/> <p>Start Developer Stir Mode.</p> <ol style="list-style-type: none"><li data-bbox="552 720 1259 778">1 Launch the Printer Setting Utility, and click Developer Stir Mode on the Diagnosis tab.<li data-bbox="552 784 803 809">2 Click the Start button.

NOTE:

- If the problem continues even though you have taken suggested actions described above, contact the Fuji Xerox local representative office or an authorised dealer.

■ Wrinkled/Stained Paper

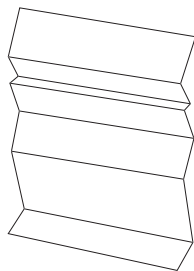

Problem	Action
The output is wrinkled. The output is stained.	Verify that the correct print media is being used. If not, use the print media recommended for the printer. See also: <ul style="list-style-type: none"><li data-bbox="550 639 937 664">• "Usable Print Media" on page 117<li data-bbox="550 678 924 703">• "About Print Media" on page 112 <hr/> <p data-bbox="541 716 1256 772">If you use the envelope, check whether the crease is within 30 mm of the four edges of the envelope.</p> <p data-bbox="541 786 1256 842">If the crease is within 30 mm of the four edges of the envelope, this is considered normal. Your printer is not at fault.</p> <p data-bbox="541 855 872 880">If not, take the following actions:</p> <ul style="list-style-type: none"><li data-bbox="550 894 1245 950">• If the envelope is #10 envelope, which is 220 mm or longer and has a flap on the long edge, use a different size envelope.<li data-bbox="550 964 1273 1020">• If the envelope is C5, which is 220 mm or longer and has a flap on the short edge, load it in the MPF with the flap open and facing up.<li data-bbox="550 1033 1273 1103">• If the envelope is Monarch or DL, which is shorter than 220 mm, load it long edge feed in the MPF with the flap open and facing up. If the problem continues, use a different size envelope.

NOTE:

- If the problem continues even though you have taken suggested actions described above, contact the Fuji Xerox local representative office or an authorised dealer.

■ The Top Margin Is Incorrect

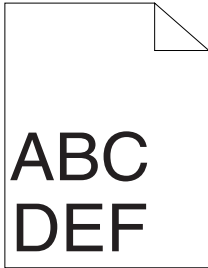

Problem	Action
The top margin is incorrect.	Ensure that the margins are set correctly on the application being used.

NOTE:

- If the problem continues even though you have taken suggested actions described above, contact the Fuji Xerox local representative office or an authorised dealer.

■ Color Registration Is out of Alignment

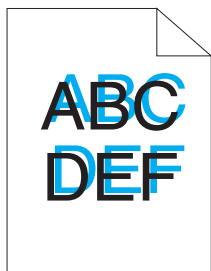

Problem	Action
Color registration is out of alignment.	<p>Execute auto color registration adjustment.</p> <ol style="list-style-type: none">1 Launch the Printer Setting Utility, and click Color Registration Adjustment on the Printer Maintenance tab.2 Deselect the check box next to On.3 Click the Start button next to Auto Correct. <hr/> <p>Clean the CTD sensor.</p> <ol style="list-style-type: none">1 Clean the CTD sensor.2 Launch the Printer Setting Utility, and click Color Registration Adjustment on the Printer Maintenance tab.3 Deselect the check box next to On.4 Click the Start button next to Auto Correct. <p>See also:</p> <ul style="list-style-type: none">• "Cleaning the Color Toner Density (CTD) Sensor" on page 242 <hr/>
	<p>Print the color registration chart and manually correct the color registration.</p> <ol style="list-style-type: none">1 Launch the Printer Setting Utility, and click Color Registration Adjustment on the Printer Maintenance tab.2 Deselect the check box next to On.3 Click the Start button next to Print Color Regi Chart.4 Select the paper size, and then click OK. The color registration chart is printed.5 Check the values with the straight lines on the chart.6 Select the value for each color on the Printer Setting Utility.7 Click the Apply New Settings button.8 Click the Start button next to Print Color Regi Chart to print the color registration chart again.9 Adjust till all straight lines are at the value of 0. <p>See also:</p> <ul style="list-style-type: none">• "Adjusting Color Registration" on page 216 <hr/>

NOTE:

- If the problem continues even though you have taken suggested actions described above, contact the Fuji Xerox local representative office or an authorised dealer.

■ Protrudent/Bumpy Paper

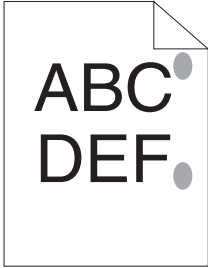

Problem	Action
Printed surface got protrudent/bumpy.	Clean up the fusing unit. 1 Load one sheet of paper on the MPF, and then print a solid image all over paper. 2 Load the printed sheet with the side to be printed on facing down, and then print a blank sheet of paper.

NOTE:

- If the problem continues even though you have taken suggested actions described above, contact the Fuji Xerox local representative office or an authorised dealer.

Adjusting Color Registration

This section describes how to adjust the color registration when you first install the printer or after moving it to a new location.







This section includes:

- ["Performing Auto Correct" on page 217](#)
- ["Printing the Color Registration Chart" on page 218](#)
- ["Determining Values" on page 219](#)
- ["Entering Values" on page 220](#)

■ Performing Auto Correct

Auto Correct allows you to correct the color registration automatically.

The Operator Panel

- 1 Press the  (**Menu**) button.
- 2 Select `Admin Menu`, and then press the  button.
- 3 Select `Maintenance Mode`, and then press the  button.
- 4 Select `Adjust ColorRegi`, and then press the  button.
- 5 Select `Auto Adjust`, and then press the  button.
- 6 Select `Are you sure?`, and then press the  button.
Auto Correct is performed.

The Printer Setting Utility

The following procedure uses Microsoft® Windows® XP as an example.

- 1 Click **start** → **All Programs** → **Fuji Xerox** → **Fuji Xerox Printer Software for Asia-Pacific** → **FX DocuPrint CP205/FX DocuPrint CP205 w** → **Printer Setting Utility**.

NOTE:





- The **Select Printer** window appears in this step, when multiple print drivers are installed on your computer. In this case, click the name of the desired printer listed in **Printer Name**.

The Printer Setting Utility opens.

- 2 Click the **Printer Maintenance** tab.
- 3 Select **Color Registration Adjustment** from the list at the left side of the page.
The **Color Registration Adjustment** page is displayed.
- 4 Deselect the check box next to **On**.
- 5 Click the **Start** button next to **Auto Correct**.
The color registration is corrected automatically.

■ Printing the Color Registration Chart

The Operator Panel

- 1 Press the  (**Menu**) button.
- 2 Select `Admin Menu`, and then press the  button.
- 3 Select `Maintenance Mode`, and then press the  button.
- 4 Select `Adjust ColorRegi`, and then press the  button.
- 5 Select `Color Regi Chart`, and then press the  button.
The color registration chart is printed.

The Printer Setting Utility

The following procedure uses Windows XP as an example.

- 1 Click **start** → **All Programs** → **Fuji Xerox** → **Fuji Xerox Printer Software for Asia-Pacific** → **FX DocuPrint CP205/FX DocuPrint CP205 w** → **Printer Setting Utility**.

NOTE:

- The **Select Printer** window appears in this step, when multiple print drivers are installed on your computer. In this case, click the name of the desired printer listed in **Printer Name**.

The Printer Setting Utility opens.

- 2 Click the **Printer Maintenance** tab.
- 3 Select **Color Registration Adjustment** from the list at the left side of the page.
The **Color Registration Adjustment** page is displayed.
- 4 Deselect the check box next to **On**.
- 5 Click the **Start** button next to **Print Color Regi Chart**.
- 6 Select the paper size, and then click **OK**.
The color registration chart is printed.

■ Determining Values

On the color registration chart printed, find the straightest lines where the two black lines and the colored line are most closely aligned for each color (Y, M, and C).

If you find the straightest line, make a note of the value (-5 – +5) indicated by the straightest line for each color.

When the value is 0 for each color, you do not need to adjust the color registration.



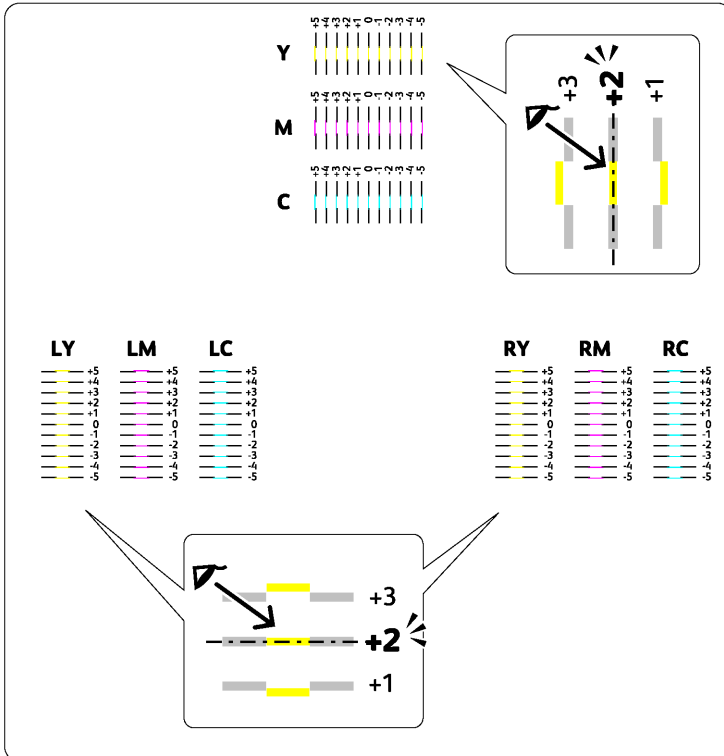





When the value is not 0, enter the value according to the procedure in ["Entering Values" on page 220](#).



■ Entering Values

The Operator Panel

Using the operator panel, enter the values that you found in the color registration chart to make adjustments.

- 1 Press the  (**Menu**) button.
- 2 Select `Admin Menu`, and then press the  button.
- 3 Select `Maintenance Mode`, and then press the  button.
- 4 Select `Adjust ColorRegi`, and then press the  button.
- 5 Select `Enter Number`, and then press the  button.
- 6 Ensure that `Enter (Y,M,C)` appears, and then press the ▲ or ▼ button until you reach the value (for example, +3) displayed on the chart.
- 7 Press the ► button once and move the cursor to the next color.
- 8 Repeat steps 6 and 7 to enter all of the digits, and then press the  button.
- 9 Ensure that `Enter (LY,LM,LC)` appears.
- 10 Press the ▲ or ▼ button until you reach the value (for example, +3) displayed on the chart.
- 11 Press the ► button once and move the cursor to the next color.
- 12 Repeat steps 10 and 11 to enter all of the digits, and then press the  button.
- 13 Ensure that `Enter (RY,RM,RC)` appears.
- 14 Press the ▲ or ▼ button until you reach the value (for example, +3) displayed on the chart.
- 15 Press the ► button once and move the cursor to the next color.
- 16 Repeat steps 14 and 15 to enter all of the digits, and then press the  button.
The top screen appears.
- 17 Perform steps 1 to 4 to enter the `Adjust ColorRegi` menu.
- 18 Select `Color Regi Chart`, and then press the  button.
The color registration chart is printed with the new values.
- 19 Adjust till all straight lines are at the value of 0. Viewing the images before and after will help.

The Printer Setting Utility

Using the Printer Setting Utility, enter the values that you found in the color registration chart to make adjustments.

The following procedure uses Windows XP as an example.

- 1 Click **start** → **All Programs** → **Fuji Xerox** → **Fuji Xerox Printer Software for Asia-Pacific** → **FX DocuPrint CP205/FX DocuPrint CP205 w** → **Printer Setting Utility**.

NOTE:

- The **Select Printer** window appears in this step, when multiple print drivers are installed on your computer. In this case, click the name of the desired printer listed in **Printer Name**.

The Printer Setting Utility opens.

- 2 Click the **Printer Maintenance** tab.
- 3 Select **Color Registration Adjustment** from the list at the left side of the page.
The **Color Registration Adjustment** page is displayed.
- 4 Deselect the check box next to **On**.
- 5 Select the value you checked in the color registration chart, and then click the **Apply New Settings** button.
- 6 Click the **Start** button next to **Print Color Regi Chart**.
- 7 Select the paper size, and then click **OK**.
The color registration chart is printed with the new values.
- 8 Adjust until all straight lines are at the value of 0. Show image of before and after adjustment will help.

IMPORTANT:

- After printing the color registration chart, do not turn off the printer until the printer motor has stopped running.
- If 0 is not next to the straightest lines, determine the values and adjust the printer again.

Noise

NOTE:

- In this section, the procedures use the Printer Setting Utility.

See also:

- ["Printer Setting Utility \(Windows Only\)" on page 45](#)

Problem	Action
The printer makes a strange noise.	<p>Locate the cause of the problem by removing the toner cartridges.</p> <ol style="list-style-type: none">1 Remove the toner cartridges.2 Launch the Printer Setting Utility, and click Machine Check on the Diagnosis tab.3 Select Main Motor Operation Check from the drop-down list box, and click the Start button.4 Click the Play of Sound button to check the motor sound. <p>See also:</p> <ul style="list-style-type: none">• "Replacing Toner Cartridges" on page 243 <p>If the noise generated from the printer matches with the noise from the Play of Sound button, contact the Fuji Xerox local representative office or an authorised dealer.</p> <hr/> <p>Perform Dispense Motor Check.</p> <ol style="list-style-type: none">1 Ensure that the toner cartridges are removed.2 Launch the Printer Setting Utility, and click Machine Check on the Diagnosis tab.3 Select Dispense Motor Check(Yellow), Dispense Motor Check(Magenta), Dispense Motor Check(Cyan), or Dispense Motor Check(Black) from the drop-down list box, and click the Start button.4 Click the Play of Sound button to check the motor sound.5 Repeat steps 3 and 4 to perform Dispense Motor Check for the rest of the toner cartridges. <p>NOTE:</p> <ul style="list-style-type: none">• You can perform Dispense Motor Check for CMYK in any order you desire.• Do not check the operation of the dispense motor repeatedly. <p>If the noise generated from the printer matches with the noise from the Play of Sound button, contact the Fuji Xerox local representative office or an authorised dealer.</p> <hr/> <p>Reinstall the toner cartridges and perform Dispense Motor Check.</p> <p>If the noise generated from the printer matches with the noise from the Play of Sound button, contact the Fuji Xerox local representative office or an authorised dealer.</p>

Other Problems



Problem	Action
Condensation has occurred inside the printer.	This usually occurs within several hours after you heat the room in winter. This also occurs when the printer is operating in a location where relative humidity reaches 85% or more. Adjust the humidity or relocate the printer to an appropriate environment.



Understanding Printer Messages

The printer LCD panel displays messages describing the current state of the printer and indicates possible printer problems you must resolve. This section describes messages, their meanings, and how to clear the messages.

IMPORTANT:

- When an error code is displayed, the print data remaining on the printer and the information accumulated in the memory of the printer are not secured.

Error-Code	What You Can Do
010-397	Turn off the printer, and then on. If this does not solve the problem, contact the Fuji Xerox local representative office or an authorised dealer. See also: <ul style="list-style-type: none">• "Online Services" on page 267
016-500	Turn off the printer, and then on. If this does not solve the problem, contact the Fuji Xerox local representative office or an authorised dealer.
016-501	
016-502	See also: <ul style="list-style-type: none">• "Online Services" on page 267
016-602	This is not an error. You can continue operation normally.
016-610	Turn off the printer, and then on. If this does not solve the problem, contact the Fuji Xerox local representative office or an authorised dealer. See also: <ul style="list-style-type: none">• "Online Services" on page 267
016-612	
016-718	Press the  button to cancel the current print job.
016-720	See also: <ul style="list-style-type: none">• "Canceling a Print Job" on page 147
016-737	
016-741	
016-742	
016-743	
016-744	
016-745	
016-799	
016-920	Press the  button. Execute the operation again according to the operation procedure.
016-921	
016-922	Press the  button. Set only wireless LAN access point (Registrar) to be operated with WPS-PBC, and execute the operation again according to the operation procedure.
018-318	Turn off the printer, and then on. If this does not solve the problem, contact the Fuji Xerox local representative office or an authorised dealer. See also: <ul style="list-style-type: none">• "Online Services" on page 267
024-340	Turn off the printer, and then on. If this does not solve the problem, contact the Fuji Xerox local representative office or an authorised dealer. See also: <ul style="list-style-type: none">• "Online Services" on page 267

Error-Code	What You Can Do
024-360	Turn off the printer, and then on. If this does not solve the problem, contact the Fuji Xerox local representative office or an authorised dealer. See also: <ul style="list-style-type: none"> • "Online Services" on page 267
024-371	Turn off the printer, and then on. Or, unplug the Ethernet cable or USB cable, and then plug it again. If this does not solve the problem, contact the Fuji Xerox local representative office or an authorised dealer. See also: <ul style="list-style-type: none"> • "Online Services" on page 267
024-958	Load the correct paper.
024-963	See also: <ul style="list-style-type: none"> • "Loading Print Media in the Multipurpose Feeder (MPF)" on page 125 • "Loading Print Media in the Priority Sheet Inserter (PSI)" on page 134
027-446	Change IP address to avoid duplication. Turn off the printer, and turn it on again.
027-452	
041-340	Turn off the printer, and then on. If this does not solve the problem, contact the Fuji Xerox local representative office or an authorised dealer. See also: <ul style="list-style-type: none"> • "Online Services" on page 267
042-325	Turn off the printer, and then on. If this does not solve the problem, contact the Fuji Xerox local representative office or an authorised dealer.
042-358	
042-372	See also: <ul style="list-style-type: none"> • "Online Services" on page 267
061-370	Turn off the printer, and then on. If this does not solve the problem, contact the Fuji Xerox local representative office or an authorised dealer. See also: <ul style="list-style-type: none"> • "Online Services" on page 267
075-100	Check and clear the paper path, load the specified paper, and then press the  button. See also: <ul style="list-style-type: none"> • "Clearing Paper Jams From the Front of the Printer" on page 189
075-921	Load paper for the second side (odd) pages, and press the  button. See also: <ul style="list-style-type: none"> • "Manual Duplex Printing (Windows Print Driver Only)" on page 140
077-100	Check and clear the paper path.
077-104	See also: <ul style="list-style-type: none"> • "Clearing Paper Jams From the Back of the Printer" on page 190
077-106	Check and clear the paper path.
077-108	See also:
077-109	<ul style="list-style-type: none"> • "Clearing Paper Jams From the Center Output Tray" on page 192
077-304	Close the rear door.

Error-Code	What You Can Do
077-900	Check and clear the paper path. See also: • "Clearing Paper Jams From the Center Output Tray" on page 192
077-901	Check and clear the paper path. See also: • "Clearing Paper Jams From the Back of the Printer" on page 190
091-402	Contact the Fuji Xerox local representative office or an authorised dealer. See also: • "Online Services" on page 267
092-651	Turn off the printer, and then on. If this does not solve the problem, contact the Fuji Xerox local representative office or an authorised dealer.
092-661	
	See also: • "Online Services" on page 267
092-310	Clean the CTD sensor.
092-910	See also: • "Cleaning the Color Toner Density (CTD) Sensor" on page 242
093-423	Replace the specified toner cartridge soon.
093-424	See also: • "Replacing Toner Cartridges" on page 243
093-425	
093-426	
093-919	Re-install the specified toner cartridge. And, turn off the printer, and then on.
093-920	See also: • "Replacing Toner Cartridges" on page 243
093-921	
093-922	
093-930	Remove the specified toner cartridge and install a new one. If you do not replace the toner cartridge, print quality problems may occur.
093-931	
093-932	See also: • "Replacing Toner Cartridges" on page 243
093-933	
093-950	Check the specified toner cartridge if there is any malfunction. Re-install the specified toner cartridge.
093-951	
093-952	See also: • "Replacing Toner Cartridges" on page 243
093-925	
093-960	
093-961	Re-install the specified toner cartridge with the supported one.
093-962	
093-926	
093-970	
093-971	See also: • "Replacing Toner Cartridges" on page 243
093-972	
093-973	

Error-Code	What You Can Do
116-314	Turn off the printer, and then on. If this does not solve the problem, contact the Fuji Xerox local representative office or an authorised dealer.
116-315	
116-317	See also: <ul style="list-style-type: none"> • "Online Services" on page 267
116-324	
116-326	
116-343	
116-350	
116-351	
116-352	
116-355	
124-333	Turn off the printer, and then on. If this does not solve the problem, contact the Fuji Xerox local representative office or an authorised dealer.
191-310	
	See also: <ul style="list-style-type: none"> • "Online Services" on page 267
193-700	This message indicates the printer is in the Non GenuineToner mode.

Contacting Service

When you call for printer service, be prepared to describe the problem you are experiencing or the error message on the LCD panel.

You need to know the model of your printer and serial number. See the label on the rear door of your printer.

Getting Help

This section includes:

- ["LCD Panel Messages" on page 230](#)
- ["SimpleMonitor Alerts" on page 231](#)
- ["Obtaining the Product Information" on page 232](#)

Fuji Xerox provides several automatic diagnostic tools to help you produce and maintain print quality.

■ LCD Panel Messages

The LCD panel provides you with information and troubleshooting help. When an error or warning condition occurs, the LCD panel displays a message informing you of the problem.

See also:

- ["Understanding Printer Messages" on page 224](#)

■ SimpleMonitor Alerts

The SimpleMonitor is a tool that is included on the *Software Pack CD-ROM*. It automatically checks the printer status when you send a print job. If the printer is unable to print your job, the SimpleMonitor automatically displays an alert on your computer screen to let you know that the printer needs attention.

■ Obtaining the Product Information

Obtaining the Latest Print Driver

The latest print driver can be obtained by downloading it from our web site.

NOTE:

- The communication fee shall be borne by users.
- 1** In your print driver's **Printing Preferences** dialog box, click the **Advanced Settings** tab and then click **About**.
 - 2** Click **Fuji Xerox Web Site**.
Your web browser launches and our web site is displayed.
 - 3** Follow the instructions on the web site and download an appropriate print driver.

NOTE:

- The URL of the driver download service page is as follows: <http://www.fujixeroxprinters.com/>
- For the latest information about the print driver features, refer to the online Help provided for the print driver.

Updating the Printer's Firmware

Our web site also provides a tool that allows you to update the printer's firmware (software embedded within the printer) from your computer.

The latest firmware and updating tool can be downloaded from the following URL.

Follow the instructions on the web site and download the correct firmware update.

<http://www.fujixeroxprinters.com/>

NOTE:

- The communication fee shall be borne by users.

Non Genuine Toner Mode

When toner within a toner cartridge is empty, the `Replace XXXX Cartridge` or `Empty XXXX Cartridge` (XXXX: Yellow, Magenta, Cyan, or Black) message appears.

When you want to use the printer in the Non Genuine Toner mode, enable the Non Genuine Toner mode and replace the toner cartridge.

IMPORTANT:

- If you use the printer in the Non Genuine Toner mode, the performance of the printer may not be at its optimum. And any problems that may arise from the use of the Non Genuine Toner mode are not covered by our quality guarantee. The continuous use of the Non Genuine Toner mode can also cause the printer to break down, and any repair charges for such break down will be incurred by users.

NOTE:

- To disable the Non Genuine Toner mode, select `Off for Non-GenuineToner` on the operator panel or deselect the check box next to **On** on the **Non Genuine Toner** page on the Printer Setting Utility.







This section includes:

- ["The Operator Panel" on page 234](#)
- ["The Printer Setting Utility" on page 235](#)

■ The Operator Panel

NOTE:

- Before starting the operation described below, confirm that `Ready` is displayed on the LCD panel.

- 1 Press the  (**Menu**) button.
- 2 Select `Admin Menu` and then press the  button.
- 3 Select `Maintenance Mode` and then press the  button.
- 4 Select `Non-GenuineToner` and then press the  button.
- 5 Select `On` and then press the  button.
- 6 Press the  button until the top page is displayed.
The printer switches to the `Non-GenuineToner` mode.

■ The Printer Setting Utility

The following procedure uses Windows XP as an example.

- 1 Click **start** → **All Programs** → **Fuji Xerox** → **Fuji Xerox Printer Software for Asia-Pacific** → **FX DocuPrint CP205/FX DocuPrint CP205 w** → **Printer Setting Utility**.

NOTE:

- The **Select Printer** window appears in this step, when multiple print drivers are installed on your computer. In this case, click the name of the desired printer listed in **Printer Name**.

The Printer Setting Utility opens.

- 2 Click the **Printer Maintenance** tab.
- 3 Select **Non Genuine Toner** from the list at the left side of the page.
The **Non Genuine Toner** page is displayed.
- 4 Select the check box next to **On**, and then click the **Apply New Settings** button.

Maintenance

This chapter includes:

- "Cleaning the Printer" on page 238
- "Replacing Toner Cartridges" on page 243
- "Ordering Supplies" on page 248
- "Storing Consumables" on page 252
- "Managing the Printer" on page 253
- "Conserving Supplies" on page 259
- "Checking Page Counts" on page 260
- "Moving the Printer" on page 261

Cleaning the Printer

This section describes how to clean the printer in order to maintain it in good condition and print clean printouts all the time.



WARNING:

- **When cleaning this product, use the designated cleaning materials exclusive to it. Other cleaning materials may result in poor performance of the product. Never use aerosol cleaners, or it may catch fire and cause explosion.**



CAUTION:

- **When cleaning this product, always switch off and unplug it. Access to a live machine interior may cause electric shock.**

This section includes:

- ["Cleaning Inside the Printer" on page 239](#)
- ["Cleaning the Color Toner Density \(CTD\) Sensor" on page 242](#)

■ Cleaning Inside the Printer

- 1 Turn off the printer.
- 2 Open the toner access cover.

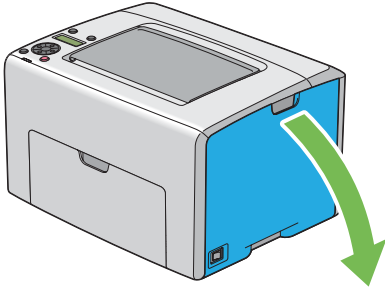

- 3 Pinch the toner cartridge firmly as shown in the illustration.

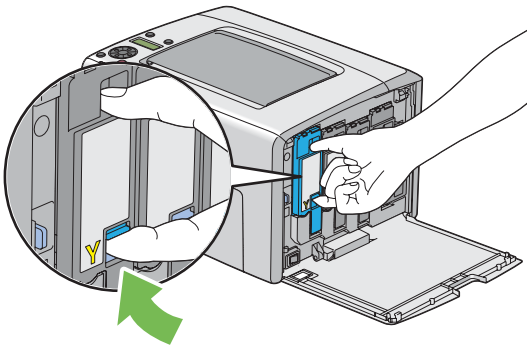

- 4 Pull the toner cartridge out.

IMPORTANT:

- Always pull the toner cartridge out slowly so you do not spill any toner.

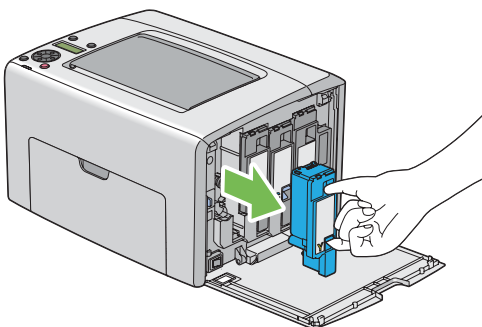

- 5 Pull the other three toner cartridges out as well.
- 6 Pull the print head cleaning rod out.

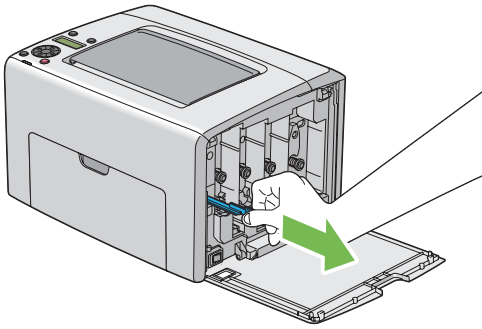

- 7 Insert the print head cleaning rod fully into the hole beside the arrow on the printer until its tip reaches the interior of the printer as illustrated below, and then pull it out.

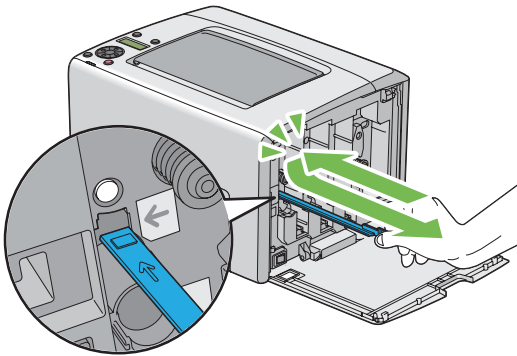

- 8 Repeat the same procedure for the other three holes.
- 9 Return the print head cleaning rod to its original location.

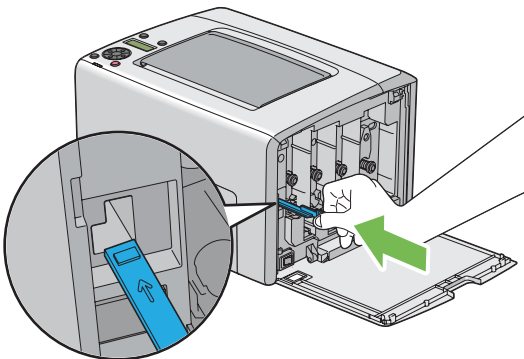

- 10 Replace the black toner cartridge by adjusting it to the associated cartridge holder, and then insert it firmly by pressing near the center of the label until the toner cartridge clicks.

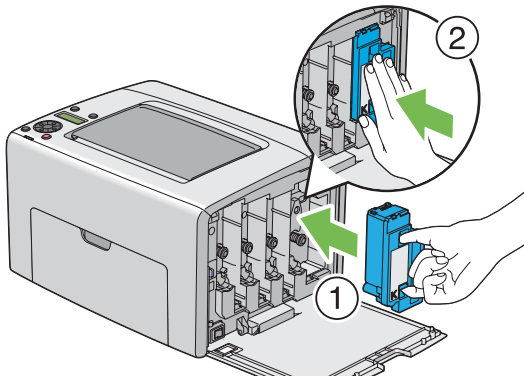

11 Replace the other three toner cartridges as well.

12 Close the toner access cover.

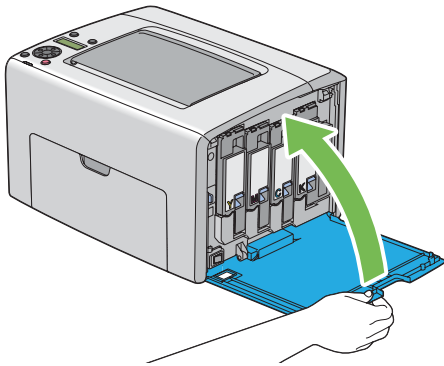

■ Cleaning the Color Toner Density (CTD) Sensor

Clean the CTD sensor only when an alert for the CTD sensor is shown on the Status Monitor window or operator panel.

- 1 Ensure that the printer is turned off.
- 2 Push the rear cover handle and open the rear door.

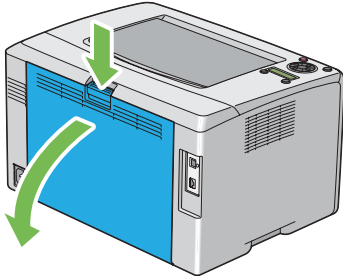

- 3 Clean the CTD sensor inside the printer with a clean dry cotton swab.

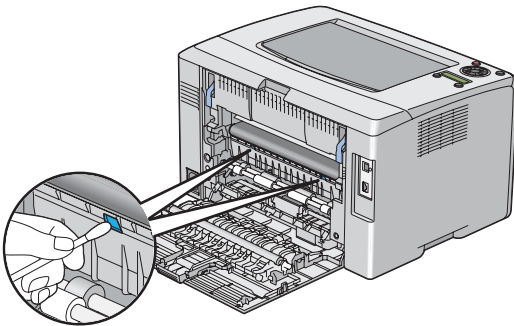

- 4 Close the rear door.

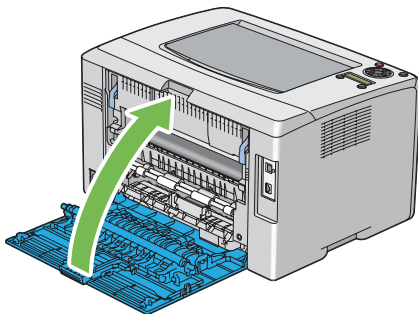

Replacing Toner Cartridges

Fuji Xerox toner cartridges are available only through Fuji Xerox.

It is recommended that you use Fuji Xerox toner cartridges for your printer. Fuji Xerox does not provide warranty coverage for problems caused by using accessories, parts, or components not supplied by Fuji Xerox.

WARNING:

- Use a broom or a wet cloth to wipe off spilled toner. Never use a vacuum cleaner for the spills. It may catch fire by electric sparks inside the vacuum cleaner and cause explosion. If you spill a large volume of toner, contact your local Fuji Xerox representative.
- Never throw a toner cartridge into an open flame. Remaining toner in the cartridge may catch fire and cause burn injuries or explosion. If you have a used toner cartridge no longer needed, contact your local Fuji Xerox representative for its disposal.

CAUTION:

- Keep toner cartridges out of the reach of children. If a child accidentally swallows toner, spit it out, rinse mouth with water, drink water and consult a physician immediately.
- When replacing toner cartridges, be careful not to spill the toner. In case of any toner spills, avoid contact with clothes, skin, eyes and mouth as well as inhalation.
- If toner spills onto your skin or clothing, wash it off with soap and water. If you get toner particles in your eyes, wash it out with plenty of water for at least 15 minutes until irritation is gone. Consult a physician if necessary. If you inhale toner particles, move to a fresh air location and rinse your mouth with water. If you swallow toner, spit it out, rinse your mouth with water, drink plenty of water and consult a physician immediately.

IMPORTANT:

- Do not shake the used toner cartridge to avoid spilling of the toner.
- Be sure to use the starter toner cartridge shipped with the printer until it gets empty, and then replace it with a purchased one.

This section includes:

- ["Overview" on page 244](#)
- ["Removing the Toner Cartridges" on page 245](#)
- ["Installing a Toner Cartridge" on page 246](#)

■ Overview

The printer has toner cartridges of four colors: black (K), yellow (Y), magenta (M), and cyan (C).

When a toner cartridge reaches its usable life-span, the following messages appear on the LCD panel (XXXX: Yellow, Magenta, Cyan, Or Black).

Message	Action
XXXX Low Replace Soon*	The specified toner cartridge has become low. Prepare a new one.
Replace XXXX Cartridge	The specified toner cartridge has become empty. Replace the old toner cartridge with a new one.
Empty XXXX Cartridge	The specified toner cartridge has become empty. Replace the old toner cartridge with a new one.

* This warning appears only when Fuji Xerox toner cartridges are used (Non-GenuineToner is set to Off.)

IMPORTANT:

- When placing a used toner cartridge on the floor or on a table, place a few sheets of paper under the toner cartridge to catch any toner that may spill.
- Do not reuse old toner cartridges once you remove them from the printer. Doing so can impair print quality.
- Do not shake or pound the used toner cartridges. The remaining toner may spill.
- We recommend you to use up the toner cartridges within one year after removing them from the packaging.

■ Removing the Toner Cartridges

- 1 Turn off the printer.
- 2 Open the toner access cover.

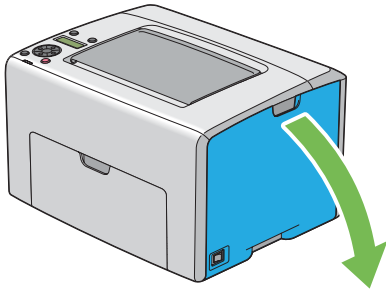

- 3 Spread a few sheets of paper on the floor or table where the removed toner cartridge is placed.
- 4 Pinch the toner cartridge firmly as shown in the illustration.

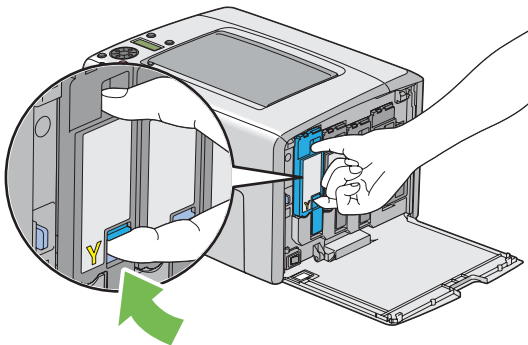

- 5 Pull the toner cartridge out.

IMPORTANT:

- Always pull the toner cartridge out slowly so you do not spill any toner.

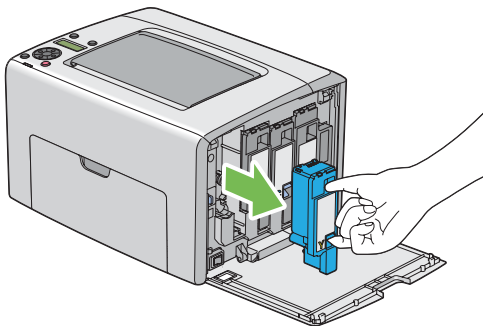

- 6 Place the toner cartridge slowly on the sheets of paper spread in step 3.

■ Installing a Toner Cartridge

- 1 Unpack a new toner cartridge of the desired color and shake it five to six times to distribute the toner evenly.

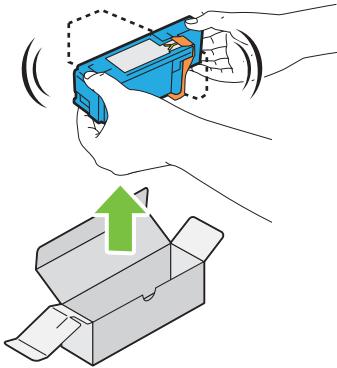

NOTE:

- Ensure that the color of the new toner cartridge matches that on the handle before replacing it.
- Handle the toner cartridge carefully to avoid spilling of the toner.

- 2 Remove the tape from the toner cartridge.

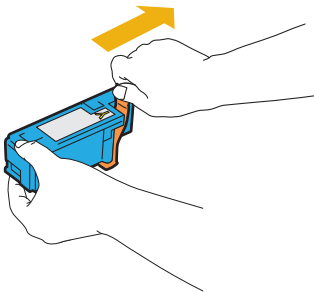

- 3 Adjust the toner cartridge to the associated cartridge holder, and then insert it firmly by pressing near the center of the label until the toner cartridge clicks.

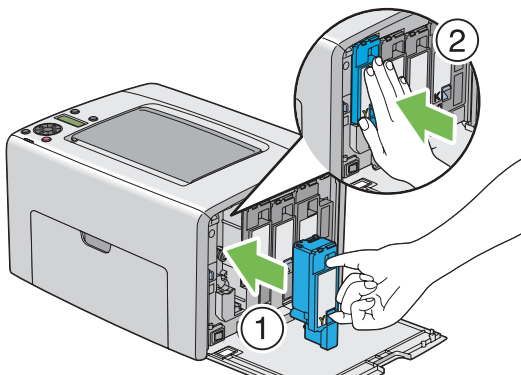

- 4 Close the toner access cover.

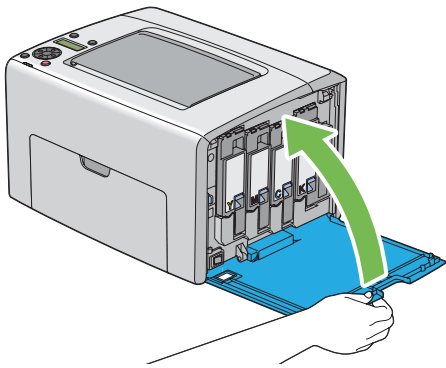

- 5** Pack the removed toner cartridge in the box in which the installed toner cartridge was packed up.
- 6** Take care not to contact with the spilled toner and remove the sheets of paper spread under the removed toner cartridge.

Ordering Supplies

This section includes:

- ["Consumables" on page 249](#)
- ["When to Order Toner Cartridges" on page 250](#)
- ["Recycling Supplies" on page 251](#)

The toner cartridges need to be ordered occasionally. Each toner cartridge includes installation instructions on the box.

■ Consumables

IMPORTANT:

- Use of consumables not recommended by Fuji Xerox can impair machine quality and performance. Use only consumables recommended by Fuji Xerox.

Product Name	Product Code	Printable number of pages
Toner Cartridge [Black]	CT201591	Approx. 2000 pages
Toner Cartridge [Yellow]	CT201594	Approx. 1400 pages
Toner Cartridge [Magenta]	CT201593	Approx. 1400 pages
Toner Cartridge [Cyan]	CT201592	Approx. 1400 pages

IMPORTANT:

- The printable number of pages are applicable when A4 paper SEF (□) is used and printing is done continuously at a density such that each toner covers 5% of the page. These values are estimates and vary depending on conditions such as the content being printed, paper size, paper type, the machine's operating environment, initializing process done when you turn on or off the printer, and adjustments to maintain print quality.

NOTE:

- The printable number of pages for the starter toner cartridges shipped with the printer are approximately 1000 pages for black toner cartridge and 700 pages for yellow, magenta, and cyan toner cartridges.
- Each toner cartridge includes installation instructions on the box.

■ When to Order Toner Cartridges

The LCD panel displays a warning when the toner cartridge nears its replacement time. Verify that you have replacements on hand. It is important to order a toner cartridge when the messages first appear to avoid interruptions to your printing. The LCD panel displays an error message when the toner cartridge must be replaced.

To order toner cartridges, contact the Fuji Xerox local representative office or an authorized dealer.

IMPORTANT:

- This printer is designed to provide the most stable performance and print quality when used with the recommended toner cartridges. Not using toner cartridges recommended for this machine degrades the performance and printing quality of the printer. You could also incur charges if the machine breaks down. To receive customer support and achieve the optimum performance of the printer, be sure to use recommended toner cartridges.

■ Recycling Supplies

- For environmental protection and efficient use of resources, Fuji Xerox reuses returned toner cartridges to make recycle parts, recycle materials or energy recovery.
- Proper disposal is required for toner cartridges no longer needed. Do not open toner cartridges containers. Return them to your local Fuji Xerox representative.
- To recover scarce resources, rechargeable batteries used in the returned machines are recycled as materials or reused for energy generation.

Storing Consumables

Store consumables in their original packaging until you need to use them. Do not store consumables in:

- Temperatures greater than 40 °C (140 °F).
- An environment with extreme changes in humidity or temperature.
- Direct sunlight.
- Dusty places.
- A car for a long period of time.
- An environment where corrosive gases are present.
- An environment with salty air.

Managing the Printer

This section includes:

- ["Checking or Managing the Printer with CentreWare Internet Services" on page 254](#)
- ["Checking Printer Status with SimpleMonitor \(Windows Only\)" on page 255](#)
- ["Checking Printer Status Through E-mail" on page 256](#)

■ Checking or Managing the Printer with CentreWare Internet Services

When the printer is installed in a TCP/IP environment, you can check printer status and configure settings using a web browser on a network computer. You can also use CentreWare Internet Services to check the remaining volume of consumables and the paper loaded in this printer.

NOTE:

- When using the printer as a local printer, you cannot use CentreWare Internet Services. For details about checking the status of a local printer, refer to "[Checking Printer Status with SimpleMonitor \(Windows Only\)](#)" on [page 255](#).

Starting CentreWare Internet Services

Use the following procedure to start CentreWare Internet Services.

- 1 Launch your web browser.
- 2 Enter the IP address of the printer in the address bar.
The CentreWare Internet Services page appears.

• Using Online Help

For details regarding the items that can be set in each CentreWare Internet Services screen, click the **Help** button to display the online Help.

■ Checking Printer Status with SimpleMonitor (Windows Only)

SimpleMonitor is a tool that is installed with your Fuji Xerox print driver. It automatically checks the printer status when you send a print job. SimpleMonitor can also check the status of the paper tray and remaining amount of toner cartridges.

Starting SimpleMonitor

Double-click the SimpleMonitor icon on the taskbar or right-click the icon and select **Select Printer**. If the SimpleMonitor icon is not displayed on the taskbar, open SimpleMonitor from the **start** menu. The following procedure uses Microsoft® Windows® XP as an example.

- 1 Click **start** → **All Programs** → **Fuji Xerox** → **SimpleMonitor for Asia-Pacific** → **Activate SimpleMonitor**.

The **Select Printer** window appears.

- 2 Click the name of the desired printer from the list.

The **Status Monitor** window appears.

For details about the functions of SimpleMonitor, refer to the online Help.

■ Checking Printer Status Through E-mail

When connected in a network environment where sending and receiving of e-mail is possible, the printer can send an e-mail report to specified e-mail addresses containing the following information:

- The network settings and the printer status
- The error status which has occurred on the printer

Setting the E-mail Environment

Activate CentreWare Internet Services. On the **Properties** tab, configure the following settings according to your e-mail environment. After configuring the settings on each screen, always click **Apply** and then turn off/on the printer to reboot. For details about each item, refer to the online Help for CentreWare Internet Services.

Item	Item to be configured	Description	
General Setup > StatusMessenger	Recipient's E-mail Address	Set the e-mail address to which notices about changes in printer status or errors are sent.	
	Notification Items	Set the contents of the notices to send in the e-mail.	
Port Status	StatusMessenger	Select the Enabled check box.	
Protocol Settings > E-mail	SMTP Server Settings <ul style="list-style-type: none"> • Machine's E-mail Address • SMTP Server Address • SMTP Server Port Number 	Select appropriate settings for sending and receiving e-mail.	
	Send Authentication <ul style="list-style-type: none"> • E-Mail Send Authentication • Login Name • Password • Re-enter Password • SMTP Server Connection Status 		
	POP3 Server Settings <ul style="list-style-type: none"> • POP3 Server Address • POP3 Server Port Number • Login Name • Password • Re-enter Password • POP3 Server Check Interval • APOP Settings • POP3 Server Connection Status 		
	Permitted E-mail Address		When setting the permission for checking information and changing the settings for an e-mail address, input the e-mail address that is permitted to receive the e-mail. If no address is input here, the printer receives e-mails from all users.
	StatusMessenger Password		Set the password for access to the printer.

Checking the Printer Status with E-mail

This section describes cautions when sending e-mail to the printer to check the printer status.

- You can specify any title for the e-mail when checking the printer status or changing the printer settings.
- Use the commands described in the next section to create the text of the e-mail.

• Commands That Can Be Used in E-mail Text

Use each command according to the following rules:

- Prefix all commands with “#”, and specify the #Password command at the top of the e-mail.
- Command lines without “#” are ignored.
- Write one command on each line and separate each command and parameter with a space or a tab.

When the same command is written two or more times in one e-mail, the second and subsequent commands are ignored.

Command	Parameter	Description
#Password	Password	Use this command at the top of the e-mail when a password is set. You can omit this command when the password is not set.
#NetworkInfo		Set this when you want to check information on the network settings list.
#Status		Set this when you want to check the printer status.

• Example of Commands

- When the read only password is “ronly”, and to check the printer status:

```
#Password ronly
```

```
#Status
```

```
#NetworkInfo
```

Conserving Supplies

You can change a setting in your print driver to conserve paper.

Supply	Setting	Function
Print media	Multiple-Up in the Layout tab of the print driver	<p>The printer prints two or more pages on one side of a sheet. The available numbers that each print driver can print one sheet of paper are as follows:</p> <ul style="list-style-type: none">• Microsoft Windows Print Driver: 2, 4, 8, 16, or 32 pages• Mac OS® X Print Driver: 2, 4, 6, 9 or 16 pages <p>Combined with the duplex setting, Multiple-Up allows you to print up to 64 pages on one sheet of paper. (32 images on the front and 32 on the back)</p>

Checking Page Counts

The total number of printed pages can be checked at the operator panel. Four meters are available: `Meter 1` (color prints), `Meter 2` (monochrome prints), `Meter 3` (large size color prints), and `Meter 4` (`Meter 1 + Meter 2`).

The `Billing Meters` counts the number of pages printed properly. Single side color print (including Multiple-Up) is counted as one job, and 2-sided print (including Multiple-Up) is counted as two. During 2-sided printing, if an error occurs after one side is printed properly, it is counted as one.



When printing color data, which has been converted by using ICC profile on an application, with the Color setting, the data is printed by color even if it seems to be black and white data on the monitor. In that case, `Meter 1` and `Meter 4` are increased.

When doing 2-sided printing, a blank page may be inserted automatically depending on the settings of the application. In this case, the blank page is counted as one page. However, when doing 2-sided printing for odd number of pages, the blank page inserted to the rear side of the last odd page is not counted.

See also:

- ["Billing Meters" on page 166](#)

Use the following procedure to check a meter:

- 1 Press the  (**Menu**) button.
- 2 Select `Billing Meters`, and then press the  button.
- 3 Check the values for each meter.

Moving the Printer

NOTE:

- The front side of this printer is heavier than the rear. Take note of this difference in weight when moving the printer.

- 1 Turn off the printer.

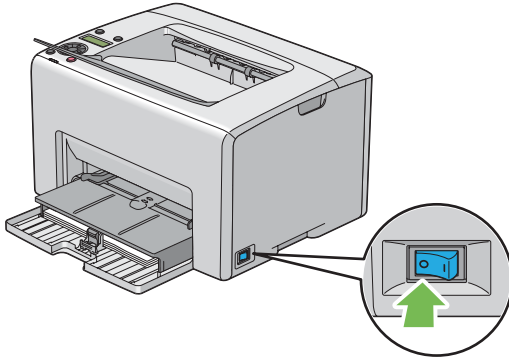

- 2 Disconnect the power cord and the interface cable.

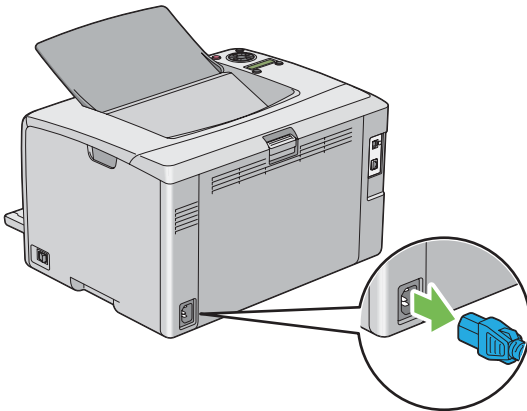

- 3 Remove any paper in the center output tray if there is. Close the output tray extension if it is opened.

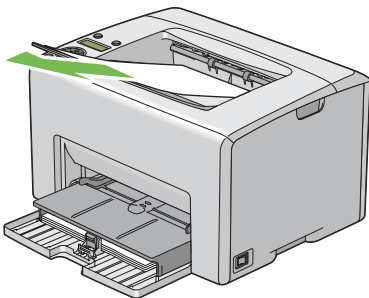

- 4 Remove any paper in the priority sheet inserter (PSI) or multipurpose feeder (MPF). Keep the paper wrapped and away from humidity and dirt.

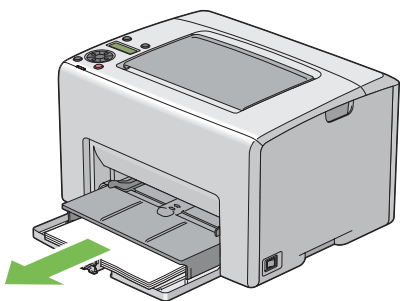

5 Push the PSI in.

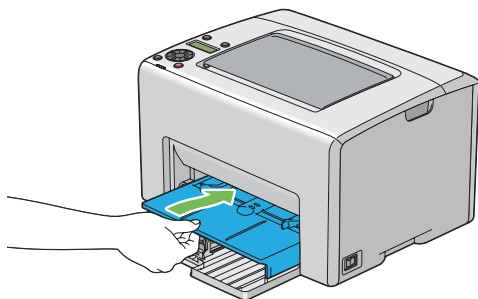

6 Slide the slide bar backward until it stops.

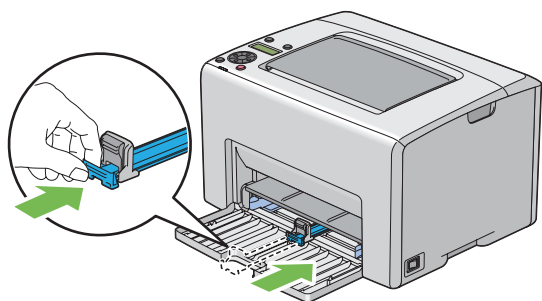

7 Close the front cover.

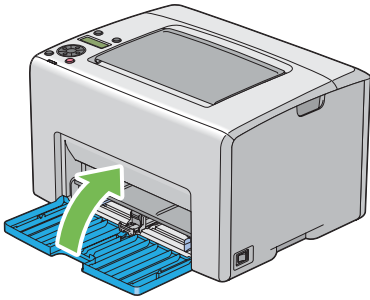

8 Lift the printer and move it gently.

NOTE:

- If the printer is to be moved over a long distance, the toner cartridges should be removed to prevent toner from spilling and the printer should be packed inside a box.



9 Adjust the color registration before using your printer.

See also:

- ["Adjusting Color Registration" on page 216](#)

Contacting Fuji Xerox

This chapter includes:

- ["Technical Support" on page 266](#)
- ["Online Services" on page 267](#)

Technical Support

Fuji Xerox recommends the Customer first utilize support materials shipped with the product, product diagnostics, information contained on the Web, and email support. If unsuccessful, to obtain service under product warranty the Customer must notify Fuji Xerox Telephone Support or its authorized service representative of the defect before the expiration of the warranty period. Customer will provide appropriate assistance to Telephone Support personnel to resolve issues, such as restoration of the operating system, software program and drivers to their default configuration and settings, verification of functionality of Fuji Xerox supplied products, replacement of customer replaceable units, clearing paper misfeeds and cleaning the unit and other prescribed routine and preventative maintenance.

If the Customer's product contains features that enable Fuji Xerox or its authorized service representative to diagnose and repair problems with the product remotely, Fuji Xerox may request that the Customer allow such remote access to the product.

Online Services

You can find detail Product and Consumable warranty information and activate your warranty by registering your details on our website at <http://www.fujixerox.com/support/docuprint/>

Fuji Xerox Online Support Assistant provides instructions and troubleshooting guides to resolve your printer problems. It is an easy-to-use, searchable online help. To find out more, please visit our online support at <http://www.fujixerox.com/support/docuprint/>

Index

A

Adj. Fusing Unit 174
Adjust Altitude 177
Adjust BTR 174
Adjust ColorRegi 175
Adjust PaperType 173
Adjusting color registration 216
Admin Menu 167
Auto Log Print 172
Auto Regi Adj 175
Avoiding jam 187

B

Back Button 33
Basic Printer Problem 195
Billing Meters 166
 Total Printed Pages 260
Bond 174, 175
BTR Refresh 176

C

Cancel Job Button 33
Canceling a job 147
Canceling print job
 From computer 147
Center Output Tray 31, 188
CentreWare Internet Services
 Managing printer 254
 Online help for 254
 Starting 254
Change Password 178
Chart 176
Checking printed pages
 How to check the meter 260
Clear Developer 176
Clearing jam 186
Clearing paper jam
 From back of the printer 190
 From center output tray 192
 From front of the printer 189
Color Registration Chart 218
Configuring wireless settings 70
Connecting printer 51
Connection specification 51
Connection type 51
Conserving supplies 259
Consumables 249
Contacting Service 228
CTD Sensor 242

D

Demo Page 165
Determining values 219
Display Problem 196

E

Electrical Safety 12
E-mail
 Commands for 258
Email Alerts 170
Energy Saver Button/Indicator 33
Entering values 220
Envelope 174, 175
Error and Warning Messages 231
Error Indicator 33
Ethernet Port 32, 51

F

F/W Version 173
Fault Time-Out 172
Front Cover 31, 188

G

Getting help 229
 SimpleMonitor Alerts 231

H

Host Access List 170
How to check the meter 260

I

Init Wireless 169
Initialize NVM 177
Installing 64
Installing a toner cartridge 246
InternetServices 170

J

Jam 194
Job History 165
JP Gloss Card 174, 175

L

Labels 174, 175
Launcher 47
LCD 33
LCD Panel 33

- Messages 230
- Length Guide 31
- Levers 32, 188
- Light Card 174, 175
- Liquid Crystal Display 33
- Loading envelope 129, 136
- Loading letterhead 133, 139
- Loading postcard 132, 138
- Loading print media 122
 - MPF 125
 - PSI 134
- Loading print media in multipurpose feeder (MPF) 125
- Loading print media in priority sheet inserter (PSI) 134
- Login Error 178
- Low Toner Msg 173
- LPR 169
- LW Gloss Card 174, 175

M

- Main components 30
- Managing
 - printer 253
- Manual Duplex Printing 140
- Menu Button 33
- Messages
 - SimpleMonitor 231
- Meters
 - Total Page Counts 260
- mm/inch 172
- Mottle 207
- Moving
 - Printer 261
- Multiple-Up 259
- Multipurpose feeder (MPF) 31, 188

N

- Network basics 49
- Network connection setup 69
- Network Setup 167
- Non-GenuineToner 177

O

- OK Button 33
- Operator Panel 31
- Ordering supplies 250
- Output Tray Extension 31, 144

P

- Panel Lock 178, 179
- Panel Lock Set 178
- Panel Settings 165

- Panel Settings Page 35
- Paper Chute 32
- Paper Feed Roller 32
- Paper Jam Location 188
- Paper Width Guides 31, 127
- Parts name 30
- Peer-to-peer 99
- Plain 174
- Point and Print 96
- Port9100 170
- Postcard 174, 175
- Power Connector 32
- Power Switch 31
- PowerSaver Time 171, 182
- Print driver (Mac OS X)
 - Installing print driver 103
- Print driver installing 64
- Print driver pre-install status 65
- Print Head Cleaning Rod 31
- Print Media 259
 - Dimensions 124
- Print Quality Problems 199
- Printer
 - Managing 253
 - Moving 261
- Printer Settings 165
- Printer software 41
- Printer status
 - Checking via e-mail 258
 - StatusMessenger 256
- Printing 145
 - Custom Paper 153
 - With Mac OS X driver 154
 - With Windows print driver 154
- Printing Basics 111
- Printing Problem 197
- Printing with WSD 159
- Priority Sheet Inserter (PSI) 31, 188
- Product Features 23

R

- Ready Indicator 33
- Rear Cover Handle 32
- Rear Door 32, 188
- Recycled 174, 175
- Recycling supplies 251
- Removing the toner cartridges 245
- Report Page 156
- Reset Defaults 170
- Resetting to defaults 183

S

- Safety

- Electrical 12
- Operational 16
- Secure Settings 177
- Sending print job 146
- Setting 259
- SimpleMonitor
 - Alerts 231
- Slide Bar 31
- SNMP 170
- Specification 25
- StatusMessenger
 - Checking printer status 256
 - Commands 258
 - Configuring 257
- Storing consumables 252

T

- Time-Out 172
- Toner Access Cover 31
- Toner Refresh 176
- Transfer Belt 32, 188
- Transfer Roller 32

U

- USB Port 32, 51
- USB Setup
 - Port Status 171
- User Setup Disk Creating Tool 48

W

- Warning and Error Messages 231
- When to order toner cartridges 250
- Wired network
 - Ethernet 167
 - Protocol 169
- Wireless LAN 170
- Wireless Setup 168
- Wireless Status 167

Free Manuals Download Website

<http://myh66.com>

<http://usermanuals.us>

<http://www.somanuals.com>

<http://www.4manuals.cc>

<http://www.manual-lib.com>

<http://www.404manual.com>

<http://www.luxmanual.com>

<http://aubethermostatmanual.com>

Golf course search by state

<http://golfingnear.com>

Email search by domain

<http://emailbydomain.com>

Auto manuals search

<http://auto.somanuals.com>

TV manuals search

<http://tv.somanuals.com>