



AGES 5+

20574/20570 Asst.

WARNING:
CHOKING HAZARD—Small parts.
Not for children under 3 years.

COMPOUND NET WT. 6 OZ. (170 g)
GEL NET WT. 6 FLUID OZ. (177 ml)

CONTENTS: Spaceship playset (7 pieces), 14 alien half-molds, plastic knife, roller, tweezers, cutter, 3 two-ounce bottles of LUNAR LAVA™ gel (net wt. 6 fl. oz., 177 ml) and 3 two-ounce cans of METEOR MUD™ compound (net wt. 6 oz., 170 g).

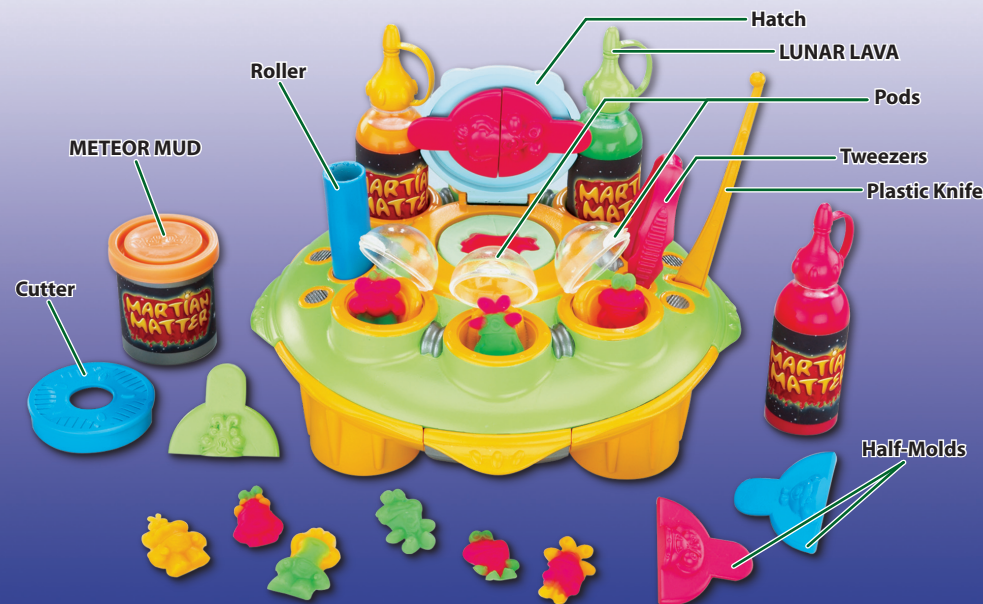

Stain Advisement: Note that LUNAR LAVA™ gel may stain some surfaces. Adult supervision is recommended. Wash with soap and warm water.

Cleaning up METEOR MUD™ compound: If spilt, remove excess compound, allow to dry, then scrape or vacuum deposits away. Always put compound back in container after play. Store in a cool place. If necessary, water may be added one drop at a time to restore softness.

NOT A FOOD ITEM. NONTOXIC.

Molded results vary depending on child's age and level of skill. Product and colors may vary.

NOTICE TO PARENTS: CONTAINS WHEAT.



© 2007 Hasbro. All Rights Reserved.
TM & ® denote U.S. Trademarks.
U.S. Patent No. 6713624.

Questions? Call: 1-800-327-8264

P/N 6732380000



ASSEMBLY

1 Place drawer in lower half of spaceship...

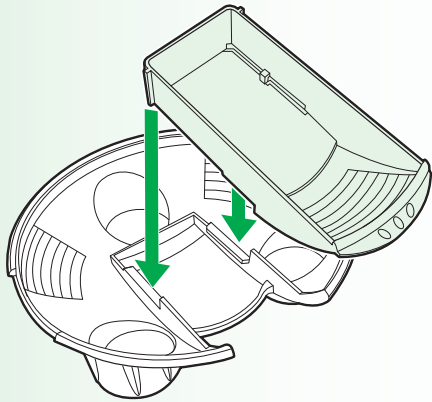

...and slide it inside.

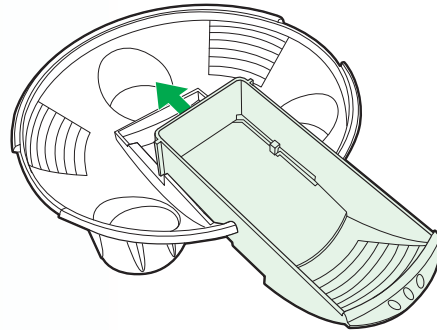

2 Place top half of spaceship on bottom half of spaceship.

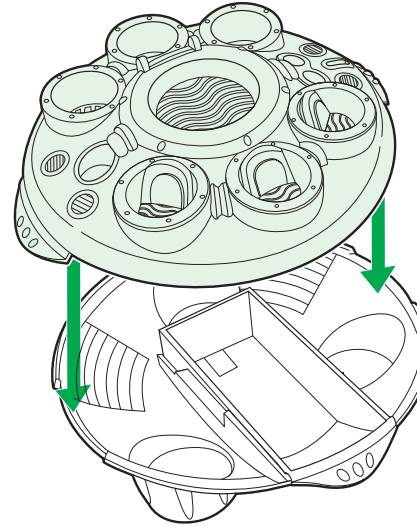

3 Snap hatch onto spaceship.

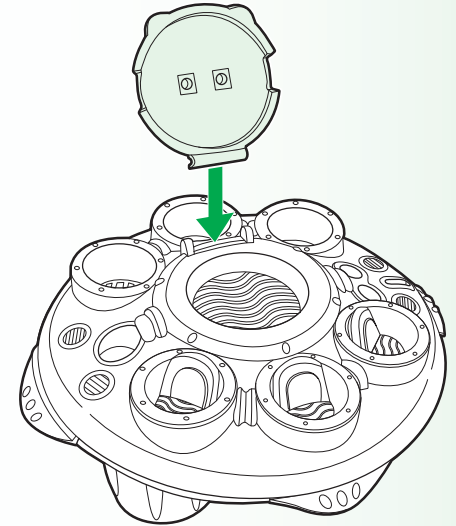

4 Place domes on top of pods.

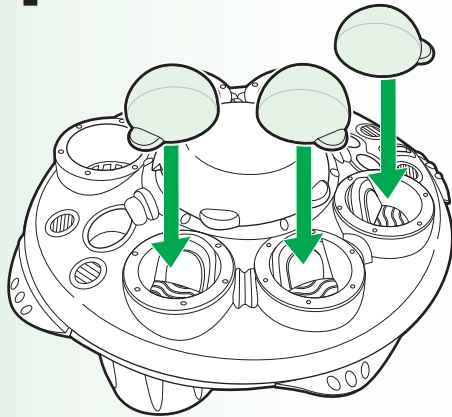

5 Slide out drawer and place alien half-molds inside.

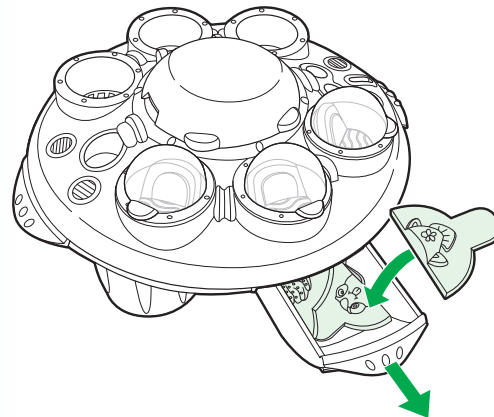

(If they don't all fit in the drawer, you can store them inside the spaceship by lifting the top half and placing them inside.)

Place LUNAR LAVA™ bottles...

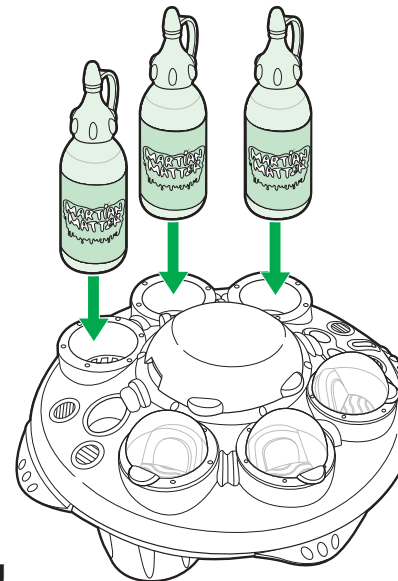

...tweezers, roller, and plastic knife in the holders on spaceship.

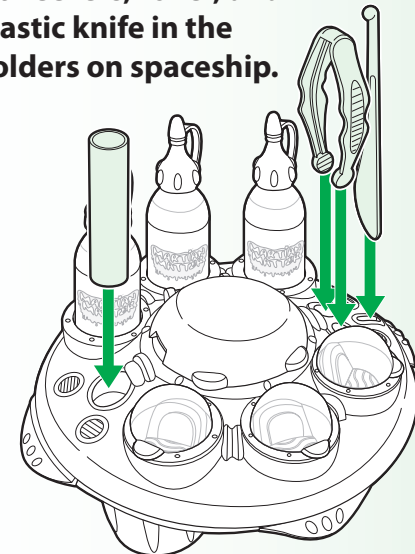

(The METEOR MUD cans and cutter can be stored inside the spaceship.)

CREATE ALIENS

1 Open hatch and fill chamber with METEOR MUD™ compound all the way to the rim.

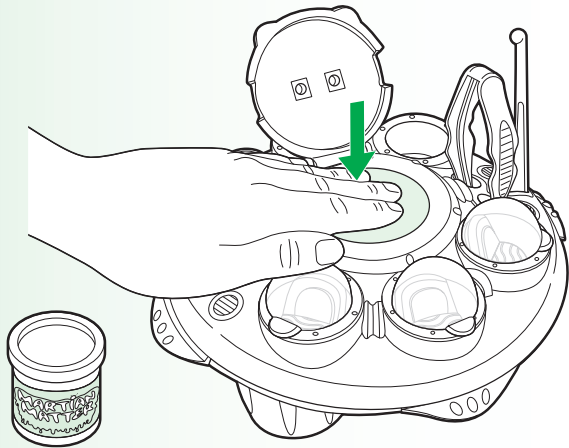

4 Open hatch. The METEOR MUD™ now has an impression of your alien in it.

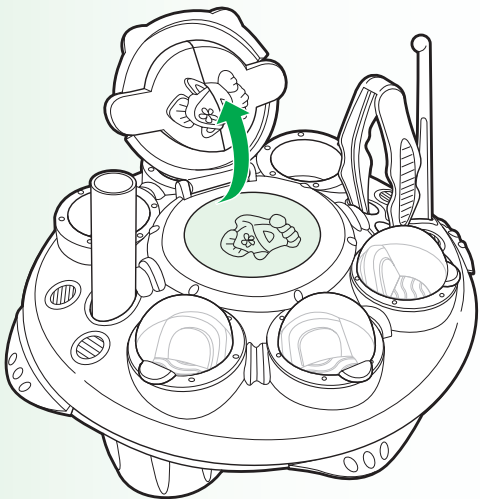

2 Open drawer and remove alien half-molds. Choose two half-molds and snap them into the underside of the hatch.

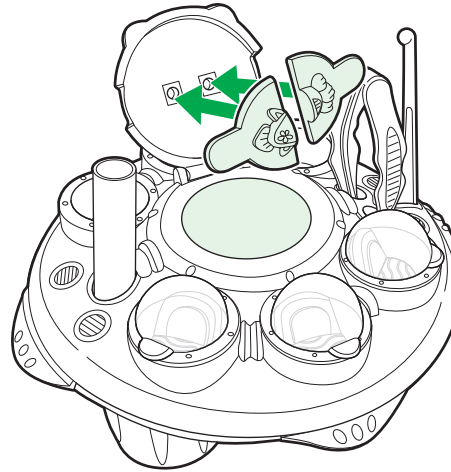

(You can make over 90 different aliens using different half-mold combinations!)

Head to head...



Head to body...



Body to body...



5 Fill impression with LUNAR LAVA™ gel all the way to the top, but do not overfill it.

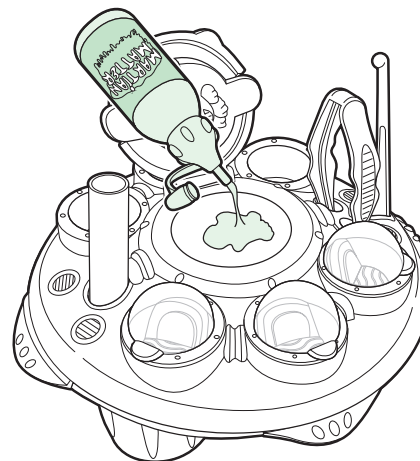

(You can use one color or combine the colors to create a multi-colored alien.)

3 Close hatch and push it down until it closes. (This presses the half-molds into the METEOR MUD™.)

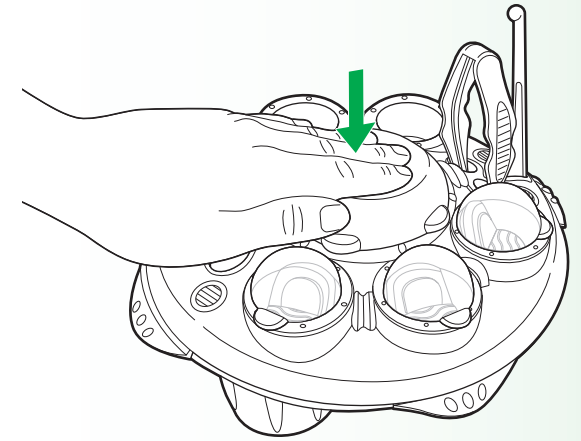

6 Place some METEOR MUD™ on a flat surface and roll it out with the roller.

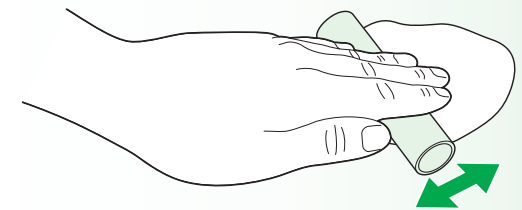

Press cutter into METEOR MUD to cut out a disc.

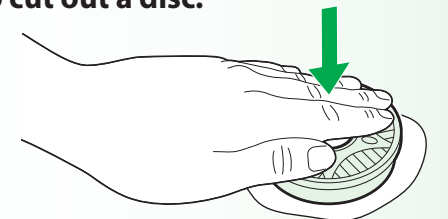

- 7** Place METEOR MUD™ compound disc on top of filled alien impression, and gently pat it down.

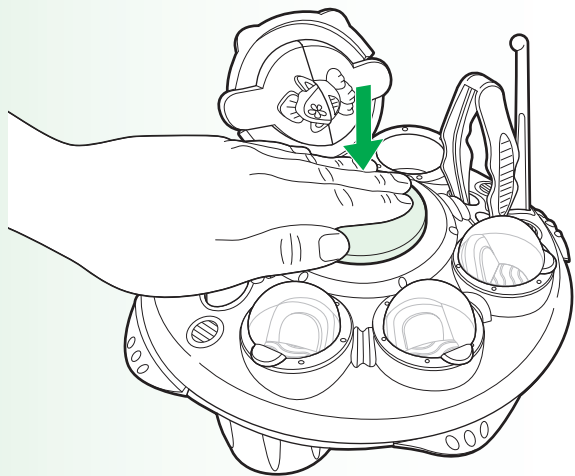

- 8** Let alien sit for 3-5 minutes to give LUNAR LAVA™ gel time to harden.

• TIP: If you'd like to make another alien while the first one is hardening, use the plastic knife to carefully remove the filled METEOR MUD™ from the chamber. Place off to the side for 3-5 minutes.

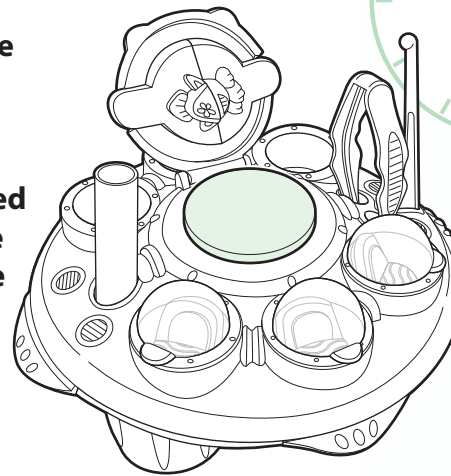

• TIP: For an alien with gooey guts, remove alien from METEOR MUD™ after 3 minutes. To create a solid alien, leave it in the METEOR MUD™ for the full 5 minutes.

- 9** After allowing LUNAR LAVA™ time to harden, remove METEOR MUD™ disc...

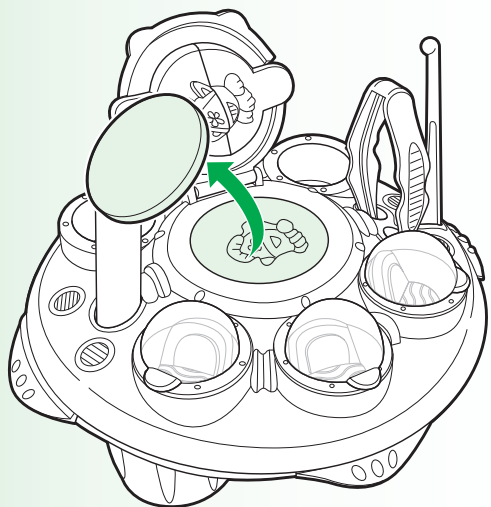

...and lift alien out of the METEOR MUD™ impression.

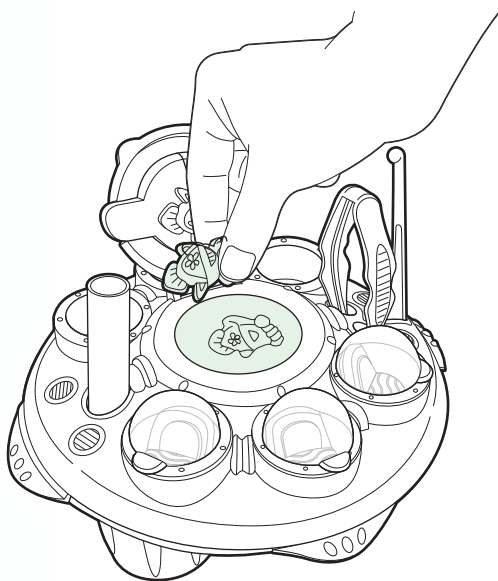

Use the plastic knife to cut away any excess LUNAR LAVA™ from alien.



• NOTE: METEOR MUD™ is reusable! To make more aliens, repeat steps 1–9.

ALIEN ACTIVITIES

- Put aliens in the pods so they can “fly” the spaceship.
- Dissect aliens with the plastic knife and tweezers!
- Flatten them with the roller (really fun when they have gooey guts!).

Use your imagination to dream up more adventures and experiments for your aliens!

ATMOSPHERE ALERT

These aliens are not from this planet, so they cannot “live” long in our atmosphere. When they are exposed to oxygen for too long, they shrivel up and become hard and dry. They will “live” longer if you keep them in the spaceship pods or an airtight container (not included).

Free Manuals Download Website

<http://myh66.com>

<http://usermanuals.us>

<http://www.somanuals.com>

<http://www.4manuals.cc>

<http://www.manual-lib.com>

<http://www.404manual.com>

<http://www.luxmanual.com>

<http://aubethermostatmanual.com>

Golf course search by state

<http://golfingnear.com>

Email search by domain

<http://emailbydomain.com>

Auto manuals search

<http://auto.somanuals.com>

TV manuals search

<http://tv.somanuals.com>