

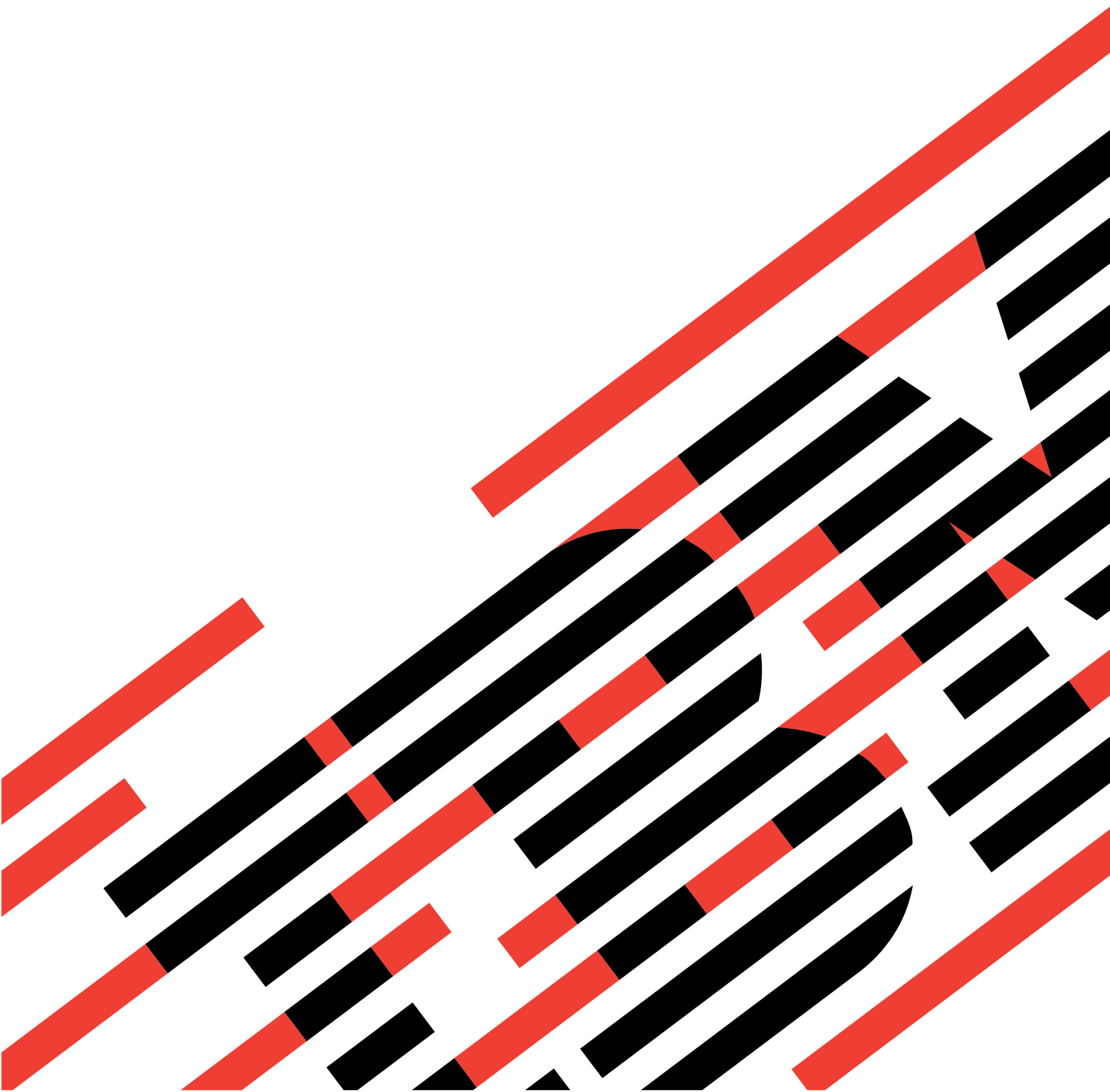

@server

xSeries 445 Type 8870

User's Guide







@server

xSeries 445 Type 8870

User's Guide

**Note:** Before using this information and the product it supports, read the general information in Appendix A, “Getting help and technical assistance,” on page 71, and Appendix B, “Notices,” on page 73.

**Second Edition (January 2004)**

**© Copyright International Business Machines Corporation 2004. All rights reserved.**

US Government Users Restricted Rights – Use, duplication or disclosure restricted by GSA ADP Schedule Contract with IBM Corp.

---

# Contents

<b>Safety</b> . . . . .	v
<b>Chapter 1. Introducing the IBM xSeries 445 server</b> . . . . .	1
Related documentation . . . . .	1
Notices and statements used in this document. . . . .	2
Features and specifications. . . . .	3
What your server offers . . . . .	4
Reliability, availability, and serviceability features . . . . .	6
Active Memory . . . . .	7
Memory scrubbing and Memory ProteXion . . . . .	7
Memory mirroring . . . . .	7
The UpdateXpress program . . . . .	7
IBM Director . . . . .	8
Server controls, LEDs, and power . . . . .	9
Front view . . . . .	9
Rear view . . . . .	11
Server power features . . . . .	14
<b>Chapter 2. Configuring the server</b> . . . . .	17
Using the Configuration/Setup Utility program . . . . .	18
Starting the Configuration/Setup Utility program . . . . .	18
Configuration/Setup Utility menu choices . . . . .	18
Configuring scalable partitions . . . . .	22
Remote console redirection . . . . .	24
Passwords . . . . .	25
Using the ServerGuide Setup and Installation CD . . . . .	27
ServerGuide features . . . . .	27
Setup and configuration overview . . . . .	28
Typical operating-system installation . . . . .	28
Installing your operating system without ServerGuide . . . . .	29
Configuring the Gigabit Ethernet controller. . . . .	30
Using the Integrated System Management Firmware Update Utility program . . . . .	30
Using the LSI Logic Configuration Utility program . . . . .	30
Using ServeRAID Manager . . . . .	31
Configuring the controller . . . . .	32
Viewing the configuration . . . . .	36
Getting assistance . . . . .	37
Remote Supervisor Adapters . . . . .	39
Identifying the Remote Supervisor Adapter. . . . .	39
Setting up the Remote Supervisor Adapter II-EXA . . . . .	40
Setting up the Remote Supervisor Adapter. . . . .	52
Using the PXE boot agent utility program . . . . .	70
Starting the PXE boot agent utility program . . . . .	70
PXE boot agent utility menu choices . . . . .	70
<b>Appendix A. Getting help and technical assistance</b> . . . . .	71
Before you call . . . . .	71
Using the documentation . . . . .	71
Getting help and information from the World Wide Web . . . . .	72
Software service and support . . . . .	72
Hardware service and support . . . . .	72
<b>Appendix B. Notices</b> . . . . .	73

Edition notice . . . . .	73
Trademarks . . . . .	74
Important notes. . . . .	75
Product recycling and disposal . . . . .	75
Battery return program . . . . .	76
Electronic emission notices . . . . .	76
Federal Communications Commission (FCC) statement . . . . .	76
Industry Canada Class A emission compliance statement . . . . .	77
Australia and New Zealand Class A statement . . . . .	77
United Kingdom telecommunications safety requirement. . . . .	77
European Union EMC Directive conformance statement. . . . .	77
Taiwanese Class A warning statement . . . . .	77
Chinese Class A warning statement . . . . .	78
Japanese Voluntary Control Council for Interference (VCCI) statement . . . . .	78
Power cords . . . . .	78
<b>Index . . . . .</b>	<b>81</b>

# Safety

Before installing this product, read the Safety Information.

قبل تركيب هذا المنتج، يجب قراءة الملاحظات الأمنية

Antes de instalar este produto, leia as Informações de Segurança.

在安装本产品之前，请仔细阅读 **Safety Information** (安全信息)。

安裝本產品之前，請先閱讀「安全資訊」。

Prije instalacije ovog produkta obavezno pročitajte Sigurnosne Upute.

Před instalací tohoto produktu si přečtěte příručku bezpečnostních instrukcí.

Læs sikkerhedsforskrifterne, før du installerer dette produkt.

Lees voordat u dit product installeert eerst de veiligheidsvoorschriften.

Ennen kuin asennat tämän tuotteen, lue turvaohjeet kohdasta Safety Information.

Avant d'installer ce produit, lisez les consignes de sécurité.

Vor der Installation dieses Produkts die Sicherheitshinweise lesen.

Πριν εγκαταστήσετε το προϊόν αυτό, διαβάστε τις πληροφορίες ασφαλείας (safety information).

לפני שתתקינו מוצר זה, קראו את הוראות הבטיחות.

A termék telepítése előtt olvassa el a Biztonsági előírásokat!

Prima di installare questo prodotto, leggere le Informazioni sulla Sicurezza.

製品の設置の前に、安全情報をお読みください。

본 제품을 설치하기 전에 안전 정보를 읽으십시오.

Пред да се инсталира овој продукт, прочитајте информацијата за безбедност.

Les sikkerhetsinformasjonen (Safety Information) før du installerer dette produktet.

Przed zainstalowaniem tego produktu, należy zapoznać się z książką "Informacje dotyczące bezpieczeństwa" (Safety Information).

Antes de instalar este produto, leia as Informações sobre Segurança.

Перед установкой продукта прочтите инструкции по технике безопасности.

Pred inštaláciou tohto zariadenia si pečítajte Bezpečnostné predpisy.

Pred namestitvijo tega proizvoda preberite Varnostne informacije.

Antes de instalar este producto, lea la información de seguridad.

Läs säkerhetsinformationen innan du installerar den här produkten.

**Statement 1:**



**DANGER**

**Electrical current from power, telephone, and communication cables is hazardous.**

**To avoid a shock hazard:**

- **Do not connect or disconnect any cables or perform installation, maintenance, or reconfiguration of this product during an electrical storm.**
- **Connect all power cords to a properly wired and grounded electrical outlet.**
- **Connect to properly wired outlets any equipment that will be attached to this product.**
- **When possible, use one hand only to connect or disconnect signal cables.**
- **Never turn on any equipment when there is evidence of fire, water, or structural damage.**
- **Disconnect the attached power cords, telecommunications systems, networks, and modems before you open the device covers, unless instructed otherwise in the installation and configuration procedures.**
- **Connect and disconnect cables as described in the following table when installing, moving, or opening covers on this product or attached devices.**

**To Connect:**

1. Turn everything OFF.
2. First, attach all cables to devices.
3. Attach signal cables to connectors.
4. Attach power cords to outlet.
5. Turn device ON.

**To Disconnect:**

1. Turn everything OFF.
2. First, remove power cords from outlet.
3. Remove signal cables from connectors.
4. Remove all cables from devices.



**Statement 2:**



**CAUTION:**

When replacing the lithium battery, use only IBM Part Number 33F8354 or an equivalent type battery recommended by the manufacturer. If your system has a module containing a lithium battery, replace it only with the same module type made by the same manufacturer. The battery contains lithium and can explode if not properly used, handled, or disposed of.

*Do not:*

- Throw or immerse into water
- Heat to more than 100°C (212°F)
- Repair or disassemble

Dispose of the battery as required by local ordinances or regulations.

**Statement 3:**



**CAUTION:**

When laser products (such as CD-ROMs, DVD drives, fiber optic devices, or transmitters) are installed, note the following:

- Do not remove the covers. Removing the covers of the laser product could result in exposure to hazardous laser radiation. There are no serviceable parts inside the device.
- Use of controls or adjustments or performance of procedures other than those specified herein might result in hazardous radiation exposure.



**DANGER**

Some laser products contain an embedded Class 3A or Class 3B laser diode. Note the following.

Laser radiation when open. Do not stare into the beam, do not view directly with optical instruments, and avoid direct exposure to the beam.

**Statement 4:**



≥ 18 kg (39.7 lb)



≥ 32 kg (70.5 lb)

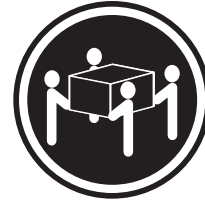

≥ 55 kg (121.2 lb)

**CAUTION:**

Use safe practices when lifting.

**Statement 5:**



**CAUTION:**

The power control button on the device and the power switch on the power supply do not turn off the electrical current supplied to the device. The device also might have more than one power cord. To remove all electrical current from the device, ensure that all power cords are disconnected from the power source.



**Statement 8:**



**CAUTION:**

Never remove the cover on a power supply or any part that has the following label attached.



Hazardous voltage, current, and energy levels are present inside any component that has this label attached. There are no serviceable parts inside these components. If you suspect a problem with one of these parts, contact a service technician.

**Statement 10:**



**CAUTION:**

Do not place any object weighing more than 82 kg (180 lb) on top of rack-mounted devices.



>82 kg (180 lb)

**Statement 13:**



**DANGER**

Overloading a branch circuit is potentially a fire hazard and a shock hazard under certain conditions. To avoid these hazards, ensure that your system electrical requirements do not exceed branch circuit protection requirements. Refer to the information that is provided with your device for electrical specifications.

**WARNING:** Handling the cord on this product or cords associated with accessories sold with this product, will expose you to lead, a chemical known to the State of California to cause cancer, and birth defects or other reproductive harm. ***Wash hands after handling.***

**ADVERTENCIA:** El contacto con el cable de este producto o con cables de accesorios que se venden junto con este producto, pueden exponerle al plomo, un elemento químico que en el estado de California de los Estados Unidos está considerado como un causante de cancer y de defectos congénitos, además de otros riesgos reproductivos. ***Lávese las manos después de usar el producto.***

---

## Chapter 1. Introducing the IBM xSeries 445 server

Your IBM® eServer™ xSeries® 445 server is a 4-U-high<sup>1</sup> rack model server for high-volume network transaction processing. This high-performance server is ideally suited for networking environments that require superior microprocessor performance, efficient memory management, flexibility, and reliable data storage.

Performance, ease of use, reliability, and expansion capabilities were key considerations in the design of your server. These design features make it possible for you to customize the system hardware to meet your needs today and provide flexible expansion capabilities for the future.

Your server contains IBM Enterprise X-Architecture™ technologies, which help increase performance and reliability. For more information, see “What your server offers” on page 4 and “Reliability, availability, and serviceability features” on page 6.

For service or assistance information, see Appendix A, “Getting help and technical assistance,” on page 71.

The xSeries 445 server comes with a limited warranty. For more information about the terms of your warranty, see the *IBM xSeries 445 Installation Guide*.

You can obtain up-to-date information about your server and other IBM server products at <http://www.ibm.com/eserver/xseries/>.

The machine type and serial number are located on the ID label located on the left side of the bezel, just above the hard disk drives. You will need these numbers when you register your server with IBM.

---

### Related documentation

This *User's Guide* provides general information about your server, including information about features, how to configure the server, and how to get help. In addition to this *User's Guide*, the following documentation comes with your server:

- *Installation Guide*

This printed document contains instructions for setting up your server and basic instructions for installing some options.

- *Option Installation Guide*

This document is in Portable Document Format (PDF) on the IBM *xSeries Documentation* CD. It contains detailed instructions for installing, removing, and connecting optional devices that your server supports.

- *Safety Information*

This document is in PDF on the IBM *xSeries Documentation* CD. It contains translated caution and danger statements. Each caution and danger statement that appears in the documentation has a number that you can use to locate the corresponding statement in your language in the *Safety Information* document.

- *Rack Installation Instructions*

This printed document contains instructions for installing your server in a rack.

---

1. Racks are marked in vertical increments of 1.75 inches each. Each increment is referred to as a unit, or “U.” A 1-U-high device is 1.75 inches tall.

- *Hardware Maintenance Manual and Troubleshooting Guide*

This document is in PDF on the IBM *xSeries Documentation* CD. It contains information to help you solve problems yourself, and it contains information for service technicians.

Depending on your server model, additional documentation might be included on the IBM *xSeries Documentation* CD.

Your server might have features that are not described in the documentation that you received with the server. The documentation might be updated occasionally to include information about those features, or technical updates might be available to provide additional information that is not included in your server documentation. These updates are available from the IBM Web site. Complete the following steps to check for updated documentation and technical updates:

1. Go to <http://www.ibm.com/pc/support/>.
2. In the **Learn** section, click **Online publications**.
3. On the “Online publications” page, in the **Brand** field, select **Servers**.
4. In the **Family** field, select **xSeries 445**.
5. Click **Continue**.

---

## Notices and statements used in this document

The caution and danger statements that appear in this document are also in the multilingual *Safety Information* document, which is on the IBM *xSeries Documentation* CD. Each statement is numbered for reference to the corresponding statement in the *Safety Information* document.

The following notices and statements are used in this document:

- **Notes:** These notices provide important tips, guidance, or advice.
- **Important:** These notices provide information or advice that might help you avoid inconvenient or problem situations.
- **Attention:** These notices indicate potential damage to programs, devices, or data. An attention notice is placed just before the instruction or situation in which damage could occur.
- **Caution:** These statements indicate situations that can be potentially hazardous to you. A caution statement is placed just before the description of a potentially hazardous procedure step or situation.
- **Danger:** These statements indicate situations that can be potentially lethal or extremely hazardous to you. A danger statement is placed just before the description of a potentially lethal or extremely hazardous procedure step or situation.

## Features and specifications

The following information is a summary of the features and specifications of your server.

<p><b>Microprocessor:</b></p> <ul style="list-style-type: none"> <li>Supports the following microprocessors: <ul style="list-style-type: none"> <li>Up to 8 Intel® Xeon MP microprocessors (16 in a 16-way configuration)</li> <li>OR</li> <li>Up to 4 Intel Xeon DP microprocessors</li> </ul> </li> <li><b>Note:</b> Use the Information in BIOS to determine the type and speed of the microprocessors installed in your server.</li> <li>IBM XA-32™ chip set with integrated memory, I/O, system cache, and remote I/O controllers</li> </ul> <p><b>Memory:</b></p> <ul style="list-style-type: none"> <li>Minimum: 2 GB</li> <li>Maximum: 64 GB</li> <li>Type: 2-way interleaved PC1600, DDR SDRAM, registered DIMMs only</li> <li>Supports 512 MB, 1GB and 2 GB dual inline memory modules (DIMMs)</li> <li>XceL4™ Server Accelerator Cache (64 MB per SMP Expansion Module)</li> </ul> <p><b>Drives:</b></p> <ul style="list-style-type: none"> <li>Diskette: 1.44 MB</li> <li>DVD-ROM</li> <li>Supports up to two internal Ultra320 SCSI hard disk drives</li> </ul> <p><b>Active™ PCI-X expansion slots:</b></p> <p>Six 64-bit Active PCI-X expansion slots:</p> <ul style="list-style-type: none"> <li>Two 66 MHz PCI-X slots</li> <li>Two 100 MHz PCI-X slots</li> <li>Two 133 MHz PCI-X slots</li> <li>Additional PCI-X slots available in an optional remote I/O expansion enclosure</li> </ul> <p><b>Cooling:</b></p> <p>Four hot-swap fans:</p> <ul style="list-style-type: none"> <li>Two 150 mm x 51 mm redundant fans</li> <li>Two 150 mm x 38 mm fans</li> </ul> <p><b>Acoustical noise emissions:</b></p> <ul style="list-style-type: none"> <li>Sound power, idling: 6.5 bel maximum</li> <li>Sound power, operating: 6.5 bel maximum</li> </ul>	<p><b>Power supply:</b></p> <p>Two hot-swap power supplies (depending on model):</p> <ul style="list-style-type: none"> <li>550 watts at 110 V ac or 1050 watts at 220 V ac</li> <li>600 watts at 110 V ac or 1200 watts at 220 V ac</li> </ul> <p><b>Video:</b></p> <ul style="list-style-type: none"> <li>Models with the Remote Supervisor Adapter II-EXA: ATI Radeon RV-100 video controller on the RSA II-EXA adapter</li> <li>Models with the Remote Supervisor Adapter: ATI Rage XL video controller on the system board</li> <li>PCI bus interface</li> <li>Compatible with SVGA</li> </ul> <p><b>Size (4 U):</b></p> <ul style="list-style-type: none"> <li>Height: 17.8 cm (7 inches, 4 U)</li> <li>Depth: 69.85 cm (27.5 inches)</li> <li>Width: 48.3 cm (19 inches)</li> <li>Maximum weight: 50 kg (110 lb) depending on your configuration</li> </ul> <p><b>Integrated functions:</b></p> <ul style="list-style-type: none"> <li>Broadcom 5704 Dual Gigabit 10/100/1000 Ethernet controller</li> <li>Light path diagnostics feature</li> <li>LSI Logic 1030 Dual Ultra320 SCSI controller</li> <li>Remote Supervisor Adapter II-EXA <ul style="list-style-type: none"> <li>ATI Radeon RV-100 video controller</li> <li>Ethernet port</li> <li>RSA II-EXA breakout port</li> </ul> </li> <li>Remote Supervisor Adapter <ul style="list-style-type: none"> <li>ASM interconnect port</li> <li>Ethernet port</li> <li>Management port</li> </ul> </li> <li>IDE controller</li> <li>RXE Management Port</li> <li>Three USB ports</li> <li>Keyboard port</li> <li>SCSI port</li> <li>Mouse port</li> <li>Symmetrical multiprocessing (SMP) Expansion Ports (three or six ports depending on your configuration)</li> <li>Two remote I/O expansion enclosure (RXE) Expansion Ports</li> </ul>	<p><b>Environment:</b></p> <ul style="list-style-type: none"> <li>Air temperature: <ul style="list-style-type: none"> <li>Server on: 10° to 35°C (50.0° to 95.0°F). Altitude: 0 to 914 m (2998.7 ft).</li> <li>Server on: 10° to 32° C (50.0° to 89.6° F). Altitude: 914 m (2998.7 ft) to 2133 m (6998.0 ft).</li> <li>Server off: -40° to 60° C (-104° to 140° F). Maximum altitude: 2133 m (6998.0 ft).</li> </ul> </li> <li>Humidity: <ul style="list-style-type: none"> <li>Server on: 8% to 80%</li> <li>Server off: 5% to 100%</li> </ul> </li> </ul> <p><b>Heat output:</b></p> <p>Approximate heat output in British thermal units (Btu) per hour:</p> <ul style="list-style-type: none"> <li>Minimum configuration: 855 Btu (250 watts)</li> <li>Maximum configuration: 2726 Btu (800 watts)</li> </ul> <p><b>Electrical input:</b></p> <ul style="list-style-type: none"> <li>Sine-wave input (50 or 60 Hz) required</li> <li>Input voltage low range: <ul style="list-style-type: none"> <li>Minimum: 100 V ac</li> <li>Maximum: 127 V ac</li> </ul> </li> <li>Input voltage high range: <ul style="list-style-type: none"> <li>Minimum: 200 V ac</li> <li>Maximum: 240 V ac</li> </ul> </li> <li>Input kilovolt-amperes (kVA) approximately: <ul style="list-style-type: none"> <li>Minimum: 0.250 kVA</li> <li>Maximum: 0.800 kVA</li> </ul> </li> </ul> <p><b>Notes:</b></p> <ol style="list-style-type: none"> <li>Power consumption and heat output vary depending on the number and type of optional features installed and the power-management optional features in use.</li> <li>These levels were measured in controlled acoustical environments according to the procedures specified by the American National Standards Institute (ANSI) S12.10 and ISO 7779 and are reported in accordance with ISO 9296. Actual sound-pressure levels in a given location might exceed the average values stated because of room reflections and other nearby noise sources. The declared sound-power levels indicate an upper limit, below which a large number of computers will operate.</li> </ol>
---	--	---

---

## What your server offers

Your server uses the following features and technologies:

- **IBM Director**

IBM Director is a workgroup-hardware-management tool that you can use to centrally manage xSeries servers. For more information about IBM Director, see the IBM Director *User's Guide* on the IBM *Director* CD.

- **IBM Enterprise X-Architecture technology**

IBM X-Architecture technology combines proven, innovative IBM designs to make your Intel-processor-based server powerful, scalable, and reliable. For more information, go to

<http://www.ibm.com/pc/us/eserver/xseries/xarchitecture/enterprise/index.html>.

- **Active™ Memory**

The Active Memory feature improves the reliability of memory through memory mirroring, memory scrubbing, and the Memory ProteXion™ feature. For more information, see “Active Memory” on page 7.

- **Large system-memory capacity**

The memory bus supports up to 64 GB of system memory. The memory controller supports error correcting code (ECC) for up to 32 industry-standard PC1600, 133 megahertz (MHz), 3.3 V, 168-pin, registered, double-data-rate (DDR), synchronous dynamic random access memory (SDRAM) dual inline memory modules (DIMMs).

- **Memory ProteXion**

The Memory ProteXion feature provides the equivalent of a hot-spare drive in a RAID array. It is based in the memory controller, and it enables the server to sense when a chip on a DIMM has failed and to route the data around the failed chip.

- **Xcel4™ Server Accelerator Cache**

The Xcel4 Server Accelerator Cache provides 64 MB of external Level-4 cache per SMP Expansion Module, which increases memory bandwidth and reduces access time through PCI-X, Ethernet, SCSI, and Fibre Channel interfaces.

- **IBM ServerGuide™ Setup and Installation CD**

The *ServerGuide Setup and Installation* CD that comes with your server provides programs to help you set up your server and install the operating system. The ServerGuide program detects installed hardware options and provides the correct configuration programs and device drivers. For more information about the *ServerGuide Setup and Installation* CD, see “Using the ServerGuide Setup and Installation CD” on page 27.

**Note:** If your server model came with an operating system, such as Microsoft® Windows® 2000 Datacenter Server, Windows Server 2003 Datacenter Edition, or VMware ESX server, see the software documentation provided with your software for configuration information.

- **Integrated network support**

Your server comes with an integrated Broadcom 5704 Dual Gigabit Ethernet controller, which supports connection to a 10-Mbps, 100-Mbps, or 1000-Mbps network. For more information, see “Configuring the Gigabit Ethernet controller” on page 30.



- **Large data-storage capacity and hot-swap capability**

Your server supports up to two 25.4-mm (1-inch) slim-high, 3.5-inch hot-swap hard disk drives in the hot-swap bays. With the hot-swap feature, you can add, remove, or replace hard disk drives without turning off the server.

- **Light path diagnostics feature**

The light path diagnostics feature provides LEDs to help you diagnose problems. For more information, see the section about the light path diagnostics feature in the *Installation Guide*.

- **Redundant connection**

The integrated dual Gigabit Ethernet ports provide a failover capability. If a problem occurs with the primary Ethernet connection, all Ethernet traffic associated with the primary connection is automatically switched to the secondary connection. If the appropriate device drivers are installed, this switching occurs without data loss and without user intervention.

- **Redundant cooling and power capabilities**

The redundant cooling of the fans in your server enable continued operation if one of the fans fails. Your server comes with two 1050-watt or two 1200-watt hot-swap power supplies, which provide redundant power for many server configurations. If the maximum load on your server is less than 1050 watts (or 1200 watts depending on your model) and a problem occurs with one of the power supplies, the other power supply can meet the power requirements.

- **Scalable partitions**

Your server is scalable and can be connected to another server so that you can share resources between servers.

- **ServeRAID™ support**

Your server supports ServeRAID adapters to create redundant array of independent disks (RAID) configurations.

- **Symmetric multiprocessing (SMP)**

Your server supports up to eight Intel Xeon microprocessors (sixteen in a 16-way configuration). The server comes with two microprocessors. You can install additional microprocessors to enhance performance.

- **Systems-management capabilities**

The server comes with a Remote Supervisor Adapter or a Remote Supervisor Adapter II-EXA installed. The adapter and the systems-management software that comes with your server enable you to manage the functions of the server locally and remotely. Both adapters provide system monitoring, event recording, and dial-out alert capability. The Remote Supervisor Adapter II-EXA also provides an integrated video controller.

---

## Reliability, availability, and serviceability features

Three important computer design features are reliability, availability, and serviceability (RAS). The RAS features help to ensure the integrity of the data that is stored in your server, the availability of the computer when you need it, and the ease with which you can diagnose and repair problems.

Your server has the following RAS features:

- Active Memory
- Active PCI-X (hot-plug) adapter slots
- Advanced Configuration and Power Interface (ACPI)
- Advanced Desktop Management Interface (DMI) features
- Advanced memory ECC, including Memory ProteXion, and multiple Chipkill™ capability
- Automatic error retry or recovery
- Auto-restart initial program load (IPL) power supply
- Automatic server restart
- Built-in, menu-driven Configuration/Setup Utility and diagnostic programs
- Customer-upgradable basic input/output system (BIOS) code
- DDR SDRAM with serial presence detect (SPD) and vital product data (VPD)
- Diagnostic support of Ethernet controllers
- Error codes and messages
- Error correcting code (ECC) protection on the L3 and XceL4 cache
- Failover Ethernet support
- Front-side buses (FSBs) parity protected
- Hot-add memory
- Hot-replace memory
- Hot-swap and redundant cooling with fan speed-sensing capability
- Hot-swap and redundant power supplies
- Hot-swap hard disk drives
- Light path diagnostics
- Memory mirroring
- Microsoft Windows Server family failover support
- Monitoring support for power-supply redundancy, temperature, voltage, and fan speed
- Parity checking on the SCSI buses
- Power-on self-test (POST)
- Processor serial number access
- Read-only memory (ROM) checksums
- Remote Supervisor Adapter or Remote Supervisor Adapter II-EXA to enable remote server management
- Standard cable presence detection
- Standby voltage for systems-management features and monitoring
- System error logging
- Vital product data (VPD) (includes information stored in nonvolatile memory for easier remote viewing)
- Wake on LAN® capability

---

## Active Memory

Active Memory is an IBM feature that improves the reliability of memory through memory mirroring, memory scrubbing, and the Memory ProteXion feature.

### Memory scrubbing and Memory ProteXion

Memory scrubbing tests the memory at regular intervals to detect and report potential memory errors before they can cause server outages.

If a detected error is recoverable, the Memory ProteXion feature corrects the error and rewrites the data to another memory location on the same DIMM. The error is logged in the error log so that you can determine whether preventive maintenance is necessary.

If there are not sufficient undamaged memory locations that the data can be rewritten to, the error is unrecoverable. Other conditions can also cause unrecoverable errors. If a detected error is unrecoverable, LEDs on the Light Path Diagnostics panel are lit to indicate the failing DIMM.

You do not have to enable memory mirroring to use memory scrubbing and the Memory ProteXion feature.

### Memory mirroring

Memory mirroring stores data in memory port 1 and memory port 2 simultaneously. To support memory mirroring, you must install identical dual inline memory modules (DIMMs) in memory port 1 and memory port 2. For more information, see the section about installing memory modules in the *Option Installation Guide* on the IBM *xSeries Documentation CD*.

To enable memory mirroring through the Configuration/Setup Utility program, select **Advanced Setup** from the main menu, and then select **Memory Settings**. For more information about using the Configuration/Setup Utility program, see Chapter 2, "Configuring the server," on page 17.

When memory mirroring is enabled, BIOS will only report half of the installed memory. For example, if you have 64 GB of memory installed and memory mirroring is enabled, BIOS will only report 32 GB of memory.

**Note:** To use the hot-add memory feature, memory mirroring must be disabled in the BIOS code.

---

## The UpdateXpress program

The UpdateXpress program is available for most xSeries servers and server options. It detects supported and installed device drivers and firmware in your server and installs available updates. You can download the UpdateXpress program from the Web at no additional cost, or you can purchase it on a CD. To download the program or purchase the CD, go to <http://www.ibm.com/pc/ww/eserver/xseries/serverguide/xpress.html>.

---

## IBM Director

With IBM Director, a network administrator can:

- View the hardware configuration of remote systems, in detail
- Monitor the usage and performance of critical components, such as microprocessors, disks, and memory
- Centrally manage individual or large groups of IBM and non-IBM Intel-based servers, desktop computers, workstations, and mobile computers on a variety of platforms

IBM Director provides a comprehensive entry-level workgroup hardware manager. Key features include:

- Advanced self-management capabilities for maximum system availability
- Multiple operating-system platform support, including Microsoft Windows 2000 Server, Windows XP Professional, Red Hat Linux, SuSE Linux, Novell NetWare, and Caldera OpenUNIX®. For a complete list of operating systems that support IBM Director, see the IBM Director Compatibility Document. This document is in Portable Document Format (PDF) at [http://www.ibm.com/pc/ww/eserver/xseries/systems\\_management/nfdir/agent.html](http://www.ibm.com/pc/ww/eserver/xseries/systems_management/nfdir/agent.html). It is updated every 6 to 8 weeks.
- Support for IBM and non-IBM servers, desktop computers, workstations, and mobile computers
- Support for systems-management industry standards
- Integration into leading workgroup and enterprise systems-management environments
- Ease of use, training, and setup

IBM Director also provides an extensible platform that supports advanced server tools that are designed to reduce the total cost of managing and supporting networked systems. By deploying IBM Director, you can achieve reductions in ownership costs through:

- Reduced downtime
- Increased productivity of IT personnel and users
- Reduced service and support costs

For more information about IBM Director, see the *IBM Director* CD that comes with your server, the IBM Director documentation on the CD, and the following Web pages:

### **IBM xSeries Systems Management page**

[http://www-1.ibm.com/servers/eserver/xseries/systems\\_management/xseries\\_sm.html](http://www-1.ibm.com/servers/eserver/xseries/systems_management/xseries_sm.html)

This Web page presents an overview of IBM Systems Management and IBM Director.

### **IBM Universal Manageability page**

<http://www.ibm.com/pc/us/pc/um/index.html>

This Web page links to an IBM portfolio of advanced management tools that help reduce costs and increase availability throughout the life cycle of a product.

---

## Server controls, LEDs, and power

The following section identifies the controls and indicators on the front and rear of your server.

### Front view

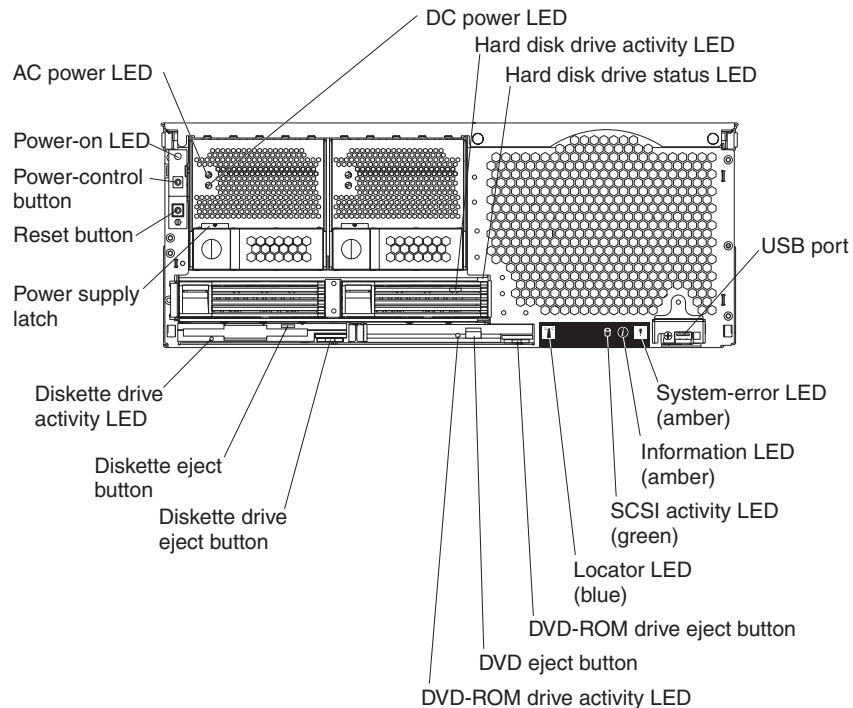

Figure 1. Front view of xSeries 445

**AC and DC power LED:** Each hot-swap power supply has an ac power LED and a dc power LED. During typical operation, both the ac and dc power LEDs are lit. For any other combination of LEDs, see the *Hardware Maintenance Manual and Troubleshooting Guide* on the IBM xSeries Documentation CD.

**Hard disk drive activity LED:** This green LED is lit when the hard disk drive is in use.

**Hard disk drive status LED:** When the drive is connected to the integrated SCSI controller with RAID capabilities, a flashing status LED indicates that the drive is a secondary drive in a mirrored pair and the drive is being synchronized. When the drive is connected to an optional ServerRAID controller, a slowly flashing (one flash per second) status LED indicates that the drive is being rebuilt. When the LED is flashing rapidly (three flashes per second), it indicates that the controller is identifying the drive.

**USB port:** Use this automatically configured port to connect one or more USB devices to the front of the server, using Plug and Play technology.

**System-error LED:** This amber LED is lit when a system error has occurred.

**Information LED:** This amber LED is lit when information about a system error has been placed in the System Error log.

**SCSI activity LED:** This green LED is lit when there is activity on the SCSI bus.

**Locator LED:** The locator LED is on the left front of the Light Path Diagnostic drawer. This blue LED identifies the primary and secondary servers. This LED blinks on the primary server and remains lit solid on the secondary server.

**DVD-ROM drive eject button:** Press this button to release a DVD-ROM drive from the server.

**DVD eject button:** Press this button to release a DVD from the DVD-ROM drive.

**DVD-ROM drive activity LED:** When this LED is lit, the DVD-ROM drive is in use.

**Diskette drive eject button:** Press this button to release a diskette drive from the server.

**Diskette eject button:** Press this button to release a diskette from the diskette drive.

**Diskette drive activity LED:** When this LED is lit, the diskette drive is in use.

**Power-supply latch:** This latch is used to secure the power supply in place.

**Reset button:** Press this button to reset the server and run the power-on self-test (POST). You might have to use a pen or the end of a straightened paper clip to press the button.

**Power-control button:** Press this button to turn the server on and off manually. A power-control-button shield comes with your server. You can install this disk-shaped shield to prevent the server from being turned off accidentally.

## Rear view

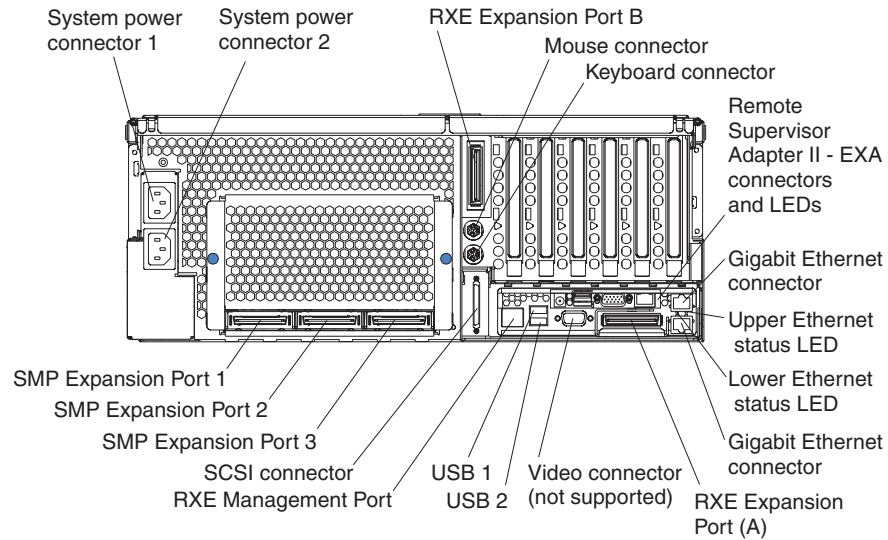

Figure 2. Rear view of model with Remote Supervisor Adapter II-EXA

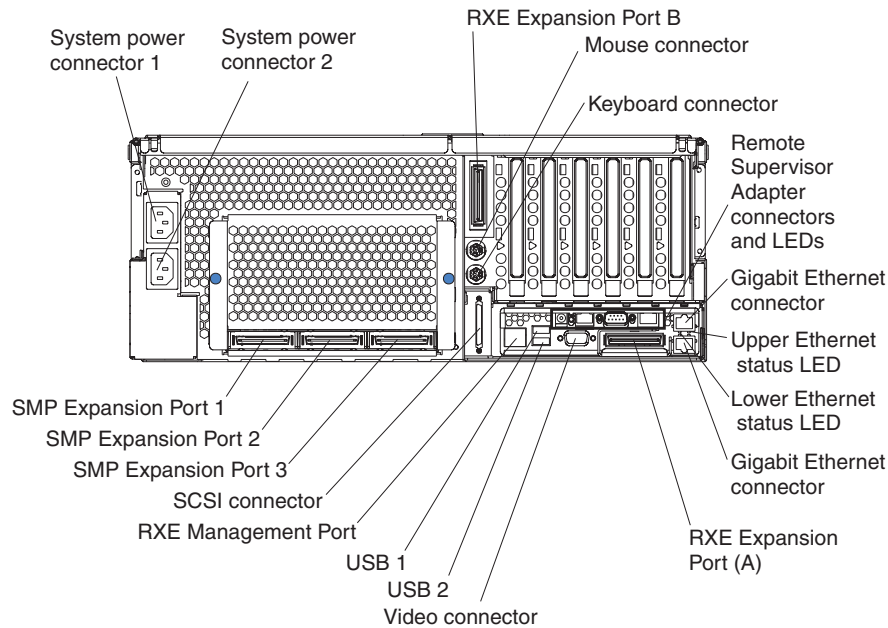

Figure 3. Rear view of model with Remote Supervisor Adapter

**System power connectors (1 and 2):** Connect the system power cords to these two connectors to provide power to the system.

**RXE Expansion Port B:** Use this port to connect the server to a remote I/O enclosure when two SMP Expansion Modules are installed.

**Mouse connector:** Connect a mouse to this connector.

**Keyboard connector:** Connect a keyboard to this connector.

**Remote Supervisor Adapter II-EXA connectors and LEDs:** This group of connectors and LEDs on the back of the server is used for system-management information and control.

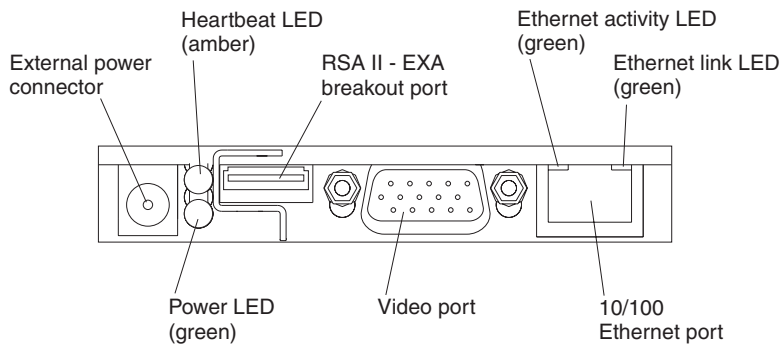

Figure 4. Remote Supervisor Adapter II-EXA connectors and LEDs

- **External power connector:** You can connect an optional ac power adapter to this connector.
- **Heartbeat LED:** This amber LED flashes continuously to indicate that there is activity on the Remote Supervisor Adapter II-EXA.
- **RSA II-EXA breakout port:** Connect the RSA II-EXA breakout cable to this port to provide two ASM interconnect ports, one USB port, and one Management port.
- **Ethernet activity LED:** This green LED is lit when there is activity on the Ethernet LAN.
- **Ethernet link LED:** This green LED is lit when the Ethernet link is active.
- **10/100 Ethernet port:** Connect Ethernet signal cables to this port.
- **Video port:** Connect a monitor or console switch to this port.

**Important:** If your server has a Remote Supervisor Adapter II-EXA installed, the integrated video controller is disabled. You must connect a monitor or console switch to the video port on the Remote Supervisor Adapter II-EXA.

- **Power LED:** This green LED comes on and stays lit when you plug in your server.

**Remote Supervisor Adapter connectors and LEDs:** This group of connectors and LEDs on the back of the server is used for system-management information and control.

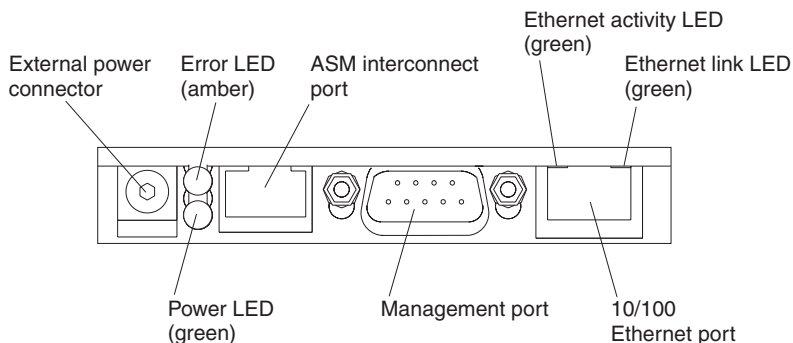

Figure 5. Remote Supervisor Adapter connectors and LEDs



- **External power connector:** You can connect an optional ac power adapter to this connector.
- **Error LED:** This amber LED is lit when a system-management error has occurred.
- **ASM interconnect port:** Connect signal cables for managing expansion-module resources to this port.
- **Ethernet activity LED:** This green LED is lit when there is activity on the Ethernet LAN.
- **Ethernet link LED:** This green LED is lit when the Ethernet link is active.
- **10/100 Ethernet port:** Connect Ethernet signal cables to this port.
- **Management port:** Connect a serial cable to this port to enable system management through a modem, or connect a null modem cable to this port to enable system management through a workstation or laptop computer.
- **Power LED:** This green LED comes on and stays lit when you plug in your server.

**Upper Ethernet status LED:** This LED displays the link and activity status for the upper Gigabit Ethernet port. When the LED is lit green, the link is active. When the LED blinks green and amber, there is activity on the Ethernet LAN.

**Lower Ethernet status LED:** This LED displays the link and activity status for the lower Gigabit Ethernet port. When the LED is lit green, the link is active. When the LED blinks green and amber, there is activity on the Ethernet LAN.

**Gigabit Ethernet port:** Connect Gigabit Ethernet signal cables to this port. This port supports 10/100/1000 speed connections.

**RXE Expansion Port A:** Use this port to connect the server to a remote I/O enclosure, when only one SMP Expansion Module is installed.

**Video port:** Connect the signal cable for a monitor to this port.

**Important:** If your server has a Remote Supervisor Adapter II-EXA installed, the integrated video controller is disabled. You must connect a monitor or console switch to the video port on the Remote Supervisor Adapter II-EXA.

**USB 2:** Use this automatically configured port to connect one or more USB devices to the server, using Plug and Play technology.

**USB 1:** Use this automatically configured port to connect one or more USB devices to the server, using Plug and Play technology.

**RXE Management Port:** Use this port to connect a management cable from the server to a remote I/O enclosure.

**SCSI port:** Connect external SCSI devices to this port.

**SMP Expansion port 3:** Use this port to interconnect two SMP Expansion Modules together in 16-way configurations.

**SMP Expansion port 2:** Use this port to interconnect two SMP Expansion Modules together.

**SMP Expansion port 1:** Use this port to interconnect two SMP Expansion Modules together.

## Server power features

When the server is connected to an ac power source but is not turned on, the operating system does not run, and all core logic except for the service processor is shut down; however, the server can respond to requests from the service processor, such as a remote request to turn on the server. The power-on LED flashes to indicate that the server is connected to ac power but it is not turned on.

### Turning on the server

Approximately 20 seconds after the server is connected to ac power, the power-control button becomes active, and you can turn on the server and start the operating system by pressing the power-control button.

You can also turn on the server in any of the following ways:

- If the server is connected to an Advanced System Management interconnect network that contains at least one server with an optional Remote Supervisor Adapter installed, the server can be turned on from the Remote Supervisor Adapter user interface.
- If a power failure occurs while the server is turned on, the server will restart automatically when power is restored.
- If your operating system supports the system-management software for an optional Remote Supervisor Adapter, the system-management software can turn on the server.
- If your operating system supports the Wake on LAN feature, the Wake on LAN feature can turn on the server.

**Note:** When you press the power-control button on either the primary or secondary server in a 16-way configuration, both servers will be turned on. If both servers do not turn on when either power-control button is pressed, see the *Hardware Maintenance Manual* and *Troubleshooting Guide* on the IBM xSeries Documentation CD.

## Turning off the server

When you turn off the server and leave it connected to ac power, the server can respond to requests from the service processor, such as a remote request to turn on the server. To remove all power from the server, you must disconnect it from the power source.

Some operating systems require an orderly shutdown before you turn off the server. See your operating-system documentation for information about shutting down the operating system.

### Statement 5:



### CAUTION:

**The power control button on the device and the power switch on the power supply do not turn off the electrical current supplied to the device. The device also might have more than one power cord. To remove all electrical current from the device, ensure that all power cords are disconnected from the power source.**



You can turn off the server in any of the following ways:

- You can turn off the server from the operating system, if your operating system supports this feature. After an orderly shutdown of the operating system, the server will be turned off automatically.
- You can press the power-control button to start an orderly shutdown of the operating system and turn off the server, if your operating system supports this feature.
- If the operating system stops functioning, you can press and hold the power-control button until the server turns off.
- If the server is connected to an Advanced System Management interconnect network that contains at least one server with an optional Remote Supervisor Adapter installed, the server can be turned off from the Remote Supervisor Adapter user interface.
- The server can be turned off from the Remote Supervisor Adapter user interface.
- If the Wake on LAN feature turned on the server, the Wake on LAN feature can turn off the server.
- The Remote Supervisor Adapter can turn off the server as an automatic response to a critical system failure.

**Note:** When you press the power-control button on either the primary or secondary server in a 16-way configuration, both servers will be turned off. If both servers do not turn off when either power-control button is pressed, see the *Hardware Maintenance Manual* and *Troubleshooting Guide* on the IBM xSeries Documentation CD.



---

## Chapter 2. Configuring the server

The following configuration programs and capabilities come with your server:

- **Configuration/Setup Utility program**

The Configuration/Setup Utility program is part of the basic input/output system (BIOS) code in your server. Use it to configure management port assignments, change interrupt request (IRQ) settings, change the startup-device sequence, set the date and time, and set passwords. For information about using this utility program, see “Using the Configuration/Setup Utility program” on page 18.

**Note:** In a 16-way configuration, some options or settings are defined through the primary server, while others must be defined on the individual server. Ensure that options or settings on the secondary server are correct before creating a scalable partition.

- **Configuring scalable partitions**

To create or remove scalable partitions, see “Configuring scalable partitions” on page 22.

- **IBM ServerGuide Setup and Installation CD**

The ServerGuide program provides software-setup tools and installation tools that are designed for your server. Use this CD during the installation of your server to configure basic hardware features, such as an integrated SCSI controller with RAID capabilities, and to simplify the installation of your operating system. For information about using this CD, see “Using the ServerGuide Setup and Installation CD” on page 27.

**Note:** If your server model comes with an operating system, such as Microsoft Windows 2000 Datacenter Server, Windows Server 2003 Datacenter Edition, or VMware ESX server, see the software documentation provided with your software for configuration information.

- **Ethernet controller configuration**

For information about configuring the Ethernet controller, see “Configuring the Gigabit Ethernet controller” on page 30.

- **Integrated System Management Processor Update program**

For information about updating the integrated system management processor firmware, see “Using the Integrated System Management Firmware Update Utility program” on page 30.

- **LSI Logic Configuration Utility program**

For information about using this utility program, see “Using the LSI Logic Configuration Utility program” on page 30.

- **ServeRAID Manager**

ServeRAID Manager is available as a stand-alone program and as an IBM Director extension. If a ServeRAID adapter is installed in your server or if you are using the RAID capabilities of the integrated SCSI controller, use ServeRAID Manager to define and configure your disk-array subsystem *before* you install the operating system. For information about using this program, see “Using ServeRAID Manager” on page 31.

- **Remote Supervisor Adapter configuration process**

Configuration activities are also required for the Remote Supervisor Adapter or Remote Supervisor Adapter II-EXA. See “Remote Supervisor Adapters” on page 39 for information about identifying, setting up, and cabling the adapter.

- **Preboot Execution Environment (PXE) boot agent utility program**

The PXE boot agent utility program is part of the BIOS code in your server. Use it to change network startup (boot) protocols and startup order and to select operating-system wake-up support. For information about using this utility program, see “Using the PXE boot agent utility program” on page 70.

---

## Using the Configuration/Setup Utility program

The Configuration/Setup Utility program is part of the BIOS code. You can use it to:

- Configure system devices and ports
- Configure scalable partitions
- Configure memory settings
- Change the drive startup sequence
- Enable USB keyboard and mouse support
- Resolve configuration conflicts
- Set the date and time
- Set passwords and security settings

## Starting the Configuration/Setup Utility program

Complete the following steps to start the Configuration/Setup Utility program:

1. Turn on the server.

**Note:** In a 16-way configuration, some options or settings are defined through the primary server, while others must be defined on the individual server. Ensure that options or settings on the secondary server are correct before creating a scalable partition.

2. When the prompt Press F1 for Configuration/Setup appears, press F1. If you have set both a power-on password and an administrator password, you must type the administrator password to access the full Configuration/Setup Utility menu. If you do not type the administrator password, a limited Configuration/Setup Utility menu is available.

**Note:** Depending on your configuration, you might experience a delay before the Configuration/Setup menu appears.

3. Select settings to view or change.

## Configuration/Setup Utility menu choices

The following choices are on the Configuration/Setup Utility main menu. Depending on the version of the BIOS code in your server, some menu choices might differ slightly from these descriptions.

- **System Summary**

Select this choice to view configuration information, including the type, speed, and cache sizes of the microprocessors and the amount of installed memory. When you make configuration changes through other options in the Configuration/Setup Utility program, the changes are reflected in the system summary; you cannot change settings directly in the system summary.

This choice is on the full and limited Configuration/Setup Utility menu.

- **System Information**

Select this choice to view information about your server. When you make changes through other options in the Configuration/Setup Utility program, some of those changes are reflected in the system information; you cannot change settings directly in the system information.

This choice is on the full Configuration/Setup Utility menu only.

- **Product Data**

Select this choice to view the machine type and model of your server, the serial number, and the revision level or issue date of the BIOS and diagnostics code stored in electrically erasable programmable ROM (EEPROM).

- **System Card Data**

Select this choice to view information about the boards installed in your server.

- **Devices and I/O Ports**

Select this choice to view or change assignments for devices and input/output (I/O) ports and to configure the remote console redirection.

Select this choice to enable or disable integrated SCSI and Ethernet controllers and all standard ports (such as the serial port). **Enable** is the default setting for all controllers. If you disable a device, it cannot be configured and the operating system will not be able to detect it (this is equivalent to disconnecting the device). If you disable the integrated SCSI controller and no SCSI adapter is installed, the server will have no SCSI capability. If you disable the integrated Ethernet controller and no Ethernet adapter is installed, the server will have no Ethernet capability.

Select this choice to configure and enable the remote console redirection feature on the server. This feature allows the user to view POST execution, change system configuration settings, and use DOS based configuration utilities remotely. See “Remote console redirection” on page 24 for more information.

This choice is on the full Configuration/Setup Utility menu only.

- **Date and Time**

Select this choice to set the date and time in the server, in 24-hour format (*hour:minute:second*).

This choice is on the full Configuration/Setup Utility menu only.

- **System Security**

Select this choice to set passwords and the Remote Control Security settings. See “Passwords” on page 25 for more information about passwords. You can also enable the chassis-intrusion detector to alert you each time the server cover is opened.

**Note:** In a 16-way configuration, security settings are defined through the primary server. If you bypass the 16-way configuration during start up or start the servers in a stand alone configuration, you must define the security setting on each individual server.

This choice is on the full Configuration/Setup Utility menu only.

- **Power-on Password**

Select this choice to set or change a power-on password. See “Power-on password” on page 25 for more information.

- **Administrator Password**

**Attention:** If you set an administrator password and then forget it, there is no way to change, override, or remove it. You must replace the system board.

Select this choice to set or change an administrator password. An administrator password is intended to be used by a system administrator; it limits access to the full Configuration/Setup Utility menu. If an administrator password is set, the full Configuration/Setup Utility menu is available only if you type the administrator password at the password prompt. See “Administrator password” on page 26 for more information.

- **Start Options**

Select this choice to view or change the start options. Changes in the start options take effect when you restart the server.

You can set keyboard operating characteristics, such as the keyboard speed, and you can specify whether the server starts with the keyboard number lock on or off. You can enable the server to run without a diskette drive, monitor, or keyboard.

The startup sequence specifies the order in which the server checks devices to find a boot record. The server starts from the first boot record that it finds. If your server has Wake on LAN hardware and software and the operating system supports Wake on LAN functions, you can specify a startup sequence for the Wake on LAN functions. You can also specify whether the integrated SCSI controller or a PCI SCSI adapter has boot precedence.

If you enable the boot fail count, the BIOS default settings will be restored after three consecutive failures to find a boot record.

You can enable a virus-detection test that checks for changes in the boot record when the server starts.

This choice is on the full Configuration/Setup Utility menu only.

- **Advanced Setup**

Select this choice to change settings for advanced hardware features.

**Attention:** The server might malfunction if these options are incorrectly configured. Follow the instructions on the screen carefully.

This choice is on the full Configuration/Setup Utility menu only.

- **System Partition Visibility**

Select this choice to specify whether the System Partition is to be visible or hidden.

- **SMP Expansion Module 2 State**

Select this choice to view or change the state for SMP Expansion Module 2. If the system contains two SMP Expansion Modules and the SMP Expansion Module 2 State is disabled, check the system error log for information about system-detected failures. After you correct the problem, enable the SMP Expansion Module 2 State.

- **CPU Socket State**

You can enable a CPU socket and view the CPU socket state.

- **Memory Settings**

Select this choice to manually enable a pair of memory connectors. If a memory error is detected during POST or memory configuration, the server automatically disables the failing pair of memory connectors and continues operating with reduced memory. After you correct the problem, you must enable the memory connectors. Use the arrow keys to highlight the pair of memory connectors that you want to enable, and use the arrow keys to select Enable.



The following information applies to memory mirroring:

- The hot-add memory feature allows you to add DIMMs without turning off the server. This feature is supported only in servers using Windows Server 2003 Enterprise or Datacenter editions.
- To use the hot-add memory feature, memory mirroring must be Disabled.
- To use the hot-replace memory feature, memory mirroring must be Enabled.

– **CPU Options**

Select this choice to specify whether the serial number in the microprocessor is to be readable, to enable or disable hyperthreading technology for all installed microprocessors, or to disable the microprocessor cache or set it to use the write-back or write-through method. Write-back caching generally provides better system performance.

– **PCI Slot/Device Information**

Select this choice to view the properties and settings for adapters installed in the PCI slots.

– **ASM Settings**

Select this choice to enable or disable the **Reboot on System NMI** option on the menu. If you enable this option, the server will automatically restart 60 seconds after the service processor issues a nonmaskable interrupt (NMI) to the server. If you disable this option, the server will not restart. **Enable** is the default setting.

– **Scalability Port Configuration**

Select this choice to view a summary of the current scalability port configurations. (This choice appears on the Advanced Setup menu when cables are connected to the SMP Expansion Ports.)

**Note:** Scalability ports are called SMP Expansion Ports in this publication.

– **Scalable Partition Settings**

Select this choice to view a summary of current scalable partition settings and to configure or delete partition settings.

**Notes:**

1. Partition settings are called partition descriptors in some IBM documentation.
2. See “Configuring scalable partitions” on page 22” for more information on creating, deleting, and configuring scalable partitions.

• **Error Logs**

Select this choice to view or clear error logs.

**Note:** When troubleshooting problems with PCI-X slots, you will notice that the error logs report the PCI-X busses numerically. The numerical assignment will change, depending on your configuration.

– **POST Error Log**

Select this choice to view the three most recent error codes and messages that were generated during POST. Select **Clear error logs** to clear the POST error log.

– **System Error Log**

Select this choice to view the System Error log, which contains all system error and warning messages that have been generated. Use the arrow keys to move between pages in the log. Select **Clear error logs** to clear the System Error log.

• **Save Settings**

Select this choice to save the changes you have made in the settings.

• **Restore Settings**

Select this choice to cancel the changes you have made in the settings and to restore the previous settings.

• **Load Default Settings**

Select this choice to cancel the changes you have made in the settings and to restore the factory settings.

• **Exit Setup**

Select this choice to exit from the Configuration/Setup Utility program. If you have not saved the changes you have made in the settings, you are asked whether you want to save the changes or exit without saving them.

For a list of supported options for your server, go to <http://www.ibm.com/pc/compat/>. To order an option, contact your IBM marketing representative or authorized reseller.

## Configuring scalable partitions

The Scalable Systems Manager program is an extension to IBM Director that provides a graphical user interface for creating and managing scalable partitions. See the *Scalable Systems Manager Installation and Users Guide* for information on how to use that program to configure scalable partitions on xSeries 445 servers. You can also use the Configuration/Setup Utility program to configure scalable partitions. This section provides information and instructions for creating and deleting scalable partitions through the Configuration/Setup Utility program.

Before you create scalable partitions, read the following information:

- Before you can create or delete a scalable partition, the Remote Supervisor Adapters must have an IP address and must be connected to a network or to each other with an Ethernet crossover cable. This connection is needed so that the Remote Supervisor Adapters can communicate and perform the necessary functions for the two servers to create or delete scalable partitions.
- When creating a scalable partition consisting of an RXE-100, you must create the scalable partition initially through the Configuration/Setup Utility program before you can use Scalable Systems Manager.
- When a scalable partition consisting of two servers in a 16-way configuration is created, the DVD-ROM drive, diskette drive, keyboard, USB connectors, mouse, and video are disabled on the secondary server.
- In the Configuration/Setup Utility program, Expansion Port A Destination and Expansion Port B Destination refer to the RXE Expansion Port connection from the expansion enclosure to the server.
- In a 16-way configuration, the SMP IDs of the Primary and Secondary Scalable Nodes must be different.

### Creating a scalable partition

Complete the following steps to create a scalable partition:

1. If you have not already done so, connect the RXE expansion and RXE management cables between the server and the remote expansion enclosure. See "RXE Expansion and Management Port cabling" in the *Option Installation Guide* on the IBM *xSeries Documentation CD*.
2. Start the Configuration/Setup Utility program.
3. From the main menu, select **Advanced Setup**.
4. Select **Scalable Partition Settings**.
5. Select **Create Scalable Partition Settings**.
6. For 4-way and 8-way single chassis configurations, complete the following steps:
  - a. Select **1 x445 chassis** as the Scalable System Configuration.
  - b. Select the number of PCI-X slots available to the RXE Expansion Port in the remote expansion enclosure. The following choices are available:
    - 0** - No PCI-X slots are assigned to the RXE Expansion Port.
    - 6** - Only six of the 12 slots are assigned to the RXE Expansion Port.
    - 12** - All 12 PCI-X slots are assigned to the RXE Expansion Port.
  - c. Complete one of the following procedures, depending on the number of SMP Expansion Modules that are installed:
    - One SMP Expansion Module: If six or 12 PCI-X slots are available, select Primary Scalable Node, Port A for the RXE Port destination.
    - Two SMP Expansion Modules: If six or 12 PCI-X slots are available to port A or port B, select Primary Scalable Node, Port B for the RXE Port destination. If six PCI-X slots are available to port A and six PCI-X slots are available to port B, select Primary Scalable Node, Port A for the RXE Port A destination and Primary Scalable Node, Port B for the RXE Port B destination.
  - d. Go to step 8.
7. For 16-way two-chassis configuration, complete the following steps:
  - a. Select **2 x445 chassis**, as the Scalable System Configuration.
  - b. Enter a Scalable Partition ID **0000 through 9999**.
  - c. For the primary boot node, select **SMP ID 0**.
 

**Note:** The SMP ID can be 0 or 2, but it must be different from the SMP ID of the secondary x445 scalable node.
  - d. Enter the Secondary ASM host name or IP address.
  - e. From the **Secondary Scalable Node SMP ID** menu, select **Yes, SMP ID 2**.
 

**Note:** This SMP ID must be different from the SMP ID for the primary boot node.
  - f. Select the number of PCI-X slots available to the RXE Expansion Port in the remote expansion enclosure. The following choices are available:
    - 0** - No PCI-X slots are assigned to the RXE Expansion Port.
    - 6** - Only six of the 12 slots are assigned to the RXE Expansion Port.
    - 12** - All 12 PCI-X slots are assigned to the RXE Expansion Port.
  - g. If 12 PCI-X slots are available to port A, select Primary Scalable Node, Port B for the RXE Port A destination. If six PCI-X slots are available to port A and six PCI-X slots are available to port B, select Primary Scalable Node, Port A for the RXE Port A destination and Primary Scalable Node, Port B for the RXE Port B destination.
8. Select **Write Scalable Partition Settings** and follow the prompts to exit the menu item.

9. Save and Exit the Configuration/Setup Utility Program.

**Note:** See the software documentation that comes with your operating system to install your operating system.

### Deleting a scalable partition

Complete the following steps to delete the scalable partition:

1. Start the Configuration/Setup Utility on the primary server.
2. From the main menu, select **Advanced Setup**.
3. Select **Scalable Partition Settings**.
4. Select either **Delete ALL Scalable Partition** or **Delete ONLY Local Scalable Partition**.

**Note:** Do not select **Write Scalable Partition Settings** when you delete the scalable partition.

5. Exit the Configuration/Setup Utility program.
6. Turn off the servers.
7. If necessary, remove the SMP Expansion cables and reconnect them according to your new configuration. See "Connecting the cables" in the *Option Installation Guide* on the IBM xSeries Documentation CD.
8. Restart the servers.

## Remote console redirection

From the **Devices and I/O Ports** choice, you can enable and configure the remote console redirection through the **Remote Console Redirection** submenu. The **Devices and I/O Ports** choice is on the full Configuration/Setup menu only.

Complete the following steps to enable and configure the remote console redirection feature:

1. Ensure that you have installed and enabled the serial port that comes with your server. See "Installing the serial port" in the *Installation Guide*.
2. From the **Devices and I/O Ports** choice, use the arrow keys to select **Remote Console Redirection**; then, press Enter. The Remote Console Redirection window opens.
3. In the Remote Console Redirection window, **Enable** the remote console redirection and enter the necessary settings for the server to work with a remote console.

**Note:** The remote console settings must match those in the Remote Console Redirection window to ensure proper operation.

4. Once you have made the necessary changes, press Esc.
5. Select **Save Settings**; then, press Enter.
6. Confirm your selection; then, exit the Configuration/Setup Utility program.
7. Connect the server to a remote console using a null modem cable.

## Passwords

From the **System Security** choice, you can set, change, and delete a power-on password and an administrator password. The **System Security** choice is on the full Configuration/Setup menu only.

**Note:** In a 16-way configuration, security settings are defined through the primary server. If you bypass the 16-way configuration during start up or start the servers in a stand alone configuration, you must define the security setting on each individual server.

If you set only a power-on password, you must type the power-on password to complete the system startup, and you have access to the full Configuration/Setup Utility menu.

An administrator password is intended to be used by a system administrator; it limits access to the full Configuration/Setup Utility menu. If you set only an administrator password, you do not have to type a password to complete the system startup, but you must type the administrator password to access the Configuration/Setup Utility menu.

If you set a power-on password for a user and an administrator password for a system administrator, you can type either password to complete the system startup. A system administrator who types the administrator password has access to the full Configuration/Setup Utility menu; the system administrator can give the user authority to set, change, and delete the power-on password. A user who types the power-on password has access to only the limited Configuration/Setup Utility menu; the user can set, change, and delete the power-on password, if the system administrator has given the user that authority.

### Power-on password

If a power-on password is set, when you turn on the server, the system startup will not be completed until you type the power-on password. You can use any combination of up to seven characters (A–Z, a–z, and 0–9) for the password.

When a power-on password is set, you can enable the Unattended Start mode, in which the keyboard and mouse remain locked but the operating system can start. You can unlock the keyboard and mouse by typing the power-on password.

If you forget the power-on password, you can regain access to the server in any of the following ways:

- If an administrator password is set, type the administrator password at the password prompt. Start the Configuration/Setup Utility program and reset the power-on password.
- Remove the server battery and then reinstall it. See the *Option Installation Guide* on the IBM *xSeries Documentation* CD for instructions for removing the battery.
- Change the position of the power-on password override switch (switch 6 on switch block 1 on the system board) to bypass the power-on password check.

**Attention:** Before changing any switch settings or moving any jumpers, turn off the server; then, disconnect all power cords and external cables. See the safety information beginning on page v. Do not change settings or move jumpers on any system-board switch or jumper blocks that are not shown in this book.

While the server is turned off, move the switch to the position opposite its current position. You can then start the Configuration/Setup Utility program and reset the power-on password. You do not need to return the switch to the previous position.

The power-on password override switch does not affect the administrator password.

### **Administrator password**

If an administrator password is set, you must type the administrator password for access to the full Configuration/Setup Utility menu. You can use any combination of up to seven characters (A–Z, a–z, and 0–9) for the password. The **Administrator password** choice is on the Configuration/Setup Utility menu only if an IBM Remote Supervisor Adapter is installed.

**Attention:** If you set an administrator password and then forget it, there is no way to change, override, or remove it. You must replace the system board.

---

## Using the ServerGuide Setup and Installation CD

The *ServerGuide Setup and Installation* CD includes an easy-to-use setup and installation program that is designed for your IBM server. The ServerGuide program detects the server model and hardware options that are installed and uses that information during setup to configure the hardware. The ServerGuide program simplifies operating-system installations by providing updated device drivers and, in some cases, installing them automatically.

**Note:** If your server model comes with an operating system, such as Microsoft Windows 2000 Datacenter Server, Windows Server 2003 Datacenter Edition, or VMware ESX server, see the software documentation provided with your software for configuration information.

If a later version of the ServerGuide program is available, you can download a free image of the *ServerGuide Setup and Installation* CD, or you can purchase the CD. To download the image, go to the IBM ServerGuide Web page at <http://www.ibm.com/pc/qtechinfo/MIGR-4ZKPPT.html>. To purchase the latest *ServerGuide Setup and Installation* CD, go to the ServerGuide fulfillment Web site at <http://www.ibm.com/pc/coupon/>.

The ServerGuide program has the following features to make setup easier:

- Diskette-free setup and configuration programs that are based on detected hardware
- ServeRAID Manager program, which configures your ServeRAID adapter or integrated SCSI controller with RAID capabilities
- Device drivers that are provided for your server model and detected hardware
- Operating-system partition size and file-system type that are selectable during setup

### ServerGuide features

Features and functions can vary slightly with different versions of the ServerGuide program. To learn more about the version that you have, start the *ServerGuide Setup and Installation* CD and view the online overview. Not all features are supported on all server models.

The ServerGuide program requires a supported IBM server with an enabled startable (bootable) CD-ROM or DVD-ROM drive. In addition to the *ServerGuide Setup and Installation* CD, you must have your operating-system CD to install your operating system.

The ServerGuide program has the following features:

- Sets system date and time.
- Detects the SCSI RAID adapter, controller, or integrated SCSI controller with RAID capabilities and runs the SCSI RAID configuration program.
- Checks the microcode (firmware) levels of ServeRAID adapters to determine whether a later level is available from the CD. You can perform updates without using diskettes.
- Detects installed hardware options and provides updated device drivers for most adapters and devices.
- Provides diskette-free installation for supported operating systems.
- Includes an online readme file with links to tips for your hardware and operating-system installation.

## Setup and configuration overview

When you use the *ServerGuide Setup and Installation* CD, you do not need setup diskettes. You can use the CD to configure any supported IBM server model. The setup program provides a list of tasks that are required to set up your server model. On a server with a ServeRAID adapter or integrated SCSI controller with RAID capabilities, you can run the SCSI RAID configuration program to create logical drives.

**Note:** Features and functions can vary slightly with different versions of the ServerGuide program.

Complete the following steps to start the *ServerGuide Setup and Installation* CD:

1. Insert the CD, and restart the server. If the ServerGuide CD does not start, see "ServerGuide startup problems" in the *IBM xSeries 445 Installation Guide*.
2. Follow the instructions on the screen to:
  - a. Select your language.
  - b. Select your keyboard layout and country.
  - c. View the overview to learn about the ServerGuide features.
  - d. Review the readme file for installation tips about your operating system and adapters.
  - e. Start the setup and hardware configuration programs.
  - f. Start the operating-system installation. You will need your operating-system CD.

### Notes:

1. Plug and Play adapters are configured automatically. Non-Plug and Play adapters or non-IBM adapters might require switch settings, additional device drivers, and installation after the operating system is installed. See the documentation that comes with the adapter.
2. Diagnostics for your server come in the BIOS code.

## Typical operating-system installation

You can use the ServerGuide program to shorten your installation time. The ServerGuide program provides the device drivers that are required for your hardware and for the operating system that you are installing. This section describes a typical ServerGuide operating-system installation.

**Note:** Features and functions can vary slightly with different versions of the ServerGuide program.

1. After you have completed the setup process, the operating-system installation program starts. (You will need your operating-system CD to complete the installation.)
2. The ServerGuide program stores information about the server model, service processor, hard disk drive controllers, and network adapters. Then, the program checks the CD for newer device drivers. This information is stored and then passed to the operating-system installation program.
3. The ServerGuide program presents operating-system partition options that are based on your operating-system selection and the installed hard disk drives.
4. The ServerGuide program prompts you to insert your operating-system CD and restart the server. At this point, the installation program for the operating system takes control to complete the installation.



The following table contains information about the supported operating systems.

**Note:** All listed operating systems are supported by the Remote Supervisor Adapter.

*Table 1. Supported operating systems and the configurations they support*

Operating system	ServerGuide support	Maximum memory and SMP support	Hot-plug PCI support	Memory hot-add support	Hyper-threading support	RSA II-EXA support
Microsoft Windows NT <sup>®</sup> Server 4.0 Enterprise Edition	No	4 GB, Single SMP Expansion module only (2-way with Intel Xeon DP microprocessors, 4-way with Intel Xeon MP microprocessors)	No	No	No	No
Microsoft Windows 2000 Server	Yes	4 GB, 4-way	Yes	No	No	Yes
Microsoft Windows 2000 Advanced Server	Yes	8 GB, 8-way	Yes	No	No	Yes
Microsoft Windows 2000 Datacenter Server	No	32 GB, 16-way	Yes	No	Yes	Yes
Microsoft Windows Server 2003 Standard Edition	Yes	4 GB, 4-way	Yes	No	Yes	Yes
Microsoft Windows Server 2003 Enterprise Edition	Yes	32 GB, 8-way	Yes	Yes	Yes	Yes
Microsoft Windows Server 2003 Datacenter Edition	No	64 GB, 16-way	Yes	Yes	Yes	Yes
Novell NetWare 6.5	No	64 GB, 8-way	Yes	No	Yes	Yes
Red Hat Linux Advanced Server 2.1	No	16 GB, 8-way	Yes	No	Yes	Yes
SCO UnixWare 7.1.3	No	64 GB, 8-way	No	No	Yes	No
SuSE Linux Enterprise Server 8	No	32 GB, 8-way	Yes	No	Yes	Yes
VMware ESX Server 2.0	No	64 GB, 16-way	No	No	No	Yes

## Installing your operating system without ServerGuide

If you have already configured the server hardware and you decide not to use the ServerGuide program to install your operating system, complete the following steps to download the latest operating-system installation instructions from the IBM Support Web page:

1. Go to <http://www.ibm.com/pc/support/>.
2. In the **Learn** section, click **Online publications**.
3. On the “Online publications” page, in the **Brand** field, select **Servers**.
4. In the **Family** field, select **xSeries 445**.
5. Click **Continue**.
6. In the **View by document type** field, select **OS installation**.
7. Select the instructions for your operating system.

---

## Configuring the Gigabit Ethernet controller

The Ethernet controller is integrated on the system board. It provides an interface for connecting to a 10-Mbps, 100-Mbps, or 1-Gbps network and provides full-duplex (FDX) capability, which enables simultaneous transmission and reception of data on the network. If the Ethernet ports in your server support auto-negotiation, the controller detects the data-transfer rate (10BASE-T, 100BASE-TX, or 1000BASE-T) and duplex mode (full-duplex or half-duplex) of the network and automatically operates at that rate and mode.

You do not need to set any jumpers or configure the controller. However, you must install a device driver to enable the operating system to address the controller. For device drivers and information about configuring the Ethernet controller, see the *Broadcom NetXtreme Gigabit Ethernet Software CD* that comes with your server. For updated information about configuring the controller, go to <http://www.ibm.com/pc/support/>.

---

## Using the Integrated System Management Firmware Update Utility program

To update the firmware for the integrated system management processor (ISMP), download the Integrated System Management Processor Update utility program for your server from the IBM Support Web site at <http://www.ibm.com/pc/support/>. Run the utility program to create a diskette that you can use to update the firmware. The utility program updates the integrated system management processor firmware only and does not affect any device drivers.

Complete the following steps to update the firmware:

1. Turn off the server.
2. Insert the diskette into the diskette drive.
3. Turn on the server. If the server does not start from the diskette, use the Configuration/Setup Utility program to configure the diskette drive as a startup device. (For more information, see the information about Configuration/Setup Utility start options in the *User's Guide*). Then, start again at step 1 of this procedure.
4. From the main menu, select **Update System Management Firmware** and press Enter.
5. Follow the instructions on the screen to complete the update.

If there is an error in updating the firmware, try updating the firmware again.

---

## Using the LSI Logic Configuration Utility program

Use the LSI Logic Configuration Utility program to:

- Set a SCSI device scan order
- View or change SCSI IDs for attached devices
- Set SCSI protocol parameters on SCSI hard disk drives

The integrated SCSI controller with RAID capabilities in your server supports only RAID level-1 and RAID level-1 Enhanced (RAID level-1E). Installing an optional ServeRAID controller provides additional RAID levels. See "Using ServeRAID Manager" on page 31 for information about configuring your server for RAID operation.

Complete the following steps to start the LSI Logic Configuration Utility program:

1. Turn on the server.
2. When the prompt <<< Press <CTRL><C> to start LSI Logic Configuration Utility >>> appears, press Ctrl+C. If you have set an administrator password, you are prompted to type the password.
3. Use the arrow keys to select a controller (channel) from the list of adapters; then, press Enter.
4. Follow the instructions on the screen to change the settings of the selected items; then, press Enter. If you select **Device Properties** or **Mirroring Properties**, additional screens are displayed.

---

## Using ServeRAID Manager

Use ServeRAID Manager, which is on the *IBM ServeRAID Support CD*, to:

- Configure a redundant array of independent disks (RAID)
- Restore a SCSI hard disk drive to the factory-default settings, erasing all data from the disk
- View your RAID configuration and associated devices
- Monitor the operation of your RAID controllers

To perform some tasks, you can run ServeRAID Manager as an installed program. However, to configure the integrated SCSI controller with RAID capabilities and perform an initial RAID configuration on your server, you must run ServeRAID Manager in Startable CD mode, as described in the instructions in this section. If you install a different type of RAID adapter in your server, use the configuration method described in the instructions that come with that adapter to view or change SCSI settings for attached devices.

See the ServeRAID documentation on the *IBM ServeRAID Support CD* for additional information about RAID technology and instructions for using ServeRAID Manager to configure your integrated SCSI controller with RAID capabilities. Additional information about ServeRAID Manager is also available from the **Help** menu. For information about a specific object in the ServeRAID Manager tree, select the object and click **Actions** ⇒ **Hints and tips**.

## Configuring the controller

By running ServeRAID Manager in Startable CD mode, you can configure the controller before you install your operating system. The information in this section assumes that you are running ServeRAID Manager in Startable CD mode.

To run ServeRAID Manager in Startable CD mode, turn on the server; then, insert the CD into the DVD-ROM drive. If ServeRAID Manager detects an unconfigured controller and ready drives, the Configuration wizard starts, and a window similar to that shown in the following illustration opens.

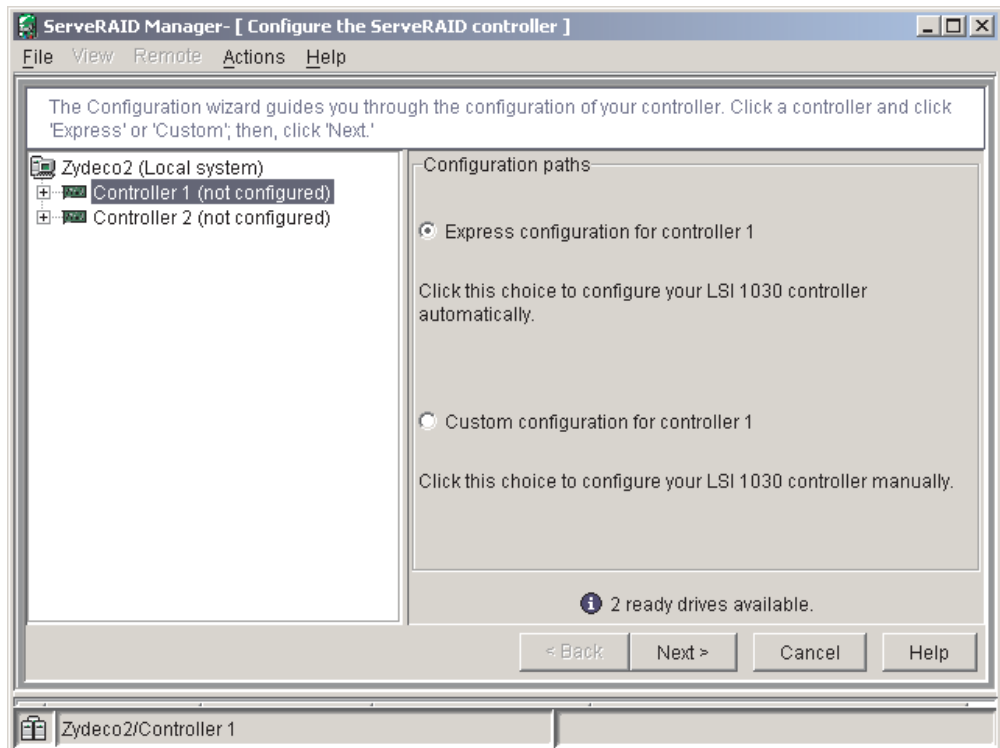

Figure 6. "Configuration wizard" window

In the Configuration wizard, you can select express configuration or custom configuration. Express configuration automatically configures the controller by grouping the first two physical drives in the ServeRAID Manager tree into an array and creating a RAID level-1 logical drive. If you select custom configuration, you can select the two physical drives that you want to group into an array and create a hot-spare drive.

## Using express configuration

Complete the following steps to use express configuration:

1. In the ServeRAID Manager tree, click the controller.
2. Click **Express configuration**.
3. Click Next. The “Configuration summary” window opens.
4. Review the information in the “Configuration summary” window. To change the configuration, click **Modify arrays**.

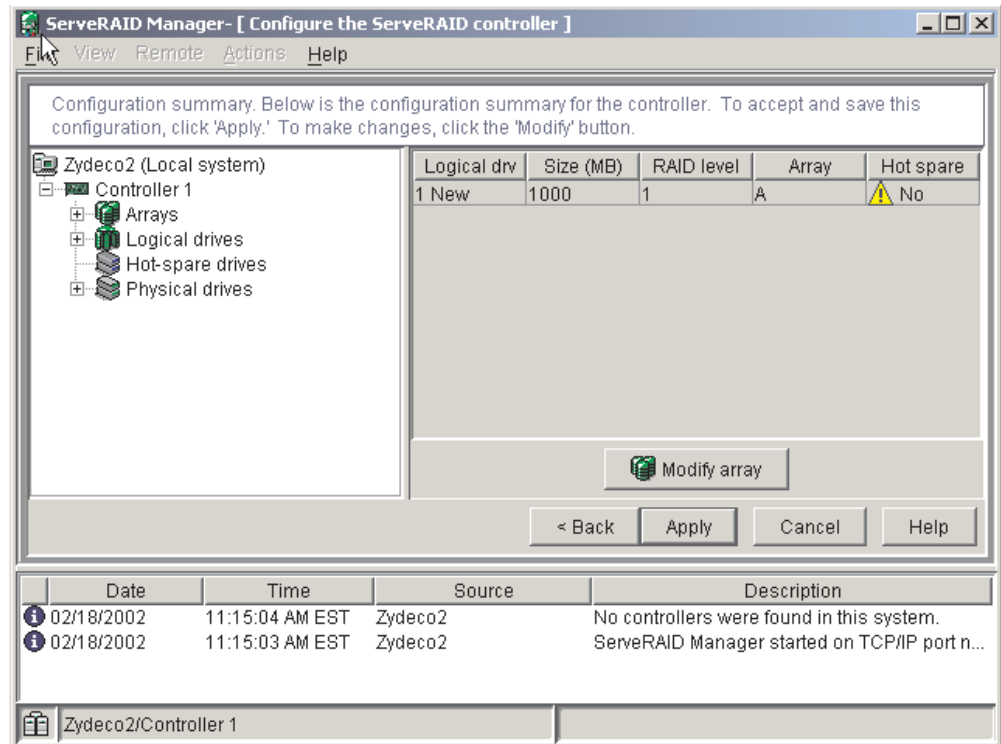

Figure 7. “Configuration summary” window

5. Click **Apply**; then, click **Yes** when asked if you want to apply the new configuration. The configuration is saved in the controller and in the physical drives.
6. Exit from ServeRAID Manager and remove the CD from the DVD-ROM drive.
7. Restart the server.

## Using custom configuration

Complete the following steps to use custom configuration:

1. In the ServeRAID Manager tree, click the controller.
2. Click **Custom configuration**.
3. Click **Next**. The “Create arrays” window opens.

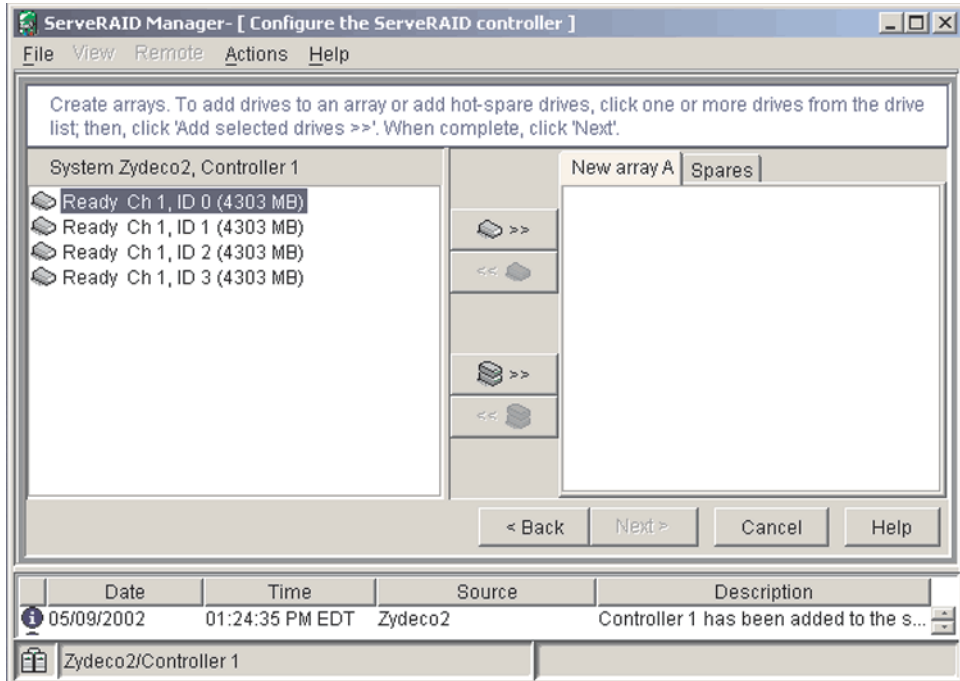

Figure 8. “Create arrays” window

4. From the list of ready drives, select the two drives that you want to group into the array.
5. Click (Add selected drives) to add the drives to the array.
6. If you want to configure a hot-spare drive, complete the following steps:
  - a. Click the Spares tab.
  - b. Select the physical drive that you want to designate as the hot-spare drive, and click (Add selected drives).
7. Click **Next**. The “Configuration summary” window opens.

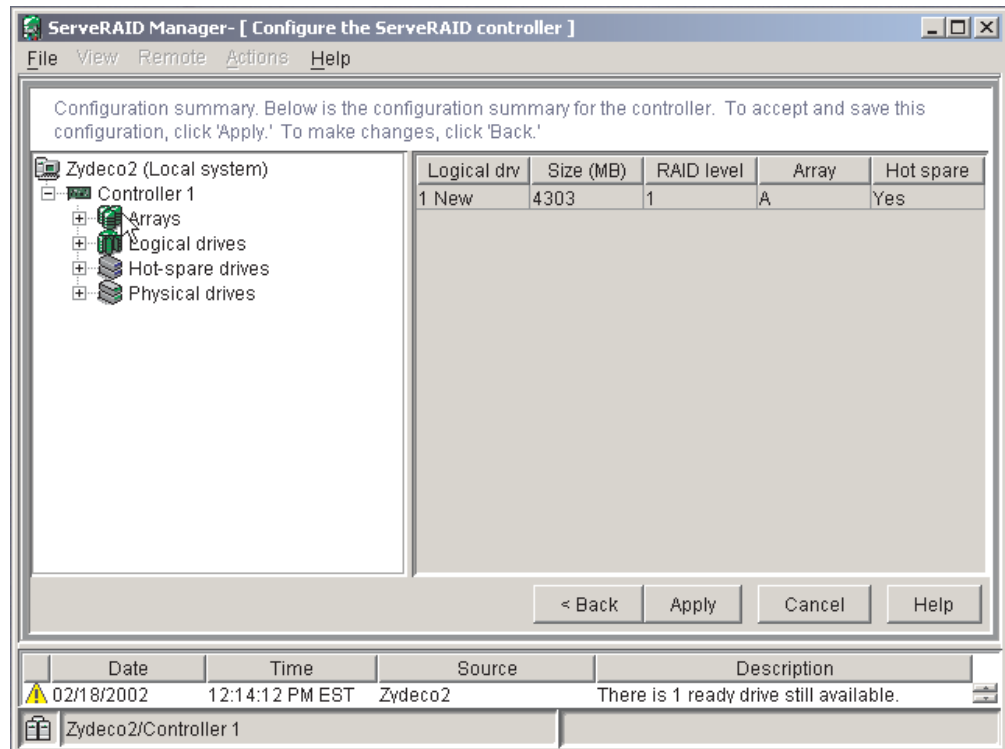

Figure 9. "Configuration summary" window

8. Review the information in the "Configuration summary" window. To change the configuration, click **Back**.
9. Click **Apply**; then, click **Yes** when asked if you want to apply the new configuration. The configuration is saved in the controller and in the physical drives.
10. Exit from ServeRAID Manager and remove the CD from the DVD-ROM drive.
11. Restart the server.

## Viewing the configuration

You can use ServeRAID Manager to view information about RAID controllers and the RAID subsystem (such as arrays, logical drives, hot-spare drives, and physical drives). When you click an object in the ServeRAID Manager tree, information about that object appears in the right pane. To display a list of available actions for an object, click the object and click **Actions**.

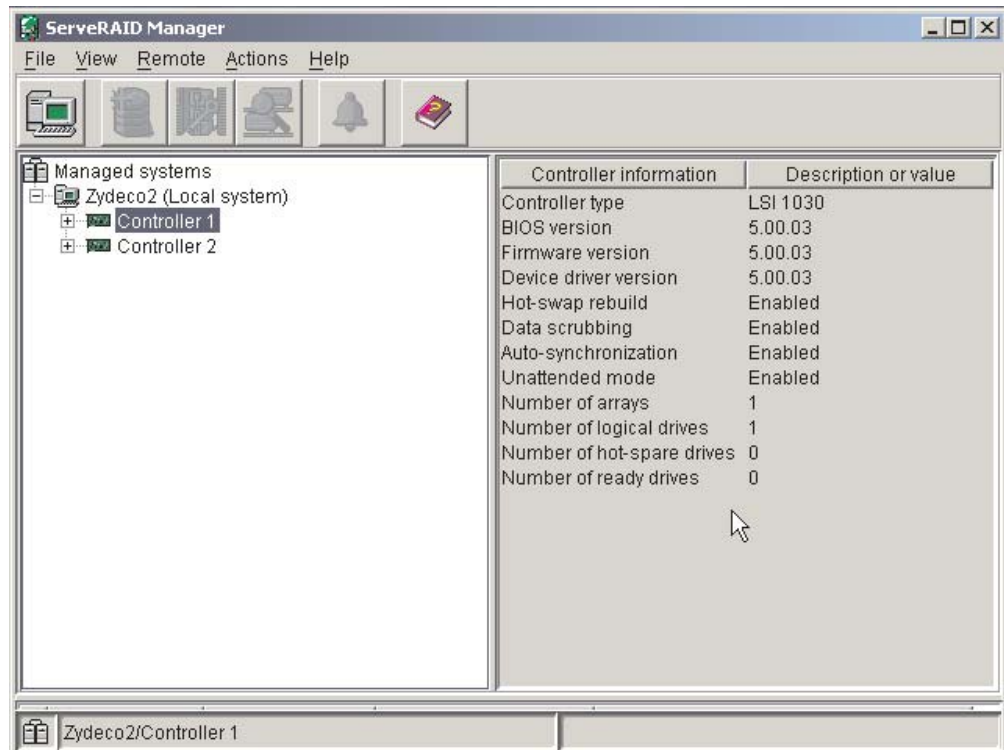

Figure 10. ServeRAID Manager window



## Getting assistance

For more information about ServeRAID Manager, see the online help system. To start the help system, click Help on the toolbar or select an item from the **Help** menu.

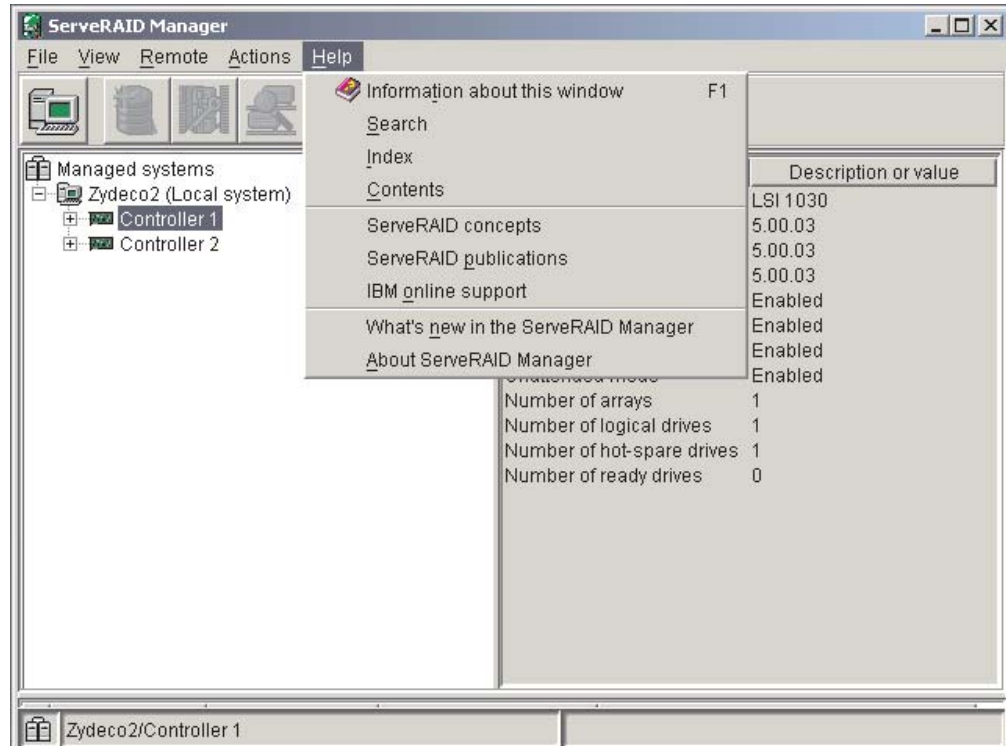

Figure 11. ServeRAID Manager help menu

The help system (ServeRAID Assist) will open within the ServeRAID Manager interface.

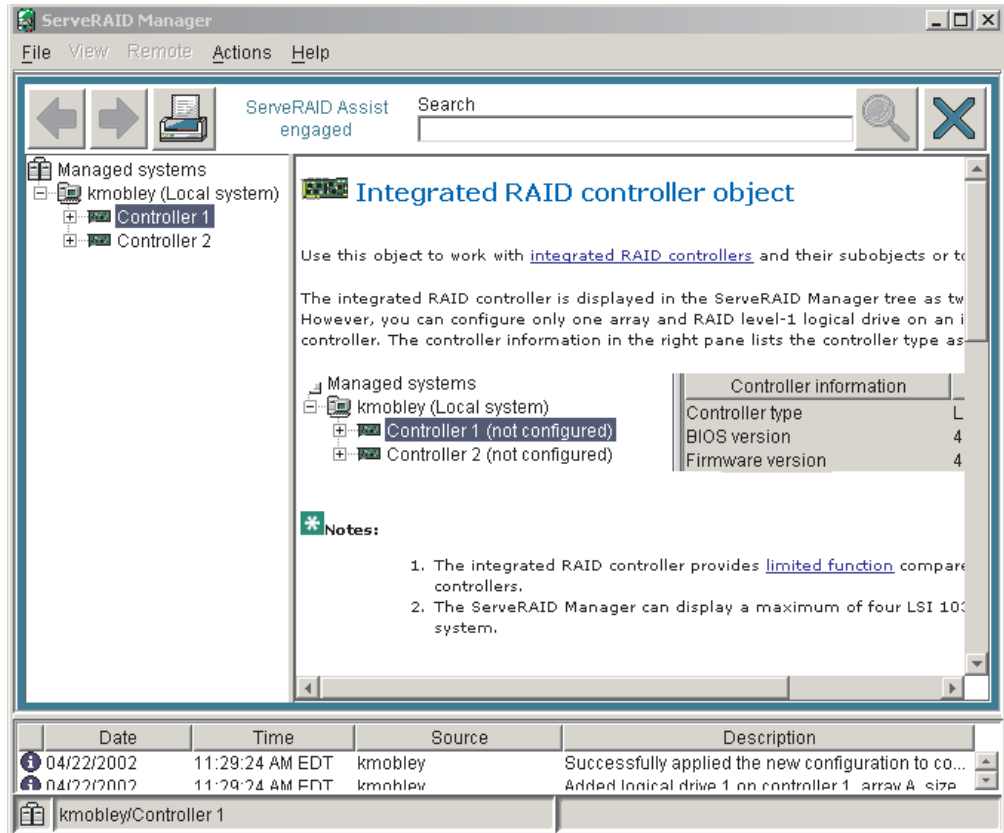

Figure 12. Hints and tips feature

To learn more about the ServeRAID Manager tree objects and the actions that apply to them, select a tree object and click **Actions** ⇒ **Hints and tips**. ServeRAID Assist will start, and information about the tree object will appear in the right pane of ServeRAID Manager.

---

## Remote Supervisor Adapters

This section describes how to identify the Remote Supervisor Adapter by its features and prerequisites for setup. It also explains how to cable and configure a Remote Supervisor Adapter or Remote Supervisor Adapter II-EXA for use on an Advanced System Management (ASM) network so that you can manage the server from a remote location. For more detailed information, see the appropriate *Remote Supervisor Adapter User's Guide* on the IBM xSeries Documentation CD.

### Identifying the Remote Supervisor Adapter

Your server comes with either a Remote Supervisor Adapter or a Remote Supervisor Adapter II-EXA installed. Before you can configure and use your Remote Supervisor Adapter, you must identify which Remote Supervisor Adapter is installed. The easiest way to identify the Remote Supervisor Adapter installed in your server is visually.

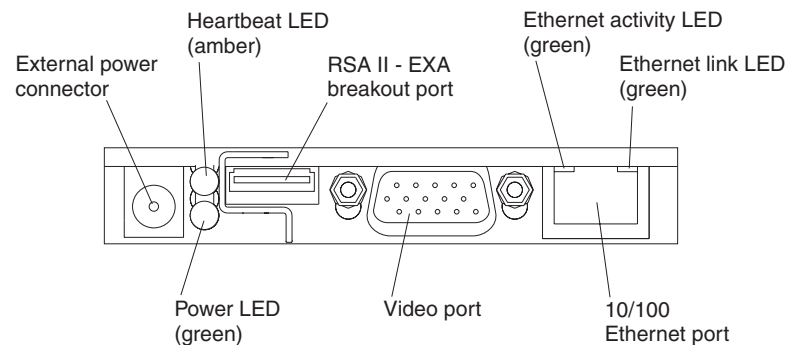

Figure 13. Remote Supervisor Adapter II-EXA connectors and LEDs

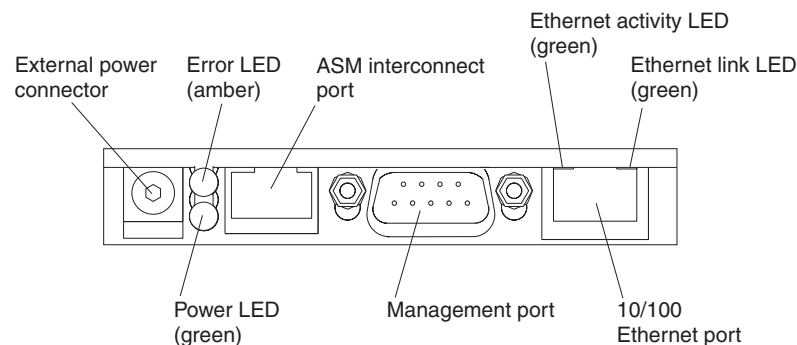

Figure 14. Remote Supervisor Adapter connectors and LEDs

Use Figure 13 and Figure 14 to identify the type of Remote Supervisor Adapter installed in the server. After identifying the adapter, see “Setting up the Remote Supervisor Adapter II-EXA” on page 40 or “Setting up the Remote Supervisor Adapter” on page 52.

## Setting up the Remote Supervisor Adapter II-EXA

This section describes features, setup requirements, and how to cable and configure the Remote Supervisor Adapter II-EXA for use on an Advanced System Management (ASM) network so that you can manage the server from a remote location.

For more detailed information, see the *Remote Supervisor Adapter II User's Guide* on the IBM *xSeries Documentation CD*.

### Remote Supervisor Adapter II-EXA features

The Remote Supervisor Adapter II-EXA provides the following:

- Seamless remote accelerated graphics
- Enhanced security features
- Continuous health monitoring and control
- Advanced Predictive Failure Analysis<sup>®</sup> (PFA) support
- Automated Server Restart (ASR)
- Automatic notification and alerts
- Event logs that are time stamped, saved on the Remote Supervisor Adapter II-EXA, and can be attached to e-mail alerts
- Server console redirection
- LAN and Advanced System Management (ASM) interconnect remote access
- Simple Network Management Protocol (SNMP) trap support
- Domain Name System (DNS) and Dynamic Host Configuration Protocol (DHCP) support
- Remote power control
- Capture operating-system-failure screen
- Remote firmware update and access to critical server settings
- Independent power, which enables around-the-clock access to the server even when the server power is off
- Virtually attach remote diskette drive, CD-ROM drive, or disk image to server

### Setup requirements

The following items are required to set up the Remote Supervisor Adapter II-EXA:

- Make sure you have an Internet connection. You will need an Internet connection during the installation process to download software and firmware from the IBM Support Web site. For information about how to download the Remote Supervisor Adapter II-EXA files, see "Obtaining Remote Supervisor Adapter II-EXA software and firmware" on page 44.
- Install the operating system on your server before you install the device drivers for the Remote Supervisor Adapter II-EXA. For information about installing the operating system, see the documentation that comes with your server.
- Remote Supervisor Adapter II-EXA device drivers. See Table 1 on page 29 for a list of the supported operating systems.

**Note:** Not all versions of Red Hat Linux or SuSE Linux are supported for all server models. To check if there is a supported Remote Supervisor Adapter II-EXA device driver for your server model running your version of Linux, go to <http://www.ibm.com/pc/support/>.

- The remote disk function requires the following software:
  - Server (for the server operating system to support the remote disk): Microsoft Windows 2000 with Service Pack 3 or above.
  - Client: Microsoft Windows 2000 or above and the Java™ 1.4 Plug-in or later.
- To configure the remote alert recipients for Director over LAN or Director over modem, the remote alert recipient must be an IBM Director-enabled server with UM Server Extensions.
- The Remote Supervisor Adapter II-EXA supports the following Web browsers for remote access. The Web browser that you use must be Java-enabled and must support JavaScript™.
  - Microsoft Internet Explorer 4.0 (with Service Pack 1), or later
  - Netscape Navigator 4.72, or later (version 6.0 is not currently supported)

**Notes:**

1. JavaJava plug-in version 1.4 or later is required.
2. The Remote Supervisor Adapter II Web interface does not support the double-byte character set (DBCS) languages.
  - Support of HTTP version 1.0, or later
  - Minimum display resolution of 800 x 600 pixels and 256 colors

**Note:** The ASM Web interface and the ASM text-based interface do not support the double-byte character set (DBCS) languages.

### **Cabling and configuring the Remote Supervisor Adapter II-EXA**

Complete the following steps to cable and configure the Remote Supervisor Adapter II-EXA.

**Note:** After you initially configure the adapter, use the Web-based interface to create a backup copy of the configuration. If you need to replace the adapter in the future, you can restore the configuration and resume normal operation more quickly. See the *IBM Remote Supervisor Adapter II User's Guide* on the IBM xSeries Documentation CD for details.

**Step 1.**

Cable the Remote Supervisor Adapter II-EXA. (See “Cable the Remote Supervisor Adapter II-EXA” on page 43 for instructions.)

**Step 2.**

Get the Remote Supervisor Adapter software and firmware. (See “Obtaining Remote Supervisor Adapter II-EXA software and firmware” on page 44 for instructions.)

**Step 3.**

Complete the setup of the Remote Supervisor Adapter II-EXA. (See “Completing the setup” on page 46 for instructions.)

For service, assistance, or additional information on the World Wide Web, see Appendix A, “Getting help and technical assistance,” on page 71.

**The RSA II-EXA breakout cable:** The ASM breakout cable connects the Remote Supervisor Adapter II-EXA to the ASM interconnect network, the server USB port, and an external modem.

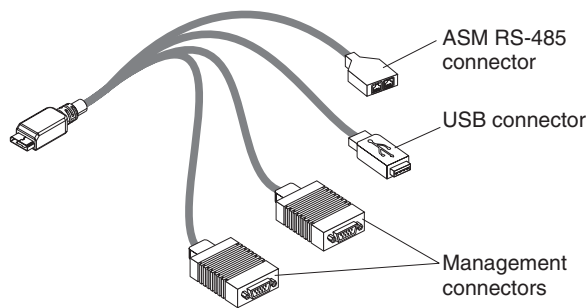

Figure 15. RSA II-EXA breakout cable

**RSA II-EXA breakout cable connections:** The RSA II-EXA breakout cable is used to provide the following connections:

- **ASM Interconnect port**  
To connect the Remote Supervisor Adapter II-EXA to an ASM interconnect network, connect a Category 3 or Category 5 cable to one of the ASM Interconnect ports on the RSA II-EXA breakout cable. For more information, see “Using the ASM interconnect network” on page 63.
- **USB connector**  
To connect the Remote Supervisor Adapter II-EXA to the USB port on the server for providing remote keyboard, video, and mouse control of the server, plug the USB connector on the RSA II-EXA breakout cable into a USB port on the server.
- **Management ports**  
To connect the Remote Supervisor Adapter II-EXA to a modem, connect the modem to a management port connector on the RSA II-EXA breakout cable.

**Note:** Connecting a modem to the Remote Supervisor Adapter II-EXA provides dial-out support only.

**Cable the Remote Supervisor Adapter II-EXA:** This section provides the information needed to cable the Remote Supervisor Adapter II.

1. Connect the RSA II-EXA breakout cable to the RSA II-EXA breakout port on the server.

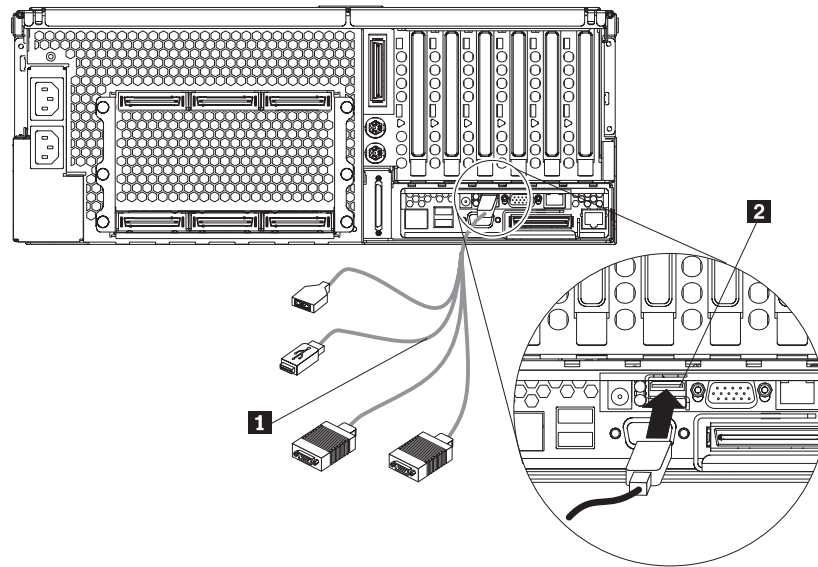

Figure 16. Connect the RSA II-EXA breakout cable to the server

2. Connect the video cable from your video device to the video port on the Remote Supervisor Adapter II-EXA.
3. Plug the USB connector on the RSA II-EXA breakout cable into one of the USB ports on the rear of the server.

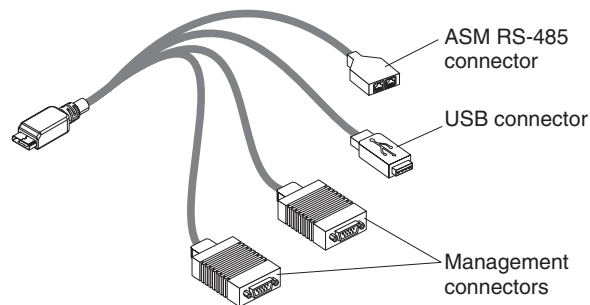

Figure 17. RSA II-EXA breakout cable

4. Complete the following steps to connect the Remote Supervisor Adapter II-EXA to the LAN:
  - a. Connect one end of a Category 3 or Category 5 Ethernet cable to the Ethernet connector on the Remote Supervisor Adapter II-EXA. Connect the other end of the Ethernet cable to your network.

- b. Check the Remote Supervisor Adapter II-EXA Ethernet link and activity LEDs. The location of the LEDs are shown in the following illustration.

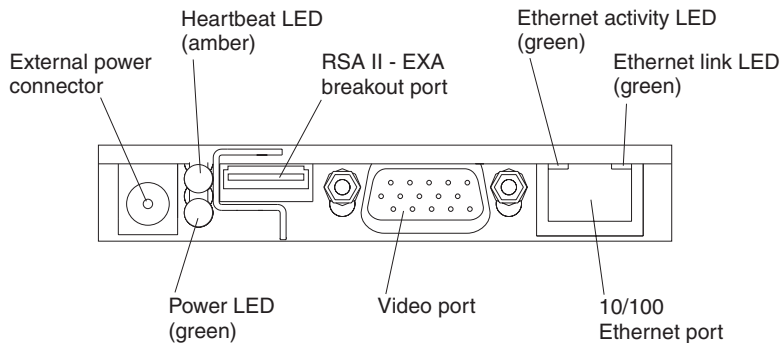

Figure 18. Remote Supervisor Adapter II-EXA connectors

- **External power connector:** You can connect an optional ac power adapter to this connector.
- **Heartbeat LED:** This amber LED flashes continuously to indicate that there is activity on the Remote Supervisor Adapter II-EXA.
- **RSA II-EXA breakout port:** Connect the RSA II-EXA breakout cable to this port to provide two ASM interconnect ports, one USB port, and one Management port.
- **Ethernet activity LED:** This green LED is lit when there is activity on the Ethernet LAN.
- **Ethernet link LED:** This green LED is lit when the Ethernet link is active.
- **10/100 Ethernet port:** Connect Ethernet signal cables to this port.
- **Video port:** Connect a monitor or console switch to this port.

**Important:** The integrated video controller is disabled on models that have a Remote Supervisor Adapter II-EXA installed. You must connect a monitor or console switch to the video port on the Remote Supervisor Adapter II-EXA.

- **Power LED:** This green LED comes on and stays lit when you plug in your server.
- c. Continue with “Obtaining Remote Supervisor Adapter II-EXA software and firmware” and “Completing the setup” on page 46.

**Note:** See the *IBM Remote Supervisor Adapter II User’s Guide* on the IBM *xSeries Documentation* CD for detailed information on how to manage your server remotely using the Web-based user interface.

**Obtaining Remote Supervisor Adapter II-EXA software and firmware:** Before you can continue the configuration of the Remote Supervisor Adapter II-EXA, you must download software and firmware from the IBM Support Web site. This section describes how to download the files from the Web site. Which files you need to download depends on your operating system.

**Note:** Changes are made periodically to the IBM Support Web site to provide timely customer information and better navigation. The search methods in the following procedures are suggestions. You might need to modify the search process depending on the Web page design.



*For Microsoft Windows 2000 or Windows Server 2003:* If the server in which the Remote Supervisor Adapter II-EXA is installed is running the Microsoft Windows 2000 or Windows Server 2003 operating system, you will need to download one file, which contains the following software and firmware:

- Software and firmware installation instructions
- Video adapter basic input/output system (BIOS) update
- IBM @server xSeries BIOS update with support for the Remote Supervisor Adapter II-EXA
- Diagnostics code update
- Remote Supervisor Adapter II-EXA device drivers
- Remote Supervisor Adapter II-EXA firmware code update
- Integrated system management processor (ISMP) update
- Video device driver
- Advanced Settings Utility program

The software and firmware files that you need are contained in one system service package for Windows installation kit. Complete the following steps to locate and download the package file.

1. Go to <http://www.ibm.com/pc/support/>.
2. In the left navigation pane, click **Search PC support**.
3. In the “Search PC support” window, under **Additional search options**, in the **Restrict to this document type** field, select **Downloads and drivers**.
4. In the **Restrict to this brand** field, select **Servers**.
5. Wait for the page to automatically refresh; then, in the **Restrict to this family** field, select your server model.
6. Wait for the page to automatically refresh; then, in the **Enter search terms** field, type system service package. (Do not use the **Search** field.)
7. Click **Search**.
8. Select the system service package that corresponds to the server model and the operating system that is running on the server in which the Remote Supervisor Adapter II-EXA is installed. The file you download will be in \*.exe format.
9. Click the file link to download the system service package to *d:/ibmssp*, where *d* is the hard disk drive letter. (Create the directory if necessary.)
10. Browse the *d:/ibmssp* directory and double click the \*.exe file to extract the packaged files. Extract the files into the *d:/ibmssp* directory.
11. See the readme.txt file that is extracted into the *d:/ibmssp* directory for a list of the file names and their descriptions.
12. To ensure correct software installation, follow the detailed installation instructions in *Remote Supervisor Adapter II Installation Instructions for Windows Users*, which is in Portable Document Format (PDF) in the *d:/ibmssp* directory. Then, continue with “Completing the setup” on page 46.

*For SuSE Linux and Red Hat Linux:* If the server in which the Remote Supervisor Adapter II-EXA is installed is running the Red Hat Linux or SuSE Linux operating system, you will need to download one file, which contains the following software and firmware:

- Software and firmware installation instructions
- Video adapter basic input/output system (BIOS) update

- IBM @server xSeries BIOS update with support for the Remote Supervisor Adapter II-EXA
- Diagnostics code update
- Remote Supervisor Adapter II-EXA device drivers
- Remote Supervisor Adapter II-EXA firmware code update
- Advanced Settings Utility program

The software and firmware files that you need are contained in one system service package for Linux installation kit. Complete the following steps to locate and download the package file:

1. Go to <http://www.ibm.com/pc/support/>.
2. In the left navigation pane, click **Search PC support**.
3. In the “Search PC support” window, under **Additional search options**, in the **Restrict to this document type** field, select **Downloads and drivers**.
4. In the **Restrict to this brand** field, select **Servers**.
5. Wait for the page to automatically refresh; then, in the **Restrict to this family** field, select your server model.
6. Wait for the page to automatically refresh; then, in the **Enter search terms** field, type "system service package". (Do not use the **Search** field.)
7. Click **Search**.
8. Select the system service package that corresponds to the server model and the operating system that is running on the server in which the Remote Supervisor Adapter II is installed. The file you download will be in \*.tgz format.
9. Click the file link to download the system service package.
10. From a command-line prompt, type `tar -xvfz filename.tgz`, where *filename* is the name of the file you downloaded. This command will create a directory named `ibmssp` and extract the files to it.
11. See the `readme.txt` file that is extracted into the `ibmssp` directory for a list of the file names and their descriptions.
12. To ensure correct software installation, follow the detailed installation instructions in *Remote Supervisor Adapter II Installation Instructions for Linux Users*, which is in Portable Document Format (PDF) in the `ibmssp` directory. Then, continue with “Completing the setup.”

**Completing the setup:** Complete the following steps to complete the setup of the Remote Supervisor Adapter II-EXA:

1. If you plan to configure Simple Network Management Protocol (SNMP) traps on the Remote Supervisor Adapter II-EXA, install and compile the management information base (MIB) on your SNMP manager. The MIB supports SNMP traps. The MIB is available on the IBM Support Web site. For more information, see “Obtaining Remote Supervisor Adapter II-EXA software and firmware” on page 44.
2. If you did not restart the server after installing the Remote Supervisor Adapter II-EXA device drivers, restart the server now.
3. See the *IBM Remote Supervisor Adapter II User’s Guide* on IBM xSeries Documentation CD for detailed instructions for completing the configuration of the Remote Supervisor Adapter II-EXA, including the following features:
  - Defining the login IDs and passwords
  - Selecting the events that will receive alert notification
  - Monitoring remote server status using the Remote Supervisor Adapter II-EXA Web interface

- Controlling the server remotely
- Virtually attaching a remote diskette drive, CD-ROM drive, or disk image to the server

If you want to set up an ASM interconnect network and have not already done so, continue with “Configuring and connecting to the ASM interconnect network.” If you do not want to set up an ASM interconnect network, your configuration is now complete.

## **Configuring and connecting to the ASM interconnect network**

This section includes information about how to configure and connect your server to function within an Advanced System Management (ASM) interconnect network.

**Overview:** You can connect system-management processors and adapters together to form an Advanced System Management (ASM) interconnect network. *System-management processors and adapters* are Remote Supervisor Adapter II-EXAs, Remote Supervisor Adapter IIs, Remote Supervisor Adapters, ASM processors, ASM PCI adapters, and integrated system management processors (ISMPs). These system-management processors and adapters are also known as *service processors*.

An ASM interconnect network provides two levels of functionality. First, the ASM interconnect network enables you to control and to configure settings for the servers in which other system-management processors and adapters reside. Second, the ASM interconnect network enables other system-management processors and adapters to use the resources (Ethernet or modem) of other Remote Supervisor Adapter II-EXAs, Remote Supervisor Adapters IIs, Remote Supervisor Adapters, ASM processors (modems only), and ASM PCI adapters in the ASM interconnect network for sending alerts. This interconnect network is used when system-management processors or adapters cannot send an alert and must forward the information to another system-management processor or adapter to send the alert.

**Planning and cabling your ASM interconnect network:** To support the most recent ASM features, a Remote Supervisor Adapter II-EXA must be the main gateway to your ASM interconnect network if the network also includes servers with Remote Supervisor Adapters, ASM PCI adapters, ASM processors, or ISMPs. The Remote Supervisor Adapter II-EXA forwards the ASM information generated by the servers attached to the ASM interconnect network to other servers on your Ethernet network or that are attached through a modem. The connected ASM processors, ASM PCI Adapters, and ISMPs are managed through the user interface and Web browser access of the Remote Supervisor Adapter II.

Before cabling the ASM interconnect network, review the following information:

- You must connect an RSA II-EXA breakout cable to the Remote Supervisor Adapter II-EXA.
- You must connect an ASM interconnect module to a Remote Supervisor Adapter.
- The cables in an ASM interconnect network are hot-swappable.
- Make sure that the firmware for the Remote Supervisor Adapter II-EXA, Remote Supervisor Adapter, ASM processor, ASM PCI adapter, and ISMP are at the latest level.
- The servers in an ASM interconnect network are referred to by their assigned names, not by their positions in the rack cabinet.

An ASM interconnect network can have up to 24 RS-485 connections, depending on the configuration. The connections can include Remote Supervisor Adapter II-EXAs, Remote Supervisor Adapter IIs, Remote Supervisor Adapters, ASM processors, ASM PCI adapters, and ISMPs. Use the following information to determine the number of servers and connections that you can have on your ASM interconnect network:

- Each Remote Supervisor Adapter II-EXA, Remote Supervisor Adapter II, Remote Supervisor Adapter, ASM processor, ASM PCI adapter, and ISMP in a server that is connected to the network uses one connection. For example, if a server that is connected to the network has a Remote Supervisor Adapter and an integrated ASM processor, the server uses two connections on the network.
- The network must include at least one server with a Remote Supervisor II-EXA, Remote Supervisor Adapter II, or Remote Supervisor Adapter (either installed as an option or preinstalled in the server).
- On an ASM interconnect network, one ASM processor or one ASM PCI adapter can communicate with 11 RS-485 connections. These connections must be to ASM processors, ASM PCI adapters, Remote Supervisor Adapters, Remote Supervisor Adapter II-EXAs, or Remote Supervisor Adapter IIs. The ASM processor and ASM PCI adapter cannot communicate with ISMPs.
- If your existing ASM interconnect network has 12 RS-485 connections that include only ASM processors, ASM PCI adapters, and at least one Remote Supervisor Adapter or Remote Supervisor Adapter II, you can also add up to 12 ISMP-based servers to this same network. The Remote Supervisor Adapter on this network will communicate with all 23 RS-485 connections; however, an ASM processor or ASM PCI adapter on this network will communicate with only the 11 non-ISMP RS-485 connections. The ASM processor and ASM PCI adapter will not recognize the ISMPs, but the ISMPs can reside on the same ASM interconnect network.
- Make sure that the ASM interconnect network is set up as a bus, not as a ring. You must connect the servers to the ASM interconnect network in a series, with terminated beginning and end points. Be sure to use the RS-485 terminator plugs. For more information, see “Using the RS-485 terminator plugs on interconnected servers.”
- Make sure that the total combined length of all Ethernet cables connecting the servers in the ASM interconnect network does not exceed 91 m (300 ft).

**Using the RS-485 terminator plugs on interconnected servers:** The Remote Supervisor Adapter II-EXA comes with two RS-485 terminator plugs. To ensure successful RS-485 communication on your ASM interconnect network, you must install the terminator plugs in the open connectors at each end of the RS-485 bus. The illustrations in “ASM interconnect network configuration examples” on page 68 can help you determine where to put the RS-485 terminator plugs on your ASM interconnect network.

**Forwarding alerts:** Remote Supervisor Adapters, ASM PCI adapters, ASM processors, and ISMPs that are connected to an ASM interconnect network share resources and system-management information. This section provides information about how alerts are forwarded in the ASM interconnect network.

During normal operation, each Remote Supervisor Adapter, ASM processor, ASM PCI adapter, and ISMP on the ASM interconnect network communicates with the other processors and adapters on the network. Processors or adapters that have a modem or Ethernet connection notify the other processors and adapters that these communications resources are available for use by other servers on the ASM interconnect network. These resources are then used as ASM interconnect network

resources, enabling Remote Supervisor Adapters, ASM processors, ASM PCI adapters, and ISMPs on the ASM interconnect network to send alerts using a modem or the network, even if they do not have a modem or network connection physically attached.

**Note:** ISMPs can use the communications resources of a Remote Supervisor Adapter, Remote Supervisor Adapter II-EXA, or Remote Supervisor Adapter II only.

When alerts are generated, they are forwarded to the Remote Supervisor Adapter II-EXA, Remote Supervisor Adapter II, Remote Supervisor Adapter, ASM processor, or ASM PCI adapter on the ASM interconnect network that has the communication resources to forward the alert. If no system on the ASM interconnect network meets the requirements, the alert is set for transmission if the connection type is configured or becomes available later.

If multiple modems or network connections exist in the ASM interconnect network, you cannot specify which system will receive an alert or which will use its modem or network connection to forward the alert. If an alert is forwarded to a Remote Supervisor Adapter II-EXA, Remote Supervisor Adapter II, Remote Supervisor Adapter, ASM processor, or ASM PCI adapter that is unable to deliver the alert (for example, the modem it is configured to use has failed or the network cannot resolve the destination IP address), the processor or adapter attempts to forward the alert to another system on the ASM interconnect network that has the communication resources to forward the alert.

Alerts are typically sent only once (per connection type), but an alert is forwarded to another interconnect device if the resources exist on other interconnect devices in the network. For example, on a three ASM processor network where ASM processor 1 generates a modem alert, but does not have a modem and the two other ASM servers with ASM processors have modems connected to them, the following might occur:

If ASM processor 1 generates an alert and the modem is unplugged from ASM processor 2 45 seconds or less prior to ASM processor 1 generating the alert, ASM processor 1 forwards the alert to ASM processor 2 having previously determined that ASM processor 2 had an available modem (which is now no longer available). When ASM processor 2 receives the forwarded alert, knowing its modem is not available, it determines that a modem is attached to ASM processor 3, and forwards the alert to ASM processor 3. Therefore, depending upon the time frame (45 seconds) within which a resource (modem) fails, the alert might be forwarded multiple times until a device on the interconnect network can send the alert.

**ASM interconnect network configuration examples:** The illustrations in this section show sample ASM interconnect network configurations.

In the following example, an Ethernet cable connects the remote system management administrator's system to the Remote Supervisor Adapter II-EXA that is installed in an xSeries 445. In this case, the xSeries 445 uses the LAN connection to forward system-management data generated by the other servers in the ASM interconnect network to the remote system-management administrator.

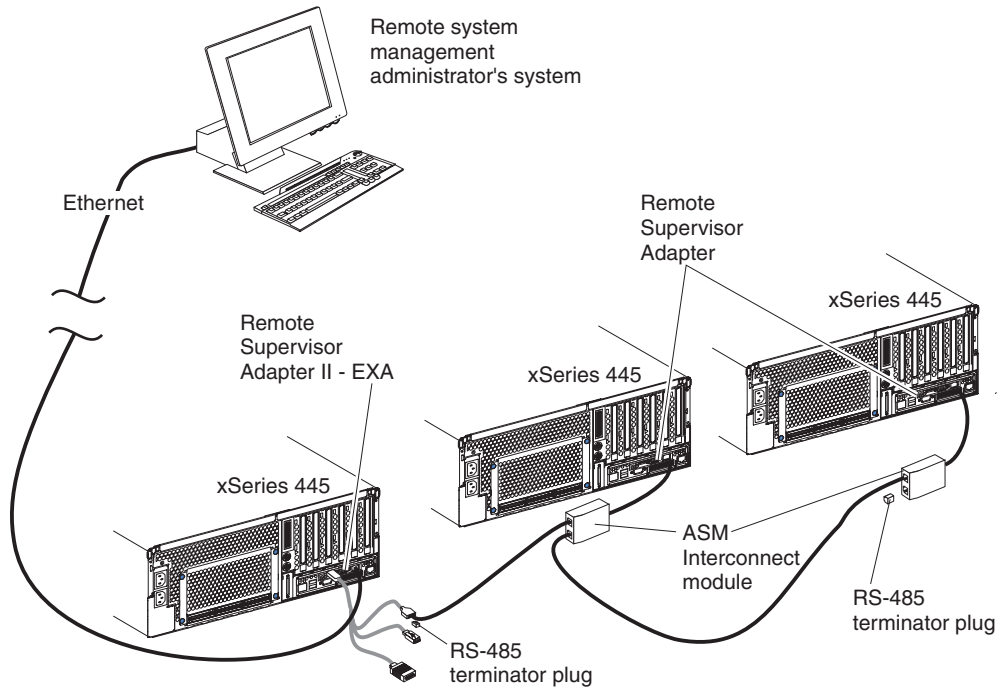
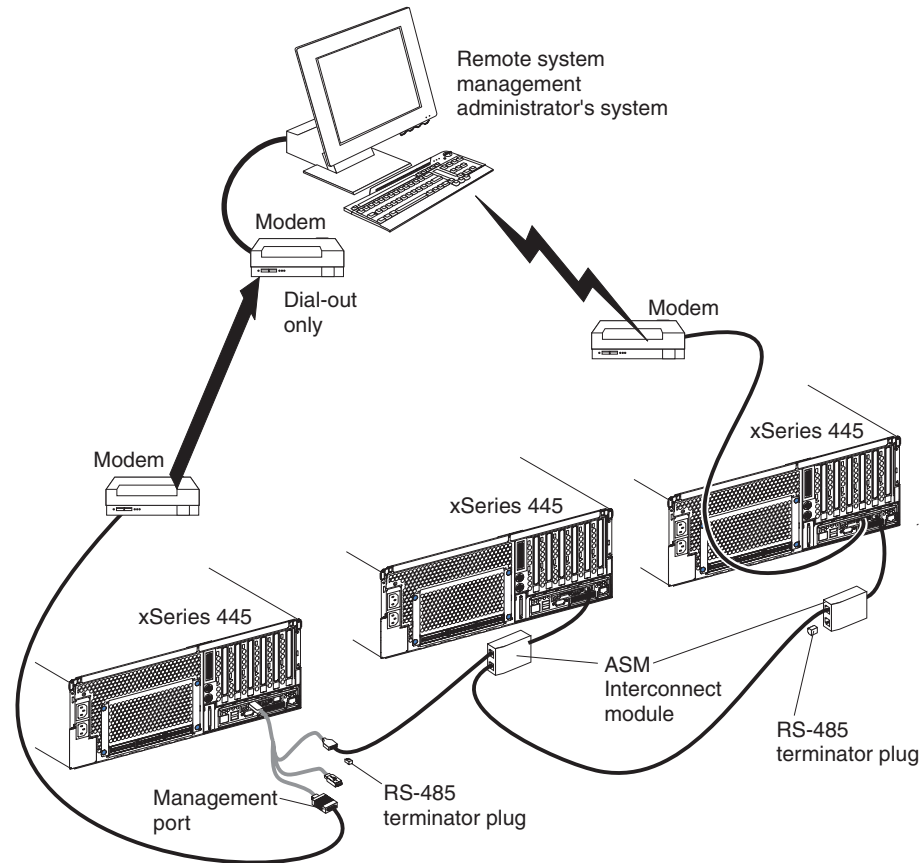

Figure 19. ASM interconnect network Ethernet configuration

In the following example, a Remote Supervisor Adapter II-EXA is installed in an xSeries 44, and creates an interconnect network with the other xSeries 445 servers that have a Remote Supervisor Adapter installed. A modem is connected to the serial connector of the Remote Supervisor Adapter II-EXA (on one end of the ASM breakout cable), a second modem is connected to the management port of the Remote supervisor Adapter in the server connected to the end of the ASM interconnect network, and a modem is connected to the remote system-management administrator's system.



**Note:** The ASM Interconnect module is connected to the RS-485 port on the back panel of the Remote Supervisor Adapter in each server.

Figure 20. ASM interconnect network modem configuration

## Setting up the Remote Supervisor Adapter

This section describes features, setup requirements, and how to cable and configure the Remote Supervisor Adapter for use on an Advanced System Management (ASM) network so that you can manage the server from a remote location.

**Note:** The information in this section is intended for use with the Remote Supervisor Adapter, not the Remote Supervisor Adapter II-EXA. For information on setting up and configuring a Remote Supervisor Adapter II-EXA, go to “Setting up the Remote Supervisor Adapter II-EXA” on page 40.

For more detailed information, see the *Remote Supervisor Adapter User's Guide* on the IBM xSeries Documentation CD.

### Remote Supervisor Adapter features

Standard features of the Remote Supervisor Adapter are as follows:

- Continuous health monitoring and control
- Advanced Predictive Failure Analysis (PFA)
- Configurable notification and alerts
- Event logs that are time-stamped, saved in nonvolatile memory, and can be attached to e-mail alerts
- Remote graphics console redirection
- LAN, serial, and Advanced System Management (ASM) interconnect remote access
- Point-to-point protocol (PPP) support
- Simple Network Management Protocol (SNMP)
- Domain Name System (DNS) and Dynamic Host Configuration Protocol (DHCP) support
- Remote power control
- Microsoft Windows 2000, Windows NT, and Windows Server 2003 blue-screen capture
- Remote firmware update and access to critical server settings
- Optional, independent power, which enables around-the-clock access to the server, even if the server is powered off

### Setup requirements

Before you set up the Remote Supervisor Adapter, you must download to a diskette, the DOS Remote Supervisor Utility program from <http://www.ibm.com/pc/support/>.

Complete the following before you set up the Remote Supervisor Adapter:

- Install the operating system on the server, using ServerGuide and the documentation that comes with the operating system.
- Install the agent component of UM Server Extensions to use the following Advanced System Management (ASM) Web interface features:
  - Shutdown O/S and then Power Off Server
  - Shutdown O/S and then Restart Server

UM Server Extensions is on the system-management software CD that comes with the server. For information about installing the agent component, see the documentation that comes with the system-management CD.



- To configure the remote alert recipients for Director over LAN or Director over modem, the remote alert recipient must be an IBM Director-enabled server with UM Server Extensions.
- If you want to use a Web browser to access the Remote Supervisor Adapter remotely, the following software is required:
  - Microsoft Internet Explorer 4.0 (with Service Pack 1), or later
  - Netscape Navigator 4.72, or later (version 6.0 is not currently supported)
  - Java enabled Web browser (See your browser documentation or online Help for instructions about enabling its Java support.)
  - Support for JavaScript 1.2, or later (See your browser documentation or online Help for instructions about enabling its JavaScript support.)
  - Support of HTTP version 1.0, or later
  - Minimum display resolution of 800 x 600 pixels and 256 colors

**Note:** The ASM Web interface and the ASM text-based interface do not support the double-byte character set (DBCS) languages.

### **Cabling and configuring the Remote Supervisor Adapter**

Complete the following steps to cable and configure the Remote Supervisor Adapter.

**Note:** After you initially configure the adapter, use the Web-based interface to create a backup copy of the configuration. If you need to replace the adapter in the future, you can restore the configuration and resume normal operation more quickly. See the *IBM Remote Supervisor Adapter User's Guide* on the IBM xSeries Documentation CD for details.

#### **Step 1.**

Connect the Ethernet and management port cables. See "Cabling the Ethernet LAN port and management port" on page 54.

#### **Step 2.**

Perform the initial configuration to enable remote access to the Remote Supervisor Adapter. So that you can:

- Configure the Ethernet port
- Configure the management (COM) port
- Set up the point-to-point protocol

See "Enabling remote access to the adapter" on page 55.

#### **Step 3.**

Configure the remote-control password to enable the ASM Web interface remote control features. See "Configuring the remote control password" on page 63.

#### **Step 4.**

Install the ASM device drivers. See "Installing Advanced System Management device drivers" on page 61.

For service, assistance, or additional information on the World Wide Web, see Appendix A, "Getting help and technical assistance," on page 71.

**Cabling the Ethernet LAN port and management port:** This section describes how to cable the Remote Supervisor Adapter. You can manage the server remotely through the Remote Supervisor Adapter using one of the user interfaces and one of the connection methods that are described in Table 2. Select the interface method you want to use to perform remote management; then, perform the indicated cabling procedure.

If you plan to set up an ASM interconnect network, before you begin cabling the server, see “Using the ASM interconnect network” on page 63 for instructions about cabling the ASM interconnect port and setting up the network. You might want to review the information in “ASM interconnect network configuration examples” on page 68 before you connect the cables. Then, return to these instructions to start the cabling procedures.

*Table 2. Cabling tasks to enable remote access to the Remote Supervisor Adapter*

User interface to Remote Supervisor Adapter	Connection to Remote Supervisor Adapter	For the cabling procedure, see:
ASM Web interface using HTTP	LAN using the Ethernet port	“Cabling the Ethernet LAN port” on page 54
Text-based user interface using the Telnet protocol		
Text-based user interface using a modem or a null modem	Management (COM) port	“Cabling the management (COM) port” on page 55
ASM Web interface using point-to-point protocol (PPP)		
Text-based user interface using the Telnet protocol over PPP		

**Cabling the Ethernet LAN port:** Complete the following steps to attach the Ethernet cables.

**Attention:** To avoid damage to the Ethernet connector on the Remote Supervisor Adapter, *do not* connect the ASM Interconnect module to the Ethernet port.

1. Connect one end of a Category 3 or Category 5 Ethernet cable to the Ethernet port on the Remote Supervisor Adapter. Connect the other end of the Ethernet cable to the network.

2. Check the Ethernet LEDs to ensure that the network connection is working. The following illustration shows the location of the LEDs.

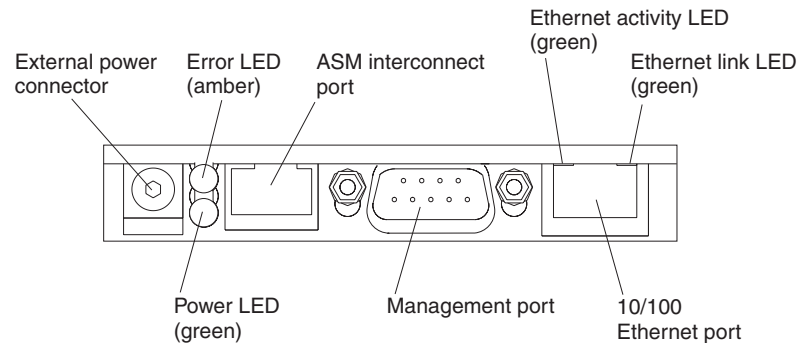

Figure 21. Remote Supervisor Adapter connectors

- **External power connector:** You can connect an optional ac power adapter to this connector.
- **Error LED:** This amber LED is lit when a system management error has occurred.
- **ASM interconnect port:** Connect signal cables for managing expansion module resources to this port.
- **Ethernet activity LED:** When the LED is green there is activity on the Ethernet LAN.
- **Ethernet link LED:** When the LED is green the link is active.
- **10/100 Ethernet port:** Connect Ethernet signal cables to the Ethernet port.
- **Management port:** Connect a serial cable to this port to enable system management through a modem, or connect a null modem cable to enable system management through a workstation or laptop computer.
- **Power LED:** This green LED comes on and stays lit when you plug in your server.

If you want to use the management port connection, continue with “Cabling the management (COM) port” on page 55; otherwise, go to “Configuring the adapter.”

*Cabling the management (COM) port:* To cable the management (COM) port, connect a modem or null modem cable to the management port on the Remote Supervisor Adapter.

Continue with Configuring the adapter.

**Configuring the adapter:** This section describes how to enable remote access to the Remote Supervisor Adapter and install ASM device drivers.

These procedures assume that you have an operational keyboard and pointing device attached to the server.

*Enabling remote access to the adapter:* The Remote Supervisor Adapter requires configuration to enable remote access through either the Ethernet port or the management port. From Table 3 on page 56, select the interface method that you want to use to perform remote management; then, perform the indicated configuration procedure.

**Note:** For detailed information about using the ASM Web interface and the text-based user interface, see the *Remote Supervisor Adapter User's Guide* on the IBM xSeries Documentation CD.

Table 3. Configuration tasks to enable remote access to the Remote Supervisor Adapter

User interface to Remote Supervisor Adapter	Connection to Remote Supervisor Adapter	For the configuration procedure, see:
ASM Web interface using HTTP	LAN using the Ethernet port	"Configuring the Ethernet settings for Web-based remote access"
Text-based user interface using the Telnet protocol		
Text-based user interface using a modem or a null modem	Management (COM) port	"Configuring the management port for text-based remote access" on page 58 and "Setting up point-to-point protocol" on page 59
ASM Web interface using point-to-point protocol (PPP)		
Text-based user interface using the Telnet protocol over PPP		

*Configuring the Ethernet settings for Web-based remote access:* If you have an accessible, active, and configured dynamic host configuration protocol (DHCP) server on the network, the hostname, IP address, gateway address, subnet mask, and DNS server IP address are set automatically. You do not need to perform further configuration tasks to enable the Ethernet connection because the default value for the **DHCP Setting** field is **Enabled**. If you need to configure the management port, go to "Configuring the management port for text-based remote access" on page 58; otherwise, go to "Installing Advanced System Management device drivers" on page 61.

If you do not have a DHCP server on the network, complete the following steps to configure the Ethernet settings.

1. With the server turned off, insert the diskette with the downloaded utility program into the diskette drive; then, turn on the server. The utility starts automatically, displaying the Remote Supervisor Utility window.
2. Use the arrow keys to select **Configuration Settings**; then, press Enter. The Configuration Settings window opens.

- Use the arrow keys to select **Ethernet Settings**; then, press Enter. The Ethernet Settings window opens, as shown in the following illustration.

**Note:** The values in the window are only examples; your settings might be different.

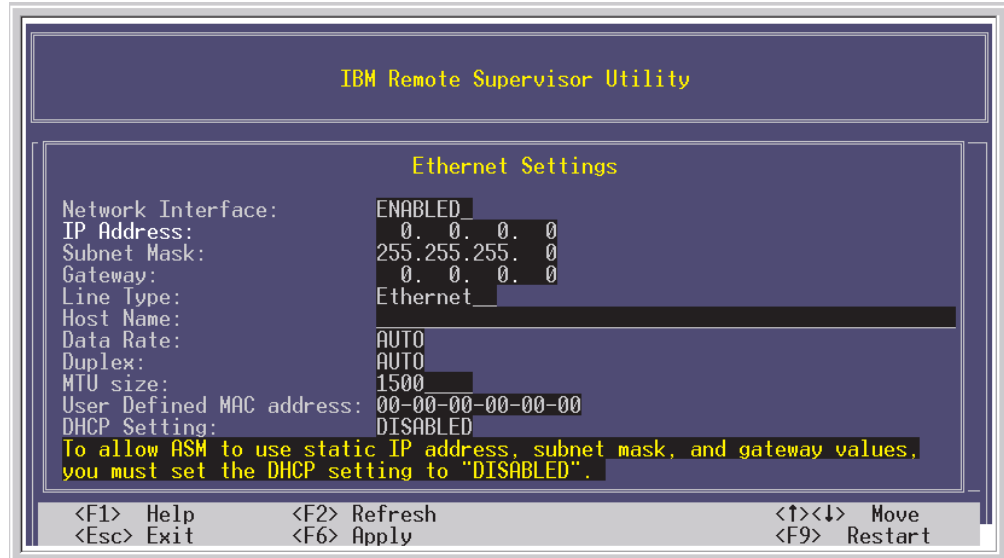

Figure 22. Ethernet Settings window with Web-based remote values

- Use the arrow keys to navigate to each field. Your system administrator can provide the information for the following fields:

#### Network Interface

The default value is **Enabled**; verify that it is still set to **Enabled**.

#### IP Address

Type the IP address of the Remote Supervisor Adapter.

#### Subnet Mask

Type the subnet mask used by the Remote Supervisor Adapter. The default value is 255.255.255.0.

#### Gateway

Type the IP address of the gateway.

#### Host Name

Type the host name of the Remote Supervisor Adapter. The default host name is ASMA<burned-in MAC address>.

For detailed information about the Ethernet settings, see the *Remote Supervisor Adapter User's Guide* on the IBM xSeries Documentation CD.

- Change the **DHCP Setting** field to **Disabled**. The default value is **Enabled**.
- Press F6 to apply the change.
- Press Esc. After the Warning window opens, press Enter to restart the Remote Supervisor Adapter.
- Press Esc to return to the Configuration Settings window. If you need to configure the management port, go to "Configuring the management port for text-based remote access" on page 58.
- Press Esc to return to the Utility program main window.

10. Use the arrow keys to select **Exit Utility** from the menu or press Esc to close the Utility program.
11. Remove the diskette from the server. The server restarts automatically.
12. If you also want to configure the management port, continue with “Configuring the management port for text-based remote access.” Otherwise, go to “Installing Advanced System Management device drivers” on page 61.

*Configuring the management port for text-based remote access:* Complete the following steps to configure the Remote Supervisor Adapter management port for access using a modem or null modem. If you completed the procedure for configuring the Ethernet port and the Configuration Settings window is open, start with step 3.

1. With the server turned off, insert the diskette with the downloaded utility program into the diskette drive; then, turn on the server. The utility starts automatically, displaying the Remote Supervisor Utility window.
2. Use the arrow keys to select **Configuration Settings**; then, press Enter. The Configuration Settings window opens.
3. Use the arrow keys to select **Modem Settings**; then, press Enter. The Modem Settings window opens, as shown in the following illustration.

**Note:** The values in the window are only examples; your settings might be different.

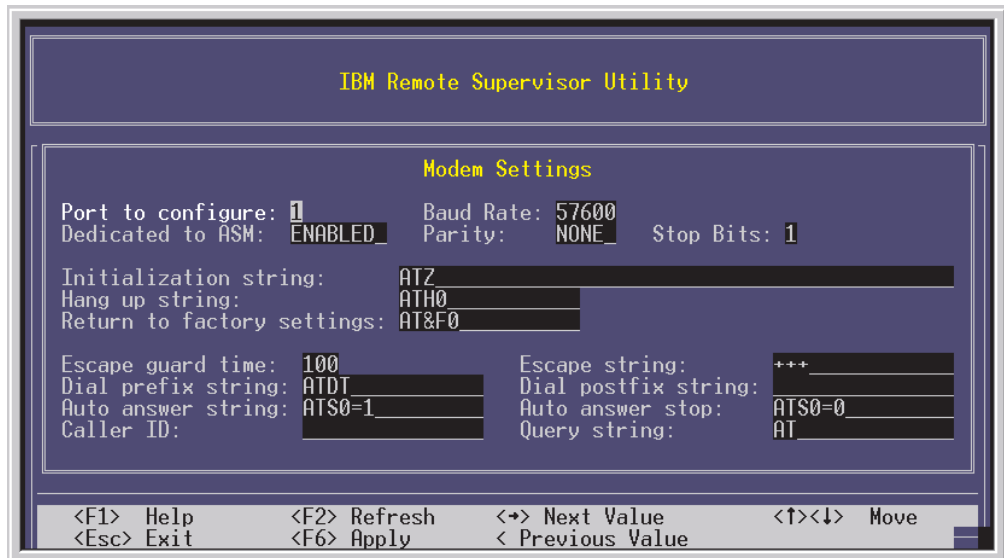

Figure 23. Ethernet Settings window with text-based remote access values

4. Verify the following management port values:

**Baud Rate**

The default is 57600. Make sure that the baud rate matches the baud rate of the device you are connecting to the management port on the Remote Supervisor Adapter.

**Dedicated to ASM**

The default is **Disabled**. If you are using point-to-point protocol (PPP), set this field to **Enabled**. If the value in this field is **Enabled** when the server is restarted, the management port remains dedicated to system management and is not returned to the operating system.

You can dedicate the integrated management port on the Remote Supervisor Adapter to system management or share it with the operating system. If the management port is dedicated to system management, it serves only the Remote Supervisor Adapter and is always available for dial-in or dial-out alerting purposes. You cannot view the port using the operating system or any application.

**Note:** To use this management port, you must first install the ASM device drivers as described in “Installing Advanced System Management device drivers” on page 61.

If the management port is shared with the operating system, it is dedicated to the Remote Supervisor Adapter only while the server is turned off or during POST. The port is returned to the operating system after POST completes. You can view the port using the operating system or any application. The Remote Supervisor Adapter takes over the port from the operating system only when information about a critical event is received. The Remote Supervisor Adapter dials out and transmits an alert and keeps the port dedicated until the server is restarted. The port is no longer available to the operating system or applications.

**Parity** The default is **None**.

**Stop Bits**

The default is **1**.

**Note:** The data bits value is preset to 8 and cannot be changed.

For detailed information about the management port and modem settings, see the *Remote Supervisor Adapter User's Guide* on the IBM xSeries Documentation CD.

5. If you made changes to the management port settings, press F6 to apply the change.
6. Press Esc to return to the Configuration Settings window. If you need to set up point-to-point protocol, go to “Setting up point-to-point protocol.”
7. Press Esc to return to the Utility program main window.
8. Use the arrow keys to select **Exit Utility** from the menu, or press Esc to close the Utility program.
9. Remove the diskette from the diskette drive. The Remote Supervisor Adapter restarts automatically.
10. Continue with “Setting up point-to-point protocol.”

*Setting up point-to-point protocol:* The Remote Supervisor Adapter management port supports point-to-point protocol (PPP). PPP enables TCP/IP communication over the management port, which enables Web-based management and Telnet sessions over a modem. To set up PPP, complete the following steps. If you completed the procedure for configuring the management port and the Configuration Settings window is open, go to step 3 on page 59.

1. With the server turned off, insert the downloaded utility program into the diskette drive; then, turn on the server. The utility starts automatically, displaying the Remote Supervisor Utility window.
2. Use the arrow keys to select **Configuration Settings**; then, press Enter. The Configuration Settings window opens.
3. Use the arrow keys to select **PPP Settings**; then, press Enter.

The PPP Settings window opens, as shown in the following illustration.

**Note:** The values in the window are only examples; your settings might be different.

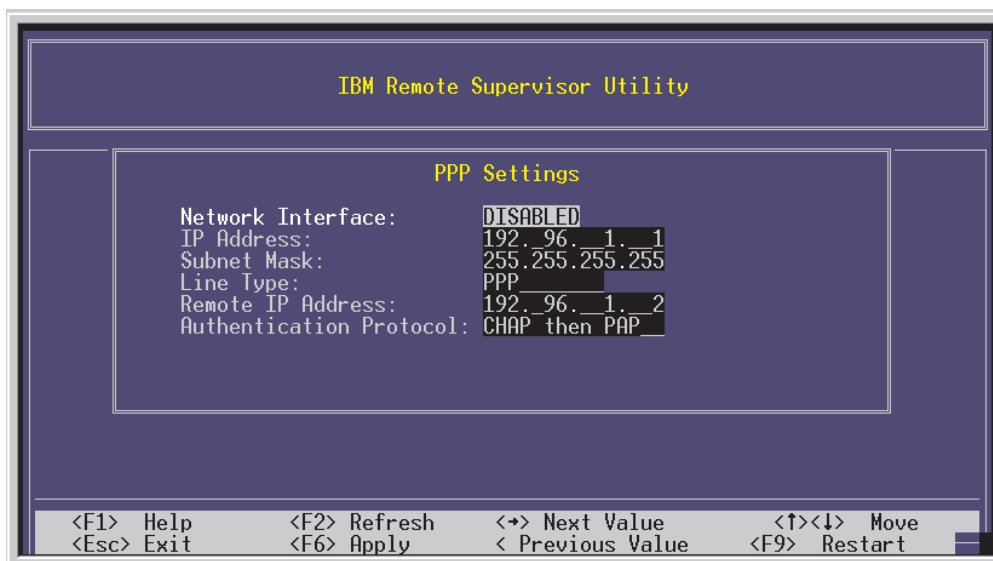

Figure 24. Ethernet Settings window setting up point-to-point protocol

4. Use the arrow keys to navigate to each field. Verify the values in the following fields:

#### Network Interface

The default is **Disabled**. Change this field to **Enabled**.

#### IP Address

The default value is 192.96.1.1. You can use the default value or another value, but the server must be able to establish a connection to that address. The default IP address (local and remote) is easily reconfigurable.

#### Subnet Mask

The default value is 255.255.255.255.

#### Line Type

The value is set to **PPP**.

#### Remote IP Address

The default value is 192.96.1.2.

#### Authentication Protocol

The default is **CHAP then PAP**. Make sure that the value in this field matches your client settings.

For detailed information about the PPP settings, see the information about configuring PPP access over a management port in the *Remote Supervisor Adapter User's Guide* on the IBM xSeries Documentation CD.

5. Press F6 to apply the changes.
6. Press Esc. After the Warning window opens, press Enter to restart the Remote Supervisor Adapter.



7. Press Esc to return to the Configuration Settings window. If you need to configure the management port, go to “Configuring the management port for text-based remote access” on page 58.
8. Press Esc to return to the Utility program main window.
9. Use the arrow keys to select **Exit Utility** from the menu or press Esc to close the Utility program.
10. Remove the diskette from the diskette drive. The server restarts automatically.
11. Continue with “Installing Advanced System Management device drivers.”

*Installing Advanced System Management device drivers:* You must install the ASM device drivers for the server. The device drivers enable communication between the Remote Supervisor Adapter and the server in which it is installed. You can obtain the most current device drivers from <http://www.ibm.com/pc/support>.

The following sections describe the procedure for installing the ASM device drivers for the server, depending on your operating system.

**Notes:**

1. If you are installing device drivers manually, note the following requirements:
  - Make sure that the operating system is installed on the server before you install the ASM device drivers. For information about installing the operating system, see the documentation that comes with the operating system.
  - Before installing the ASM device drivers for the Remote Supervisor Adapter, stop any system-management application.
2. If you are using ServerGuide to install device drivers and your operating system is Windows 2000 or Windows Server 2003, ServerGuide installs the ASM device drivers automatically.
  - For Windows 2000 or Windows Server 2003 installations, continue with “Installing Windows 2000 or Windows Server 2003 ASM device drivers”
  - For Windows NT installations, go to “Installing Windows NT ASM device drivers” on page 62.

After you install the ASM device drivers, go to “Configuring the remote control password” on page 63 to set the remote control password.

*Installing Windows 2000 or Windows Server 2003 ASM device drivers:* To install the ASM device drivers for Windows 2000 or Windows Server 2003, complete the following steps.

**Notes:**

1. Do not use the Hardware Wizard to install the drivers. If the Hardware Wizard starts itself for the installation of any System Management Driver hardware, exit the Hardware Wizard by selecting **Cancel**.
2. If IBM Netfinity® Director, IBM Director, or UM Services is running on the server, stop the system-management application before proceeding.

Complete the following steps to manually install the Windows 2000 or Windows Server 2003 ASM device drivers.

1. Open a command prompt.
2. If you are installing from a diskette, type: `a:\WIN2000\SETUP`, where *a* is the drive letter of the diskette drive.

3. If you are installing from a CD, type: `d:\DD\WIN2000\SETUP`, where *d* is the drive letter of the DVD-ROM drive.
4. Follow the directions that display on the screen.
5. Go to “Configuring the remote control password” on page 63.

*Installing Windows NT ASM device drivers:* Select one of the following methods to install the ASM device drivers for Windows NT:

- Non-interactive

The non-interactive method for installing the ASM device drivers accepts the default values for any window prompts that appear. You are prompted to respond only if an error occurs during installation.

- Interactive

The normal (interactive) method for installing the ASM device drivers prompts you with instructions and waits for you to respond before continuing with the installation.

**Note:** If IBM Netfinity Director, IBM Director, UM Services, or IBM Netfinity Manager is running on the server, stop the system-management application before proceeding.

*Using the non-interactive method:* Complete the following steps to use the non-interactive method.

1. Open a Windows NT command prompt; then, type one of the following commands:
  - If the installation is from a diskette, type:  
`a:\NT\SETUP -q`  
(where *a* is the drive letter assigned to the diskette drive).  
Press Enter.
  - If the installation is from a CD, type:  
`d:\DD\NT\SETUP -q`  
(where *d* is the drive letter assigned to the DVD-ROM drive).  
Press Enter.
2. Follow the instructions that appear in the window.
3. Go to “Configuring the remote control password” on page 63.

*Using the interactive method:* Complete the following steps to use the interactive method.

1. Open a Windows NT command prompt; then, type one of the following commands:
  - If the installation is from a diskette, type:  
`a:\NT\SETUP`  
(where *a* is the drive letter assigned to the diskette drive).  
Press Enter.
  - If the installation is from a CD, type:  
`d:\DD\NT\SETUP`  
(where *d* is the drive letter assigned to the DVD-ROM drive).  
Press Enter.
2. Follow the instructions that appear in the window.
3. Continue with “Configuring the remote control password” on page 63.

*Configuring the remote control password:* If you want to use the remote control features of the Remote Supervisor Adapter ASM Web interface, you must configure the remote control password using the Configuration/Setup Utility program that comes with the server. This program is part of the basic input/output system (BIOS) code.

To set up a remote control password, complete the following steps:

1. Start the server, and watch the monitor screen.
2. When the message Press F1 for Configuration/Setup is displayed, press F1. The Configuration/Setup Utility main menu window opens.
3. Use the arrow keys to select **System Security**; then, press Enter. The System Security window opens.
4. Select **Remote Control Security Settings**; then, press Enter. The Remote Control Security Settings window opens.
5. Enter the Remote Control Password that you will use each time you log in to the remote-control features of the Remote Supervisor Adapter ASM Web Interface.
6. Select **Save New Remote Control Password**; then, press Enter.
7. In the System Security window, press Esc.
8. Select **Save Settings**; then, press Enter.
9. Confirm your selection; then, exit the Configuration/Setup Utility program.
10. Continue with “Completing the configuration.”

*Completing the configuration:* To complete the configuration of the Remote Supervisor Adapter, see the *Remote Supervisor Adapter User’s Guide* on the IBM *xSeries Documentation CD*. Completing the configuration includes the following tasks:

- Defining the login IDs and passwords
- Selecting the events that will receive alert notification
- Monitoring remote server status using the ASM Web interface or a text-based user interface
- Controlling the server remotely

If you want to set up an ASM interconnect network and have not already done so, continue with “Using the ASM interconnect network.” If you do not want to set up an ASM interconnect network, Remote Supervisor Adapter configuration is now complete. To start managing the server remotely, see the *Remote Supervisor Adapter User’s Guide* on the IBM *xSeries Documentation CD*.

## Using the ASM interconnect network

This section explains how to configure and connect the server to function within an ASM interconnect network.

The ASM interconnect network can include as many as 12 individual ASM connections in a single bus. These connections can include Remote Supervisor Adapters, ASM processors, and ASM PCI Adapters. When the clients and servers are connected, they use the ASM interconnect network to share ASM resources, information, and alerts among multiple servers, without having to add additional communications hardware or network interface adapters.

An ASM interconnect network provides two levels of functionality. First, the ASM interconnect network enables you to configure settings and to control the servers

where other Remote Supervisor Adapters, ASM processors, and ASM PCI Adapters on the network reside. Second, the ASM interconnect network enables other interconnect network devices to use the resources (Ethernet or modem) of other Remote Supervisor Adapters, ASM processors, and ASM PCI Adapters in the ASM interconnect network for sending alerts. This interconnect network is used when Remote Supervisor Adapters, ASM processors, or ASM PCI Adapters cannot send an alert and must forward the information to another one of these devices to send the alert.

**Planning and cabling the interconnect network:** To support the most recent ASM features, a Remote Supervisor Adapter must be the main gateway interconnect to the ASM interconnect bus if the bus also includes servers with ASM PCI adapters or ASM processors. The Remote Supervisor Adapter forwards the ASM information generated by the servers attached to the ASM interconnect bus to other servers on the Ethernet network. The connected ASM processors and ASM PCI Adapters are managed through the new user interface and Web browser access of the Remote Supervisor Adapter.

**Note:** To ensure the stability of the system, you must have the most current level of firmware installed on the Remote Supervisor Adapter that is the main interconnect gateway for the ASM interconnect network. The most current level of firmware is available on the World Wide Web at <http://www.ibm.com/pc/support/>. For more information on updating firmware, see the *IBM Remote Supervisor Adapter User's Guide* on the *IBM xSeries Documentation CD*.

You must connect an ASM Interconnect module to the Remote Supervisor Adapter and to each xSeries 445 server that you connect to the ASM interconnect network bus.

**Attention:** To avoid damage to the Ethernet connector on the Remote Supervisor Adapter, do not connect the ASM Interconnect module to the Remote Supervisor Adapter Ethernet port.

To connect the servers, note the following setup and configuration considerations:

- Make sure that the ASM interconnect network is set up as a bus, not as a ring. You must connect the servers to the ASM interconnect network in a series, with terminated beginning and end points.
- Make sure that the total combined length of all Ethernet cables connecting the server in the ASM interconnect network does not exceed 91 M (300 ft).
- Each Remote Supervisor Adapter, ASM PCI adapter, or ASM processor that is connected to the ASM interconnect network bus counts as one connection. For example, if an ASM PCI adapter is installed in a server that has an ASM processor, the processor and the adapter connect to each other using one ASM interconnect connection, but the processor and the adapter count as two connections on the ASM interconnect network bus.

**Forwarding alerts:** Remote Supervisor Adapters, ASM PCI adapters, and ASM processors that are connected to an ASM interconnect network share resources and system-management information. This section provides information on how alerts are forwarded in the ASM interconnect network.

During normal operation, each Remote Supervisor Adapter, ASM processor, or ASM PCI adapter on the ASM interconnect network communicates with the other processors and adapters on the network. Processors or adapters that have a modem or Ethernet connection notify the other processors and adapters that these

communications resources are available for use by other servers on the ASM interconnect network. These resources are then used as ASM interconnect network resources, enabling Remote Supervisor Adapters, ASM processors, or ASM PCI adapters on the ASM interconnect network to send alerts using a modem or the network, even if they do not have a modem or network connection physically attached.

When alerts are generated, they are forwarded to the Remote Supervisor Adapter, ASM processor, or ASM PCI adapter on the ASM interconnect network that has the communication resources to forward the alert. If no system on the ASM interconnect network meets the requirements, the alert is set for transmission if the connection type is configured or becomes available later.

If multiple modems or network connections exist in the ASM interconnect network, you cannot specify which system will receive an alert or which will use its modem or network connection to forward the alert. If an alert is forwarded to a Remote Supervisor Adapter, ASM processor, or ASM PCI adapter that is unable to deliver the alert (for example, the modem it is configured to use has failed or the network cannot resolve the destination IP address), the processor or adapter attempts to forward the alert to another system on the ASM interconnect network that has the communication resources to forward the alert.

Alerts are typically sent only once (per connection type), but an alert is forwarded to another interconnect device if the resources exist on other interconnect devices in the network. For example, on a three ASM processor network where ASM processor 1 generates a modem alert, but does not have a modem and the other ASM processors have modems, the following might occur:

If ASM processor 1 generates an alert and the modem is unplugged from ASM processor 2 45 seconds prior to ASM processor 1 generating the alert, ASM processor 1 forwards the alert to ASM processor 2, having previously determined that ASM processor 2 has an available modem. When ASM processor 2 receives the forwarded alert, it determines that a modem is attached to ASM processor 3, and forwards the alert. Therefore, depending upon the time frame (45 seconds) within which a resource (modem) fails, the alert might be forwarded multiple times until an interconnect device can send the alert.

**Cabling for the ASM interconnect network:** Depending upon the servers you have, you might need additional ASM Interconnect modules or Category 5 or Category 3 Ethernet cables. The following table lists some IBM Netfinity and IBM xSeries products, and indicates whether you need to use an ASM Interconnect module to set up the ASM interconnect network.

Server name	ASM Interconnect module needed
Netfinity 4500R	yes
Netfinity 5000	yes
Netfinity 5500	yes
Netfinity 5500-M10	yes
Netfinity 5500-M20	yes
Netfinity 5600	yes
Netfinity 6000R	no
Netfinity 7100	no
Netfinity 7600	no

Server name	ASM Interconnect module needed
xSeries 220	yes
xSeries 232	yes
xSeries 240	yes
xSeries 330	The ASM interconnect module is required to link the Remote Supervisor Adapter to the microprocessor in the server. Use the RS-485 ports to create the ASM interconnect network.
xSeries 340	yes
xSeries 342	yes
xSeries 350	no
xSeries 360	yes
xSeries 440	yes
xSeries 445	yes (Not required for models that come with a Remote Supervisor II-EXA installed)

For the servers that do not need an ASM Interconnect module, a module is still needed to connect the Remote Supervisor Adapter in the gateway server to the integrated ASM processor. After you make that connection, you can connect the servers together using their ASM interconnect ports. For additional information, see “ASM interconnect network configuration examples” on page 68.

*Connecting the ASM Interconnect module to the xSeries 445:* The ASM Interconnect module connects the Remote Supervisor Adapter to the ASM interconnect network. This module must be purchased separately. To connect the ASM interconnect module to the Remote Supervisor Adapter, complete the following steps.

**Attention:** To avoid damage to the Ethernet connector, do not plug the ASM interconnect module into the Remote Supervisor Adapter Ethernet port.

1. Connect the ASM Interconnect module **1** to the Remote Supervisor Adapter ASM interconnect (peer-to-peer) port **2** as shown in the following illustration. This port is on the edge of the Remote Supervisor Adapter that is accessible from the rear of the server and is labeled RS485.

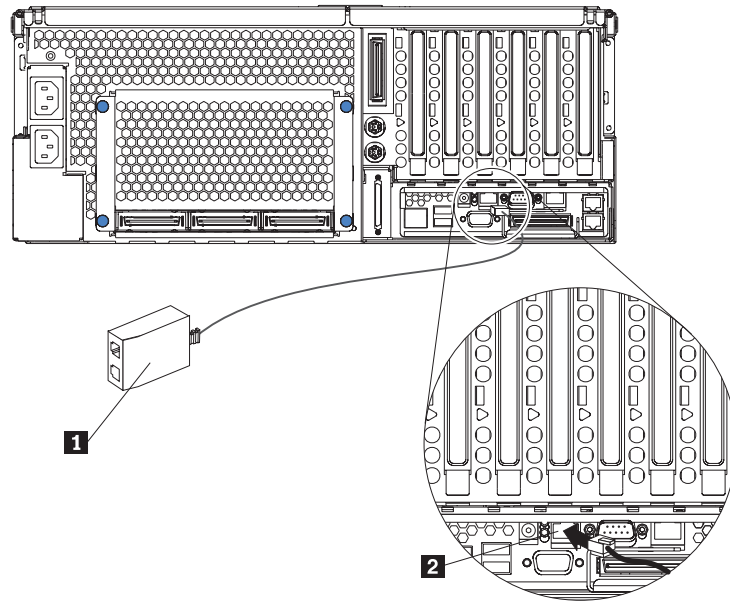
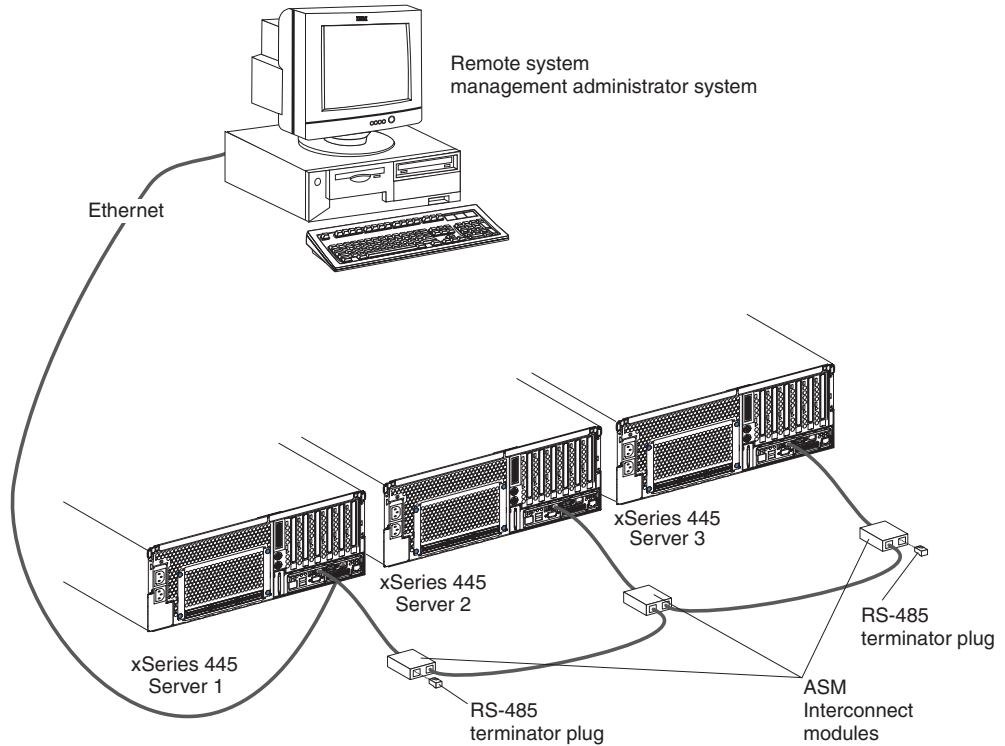

Figure 25. Connecting an ASM Interconnect module to an xSeries 445 server

2. Connect one or two Category 3 or Category 5 Ethernet cables to the other end of the ASM Interconnect module.
3. Continue with “ASM interconnect network configuration examples” on page 68.

**ASM interconnect network configuration examples:** The illustrations in this section show sample ASM interconnect network configurations.

The following illustration shows an Ethernet cable connecting the remote administrator system to the Remote Supervisor Adapter that is installed in an xSeries 445. Server 1 uses the LAN connection to forward system-management data generated by the other xSeries 445 server in the ASM interconnect network bus to the remote system-management administrator.



**Note:** The ASM Interconnect module is connected to the RS485 port on the back panel of the Remote Supervisor Adapter in each server.

Figure 26. ASM Interconnect network configuration



The following illustration shows a modem connected to the management port of the Remote Supervisor Adapter in the xSeries 445 server on the left, a modem connected to the management port of the Remote Supervisor Adapter in the xSeries 445 server on the right, and a modem connected to the remote administrator system. Placing modems at opposite ends of the ASM interconnect network bus ensures that if an ASM interconnect connection in the bus fails, all of the servers on the ASM interconnect network have access to a modem to forward system-management data to the remote system-management administrator.

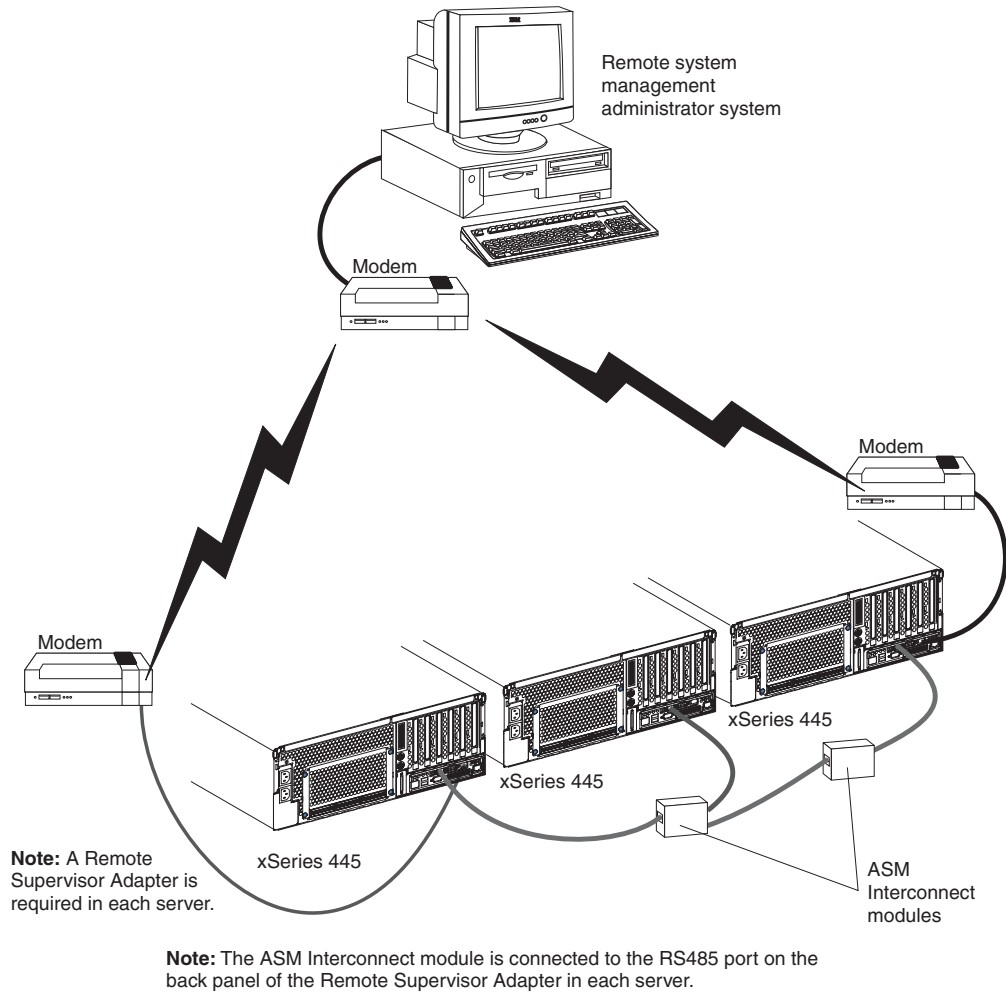

Figure 27. Connecting modems to the ASM Interconnect network

---

## Using the PXE boot agent utility program

Use the Preboot Execution Environment (PXE) boot agent utility program to enable or disable operating-system wake-up support.

**Note:** Your server does not support changing the network boot protocol or specifying the startup order of devices through the PXE boot agent utility program.

## Starting the PXE boot agent utility program

Complete the following steps to start the PXE boot agent utility program:

1. Turn on the server.
2. When the Initializing Intel (R) Boot Agent Version X.X.XX PXE 2.0 Build XXX (WfM 2.0) prompt appears, press Ctrl+S. You have 2 seconds (by default) to press Ctrl+S after the prompt appears.
3. Use the arrow keys and press Enter to select a choice from the menu.
4. Follow the instructions on the screen to change the settings of the selected items; then, press Enter.

## PXE boot agent utility menu choices

The following choices are on the PXE boot agent utility menu:

- **Network Boot Protocol**  
PXE is the default setting. Do not change this setting; your server does not support any other network boot protocols.
- **Boot Order**  
Your server does not support this choice. Use the **Start Options** choice in the Configuration/Setup Utility program to specify the startup order of devices.
- **Show setup prompt**  
Select this choice to enable or disable the PXE setup prompt. **Disable** is the default setting. When the prompt is enabled, the prompt Press Ctrl+S to enter the setup menu appears under the initializing prompt.
- **Setup time wait menu**  
Select this choice to specify the amount of time (in seconds) that the system will wait for you press Ctrl+S after the prompt appears. You can select 2 (default), 3, 5, or 8 seconds.
- **Legacy OS wake up support**  
Select this choice to enable or disable the legacy operating-system wake-up support. **Disabled** is the default setting.  
If you are using an Advanced Configuration and Power Interface (ACPI) aware operating system, such as Microsoft Windows 2000, Windows Server 2003, or Windows NT, disable this choice to use Wake on LAN support. Otherwise, enable it.  
If you are using a non-ACPI-aware operating system, do not send wake-up packets to the server while it is turned on. If you send a wake-up packet to the server while it is turned on and you are then unable to turn off the server, see “Power problems” in the “Error symptoms” section in the *Hardware Maintenance Manual and Troubleshooting Guide* on the IBM xSeries Documentation CD.

---

## Appendix A. Getting help and technical assistance

If you need help, service, or technical assistance or just want more information about IBM products, you will find a wide variety of sources available from IBM to assist you. This appendix contains information about where to go for additional information about IBM and IBM products, what to do if you experience a problem with your xSeries or IntelliStation® system, and whom to call for service, if it is necessary.

---

### Before you call

Before you call, make sure that you have taken these steps to try to solve the problem yourself:

- Check all cables to make sure that they are connected.
- Check the power switches to make sure that the system is turned on.
- Use the troubleshooting information in your system documentation, and use the diagnostic tools that come with your system.
- Go to the IBM Support Web site at <http://www.ibm.com/pc/support/> to check for technical information, hints, tips, and new device drivers.
- Use an IBM discussion forum on the IBM Web site to ask questions.

You can solve many problems without outside assistance by following the troubleshooting procedures that IBM provides in the online help or in the publications that are provided with your system and software. The information that comes with your system also describes the diagnostic tests that you can perform. Most xSeries and IntelliStation systems, operating systems, and programs come with information that contains troubleshooting procedures and explanations of error messages and error codes. If you suspect a software problem, see the information for the operating system or program.

---

### Using the documentation

Information about your IBM xSeries or IntelliStation system and preinstalled software, if any, is available in the documentation that comes with your system. That documentation includes printed books, online books, readme files, and help files. See the troubleshooting information in your system documentation for instructions for using the diagnostic programs. The troubleshooting information or the diagnostic programs might tell you that you need additional or updated device drivers or other software. IBM maintains pages on the World Wide Web where you can get the latest technical information and download device drivers and updates. To access these pages, go to <http://www.ibm.com/pc/support/> and follow the instructions. Also, you can order publications through the IBM Publications Ordering System at <http://www.elink.ibm.com/public/applications/publications/cgibin/pbi.cgi>.

---

## Getting help and information from the World Wide Web

On the World Wide Web, the IBM Web site has up-to-date information about IBM xSeries and IntelliStation products, services, and support. The address for IBM xSeries information is <http://www.ibm.com/eserver/xseries/>. The address for IBM IntelliStation information is <http://www.ibm.com/pc/intellistation/>.

You can find service information for your IBM products, including supported options, at <http://www.ibm.com/pc/support/>.

---

## Software service and support

Through IBM Support Line, you can get telephone assistance, for a fee, with usage, configuration, and software problems with xSeries servers, IntelliStation workstations, and appliances. For information about which products are supported by Support Line in your country or region, go to <http://www.ibm.com/services/sl/products/>.

For more information about Support Line and other IBM services, go to <http://www.ibm.com/services/>, or go to <http://www.ibm.com/planetwide/> for support telephone numbers. In the U.S. and Canada, call 1-800-IBM-SERV (1-800-426-7378).

---

## Hardware service and support

You can receive hardware service through IBM Integrated Technology Services or through your IBM reseller, if your reseller is authorized by IBM to provide warranty service. Go to <http://www.ibm.com/planetwide/> for support telephone numbers, or in the U.S. and Canada, call 1-800-IBM-SERV (1-800-426-7378).

In the U.S. and Canada, hardware service and support is available 24 hours a day, 7 days a week. In the U.K., these services are available Monday through Friday, from 9 a.m. to 6 p.m.

---

## Appendix B. Notices

This information was developed for products and services offered in the U.S.A.

IBM may not offer the products, services, or features discussed in this document in other countries. Consult your local IBM representative for information on the products and services currently available in your area. Any reference to an IBM product, program, or service is not intended to state or imply that only that IBM product, program, or service may be used. Any functionally equivalent product, program, or service that does not infringe any IBM intellectual property right may be used instead. However, it is the user's responsibility to evaluate and verify the operation of any non-IBM product, program, or service.

IBM may have patents or pending patent applications covering subject matter described in this document. The furnishing of this document does not give you any license to these patents. You can send license inquiries, in writing, to:

*IBM Director of Licensing  
IBM Corporation  
North Castle Drive  
Armonk, NY 10504-1785  
U.S.A.*

INTERNATIONAL BUSINESS MACHINES CORPORATION PROVIDES THIS PUBLICATION "AS IS" WITHOUT WARRANTY OF ANY KIND, EITHER EXPRESS OR IMPLIED, INCLUDING, BUT NOT LIMITED TO, THE IMPLIED WARRANTIES OF NON-INFRINGEMENT, MERCHANTABILITY OR FITNESS FOR A PARTICULAR PURPOSE. Some states do not allow disclaimer of express or implied warranties in certain transactions, therefore, this statement may not apply to you.

This information could include technical inaccuracies or typographical errors. Changes are periodically made to the information herein; these changes will be incorporated in new editions of the publication. IBM may make improvements and/or changes in the product(s) and/or the program(s) described in this publication at any time without notice.

Any references in this information to non-IBM Web sites are provided for convenience only and do not in any manner serve as an endorsement of those Web sites. The materials at those Web sites are not part of the materials for this IBM product, and use of those Web sites is at your own risk.

IBM may use or distribute any of the information you supply in any way it believes appropriate without incurring any obligation to you.

---

### Edition notice

**© Copyright International Business Machines Corporation 2004. All rights reserved.**

U.S. Government Users Restricted Rights — Use, duplication, or disclosure restricted by GSA ADP Schedule Contract with IBM Corp.

---

## Trademarks

The following terms are trademarks of International Business Machines Corporation in the United States, other countries, or both:

Active Memory	Predictive Failure Analysis
Active PCI	PS/2
Active PCI-X	ServeRAID
Alert on LAN	ServerGuide
BladeCenter	ServerProven
C2T Interconnect	TechConnect
Chipkill	ThinkPad
EtherJet	Tivoli
e-business logo	Tivoli Enterprise
@server	Update Connector
FlashCopy	Wake on LAN
IBM	XA-32
IBM (logo)	XA-64
IntelliStation	X-Architecture
NetBAY	Xcel4
Netfinity	XpandOnDemand
NetView	xSeries
OS/2 WARP	

Intel, MMX, and Pentium are trademarks of Intel Corporation in the United States, other countries, or both.

Microsoft, Windows, and Windows NT are trademarks of Microsoft Corporation in the United States, other countries, or both.

Java and all Java-based trademarks and logos are trademarks or registered trademarks of Sun Microsystems, Inc. in the United States, other countries, or both.

Other company, product, or service names may be trademarks or service marks of others.

---

## Important notes

Processor speeds indicate the internal clock speed of the microprocessor; other factors also affect application performance.

CD-ROM drive speeds list the variable read rate. Actual speeds vary and are often less than the maximum possible.

When referring to processor storage, real and virtual storage, or channel volume, KB stands for approximately 1000 bytes, MB stands for approximately 1 000 000 bytes, and GB stands for approximately 1 000 000 000 bytes.

When referring to hard disk drive capacity or communications volume, MB stands for 1 000 000 bytes, and GB stands for 1 000 000 000 bytes. Total user-accessible capacity may vary depending on operating environments.

Maximum internal hard disk drive capacities assume the replacement of any standard hard disk drives and population of all hard disk drive bays with the largest currently supported drives available from IBM.

Maximum memory may require replacement of the standard memory with an optional memory module.

IBM makes no representation or warranties regarding non-IBM products and services that are ServerProven<sup>®</sup>, including but not limited to the implied warranties of merchantability and fitness for a particular purpose. These products are offered and warranted solely by third parties.

IBM makes no representations or warranties with respect to non-IBM products. Support (if any) for the non-IBM products is provided by the third party, not IBM.

Some software may differ from its retail version (if available), and may not include user manuals or all program functionality.

---

## Product recycling and disposal

This unit contains materials such as circuit boards, cables, electromagnetic compatibility gaskets, and connectors which may contain lead and copper/beryllium alloys that require special handling and disposal at end of life. Before this unit is disposed of, these materials must be removed and recycled or discarded according to applicable regulations. IBM offers product-return programs in several countries. Information on product recycling offerings can be found on IBM's Internet site at <http://www.ibm.com/ibm/environment/products/prp.shtml>.

---

## Battery return program

This product may contain a sealed lead acid, nickel cadmium, nickel metal hydride, lithium, or lithium ion battery. Consult your user manual or service manual for specific battery information. The battery must be recycled or disposed of properly. Recycling facilities may not be available in your area. For information on disposal of batteries outside the United States, go to <http://www.ibm.com/ibm/environment/products/batteryrecycle.shtml> or contact your local waste disposal facility.

In the United States, IBM has established a collection process for reuse, recycling, or proper disposal of used IBM sealed lead acid, nickel cadmium, nickel metal hydride, and battery packs from IBM equipment. For information on proper disposal of these batteries, contact IBM at 1-800-426-4333. Have the IBM part number listed on the battery available prior to your call.

In the Netherlands, the following applies.



---

## Electronic emission notices

### Federal Communications Commission (FCC) statement

**Note:** This equipment has been tested and found to comply with the limits for a Class A digital device, pursuant to Part 15 of the FCC Rules. These limits are designed to provide reasonable protection against harmful interference when the equipment is operated in a commercial environment. This equipment generates, uses, and can radiate radio frequency energy and, if not installed and used in accordance with the instruction manual, may cause harmful interference to radio communications. Operation of this equipment in a residential area is likely to cause harmful interference, in which case the user will be required to correct the interference at his own expense.

Properly shielded and grounded cables and connectors must be used in order to meet FCC emission limits. Properly shielded and grounded cables and connectors must be used in order to meet FCC emission limits. IBM is not responsible for any radio or television interference caused by using other than recommended cables and connectors or by using other than recommended cables and connectors or by unauthorized changes or modifications to this equipment. Unauthorized changes or modifications could void the user's authority to operate the equipment.

This device complies with Part 15 of the FCC Rules. Operation is subject to the following two conditions: (1) this device may not cause harmful interference, and (2) this device must accept any interference received, including interference that may cause undesired operation.



## Industry Canada Class A emission compliance statement

This Class A digital apparatus complies with Canadian ICES-003.

### Avis de conformité à la réglementation d'Industrie Canada

Cet appareil numérique de la classe A est conforme à la norme NMB-003 du Canada.

## Australia and New Zealand Class A statement

**Attention:** This is a Class A product. In a domestic environment this product may cause radio interference in which case the user may be required to take adequate measures.

## United Kingdom telecommunications safety requirement

### Notice to Customers

This apparatus is approved under approval number NS/G/1234/J/100003 for indirect connection to public telecommunication systems in the United Kingdom.

## European Union EMC Directive conformance statement

This product is in conformity with the protection requirements of EU Council Directive 89/336/EEC on the approximation of the laws of the Member States relating to electromagnetic compatibility. IBM cannot accept responsibility for any failure to satisfy the protection requirements resulting from a nonrecommended modification of the product, including the fitting of non-IBM option cards.

This product has been tested and found to comply with the limits for Class A Information Technology Equipment according to CISPR 22/European Standard EN 55022. The limits for Class A equipment were derived for commercial and industrial environments to provide reasonable protection against interference with licensed communication equipment.

**Attention:** This is a Class A product. In a domestic environment this product may cause radio interference in which case the user may be required to take adequate measures.

## Taiwanese Class A warning statement

警告使用者：  
這是甲類的資訊產品，在  
居住的環境中使用時，可  
能會造成射頻干擾，在這種  
情況下，使用者會被要求  
採取某些適當的對策。

## Chinese Class A warning statement

**声 明**  
此为 A 级产品。在生活环境中，  
该产品可能会造成无线电干扰。  
在这种情况下，可能需要用户对其  
干扰采取切实可行的措施。

## Japanese Voluntary Control Council for Interference (VCCI) statement

この装置は、情報処理装置等電波障害自主規制協議会（VCCI）の基準に基づきクラスA情報技術装置です。この装置を家庭環境で使用すると電波妨害を引き起こすことがあります。この場合には使用者が適切な対策を講ずるよう要求されることがあります。

---

## Power cords

For your safety, IBM provides a power cord with a grounded attachment plug to use with this IBM product. To avoid electrical shock, always use the power cord and plug with a properly grounded outlet.

IBM power cords used in the United States and Canada are listed by Underwriter's Laboratories (UL) and certified by the Canadian Standards Association (CSA).

For units intended to be operated at 115 volts: Use a UL-listed and CSA-certified cord set consisting of a minimum 18 AWG, Type SVT or SJT, three-conductor cord, a maximum of 15 feet in length and a parallel blade, grounding-type attachment plug rated 15 amperes, 125 volts.

For units intended to be operated at 230 volts (U.S. use): Use a UL-listed and CSA-certified cord set consisting of a minimum 18 AWG, Type SVT or SJT, three-conductor cord, a maximum of 15 feet in length and a tandem blade, grounding-type attachment plug rated 15 amperes, 250 volts.

For units intended to be operated at 230 volts (outside the U.S.): Use a cord set with a grounding-type attachment plug. The cord set should have the appropriate safety approvals for the country in which the equipment will be installed.

IBM power cords for a specific country or region are usually available only in that country or region.

<b>IBM power cord part number</b>	<b>Used in these countries and regions</b>
02K0546	China
13F9940	Australia, Fiji, Kiribati, Nauru, New Zealand, Papua New Guinea
13F9979	Afghanistan, Albania, Algeria, Andorra, Angola, Armenia, Austria, Azerbaijan, Belarus, Belgium, Benin, Bosnia and Herzegovina, Bulgaria, Burkina Faso, Burundi, Cambodia, Cameroon, Cape Verde, Central African Republic, Chad, Comoros, Congo (Democratic Republic of), Congo (Republic of), Cote D'Ivoire (Ivory Coast), Croatia (Republic of), Czech Republic, Dahomey, Djibouti, Egypt, Equatorial Guinea, Eritrea, Estonia, Ethiopia, Finland, France, French Guyana, French Polynesia, Germany, Greece, Guadeloupe, Guinea, Guinea Bissau, Hungary, Iceland, Indonesia, Iran, Kazakhstan, Kyrgyzstan, Laos (People's Democratic Republic of), Latvia, Lebanon, Lithuania, Luxembourg, Macedonia (former Yugoslav Republic of), Madagascar, Mali, Martinique, Mauritania, Mauritius, Mayotte, Moldova (Republic of), Monaco, Mongolia, Morocco, Mozambique, Netherlands, New Caledonia, Niger, Norway, Poland, Portugal, Reunion, Romania, Russian Federation, Rwanda, Sao Tome and Principe, Saudi Arabia, Senegal, Serbia, Slovakia, Slovenia (Republic of), Somalia, Spain, Suriname, Sweden, Syrian Arab Republic, Tajikistan, Tahiti, Togo, Tunisia, Turkey, Turkmenistan, Ukraine, Upper Volta, Uzbekistan, Vanuatu, Vietnam, Wallis and Futuna, Yugoslavia (Federal Republic of), Zaire
13F9997	Denmark
14F0015	Bangladesh, Lesotho, Maceo, Maldives, Namibia, Nepal, Pakistan, Samoa, South Africa, Sri Lanka, Swaziland, Uganda
14F0033	Abu Dhabi, Bahrain, Botswana, Brunei Darussalam, Channel Islands, China (Hong Kong S.A.R.), Cyprus, Dominica, Gambia, Ghana, Grenada, Iraq, Ireland, Jordan, Kenya, Kuwait, Liberia, Malawi, Malaysia, Malta, Myanmar (Burma), Nigeria, Oman, Polynesia, Qatar, Saint Kitts and Nevis, Saint Lucia, Saint Vincent and the Grenadines, Seychelles, Sierra Leone, Singapore, Sudan, Tanzania (United Republic of), Trinidad and Tobago, United Arab Emirates (Dubai), United Kingdom, Yemen, Zambia, Zimbabwe
14F0051	Liechtenstein, Switzerland
14F0069	Chile, Italy, Libyan Arab Jamahiriya
14F0087	Israel
1838574	Antigua and Barbuda, Aruba, Bahamas, Barbados, Belize, Bermuda, Bolivia, Brazil, Caicos Islands, Canada, Cayman Islands, Costa Rica, Colombia, Cuba, Dominican Republic, Ecuador, El Salvador, Guam, Guatemala, Haiti, Honduras, Jamaica, Japan, Mexico, Micronesia (Federal States of), Netherlands Antilles, Nicaragua, Panama, Peru, Philippines, Taiwan, United States of America, Venezuela
24P6858	Korea (Democratic People's Republic of), Korea (Republic of)
34G0232	Japan
36L8880	Argentina, Paraguay, Uruguay
49P2078	India
49P2110	Brazil

<b>IBM power cord part number</b>	<b>Used in these countries and regions</b>
6952300	Antigua and Barbuda, Aruba, Bahamas, Barbados, Belize, Bermuda, Bolivia, Caicos Islands, Canada, Cayman Islands, Colombia, Costa Rica, Cuba, Dominican Republic, Ecuador, El Salvador, Guam, Guatemala, Haiti, Honduras, Jamaica, Mexico, Micronesia (Federal States of), Netherlands Antilles, Nicaragua, Panama, Peru, Philippines, Saudi Arabia, Thailand, Taiwan, United States of America, Venezuela

---

# Index

## A

- acoustical noise emissions 3
- Active Memory 4, 7
- administrator password 25
- alerts, forwarding 48, 64
- ASM interconnect network 63
  - cabling 65
  - compatible servers 65
  - configuration examples 50, 68
  - forwarding alerts 48
  - module, installing in the xSeries 445 66
  - overview 47
  - planning and cabling 47, 64
- attention notices 2
- availability 6

## B

- battery, return program 76
- browser, Web requirements 41

## C

- cabling
  - ASM interconnect network 47, 64
  - Ethernet LAN port 54
  - management (COM) port 55
- cache 4
- calling for service 71
- caution statements 2
- Class A electronic emission notice 76
- configuration
  - completing Remote Supervisor Adapter 63
    - with ServerGuide 28
- Configuration/Setup Utility 18
  - menu choices 18
  - program 17
- configuring
  - Ethernet controller 30
  - remote control password 63
  - scalable partitions 17, 22
- connectors 11
- controls, server 9
- cooling 5

## D

- danger statements 2
- device drivers 7
- device drivers, ASM
  - installing Windows 2000 61
  - installing Windows NT 62
- DIMMs
  - specifications 3
  - supported 3
- diskette drive
  - specifications 3

- documentation
  - online 2
  - related 1
- DOS configuration utility 55
- drives 5
- DVD-ROM
  - drive specification 3

## E

- electrical input 3
- electronic emission Class A notice 76
- Enterprise X-Architecture technology 4
- environment
  - specifications 3
- Ethernet 4, 5
  - configuring settings 56
  - controller configuration 17
  - LAN port, cabling 54
- expansion slots
  - number of 3

## F

- fans 5
- FCC Class A notice 76
- features
  - RAS 6
  - server 4
  - ServerGuide 27
- forwarding alerts 48

## G

- getting help and technical assistance 71

## H

- hardware service and support 72
- heat output 3
- help, getting 71

## I

- IBM Director 4, 8
- important notices 2
- information, safety v
- integrated functions 3
- integrated system management processor firmware,
  - updating 17, 30
- ISMP firmware, updating 30

## L

- LEDs
  - front view 9
  - rear view 11

- light path diagnostics 5
- LOC (location) LED 10
- local area network (LAN) 4
- LSI
  - Logic Configuration Utility program 17

## M

- management port, cabling 55
- memory 4, 7
  - mirroring 7
  - scrubbing 7
  - specifications 3
- Memory ProteXion 4, 7
- microprocessor 5
  - specifications 3
- mirroring, memory 7
- mouse connector 11

## N

- notes 2
- notes, important 75
- notices
  - and statements 2
  - electronic emission 76
  - FCC, Class A 76
  - safety v

## O

- online publications 2
- operating system installation
  - with ServerGuide 28
  - without ServerGuide 29

## P

- passwords 25
- planning an ASM interconnect network 47
- point-to-point protocol, setting up 59
- power
  - supply specifications 3
- power cords 78
- power-control button 10
- power-control-button shield 10
- power-on password 25
- Preboot Execution Environment boot agent utility
  - program 18
- product recycling 75
- publications 1

## R

- RAS features 6
- recycling, product 75
- related documentation 1
- reliability 6
- remote access
  - enabling 55

- remote console redirection 24
- remote control password, configuring 63
- Remote Supervisor Adapter 5
  - cabling 53, 54
  - completing configuration 63
  - configuration 17
  - configuring 52, 53, 55
  - enabling remote access 55
  - features 52
  - identifying 39
  - remote control password 63
  - setup requirements 52
  - software 61
- Remote Supervisor Adapter II-EXA 5
  - breakout cable 12, 42, 44
  - cabling 41, 43
  - configuration 17
  - configuring 40, 41
  - connectors and LEDs 12
  - features 40
  - firmware 44
  - identifying 39
  - rear view 11
  - setup requirements 40
  - software 44
- reset button 10
- RS-485 terminator plugs, using 48
- RSA II-EXA breakout cable 42

## S

- safety
  - notices v
- scalability 5
- scalable partition
  - create 22
  - delete 24
- scalable partition considerations 22
- scrubbing, memory 7
- server controls 9
- ServeRAID 5
  - manager
    - Configuration wizard 32
    - Manager 17
    - manager, online help 37
- ServerGuide
  - CD 4
  - features 27
  - operating system installation 28
  - setup and installation CD 17
  - using 27
- service, hardware 72
- serviceability 6
- setup
  - with ServerGuide 28
- SMP 5
- software service and support 72
- specifications, and features 3
- Standby mode 14
- starting
  - Configuration/Setup Utility program 18

starting (*continued*)  
  server 14  
statements and notices 2  
symmetric multiprocessing 5  
systems management 5, 8

## **T**

technical assistance, getting 71  
telnet 59  
temperature  
  air 3  
terminator plugs, using 48  
trademarks 74  
turning off the server 15  
turning on the server 14

## **U**

United States electronic emission Class A notice 76  
United States FCC Class A notice 76  
UpdateXpress 7  
using the Configuration/Setup Utility program 18  
utility  
  Configuration/Setup 18

## **V**

video controller  
  specifications 3

## **W**

Web browser requirements 41  
Web site  
  ServerGuide 27  
Windows 2000 ASM device drivers, installing 61  
Windows NT ASM device drivers, installing 62

## **X**

X-Architecture technology 4  
Xcel4 Server Accelerator Cache 4









Part Number: 02R2784

Printed in USA

(1P) P/N: 02R2784



## Free Manuals Download Website

<http://myh66.com>

<http://usermanuals.us>

<http://www.somanuals.com>

<http://www.4manuals.cc>

<http://www.manual-lib.com>

<http://www.404manual.com>

<http://www.luxmanual.com>

<http://aubethermostatmanual.com>

Golf course search by state

<http://golfingnear.com>

Email search by domain

<http://emailbydomain.com>

Auto manuals search

<http://auto.somanuals.com>

TV manuals search

<http://tv.somanuals.com>