

## **Mainboard User' s Manual**

This publication, including all photographs, illustrations and software, is protected under international copyright laws, with all rights reserved. Neither this manual, nor any of the material contained herein, may be reproduced without the express written consent of the manufacturer.

The information in this document is subject to change without notice. The manufacturer makes no representations or warranties with respect to the contents hereof and specifically disclaims any implied warranties of merchantability or fitness for any particular purpose. Further, the manufacturer reserves the right to revise this publication and to make changes from time to time in the content hereof without obligation of the manufacturer to notify any person of such revision or changes.

### **Trademarks**

IBM, VGA, and PS/2 are registered trademarks of International Business Machines.

Intel, Pentium, Pentium-II, Pentium-III, MMX, and Celeron are registered trademarks of Intel Corporation.

Microsoft, MS-DOS and Windows 95/98/NT are registered trademarks of Microsoft Corporation.

Sound Blaster is a trademark of Creative Technology Ltd.

PC-cillin and ChipAwayVirus are trademarks of Trend Micro Inc.

AMI is a trademark of American Megatrends Inc.

A3D is a registered trademark of Aureal Inc.

Gamut is a registered trademark of Formosoft International Inc.

SuperVoice is a registered trademark of Pacific Image Communications Inc.

MediaRing Talk is a registered trademark of MediaRing Inc.

Other names used in this publication may be trademarks and are acknowledged.

**Copyright ©2000  
All Rights Reserved  
MS7308D/E, V1.6  
S63X/JUNE 2000**

## **MS7308D/E Mainboard User' s Manual**

### **Federal Communications Commission (FCC)**

This equipment has been tested and found to comply with the limits for a Class B digital device, pursuant to Part 15 of the FCC Rules. These limits are designed to provide reasonable protection against harmful interference in a residential installation. This equipment generates, uses, and can radiate radio frequency energy and, if not installed and used in accordance with the instructions, may cause harmful interference to radio communications. However there is no guarantee that interference will not occur in a particular installation. If this equipment does cause harmful interference to radio or television reception, which can be determined by turning the equipment off and on, the user is encouraged to try to correct the interference by one or more of the following measures:

- Reorient or relocate the receiving antenna.
- Increase the separation between the equipment and the receiver.
- Connect the equipment onto an outlet on a circuit different from that to which the receiver is connected.
- Consult the dealer or an experienced radio/TV technician for help.

Shielded interconnect cables and shielded AC power cable must be employed with this equipment to insure compliance with the pertinent RF emission limits governing this device. Changes or modifications not expressly approved by the system' s manufacturer could void the user' s authority to operate the equipment.

### **Declaration of Conformity**

This device complies with part 15 of the FCC rules. Operation is subject to the following conditions:

- This device may not cause harmful interference, and
- This device must accept any interference received, including interference that may cause undesired operation.

### **Canadian Department of Communications**

This class B digital apparatus meets all requirements of the Canadian Interference-causing Equipment Regulations.

Cet appareil numérique de la classe B respecte toutes les exigences du Règlement sur le matériel brouilleur du Canada.

## MS7308E Mainboard User' s Manual

### Table of Contents

Chapter 1: Introduction .....	1
Key Features.....	2
Package Contents .....	5
Static Electricity Precautions .....	6
Pre-Installation Inspection.....	6
Chapter 2: Mainboard Installation .....	7
Mainboard Components.....	8
Install A CPU .....	9
Install Memory.....	10
Setting Jumper Switches .....	11
Install the Mainboard.....	13
Optional Extension Brackets.....	14
Install Other Devices.....	15
Expansion Slots.....	17
Chapter 3: BIOS Setup Utility .....	19
Introduction .....	19
Running the Setup Utility.....	20
Standard CMOS Setup Page .....	21
Advanced Setup Page .....	22
Power Management Setup Page .....	24
PCI / Plug and Play Setup Page.....	26
Load Optimal Settings .....	27
Load Best Performance Settings .....	27
Features Setup Page .....	28
CPU PnP Setup Page.....	30
Hardware Monitor Page.....	31
Change Password.....	31
Exit.....	32
Chapter 4: Software & Applications .....	33
About the Software .....	33
Folders for this Mainboard.....	33
Running the Support CD-ROM.....	34
Utility Folder Installation Notes .....	34
Mainboard (MS7308D/E) Installation Notes .....	35

**MS7308D/E Mainboard User' s Manual**

---

<b>Appendix A: Gamut</b> .....	A1
Introduction .....	A2
Before Installing .....	A3
Installation .....	A4
Produce MP3 file—Use CD-Cashier .....	A5
Play MP3 file—Use Musician .....	A7
Play music CD—Use 3D <sub>FS</sub> -ACD .....	A8
Play MIDI file—Use Midier .....	A9
Recording audio data—Use Voice-Catcher .....	A10

## Chapter 1

### Introduction

---

This mainboard has a **Socket 370**, which uses either an **Intel PPGA (Plastic Pin Grid Array) Celeron** or **FCPGA Pentium III** processor.

This mainboard supports front-side bus speeds of **66MHz**, **100MHz** or **133MHz**.

This mainboard uses the SiS 630 chipset which provides **CPU Plug & Play** through firmware, integrates a **128-bit AGP Graphics Accelerator** and has an embedded **10BaseT/100BaseTX Network Interface**. The mainboard has a built-in **PCI 3D Sound System**. There is an AMR slot for the AMR device cards. In addition, the mainboard has a full set of **ATX I/O Ports** including PS/2 keyboard and mouse ports, two USB ports, a parallel port, a serial port and a VGA port. And three extra USB ports can be added using the Extended USB Module that connects to the mainboard.

This mainboard has all the features you need to develop a powerful multimedia workstation that is network ready, and has built-in communications. The board is **Micro-ATX size** and has power connector for an **ATX** power supply.

## MS7308D/E Mainboard User' s Manual

### Key Features

The key features of this mainboard include:

#### Socket-370 Processor Support

- ◆ Supports **PPGA Celerons** from 300MHz to 600MHz.
- ◆ **FCPGA Pentium III** CPUs are supported
- ◆ Supports 66MHz, 100MHz or 133MHz FSB

All processors are automatically configured using firmware and a synchronous/asynchronous Host/DRAM Clock Scheme.

#### Memory Support

- ◆ Two DIMM slots for 168-pin SDRAM memory modules
- ◆ Support for 66MHz, 100MHz, & 133MHz memory bus
- ◆ Maximum installed memory is 2 x 512MB = 1 GB

#### Expansion Slots

- ◆ Two 32-bit PCI slots
- ◆ One AMR slot for a special audio/modem riser card

#### Onboard IDE channels

- ◆ Primary and Secondary PCI IDE channels
- ◆ Support for PIO (programmable input/output) modes
- ◆ Support for Multiword DMA modes
- ◆ Support for Bus Mastering and Ultra DMA 33/66 modes

#### Power Supply and Power Management

- ◆ ATX power supply connector
- ◆ ACPI and previous PMU support, suspend switch, keyboard power on/off
- ◆ Supports Wake on Modem, Wake on LAN and Wake on Alarm

## 1: Introduction

### Built-in Graphics System

- ◆ Onboard 128-bit 2D/3D 100MHz Host interface **AGP Graphics Accelerator** Complies with AGP 1x,2x,4x
- ◆ Shared memory architecture allows a maximum of 64 MB main memory to act as frame buffer
- ◆ Supports high resolutions up to 1920x1200 16M colors, up to 2048x2048 Texture size and Virtual screen up to 4096x4096
- ◆ Supports hardware DVD Accelerator

### Sound System

- ◆ Complies with the PC99 audio specification
- ◆ 16-bit CODEC for full-duplex playback and recording
- ◆ Driver support for Windows 95/98/2000/NT 4.0
- ◆ Provides MPU-401 Game/MIDI port and legacy Sound Blaster 16 support
- ◆ Downloadable Wave-table Synthesizer supports Direct Music®
- ◆ 48KHz sampling rate and measured **90dB** audio quality

### Onboard I/O Ports

- ◆ Provides PC99 Color Connectors for easy peripheral device connections
- ◆ Floppy disk drive connector with 1Mb/s transfer rate
- ◆ One serial port with 16550-compatible fast UART
- ◆ One parallel port with ECP and EPP support
- ◆ Five USB ports (three for optional) and two PS/2 ports for keyboard and mouse
- ◆ One infrared port connector for optional module

### Built-in Ethernet LAN

- ◆ **Optional 10BaseT/100BaseTX Ethernet LAN**
- ◆ LAN controller integrates Fast Ethernet MAC and PHY compliant with IEEE802.3u 100BASE-TX, 10BASE-T and ANSI X3.263 TP-PMD standards
- ◆ Compliant with ACPI 1.0 and the Network Device Class Power Management 1.0

## **MS7308D/E Mainboard User' s Manual**

- ◆ High Performance provided by 100Mbps clock generator and data recovery circuit for 100Mbps receiver

### **Onboard Flash ROM**

- ◆ Automatic CPU and board configuration
- ◆ Supports Plug and Play configuration of peripheral devices and expansion cards
- ◆ Built-in virus protection using **Trend' s ChipAwayVirus** provides boot process virus protection.

### **Bundled Software**

- ◆ **PC-Cillin** provides automatic virus protection under DOS, Windows 95/98
- ◆ **SuperVoice** is data, fax and voice communication software
- ◆ **Gamut** provides professional audio features included MP3 encoding/playback
- ◆ **MediaRing Talk** provides PC to PC or PC to Phone internet phone communication
- ◆ **S-YXG50** is music synthesizer software to playback MIDI files on the system

### **Dimensions**

- ◆ Micro-ATX form factor (24.4cm x 19cm)



## 1: Introduction

### Package Contents

Your mainboard package ships with the following items:

- ❑ The mainboard
- ❑ This User's Guide
- ❑ 1 UDMA/66 IDE cable
- ❑ Floppy disk drive cable
- ❑ Support software on CD-ROM disk
- ❑ **10/100BaseTX Ethernet LAN ( Only for MS7308E M/B )**

### Optional Accessories

You can purchase the following optional accessories for this mainboard.

- ❑ Extended USB module

## **MS7308D/E Mainboard User' s Manual**

### **□ Static Electricity Precautions**

Components on this mainboard can be damaged by static electricity. Take the following precautions when unpacking the mainboard and installing it in a system.

1. Keep the mainboard and other components in their original static-proof packaging until you are ready to install them.
2. During installation, wear a grounded wrist strap if possible. If you don' t have a wrist strap, discharge static electricity by touching the bare metal of the system chassis.
3. Handle the mainboard carefully by the edges. Avoid touching the components unless it is absolutely necessary. During installation put the mainboard on top of the static-protection packaging it came in with the component side facing up.

### **Pre-Installation Inspection**

1. Inspect the mainboard for damage to the components and connectors on the board.
2. If you suspect that the mainboard has been damaged, do not connect power to the system. Contact your mainboard vendor and report the damage.

## Chapter 2

### Mainboard Installation

---

To install this mainboard in a system, follow the procedures in this chapter:

- ❑ Identify the mainboard components
- ❑ Install a CPU
- ❑ Install one or more system memory modules
- ❑ Verify that any jumpers or switches are set correctly
- ❑ Install the mainboard in a system chassis (case)
- ❑ Connect any extension brackets or cables to the mainboard connector headers
- ❑ Install any other devices and make the appropriate connections to the mainboard connector headers.

**Note:**

1. Before installing this mainboard, make sure jumper JP7 is set to Normal, the default setting. See this chapter for information on locating JP7 and the setting options.
2. Never connect power to the system during installation. Doing so may damage the mainboard.

## MS7308D/E Mainboard User's Manual

### Mainboard Components

Use the diagram below to identify the major components on the mainboard.

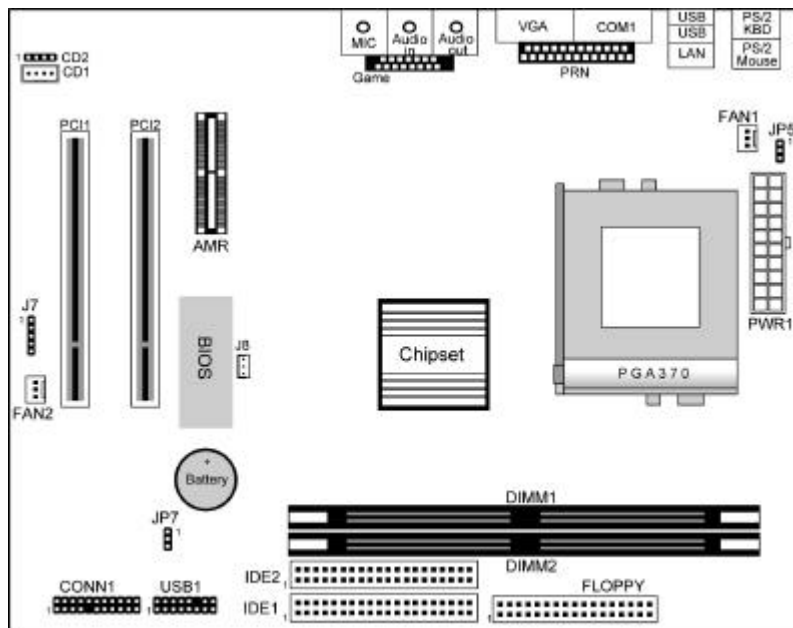

*Note: Any jumpers on your mainboard that do not appear in this illustration are for testing only.*

## 2: Mainboard Installation

### Install A CPU

This mainboard has a Socket 370 which supports Celeron PPGA and FCPGA Pentium III processors.

**To ensure reliability, ensure that your processor has a heatsink/cooling fan assembly.**

Do not try to install a Socket 7 processor in the Socket-370. A Socket 7 processor such as the Pentium-MMX, or the AMD K5/K6 does not fit in the Socket 370.

The following list notes the processors that are currently supported by this mainboard.

**PPGA Celeron:** 300~600 MHz, FSB: 66 MHz

**FCPGA Pentium III:** 500~800MHz, FSB: 100MHz, 133MHz

### Installing a Socket-370 Processor

A processor installs into the ZIF (Zero Insertion Force) Socket-370 on the mainboard.

1. Locate the Socket-370 and FAN1. Pull the locking lever out slightly from the socket and raise it to the upright position.

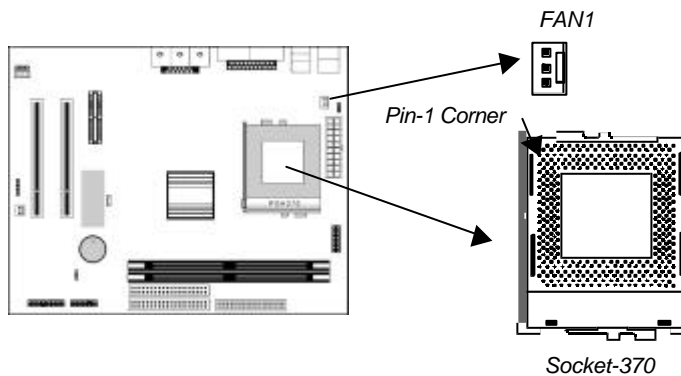

2. On the processor, identify the Pin-1 corner by its beveled edge.

## MS7308D/E Mainboard User's Manual

3. On the Socket-370, identify the Pin-1 corner. The Pin-1 corner is at the end of the locking lever when it is locked.
4. Match the Pin-1 corners and insert the processor into the socket. No force is required and the processor should drop into place freely.
5. Swing the locking lever down and hook it under the catch on the side of the socket. This secures the CPU in the socket.
6. All processors should be installed with a combination heatsink/cooling fan, connect the cable from the fan to the CPU fan power connector FAN1.

## Install Memory

The mainboard has two DIMM sockets for system memory modules. You must install at least one memory module in order to use the mainboard.

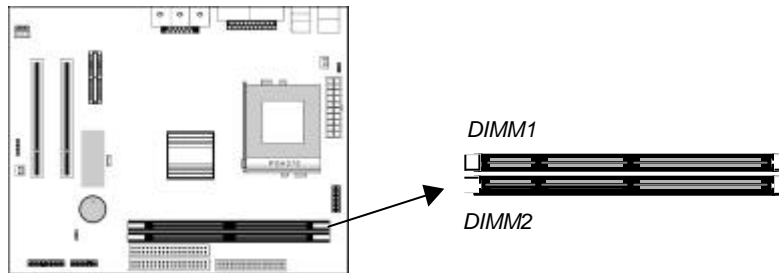

For this mainboard, you must use 168-pin, 3.3V unbuffered SDRAM memory modules. If the installed CPU uses a 100MHz system bus, you must use PC100 or PC133 memory. If the installed CPU uses a 66MHz system bus, you must use PC66 memory. You can install any size memory module from 16 MB to 512MB, so the maximum memory size is  $2 \times 512\text{MB} = 1\text{GB}$ .

The edge connectors on the memory modules have cut outs, which coincide with spacers in the DIMM sockets so that memory modules can only be installed in the correct orientation.

## 2: Mainboard Installation

To install a module, push the retaining latches at either end of the socket outwards. Position the memory module correctly and insert it into the DIMM socket. Press the module down into the socket so that the retaining latches rotate up and secure the module in place by fitting into notches on the edge of the module.

### Setting Jumper Switches

Jumpers are sets of pins which can be connected together with jumper caps. The jumper caps change the way the mainboard operates by changing the electronic circuits on the mainboard. If a jumper cap connects two pins, we say the pins are **SHORT**. If a jumper cap is removed from two pins, the pins are **OPEN**.

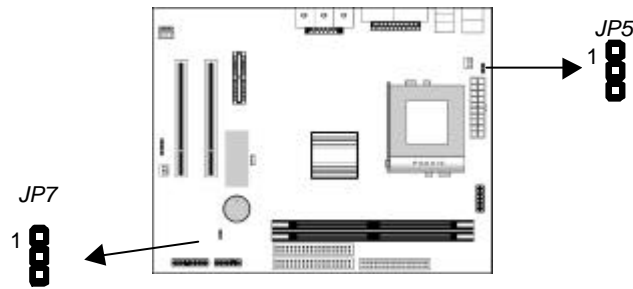

#### Jumper JP5: Keyboard Power On Selector

If you enable the keyboard power on feature, you can use hot keys on your keyboard as a power on/off switch for the system.

*Note: The system must provide 1A on the +5VSB (+5V Standby) signal before using the Keyboard Power On function.*

Function	Jumper Setting
Disable Keyboard Power On	Short Pins 1-2
Enable Keyboard Power On	Short Pins 2-3

#### Jumper JP7: Clear CMOS Memory

Use this jumper to clear the contents of the CMOS memory. You may need to clear the CMOS memory if the settings in the Setup Utility are incorrect and prevent your mainboard from operating. To clear the CMOS memory, disconnect all the power cables from

## MS7308D/E Mainboard User's Manual

the mainboard and then move the jumper cap into the CLEAR setting for a few seconds.

Function	Jumper Setting
Normal Operation	Short Pins 1-2
Clear CMOS Memory	Short Pins 2-3



## 2: Mainboard Installation

### Install the Mainboard

Install the mainboard in a system chassis (case). The board is a Micro-ATX size mainboard with a twin-tier of I/O ports. You can install this mainboard in any ATX case. Ensure that your case has an I/O cover plate that matches the ports on this mainboard.

Install the mainboard in a case. Follow the instructions provided by the case manufacturer using the hardware and internal mounting points on the chassis.

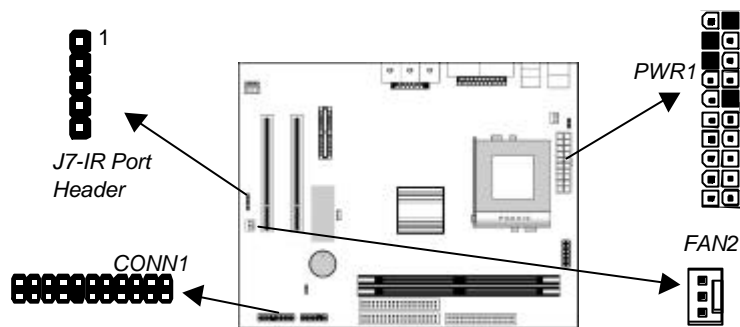

Connect the power connector from the power supply to the **PWR1** ATX Power connector on the mainboard. If there is a cooling fan installed in the system chassis, connect the cable from the cooling fan to the **FAN2** fan power connector on the mainboard. If there is an infrared port installed in the system chassis, connect the cable from the infrared port to the **J7** IR port header on the mainboard. Connect the case switches and indicator LEDs to the **CONN1** switch and LED connector header, see the illustration below for a guide to the connector pin assignments.

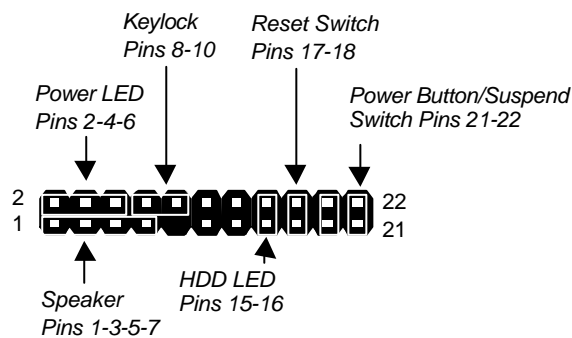

## MS7308D/E Mainboard User's Manual

### Optional Extension Brackets

For this mainboard, you can also obtain a USB module extension bracket. Install them by following the steps below.

#### Extended USB Module

This module bracket has three USB ports for more USB devices.

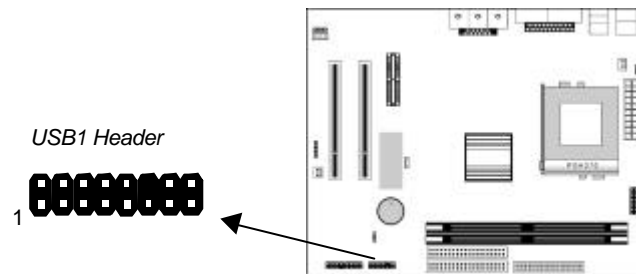

1. Locate the **USB1** header on the mainboard.
2. Plug the bracket cable onto the header.
3. In the system chassis, remove a slot cover from one of the expansion slots and install the extension bracket in the opening. Use the screw that held the slot cover in place to secure the extension bracket to the chassis.

## 2: Mainboard Installation

### Install Other Devices

Install and connect any other devices in the system following the steps below.

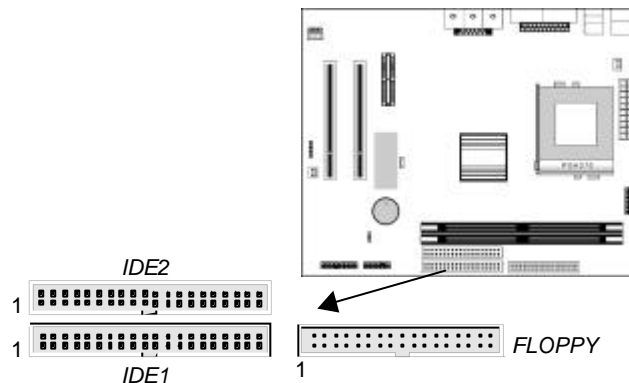

### Floppy Disk Drive

The mainboard ships with a floppy disk drive cable that can support one or two drives. Drives can be 3.5" or 5.25" wide, with capacities of 360K, 720K, 1.2MB, 1.44MB, or 2.88MB.

Install your drives and connect power from the system power supply. Use the cable provided to connect the drives to the floppy disk drive header **FLOPPY**.

### IDE Devices

IDE devices include hard disk drives, high-density diskette drives, and CD-ROM or DVD-ROM drives, among others.

The mainboard ships with an IDE cable that can support one or two IDE devices. If you connect two devices to a single cable, you must configure one of the drives as Master and one of the drives as Slave. The documentation of the IDE device will tell you how to configure the device as a Master or Slave device. The Master device connects to the end of the cable.

Install the device(s) and connect power from the system power supply. Use the cable provided to connect the device(s) to the Primary IDE channel connector **IDE1** on the mainboard.

## MS7308D/E Mainboard User's Manual

If you want to install more IDE devices, you can purchase a second IDE cable and connect one or two devices to the Secondary IDE channel connector **IDE2** on the mainboard. If you have two devices on the cable, one must be Master and one must be Slave.

### Internal Sound Connections

If you have installed a CD-ROM drive or DVD-ROM drive, you can connect the drive audio cable to the onboard sound system. On the mainboard, locate the two 4-pin connectors **CD1** and **CD2**. There are two kinds of connector because different brands of CD-ROM drive have different kinds of audio cable connectors. Connect the cable to the appropriate connector.

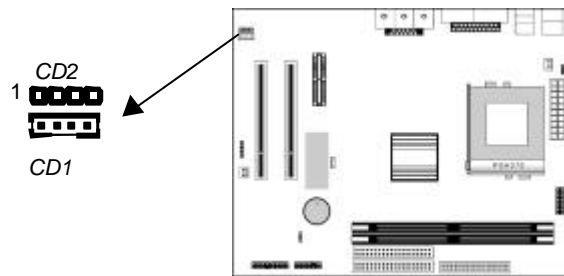

## 2: Mainboard Installation

### Expansion Slots

This mainboard has two 32-bit PCI expansion slots, an AMR slot.

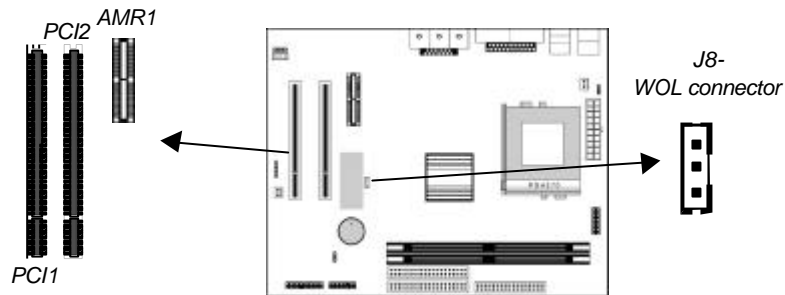

Follow the steps below to install a PCI/AMR expansion card.

1. Locate the PCI, AMR slots on the mainboard.
2. Remove the slot cover for the expansion slot from the system chassis.
3. Insert the expansion card edge connector into the slot and press it firmly down into it so that it is fully inserted.
4. Secure the expansion card bracket to the system chassis using the screw that held the slot cover in place.

### AMR Slot

The AMR (Audio Modem Riser) slot is an industry standard slot that allows for the installation of a special audio/modem riser card. Different territories have different regulations regarding the specifications of a modem card. You can purchase an AMR card that is approved in your area and install it directly into the AMR slot.

## **MS7308D/E Mainboard User' s Manual**

### **Wake On LAN (WOL)**

If you are using an ATX power supply you can configure your system so that it powers down by software and can be resumed by alarms. If you have installed a LAN adapter expansion card, connect the card to the Wake On LAN connector **J8**. This allows incoming traffic to resume the system from a software power down. You need to enable this feature in the system setup utility.

## Chapter 3

# BIOS Setup Utility

---

### Introduction

The BIOS Setup Utility records settings and information about your computer such as the date and time, the kind of hardware installed, and various configuration settings. Your computer uses this information to initialize all the components when booting up and functions as the basis for coordination between system components.

If the Setup Utility configuration is incorrect, it may cause the system to malfunction. It can even stop your computer from booting properly. If this happens, you can use the clear CMOS jumper to clear the CMOS memory used to store the configuration information, or you can hold down the **Page Up** key while you reboot your computer. Holding down the **Page Up** key also clears the setup information.

You can run the setup utility and manually make changes to the configuration. You might need to do this to configure some of the hardware that you install on or connect to the mainboard, such as the CPU, system memory, disk drives, etc.

## MS7308D/E Mainboard User's Manual

### Running the Setup Utility

Each time your computer starts, before the operating system loads, a message appears on the screen that prompts you to “Hit <DEL> if you want to run SETUP”. When you see this message, press the **Delete** key and the Main menu page of the Setup Utility appears on your monitor.

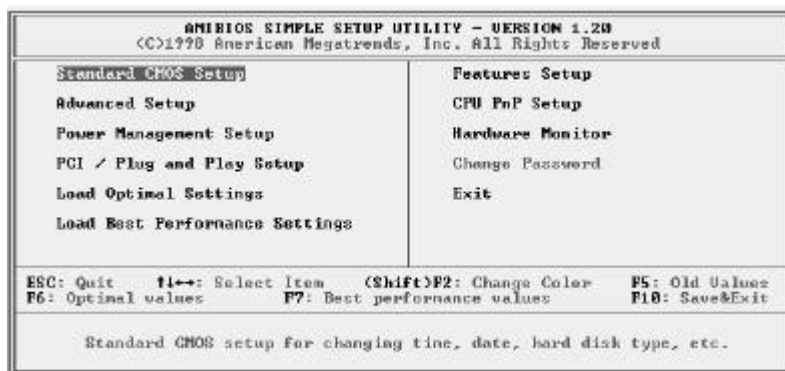

You can use the cursor arrow keys to highlight any of the options on the main menu page. Press **Enter** to select the highlighted option. To leave the setup utility, press the **Escape** key. To cycle through the Setup Utility's optional color schemes hold down the **Shift** key and press **F2**.

Some of the options on the main menu page lead to tables of items with installed values. In these pages, use the cursor arrow keys to highlight the items, and then use the **PgUp** and **PgDn** keys to cycle through the alternate values for each of the items. Other options on the main menu page lead to dialog boxes which require you to answer Yes or No by hitting the **Y** or **N** keys.

If you have already made changes to the setup utility, press **F10** to save those changes and exit the utility. Press **F5** to reset the changes to the original values. Press **F6** to install the setup utility with a set of default values. Press **F7** to install the setup utility with a set of high-performance values.



### 3: BIOS Setup Utility

#### Standard CMOS Setup Page

Use this page to set basic information such as the date and time, the IDE devices, and the diskette drives. If you press the F3 key, the system will automatically detect and configure the hard disks on the IDE channels.

```
AMIBIOS SETUP - STANDARD CMOS SETUP
(C)1998 American Megatrends, Inc. All Rights Reserved

Date (mm/dd/yyyy): Thu DEC 02, 1999
Time (hh/mm/ss) : 23:27:20

Type      Size  Cyls  Head  WPcon  Sec  LBA  Blk  PIO  32Bit
Pri Master : Not Installed
Pri Slave  : Not Installed
Sec Master : Not Installed
Sec Slave  : Not Installed

Floppy Drive A: Not Installed
Floppy Drive B: Not Installed

Month: Jan - Dec          ESC = Exit
Day: 01 - 31             F4 = Select Item
Year: 1981 - 2099       F1/F2/+/= : Modify
                          <Shift>F2 : Color
                          F3 = Detect All HDD
```

Date & Time	Use these items to set the system date and time
Pri Master Pri Slave Sec Master Sec Slave	Use these items to configure devices connected to the Primary and Secondary IDE channels. To configure an IDE hard disk drive, choose <i>Auto</i> . If the <i>Auto</i> setting fails to find a hard disk drive, set it to <i>User</i> , and then fill in the hard disk characteristics (Size, Cyls, etc.) manually. If you have a CD-ROM drive, select the setting <i>CDROM</i> . If you have an ATAPI device with removable media (e.g. a ZIP drive or an LS-120) select <i>Floptical</i> .
Floppy Drive A Floppy Drive B	Use these items to set the size and capacity of the floppy diskette drive(s) installed in the system.

## MS7308D/E Mainboard User's Manual

### Advanced Setup Page

Use this page to set more advanced information about your system. Take some care with this page. Making changes can affect the operation of your computer.



Trend ChipAway Virus	This mainboard has built-in virus protection in the firmware. Use this item to enable or disable the built-in virus protection.
Share Memory Size	This item lets you allocate a portion of the main memory for use by the onboard VGA display.
1 <sup>st</sup> Boot Device 2 <sup>nd</sup> Boot Device 3 <sup>rd</sup> Boot Device	Use these items to determine the device order the computer uses to look for an operating system to load at start-up time.
Try Other Boot Device	If you enable this item, the system will also search for other boot devices if it fails to find an operating system from the first two locations.
S.M.A.R.T. for Hard Disks	Enable this item if any IDE hard disks support the S.M.A.R.T. (Self-Monitoring, Analysis and Reporting Technology) feature.
BootUp Num-Lock	This items determines if the Num Lock key is active or inactive at system start-up time.
Floppy Drive Swap	If you have two diskette drives installed and you enable this item, drive A becomes drive B and drive B becomes drive A.

### 3: BIOS Setup Utility

Floppy Drive Seek	If you enable this item, your system will check all floppy disk drives at start up. Disable this item unless you are using an old 360KB drive.
PS/2 Mouse Support	If this item is set to Enabled, the onboard PS/2 Mouse port will work. Setting this to Disable turns off the port.
Password Check	If you have entered a password for the system, use this item to determine if the password is required to enter the Setup Utility ( <i>Setup</i> ) or required both at start-up and to enter the Setup Utility ( <i>Always</i> ).
Boot to OS/2 > 64MB	Enable this item if you are booting the OS/2 operating system and you have more than 64MB of system memory installed.
Internal Cache	Leave this item enabled since all the processors that can be installed on this board have internal cache memory.
System BIOS Cacheable	If you enable this item, a segment of the system BIOS will be cached to main memory for faster execution.
CAS Latency	This item determines the operation of the SDRAM memory CAS (column address strobe). We recommend that you leave this item at the default value. The 2T setting requires faster memory that specifically supports this mode.

## MS7308D/E Mainboard User's Manual

### Power Management Setup Page

This page sets some of the parameters for system power management operation.



Power Management/APM	Use this item to enable or disable a power management scheme. If you enable power management, you can use the items below to set the power management operation. Both APM and ACPI are supported.
Standby Time Out (Minute)	This sets the timeout for Standby mode in minutes. If the time selected passes without any system activity, the computer will enter power-saving Standby mode.
Suspend Time Out (Minute)	This sets the timeout for Suspend mode in minutes. If the time selected passes without any system activity, the computer will enter power-saving Suspend mode.
Hot Key Power On	If you enable this item, you can turn the system on by pressing hot keys (Ctrl+Alt+BackSpace) on the keyboard. You must connect an ATX power supply and enable the jumper in order to use this feature.

### 3: BIOS Setup Utility

---

OnBoard Lan Power On	The system can be turned off with a software command. If you enable this item, the system can automatically resume if there is traffic on the network adapter. You must use an ATX power supply in order to use this feature.
Ring On Power On	The system can be turned off with a software command. If you enable this item, the system can automatically resume if there is an incoming call on the Fax/Modem. You must use an ATX power supply in order to use this feature.
RTC Alarm Power On	The system can be turned off with a software command. If you enable this item, the system can automatically resume at a fixed time based on the system's RTC (realtime clock). Use the items below this one to set the date and time of the wake-up alarm. You must use an ATX power supply in order to use this feature.

---

## MS7308D/E Mainboard User's Manual

### PCI / Plug and Play Setup Page

This page sets some of the parameters for devices installed on the PCI bus and devices that use the system plug and play capability.



Plug and Play Aware O/S	Enable this item if you are using an O/S that supports Plug and Play such as Windows 95 or 98.
Primary Graphics Adapter	This item indicates if the primary graphics adapter uses the PCI or the AGP bus. The default PCI setting still lets the onboard display work and allows the use of a second display card installed in a PCI slot.
Allocate IRQ to PCI VGA	If this item is enabled, an IRQ will be assigned to the PCI VGA graphics system. You set this value to No to free up an IRQ.
Reserved Memory Size	This item lets you reserve a block of memory for any device that requires it.
Reserved Memory Address	This item lets you set the address for any block of memory that has been reserved.

### 3: BIOS Setup Utility

#### Load Optimal Settings

If you select this item and press **Enter** a dialog box appears. If you press **Y**, and then **Enter**, the Setup Utility loads a set of fail-safe default values. These default values are not very demanding and they should allow your system to function with most kinds of hardware and memory chips.

#### Load Best Performance Settings

If you select this item and press **Enter** a dialog box appears. If you press **Y**, and then **Enter**, the Setup Utility loads a set of best-performance default values. These default are quite demanding and your system might not function properly if you are using slower memory chips or other low-performance components.

## MS7308D/E Mainboard User's Manual

### Features Setup Page

This page sets some of the parameters for peripheral devices connected to the system.

AMIBIOS SETUP – FEATURES SETUP	
©1998 American Megatrends, Inc. All Rights Reserved	
OnBoard FDC	Enabled
OnBoard Serial PortA	3F8h/COM1
OnBoard IR Port	Disabled
OnBoard Parallel Port	378h
Parallel Port Mode	SPP
Parallel Port IRQ	7
Parallel Port DMA	N/A
OnBoard PCI IDE	Both
Ultra DMA Support	Disabled
OnBoard Audio/Modem	Enabled
OnBoard LAN	Enabled
USB Function	Disabled
USB Function for DOS	Disabled
ESC : Quit            ↑↓←→ : Select Item F1 : Help            PU/PD/+/- : Modify F5 : Old Values (Shift)F2 : Color F6 : Load Optimal values F7 : Load Best performance values	

OnBoard FDC	Use this item to enable or disable the onboard floppy disk drive interface.
OnBoard Serial PortA	Use this item to enable or disable the onboard COM1 serial port, and to assign a port address
OnBoard IR Port	Use this item to define the protocol for an infrared port if you have installed an optional IR port. The choices are IrDA and ASKIR.
Onboard Parallel Port	Use this item to enable or disable the onboard LPT1 parallel port, and to assign a port address. The Auto setting will detect and available address.
Parallel Port Mode	Use this item to set the parallel port mode. You can select SPP (Standard Parallel Port), ECP (Extended Capabilities Port), EPP (Enhanced Parallel Port), or ECP + EPP.
Parallel Port IRQ	Use this item to assign either IRQ 5 or 7 to the parallel port.
Parallel Port DMA	Use this item to assign a DMA channel to the parallel port. The options are 0, 1 and 3.



### 3: BIOS Setup Utility

Onboard PCI IDE	Use this item to enable or disable either or both of the onboard Primary and Secondary IDE channels.
Ultra DMA Support	Use this item to set Ultra DMA support for IDE devices on the Primary or Secondary IDE channels. You must enable this or UDMA devices will not work at their intended speed.
OnBoard Audio/Modem	This item enables or disables the onboard audio/modem chip.
OnBoard LAN	This item enables or disables the onboard network interface.
USB Function	Enable this item if you plan to use the USB ports on this mainboard.
USB Function for DOS	Enable this item if you plan to use the USB ports on this mainboard in a DOS environment.

## MS7308D/E Mainboard User's Manual

### CPU PnP Setup Page

This page lets you manually configure the mainboard for the CPU. The system will automatically detect the kind of CPU that you have installed and make the appropriate adjustments to the items on this page.

**Note:** If you manually set the wrong speed and the system won't run properly, press the **Page Up** key while the system is booting and a default setting will replace the incorrect CPU setting.



CPU Speed	The item displays the internal clock speed of the CPU, based on the next two items.
CPU/SDRAM Frequency	Use this item to sets the external clock frequency for the CPU and the memory bus frequency. The options include combinations of 66 and 100MHz. Set the CPU clock based on the requirements of the CPU installed on the board. Select the memory frequency based on the speed of the memory installed on the board.
CPU Multiple Freq.	Use this item to set a multiplier for the CPU external frequency. The multiplier times the external CPU frequency sets the internal clock speed of the CPU, e.g. 100 MHz (external clock or "FSB") x 4.5 (multiplier) = 450 MHz (internal clock speed of the installed CPU).

### 3: BIOS Setup Utility

#### Hardware Monitor Page

This page sets some of the parameters for the hardware monitoring function of this mainboard.

AMIBIOS SETUP – HARDWARE Monitor	
©1998 American Megatrends, Inc. All Rights Reserved	
--- Hardware Monitor ---	
CPU Temperature	30°C/86°F
System Temperature	
Fan#1 Speed	
Fan#2 Speed	
Vcore	2.000 V
+1.800V	1.800 V
Vcc3	3.300 V
Vcc	5.000 V
+12V	12.000 V
SB5V	5.000 V
ESC : Quit      ↑↓←→ : Select Item	
F1 : Help      PU/PD/+/- : Modify	
F5 : Old Values (Shift)F2 : Color	
F6 : Load Optimal values	
F7 : Load Best performance values	

CPU, System Temperature	These items display CPU and the system temperature measurement. The system will alert you if a safe temperature is exceeded.
FAN#1, 2 Speed & Voltage Measurements	These items indicate cooling fan speeds in RPM and the various system voltage measurements. If the values deviate beyond certain limits, the hardware monitoring feature will alert you with a warning.

#### Change Password

If you highlight this item and press **Enter**, a dialog box appears which lets you enter a Supervisor password. You can enter no more than six letters or numbers. Press **Enter** after you have typed in the password. A second dialog box asks you to retype the password for confirmation. Press **Enter** after you have retyped it correctly. The password is then required to access the Setup Utility or for that and at start-up, depending on the setting of the Password Check item in Advanced Setup.

## MS7308D/E Mainboard User's Manual

### Change or Remove the Password

Highlight this item, press Enter and type in the current password.  
At the next dialog box, type in the new password, or just press Enter to disable password protection.

### Exit

Highlight this item and press **Enter** to save the changes that you have made in the Setup Utility configuration and exit the program. When the Save and Exit dialog box appears, press **Y** to save and exit, or press **N** to exit without saving.

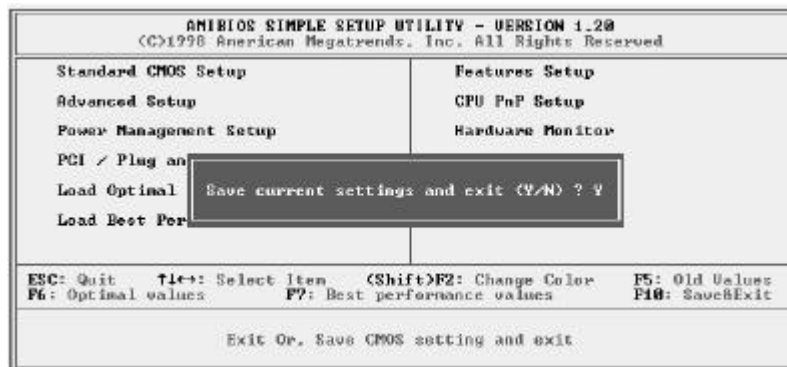

## Chapter 4

# Software & Applications

---

### About the Software

The software for this mainboard is supplied on a CD-ROM. The disk has some folders that can be used by many different mainboards, for example the **UTILITY** folders. Some folders can only be used by mainboards which have certain brands of chipsets, for example the **INTEL** and **SIS** folders. In addition, software that is specifically intended for one kind of mainboard is stored in a folder with the name of that board. The software for this mainboard is stored in the **MS7308D/E** folder.

***Note:** Never try to install software from a folder that is not specified for use with your mainboard.*

### Folders for this Mainboard

For this board, you can install software from the following folders:

#### Utility Folder

You can use the software in the following sub-folders:

- ❑ **AMIFLASH:** Software to erase and install new revisions of the system BIOS
- ❑ **DIRECTX5:** Software display drivers for Microsoft's DirectX Rev. 5 specification
- ❑ **PC-CILLIN:** Anti-virus software
- ❑ **SUPER VIOCE:** Fax/Modem application software
- ❑ **GAMUT:** Audio rack for built-in sound system
- ❑ **MediaRing Talk :** PC to PC base Internet phone application software
- ❑ **Yamaha XG :** Yamaha S-YXG50 Software synthesizer

## MS7308E Mainboard User's Manual

### Running the Support CD-ROM

1. Place the disk in your CD-ROM drive. If you are running Windows with Autoplay enabled, the opening screen of the CD appears automatically. Click on READ ME to read the latest instructions.
2. Before installing the software, look for a file named README.TXT, or something similar. This file may contain important information to help you install the software correctly.
3. Some software is installed in separate folders for different operating systems, such as DOS, WIN NT, WIN95/98, and so on. Always log on to the correct folder for the kind of OS you are using.
4. To install the software, you usually execute a file named SETUP.EXE or INSTALL.EXE by double clicking on the filename.

### Utility Folder Installation Notes

#### AMI Flash Memory Utility

This utility lets you erase the system BIOS stored on a Flash Memory chip on the mainboard, and lets you copy an updated BIOS to the chip. Take care how you use this program. If you erase the current BIOS and fail to write a new BIOS, or write a new BIOS that is incorrect, your system will malfunction.

There are several flash memory utilities. For this mainboard you must use the **AMIFL815.EXE** utility. To use the utility, you must be in real-mode DOS (not the DOS box that is available in Windows 95/98/NT). If you are using WINDOWS 95/98, shut down your computer and select the option Restart in DOS in the shut-down dialog box. If you are running Windows NT, shut down your computer and boot from a DOS diskette temporarily in order to run the flash memory utility.

#### DirectX5 Drivers

The DirectX drivers are for installation only in Windows 95/98. The DirectX drivers need to be installed before you install an AGP driver. You may be able to get more up-to-date DirectX drivers

## 4: Software & Applications

from the Microsoft web site. Start the installation by clicking on the file DX5CORE.EXE.

### **GAMUT**

The Gamut audio rack software for the built-in sound system is provided for different languages. Log on to the appropriate directory for your language, then run SETUP to install the application software.

### **MediaRing Talk**

To install the MediaRing Talk voice modem software for the built-in modem, run MRTALK99-SETUP.

### **PC-Cillin Anti-Virus Utility**

Anti-virus software is provided for DOS, for WIN95, and WIN 98. Log on to the appropriate directory for your operating system. For DOS, copy all the files in the DOS folder to your hard disk drive. For Windows 95, log on to the Disk 1 folder and run SETUP. For Windows 98, run SETUP.

### **Super Voice**

To install the Super Voice voice, fax, data communication application for use with the built-in fax/modem, run PICSHELL.

### **Mainboard (MS7308D/E) Installation Notes**

All of the sub-folders in this folder are empty, with a short README file giving directions to alternate folders for the appropriate software.

## Free Manuals Download Website

<http://myh66.com>

<http://usermanuals.us>

<http://www.somanuals.com>

<http://www.4manuals.cc>

<http://www.manual-lib.com>

<http://www.404manual.com>

<http://www.luxmanual.com>

<http://aubethermostatmanual.com>

Golf course search by state

<http://golfingnear.com>

Email search by domain

<http://emailbydomain.com>

Auto manuals search

<http://auto.somanuals.com>

TV manuals search

<http://tv.somanuals.com>