

OLYMPUS®

VOICE & MUSIC

DM-20

DM-10

INSTRUCTIONS

EN INSTRUCTIONS

FR MODE D'EMPLOI

ES INSTRUCCIONES

Thank you for purchasing an Olympus
Digital Voice Recorder.

Please read these instructions for information
about using the product correctly and safely.
Keep the instructions handy for future reference.

To ensure successful recordings, we recommend that
you test the record function and volume before use.

EN

Table of Contents

Table of Contents	2
Safe and Proper Usage	4
General Precautions	4

1 Getting Started

Main Features	6
Identification of Parts	8
Inserting Batteries	10
Using the AC Adapter	11
Switching Between the Voice Recorder and Music Player	11
Setting Time/Date (TIME&DATE)	12
Installing Software	14

2 When Using the Recorder as a Voice Recorder

Recording	18
Using the Variable Control Voice Actuator (VCVA)	20
Recording with External Microphone	22
Recording Modes (REC MODE)	23
Microphone Sensitivity (MIC SENSE)	24
Playing	25
Repeat Playback	27
Noise Cancel Function	29
Index Marks	30
Menu List (VOICE mode)	31

3 Managing Files on Your PC

Using DSS Player Software	32
Using Online Help	33
Connecting to Your PC	34
Running DSS Player	38

4 Using the Recorder as a Music Player

Using the Recorder as a Music Player	40
Using Windows Media Player	40
Window Names (Windows Media Player)	42
Copying Music from CD	43
Transferring Music File to the Recorder	44
Music Playback	45
Increasing the WOW effect (WOW EFFECT)	48
Menu List (MUSIC mode)	50

5 Feature Common to the Voice Recorder and Music Player

Erasing	51
Hold	54

6 Using the Recorder as a Reader / Writer

Using the Recorder as a Reader/Writer	55
---	----

7 Other Information

Alarm Message List	56
Troubleshooting	58
Accessories (optional)	59
Specifications	59
Technical Assistance And Support	61

1

2

3

4

5

6

7

Safe and Proper Usage

Before using your new recorder, read this manual carefully to ensure that you know how to operate it safely and correctly. Keep this manual in an easily accessible location for future reference.

- The warning symbols indicate important safety related information. To protect yourself and others from personal injury or damage to property, it is essential that you always read the warnings and information provided.

Using the Online Manual

When you install the DSS Player 2002 on your PC from the CD-ROM, you can use an online expanded version of this instruction manual, allowing you to learn more about the digital voice recorder.

If the DSS Player is installed, click on the [Start] button, select [All Programs], then [OLYMPUS DSS Player 2002], then click on [DM-20/10 ONLINE INSTRUCTIONS]. You can read more about the items listed below.

Operating Environment	14
Uninstalling Software	19
Listening While Audio Is Recorded (Recording Monitor)	26
Recording Sound Played Back by Another Device	29
Continuous Playback (ALL PLAY)	34
Auto Backspace review (BACK SPACE)	35
Assigning File Comments (COMMENT)	40
LCD Display Information (VOICE mode)	41
Window Names (DSS Player)	52

Download Voice Files from the Recorder	53
Play a Voice File	55
Upload Voice Files to the Recorder	56
Send Voice Files with E-mail	58
Changing User ID	58
Changing a Folder Name	59
Editing File Comments	59
Editing a Template	60
Changing the User Equalizer (USER EQ)	71
LCD Display Information (MUSIC mode)	73
Changing Playback Order of Music File	75
Locking Files (LOCK)	80
Alarm Playback Function (ALARM)	81
LCD Contrast Adjustment (CONTRAST)	84
Backlight (BACKLIGHT)	85
System Sounds (BEEP)	86
Assigning Folder names (FOLDER NAME)	87
Moving Files Across Folders	90
Formatting the Recorder (FORMAT)	92

General Precautions

- **Do not leave the recorder in hot, humid locations such as inside a closed automobile under direct sunlight or on the beach in the summer.**
- **Do not store the recorder in places exposed to excessive moisture or dust.**
- **Do not use organic solvents such as alcohol and lacquer thinner to clean the unit.**
- **Do not place the recorder on top of or near electric appliances such as TVs or refrigerators.**

- **Avoid recording or playing back near cellular phones or other wireless equipment, as they may cause interference and noise. If you experience noise, move to another place, or move the recorder further away from such equipment.**
- **Avoid sand or dirt. These can cause irreparable damage.**
- **Avoid strong vibrations or shocks.**
- **Do not disassemble, repair or modify the unit yourself.**
- **Do not operate the unit while operating a vehicle (such as a bicycle, motorcycle, or go-cart).**
- **Keep the unit out of the reach of children.**

<Warning regarding data loss>

Recorded content in memory may be destroyed or erased by operating mistakes, unit malfunction, or during repair work.

It is recommended to back up and save important content to other media such as a computer hard disk.

Batteries

Warning

- **Batteries should never be exposed to flame, heated, short-circuited or disassembled.**
- **Do not attempt to recharge alkaline, lithium or any other non-rechargeable batteries.**
- **Never use any battery with a torn or cracked outer cover.**
- **Keep batteries out of the reach of children.**
- **If you notice anything unusual when using this product such as abnormal noise, heat, smoke, or a burning odor:**

- ① remove the batteries immediately while being careful not to burn yourself, and;
- ② call your dealer or local Olympus representative for service.

AC Adapter

Warning

- **Do not attempt to disassemble, repair or modify the AC adapter in any way.**
- **Keep foreign objects including water, metal, or flammable substances from getting inside the product.**
- **Do not moisten the AC adapter or touch it with a wet hand.**
- **Do not use the AC adapter in the vicinity of flammable gas (including gasoline, benzene and lacquer thinner).**

In case

- ... the internal parts of the AC adapter are exposed because it has been dropped or otherwise damaged:
- ... the AC adapter is dropped in water, or if water, metal flammable substances or other foreign objects get inside it:
- ... you notice anything unusual when using the AC adapter such as abnormal noise, heat, smoke, or a burning odor:
 - ① do not touch any of the exposed parts;
 - ② immediately disconnect the power supply plug from the power outlet, and;
 - ③ call your dealer or local Olympus representative for servicing. Continued use of the AC adapter under these circumstances could result in electric shock, fire or injury.

Main Features

1

Main Features

- Dual function recorder as a Digital Voice Recorder and a Digital Music Player (€ P.18,40).
- Includes the Olympus DSS Player software and Windows Media Player (€ P.14).
- Includes a dual function Remote Controller and Microphone (€ P.22).¹
- A Ear/Mic/Remote Controller Jack with switch-over depending on the application.
- A USB connected Cradle for data download from the recorder to the PC (€ P.34).
- The recorder can also be used as a removable external memory reader/writer (€ P.55).
- The large LCD screen with backlight can be easily read even in the dark.
- You may assign your own names to folders.

Main features of the Digital Voice Recorder

- The recorder stores highly compressed DSS and WMA format voice messages in integrated flash memory.²
- The recorder supports three recording modes, HQ (High Quality) mode, SP (Standard Playback) mode and LP (Long Playback) mode. If a stereo microphone (optional) is used, you can enjoy recording in SHQ (Stereo High Quality) mode (€ P.23).

Recording time*3

- DM-20 (128MB)

SHQ mode : 4 hours 20 minutes

HQ mode : 8 hours 45 minutes

SP mode : 20 hours 55 minutes

LP mode : 44 hours 45 minutes

- DM-10 (64MB)

SHQ mode : 2 hours 10 minutes

HQ mode : 4 hours 20 minutes

SP mode : 10 hours 25 minutes

LP mode : 22 hours 20 minutes

- The five folders can hold 199 files each, for the maximum of 995 recordings (€ P.18).
- You can input file comments.⁴
- The recorder has a Noise Cancel Function (€ P.29).
- Recorded files may be moved from one folder to another.
- You can insert or delete index marks (€ P.30).⁴
- The recorder has Fast Playback and Slow Playback functions to control playback speed (€ P.26).
- Comes with DSS Player software (€ P.32).

Main features of the Digital Music Player

- Can play back music files in MP3 and WMA format.

Playback time*5

DM-20 (128 MB) : 100 to 340 minutes

DM-10 (64 MB) : 50 to 170 minutes

- Has built-in WOW (ESS P.48).
- You can change the playback equalizer settings.

*1: Depending on the product you purchased, the remote controller microphone may not be included. For the supplied components, see the descriptions on the package.

*2: DSS format in SP and LP mode recording, and WMA format in SHQ and HQ mode recording.

*3: Available recording time for one continuous file. Available recording time may be shorter if many short recordings are made. (The displayed available recording time and recorded time are approximate indications.)

*4: For WMA files, these functions are only available for files recorded with this recorder or the IC recorders from Olympus.

*5: The total storage time will vary depending on the bit rate of each music file.

IBM and PC/AT are the trademarks or registered trademarks of International Business Machines Corporation.

Microsoft, Windows and Windows Media are registered trademarks of Microsoft Corporation.

Apple, Macintosh, iMac, Mac, and PowerMac are trademarks or registered trademarks of Apple Computer, Inc.

Intel and Pentium are registered trademarks of Intel Corporation.

Adobe and Acrobat Reader are registered trademarks of Adobe Systems Incorporated.

WOW, SRS and (●) symbol are trademarks of SRS Labs, Inc.

WOW technology is incorporated under license from SRS Labs, Inc.

CORTOLOGIC is a registered trademark of Cortologic AG.

Other product and brand names mentioned herein may be the trademarks or registered trademarks of their respective owners.



Identification of Parts

1

Identification of Parts

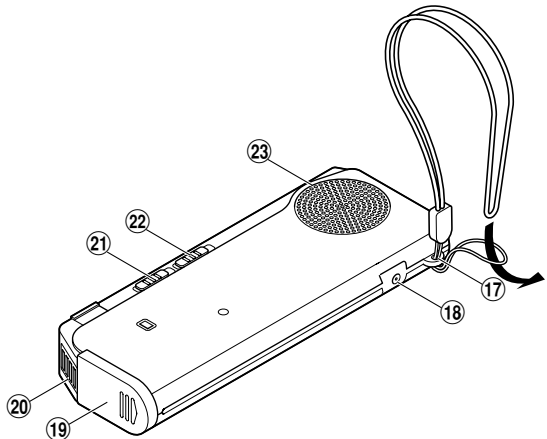
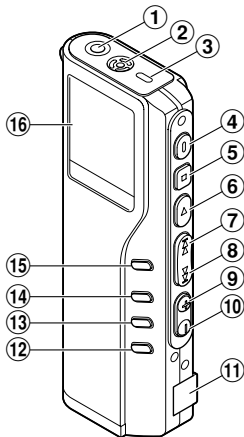

- ① EAR/MIC/REMOTE jack
- ② Built-in microphone
- ③ Record/Play indicator lamp
- ④ REC (Record) button
- ⑤ STOP button
- ⑥ PLAY button
- ⑦ FF (Fast Forward) button
- ⑧ REW (Rewind) button
- ⑨ VOL (+) button
- ⑩ VOL (-) button
- ⑪ PC (USB) terminal
- ⑫ ERASE button

- ⑬ FOLDER/REPEAT button
- ⑭ INDEX/EQ button
- ⑮ DISPLAY/MENU button
- ⑯ Display (LCD panel)
- ⑰ Strap hole
- ⑱ Power jack
- ⑲ Battery cover
- ⑳ Cradle attachment point
- ㉑ Mode (VOICE/MUSIC) switch
- ㉒ HOLD switch
- ㉓ Built-in speaker

Remote Controller Microphone

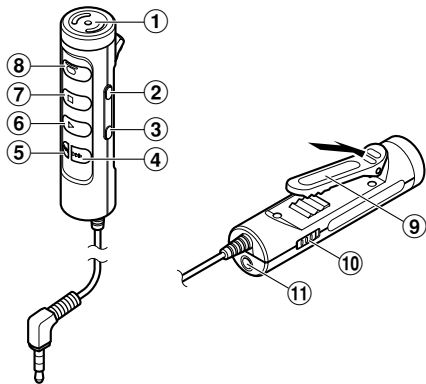

- ① Built-in microphone
- ② VOL (+) button
- ③ VOL (-) button
- ④ FF (Fast Forward) button
- ⑤ REW (Rewind) button
- ⑥ PLAY button
- ⑦ STOP button
- ⑧ REC (Record) button/
REC indicator lamp
- ⑨ Clip
- ⑩ HOLD switch
- ⑪ EAR jack

Display (LCD Panel)

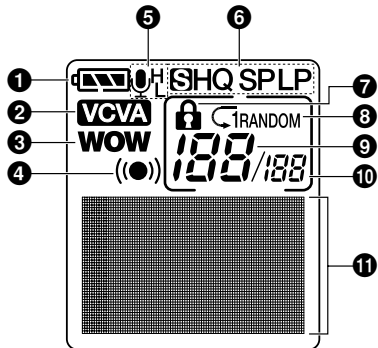

- ① Battery indicator
- ② VCVA (Variable Control Voice Actuator) indicator
- ③ WOW indicator
- ④ Alarm indicator
- ⑤ Microphone sensitivity display
- ⑥ Record mode indicator
- ⑦ Erase lock indicator
- ⑧ Repeat, Random play indicator
- ⑨ Current file number
- ⑩ Total number of recorded files in the folder
- ⑪ Character Information display

Depending on the product you purchased, the remote controller microphone may not be included. For the supplied components, see the descriptions on the package.

Inserting Batteries

1

Inserting Batteries

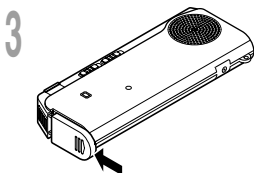
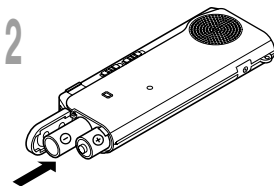
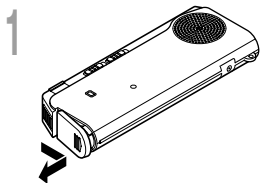

1 Lightly press down on the arrow and slide the battery cover open.

2 Insert two AAA alkaline batteries, observing the correct polarity.

3 Close the battery cover completely.

Replacing batteries

The battery indicator on the display changes as the batteries lose power.

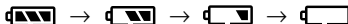

When  appears on the display, replace the batteries as soon as possible.

When the batteries are too weak, the recorder shuts down and “BATTERY LOW” appears on the display. AAA alkaline batteries are recommended.

An optional Ni-MH Rechargeable Battery from Olympus can be used for the recorder (P.59).

Notes

- **Be sure to stop the recorder before replacing the batteries.** Unloading the batteries while the recorder is in use may corrupt the file. If you are recording into a file and the batteries run out, you will lose your currently recorded file because the file header will not be able to close. It is crucial to change the batteries once you see only one Hash mark in the battery icon.
- Be sure to replace both batteries at the same time.
- **Never mix old and new batteries, or batteries of different types and/or brands.**
- If it takes longer than 1 minute to replace dead batteries, you may have to reset the time when you load fresh batteries (P.12).
- Remove the batteries if you are not going to use the recorder for an extended period of time.

Using the AC Adapter

Plug the optional AC adapter (Olympus Model A321 or A322) into household power outlet and connect the power plug to the recorder's power connector (DC 3 V) as shown in the illustration. Always stop recording before connection. Otherwise it may not be possible to play back the voice data being recorded.

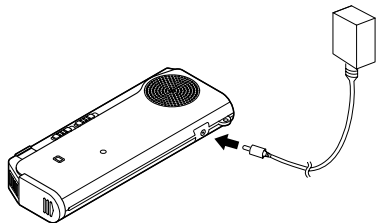

⚠ Warning

- **Always stop recording before connection or disconnection.**
- **When the AC adapter is not in use, disconnect the power supply plug from the power outlet.**
- **Use only the correct power supply voltage as indicated on the adapter.**
- **Do not use the AC adapter when connecting the recorder to the USB port.**

Switching Between the Voice Recorder and Music Player

This device can be used as a voice recorder or as a music player.

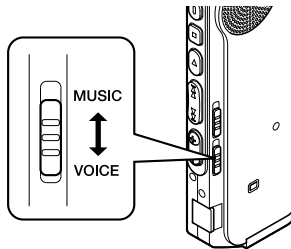

Using the mode switch, choose between **VOICE** or **MUSIC** option.

VOICE : For recording or playing back voice files.

MUSIC : For listening to music files.

— Meaning of icons in this manual —



Set the mode switch to **VOICE** before operating the recorder.



Set the mode switch to **MUSIC** before operating the recorder.



Convenient features that can be used with both the Voice Recorder and Music Player.

Setting Time/Date (TIME&DATE)

1

Setting Time/Date (TIME&DATE)

If you have set the time and date, information as to when an audio file is recorded is stored automatically with that file. The time and date should be set to ease file management tasks. The time and date setting is also needed to perform the alarm playback function.

The hour indicator will flash automatically when you load batteries before using the recorder for the first time, or after the recorder hasn't been used for a long time. Proceed from step 1.

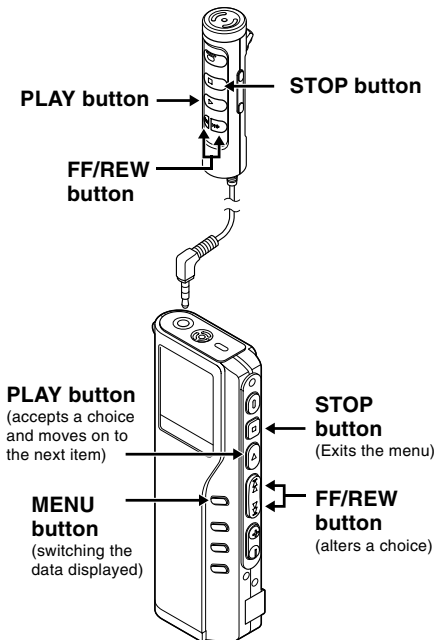

When the remote controller microphone is connected, buttons with the same names as those on the recorder work analogously.

1 Set the hour.

- ① Press the **FF** button or **REW** button to set the hour.
 - ② Press the **PLAY** button to accept the hour.
- You can choose between 12 and 24 hour display by pressing the **MENU** button while setting the hour and minute.

Example: 5:45 P.M.

PM 5:45 ↔ 17:45
(Initial setting)

2 Set the minute.

- ① Press the **FF** button or **REW** button to set the minute.
- ② Press the **PLAY** button to accept the minute.

3 Set the year.

- ① Press the **FF** button or **REW** button to set the year.
 - ② Press the **PLAY** button to accept the year.
- You can choose the order of the year, month, day by pressing the **MENU** button while setting them.

Example: March 14, 2003

3M 14D 2003Y (Initial setting)



14D 3M 2003Y



2003Y 3M 14D



5 Set the date.

- ① Press the **FF** button or **REW** button to set the date.
- ② Press the **PLAY** button to accept the date.

6 Press the **STOP** button to close the menu.

Note

If you press the STOP button during the setup operation, the recorder will save the items that were set to that point.

4 Set the month.

- ① Press the **FF** button or **REW** button to set the month.
- ② Press the **PLAY** button to accept the month.

Changing the Time/Date

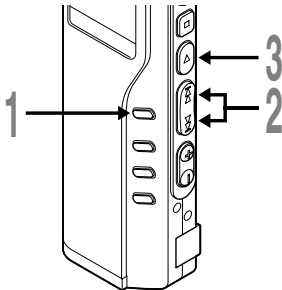

1 Press and hold the **MENU** button for 1 second or longer.

The menu opens (P.31,50).

2 Press the **FF** or **REW** button until “**TIME & DATE**” flashes on the display.

3 Press the **PLAY** button.

Time/Date screen appears. The hour indicator flashes, indicating the start of the Time/Date setup process.



Follow the same steps starting at step 1 in “Setting Time/Date” (P.12).

Installing Software

1

Installing Software

Before you connect the recorder to your PC and use it, you must first install the utility software from the included Software CD.

Applications included with “Voice & Music DM Series Utility Software”

- DSS Player: Recorded voice files can be downloaded to the PC for complete file management and playback solution.
- Windows Media Player: Music data can be converted into music files and uploaded to the recorder.
- Acrobat Reader is installed on your PC. It is required to view the accompanying manual in PDF format.

Be sure to confirm the following before installation:

- Exit all running applications.
- Eject the floppy disk if you are using one.
- If you are running Windows2000/XP or Mac OS X on the network, you need to log on as an Administrator.

1 Insert OLYMPUS Voice & Music DM Series Utility Software into the CD-ROM drive.

The installation program will start automatically. Once the program starts, jump to step 4. If it does not, follow the procedures in steps 2 and 3.

2 Click the [Start] button and select [Run].

3 Enter "D:\setup.exe" in the [Open] field and click [OK].

This is assuming the CD-ROM drive is D.

4 The installation Language Selection dialog box opens.

Click the desired language to select it.

5 Select the necessary software, when the OLYMPUS Voice & Music DM Series Utility Software opening screen appears.

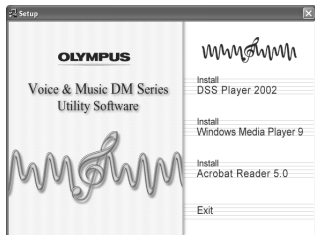

Installing DSS Player

6 Confirm your acceptance of the terms of the Licensing Agreement.

You must accept the terms of the Licensing Agreement to install DSS Player. If you accept them, click [Yes].

7 Register user information.

Register user information. Enter your name, company name, and license ID number (serial number).

The license ID number is printed on the license ID card. Click [Next]. A confirmation dialog box opens, click [Yes].

8 Select where to install DSS Player.

This lets you specify the folder in which to install DSS Player. Click [Browse] to find the desired installation folder. To accept the default folder, click [Next].

Note

If the installation folder does not exist, a confirmation dialog box opens to get your permission to create a folder for this purpose. Click [Yes].

9 Select a program menu folder.

You may change the program menu folder to another one, such as [Start Up]. To accept the default folder, click [Next].

10 Authorizing the start of file copying.

Confirm all "Current Settings". To accept them, click [Next].

Note

To change the program menu folder or installation folder, click [Back].

11 Copy files.

Wait until DSS Player is installed on your PC, then click [Finish].

The screen returns to the opening screen automatically.

If you would like to install Windows Media Player at this time, please select “Install Windows Media Player” and proceed to step 12 below.

Installing Windows Media Player

12 Confirm acceptance of the terms of the Licensing Agreement.

You must accept the terms of the Licensing Agreement to install Windows Media Player. If you accept them, click [I Accept].

Installing Windows Media Player.

13 Select your Privacy Options.

You can set up your privacy options on this screen. If you want to install the software applying to your environment, change the check in the checkbox.

To select the default, click [Next].

14 Customize the Installation Option.

Select the installation options. To select the default, click [Finish]. Installation is complete and Windows Media Player will start up. Close Windows Media Player to return to the opening screen.

If you would like to install Acrobat Reader at this time, please select “Install Acrobat Reader” and proceed to step 15 below.

Install Acrobat Reader

15 Install Acrobat Reader according to the directions on the screen.

Installing the Device Driver

16 Connect the recorder to your PC, referring to “Connecting to Your PC” (P.34).

When you connect the recorder to your PC for the first time after installing DSS Player, the recorder’s driver will be installed automatically. If the driver is installed properly, DSS Player will start automatically.

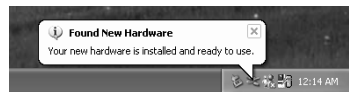

Macintosh

1 Insert OLYMPUS Voice & Music DM Series Utility Software into the CD-ROM drive.

2 Double-click CD icon.
Double-click the desired language to select it.

3 Double-click the following icon.
(OS 9.x)
DSS Player for Mac Installer
(OS X)
DSS Player (for Mac) Installer OS X

4 Click [Continue] when the DSS Player for Mac opening screen appears.

5 Confirm your acceptance of the terms of the Licensing Agreement.
You must accept the terms of the Licensing Agreement to install DSS Player for Mac. If you accept them, click [Agree].

6 Select where to install DSS Player for Mac.
This lets you specify the folder in which to install DSS Player for Mac. To accept the default folder, click [Choose].
Installing DSS Player for Mac.



7 Completing setup.
Installation has finished. Click [Quit]. If you installed the software into the OS 9.x, you need restart your PC after completing the installation.



Recording

2

Recording

The recorder provides five folders, A, B, C, D and E, and each message recorded in a folder is saved as a Digital Speech Standard (DSS) file or a Windows Media Audio (WMA) file. These five folders can be selectively used to distinguish the kind of recording; for example, Folder A might be used to store private information, while Folder B might be dedicated to holding business information. Up to 199 messages can be recorded per folder.

Microphone

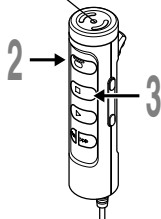

1 Press the FOLDER button to choose a folder.

The folder name is displayed.

- a Total number of recorded files in the folder
- b Current file number
- c Current folder

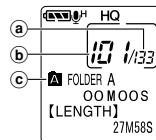

2 Press the REC button to start recording.

The record/play indicator lamp glows red. Aim the microphone at the sound source. When using the remote controller microphone for recording, the indicator lamp and internal microphone of the recorder are switched off.

- d Current recording mode
- e Recording time
- f Remaining recording time

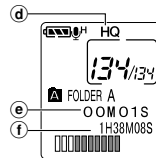

Microphone

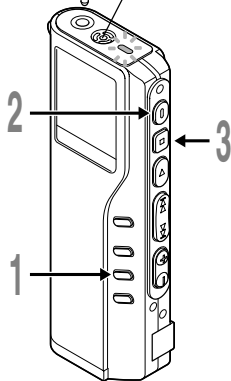

3 Press the STOP button to stop recording.

Notes

- A beep will sound when remaining recording time reaches 60 seconds, 30 seconds, and 10 seconds while recording.
- “MEMORY FULL” or “FOLDER FULL” will be displayed when the memory or folder capacity is full. Delete any unnecessary files before recording any further (see P.51) or transfer voice files to your computer using DSS Player Software.

Recording functions

Pause Recording

Pause

Press the **REC** button while recording.

- ➡ “REC PAUSE” will flash on the display.

Resume Recording

Press the **REC** button again.

- ➡ Recording will resume at the point of interruption.

Note

The recorder will time out after 10 minutes when left in “REC PAUSE”.



Using the Variable Control Voice Actuator (VCVA)

When the microphone senses that sounds have reached a preset threshold volume level, the built-in Variable Control Voice Actuator (VCVA) starts recording automatically, and stops when the volume drops below the threshold level.

The VCVA feature help extend recording time and conserve memory by turning off recording during silent periods. This helps make the playback, with no lulls or dead space, more efficient and convenient.

2

Using the Variable Control Voice Actuator (VCVA)

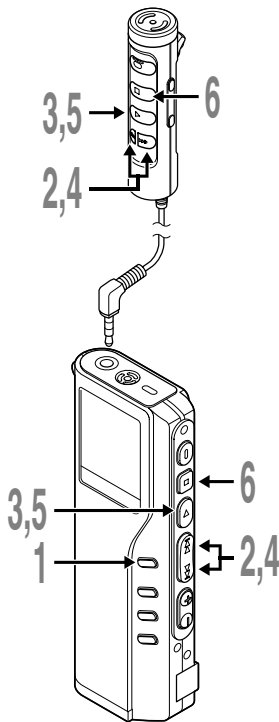

1 Press and hold the MENU button for 1 second or longer.

The menu opens (P.31).

2 Press the FF or REW button until “VCVA” flashes on the display.

3 Press the PLAY button.

The VCVA setup process begins.

4 Press the FF or REW button to choose between ON and OFF.

ON : Will start recording in VCVA mode.

OFF : Will resume recording in normal mode.

5 Press the PLAY button to complete the setup screen.

6 Press the STOP button to close the menu.

When ON is selected, a VCVA indication will be displayed on the screen.

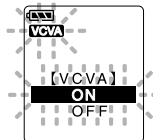
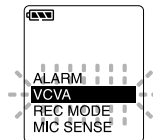

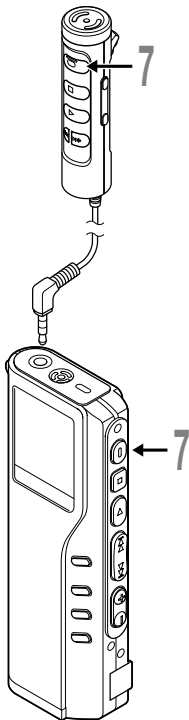

7 Press the REC button to start recording.

When the sound volume is lower than the preset threshold sound level, recording automatically stops after 1 sec approximately, recording automatically pauses after approximately 1 second, and “STANDBY” flashes on the display. The record/play indicator lamp glows when recording starts and flashes when recording pauses.

* When the remote controller is connected, the REC indicator lamp on the remote controller lights up but the record/play indicator lamp on the recorder will be switched off.

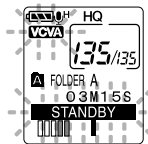

Adjust the start/stop actuation level

Press the FF or REW button to adjust the pause sound level during recording.

The VCVA level can be set to any of 15 different values. The higher the value, the more sensitive the recorder to sounds. At the highest value, even the faintest sound will activate recording.

The VCVA pause sound level can be adjusted according to the ambient (background) noise.

- a Level meter (varies according to the sound volume being recorded)
- b Start level (moves to the right/left according to the set level)

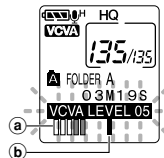

Notes

- The start/stop actuation level also varies depending on the selected microphone sensitivity mode (P.24).
- To ensure successful recordings, prior testing and adjustment of the start/stop actuation level is recommended.



Recording with External Microphone

To enhance sound quality during recording, use the Remote Controller Microphone or an optional external microphone. If a stereo microphone is used, recording in SHQ (Stereo High-Quality) mode is possible. Please note, when a microphone is connected to the jack on the recorder, the jack functional switch-over is made automatically.

2

Recording with External Microphone



1 Make sure that the recorder has stopped.

2 Connect to the jack on the recorder.

If an external microphone is connected to the jack on the recorder, the built-in microphone is disabled.

Applicable external microphones

● **Remote controller microphone: MR12**

MR12 contains a non-directional microphone. With a clip, you can attach the microphone on your jacket's pocket, etc. This microphone is used to record your voice or voices of people close to you.

● **Noise-Cancellation microphone: ME12 (optional) (Dictation microphone)**

This microphone is used to record your own voice while minimizing surrounding noise.

● **Stereo microphone: ME50S (optional)**

When using a stereo microphone, the recorder will switch-over to SHQ mode automatically and recording in WMA format, noise-free sound can be accomplished. Stereo recording is only possible in SHQ mode.

Notes

- Do not insert or remove a microphone into or from the jack while recording.
- If an earphone is connected to the remote controller recording is not possible.
- If an earphone is connected to the remote controller EAR jack while recording, recording will stop automatically.



Recording Modes (REC MODE)

You can select from among three recording modes: HQ (High Quality) mode, SP (Standard Playback) mode and LP (Long Playback) mode.

If an optional stereo microphone is used, the only possible recording mode is SHQ (Stereo High Quality).

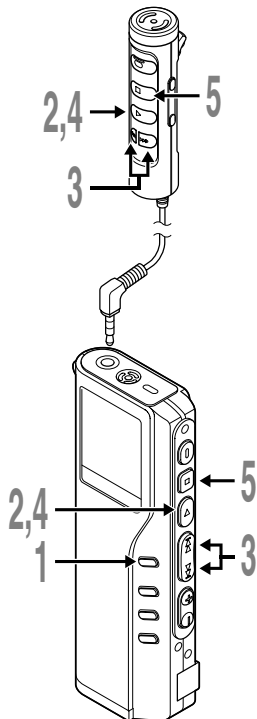

1 Press and hold the MENU button for 1 second or longer.

“REC MODE” will be displayed on the screen (see P.31).

2 Press the PLAY button.

The recording mode setup process begins.

3 Press the FF or REW button to choose from HQ, SP and LP.

4 Press the PLAY button to complete the setup screen.

5 Press the STOP button to close the menu.

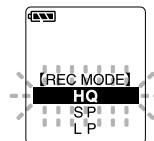
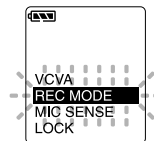

2
Recording Modes (REC MODE)

Note

Choose SHQ/HQ or SP mode for recording meetings or lectures with crisp clarity.



Microphone Sensitivity (MIC SENSE)

Microphone sensitivity is adjustable to meet recording needs.

2

Microphone Sensitivity (MIC SENSE)

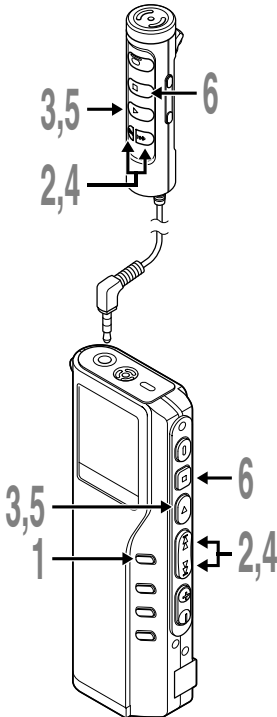

1 Press and hold the **MENU button for 1 second or longer.**

The menu opens (see P.31).

2 Press the **FF or **REW** button until “MIC SENSE” flashes on the display.**

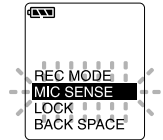

3 Press the **PLAY button.**

The microphone sensitivity setup process begins.

4 Press the **FF or **REW** button to choose between **CONFERENCE** and **DICTATION**.**

CONFERENCE: High-sensitivity mode that records sounds in all directions.

DICTATION: Low-sensitivity mode suited for dictation.



5 Press the **PLAY button to complete the setup screen.**

6 Press the **STOP button to close the menu.**

Notes

- If you want to record clear or noise-free dictation, select **DICTATION** mode and place the microphone 3 to 4 inches from the source.
- If the ambient (background) noise is too loud to get a clear recording even in **DICTATION** mode, we recommend that you use an ME12 single directional microphone (sold separately).



Playing

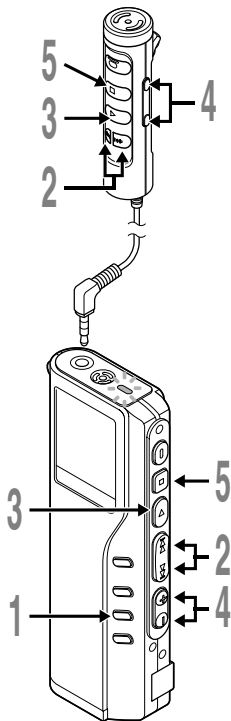

1 Press the FOLDER button to choose folder.

2 Press the FF or REW button to choose the file that you want to play.

If you keep pressing the FF or REW button in stop mode, the recorder continuously skips to the beginnings of files.

3 Press the PLAY button to start playback.

The record/play indicator lamp glows green.

- (a) Current playback time**
- (b) Total recording time of the file being played**

4 Press the VOL (+) or VOL (-) button to select the proper sound volume.

The display shows the volume level. You can choose between 0 to 30.

5 Press the STOP button at any point you want to stop the playback.

Resume playback by pressing PLAY button again.

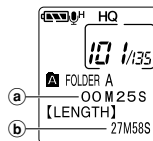
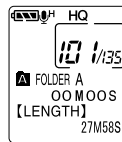

Note

You can listen to audio playback through the earphone connected to the jack on the recorder or the EAR jack on the remote controller.

Playback functions	Operation	How to Cancel
Fast Playback (F.PLAY)	Press the PLAY button once while playing a file.*1 ➤ The recorder plays back at approximately 50% faster than normal rate.	Press the PLAY button 2 times while fast playing back. ➤ Playback returns to normal rate.
Slow Playback (S.PLAY)	Press the PLAY button once while fast playing back.*1 ➤ The recorder plays back at approximately 25% slower than normal rate.	Press the PLAY button once while slow playing back. ➤ Playback returns to normal rate.
Cue (CUE)	Hold the FF button while playing a file. ➤ The recorder stops when it reaches the end of the file. Continue pressing the FF button to proceed with the cue from the beginning of the next file.	Release the FF button. ➤ Replays at the original speed.
Review (REVIEW)	Hold the REW button while playing a file. ➤ The recorder stops when it reaches the beginning of the file. Continue pressing the REW button to proceed with the review from the end of the previous file.	Release the REW button. ➤ Replays at the original speed.
Skipping to beginning of a file*2	Press the FF button during playback, fast playback, or slow playback.*3 ➤ The next file is cued and playback starts at the original speed.	—
	Press the REW button during playback, fast playback, or slow playback.*3 ➤ The file being played is cued and playback starts at the original speed.	—

*1: As in normal playback, operations such as playback stop, file cueing, and index mark (⏏ P.30) insertion are possible in fast playback and slow playback.

*2: If you keep pressing the FF or REW button in stop mode, the recorder continuously skips to the beginnings of files (F.SKIP/B.SKIP).

*3: If an index mark is encountered midway, playback begins at that point.

Note

If you set Noise Cancel to “LOW” or “HIGH”, you cannot use the Fast Playback and Slow Playback functions.



Repeat Playback

This function enables repeated playback of part of the file being played. If the continuous playback function is used together, two or more files can be repeatedly replayed as long as they are in the same folder.

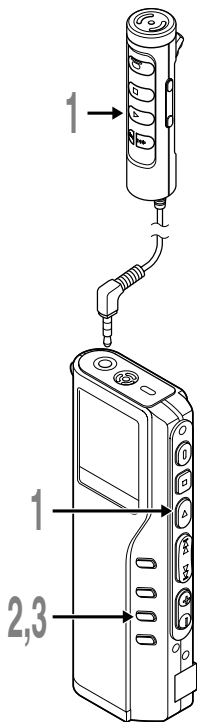

1 Choose the file for Repeat Playback, and press the **PLAY** button.

File playback begins.

2 Press the **REPEAT** button briefly at the point you want to start Repeat Playback.

“REPEAT END?” flashes until you designate the end point.

3 Press the **REPEAT** button briefly again at the position you want Repeat Playback to end.

The recorder repeatedly plays back the section between the start and the end positions until you cancel Repeat Playback.

If continuous playback is set to ON, the end position can be set to the extent of the last file in the folder.

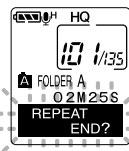

2

Repeat Playback

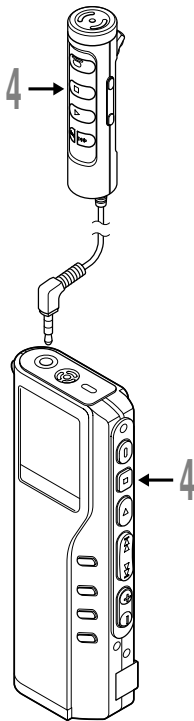

4 Press the **STOP** button.

Repeat Playback is cancelled.

You can use Fast Playback and Slow Playback functions, insert and delete index marks, and use the Noise Cancel function.

Notes

- If no end position is designated, the end of the file becomes automatically the end position. If continuous playback is set to "ON", the end of the last file in the folder is set to the end position and then repeated playback starts.
- If you pass the start or end position by pressing the REW or FF button, Repeat Playback will be cancelled.
- To use this function, briefly press the REPEAT button. If you hold it 1 second or longer, the Moving Files screen appears.



Noise Cancel Function

If recorded audio is difficult to understand because of noise, adjust the Noise Cancel setting level. Noise will be reduced in the file when its played back for better sound quality.

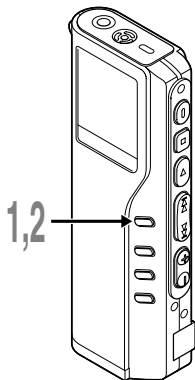

1 Press and hold the MENU button for 1 second or longer while the file is playing.

Displays currently set Noise Cancel level.

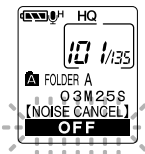

2 Press the MENU button again to choose a noise cancel level.

The levels switch in the following rotation, "OFF" "LOW" "HIGH".

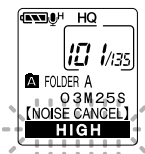

If the display is already set to Noise Cancel, start from step 2.

Change the Noise Cancel level within 8 seconds, otherwise the level is set at the displayed level and the display returns to its original view.

Notes

- If you set it to "LOW" or "HIGH", the display flashes the Noise Cancel level for about 2 seconds when a file is played back.
- If you set Noise Cancel to "LOW" or "HIGH", the setting remains valid until it's set to "OFF".
- If you set Noise Cancel to "LOW" or "HIGH", you cannot use the Fast Playback and Slow Playback functions.
- If Noise Cancel is used for files recorder in SHQ, the files will be played in monaural mode.

2

Noise Cancel Function



Index Marks

Index marks can be placed in a file during recording or playback to provide a quick and easy way of keeping track of important sections in the file.

2

Index Marks

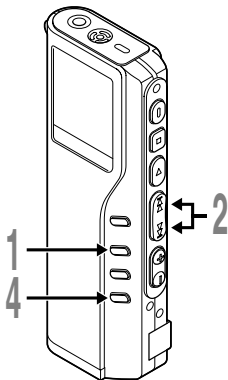

Setting an Index Mark

- 1 Press the **INDEX** button during recording or playback to set an index mark.

An index number appears on the display.

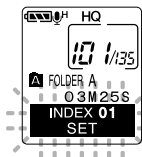

Locating an Index Mark

- 2 Hold the **FF** or **REW** button while playing a file.

The recorder stops for 1 second when it reaches the index mark.

Clearing an Index Mark

- 3 Locate the index mark you want to clear.

- 4 Press the **ERASE** button while the index number appears for approximately 2 seconds on the display.

The index mark is erased.

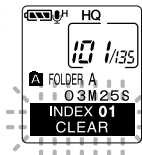

Notes

- Up to 16 index marks can be set in a file. Attempting to set more index marks will cause “INDEX FULL” to appear on the display.
- Index marks cannot be set or cleared in a locked file.
- In case of WMA files, index marks can only be placed in files recorded with Olympus recorders.



Menu List (VOICE mode)

Press and hold the **MENU** button for 1 second or longer.

REC MODE

Selection from HQ, SP and LP modes.

MIC SENSE

Mic sense setting (☞P.24). Selection between CONFERENCE (high-sensitivity mode) and DICTATION (low-sensitivity mode).

LOCK

Locking files setting. Selection between ON (locked) and OFF (unlocked).

BACK SPACE

Back space setting. Selection from OFF, 1 SEC SKIP and 2 SEC SKIP.

ALL PLAY

Continuous playback setting. Selection between ON (enabled) and OFF (disabled).

TIME&DATE

Time/Date setting. In order of hour, minute, year, month and day (☞P.12).

FORMAT

Recorder formatting.

CONTRAST

LCD contrast adjustment. Adjust the level from 1 to 12.

BEEP

System sounds setting. Selection between ON (enabled) and OFF (disabled).

BACKLIGHT

Backlight setting. Selection between ON (enabled) and OFF (disabled).

EXT.INPUT

EXT.INPUT setting. Selection from AUTO SELECT, STEREO INPUT and MONAURAL INPUT.

COMMENT

Assigning file comments.

FOLDER NAME

Folder naming.

ALARM

Alarm playback setting. Selection between ON (enabled) and OFF (disabled).

VCVA

VCVA setting (☞P.20). Switch between ON (enabled) and OFF (disabled).



Press the **FF** button or **REW** button.

Notes

- Part of the menu is common with the MUSIC mode.
- If you press the **STOP** button or the **REC** button, during a menu setup operation, the recorder will stop and apply the items that were set to that point.
- The recorder will stop if you leave it idle for 3 minutes during a menu setup operation, when a selected item is not applied.

Using DSS Player Software

The DSS Player Software can be used to do the following:

- Playback voice files on your PC and on the recorder when connected via USB. Download files from the recorder to the PC or upload files from the PC to the recorder.
- Change the order of the music files stored in the recorder.

3

Precautions on using the recorder connected to a PC

- When you are downloading a file from the recorder or uploading a file to the recorder, do not remove the USB cable even if the screen is indicating you can. Data is still being transferred while the record/play indicator lamp is blinking. When removing the USB cable, be sure to follow the description in  P35. If the USB cable is removed before the drive is stopped, data may not be successfully transferred.
- On a PC, do not format the drive of the recorder. Initialization is not successfully achieved on a PC. For initialization, follow the instructions in the menu screen of the recorder.
- Folder (directory) names displayed by file management tools such as Explorer attached to Microsoft Windows and Finder attached to Mac OS are different from the folder names settable with the recorder or DSS player.
- If folders or files stored on the recorder are moved or renamed by using a file management tool such as Explorer or Finder, the order of files may be changed or files may become unrecognizable.
- Data can be written or uploaded to the recorder even though the attribute of the recorder drive is shown as Read-only by the operating system of the PC.
- As the noise may cause adverse effects on electronics devices nearby the recorder, unplug the earphone and remote controller when you connect the recorder to a PC.

Using Online Help

To open Online Help, you have the following options.

(Windows)

- Click the [Start] button, select [All Programs], then [Olympus DSS Player 2002], then click [Help].
- While DSS Player is running, choose [Contents] from the [Help] menu.
- While DSS Player is running, press [F1] on the keyboard.

(Macintosh)

- While DSS Player is running, choose [DSS Player for Mac Help] from the [Help] menu.

Search by Contents

1 Once the Online Help screen appears, click the Contents tab.

2 Double-click the  icon of the desired topic heading.

The title of the topic is displayed.

3 Double-click the  icon of the desired topic.

An explanation of the topic is displayed.



Search by Key word

1 Once the Online Help screen appears, click the Index tab.

2 Enter text.

Matching keywords are located automatically.

3 Choose a topic, then click [Display].

An explanation of the topic is displayed.

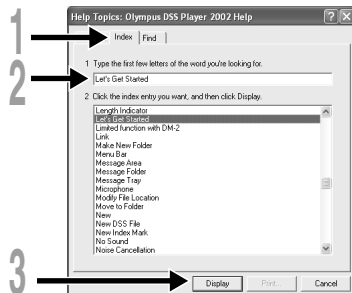

Note

For more information on menus and operations, refer to Online Help. You will be able to use Online Help after DSS Player is installed.

Connecting to Your PC

Be sure to finish installing DSS Player before connecting the recorder.

3

Connecting to Your PC

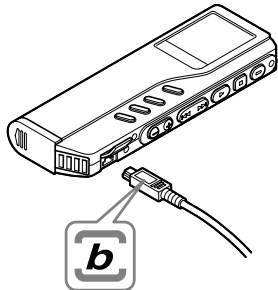
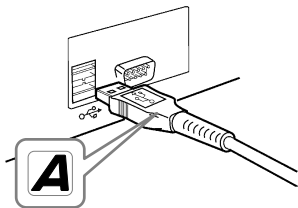

Connecting to your PC using the USB cable

- 1 Release the **HOLD** switch.
- 2 Insert end A of the USB cable to your PC's USB port or USB hub.
- 3 Confirm that the recorder is not in use before attaching end b of the USB cable to the terminal port of the recorder.

"REMOTE" is displayed on recorder if the USB cable is connected.

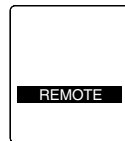

Windows

When the recorder is connected and "My Computer" is opened, a removable disk drive is displayed. If "Add New Hardware Wizard" appears, cancel the wizard by pressing the [Cancel] button and then install DSS Player.



Macintosh

If the recorder is connected to Mac OS, an icon with a drive name of "unlabeled" appears.

Disconnecting from Your PC

Windows 98/98 SE

- 1 Confirm that the record/play indicator lamp on the recorder is not flashing. Right-click the Removable Disk icon in My Computer and select [Eject].
- 2 Disconnect the USB cable.

Windows Me/2000/XP

- 1 Click the  on the task bar located at the lower-right corner of the screen. Click [Safely remove USB Mass Storage Device-Drive].

It will read [Stop USB Disk-Drive] for Windows Me. The drive letter will differ depending on the computer being used.

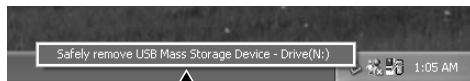

- 2 When the Safe To Remove Hardware window appears, click [OK].
- 3 Disconnect the USB cable.

3

Connecting to Your PC

Macintosh

- 1 Move the icon of the recorder's drive displayed on desktop to trash box by drag and drop.
- 2 Disconnect the USB cable.

3

Notes

- NEVER disconnect the USB cable while the record/play indicator lamp is flashing. If you do, the data will be destroyed.
- Refer to the user's manual for your PC regarding the USB port or USB hub on your PC.
- Be sure that you connect the USB cable either directly to the USB port on your PC or the self-power (AC adapter connection) USB hub.
- Be sure to push the cable connector all the way in. Otherwise, the recorder may not operate properly.
- Release the HOLD switch.

Connecting to your PC using the cradle

Place the recorder on the cradle

- 1 Insert end A of the USB cable to your PC's USB port or USB hub.
- 2 Connect the end b of the USB cable to the cradle.
- 3 Make sure that the recorder is off, and place it in the cradle.
 - ① Set the recorder vertically.

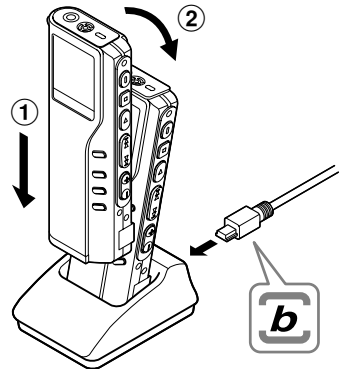

- ② While pushing down the top of the recorder, set the recorder on the cradle. In this case, make sure that concavity on the rear of the recorder fits convexity of the cradle.

“REMOTE” is displayed on recorder if the USB cable is connected.

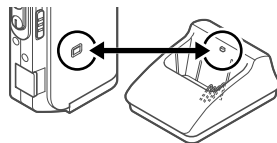

Remove the recorder from the cradle

Follow step 1 in “Disconnecting from Your PC” (P.35).

- 1 Make sure that the recorder's record/play indicator lamp isn't flashing, and remove the recorder from the cradle.**

Hold the cradle with your hand, and raise the recorder from the top end to remove it from the hook, as shown in the illustration.

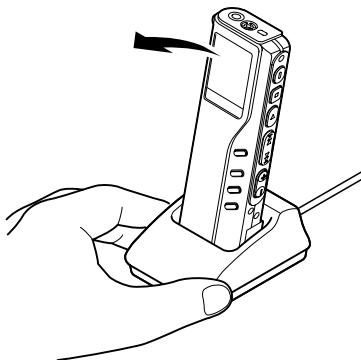

Notes

- Do not touch the connection point on the front of the cradle (at the low end), as that may cause bad connection.
- The cradle does not have the recharging function.

Running DSS Player

Windows

By connecting the recorder to your PC, you can automatically start the application.

Disabling automatic start

1 Right click the  icon in the System Tray in the lower right-hand corner of the screen, then click **Select startup application**.

2 **Select and click [DSS Player 2002].**

The check mark on [DSS Player 2002] disappears. For automatic start, select and click DSS Player to reinstate again.

Manual start

1 **Start Windows.**

2 **Click the [Start] button, select [All Programs], then [Olympus DSS Player 2002].**

3 **Click [Olympus DSS Player 2002].**

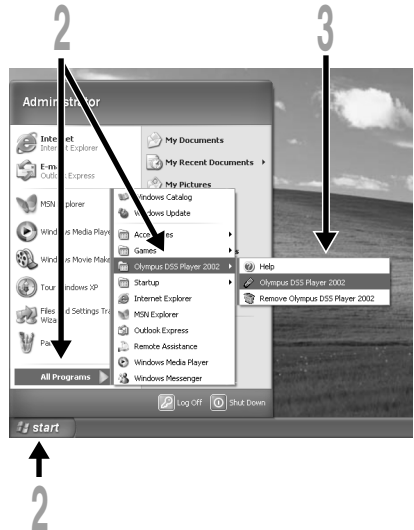

Notes

- You can not run more than one DSS Player program or multiple copies of the same program simultaneously.
- If you connect the recorder before installing DSS Player, the "Add New Hardware Wizard" dialog box will open. If this happens, click [Cancel] to exit the wizard, then install DSS Player.

Macintosh

To start, open the “DSS Player for Mac” folder created upon installation and double-click the icon.

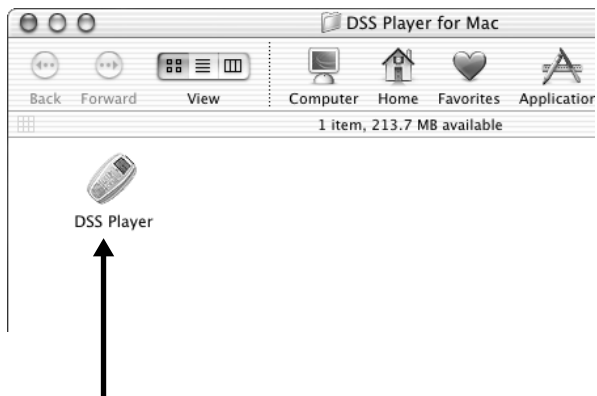

Note

DSS Player for Mac does not have the automatic start function.

Using the Recorder as a Music Player

The recorder supports music files in MP3 and WMA formats, which can be transferred from the PC to the corresponding music folder of the recorder.

Using Windows Media Player

Windows

By using Windows Media Player, music files from music CDs can be converted (ripped) (see P.43) and music files that you bought from any music distribution sites can be easily transferred to the recorder (see P.44).

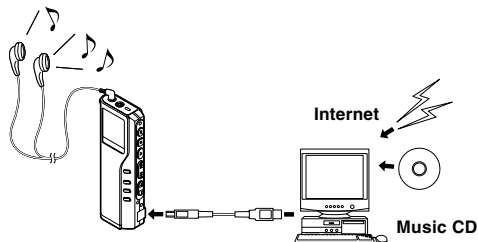

Macintosh

Windows Media Player included with the recorder is for Windows only. Please use your favorite application software according to your use.

Copyright and copyright protection feature (DRM)

By the Copyright Act, any voice/music files and music CDs downloaded from the Internet without the copyright holder's permission may not be reproduced, distributed, publicized/re-publicized on the Internet, or converted into MP3 or WMA files for the purpose of commercial business or sale.

A WMA file may be provided with DRM (Digital Right Management) for copyright protection. DRM limits the file to copy or distribute music files that are converted (ripped) from a music CD or downloaded from music distribution services. To transfer a WMA file with DRM to the recorder, you need to use appropriate methods such as Windows Media Player. Copying the music files with DRM purchased from online music distribution service to a portable device such as this recorder may be restricted.

Windows Media Audio License and Distribution Agreement

- You have acquired an item ("DM-20/10") that includes software licensed by OLYMPUS from Microsoft Licensing Inc. or its affiliates ("MS"). Those installed software products of MS origin, as well as associated media, printed materials, and "online" or electronic documentation ("SOFTWARE") are protected by copyright laws and international copyright treaties, as well as other intellectual property laws and treaties. The SOFTWARE is licensed, not sold.

* [Approved alternative text if OLYMPUS does not mention MS in the EULA text: "You have acquired an item("DM-20/10") which includes software licensed by OLYMPUS from one or more software licensors ("OLYMPUS's Software Suppliers"). Such software products, as well as associated media, printed materials, and "online" or electronic documentation ("SOFTWARE") are protected by copyright laws and international copyright treaties, as well as other intellectual property laws and treaties."]

- IF YOU DO NOT AGREE TO THIS END USER LICENSE AGREEMENT ("EULA"), DO NOT USE THE DM-20/10 OR COPY THE SOFTWARE. INSTEAD, PROMPTLY CONTACT OLYMPUS FOR INSTRUCTIONS ON RETURN OF THE UNUSED DM-20/10(S) FOR A REFUND. ANY USE OF THE SOFTWARE, INCLUDING BUT NOT LIMITED TO USE ON THE DM-20/10, WILL CONSTITUTE YOUR AGREEMENT TO THIS EULA (OR RATIFICATION OF ANY PREVIOUS CONSENT).
- GRANT OF LICENSE. The SOFTWARE is licensed, not sold. This EULA grants you the following rights to the SOFTWARE:
 - You may use the SOFTWARE only on the "DM-20/10".
 - NOT FAULT TOLERANT. THE SOFTWARE IS NOT FAULT TOLERANT. [OLYMPUS] HAS INDEPENDENTLY DETERMINED HOW TO USE THE SOFTWARE IN THE "DM-20/10", AND MS HAS RELIED UPON [OLYMPUS] TO CONDUCT SUFFICIENT TESTING TO DETERMINE THAT THE SOFTWARE IS SUITABLE FOR SUCH USE.
 - NO WARRANTIES FOR THE SOFTWARE. THE SOFTWARE is provided "ASIS" and with all faults. THE ENTIRE RISK AS TO SATISFACTORY QUALITY, PERFORMANCE, ACCURACY, AND EFFORT (INCLUDING LACK OF NEGLIGENCE) IS WITH YOU. ALSO, THERE IS NO WARRANTY AGAINST INTERFERENCE WITH YOUR ENJOYMENT OF THE SOFTWARE OR AGAINST INFRINGEMENT. IF YOU HAVE RECEIVED ANY WARRANTIES REGARDING THE "DM-20/10" OR THE SOFTWARE, THOSE WARRANTIES DO NOT ORIGINATE FROM, AND ARE NOT BINDING ON, MS.
 - Note on Java Support. The SOFTWARE may contain support for programs written in Java. Java technology is not fault tolerant and is not designed, manufactured, or intended for use or resale as online control equipment in hazardous environments requiring fail-safe performance, such as in the operation of nuclear facilities, aircraft navigation or communication systems, air traffic control, direct life support machines, or weapons systems, in which the failure of Java technology could lead directly to death, personal injury, or severe physical or environmental damage. Sun Microsystems, Inc. has contractually obligated MS to make this disclaimer.
 - No Liability for Certain Damages. EXCEPT AS PROHIBITED BY LAW, MS SHALL HAVE NO LIABILITY FOR ANY INDIRECT, SPECIAL CONSEQUENTIAL OR INCIDENTAL DAMAGES ARISING FROM OR IN CONNECTION WITH THE USE OR PERFORMANCE OF THE SOFTWARE. THIS LIMITATION SHALL APPLY EVEN IF ANY REMEDY FAILS OF ITS ESSENTIAL PURPOSE...
 - Limitations on Reverse Engineering, Decompilation, and Disassembly. You may not reverse engineer, decompile, or disassemble the SOFTWARE, except and only to the extent that such activity is expressly permitted by applicable law not withstanding this limitation.
 - SOFTWARE TRANSFER ALLOWED BUT WITH RESTRICTIONS. You may permanently transfer rights under this EULA only as part of a permanent sale or transfer of the "DM-20/10", and only if the recipient agrees to this EULA. If the SOFTWARE is an upgrade, any transfer must also include all prior versions of the SOFTWARE.
 - EXPORT RESTRICTIONS. You acknowledge that the SOFTWARE, or any part thereof, or any process or service that is the direct product of the SOFTWARE(the foregoing collectively referred to as the "Restricted Components") are of U.S. origin. You agree to comply with all applicable international and national laws that apply to these products, including the U.S. Export Administration Regulations, as well as end-user, end-user and destination restrictions issued by U.S. and other governments. For additional information on exporting Microsoft products, see <http://www.Microsoft.com/exporting/>.

Window Names (Windows Media Player)

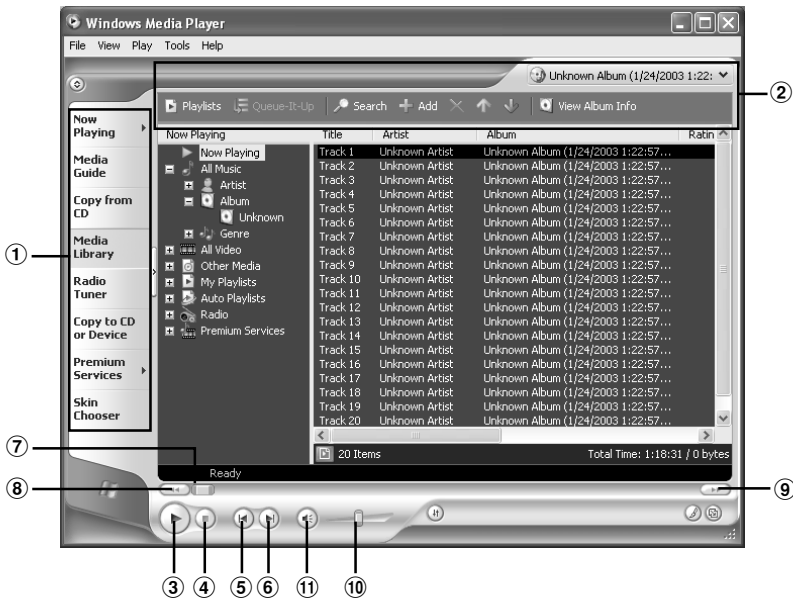

- ① Features taskbar
- ② Quick Access box
- ③ Play button
- ④ Stop button

- ⑤ Previous button
- ⑥ Next button
- ⑦ Seek slider
- ⑧ Rewind button

- ⑨ FastForward button
- ⑩ Volume slider
- ⑪ Mute button

4

Window Names (Windows Media Player)

Copying Music from CD

Windows

1 Insert CD into the CD-ROM drive and start Windows Media Player.

2 From the Features taskbar, click the [Copy from CD] menu.

3 Click [Find Album Info] of Quick Access box.

If Internet connectivity is available, CD information is searched.

4 Put a check mark on the music file that you want to copy.

5 Click [Copy Music] of Quick Access box.

Files copied to a PC are stored in WMA format. Music files copied are categorized by artist, album, genre, etc. and added to the play list.

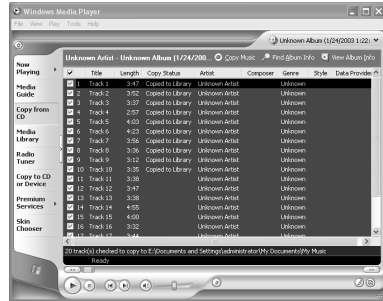

4

Copying Music from CD



Music Playback

The recorder has 2 music folders; music A and music B, to store music files transferred from a PC. 2 folders can be conveniently used depending on the genre of music files.

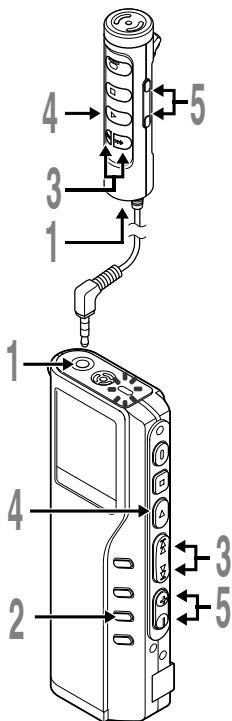

1 Insert the stereo earphone or remote controller into the jack on the recorder.

If a remote controller is used, insert the earphone into the EAR jack.

2 Press the **FOLDER** button to choose a folder.

3 Press the **FF** or **REW** button to choose the music file that you want to play.

The filename and the length of the music track will be displayed.

If you hold the FF or REW, files are skipped continuously.

(a) File being selected

(b) Length of the file being selected

4 Press the **PLAY** button to start playback.

The record/play indicator lamp will flash in green, and the title and artist name will scroll on the left side of the screen.

(c) Title and artist name of the file being played

(d) Play time of the file being played

5 Press the **VOL (+)** or **VOL (-)** button to select the proper sound volume.

The display shows the volume level. You can choose between 0 to 30.

The next track will automatically start once the track being played is finished.

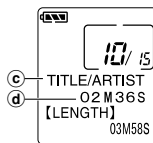
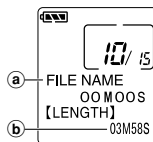

4

Music Playback

Notes

- The proper bit rate for playback on the recorder are 32 kbps to 160 kbps for both the MP3 and WMA format.
- It is possible to play back files with different bit rates (converting the bit rate within one file); however, the displayed time may not be accurate.
- When using the earphones, do NOT set the volume too high. Listening at very high volume may lead to hearing loss.
- It is possible to listen to music without the earphones, using the internal speakers; however, the sound will be in mono, not stereo.
- Up to 40 characters per track can be used to list title and artist name.

Playback Functions

Skip a Music File While Playing It

Press the **FF** button while playing a music file.

- ➡ The recorder skips to the beginning of the next track and starts playing it.

Press the **REW** button while playing a music file.

- ➡ The recorder skips to the beginning of the current track and starts playing it.

Fast Forward

Hold the **FF** button while playing a music file.

- ➡ Will fast-forward to the end of the track and stop at the beginning of the next track.

Canceling Fast Forward

Release the **FF** button where you want the music file played.

- ➡ Playback begins.

Fast Rewind

Hold the **REW** button while playing a music file.

- ➡ Will rewind to the beginning of the current track and resume playback.

Canceling Fast Rewind

Release the **REW** button where you want the music file played.

- ➡ Playback begins.

Canceling Playback

Press the **PLAY** or **STOP** button.

- ➡ Will stop playing the current track.

Various Playback Features

Equalizer

The equalizer mode is selected in the following order each time the **EQ** (equalizer) button is pressed.

→ FLAT → ROCK → POP → JAZZ → USER



You can set/create your own equalizer preferences using the user equalizer (USER EQ) function.

- If no action is taken within 2 seconds after the EQ button is pressed, the display will revert to the normal indication.

Repeat and Random Play

The play mode is switched in the following order each time the **REPEAT** button is pressed more than 1 second with playback stopped or is pressed during playback.

→ Normal play → Single music repeat play → All music repeat play
← Random play ← Random repeat play

Function	Explanation	Display indicator
Normal play	Will stop after all the tracks been played.	No indication
Single music repeat play	Will play one track repeatedly.	
All music repeat play	Will play all the tracks from first to last continuously.	
Random repeat play	Will continuously play all the tracks in random order.	
Random play	Will stop after all the tracks have been played in random order.	RANDOM



Increasing the WOW effect (WOW EFFECT)

The recorder has WOW, an audio processing technology that increases sound clarity and bass quality. The level of the surround effect (SRS 3D) and the bass effect (TruBass) may be individually adjusted through three levels of processing or turned off.

Surround effect (SRS 3D): Increases the sound-expansion effect and sound clarity.

Bass effect (TruBass): Enriches the low sounds.

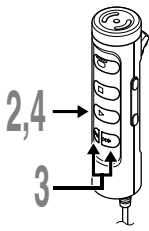

- 1 Press and hold the MENU button for 1 second or longer.**

"WOW EFFECT" will be displayed on the screen (P.50).



- 2 Press the PLAY button.**

The surround effect setup process begins (SRS 3D).

- 3 Press the FF or REW button to select the surround effect level.**

The levels switch in the following rotation, "OFF" "LOW" "MIDDLE" "HIGH".

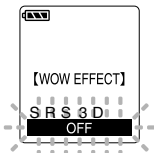

- 4 Press the PLAY button to register your setting.**

The bass effect setup process begins (TruBass).

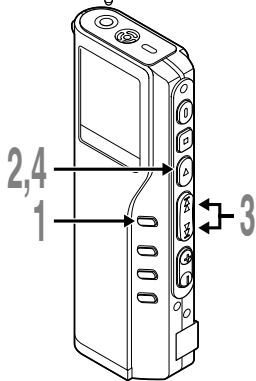

4

Increasing the WOW effect (WOW EFFECT)

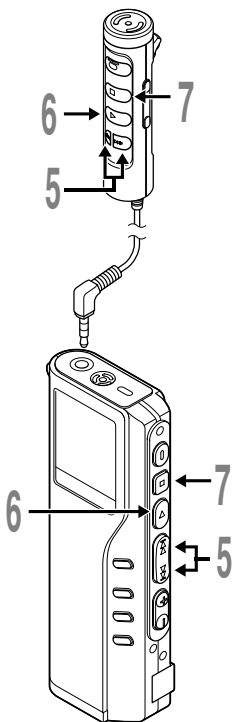

5 Press the **FF** or **REW** button to select the bass effect level.

The levels switch in the following rotation, “OFF” “LOW” “MIDDLE” “HIGH”.

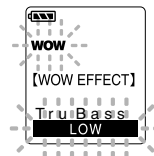

6 Press the **PLAY** button to save your setting.

7 Press the **STOP** button to close the menu.

If you wish to set other menus, press and hold the **PLAY** button for more than 1 second without pressing the **STOP** button.

If you want to change the WOW level while listening to sound, press the **MENU** button for at least 1 second during playback and then start procedure from step 3.

Notes

- Both the surround effect and bass effect are OFF as the WOW default settings.
- If there is no action taken within 8 seconds during the WOW settings during playback, the recorder will revert to normal play.
- “**WOW**” will be displayed on the screen if the surround effect or the bass effect is set.
- The WOW effect will be weakened if the bit rate for any music file is less than 32 kbps.
- Depending on the song, the WOW effect will be heightened, and may sound like noise. If this happens, adjust the WOW effect.



Menu List (MUSIC mode)

Press and hold the **MENU** button for 1 second or longer.

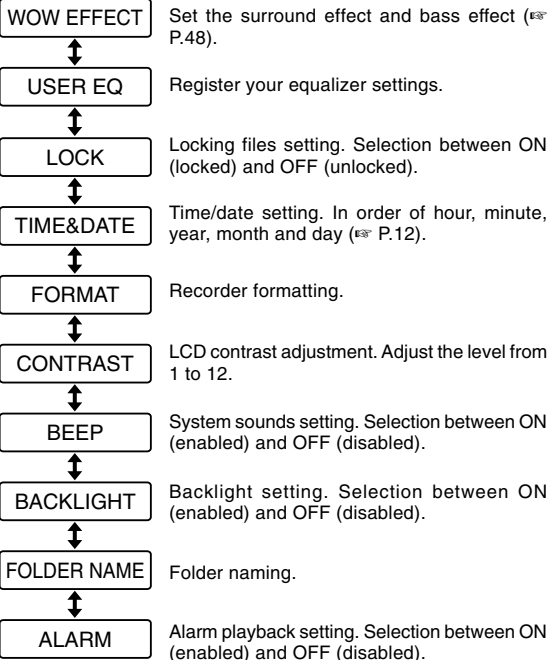

Press the **FF** button or **REW** button.

Notes

- Part of the menu is common with the VOICE mode.
- If you press the **STOP** button or the **REC** button, during a menu setup operation, the recorder will stop and apply the items that were set to that point.
- The recorder will stop if you leave it idle for 3 minutes during a menu setup operation, when a selected item is not applied.

4

Menu List (MUSIC mode)



Erasing

Erasing One File at a Time

A selected file can be erased from a folder.

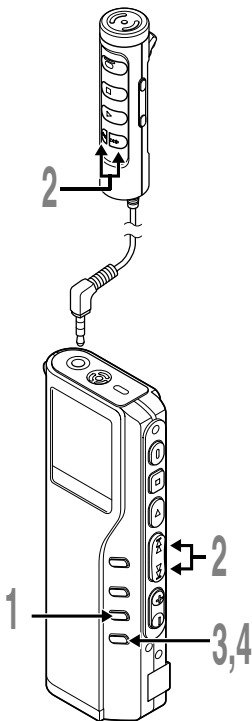

1 Press the **FOLDER** button to choose a folder.

2 Press the **FF** or **REW** button to choose the file you want to erase.

a File to be erased

3 Press the **ERASE** button.
"FILE ERASE?" flashes on the display for approximately 8 seconds.

4 Press the **ERASE** button once more when "FILE ERASE?" is flashing.
The display changes to "FILE ERASE!" and erasing will start.

"ERASE DONE" is displayed when the file is erased. File numbers will be reassigned automatically.



a

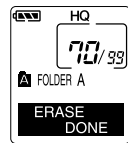
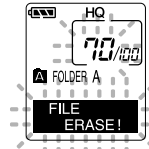
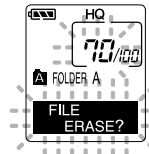

5
Erasing

Erase All Files from a Folder

All files in a folder can be erased simultaneously, except for locked files.

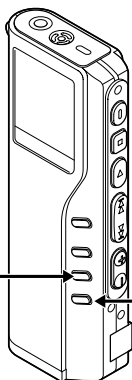

5

Erasing

- 1 Press the **FOLDER** button to choose the folder you want to erase all files.

Ⓐ Folder from which to erase files

- 2 Press the **ERASE** button for 3 seconds or longer.

“ALL ERASE?” flashes on the display for approximately 8 seconds.

- 3 Press the **ERASE** button once more when “ALL ERASE?” is flashing.

The display changes to “ALL ERASE!” and erasing will start.

“ERASE DONE” is displayed when the files are erased. Locked files are reassigned file numbers in ascending order.

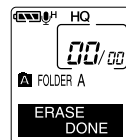
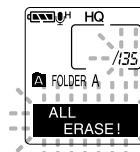
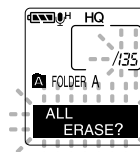
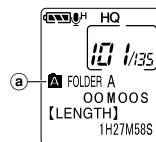

Notes

- An erased file cannot be restored.
- If the ERASE button is not pressed within the 8 seconds after “FILE ERASE?” or “ALL ERASE?” starts flashing, the recorder will revert to stop status.
- Completion of erasing may take 10 seconds. Never do anything during this period because data may be corrupted. Battery removal and AC adapter setting/removal are not permissible, whether or not the battery is set in the recorder.

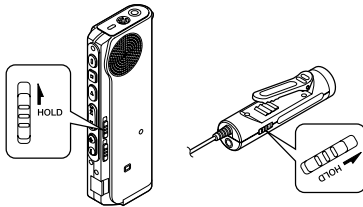

Setting the HOLD switch to the HOLD position. If you set the recorder to HOLD status by sliding the HOLD switch in the direction of the arrow, the current conditions will be preserved, and all buttons and switches except the HOLD switch will be disabled. This feature is useful when the recorder has to be carried in a bag or pocket. **Remember to reset the HOLD switch when using the recorder.**

Running state when HOLD is set

1: State of the recorder, 2: HOLD of the recorder, 3: HOLD of the remote controller, 4: Button operation on the recorder, 5: Button operation on remote controller

	1	2	3	4	5
5 Hold STOPS	On	Not connected		The display goes out after "HOLD" blinks for 2 seconds.*1	_____
	On	Off		The display goes out after "HOLD" blinks for 2 seconds.*1	Normal operation. If the recorder stops after button operation, the display goes out 20 seconds later.
	Off	On		Normal operation	Button operation on the remote controller is invalid.
Running	On	Not connected		If HOLD is applied during playback (recording), operation is disabled with the playback (recording) state unchanged.*2	_____
	On	Off		If HOLD is applied during playback (recording), operation is disabled with the playback (recording) state unchanged.*2	Normal operation. If the recorder stops after button operation, the display goes out 20 seconds later.
	Off	On		Normal operation	Button operation on the remote controller is invalid. However, the REC lamp is lit while the recorder is recording.

*1: Pressing any button makes clock display blink for 2 seconds but the recorder does not start.

*2: The recorder stops when playback completes or recording terminates due to no memory space.

Note

The alarm will sound at the scheduled time even if the recorder is set to hold. The recorder begins to play the file associated with the alarm when you press any button.

Using the Recorder as a Reader/Writer

With the recorder connected to your PC, you can download data from the memory to your PC and upload data stored on your PC to the memory.

- You will need to install the Olympus DSS Player Software if you are using Windows 98/ 98SE.

Example: Copying Data from PC to Recorder using Explorer or Finder

1 Start Windows.

2 Connecting the recorder to your PC.

For the connection procedure, refer to “Connecting to Your PC using the USB cable” (P.34).

3 Open the Explorer or Finder window.

The recorder will appear as a removable drive icon.

4 Copy the data.

While the data are being written or copied, the record/play indicator lamp on the recorder will flash.

Before disconnecting the recorder from your PC, refer to “Disconnecting from Your PC” (P.35).

.....

Note

NEVER disconnect the USB cable while the record/play indicator lamp is flashing. If you do, the data will be destroyed.

Alarm Message List

Message	Meaning	Explanation	Action
BATTERY LOW	Low battery power	Battery power is getting low.	Replace with new batteries (☞ P.10).
LOCK ON	Erase-locked	Tried to delete a locked file.	Unlock the file.
INDEX FULL	Index full	The file is full of index marks (maximum of 16 marks).	Erase index marks that are no longer required (☞ P.30).
INDEX CAN'T BE ENTERED	File not supporting index	Tried to incorporate WMA file index marks into the music files or the files not recorded with the recorder.	You can incorporate index marks into the voice files recorded with the recorder or IC recorders from Olympus only.
FOLDER FULL	Folder full	The folder is full of files (maximum of 199 files).	Erase unnecessary files (☞ P.51).
	Maximum number	The destination folder already has the maximum number of files (199).	Erase unnecessary files (☞ P.51).
OVER-FLOW	Too many characters input	Exceeds the maximum number of characters that can be registered.	Reduce the number of characters within the limit. Up to 12 characters can be used for a folder name. Up to 100 characters can be used for a file comment.
COMMENT CAN'T BE ENTERED	File not supporting comment	Tried to incorporate comments into WMA files.	You can incorporate comments into the voice files recorded with the recorder or IC recorders from Olympus only.
MEMORY ERROR	Error in the internal flash memory	Error in the internal memory.	This is a malfunction, so go to the store where you purchased the recorder or an Olympus service station for repair.
LICENCE MISMATCH	Illegally copied file	The music files copied illegally.	Delete the file (☞ P.51).
MEMORY FULL	Zero remaining memory	No remaining internal memory.	Erase unnecessary files (☞ P.51).

Message	Meaning	Explanation	Action
NO FILE	No file	No files were found in the folder.	Select another folder.
FORMAT ERROR	Formatting error	There was an error while formatting the recorder's memory.	Reformat the memory.
SAME FILE	Same named file	Tried to create or store a file that has same name as a file in the folder.	Change the file name.
SYSTEM ERROR	System error	System error detected in the recorder.	This is a malfunction. Contact the place of purchase or Olympus Service Center for repair.

Troubleshooting

Symptom	Probable cause	Action
Nothing appears on the display	The batteries are not loaded properly.	Verify polarity is correct.
	The batteries are dead.	Replace with new batteries (☞ P.10).
	The recorder is in HOLD mode.	Release the recorder from HOLD (☞ P.54).
Won't start	The recorder is in HOLD mode.	Release the recorder from HOLD (☞ P.54).
	The batteries are dead.	Replace with new batteries (☞ P.10).
Unable to record	Low remaining internal flash memory.	Erase unnecessary files (☞ P.51).
	The maximum number of files has been reached.	Check another folder.
	MUSIC mode is active.	Switch to VOICE mode (☞ P.11).
No playback tone heard	The earphone is connected.	Unplug the earphones to use the internal speaker.
	The VOLUME button is set to 0.	Adjust the VOLUME button.
Unable to erase	The file is locked.	Unlock the file.
Noise heard during playback	The recorder was shaken during recording.	—
	The recorder was placed near a cell phone or fluorescent lamp while recording or during playback.	Move the recorder.
Recording level too low	The microphone sensitivity is too low.	Set the microphone sensitivity to CONFERENCE mode and try again (☞ P.24).
Unable to set index marks	The maximum number of index marks (16) has been reached.	Erase unnecessary index marks (☞ P.30).
	The file is locked.	Unlock the file.
Won't work with AC adapter	A non-standard AC adapter is being used.	Use the Olympus A321 (for US, Canada) or A322 (for Europe except U.K) AC adapter (Optional).
Cannot find the downloaded file	The destination folder for downloading was other than the music A folder.	Copy the music file into the music A folder.
	VOICE mode is active.	Switch to MUSIC mode (☞ P.11).
Cannot find the recorded voice	MUSIC mode is active.	Switch to VOICE mode (☞ P.11).
	Wrong folder.	Switch to the right folder.

Accessories (optional)

Stereo Microphone: ME50S

To create stereo recordings in WMA format with clear sound and reduced noise.

Noise-Cancellation microphone: ME12

(Dictation microphone)

Used to get crisp recordings of your own voice by reducing the effects of ambient noise.

AC adapter: A321 (US and Canada) or A322 (Europe except U.K.)

Ni-MH Rechargeable Battery Charger: BU-400

Charger for AA batteries (1 to 4) or 1 to 2 AAA batteries.

Ni-MH Rechargeable Battery: BR401

High-efficiency rechargeable long life batteries.

Connecting cord: KA232*

Use to connect the microphone jack of this unit to a radio or other sound source.

Plug adapter: PA3

A mini plug adapter to connect 2.5 mm mini-plug devices such as microphone to the recorder 3.5 mm mini-jack.

* Use this accessory with the PA3 plug adapter.

Specifications

For the Digital Voice Recorder

Recording format

DSS (Digital Speech Standard)
WMA (Windows Media Audio)

Input level -70 dBv

Sampling frequency

SHQ mode: 44.1 kHz
HQ mode: 44.1 kHz
SP mode: 12 kHz
LP mode: 8 kHz

Overall frequency response

SHQ mode: 300 to 8,000 Hz
HQ mode: 300 to 7,000 Hz
SP mode: 300 to 5,000 Hz
LP mode: 300 to 3,000 Hz

Recording time

DM-20 (128 MB)

SHQ mode: 4 hours 20 minutes
HQ mode: 8 hours 45 minutes
SP mode: 20 hours 55 minutes
LP mode: 44 hours 45 minutes

DM-10 (64 MB)

SHQ mode: 2 hours 10 minutes
HQ mode: 4 hours 20 minutes
SP mode: 10 hours 25 minutes
LP mode: 22 hours 20 minutes

Alkaline battery life

Recording: Approx. 16 hours
Playback: Approx. 9 hours

Ni-MH Rechargeable Battery life

Recording: Approx. 12 hours
Playback: Approx. 8 hours

For the Digital Music Player

Compatible data format

WMA, MP3 format

Sampling frequency

44.1 kHz

Frequency band

20 to 20,000 Hz

Playback time

DM-20 (128 MB)

100 to 340 minutes

DM-10 (64 MB)

50 to 170 minutes

(Time may vary depending on the bit rate of the music data.)

Maximum headphone output

5mW + 5mW (at load of 32 Ω)

Alkaline battery life

Approx. 10 hours

Ni-MH Rechargeable Battery life

Approx. 8 hours

Common specifications

Recording medium

Built-in flash memory

128 MB (DM-20)

64 MB (DM-10)

Speaker

Built-in \varnothing 23 mm round dynamic speaker

MIC/EAR/REMOTE jack

\varnothing 3.5 mm mini-jack, impedance MIC 2k Ω ,
EAR 8 Ω or more

Maximum working output (3 V DC)

180 mW or more (8 Ω speaker)

Input power requirement

Rated voltage: 3 V

Batteries: Two AAA Alkaline batteries
(LR03 or R03) or Two Ni-MH
rechargeable batteries

External power supply: AC adapter

External dimensions

109.5 x 39.5 x 15 mm

(without protrusions)

Weight

85 g (including alkaline batteries)

* Specifications and design are subject to change without notice.

* Battery life is measured by Olympus. It varies greatly according to the type of batteries used and the conditions of use.

Technical Assistance And Support

The following are contact information for technical support for Olympus recorders and software only.

◆ Technical Hotline Number in the U.S. and Canada

1-888-553-4448

◆ User Support E-mail address in the U.S. and Canada

distec@olympus.com

◆ Technical Hotline Number in Europe

Toll free number

00800 67 10 83 00

available for Austria, Belgium, Denmark, Finland, France, Germany, Italy, Luxemburg, Netherlands, Norway, Portugal, Spain, Sweden, Switzerland, United Kingdom

Charged numbers for the Rest of Europe

+49 180 567 1083

+49 40 23773 899

◆ User Support E-mail address in Europe

dss.support@olympus-europa.com

Free Manuals Download Website

<http://myh66.com>

<http://usermanuals.us>

<http://www.somanuals.com>

<http://www.4manuals.cc>

<http://www.manual-lib.com>

<http://www.404manual.com>

<http://www.luxmanual.com>

<http://aubethermostatmanual.com>

Golf course search by state

<http://golfingnear.com>

Email search by domain

<http://emailbydomain.com>

Auto manuals search

<http://auto.somanuals.com>

TV manuals search

<http://tv.somanuals.com>