



**SurePOS 100
IBM 4613 Point of Sale Terminal
Technical Reference**

Version 1.0
Dec 31, 2007

Please note that all of the features, functions, etc. defined in this document are subject to change without notice. Not all models, features, etc. are announced in all countries, and references in this document are not an indication that IBM will support these items in the future in every country. Consult with your IBM sales professional for assistance in identifying what is available in your country.

(c) Copyright International Business Machines Corporation 2001. All rights reserved.

Change History

Version	Date	Change Description
1.0		Initial Release

Table of Contents

1.0	Introduction	5
1.1	Overview	5
1.2	Related Documents	6
2.0	The SurePOS 100 Mechanical Package	8
2.1	Dimensions	8
2.2	Controls & Indicators	8
2.2.1	Special Tools for Service	9
3.0	Comparison with SureOne	10
3.1.1	Device Comparison with SureOne	10
4.0	SurePOS 100 Technical Specs and Programming Information	12
5.0	SurePOS 100 System Unit Technical Information	13
5.1	Processor Specifications	13
5.2	System Memory	13
5.3	Video	13
5.4	Ethernet	13
5.5	Hard File	13
5.6	PCI Expansion Slot	14
5.7	I/O Ports	14
5.7.1	Connectors/ Pinouts	15
5.7.2	Serial Port Pinouts	15
6.0	Device Hardware Specifications	16
6.1	Keyboard, Keylock, MSR	16
6.1.1	Keyboard	16
6.1.2	Keylock	17
6.1.3	Magnetic Stripe Reader (MSR)	17
6.1.4	Multiple Input considerations	18
6.2	Monitor	19
6.2.1	Monochrome CRT monitor – Model 108	19
6.2.2	Color LCD monitor – Model 118	19
6.2.3	Supported Video Modes	19
6.3	Optional 2x20 VFD Customer Display	19
6.4	Optional 1x11 LED 7-segment display	20
6.5	Printer	21
6.5.1	Impact Printer	21
6.5.2	Thermal Printer	22
7.0	System Programming Considerations	24
7.1	Identification via software	24
7.2	Control Registers	24
7.2.1	Definitions:	24
7.3	Memory Map	26
8.0	IO Programming Considerations	27
8.1	Keyboard	27
8.2	Keyboard/ MSR BIOS Command protocol	27
8.3	JAVAPOS Keyboard/MSR Command protocol	29
8.4	Magnetic Strip Reader (MSR)	30
8.4.1	MSR Error Handling	30
8.5	Keylock	30
9.0	Printer Programming	31
9.1	Impact Printer	31
9.2	Thermal Printer	31
9.3	Communications	31
9.3.1	DTR Mode	31
9.3.2	XON/XOFF Mode	33

SurePOS 100 Technical Reference

9.3.3	STX-ETX Mode	34
9.3.4	Star Mode Commands	36
9.3.5	Control Codes Used for Line Spacing	43
9.3.6	Control Codes Used for Page Layout	45
9.3.7	Control Codes Used for Graphics Printing	48
9.3.8	Control Codes Used for Character Downloading	49
9.3.9	Cash Drawer Commands	52
9.3.10	Other Control Codes	53
9.3.11	Control Codes	57
9.3.12	ESC/POS Mode Commands	65
9.4	Cash Drawer	67
Appendix A	Quick Reference for Printer Commands	69
9.5	Printer Command Reference -- Standard Version	69
9.5.1	General Usage Commands -- Standard Version	69
9.5.2	IBM Extended Commands -- Standard Version	72
9.6	Printer Command Reference -- Simplified and Traditional Chinese Versions	72
9.6.1	Control Codes -- Simplified and Traditional Chinese Versions	72
9.6.2	DBCS Character Commands -- Simplified and Traditional Chinese Versions	74
9.6.3	IBM Extended Commands -- Simplified and Traditional Chinese Versions	75
Appendix B	Adapter Cable Definition -- 15 Pin to standard 9 pin	76
10.0	Customer Display Programming Information	77
10.1	1x11 LED Display	77
10.1.1	1x11 Command Set	77
10.1.2	1x11 Character Set	77
10.2	2x20 VFD Customer Display	77
10.2.1	Command Set	77
11.0	Appendix - Code Pages	84
11.1.1	Code Page 00850 (Multilingual)	85
11.1.2	Code Page 00852 (Eastern Europe)	86
11.1.3	Code Page 00855 (Bulgaria)	87
11.1.4	Code Page 00857 (Turkey)	88
11.1.5	Code Page 00862 (Israel)	89
11.1.6	Code Page 00864 (Arabic)	90
11.1.7	Code Page 00866 (Russia)	91
11.1.8	Code Page 00869 (Greece)	92
11.1.9	Code Page 00874 (Thailand) (Printer Only)	93
11.1.10	Code Page 00897 (Japan)	94
12.0	PC DOS 7.0 Reference Publications	95
13.0	Keyboard Programming Utility Guide	98
13.1	Requirements	98
13.2	Utility Functions	98
13.3	Procedures	99
13.4	Programming Limitations	104

1.0 Introduction

1.1 Overview

The SurePOS 100 Point of Sale Terminal-- the IBM 4613--is an integrated terminal solution comprised of a motherboard, keyboard, MSR, receipt printer, monitor, keylock, and networking capability in a single mechanical package. Attachment of optional cash drawers and customer displays is supported. SurePOS 100 is the successor to the IBM SureOne (4614).

There are two 4613 models.

The 4613-108 incorporates a 9 inch monochrome SVGA CRT monitor.

The 4613-118 incorporates a 10 inch SVGA LCD monitor.

All SurePOS 100 models include the following components and features:

- Via C7 CPU and Chipset
- 256M system memory standard, with slot available for upgrade
- 96-key keyboard with customizable keys and keytop accessory kits
- 3-track MSR
- CD-ROM (optional feature)
- 80 GB or larger fixed disk drive
- 10/100 Ethernet port
- One partial length PCI feature card slot (optional feature)
- External I/O ports:
 - 24V Cash Drawer that drives OEM and IBM 24V cash drawers
 - 4x RS232, 2 of them IBM 15-pin Powered RS232
 - 2x USB
 - additional 1X front USB port
 - one 12V Powered USB port
 - PS2 Keyboard and Mouse
 - Ethernet
 - VGA
- A single-station impact or thermal printer, with DBCS support options for Simplified and Traditional Chinese. A machine may be ordered without a printer installed.
- 2 x 20 Vacuum Fluorescent customer display (optional feature)
- 1x11 7-segment LED customer display (optional feature)
- Compact and full-size optional cash drawers (optional features)
- OS Support
 - PC DOS 7
 - Windows 2000/XP



Figure 1. Model 108



Figure 2. Model 118

1.2 *Related Documents*

SurePOS 100 Product Documents

1. IBM SurePOS 100 Point-of-Sale Terminal Installation and Operation Manual, GA27-4368
2. IBM SurePOS 100 Point-of-Sale Terminal Hardware Service Guide, GY27-0425

3. IBM SurePOS 100 Operating System Installation Guide
4. IBM SurePOS 100 Getting Started Guide

2.0 The SurePOS 100 Mechanical Package

The chassis and component integration features are designed with cost, ease of service, and ruggedness in mind. The following components are integrated into the chassis:

- Core logic; CPU, system board, etc.
- Monitor
- Printer
- Keyboard
- MSR
- Keylock
- Power Supply
- Mounting point for optional Customer Display.

2.1 Dimensions

System unit height at front: 5.2 cm (2.05 in)
System unit height at rear: 12 cm (4.72 in)
Height of monitor : 37 cm (14.6 in)
System unit width 33 cm (13 in)

Weight:

Model 108 (CRT) 12.6 kg (27.8 lbs)
Model 118 (LCD) 10.6 kg (23.5 lbs)

The width and depth dimension allow the unit to sit atop an IBM small footprint cash drawer. The feet of the unit must be placed in a manor such that they integrate into the top of the cash drawer and effectively “lock” the two components together when moved in the horizontal plane.



2.2 Controls & Indicators

All system unit controls and indicators are located at the control panel on top of the SurePOS 100.

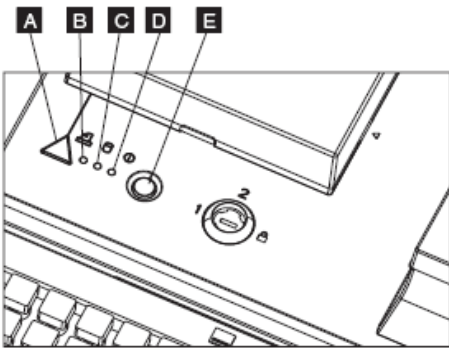

Control or Indicator	Location
Paper feed button	A
Printer Status	B
Green hard drive activity indicator	C
Green power-on indicator	D
Power-on and power-off switch	E
3-position keylock	to the right of the power button E

2.2.1 Special Tools for Service

To maintain the SurePOS 100 terminals, the service representative may need the following items that are not supplied in the tool kit:

- Keytop puller, P/N 38H6011 or P/N 63X5175
- Lock cylinder alignment key, lock installation-removal key, and dummy lock insert key, P/N 4783922
- MSR test card, P/N 90X9640
- 9-pin loop-back test connector for serial ports, PN 38H6039
- 15-pin loop-back test connector for serial ports, PN 38H6035

3.0 Comparison with SureOne

The SurePOS 100 Point of Sale Terminal is an electrical and mechanical redesign of the 4614 SureOne P80/P81.

The following information is intended to assist SureOne users with the transition to the SurePOS 100.

Most external I/O devices and programming interfaces are compatible between the two products.

Exceptions are noted below.

SurePOS 100 does not:

- support a journal take up kit.
- enable fiscalization. A SurePOS 100-based fiscal solution uses the printerless model with a locally sourced fiscal printer.
- Offer a Floppy disk drive.
- Offer a Parallel port
- Have a printer cover open sensor.

SurePOS 100 uses a standard IBM RSS RS-232 2x20 VFD option—the SureONE VFD is not compatible. The SureOne VFD is not electrically compatible with SurePOS 100. There is no available port. The programming interface of the standard 2x20 used with SurePOS 100 is similar in many respects to the SureOne interface. Key areas of difference are in selection of code pages and in establishing User-defined characters.

SurePOS 100 supports a 3 track MSR.

MSR error reporting is improved. See the SurePOS 100 Keyboard Tech Ref.

Minor differences in MSR scan codes exist between SurePOS 100 and SureONE. See the SurePOS 100 Keyboard Tech Ref.

The SurePOS100 keyboard uses the same key-switch technology as IBM's Point of Sale Keyboard line.

This section contains a list of the devices that constitute each functional section of each model. Detailed device specifications are found in subsequent sections.

3.1.1 Device Comparison with SureOne

Subsystem	SurePOS 100	SureOne 4614-P80/P81	Driver Impact	App Impact
Processor	Via C7 2.0GHz	Via C3 866Mhz	Different OEM Driver	∅
Core Logic Chipset	Via CN700, VT8237R+	Via VT8602 VT686B	Different OEM Driver	∅
Video Controller	Via	Via	Different OEM Driver	∅
System Memory	DDR2 256MB–1GB (2G tested but not presently offered)	SDRAM 64MB- 512MB	∅	∅

SurePOS 100 Technical Reference

HDD Interface (see CD Rom)	SATA connection	IDE connection	∅	∅
LED customer display	15pin Powered RS232	none	no UPOS driver support- direct IO via RS-232	
VFD Port	15pin Powered RS232	IBM Port 4 RS232	∅	∅
Integrated 96key programmable PS/2 Keyboard	Custom Keyboard XAC	SMK Keyboard	new UPOS driver as required	∅
Ethernet	Via MAC	Nat. Semi. MAC	Different OEM Driver	∅
Integrated PS/2 MSR wedge	XAC	XAC	new UPOS driver as required	∅
Printer Support Dot Matrix Thermal	Star MP512II Star TMP212	Star MP512II Star TMP212	∅	∅
USB Ports, 2x	USB 2.0	USB 1.1	∅	∅
Front USB	USB 2.0	none		
Powered USB	12v Port	none	∅	∅
RS232 Ports	2 Powered	1 Powered	∅	∅
PCI Slot	32 bit/33Mhz 1 partial length	32bit/33Mhz 1partial length	∅	∅
CRT Port	15 pin analog	15 pin analog	∅	∅
Display Power	12v	12v	∅	∅
Cash Drawer	24v 240h/241h interface	24v 240h/241/ interface	∅	∅
Power Supply	autoranging	hi/lo voltage switch		
Keylock	3 position 240h/241h interface	3 position 240h/241h interface	∅	∅

SureOne Product Documents

1. IBM 4614 SureOne Point of Sale Technical Reference Information
2. IBM 4614 SureOne Point of Sale Technical Reference Addendum
3. IBM 4614 SureOne Point-of-Sale Terminal: Quick Reference, GA27-4135
4. IBM 4614 SureOne Point-of-Sale Terminal: Hardware Service Manual, GY27-0353
5. IBM 4614 SureOne Point-of-Sale Terminal: Service Diskette, SX27-4012.
6. IBM SureOne Programmable Keyboard Technical Reference

4.0 SurePOS 100 Technical Specs and Programming Information

	Technical Specs	Programming Information
System Unit	Section 5.0 on page 13	Section 7.0 on page 24
Keyboard	Section 6.1 on page 16	Section 8.1 on page 27
Keylock	Section 6.1 on page 16	Section 8.5 on page 30
MSR	Section 6.1 on page 16	Section on page
Impact Printer	Section 6.5.1 on page 21	Section 9.0 on page 31
Thermal Printer	Section 6.5.2 on page 22	Section 9.0 on page 31
Monitor	Section 6.2 on page 19	n/a
CD-DVD	Section 6.2 on page 19	n/a
2x20 LCD	Section 6.3 on page 19	Section 10.2 on page 77
1x11 LED	Section 6.4 on page 20	Section 10.1 on page 77

5.0 SurePOS 100 System Unit Technical Information

5.1 Processor Specifications

Via C7D

Function	
Frequencies	2.0Ghz
Socket	None
Cache	Two 64KB 4-way L1 Caches 128KB L2 Cache
FSB	800Mhz

5.2 System Memory

533MHz DDR2 DIMMS.

Supported Memory configurations:

Base 256M, Expansion 0M

Base 512M, Expansion 0M

Base 256M, Expansion 512M as a field feature

Base 512M, Expansion 512M as a field feature

5.3 Video

Video function is provided by the integrated CPU chipset for all models. The video subsystem uses System Memory for video storage. The BIOS Setup utility allows the user to allocate a portion of System memory for the video frame buffer. Video memory of 16MB, 32MB and 64MB can be allocated.

5.4 Ethernet

NO SUPPORT FOR RPL OR NETWARE PROTOCOLS is provided.

Depending on software and BIOS setup options, if a unit is off and AC power is available, the LAN function Wake-On-LAN can be enabled. This feature can be used to cause a terminal that is in either the standby or off state to "wake up" or power up on a specified LAN event. Waking up from the off state is dependent on the OS used, the level of support provided by the LAN drivers, and how the customer has configured the hardware, OS, and application.

The LAN function is compatible with the following industry standards:

IEEE 802.3i 10baseT/100baseT physical layer interface

IEEE 802.3u auto negotiation

5.5 Hard File

One SATA port is provided at 1.5 Gb/s.

5.6 PCI Expansion Slot

One internal, partial length, 32 bit/ 33 MHz PCI Expansion Slot is provided for use with industry standard expansion cards. Typical PCI cards used in retail are Modems and NVRAM adapters (e.g. Atlas card).

5.7 I/O Ports

Port	Description	Hot Plug Support
RS232 Serial	Two 9 pin D-shell, Two 15pin D-shell Powered, 5v and 12v 16550 UART Compatible	No
USB	One 12V Powered USB One Standard USB 2.0, Front Two Standard USB 2.0, Rear All speeds supported: High, Full, Low	Yes
CRT Video	Industry standard 15 pin D-shell Analog RGB video port	No
Keyboard/Mouse	PS/2 interface, two separate ports, one keyboard one mouse	No
Ethernet	RJ-45 connector with integrated Green Link and Amber Activity LEDs Auto-negotiation of 10Mbit and 100Mbit	Yes
Cash Drawer	One IBM 24V cash drawer port	Yes
DC Power Port	Dedicated DC power for the LCD display option	No
PCI Slot	Internal partial length PCI 32bit/33Mhz slot The PCI riser card is an optional feature.	No

5.7.1 Connectors/ Pinouts

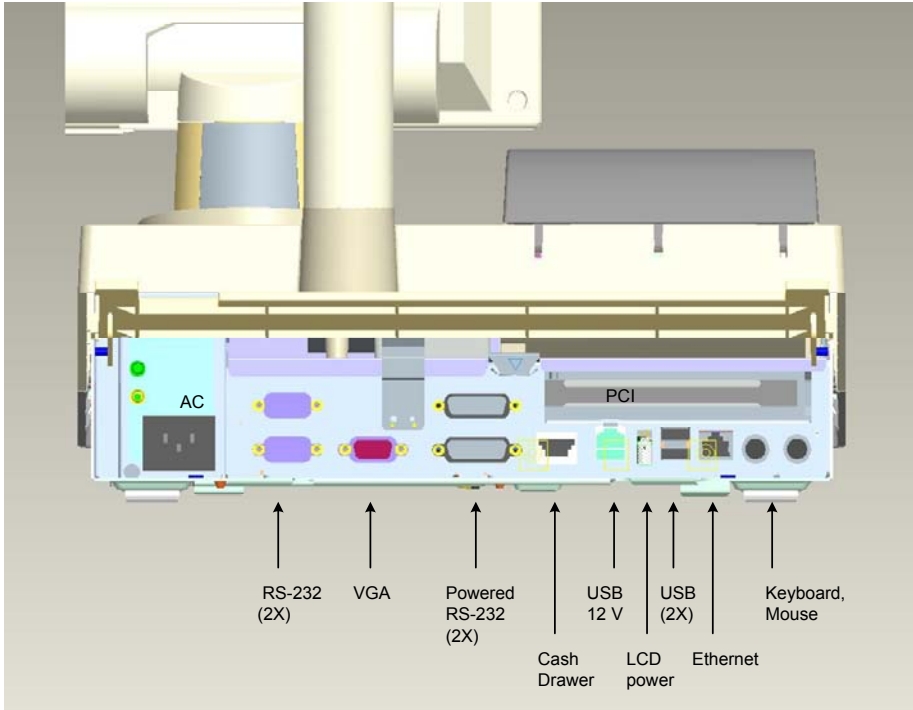

Figure 3. SurePOS 100 I/O Ports

5.7.2 Serial Port Pinouts

Signal Description	Port A,B (standard) 9 pin D shell	Port C,D (powered) 15 pin D shell
CD	1	1
RXD	2	2
TXD	3	3
DTR	4	4
DSR	6	12
RTS	7	13
CTS	8	14
RI	9	15
GND	5	5,6,11
+5V (+5%, -10% at conn.)	n/a	7,10
+12V (+5%, -10% at conn.)	n/a	8,9

6.0 Device Hardware Specifications

6.1 Keyboard, Keylock, MSR

6.1.1 Keyboard

The SurePOS 100 terminal has a matrix keyboard with the following features:

96 keys

The standard accessory kit contains the clear keycaps, plus double keys and blanking bars.

The keyboard is shipped without keycaps installed. The distributor merges a language- or country-unique keytop or keytop label kit with the unit.

An optional accessory kit provides a quad key

Default QWERTY style that is layout compatible with a Standard PC 101, 102, or 103 key layout

The keyboard appears to the system as a standard PC keyboard. The capability to program the keyboard scan codes which are transmitted to the application software is described in the SurePOS 100 Programmable Keyboard Technical Reference section of this document.



Figure 4. US English SurePOS 100 Keyboard (101 Layout)

Keyboard Specifications

Item	Specification	Notes
Key Switch Technology	Membrane	
Number of Keys	96 keys	6 rows, 16 columns
Travel, Full	4.0 – 0.4 mm	
Travel, Pre	2.0 +/-0.6mm	
Key pressure	60 +/-20cN	Parallel to key centerline
Key bounce time	< 5 mS	
Programmable scan codes per key	255	
Spill Resistance	Membrane Immersion in water for up to 30 minutes	

Lens Cap Removal Force	500 grams minimum	
Key Cap Nomenclature	Preprinted key labels	

6.1.1.1 Keyboard/MSR Controller IC

Item	Specification	Notes
Upstream Host Interface	PS/2 Keyboard	
Downstream interfaces	96 key Scan Matrix wires MSR buffered read head output PS/2 Keyboard Port	
FLASH Upgradeable Firmware	Yes	
MSR interface	Wedge functionality	MSR data converted to keyboard scan codes and appear as keyboard input
Wedge Data Speed Control	Slow, Medium, High	Selectable in POST Setup. Data Speed is the rate which keyboard scan codes are transmitted from keyboard controller to Host PS/2 port. This feature allows adjusting the rate for problems that exists with some software applications.

6.1.1.2 Keyboard Wedge Considerations

Many keyboard “wedge” devices exist in the market. These plug into a PS/2 port and transmit data to the application as keyboard scan codes.

IBM cannot guarantee that all wedge devices will work. As with any other open system, the system Integrator must test with all software and I/O being offered as a complete solution to end users.

6.1.2 Keylock

The SurePOS 100 Terminal contains a 3-position keylock that can be read by an application program. One of the positions can also be used to prevent the terminal from booting. This non-booting mode is a configuration option that can be enabled or disabled by the user. The keylock does not provide any physical (cover-locking) security.

The keylock is the same style keylock used on other IBM POS equipment and is available with a variety of key configurations.

6.1.3 Magnetic Stripe Reader (MSR)

Each terminal is shipped with an integrated 3- track MSR. Supported tracks are:

Track 1/2
 Track 1/3
 Track 2/3
 All tracks

The MSR data is delivered as if it had been entered manually via the keyboard. A detailed description of default scancodes and the ability to program the MSR scan codes which are transmitted to the application software is available in the SurePOS 100 Programmable Keyboard Technical Reference section of this document. A separate MSR I/O port is not provided.

General MSR Specifications

	Specification	
Track Configuration	ISO 7811 Tracks 1,2,3	
Coercivity of Magnetic Stripe	300 to 4000 Oe	
Read Direction	Bi-directional	
Swipe Speed	5 to 45 inches per second	
Maximum Jitter	12%	
Error Rate	Less than 0.5%	
Electrical Interface	PS/2 keyboard wedge	
Rated Life	500,000 swipes	
Metallized Card Support	Yes	
FLASH Upgradeable Firmware	Yes	

Configurable MSR Characteristics

	Specification	Default
Enable/Disable Sentinels	Yes	
Enable/Disable Carriage Return	Yes	
Programmable Sentinels	Yes	
Individually Selectable Tracks	1,2,3	Track 2/3
Data Speed Selectable	Slow, Medium, High	

6.1.4 Multiple Input considerations

Limitations

Simultaneous input from the internal keyboard, MSR, or external keyboard port is not supported. In such an event, data from the internal keyboard or external keyboard port may be lost. Data from the MSR is given priority and will not be lost or interrupted.

Data Source Identification

A data source identification option will be added that will enable applications to determine, via the data stream coming from the keyboard, the source of the data. It should be noted that this interface will be outside the scope of the PC keyboard interface, and will make the keyboard datastream unique to SureOne.

There are 3 possible data sources:

- Internal matrix keyboard
- External keyboard port
- Internal MSR

Each data source can be selected to have its data identified individually (i.e., an application can choose to only enable identification of the MSR and external keyboard port while leaving the internal port alone). A detailed description of configuring data source identification is available in the SurePOS 100 Programmable Keyboard Technical Reference section of this document

6.2 Monitor

Two video monitors are available in the 4613 product line.

6.2.1 Monochrome CRT monitor – Model 108

Specifications:

- TVS TM-9AF monitor
- PC-ABS covers
- See below for supported video modes.

6.2.2 Color LCD monitor – Model 118

The SurePOS 100 Model 118 includes the IBM 4820-1WD LCD monitor.

- Display size 10.4 inches
- Analog video
- See below for supported video modes.

6.2.3 Supported Video Modes

Mode	Resolution	Refresh (Hz)	LCD	CRT
VGA	640x350	70	X	X
	640x400	70	X	X
	720x350	70	X	
	720x400	70	X	
		85		X
	640x490	60	X	X
		72	X	
		75	X	X
SVGA	800x600	56	X	X
		60	X	X
		72	X	
		75	X	

6.3 Optional 2x20 VFD Customer Display

The 2x20 Vacuum Fluorescent Display electronics is common to the SurePOS 500 distributed display.

2x20 Display Characteristics	
Technology	Vacuum Fluorescent

SurePOS 100 Technical Reference

Brightness (w/o lens)	300 cd/m**2
Display Color	Green
Adjustment	Multi-position detent
Character Matrix	5x7
Character Height and Width	9.5x4.45 mm
Emulations	Logic Controls Emulation or IBM Multi-mode
Character Sets (IBM Multi-mode)	Code Page 437 (US/Euro) Code Page 897 (Katakana) Code Page 857 (International) Code Page 852 (Central Europe) Code Page 855 (Cyrillic) Code Page 857 (Turkey) Code Page 862 (Israel) Code Page 863 (Canadian French) Code Page 864 (Arabic) Code Page 865 (Nordic) Code Page 808 (Cyrillic Russian) Code Page 869 (Greece)
User Defined Characters	Logic Controls Mode: 1 IBM Mode: 8
Electrical Interface	RS232
Power	12V
Power consumption (all pixels energized)	7.2 W
Attachment Cable	15 pin, powered RS232 cable 0.8 m for integrated configuration 3.8 m for distributed configuration
Mechanical mounting	Integrated: Short and tall posts, direct mount to SurePOS main housing. Distributed: Short and tall posts, mounting base.

6.4 *Optional 1x11 LED 7-segment display*

WINPOS WD-111 with custom cable lengths and PC-ABS in place of WinPOS' standard ABS.

2x20 Display Characteristics	
Technology	LED
Brightness (w/o lens)	500 cd/m**2
Display Color	Green
Adjustment	Multi-position detent
Character Height and width	14.5 mm x 8.5 mm
Character Sets	16 Alphanumeric (non-standard Code Page)
User Defined Characters	none
Electrical Interface	RS232

Formatted: Italian (Italy)

Power	12V
Power consumption (all pixels energized)	6W max
Attachment Cable	15 pin, powered RS232 cable 0.8 m for integrated configuration 3.8 m for distributed configuration
Mechanical mounting	Integrated: Short and tall posts, direct mount to SurePOS main housing. Distributed: Short and tall posts, mounting base.

6.5 Printer

The SurePOS 100 POS Terminal is available with either an impact printer, a thermal printer, or no integrated printer.

Each printer solution consists of a print head assembly mounted under the printer cover and a printer card mounted under the keyboard cover. The thermal and impact printers each have a unique printer card. Each Printer adapter card is available in three versions: Single Byte, double byte traditional Chinese, and double byte simplified Chinese.

.Firmware is unique to each version of printer adapter card and fonts cannot be downloaded to other cards to change their "personality."

6.5.1 Impact Printer

The impact printer design is a single head print mechanism which is capable of printing double byte character sets without compromising performance.

The printer is a self-contained mechanism that satisfies the requirements of the small retailer. It can print receipts, and print on two-part forms.

6.5.1.1 Impact Printer Characteristics

- Star Micronics MP512MB printer mechanism
- Font support for Single Byte character sets Thai and USA/Europe
- Font support for Double Byte character sets Simplified Chinese (GB2312-80 compatible character set), Japanese (JIS compatible character set), and Traditional Chinese (BIG5 compatible character set)
- Bi-directional printing in both single and double byte modes
- 4.0 Lines per second print speed in text mode
- 9-pin print head
- 40 columns in default print mode
- 3 in./76.2 mm Paper (3.25 in./82mm maximum diameter roll)

- Ability to use single or two part paper
- Paper thickness: 0.07 mm to 0.10 mm for single part paper to 0.14 mm total thickness for two part paper, with each sheet 0.05 to 0.08 mm thick
- Use of the industry-standard Star command set
- Double wide, double high, emphasized logo printing
- Built-in font support for worldwide use
- Up to 10 user-defined downloadable characters
- Approximately 100 million character life expectancy
- Purple ribbon with an approximate maximum life of 6 million characters

6.5.2 Thermal Printer

The SurePOS 100 thermal printer is common with the 4614 SureOne printer, incorporating the Star Micronics TMP212CD-24-A thermal printer mechanism and Hitachi YZ3-40220001 paper cutter unit.

The thermal printer is generally compatible with the SureOne impact printer command set and functions. The printer is compatible with the Star TSP200 printer in both Star and ESC/POS command modes.

Three versions of the thermal printer are available for printing different international character sets: the Standard Version, the Simplified Chinese Version, and the Traditional Chinese Version.

The Standard version of the printer in Star mode contains the following code pages:

437 (US/Europe,
850 (Multilingual)
852 (Latin 2)
855 (Cyrillic)
857 (Turkish)
862 (Hebrew)
864 (Arabic)
866 (Cyrillic 2)
874 (Thai)
Katakana.

The Standard version of the printer in ESC/POS** mode contains the following code pages:

437 (US/Europe), 850 (Multilingual), 860 (Portuguese), 863 (Canadian-French), 865 (Norwegian), and Katakana.

The Simplified Chinese version of the printer contains code page 1381, a GB2312-80 compatible Simplified Chinese character set.

The Traditional Chinese version of the printer contains the BIG5 Traditional Chinese character set.

Printer and cutter characteristics include:

- Fast, quiet, high-quality printing
- Industry-standard Star command set
- Industry-standard ESC/POS command set
- Up to 16.7 lines per second (at 3 mm line spacing)
- Up to 12.5 lines per second (at 4 mm line spacing)
- 48 print columns in default print mode (16.9 characters per inch)
- Various print characteristics (scaled height and width, emphasized, underlined, reverse image, inverted, character spacing, line spacing and more)

SurePOS 100 Technical Reference

- 576-dot printhead (8 dots per mm / 203 dots per inch)
- 72 mm print width
- 79 to 80 mm wide thermal paper roll (82 mm maximum outside roll diameter)
- 0.06 to 0.075 mm paper thickness
- Barcode printing in nine different formats
- Graphics and logo printing modes
- Resident single-byte character sets for worldwide support (Standard version)
- Resident double-byte character sets for worldwide support (Simplified Chinese or Traditional Chinese)
- Up to 32 user-definable download characters (Standard version)
- Memory switch settings to modify and store printer configuration
- Out-of-paper sensor
- Printer life expectancy of approximately 10 million lines
- Paper cutter with software-controlled partial or full paper cut
- Paper cutter life expectancy of approximately 300 000 cuts

7.0 System Programming Considerations

7.1 Identification via software

The system vital product can be obtained from the SMBIOS. Information which can be parsed from SMBIOS includes (but is not limited to):

- Machine Type Model
- Serial Number
- UUID

7.2 Control Registers

The following are the only control registers supported on SurePOS 100, and are compatible with the SureOne models P80 and P81.

SurePOS 100 has a custom designed integrated circuit to manage COM port assignments, keylock reads, and cash drawer configuration. The SurePOS 100 has two I/O ports located at I/O addresses 240h and 241h. Address 240h is the index port and address 241h is the data port. A register index value is written to address 240h, then address 241h is read from or written to in order to actually pass data to or from the control registers.

Usage examples:

To read index registers 10h and 11h.
 Write the value 10h to I/O address 240h.
 Read I/O address 241h. The read value is the value of index register 10h.
 Write the value 11h to I/O address 240h.
 Read I/O address 241h. The read value is the value of index register 11h.

To write the index register at 12h with 55h.
 Write the value 12h to I/O address 240h.
 Write the value 55h to I/O address 241h.

Programs that access control registers must insure that the index register at I/O address 240h is written to 00h at the end of any I/O operation to prevent register contents from being changed accidentally by runaway code.

7.2.1 Definitions:

Keylock Position

INDEX 26H:

Read

7 6 5 4 3 2 1 0 Function

 x x x x 1 1 1 Position 1 (the locked position shown on the cover)

x x x x 1 1 0 Position 2

x x x x 1 0 1 Position 3

Control register S

Cash drawer setup

INDEX 28H:

Read/write

7 6 5 4 3 2 1 0 Function

x x x x x x 1 disable C/D driver
x x x x x x 0 enable C/D driver
x x x x x 1 x C/D pulse = 100 mS (recommended)
x x x x x 0 x C/D pulse = 50 mS
x x x x 0 x x C/D controlled by prt logic
x x x x 1 x x C/D controlled by ASIC

Control register T

Cash drawer open via ASIC

INDEX 29H:

Write only

7 6 5 4 3 2 1 0 Function

0 0 0 0 0 0 1 Pulse C/D circuit (open drawer)

Control register U

Cash drawer status

INDEX 30H:

Read/write

7 6 5 4 3 2 1 0 Function

x x x x x 0 x IBM cash drawer connected
x x x x x 1 x IBM cash drawer not connected
x x x x 0 x x IBM cash drawer open
x x x x 1 x x IBM cash drawer closed

7.3 Memory Map

The system memory map is as follows:

xxxxxxh	Open/RAM
10000h FFFFh	64K POST/BIOS/SMBIOS
F000h EFFFh	Free
C900h C8FFh	Video BIOS/LAN PXE
B800h B7FFh	Free
B100h B0FFh	Video
A000h 9FFFh	Base RAM (640K)
0000h	

8.0 IO Programming Considerations

The following sections describe programming considerations for the SurePOS 100 keyboard, magnetic stripe reader (MSR), and printers.

8.1 Keyboard

Some keys that are on a normal PC keyboard are not on this keyboard. These include the non-numeric keys surrounding the PC numeric pad (+, Enter, *, -, /), and the Numlock key.

Three keys that are on a PC keyboard are implemented using a special Pos Shift key. The functions of these three keys are implemented on a key that is used for another function in its non-shifted state. These are:

- Pos Shift + Ins generates the scan code for the PrtScr key (124)
- Pos Shift + Home generates the scan code for the ScrLk key (125)
- Pos Shift + PgUp generates the scan code for the Pause key (126)
- Pos Shift + Esc generates the scan codes for the combination of the left Ctrl key and the Pause key (126). This key combination is commonly known as the Break key. This key definition is included because it is easier to do Pos Shift + Escape than Ctrl + Pos Shift + Pause.

The Pos Shift key itself generates no scan code of its own to the keyboard port when the keyboard is configured to be in 101, 102, or 103 (v10) PC mode.

Note: An optional Quad Key can be ordered and installed to replace four existing keys in a 2-by-2 pattern. No keyboard driver is required or provided to use the keyboard in the default PC mode. When the keyboard is configured to be in POS mode, the application program must use standard PC keyboard interfaces to intercept the keystrokes (scan codes) and perform the appropriate translation and detection.

8.2 Keyboard/ MSR BIOS Command protocol

“00” Key Enable/Disable

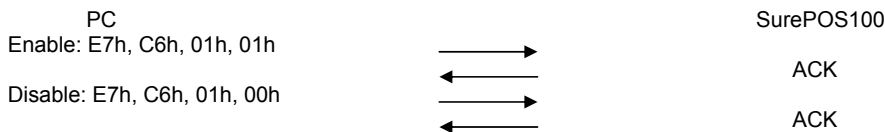

2. MSR Tracks Enable/Disable

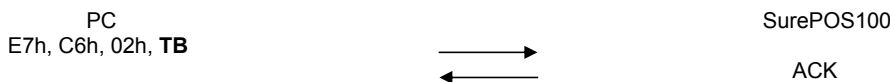

Note:

- TB**: Track Byte, 00-07
- 00: All Track Disable
- 01: Track1 Enable, Track2, 3 Disable
- 02: Track1 Disable, Track2 Enable, Track3 Disable
- 03: Track1 Enable, Track2 Enable, Track3 Disable
- 04: Track1 Disable, Track2 Disable, Track3 Enable
- 05: Track1 Enable, Track2 Disable, Track3 Enable
- 06: Track1 Disable, Track2 Enable, Track3 Enable
- 07: All Track Enable

3. Typematic Enable/Disable

PC		SurePOS100
Enable: E7h, C6h, 03h, 01h	→	
	←	ACK
Disable: E7h, C6h, 03h, 00h	→	
	←	ACK

4. External Keyboard Enable/Disable

PC		SurePOS100
Enable: E7h, C6h, 04h, 01h	→	
	←	ACK
Disable: E7h, C6h, 04h, 00h	→	
	←	ACK

5. MSR Speed

PC		SurePOS100
High Speed: E7h, C6h, 05h, 0Dh	→	
	←	ACK
Medium Speed: E7h, C6h, 05h, 17h	→	
	←	ACK
Low Speed: E7h, C6h, 05h, 23h	→	
	←	ACK

6. Select Keyboard Layout

PC		SurePOS100
101 mode: E7h, C6h, 06h, 01h	→	
	←	ACK
102 mode: E7h, C6h, 06h, 02h	→	
	←	ACK
103 mode: E7h, C6h, 06h, 03h	→	
	←	ACK
POS mode: E7h, C6h, 06h, 04h	→	
	←	ACK

7. MSR code maps for 8 Countries

PC		SurePOS100
United States: E7h, C6h, 07h, 01h	→	
	←	ACK
Canadian/French: E7h, C6h, 07h, 02h	→	
	←	ACK
U.K.English: E7h, C6h, 07h, 03h	→	
	←	ACK
French: E7h, C6h, 07h, 04h	→	
	←	ACK
Germany: E7h, C6h, 07h, 05h	→	
	←	ACK
Latin American: E7h, C6h, 07h, 06h	→	
	←	ACK
Spanish: E7h, C6h, 07h, 07h	→	
	←	ACK
Brizilian: E7h, C6h, 07h, 08h	→	
	←	ACK
Custom: E7h, C6h, 07h, FFh	→	
	←	ACK

8.3 JAVAPOS Keyboard/MSR Command protocol

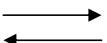
1. JPOS Command set prefix
 PC
 E7h, C6h, 08h, **PB**

SurePOS100
ACK
- Note:
PB: Prefix Byte, 00-FF

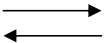
2. JPOS Command set suffix
 PC
 E7h, C6h, 09h, **SB**

SurePOS100
ACK
- Note:
SB: Suffix Byte, 00-FF

3. JPOS Command set prefix and suffix Enable/Disable
 PC
 E7h, C6h, 0Ah, **PSB**

SurePOS100
ACK
- Note:
PSB: Prefix and Suffix Enable/Disable Byte, Bit0: prefix, Bit1: suffix, Range: 00-03
 00: Prefix and Suffix all Disable.
 01: Prefix Enable, Suffix Disable
 02: Prefix Disable, Suffix Enable
 03: Prefix and Suffix all Enable

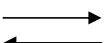
4. JPOS Command Write Flash Command
 PC
 Enable: E7h, C6h, 0Bh, 01h
 

SurePOS100
ACK

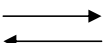
5. JPOS Command Query MSR Track Status
 PC
 Enable: E7h, C6h, 0Ch, 01h
 

SurePOS100
RESPONSE
- Note:
RESPONSE:
 0x0B 0x8B: '0' scan code (make and release), All Track Disable
 0x02 0x82: '1' scan code (make and release), Track1 Enable, Track2, 3 Disable
 0x03 0x83: '2' scan code (make and release), Track1 Disable, Track2 Enable, Track3 Disable
 0x04 0x84: '3' scan code (make and release), Track1 Enable, Track2 Enable, Track3 Disable
 0x05 0x85: '4' scan code (make and release), Track1 Disable, Track2 Disable, Track3 Enable
 0x06 0x86: '5' scan code (make and release), Track1 Enable, Track2 Disable, Track3 Enable
 0x07 0x87: '6' scan code (make and release), Track1 Disable, Track2 Enable, Track3 Enable
 0x08 0x88: '7' scan code (make and release), All Track Enable

8.4 [Magnetic Strip Reader \(MSR\)](#)

A 3-track MSR is shipped with every unit. Available configurations, configurable through the BIOS, are:

- Tracks 1/2
- Tracks 2/3
- Tracks 1/3
- All tracks

MSR data is brought in through the keyboard port as keyboard data. Non-ANSI/ISO-encoded credit cards cannot be read.

The format for MSR data is:

SS = Start Sentinel
= % for Track 1
= ; for Tracks 2 and 3
ES = End Sentinel
= ? for Tracks 1, 2, and 3
CR = Carriage Return

8.4.1 MSR Error Handling

8.5 Keylock

The keylock is a 3-position keylock. The key can be removed in all three positions.

If the boot-lock mode in the configuration screen is activated, the terminal does not boot when the keylock is in position 1.

The keylock position can be read from the SurePOS 100 ASIC through a read to index register 26h.

Values are:

xxxxx111 position 1 (the locked position shown on the cover)
xxxxx110 position 2
xxxxx101 position 3

9.0 Printer Programming

9.1 Impact Printer

This printer is available in Standard, Simplified Chinese, and Traditional Chinese versions. Commands are based on the Star SP500 printer.

Additional IBM command extensions are:

ESC T for character set support
ESC Y for paper width
ESC for XON/XOFF handshaking
ESC for DTR handshaking

9.2 Thermal Printer

This printer is available in Standard, Simplified Chinese, and Traditional Chinese versions. Commands are based on the Star TSP200 printer. The Standard version of the thermal printer also supports the ESC/POS command set. Additional IBM command extensions are:

ESC T for character set support (Standard version only)
ESC for XON/XOFF handshaking
ESC for DTR handshaking

9.3 Communications

The printer is attached through a COM port that is determined through configuration. The printer is configured during setup to run at 9600 baud, 1 stop bit, and no parity. The appropriate MODE command must be part of the AUTOEXEC.BAT or STARTUP.CMD file to communicate with the printer.

Application programs that write only to the LPT port can be used with the printer by using the mode command to redirect printer data to a COM port. The printer must be configured to be COM1 through COM4. For example, the command:

```
MODE LPT1=COM1
```

redirects the printer data written to LPT1 to the COM1 port.

The printer performs handshaking with the system logic by one of two methods: DTR or XON/XOFF mode. DTR mode (also called hardware handshaking mode) is simple and implemented within the operating system by using the MODE command. XON/XOFF mode is selected by using a command. The system powers up in hardware handshaking (DTR) mode.

9.3.1 DTR Mode

Signals are controlled using the DTR line as BUSY flag.

Figure 3-5. DTR Signal Timing

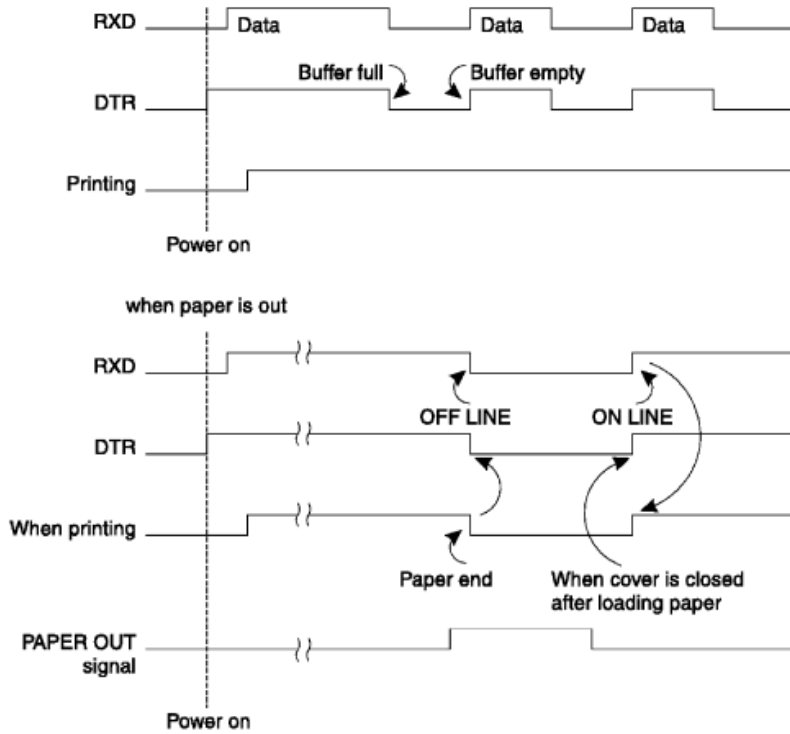

If a printer logic board error does not occur after the power is switched ON, the DTR signal line is asserted.

After the application confirms that DTR is asserted, the application program can send data to the printer at any time. The printer logic drops the DTR signal when the empty space in the data buffer is below 256 bytes. After the application detects that the DTR signal has dropped, transmission of data must stop. In DOS and OS/2 systems, this buffer management can be completely handled by the operating system. No application programming is required to implement this handshaking.

When the data in the data buffer is reduced to 256 bytes or less, the empty space in the data buffer is increased and the printer logic asserts DTR. Then the printer is ready to receive more data.

Figure 3-6. DTR Data Buffer



9.3.1.1 Framing Error

A framing error occurs when space is detected at the stop bit. When a framing error or parity error occurs for the data that is received, the printer prints out a "?" mark to indicate that the error occurred.

9.3.1.2 Mechanical Error

Immediately after a mechanical error occurs, the printer logic drops DTR.

9.3.2 XON/XOFF Mode

This mode is enabled after the application program transmits the ESC command to the printer. The print buffer must be empty or this command is ignored.

Figure 3-7. XON/XOFF DTR Signal Timing

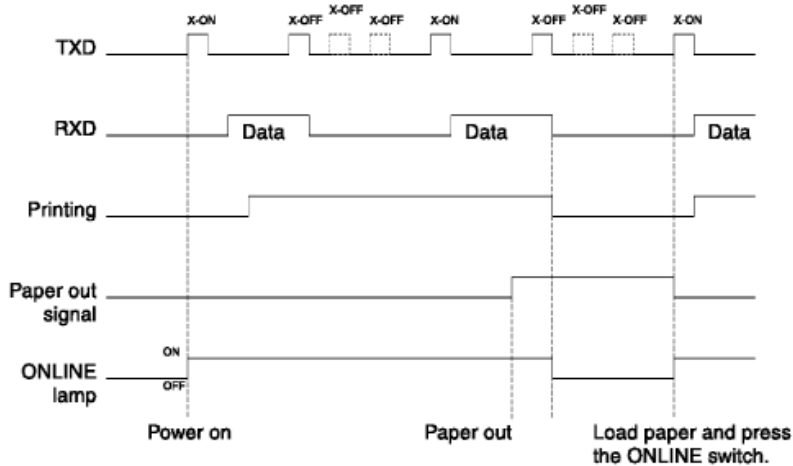

After transmission of the ESC command, the printer outputs an XON (DC1 by control code; 11h by hexadecimal data) to the system. When the application program receives the XON signal, it can transmit data to the printer. If the data text is not sent from the application program, the printer logic outputs an XON signal at 3 second intervals until the printer receives data.

The printer starts sending XOFF (DC3, 13h) when the empty space in the buffer reduces below 256 bytes. When the application receives the XOFF signal, it halts output of data. However, the printer logic can continue receiving data until the buffer becomes completely full.

Output of the XON signal is resumed when the data in the buffer is printed out and drops to below 256 bytes.

Figure 3-8. XON/XOFF Data Buffer

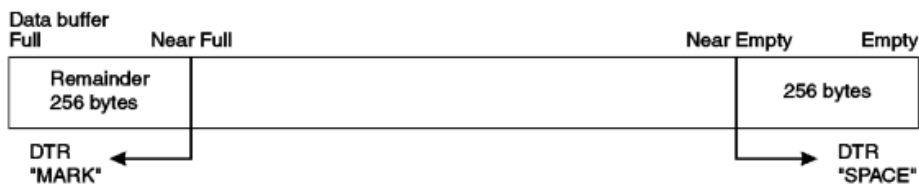
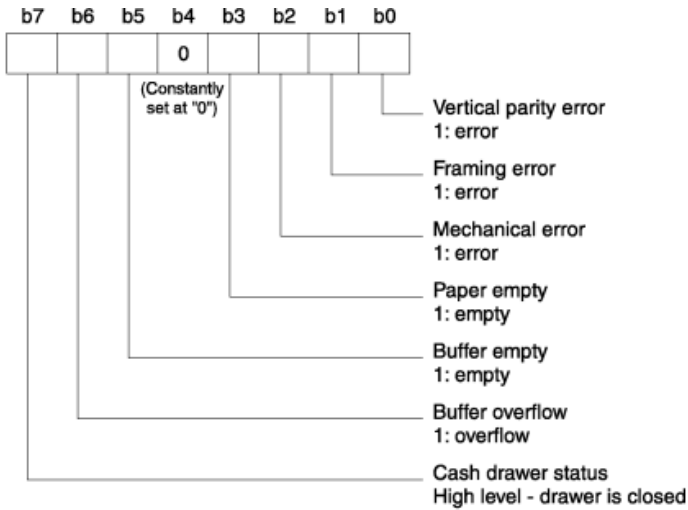

Figure 3-9. XON/XOFF Status Byte



9.3.3 STX-ETX Mode

Note: This mode is available only on the impact printer.

This mode is accessed from either DTR mode or XON/XOFF mode. To set this mode, the data buffer must be empty.

The application program sends an ENQ code to the printer logic and acknowledges the printer status. Then, the host computer checks that the printer buffer is empty. After the application program detects that the buffer is empty, an STX code and data are transmitted. After one block of data is transmitted, the application sends an ENQ code to the printer, then receives the printer status and check byte.

At this point, the system performs a status check. When the system determines that there was no error, it transmits an ETX code that serves as text end code. After the printer logic receives the ETX code, data in the data buffer is printed out. If an error occurs, a CAN code is transmitted by the application program. In this instance, the data that was previously sent to the buffer is cleared, thus, the application program must retransmit the same data to the printer logic.

Refer to Figure 3-10 for a flowchart of this operation.

Figure 3-10. STX-ETX Mode Flowchart for Host



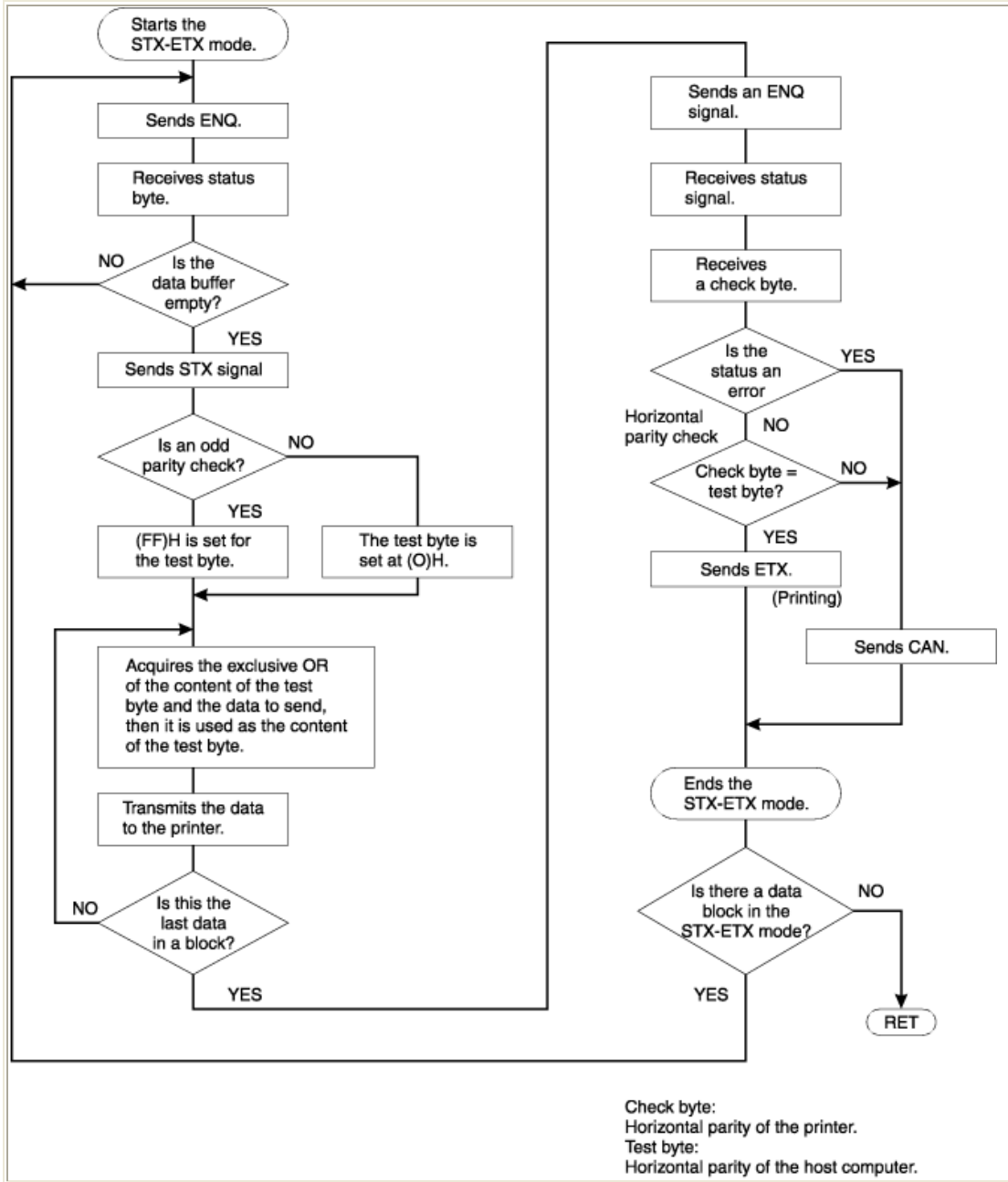

The printer supports the code pages described in this document except that it does not support any characters in positions 00h to 1Fh. Additional exceptions are documented on each code page.

9.3.4 Star Mode Commands

Note: This section uses the following conventions:

The "value" in quotes is the ASCII hex representation of the value. For example, the ASCII value for the numeral 1 is 31h. The value n is the ASCII value. When n=1, the hex code 31h is represented.

The in brackets is either the absolute hex value or represents the ASCII control code. For example, if the value is , then that represents the hex byte 01h, is hex byte 1Bh.

9.3.4.1 IBM Extended Commands

Function:

Select international character set

Code:

"T" n

1Bh 54h n

Outline:

Selects the international character set corresponding to the value set for n. n must be a 4-byte ASCII string where the string value represents the code page and is one of the following:

Refer to the Star documents (["Related Publications and Diskettes"](#)) for the character sets for code pages 0000, 0001, and 0002 in the list that follows.

0000 Star USA/Europe

0001 Star IBM#1

0002 Star IBM#2

0003 Star Japan (Katakana)

0850 (Multilingual)

0852 (Eastern Europe)

0855 (Bulgaria)

0857 (Turkey)

0862 (Israel)

0864 (Arabic)

0866 (Russia)

0869 (Greece) - Impact printer only

0874 (Thailand)

The default international character set is 0850.

Function:

~~Select paper width~~ Null (select paper width on original SureOne printer, not supported on MP512)

Code:

"Y" n

1Bh 59h n

Outline:

This command does nothing. Function on original SureOne printer is shown below.

Selects the paper width. n is a 1-byte ASCII string where n represents the paper width and is one of the following:

0 = 3.25 inch (82.5 mm) wide paper (power-up default)

1 = 2.25 inch (57.5 mm) wide paper

Function:

Set XON/OFF mode

Code:

Outline:

Sets XON/OFF mode

Function:

Set DTR mode

Code:

Outline:
Sets DTR Mode

9.3.4.2 Existing Star Commands

Function:
Selects an international character set

Code:
"R" n
1Bh 52h n

Outline:
Selects an international character set according to the value of n, as shown below:

n
Character set
0
U.S.A.
1
France
2
Germany
3
U.K.
4
Denmark I
5
Sweden
6
Italy
7
Spain I
8
Japan
9
Norway
10
Denmark II
11
Spain II
12
Latin America

When the value of n is 0 to 9, 0(00h) to 9(09h) or "0"(30h) to "9"(39h) can be set. When the value of n is 10 to 12, 10(0Ah) to 12(0Ch) or "A"(41h) to "C"(43h) can be set.

Function:
Select IBM character set 2.

Code:
"6"
1Bh 36h

Outline:
Selects IBM character set 2.

Note:
This code is valid only when the character code set by the ESC T command is set for IBM character set 1 or 2.

Function:
Select IBM character set 1.

Code:

"7"

1Bh 37h

Outline:

Selects IBM character set 1.

Note:

This code is valid only when the character code table set by the ESC T command is set for IBM character set 1 or 2.

Function:

Select normal character spacing

Code:

"M"

1Bh 4Dh

Outline:

This code is valid only when received at the beginning of a line. For the impact printer, the maximum number of print columns varies with the setting of the paper width DIP switch.

Impact Printer:

7 x 9 half-dots

3.25-in. paper - maximum print columns = 40

2.25-in. paper - maximum print columns = 28

Characters per inch (CPI) = 15.4

Thermal Printer:

12-dot pitch printing

Maximum print columns = 48

Characters per inch (CPI) = 16.9

Function:

Select medium character spacing

Code:

"g"

1Bh 67h

Outline:

Prints 12-dot pitch characters with 2-dot spacing between characters.

Function:

Select wide character spacing

Code:

"P"

1Bh 50h

Outline:

This code is valid only when received at the beginning of a line. For the impact printer, the maximum number of print columns varies with the setting of the paper width DIP switch.

Impact Printer:

5 x 9 two-pulse printing

3.25-in. paper - maximum print columns = 33

2.25-in. paper - maximum print columns = 23

Characters per inch (CPI) = 12.8

Thermal Printer:

15-dot pitch printing

Maximum print columns = 38

Characters per inch (CPI) = 13.5

Function:

Select extra-wide character spacing

Code:
":"

1Bh 3Ah

Outline:

This code is valid only when received at the beginning of a line. For the impact printer the maximum number of print columns varies with the setting of the width DIP switch.

Thermal Printer:

5 x 9 three-pulse printing

3.25-in. paper - maximum print columns = 22

2.25-in. paper - maximum print columns = 15

Characters per inch (CPI) = 8.5

Thermal Printer:

16-dot pitch printing

Maximum print columns = 36

Characters per inch (CPI) = 12.7

Function:

Set the character spacing

Code:

n

1Bh 20h n

Outline:

Sets the space between characters to n dots, where n is a number from 0 to 15. When the value of n is 0 to 9, 0(00h) to 9(09h) or "0"(30h) to "9"(39h) can be set. When the value of n is 10 to 15, 10(0Ah) to 15(0Fh) or "A"(41h) to "F"(46h) can be set.

Function:

Select 2X character width mode

Code:

0Eh

Outline:

Data following this code is printed in double-width characters.
Same as "W" "1" or "W" .

Function:

Cancel 2X character width mode

Code:

14h

Outline:

Cancels expanded character width set by or "W" code. Data following this code is printed out in normal width characters.
Same as "W" "0" or "W" .

Function:

Set expanded character width mode

Code:

"W" "n" or "W" <n>

1Bh 57h "n" or 1Bh 57h

Outline:

Data following this code is printed in expanded-width characters.

n

Character width

0

normal

1
double
2
triple
3
quadruple
4
quintuple
5
sextuple

Note: Numbers 2-5 are for the thermal printer only.

Function:
Select 2X character height mode
Code:
"
1Bh 0EH
Outline:
Data following this code is printed in double height characters. Same as "h" "1" or "h" .

Function:
Select 2X character height mode
Code:
"
1Bh 14h
Outline:
Cancels expanded character height set by or "h" code. Data following this code is printed out in normal height characters. Same as "h" "0" or "h" .

Function:
Set expanded character height
Code:
"h" "n" or "h"
1Bh 68h "n" or 1Bh 68h
Outline:
Prints characters with expanded character height after the code is received.
However, the bit image mode "K" and "L" are excluded for the impact printer.
Note:
When combined with code, this code enables printing of the characters twice the normal vertical and horizontal size.
This code is not combined with the inverted print mode code for the impact printer.
Character Height - n
n
Character Height
0
normal
1
double
2
triple
3
quadruple
4
quintuple
5
sextuple

Note: Numbers 2 through 5 are for the thermal printer only.

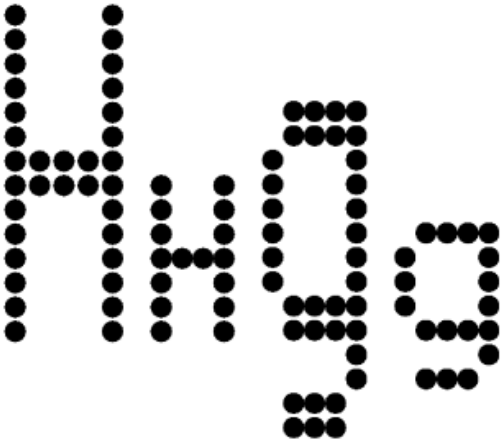

Function:
Select emphasized print mode
Code:
"E"
1Bh 45h
Outline:
Data following this code is printed in the emphasized print mode. In this mode, the only unidirectional printing is performed for the Impact printer.

Function:
Select emphasized print mode
Code:
"G"
1Bh 47h
Outline:
Causes subsequent characters to be emphasized.

Function:
Cancel emphasized print mode
Code:
"F"
1Bh 46h
Outline:
Cancels emphasized print mode.

Function:
Cancel emphasized printing
Code:
"H"
1Bh 48h
Outline:
Cancels emphasized printing.

Function:
Select underline mode

Code:

"_" "n" or "_"

1Bh 2Dh "n" or 1Bh 2Dh

Outline:

When n=1, data following this code is printed out underlined, except for the spaces generated by horizontal tabs. When n=0, underline mode is cancelled.

Function:

Select overline mode

Code:

"_" "n" or "_"

1Bh 5Fh "n" or 1Bh 5Fh

Outline:

When n=1, data following this code is printed out with an overline, except for the spaces generated by horizontal tabs. When n=0, overline mode is cancelled.

Function:

Select highlighted print mode

Code:

"4"

1Bh 34h

Outline:

Prints with highlighted characters. For the impact printer, if an underline, overline, or inverted print command is input while the highlighted print mode is in effect, the highlighted mode cancels and the new input command executes. If a highlighted print command is received while the underline, overline, or inverted print mode is in effect, the previously set mode cancels and the new input command (highlighted) executes.

Function:

Cancel highlighted print mode

Code:

"5"

1Bh 35h

Outline:

Cancels highlighted print mode.

Function:

Select inverted print mode

Code:

0Fh

Outline:

Data following this code is printed out in inverted characters. For the impact printer, this code is valid only when input at the beginning of a line. For the impact printer, normal and inverted characters cannot be mixed on the same line.

Function:

Cancel inverted print mode

Code:

12h

Outline:

Cancels the inverted character mode. For the impact printer, this code is valid only when input at the beginning of a line.

9.3.5 Control Codes Used for Line Spacing

Function:
Line feed
Code:

0Ah
Outline:
Data in the line buffer is printed out and one line is fed. If no data is in the line buffer before this code is received, the printer feeds one line.

Function:
Carriage return
Code:

0Dh
Outline:
Functions the same as the code.

Notes:

The default DIP switch setting for the impact printer ignores this code.
The default memory switch setting for the thermal printer ignores this code.

Function:
Set normal line spacing
Code:
"z" "1" or "z"
1Bh 7Ah 31h or 1Bh 7Ah 01h
Outline:
Line spacing is set at 1/6 inch for the impact printer and 4 mm for the thermal printer after this code is received.

Function:
Set compact line spacing
Code:
"0"
1Bh 30h
Outline:
Line spacing is set at 1/8 inch for the impact printer and 3 mm for the thermal printer after this code is received.

Function:
Feed paper n lines
Code:
"a" n
1Bh 61h n
Definition Range:
1 <= n <= 127
Outline:
After data in the line buffer is printed, paper feeds n lines.

Function:
Set tight line spacing
Code:
"1"
1Bh 31h
Outline:
Line spacing is set at 7/72 inch for the impact printer and 3 mm for the thermal printer after this code is received.

Function:
Define n/72 inch line feed
Code:
"A" n
1Bh 41h n
Definition Range:
0 <= n <= 85 (default n = 12)
Outline:
Line feed is set at n/72 inch after this code is received.
This code sets the feed a n/72 inch with the "2" code.

Function:
Set n/72 inch line feed
Code:
"2"
1Bh 32h
Outline:
Sets the line feed at a defined value with the "A"

Function:
One-time micro line feed
Code:
"J" n
1Bh 4Ah n
Definition Range:
1 <= n <= 255
Outline:
Activates the n/72 inch paper feed once for the impact printer, and n/4 mm for the thermal printer

Function:
One-time n/4 mm backfeed
Code:
"j" n
1Bh 6Ah n
Outline:
Feeds the paper back n/4 mm once only. The value of n is 1 to 255. Space setting for one line is not changed.
This command can also feed the paper back to the page before the current page. In this case, the position of the line on the previous page is determined by the page length control.

Function:
One-time n/8 mm feed
Code:
"l" n (l = capital i)
1Bh 49h n
Outline:
Performs a line feed n/8 mm once only. The value of n is 1 to 255. Space setting for lines is not changed.

Function:
Set crowded line spacing
Code:
"z" "0" or "z"
1Bh 7Ah 30h or 1Bh 7Ah 00h
Outline:
Line feed is set at 1/12 inch for the impact printer and 3 mm for the thermal printer after this code is received.

Function:
Set n/144 inch line feed
Code:
"y" n
1Bh 79h n
Definition Range:
1 <= n <= 255
Outline:
Line feed is set at n/144 inch after this code is received.

Function:
Set n/216 inch line feed
Code:
"3" n
1Bh 33h n
Definition Range:
1 <= n <= 255
Outline:
Line feed is set at n/216 inch after this code is received.
The actual line feed is set at INT (n X 2/3 + 0.5)/144 inch.

9.3.6 [Control Codes Used for Page Layout](#)

Function:
Form feed
Code:

0Ch
Outline:
After data in the buffer is printed, paper feeds to the top of the next page.

Function:
Set page length in lines
Code:
"C" n
1Bh 43h n
Definition Range:
Default value = 42,
1 <= n <= 255 (Impact printer)
1 <= n <= 127 (Thermal printer)
Outline:
Sets the page length at n lines.

Function:
Set page length in inches
Code:
"C" n
1Bh 43h 00h n
Definition Range:
1 <= n <= 127 (Impact printer)
1 <= n <= 22 (Thermal printer)
Outline:
Sets the page length at n inches.

Function:

Execute vertical tab
Code:

0Bh
Outline:

Feeds the paper to the next vertical tab set position. When a vertical tab is not set, line feed is not performed. If the current line is at or below the last vertical tab set position, the paper feeds to the top of the next page.

Function:
Set vertical tab position
Code:

"B" n1 n2...nk
1Bh 42h n1 n2...nk 00h

Definition Range:
 $1 \leq n1 < n2 < n3 \dots < nk \leq 255, 1 \leq k \leq 16$

Outline:
Cancels all current vertical tab positions and sets new vertical tab positions at lines n1, n2, where n1, n2 are numbers between 1 and 255. A maximum of 16 vertical tab positions can be set. The tab positions must be specified in ascending order; any violation of ascending order terminates the tab position list. Standard termination is by the control code. The vertical tab positions are set in terms of the current line spacing and do not move if the line spacing is changed later.

Note:
If a tab set position <nk> is equivalent or smaller than <nk - 1> just preceding the tab set position, setting of vertical tab is assumed as complete.

Function:
Set bottom margin
Code:

"N" n
1Bh 4Eh n

Definition Range:
Default value = 0
 $0 \leq n \leq 255$ (Impact printer)
 $0 \leq n \leq 127$ (Thermal Printer)

Outline:
Sets bottom margin to n lines.

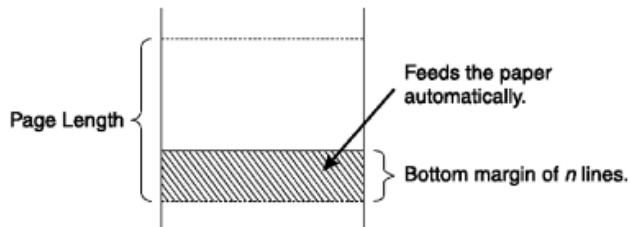

Function:
Cancel bottom margin

Code:
"O" (letter O)
1Bh 4Fh

Outline:
Cancels bottom margin.

Function:

Set left margin

Code:

"l" n (l = lowercase L)

1Bh 6Ch n

Definition Range:

$0 \leq n \leq (\text{right margin} - 2)$ (Impact Printer)

$0 \leq n \leq (\text{right margin} - 2)$ (Thermal printer)

Outline:

Sets the left margin at column n in the current character pitch. The left margin does not move if the character pitch is changed later. For the impact printer, the left margin must be at least two columns to the left of the right margin and within the limits above. For the thermal printer, the left margin must allow a line length of at least 36 mm, otherwise the command is ignored.

Function:

Set right margin

Code:

"Q" n

1Bh 51h n

Definition Range:

$2 \leq n \leq (\text{maximum number of print columns}) - 1$ (Impact Printer)

$1 \leq n \leq 255$ (maximum number of print columns) - (Thermal Printer)

Outline:

Sets the right margin at column n in the current character pitch. Column n becomes the last character position of the line. The right margin does not move if the character pitch is changed later. For the impact printer, the right margin must be at least two columns to the right of the left margin and within the limits above. For the thermal printer, the right margin must allow a line length of at least 36 mm, otherwise the command is ignored.

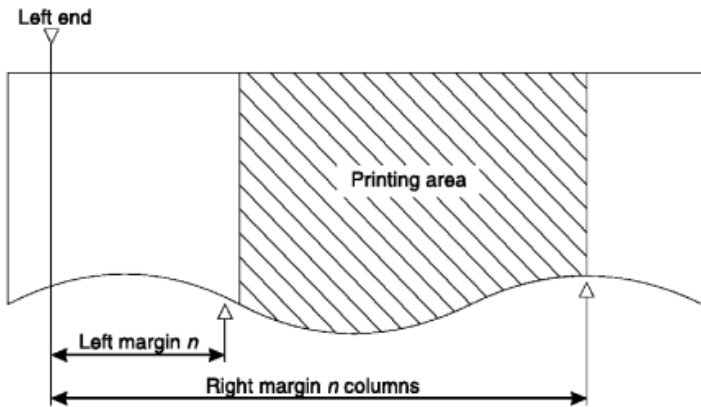

Function:

Execute horizontal tab.

Code:

09h

Outline:

The print position skips to the next horizontal tab position in line. When no horizontal tab position is set, this code is ignored. (Underlining and overlining do not take place in the spaces between characters set with the horizontal tab function.)

Function:

Set horizontal tab position

Code:

"D" n1 n2...nk

1Bh 44h n1 n2...nk 00h

Definition Range:

1 <= n1 <n2 <n3...<nk <= (maximum no. of print columns), 1 <=k <=16

Outline:

Cancels all current horizontal tab positions and sets new tab positions at columns n1, n2, etc. in the current character pitch. The maximum number of horizontal tab positions allowed is 16. The tab positions must be specified in ascending order; any violation of ascending order terminates the tab position list. Standard termination is by the control code. To clear all tab positions, specify "D" .

Note:

When the horizontal tab set position <nk> is equivalent or smaller than <nk - 1> (which is the column just preceding the set tab position) vertical tab setting is assumed as complete.

9.3.7 Control Codes Used for Graphics Printing

Function:

Normal density graphics

Code:

"K" n1 m1 m2....

1Bh 4Bh n1 00h m1 m2....

Definition Range:

1 <= n1 <= 200 (Impact Printer)

1 <= n1 <= 192 (Thermal Printer)

Outline:

Executes normal density dot graphics. The total number of bit image data bytes in one line is equal to n1. The printer ignores any data bytes over the specified amount allowed in one line. When the bit image print is finished, the printer automatically returns to character mode. For the Impact printer, each data bit controls 1 dot. For the Thermal printer, each data bit controls a 3 x 3 dot block (0.375 mm x 0.375 mm).

Example:

The following design is created using the bit image in the table. Because the volume of data is 30, n1 = 1Eh.

	m1	m2	m3	m4	m5	m6	m7	m8	m9	m10	m11	m12	m13	m14	m15	m16	m17	m18	m19	m20	m21	m22	m23	m24	m25	m26	m27	m28	m29	m30
D8																														
D7																														
D6																														
D5																														
D4																														
D3																														
D2																														
D1																														

Data	Binary	Hex	Data	Binary	Hex	Data	Binary	Hex
m1	00000001	01	m11	00111110	3E	m21	00111110	3E
m2	00011110	1E	m12	00000010	02	m22	00101110	2E
m3	00111110	3E	m13	00000010	02	m23	00101110	2E
m4	01011111	5E	m14	00111110	3E	m24	00111110	3E
m5	00011111	1F	m15	00111110	3E	m25	00101111	2F
m6	01011110	5E	m16	00101111	2F	m26	00101111	2F
m7	00011110	1E	m17	00010111	2F	m27	00111110	3E
m8	00111111	3F	m18	00111110	3E	m28	00111110	3E
m9	00101111	2F	m19	00101110	2E	m29	00000010	02

m10	00111110	3E	m20	00101110	2E	m30	00000010	02
-----	----------	----	-----	----------	----	-----	----------	----

Function:

High-density graphics

Code:

"L" n1 n2 m1 m2....

1Bh 4Ch n1 n2 m1 m2....

Definition Range:

1 <= n1 + 256 X n2 <= 400 - (Impact printer)

1 <= n1 + 256 X n2 <= 576 - (Thermal printer)

Outline:

Executes high-density dot graphics determined by n1 and n2. The total number of bit image data bytes in one line is equal to n1 + n2 X 256. Refer to K as to the relationship between the dot position and the bit number. The printer ignores any data bytes over the specified amount allowed in one line.

When the bit image printing is finished, the printer automatically returns to the character mode.

Note:

For the impact printer, dots cannot overlap each other in the horizontal direction.

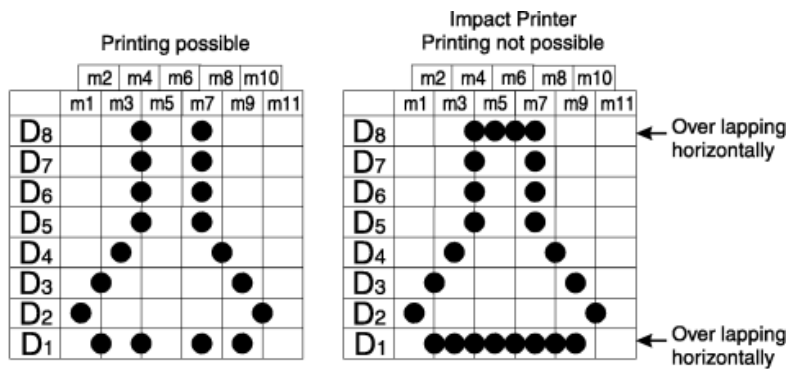

Function:

Print fine-density bit image

Code:

"k" n d1...dk

1Bh 6Bh n 00h d1...dk

Outline:

Prints a bit image using 1 horizontal dot and 1 vertical dot for 1 dot of input data. n is designated by the number of data bytes in the horizontal direction and n must be within the range 1 to 72. The data is ignored if it is longer than 72 digits or goes beyond the right margin. k = n x 24.

Function:

Print fine density graphics

Code:

"X" n1 n2 d1...d

1Bh 58h n1 n2 d1...dk

Outline:

Prints a bit image of the input data using horizontal and vertical resolutions of 8 dots/mm. Data extending past the right margin is ignored. k = (n1 + n2 x 256) x 3. 1 <= n1+n2 x 256 <= 576

9.3.8 [Control Codes Used for Character Downloading](#)

Function:

Definition of download characters for impact printer

Code:

When 7 X 9 (half-dots) font matrix is set (default setting):

"&" n1 n2 [m0 m1 m2 m3 m4 m5 m6 m7] n2 - n1 + 1

1Bh 26h 00h n1 n2 [m0 m1 m2 m3 m4 m5 m6 m7] n2 - n1 + 1

When 5 X 9 font matrix is set:

"&" n1 n2 m0 m1 m2 m3 m4 m5] n2 - n1 + 1

1Bh 26h 00h n1 n2 [m0 m1 m2 m3 m4 m5] n2 - n1 + 1

Definition Range:

21h <= n1 <= n2 <= n2 7Fh, m0 = 00h or m0 = 80h

Outline:

Defines download characters.

Up to 10 download characters can be defined and stored in the printer's RAM. Defining of download characters begins with character code n1 and completes with n2. When only one character is defined, n1= n2. m0 indicates the relationship between the character pattern and the print head. m1 m2...indicate the character pattern.

Note:

When the 7 X 9 (half-dots) font matrix is set (the default setting), printing of adjacent horizontal dots is not allowed.

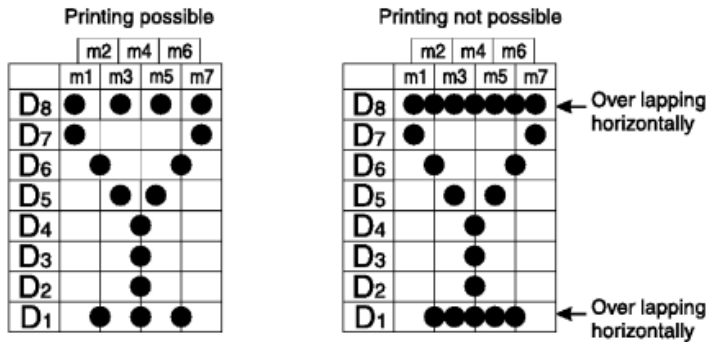

Function:

Enable download character set

Code:

"%" "1" or "%"

1Bh 25h 31h or 1Bh 25h 01h

Outline:

Enables the download character set. Download characters defined by the ESC & code cannot be printed until enabled by this command.

Function:

Disable download character set

Code:

"%" "0" or "%"

1Bh 25h 30h or 1Bh 25h 00h

Outline:

Disables the selected download character set and selects the built-in character set. When power to the printer is initially switched on, the built-in character set is selected.

Example:

For the Impact printer to print a download character when the 7 x 9 (half-dots) font matrix is set:

Design the download character to be used at code positions 21h, 22h, and 23h

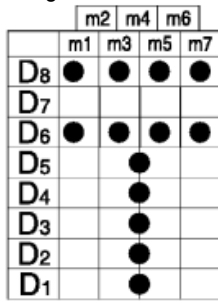

Char. Code = (21)H

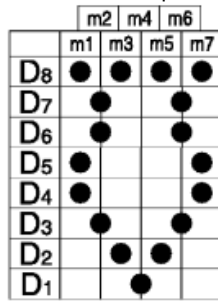

Char. Code = (22)H

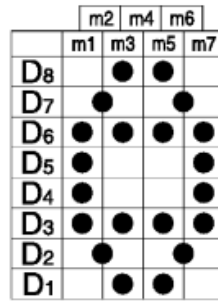

Char. Code = (23)H

Define the download characters. When character addresses where the download character are desired to be 21h, 22h, 23h, n1 = 21h) and n2 = 23h.

If the relationship between the character pattern data and the printing head is specified to "not use pin 9", m0 = 80h is obtained. When data m1 to m7 are converted into hexadecimal data, they are indicated as shown in [Table 3-5](#).

Table 3-5. Character Bit Images

Data	Binary	Hex	Data	Binary	Hex	Data	Binary	Hex
m1	10100000	A0	m1	10011000	98	m1	00111000	3C
m2	00000000	00	m2	01100100	64	m2	01000010	42
m3	10100000	A0	m3	10000010	82	m3	10100101	A5
m4	00011111	1F	m4	00000001	01	m4	00000000	00
m5	10100000	A0	m5	10000010	82	m5	10100101	A5
m6	00000000	00	m6	01100100	64	m6	01000010	42
m7	10100000	A0	m7	10011000	98	m7	00111000	3C

Example of Transmitting Data

Definition of download characters	1Bh 26h 00h 21h 23h 80h A0h 00h A0h 1Fh A0h 00h A0h 80h 98h 64h 82h 01h 82h 64h 98h 80h 3Ch 42h A5h 00h A5h 42h 3Ch
Selecting the download character set	1Bh 25h 31h
Character codes	21h 22h 23h 0Ah
Canceling the download character set	1Bh 25h 30h
Character codes	21h 22h 23h 0Ah

Function:

Define download character for thermal printer

Code:

"&" n m1 m2 ... m48

1Bh 26h 01h 01h m1 m2 ... m48

Code:

"&" "1" "1" n m1 m2 ... m48

1Bh 26h 31h 31h m1 m2 ... m48

Outline:

Defines one new character and stores it in RAM for later use. n is the character code of the character defined and must be from 32 to 127. If the maximum of 32 external characters have already been stored, the oldest stored external character is deleted so that a new external character can be stored. The character matrix is 12 dots wide and 24 dots high.

Function:

Delete a download character

Code:

"&" n

1Bh 26h 01h 00h n

Code:

"&" "1" "0" n

1Bh 26h 31h 30h n

Outline:

Deletes the download character that was assigned the value n.

9.3.9 [Cash Drawer Commands](#)

Function:

Adjust drive pulse width for cash drawer

Code:

n1 n2

1Bh 07h n1 n2

Definition Range:

1 <= n1 <= 127, 1 <= n2 <= 127 (default setting n1 = n2 = 20)

Outline:

Adjusts drive pulse width for peripheral devices requiring other than standard 200-ms pulse time and delay time.

Energizing time = 10 X n1 (ms)

Delay time = 10 X n2 (ms)

Executed by , codes.

Note:

n1 and n2 do not need to be specified for IBM or other cash drawers capable of being driven by a standard 200-ms pulse.

Function:

Deferred open command for cash drawer

Code:

07h

Outline:

Executes an open command for cash drawer after all previous bytes in the printer logic buffer have been processed.

Function:

Immediate drive command for cash drawer

Code:

1Ch

Outline:

Executes drive pulse for cash drawer immediately. This code differs from the code in that when the printer receives an code, the command is executed immediately. The code is stored in the data buffer in the same manner as other codes, and executed in the order in which they are received.

For additional information about cash drawer commands and the interfaces for the cash drawer, see ["Cash Drawer"](#)

9.3.10 [Other Control Codes](#)

Function:

Sound buzzer

Code:

1Eh

Outline:

Generates a short alarm.

Function:

Cancel print data in buffer

Code:

18h

Outline:

Clears data buffer and line buffer.

For the impact printer, clears the data in the data buffer in the STX-ETX mode.

Function:

Select unidirectional print mode

Code:

"U" "1" or "U"

1Bh 55h 31h or 1Bh 55h 01h

Outline:

The impact printer prints only when the print head moves from left to right.

Function:

Select bidirectional print mode

Code:

"U" "0" or "U"

1Bh 55h 30h or 1Bh 55h 00h

Outline:

The impact printer returns to the standard bidirectional print mode. This mode is set automatically when the printer power is switched on.

Function:

Initialize printer

Code:

"@"

1Bh 40h

Outline:

Cancels the various conditions set after the power was switched on and resets the printer to the initial settings in effect when the printer is switched on. In this instance, contents of the line buffer and the data buffer are not cleared.

Function:
Enquiry
Code:

05h

Outline:

Causes the control board to transmit a status byte. For the Impact printer, when this code is received after receiving text data in the STX-ETX mode, the control board transmits the status and check byte.

The status byte definition is as follows:

Bit

Definition

7

Cash drawer status, 0 = open

6

Printer buffer overflow = 1

5

Printer buffer empty = 1

4

Always 0

3

Paper empty = 1

2

Mechanical error = 1

1

Framing error = 1

0

Parity error = 1

Function:

Reset the printer hardware

Code:

"?"

1Bh 3Fh 0Ah 00h

Outline:

Resets the printer hardware.

Function:

Enter STX-ETX mode

Code:

02h

Outline:

Sets the STX-ETX mode.

Function:

Terminate STX-ETX mode

Code:

03h

Outline:

Terminates the STX-ETX mode and prints out the text data.

Function: Null (select validation printing on the original printer), MP512 Only

Code: <GS> data <LF>

1Dh Data 0AH

Outline: This command does nothing

Function:

~~Select validation printing~~–Null, was select validation printing on original SureOne offering

Code:

data

1Dh data 0Ah

Outline:

This command does nothing. Original SureOne printer function shown below for reference.

Prints up to 32 columns of the 15.4 CPI size characters on one line.

Notes:

Character data and immediate execution command are valid for data.

Printing modes (such as emphasized, inverted, expanded character modes) which were set before validation printing are invalid during validation printing. These modes become valid again after validation printing is completed.

Function:

Select bar code printing

Code:

"b" n1 n2 n3 n4 di ... dk

1Bh 62h n1 n2 n3 n4 di ... dk 1Eh

Outline:

Prints bar code according to the value of n1, as follows:

n1

Type of bar code

0

UPC-E

1

UPC-A

2

JAN/EAN-8

3

JAN/EAN-13

4

Code 39

5

ITF

6

Code 128

7

Code 93

8

NW-7

The value of n1 can be set to 0(00h) or 8(08h) or "0"(30h) to "8"(38h).

n2

Whether character below bar code or line feed is printed

1

No. Line feed is performed after execution of command.

2

Yes. Line feed is performed after execution of command.

3

No. Line feed is not performed after execution of command

4

Yes. Line feed is not performed after execution of command.

The value of n2 can be set to 1(01h) to 4(04h) or "1"(31h) to "4"(34h).

n3

Mode of bar code (UPC-E, UPC-A, JAN/EAN-8, JAN/EAN-13, CODE 128, CODE 93)

- 1
Minimum module of 2 dots
- 2
Minimum module of 3 dots
- 3
Minimum module of 4 dots

Mode of barcode (Code 39, NW-7, ITF)

n3	Code 39 & NW-7	ITF
1 Narrow : wide	2:6 dots	2:5 dots
2 Narrow : wide	3:9 dots	4:10 dots
3 Narrow : wide	4:12 dots	6:15 dots
4 Narrow : wide	2:5 dots	2:4 dots
5 Narrow : wide	3:8 dots	4:8 dots
6 Narrow : wide	4:10 dots	6:12 dots
7 Narrow : wide	2:4 dots	2:6 dots
8 Narrow : wide	3:6 dots	3:9 dots
9 Narrow : wide	4:8 dots	4:12 dots

When the value of n3 is UPC-E, UPC-A, JAN/EAN-8, JAN/EAN-13, Code 128 or Code 93, 1(01h) to 3(03h) or "1"(31h) to "3"(33h) can be set. When the value of n3 is CODE 39, NW-7 or ITF, 1(01h) to 9(09h) or "1"(31h) to "9"(39h) can be set.

n4 Height of Bar Code:

The height of the bar code can be up to 255 dots (31.9 mm / 1.256 in.). If the bar code is higher than the line feed amount, the line feed amount is automatically multiplied by an integer.

di...dk

Bar code data

UPC-E/UPC-A: K = 11 (or 12)

The check digit at the 12th digit is automatically added, and ignored even if it is specified.

JAN/EAN-8: K = 7 (or 8)

The check digit at the 8th digit is automatically added, and ignored even if it is specified.

JAN/EAN-13: K = 12 (or 13)

The check digit at the 13th digit is automatically added, and ignored even if it is specified.

CODE 39:

The value of k is optional, and the maximum value also differs according to the modes (21 digits maximum in mode 7). The start/stop code (" * ") is automatically added.

ITF:

The value of k is optional, and the maximum value also differs according to the modes (40 digits maximum in mode 4). If the data is number of an odd digits, 0 is automatically added at the beginning of the data.

Code 128:

The value of k is optional, and the maximum value also differs according to the modes and the types of character number (51 digits maximum in mode 1). The check character is automatically added.

CODE 93:

The value of k is optional, and the maximum value also differs according to the modes and the types of character (30 digits maximum in mode 1). The check characters (C and K) are automatically added.

NW-7:

The value of k is optional, and the maximum value also differs according to the modes and the types of character number (29 digits maximum in mode 7). The start/stop code is also contained in the data (it is not automatically added).

The bar code printing start position is at the upper end of the current line. If the bar code is positioned beyond the right margin, neither the bar code nor the character below the bar code will be printed.

Data of CODE 128 and CODE 93

When is used in a command, some kinds of control code cannot be sent by the host PC. The control code should be sent as the data as shown below:

When sending the following data, express as a set of two characters. Express "% (25h)" as "%0 (25h - 30h)". Add "40h - 5Fh" after "%" for the control codes (00h - 1Fh). Express the control code (7Fh) as "%5(25h - 35h)". Add "1 - 4 (31h - 34h)" after "%" for the function code. Add "6 - 8 (36h - 38h)" after "%" for the start code.

9.3.11 [Control Codes](#)

Code	Format
NUL	00h %@ 25h 40h
SOH	01h %A 25h 41h
STX	02h %B 25h 42h
ETX	03h %C 25h 43h
EOT	04h %D 25h 44h
ENQ	05h %E 25h 45h
ACK	06h %F 25h 46h
BEL	07h %G 25h 47h
BS	08h %H 25h 48h
HT	09h %I 25h 49h
LF	0Ah %J 25h 4Ah
VT	0Bh %K 25h 4Bh
FF	0Ch %L 25h 4Ch
CR	0Dh %M 25h 4Dh
SO	0Eh %N 25h 4Eh
SI	0Fh %O 25h 4Fh
DLE	10h %P 25h 50h
DC1	11h %Q 25h 51h
DC2	12h %R 25h 52h
DC3	13h %S 25h 53h
DC4	14h %T 25h 54h
NAK	15h %U 25h 55h
SYN	16h %V 25h 56h
ETB	17h %W 25h 57h
CAN	18h %X 25h 58h
EM	19h %Y 25h 59h
SUB	1Ah %Z 25h 5Ah
ESC	1Bh %[25h 5Bh
FC	1Ch %Ñ 25h 5Ch
GS	1Dh %j 25h 5Dh
RS	1Eh %^ 25h 5Eh
US	1Fh %_ 25h 5Fh
DEL	7Fh %5 25h 35h

9.3.11.1 [Special Code Format](#)

Code	Format
% 25h	%0 25h 30h

9.3.11.2 [Function Codes Format](#)

Code	Format
FNC1	%1 25h 31h *
FNC2	%2 25h 32h *
FNC3	%3 25h 33h *
FNC4	%4 25h 34h *

* = For CODE 128 only

9.3.11.3 Start Codes Format

Code Format
 START A %6 25H 36H *
 START B %7 25H 37H *
 START C %8 25H 38H *
 * = For CODE 128 only

Function:

Full-cut command to the auto-cutter

Code:

"d" "0" or "d"

Outline:

Cuts the paper partially when memory switch #2, bit C is set to 0. If memory switch #2, bit C is set to 1, the paper is fed 18 mm (0.7 in.) and then cut fully. When the auto-cutter is invalid (set by memory switch #2, bit 8), this command is ignored.

Function:

Partial-cut command to the auto-cutter

Code:

"d" "1" or "d"

Outline:

Cuts the paper partially when memory switch #2, bit C is set to 0. If memory switch #2, bit C is set to 1, the paper is fed 18 mm (0.7 in.) and then cut partially. When the auto-cutter is invalid (set by memory switch #2, bit 8), this command is ignored.

Function:

Set memory switch

Code:

"#N,n1n2n3n4"

1Bh 23h N 2Ch n1n2n3n4 0Ah 00h

Outline:

Set the memory switch. The memory switch is a "soft" dip switch to set the printer configuration. After the memory switch command has been sent, the setting can be enabled by setting the printer OFF and ON again or sending the printer reset command "?" to the printer. Changed memory switch settings are stored in EEPROM and these settings will be stored permanently on the printer logic circuit board.

Table 3-6. Default Memory Switch Settings (n1n2n3n4)

N	Standard	Japanese	Korean	Simplified Chinese	Traditional Chinese
0	0000	0010	0010	0010	0010
1	0100	0100	0100	0100	0100
2	0100	0100	0100	0100	0100
3	0300	0000	0000	0010	0010
4	0000	0000	0000	0000	0000
E	0000	0000	0000	0000	0000

Note: Memory switch "D" is not shown because it does not have a default setting.

To set the memory switches for the Standard, Traditional Chinese, or Simplified Chinese versions to match the Star TSP200 series printer, send the following commands to the printer:

"#3,0000"
 "?"

Note: On the Standard version, this will change the default power-on character set from "Multilingual" (code page 850) to Star "Normal".

On the Simplified Chinese and Traditional Chinese versions, this will change number of characters per line from 44 to 38 alphanumeric, and from 22 to 19 DBCS.

N

Memory switch number (0, 1, 2, 3, 4, D, E)

n1n2n3n4

Mode settings (see details in [Table 3-7](#) through [Table 3-18](#)).

Table 3-7. Memory Switch #0

n	Bit	Function	0	1	Notes
n1	F				
n1	E				
n1	D				
n1	C				
n2	B				
n2	A				
n2	9				
n2	8				
n3	7				
n3	6				
n3	5				
n3	4			DBCS	Not available on Standard version
n4	3	cut	Full cut	Partial cut	
n4	2		Form feed	Feed and cut	
n4	1				
n4	0				

Table 3-8. Memory Switch #1

n	Bit	Function	0	1	Notes
n1	F				
n1	E				
n1	D				
n1	C				
n2	B				
n2	A				
n2	9				
n2	8				
n3	7				
n3	6				

n3	5				
n3	4	Zero style	Normal	Slash	
n4	3	International character set	See Table 3-9	See Table 3-9	Standard and Japanese versions only
n4	2	International character set	See Table 3-9	See Table 3-9	Standard and Japanese versions only
n4	1	International character set	See Table 3-9	See Table 3-9	Standard and Japanese versions only
n4	0	International character set	See Table 3-9	See Table 3-9	Standard and Japanese versions only

Table 3-9. International Character Set

n4	Country
0	USA
1	France
2	Germany
3	UK
4	Denmark #1
5	Sweden
6	Italy
7	Spain #1
8	Japan
9	Norway
A	Denmark #2
B	Spain #2
C	Latin America
D	Reserved
E	Reserved
F	Reserved

Table 3-10. Memory Switch #2

n	Bit	Function	0	1	Notes
n1	F				
n1	E				
n1	D				
n1	C	"d"	Cut	Feed & cut	
n2	B				
n2	A				

n2	9				
n2	8	Auto-cutter	Invalid	Valid	
n3	7				
n3	6				
n3	5				
n3	4				
n4	3				
n4	2				
n4	1				
n4	0	Paper Near End sensor	Invalid	Valid	

Table 3-11. Memory Switch #3

n	Bit	Function	0	1	Notes
n1	F				
n1	E				
n1	D				
n1	C	Shift JIS Kanji	Valid	Invalid	Japanese version only
n2	B				
n2	A				
n2	9	Character table	See Table 3-12	See Table 3-12	Standard and Japanese versions only
n2	8	Character table	See Table 3-12	See Table 3-12	Standard and Japanese versions only
n3	7				
n3	6				
n3	5				
n3	4	Print Column	See Table 3-13	See Table 3-13	
n4	3				
n4	2				
n4	1	code	Invalid	Valid	
n4	0	Line Pitch	4 mm	3 mm	

Table 3-12. Character Table

n2	Character Table
0	Normal
1	IBM

2	Katakana
3	Multilingual (CP850)

Table 3-13. Character Table

n3	0	0	1	1
Version	ANK	DBCS	ANK	DBCS
Standard	48	N/A	38	N/A
Japanese	48	22	38	19
Korean	44	22	38	19
Simplified Chinese	38	19	44	22
Traditional Chinese	38	19	44	22

Table 3-14. Memory Switch #4

n	Bit	Function	0	1	Notes
n1	F				
n1	E				
n1	D				
n1	C				
n2	B				
n2	A				
n2	9				
n2	8	Buffer size	4 KB	45 bytes	
n3	7				
n3	6				
n3	5				
n3	4	Busy Condition	See Table 3-15	See Table 3-15	ESC/POS mode only
n4	3				
n4	2				
n4	1				
n4	0				

Table 3-15. Busy Condition

Printer	Bit 4 "0"	Bit 4 "1"
Until printer ready after power on	Busy	Busy
Until printer ready after I/F reset	Busy	Busy
While self test printing	Busy	Busy
Cover open	Busy	

While feeding paper with feed switch	Busy	
Paper out (or paper near end)	Busy	
While macro function is running	Busy	
Error condition	Busy	
Buffer full	Busy	

Table 3-16. Memory Switch #D

n	Bit	Function	0	1	Notes
n1	F				
n1	E				
n1	D				
n1	C				
n2	B				
n2	A				
n2	9	Head Rank	See Table 3-17	See Table 3-17	Not for application program use
n2	8	Head Rank	See Table 3-17	See Table 3-17	Not for application program use
n3	7				
n3	6				
n3	5				
n3	4				
n4	3				
n4	2				
n4	1				
n4	0				

Table 3-17. Head Rank

n2	bit 9	bit 8	Head Rank
0	0	0	A
1	0	1	B
2	1	0	C
3	1	1	C

Table 3-18. Memory Switch #E

n	Bit	Function	0	1	Notes
n1	F	Print Density	See Table 3-19	See Table 3-19	
n1	E	Print	See	See Table	

	Density	Table 3-19		
n1	D			
n1	C			
n2	B			
n2	A			
n2	9			
n2	8			
n3	7			
n3	6			
n3	5			
n3	4	Emulation Mode	Star ESC/POS	Standard and Japanese versions only
n4	3			
n4	2			
n4	1			
n4	0	Handshake	DTR XON/XOFF	

Table 3-19. Print Density

n1	bit F	bit E	Print Density	Note
C	1	1	Low	Level 1
0	0	0	Normal	Level 2
8	1	0	Medium High	Level 3
4	0	1	High	Level 4

Function: Program memory switch into printer RAM, MP512 Only

Code: <ESC><GS> #m N n1n2n3n4 <LF><NUL>
1Bh 1Dh m N n1n2n3n4 0Ah 00h

m=","; Define memsw data as "word set"
N: number of memsw
n1n2n3n4: defined data

Outline: The memory switch is a "soft" dip switch to set the printer configuration. After the memory switch command has been sent the setting can be enabled by issuing the update and enable memory switch settings command.

Function: Update and enable memory switch settings, MP512 Only

Code: <ESC> <GS> "#W00000" <LF><NUL>
1Bh 1Dh W00000 0Ah 00h

Outline: Writes settings updated by the program memory switch command into the printer's flash memory, and resets the printer to enable the new memory switch settings. Multiple memory switch settings can be programmed for each set memory switch command. This operation should not be performed on a per receipt basis as it may decrease printer life.

Function:
Vertical Column Alignment

Code:

"@"

1Bh 17h 40h

Outline:

Note: This command is not intended for use by an application program.

The alignment routine adjusts the timing of the print wires of the two heads relative to each other.

This causes the printer to print 7 numbered vertical lines with different timing on each line. The line highlighted with an asterisk (*) is current setting.

The diagnostic program prompts the user to select the line that prints with the highest quality (most straight vertical lines). When the user enters the line number, the printer is set with the value using the following command:

"n" where n is an ASCII digit between 1 and 7

1Bh 17h (for example, 31h-37h)

The printer then prints that pattern and saves the setting in NVRAM.

Function:

Print Density

Code:

"{" "00"

1Bh 7B 30h 30h

Outline:

Note: This command is not intended for use by an application program.

This command adjusts the impact force of the two heads for correct print density. This causes the printer to print 11 numbered vertical lines of a solid bar. The line highlighted with an asterisk (*) is the current setting.

The diagnostic program prompts the user to select the line that prints with the highest quality (most even darkness left to right). When the user enters the line number, the printer is set with the value using the following command:

"{" "n1n2"

where "n1n2" are two ASCII digits between 01 and 11

1Bh 7B

The printer then prints that pattern and saves the setting in NVRAM.

9.3.12 [ESC/POS Mode Commands](#)

Note: ESC/POS mode is available on the Standard and Japanese versions only. ESC/POS mode can be set via memory switch #E, bit 4. Refer to the Seiko-Epson Command Reference for additional information about ESC/POS commands.

Control Code	Hexadecimal	Code Function
HT	09	Horizontal tab
LF	0A	Print line feed
FF	0C	Page mode print and return
DLE EOT	10 04	Real time transmission of status
DLE ENQ	10 05	Real time request to printer
CAN	18	Cancel print data in page mode
ESC CAN	1B 18 0A 00	Hardware Reset

SurePOS 100 Technical Reference

ESC FF	1B FF	Print page mode data
ESC SP	1B 20	Set right space amount of character
ESC !	1B 21	Universal print mode designation
ESC #	1B 23	Set memory switch
ESC \$	1B 24	Designate absolute printing
ESC %	1B 25	Designate/cancel download character set
ESC &	1B 26	Define download characters
ESC *	1B 2A	Designate bit image mode
ESC -	1B 2D	Designate/cancel underline
ESC 2	1B 32	Set 1/6 inch line feed amount
ESC 3	1B 33	Set line feed amount
ESC =	1B 3D	Select peripheral equipment
ESC ?	1B 3F	Delete download characters
ESC @	1B 40	Initialize printer
ESC D	1B 44	Set horizontal tab position
ESC E	1B 45	Designate/cancel emphasized print
ESC G	1B 47	Designate/cancel double print
ESC J	1B 4A	Print and paper feed
ESC L	1B 4C	Select page mode
ESC R	1B 52	Select international characters
ESC S	1B 53	Select standard mode
ESC T	1B 54	Select character print direction in print mode
ESC V	1B 56	Designate/cancel 90-deg. character rotation
ESC W	1B 57	Set print range in page mode
ESC \	1B 5C	Designate relative position
ESC a	1B 61	Align position
ESC c4	1B 63 34	Select no valid paper detector at print stop
ESC c5	1B 63 35	Enable/disable panel switch
ESC d	1B 64	Print and paper feed <i>n</i> lines
ESC i	1B 69	Partial cut (one section remaining)
ESC p	1B 70	Designate pulse generation
ESC t	1B 74	Select character code table
ESC u	1B 75	Transmission of peripheral equipment status
ESC v	1B 76	Transmission of paper detection status
ESC {	1B 7B	Designate/cancel inverted printing
GS !	1D 21	Designate character size

GS \$	1D 24	Designate absolute position of vertical direction of characters in page mode
GS *	1D 2A	Define download bit image
GS /	1D 2F	Print download bit image
GS :	1D 3A	Start/finish macro definition
GS B	1D 42	Designate/cancel reverse printing
GS H	1D 48	Select print position of HRI characters
GS I	1D 49	Printer ID transmission
GS L	1D 4C	Set left margin
GS P	1D 50	Set basic calculated pitch
GS V	1D 56	Paper cut
GS W	1D 57	Set print range
GS \	1D 5C	Designate the relative position of vertical characters when printing in the page mode
GS ^	1D 5E	Execute macro
GS a	1D 61	Enable/disable automatic status transmission
GS f	1D 66	Select HRI character font
GS h	1D 68	Set bar code height
GS k	1D 6B	Printing of bar code
GS r	1D 72	Transmission of status
GS w	1D 77	Set lateral size of bar code

9.4 [Cash Drawer](#)

The SurePOS 100 supports the industry standard Star interface for the cash drawer. Commands are actually written to the printer port and the printer electronics control the cash drawer. This interface can drive a 24 V cash drawer with drive current up to 1 A.

In addition to the industry standard interface that opens a drawer and detects that it is open, the SureOne POS Terminal also implements the 4680/4690 function of detecting that the cash drawer is attached to the system when an IBM or compatible cash drawer is used. There is also a simple cash drawer interface for terminals not equipped with a printer.

Cash drawer open status can be determined through the Enquiry printer command.

There is also logic within the SurePOS 100 ASIC chip to drive the cash drawer in the event a printer is not installed. This circuitry is also used to tell if a cash drawer is physically attached to the system and to determine which circuit, printer or ASIC, controls the cash drawer interface.

Control register S

Cash drawer setup

INDEX 28H:

Read/write

D7	D6	D5	D4	D3	D2	D1	D0	Function
x	x	x	x	x	x	x	1	disable C/D driver
x	x	x	x	x	x	x	0	enable C/D driver
x	x	x	x	x	x	1	x	C/D pulse = 100 mS (recommended)
x	x	x	x	x	x	0	x	C/D pulse = 50 mS

SurePOS 100 Technical Reference

x	x	x	x	x	0	x	x	<i>C/D controlled by prt logic</i>
x	x	x	x	x	1	x	x	<i>C/D controlled by ASIC</i>

Control register T
Cash drawer open via ASIC
INDEX 29H:
Write only

D7	D6	D5	D4	D3	D2	D1	D0	Function
0	0	0	0	0	0	0	1	<i>Pulse C/D circuit (open drawer)</i>

Control register U
Cash drawer status
INDEX 30H:
Read/write

D7	D6	D5	D4	D3	D2	D1	D0	Function
x	x	x	x	x	x	0	x	<i>IBM cash drawer connected</i>
x	x	x	x	x	x	1	x	<i>IBM cash drawer not connected</i>
x	x	x	x	x	0	x	x	<i>IBM cash drawer open</i>
x	x	x	x	x	1	x	x	<i>IBM cash drawer closed</i>

Appendix A Quick Reference for Printer Commands

[Partial Table-of-Contents](#)

- [Printer Command Reference -- Standard Version](#)
- [General Usage Commands -- Standard Version](#)
- [IBM Extended Commands -- Standard Version](#)
- [Printer Command Reference -- Simplified and Traditional Chinese Versions](#)
- [Control Codes -- Simplified and Traditional Chinese Versions](#)
- [DBCS Character Commands -- Simplified and Traditional Chinese Versions](#)
- [IBM Extended Commands -- Simplified and Traditional Chinese Versions](#)
- [Printer Command Reference -- Korean Version](#)
- [Control Codes -- Korean Version](#)
- [DBCS Character Commands -- Korean Version](#)
- [IBM Extended Commands -- Korean Version](#)
- [Printer Command Reference -- Japanese Version](#)
- [Control Codes -- Japanese Version](#)
- [DBCS Character Commands -- Japanese Version](#)
- [IBM Extended Commands -- Japanese Version](#)

9.5 [Printer Command Reference -- Standard Version](#)

9.5.1 [General Usage Commands -- Standard Version](#)

Table A-1. General Usage Commands - Standard Versions

Control Codes	Function	Supported by:	
		Impact Printer	Thermal Printer
"R" <i>n</i>	Select international character set	No	Yes
"6"	Select IBM 2 character table	Yes	Yes
"7"	Select IBM 1 character table	Yes	Yes
"i" <i>n1 n2</i>	Set the magnification rates in character width and height	No	Yes
	Select 2X character width mode	Yes	Yes
	Cancel 2X character width mode	Yes	Yes
	Sets the printing magnified double in character height	No	Yes
	Resets the printing magnified in character height	No	Yes
"h" <i>n1</i>	Sets the magnification rate in character height	No	Yes
"/" "1" or "/"	Select slash zero	No	Yes
"/" "0" or "/"	Select normal zero	No	Yes
"M"	Select normal character spacing	Yes	Yes
"g"	Select medium character spacing	No	Yes
"P"	Select wide character spacing	Yes	Yes

SurePOS 100 Technical Reference

","	Select extra wide character spacing	Yes	Yes
n	Select character spacing	No	Yes
"E"	Select emphasized print mode	Yes	Yes
"G"	Select emphasized printing	No	Yes
"F"	Cancel emphasized print mode	Yes	Yes
"H"	Cancel emphasized printing	No	Yes
"W" "n" or "W"	Set expanded character width mode	Yes	Yes
"-" "n" or "-"	Set underline mode	Yes	Yes
"_" "n" or "_"	Set overline mode	Yes	Yes
"4"	Select highlighted print mode	Yes	Yes
"5"	Cancel highlighted print mode	Yes	Yes
	Select inverted (upside down) print mode	Yes	Yes
	Cancel inverted print mode	Yes	Yes
	Line feed	Yes	Yes
	Carriage Return	Yes	Yes
"z" "1" or "z"	Normal line spacing	Yes	Yes
"0"	Compact line spacing	Yes	Yes
"1"	Tight line spacing	Yes	Yes
"z" "0" or "z"	Crowded line spacing	Yes	Yes
"y" n	Set n/144 inch line feed	Yes	Ignored
"3" n	Set n/216 inch line feed	Yes	Ignored
"A" n	Define n/72 inch line feed	Yes	Ignored
"2"	Set n/72 inch line feed	Yes	Ignored
"J" n	One time micro line feed	Yes	Yes
"j" n	One time backfeed	Yes	Yes
"l" n (l=capital i)	One time n/8 mm line feed	No	Yes
"a" n	Feed paper n lines	Yes	Yes
	Form feed	Yes	Yes
"C" n	Set page length in lines	Yes	Yes
"C" n	Set page length in inches	Yes	Yes
	Vertical tab	Yes	Yes
"B" n1 n2	Set vertical tab positions	Yes	Yes
"N" n	Set bottom margin	Yes	Yes
"0"	Cancel bottom margin	Yes	Yes
"l" n	Set left margin	Yes	Yes

SurePOS 100 Technical Reference

(l = lowercase L)			
"Q" n	Set right margin	Yes	Yes
	Horizontal tab	Yes	Yes
"D" n1n2	Set horizontal tab positions	Yes	Yes
"K" n1	Normal density graphics	Yes	Yes
"L" n1n2	High density graphics	Yes	Yes
"k" n1 d1	Fine density graphics	No	Yes
"X" n1 n2 m1	Fine density graphics	No	Yes
"&" n1n2	Define download characters	Yes	No
"&"	Delete a download character	No	Yes
"&"	Define download characters	No	Yes
"%" "1" or "%"	Enable download character set	Yes	Yes
"%" "0" or "%"	Disable download character set	Yes	Yes
"@"	Ignored initialized printer	Yes	Yes
"?"	Reset printer hardware	No	Yes
	Enquiry	Yes	Yes
	Cancel print data in buffer	Yes	Yes
"U" "1" or "U"	Select unidirectional print mode	Yes	Ignored
"U" "0" or "U"	Select bidirectional print mode	Yes	Ignored
	Enter STX-ETX mode	Yes	No
	Terminate STX-ETX mode	Yes	No
data	Select validation printing	Yes	No
n1n2	Adjust drive pulse width for cash drawer	Yes	Yes
	Deferred drive command for cash drawer	Yes	Yes
	Ignored immediate drive command for cash drawer	Yes	Yes
	Sound buzzer	Yes	Yes
"#" "*"	Request to send firmware version	No	Yes
"#n=0000"	Request to send memory switch setting	No	Yes
"#N, n1 n2 n3 n4"	Set memory switch	No	Yes
"d" "0" or "d"	Full-cut command to the auto cutter	No	Yes
"d" "1" or	Partial-cut command to the auto cutter	No	Yes

"d"			
"b" n1 n2 n3 n4 d1 ...	Select barcode printing	No	Yes

9.5.2 [IBM Extended Commands -- Standard Version](#)

Table A-2. IBM Expanded Commands - Standard Versions

Control Codes	Function	Supported by:	
		Impact Printer	Thermal Printer
"Y" n	Select paper width	No	Ignored
"T" n1n2n3n4	Select character table	Yes	Yes
	Select XON/XOFF mode	Yes	Yes
	Select DTR mode	Yes	Yes

9.6 [Printer Command Reference -- Simplified and Traditional Chinese Versions](#)

9.6.1 [Control Codes -- Simplified and Traditional Chinese Versions](#)

Table A-3. Control Codes - Simplified and Traditional Chinese Versions

Control Codes	Function	Supported by:	
		Impact Printer	Thermal Printer
"R" n	Select international character set	X	Yes
"/" "1" or "/"	Select slash zero	No	Yes
"/" "0" or "/"	Select normal zero	No	Yes
"M"	Normal character spacing	Yes	Yes
"g"	Medium character spacing	No	Yes
"P"	Wide character spacing	Yes	Yes
":"	Extra wide character spacing	No	Yes
n	Set character spacing	No	Yes
	Select 2X character width mode	Yes	Yes
	Cancel 2X character width mode	Yes	Yes
	Sets the printing magnified double in character height	No	Yes
	Resets the printing magnified in character height	No	Yes
"h" n	Sets the magnification rates in character height	No	Yes
"i" n1 n2	Sets the magnification rates in character width and height	No	Yes

SurePOS 100 Technical Reference

"E"	Select emphasized printing	No	Yes
"G"	Select emphasized printing	No	Yes
"F"	Cancel emphasized printing	No	Yes
"H"	Cancel emphasized printing	No	Yes
"W" "n" or "W"	Sets expanded character width mode	No	Yes
"_" "n" or "_"	Select underline mode	Yes	Yes
"_" "n" or "_" "<n>"	Select overline mode	No	Yes
"4"	Select highlight printing	No	Yes
"5"	Cancel highlight printing	No	Yes
	Select inverted (upside down) print mode	Yes	Yes
	Cancel inverted print mode	Yes	Yes
	Line feed	Yes	Yes
	Carriage return	Yes	Yes
"y" n	Set n/144 inch line feed	Yes	Ignored
"z" "1" or "z"	Normal line spacing	Yes	Yes
"0"	Compact line spacing	Yes	Yes
"A" n	Define n/72 inch line feed	Yes	Ignored
"2"	Set n/72 inch line feed	Yes	Ignored
"J" n	One time micro line feed	Yes	Yes
"j" n	One time micro backfeed	No	Yes
"I" n (I = capital i)	One time n/8 mm line feed	No	Yes
"a" n	Feed paper n lines	Yes	Yes
	Form feed	Yes	Yes
"C" n	Set page length in lines	Yes	Yes
"C" n	Set page length in inches	No	Yes
	Vertical tab	No	Yes
"B" n1 n2 ...	Set vertical tab stops	No	Yes
"N" n	Set bottom margin	No	Yes
"O" n	Cancel bottom margin	No	Yes
"I" n (I = lowercase L)	Set left margin	Yes	Yes
"Q" n	Set right margin	Yes	Yes
	Horizontal tab	Yes	Yes
"D" n1n2	Set horizontal tab positions	Yes	Yes

SurePOS 100 Technical Reference

"K" n1	Normal density graphics	Yes	Yes
"L" n1n2	High density graphics	Yes	Yes
"k" n1 d1	Fine density graphics	No	Yes
"X" n1 n2 m1	Fine density graphics	No	Yes
"^" n0n1n2	9-dot bit image	Yes	No
"&" n1 n2	Define a download character	No	Yes
"&"	Define download character	No	Yes
"&"	Delete a download character	No	Yes
"%" "1" or "%"	Enable download character set	Yes	Yes
"%" "0" or "%"	Disable download character set	Yes	Yes
"@"	Initialize printer	Yes	Yes
"?"	Reset printer hardware	Yes	Yes
	Enquiry	Yes	Yes
	Cancel print data in buffer	Yes	Yes
"U" "1" or "U"	Select unidirectional print mode	Yes	Ignored
"U" "0" or "U"	Select bidirectional print mode	Yes	Ignored
	Enter STX-ETX mode	Yes	No
	Terminate STX-ETX mode	Yes	No
n1n2	Adjust drive pulse width for cash drawer	Yes	Yes
	Deferred drive command for cash drawer	Yes	Yes
	Immediate drive command for cash drawer	Yes	Yes
data	Select validation printing	No	No
	Beep the buzzer	No	Yes
"##"	Request to send firmware version	No	Yes
"#n = 0000"	Request to send memory switch setting	No	Yes
"#N, n1 n2 n3 n4"	Set memory switch	No	Yes
"d" "0" or "d"	Full-cut command to the auto cutter	No	Yes
"d" "1" or "d"	Partial-cut command to the auto cutter	No	Yes
"b" n1 n2 n3 n4 d1 ...	Select bar code printing	No	Yes

9.6.2 [DBCS Character Commands -- Simplified and Traditional Chinese Versions](#)

Table A-4. DBCS Character Commands &dash.&dash. Simplified and Traditional Chinese Versions

Control Codes	Function	Supported by:	
		Impact Printer	Thermal Printer
"s" n1n2	Set space between DBCS characters	Yes	Yes
"t" n1n2	Set space between DBCS half characters	Yes	No
"r" a1a2 d1...d32	Define DBCS character download	Yes	No
"u" "1" or "u"	Select Kanji (A) DBCS	Yes	Yes
"u" "0" or "u"	Select Kanji (B) DBCS	Yes	Yes
"x" "1" or "x"	Select normal size DBCS character	Yes	Yes
"x" "0" or "x"	Select double-height size DBCS character	Yes	Yes
"w" "1" or "w"	Select Kanji (A) DBCS	Yes	Yes
"w" "0" or "w"	Select double-height, double-width size DBCS character	Yes	Yes

9.6.3 [IBM Extended Commands -- Simplified and Traditional Chinese Versions](#)

Table A-5. IBM Extended Commands &dash.&dash. Simplified and Traditional Chinese Versions

Control Codes	Function	Supported by:	
		Impact Printer	Thermal Printer
"Y" n	Select paper width	Yes	Yes
	Select XON/XOFF mode	Yes	Yes
	Select DTR mode	Yes	Yes
"n"	Vertical column alignment mode	Yes	No
"{" n1n2	Print density setting mode	Yes	No

Appendix B Adapter Cable Definition – 15 Pin to standard 9 pin

An adapter cable can be obtained from any PC cable supplier that adapts the 15-pin connector to a standard 9-pin non-powered connector. The cable should be wired as shown in [Figure 2-2](#).

Figure 2-2. 15-pin to 9-pin Adapter Cable Wiring for Serial Channels

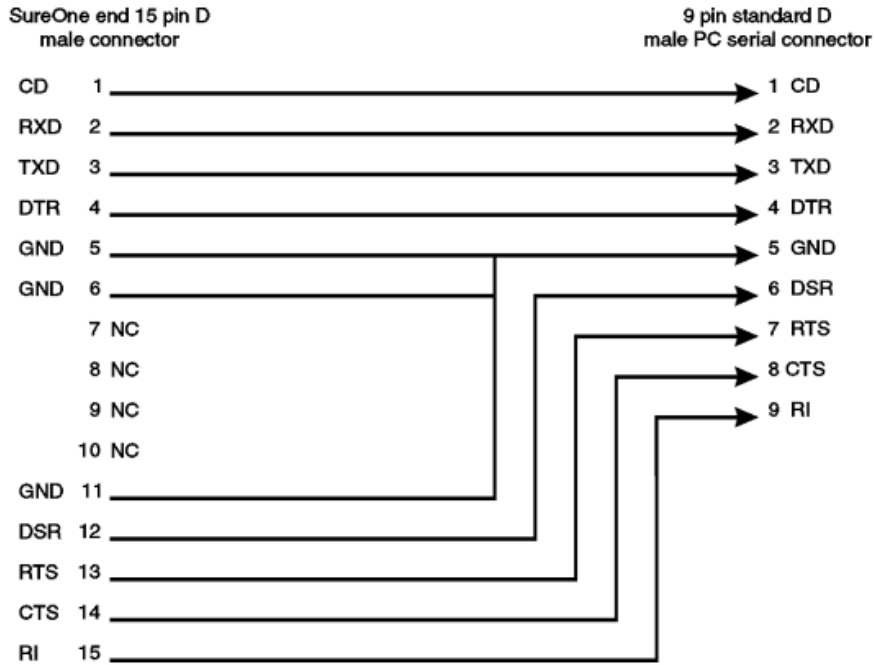

Figure 5. SurePOS 100 with Docking Station (proposed RPQ)

10.0 Customer Display Programming Information

10.1 1x11 LED Display

10.1.1 1x11 Command Set

Command	Code	Description
ESC Q A ..CR	1B 75 41 [data x 11] 0D	Show data 11 bytes on display

10.1.2 1x11 Character Set

	00	01	02	03	04	05	06	07	08	09	0A	0B	0C	0D	0E	0F
20H														-		
30H	0	1	2	3	4	5	6	7	8	9				=		
40H		A	B	C	D	E	F	G	H	I	J		L		N	O
50H	P	Q	R	S	T	U				Y						-
60H		a	b	c	d	e	f	g	h	i	j		l		n	o
70H	p	q	r	s	t	u				y						

10.2 2x20 VFD Customer Display

10.2.1 Command Set

Format shown is the hexadecimal value followed by the ASCII representation of that value in <>.

EMULATION MODE SELECT (00h,<NULL>): Indicates with the second byte, which mode is selected:

00h - Logic Controls emulation mode (Default)

01h - IBM mode

CHARACTER SET SELECT (02h,<STX>): IBM Mode only. Selects the character set with the next byte. This command is ignored for Logic Controls Emulation.

Character set definitions are as follows:

00h - Modified IBM code page 437 (US English - power up default)

01h - Modified IBM code page 897 (Katakana)

02h - Modified IBM code page 858 (Multilingual International)

03h - Modified IBM code page 852 (Central Europe)

04h - Modified IBM code page 855 (Cyrillic)

05h - Modified IBM code page 857 (Turkey)

06h - Modified IBM code page 862 (Israel)

07h - Modified IBM code page 863 (Canadian French)

08h - Modified IBM code page 864 (Arabic)

09h - Modified IBM code page 865 (Nordic)

0Ah - Modified IBM code page 808 (Cyrillic - Russia)

0Bh - Modified IBM code page 869 (Greece)

Any other selection value is ignored.

For documentation of the fonts of the character sets, refer to Section 11.0 of this document.

USER CHARACTER DEFINITION (03h)<EXT>: This command allows for custom character definition.

IBM Mode: The byte following the command byte represents an address between 15h and 1Ah or between 1Ch and 1Eh in the currently selected character set. The address byte is followed by 8 bytes that define the actual bit patterns of the user defined character. The format of this data stream is as follows:

byte #	Bit 0	Bit 1	Bit 2	Bit 3	Bit 4	Bit 5	Bit 6	Bit 7
1	"x"h	"x"h	"x"h	P1	P2	P3	P4	P5
2	"x"h	"x"h	"x"h	P6	P7	P8	P9	P10
3	"x"h	"x"h	"x"h	P11	P12	P13	P14	P15
4	"x"h	"x"h	"x"h	P16	P17	P18	P19	P20
5	"x"h	"x"h	"x"h	P21	P22	P23	P24	P25
6	"x"h	"x"h	"x"h	P26	P27	P28	P29	P30
7	"x"h	"x"h	"x"h	P31	P32	P33	P34	P35
8 *	"x"h	"x"h	"x"h	"x"h	"x"h	"x"h	"x"h	"x"h

* This is maintained for application compatibility with displays with 5x8 character boxes.

Px below represents a character pixel position in the character, a 1 indicating the pixel is ON, and 0 indicating the pixel is OFF. In the table "x"h indicates that the bit value is a Don't Care.

<--- 5 pixels wide ---->

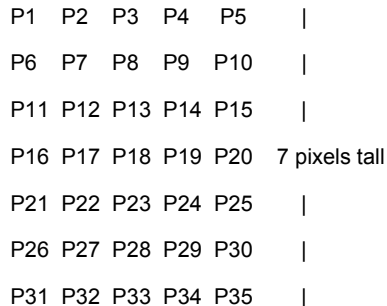

Logic Controls Emulation Mode: The byte following the command byte contains the ASCII character (20h - 7Fh) of a keyboard key to be redefined. This byte is followed by 5 bytes that define the bit patterns of the user defined character. Logic Controls only allows one keyboard key to be redefined. This means there is only one user definable character in this mode. Once a key is redefined, any occurrence of that character on the display will change to the user defined character. If a new key is redefined the previously redefined key is restored to the original character on all places on the display and the newly redefined key will be changed to the user definable character. The format of this data stream is as follows:

SurePOS 100 Technical Reference

byte #	Bit 0	Bit 1	Bit 2	Bit 3	Bit 4	Bit 5	Bit 6	Bit 7
1	P8	P7	P6	P5	P4	P3	P2	P1
2	P16	P15	P14	P13	P12	P11	P10	P9
3	P24	P23	P22	P21	P20	P19	P18	P17
4	P32	P31	P30	P29	P28	P27	P26	P25
5	"x"h	"x"h	"x"h	"x"h	"x"h	P35	P34	P33

Px below represents a character pixel position, a 1 indicating the pixel is ON, and 0 indicating the pixel is OFF. In the table "x"h indicates that the bit value is a Don't Care.

<--- 5 pixels wide ----->

```

P1 P2 P3 P4 P5   |
P6 P7 P8 P9 P10  |
P11 P12 P13 P14 P15 |
P16 P17 P18 P19 P20 7 pixels tall
P21 P22 P23 P24 P25 |
P26 P27 P28 P29 P30 |
P31 P32 P33 P34 P35 |
    
```

User defined characters will remain on the display if the display control mode is switched, and change only when the character position is updated.

BRIGHTNESS CONTROL (04h),<EOT>: The byte following the command indicates the percentage of maximum brightness to which to set the display:

- FFh - 100% (power-up default)
- 60h - 60%
- 40h - 40%
- 20h - 20%

ALPHANUMERIC MESSAGE SCROLL (05h),<ENG>: The bytes following the command compose a message of up to 45 characters in length that are continuously scrolled on the top line of the display.

Any data received after the 45th are ignored except a carriage return (0Dh). The message will be displayed after the carriage return command is received. If the cursor position is on the top line when this command is received, it is moved to the first position on the bottom line. If the cursor position is on the bottom line, the cursor position is not changed. Any text on the bottom line is left unchanged when this command is issued. Data will continue scrolling on the top line until a valid character, Backspace, Horizontal Tab, Line Feed, Carriage Return, or Display Position command is written to the top line. Test and Reset will stop the scrolling message regardless of the display position.

BACKSPACE (08h, <BS>): Decrements the cursor position by one, and clears any character displayed in that position. If the write position is at the lower left position, the position is moved to the upper right, and if the write position is at the upper left, the write position is moved to the lower right. This command will stop the scrolling alphanumeric message if the cursor position is on the top line when this command is sent.

HORIZONTAL TAB (09h, <HT>): Increments the cursor position by one. No character erasure takes place. This command will stop the scrolling alphanumeric message if the cursor position is on the top line when this command is sent. At the end of a line, the display behavior is determined by the state of the DC1/DC2 mode as follows:

Normal Display Control (DC1) Mode: If the cursor is at the upper right position, it is moved to the lower left position. If the cursor is at the lower right position, it is moved to the upper left position.

Vertical Scroll Display Control (DC2) Mode: If the cursor position is at the upper right position, it is moved to the lower left. If the cursor is at the lower right position, the characters displayed on the bottom line are moved to the top line, the bottom line is cleared, and the cursor is moved to the lower left position.

LINE FEED (0Ah, <LF>): The display behavior is determined by the state of the DC1/DC2 mode as follows:

Normal Display (DC1) Mode: The cursor is moved to the same position in the complementary line. In this mode, a line feed command will stop the scrolling alphanumeric message if the cursor position is on the top line when this command is sent.

Vertical Scroll (DC2) Mode: If the cursor position is on the top line, it is moved to the complementary position on the bottom line. If the cursor position is on the bottom line, all characters on that line are moved to the top line, the bottom line is cleared, and the cursor position is unchanged. This command will always stop the scrolling alphanumeric message.

CARRIAGE RETURN (0Dh, <CR>): Causes the cursor to move to the left most position of the current line. This command will stop the scrolling alphanumeric message if the cursor position is on the top line when this command is sent.

TEST (0Fh, <SI>): Causes the first 40 characters in the currently selected character set to be displayed one time. In addition, at the end of the test, a test pattern is written that turn all pixels ON. At the conclusion of the test routine, the display is cleared and the display is reset to the "reset" state defined below.

DISPLAY POSITION (10h,<DLE>): Changes the cursor position. The byte following the command byte indicates the character position where the next data string write will start. Address 00h is the top left, address 13h is the top right, address 14h is the bottom left and address 27h is the bottom right. Any values greater than 27h are ignored and the cursor position will remain unchanged. This command will stop the scrolling alphanumeric message if the cursor position is on the top line when this command is sent.

NORMAL DISPLAY CONTROL MODE (DC1) (11h, <DC1>): Data can be written into either line. After writing a character, the cursor moves one position to the right. When the display position is at the last position of the top line, the cursor moves to the first position of the bottom line. When the display position is at the last position of the bottom line, the cursor moves to the first position of the top line. The display remains in DC1 mode until a DC2 mode command is issued, a reset command is issued, or power is removed from the display.

VERTICAL SCROLL DISPLAY CONTROL MODE (DC2) (12h, <DC2>): Data may be written to either line. When the display position is at the last position of the top line, the cursor moves to the first position of the bottom line. When valid character data or a horizontal tab command is sent to the last position of the bottom line, the data on the bottom line will be transferred to the top line and the cursor will be moved to the lower left position. Note that a carriage return command does not cause the data on the bottom line to be transferred to the top line.

DC2 mode is the power up and reset default. The display remains in DC2 mode until a DC1 mode command is issued.

CURSOR ON (13h,<DC3>): Turns on the cursor. This is the power-up default.

CURSOR OFF (14h)<DC4>: Turns off the cursor.

RESET (1Fh)<US>: Causes the display to reset some programmable parameters back to the power-on state. This state is defined to be:

- Cursor ON
- Scrolling Alphanumeric message OFF
- All pixels OFF (all character positions are filled with 20h)
- Write position for next write at position 00h (top left)
- Default code page (437) selected
- DC2 mode enabled
- Default (Logic Controls) emulation mode selected.
- Brightness set to 100%
- IBM user defined characters are NOT erased. The Logic Controls user defined character key is RESET.

All other bytes between 00h and 1Fh not defined above are completely ignored by the display in the Logic Controls mode. User defined characters in the IBM mode that have not been previously defined are spaces.

11.0 Appendix - Code Pages

This Appendix contains the following code pages:

[Partial Table-of-Contents](#)

- [Code Page 00850 \(Multilingual\)](#)
 - [Code Page 00852 \(Eastern Europe\)](#)
 - [Code Page 00855 \(Bulgaria\)](#)
 - [Code Page 00857 \(Turkey\)](#)
 - [Code Page 00862 \(Israel\)](#)
 - [Code Page 00864 \(Arabic\)](#)
 - [Code Page 00866 \(Russia\)](#)
 - [Code Page 00869 \(Greece\)](#)
 - [Code Page 00874 \(Thailand\) \(Printer Only\)](#)
 - [Code Page 00897 \(Japan\)](#)
-

11.1.1 [Code Page 00850 \(Multilingual\)](#)

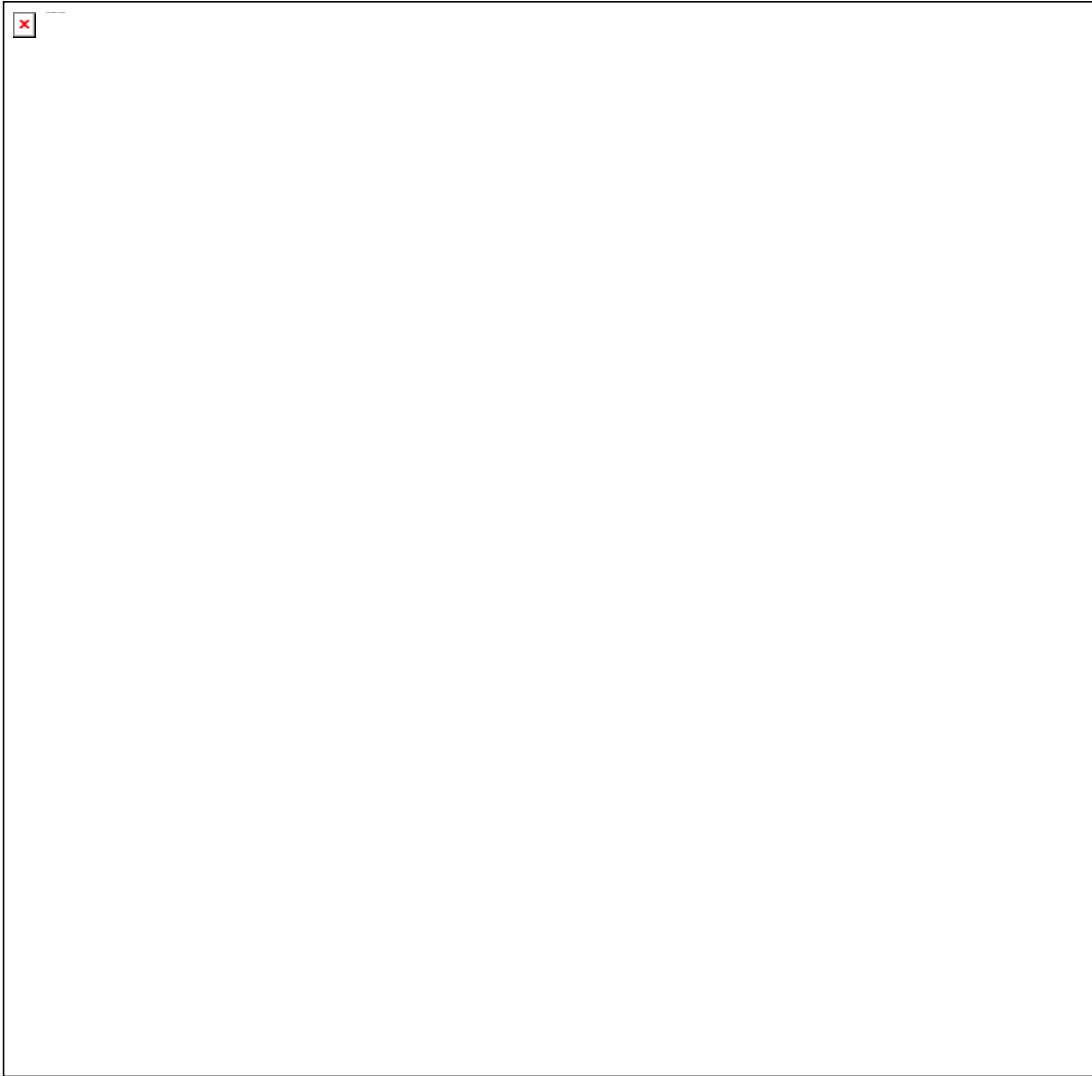

Notes:

Printer - Characters may vary as shown (ex. 00h through 1Fh).

Customer (2 x 20) Display - all codes are displayed as shown in the above code page **except** 00h through 1Fh, B0h-B4h, B9h-BCh, BFh-C5h, C8h-CEh, D9h-DCh, DFh, and FEh. These code page characters display as a blank.

11.1.2 [Code Page 00852 \(Eastern Europe\)](#)

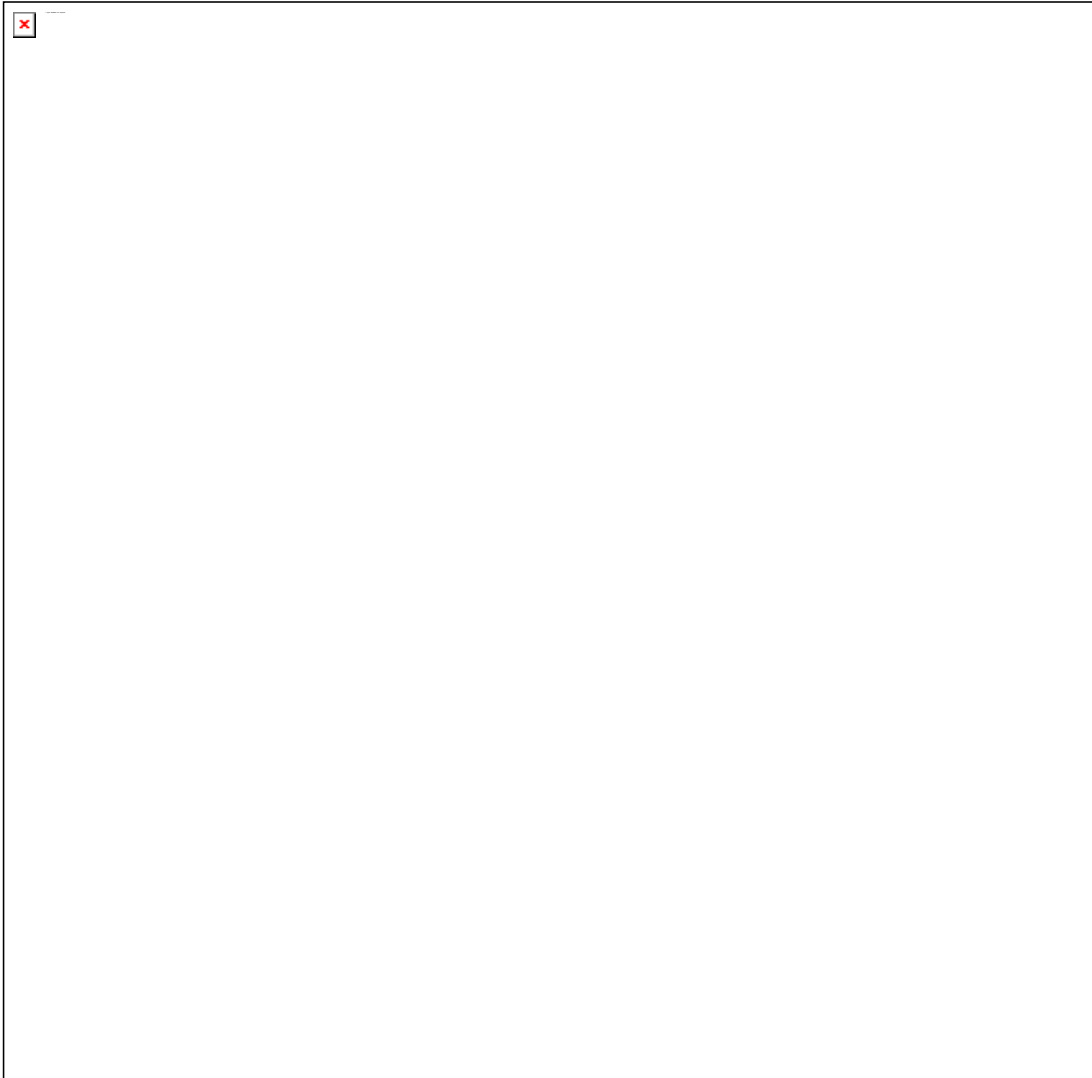

Notes:

Printer - Characters may vary as shown (ex. 00h through 1Fh).

Customer (2 x 20) Display - all codes are displayed as shown in the above code page **except** 00h through 1Fh, B0h-B4h, B9h-BCh, BFh-C5h, C8h-CEh, D9h-DCh, DFh, and FEh. These code page characters display as a blank.

11.1.3 [Code Page 00855 \(Bulgaria\)](#)



Notes:

Printer - Characters may vary as shown (ex. 00h through 1Fh).

Customer (2 x 20) Display - all codes are displayed as shown in the above code page **except** 00h through 1Fh, B0h-B4h, B9h-BCh, BFh-C5h, C8h-CEh, D9h-DCh, DFh, and FEh. These code page characters display as a blank.

11.1.4 [Code Page 00857 \(Turkey\)](#)

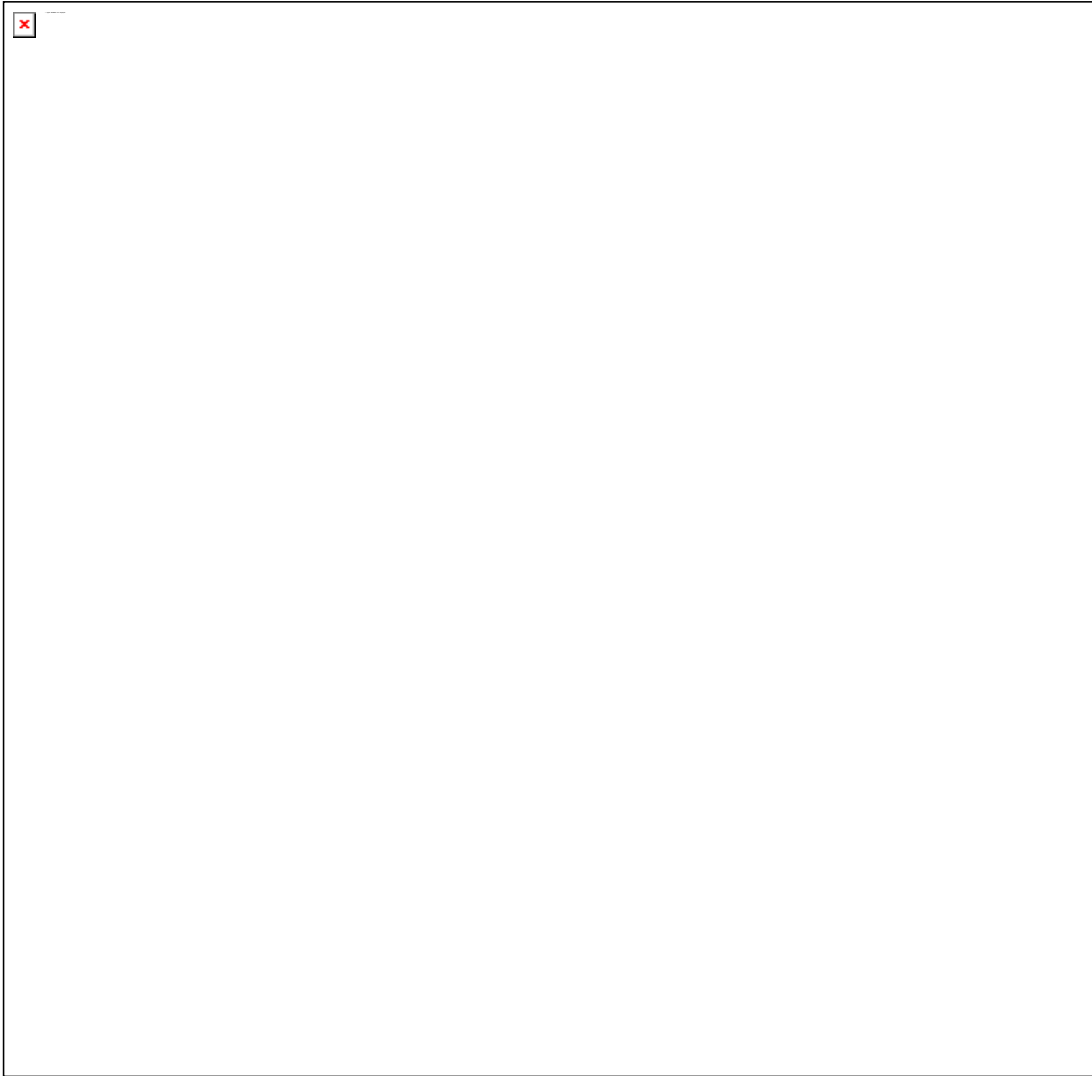

Notes:

Printer - Characters may vary as shown (ex. 00h through 1Fh).

Customer (2 x 20) Display - all codes are displayed as shown in the above code page **except** 00h through 1Fh, ABh-ACH, B0h-B4h, B9h-BCh, BFh-C5h, C8h-CEh, D0h-D1h, D5h, D9h-DCh, DFh, F2h-F4h, and FEh. These code page characters display as a blank.

11.1.5 [Code Page 00862 \(Israel\)](#)

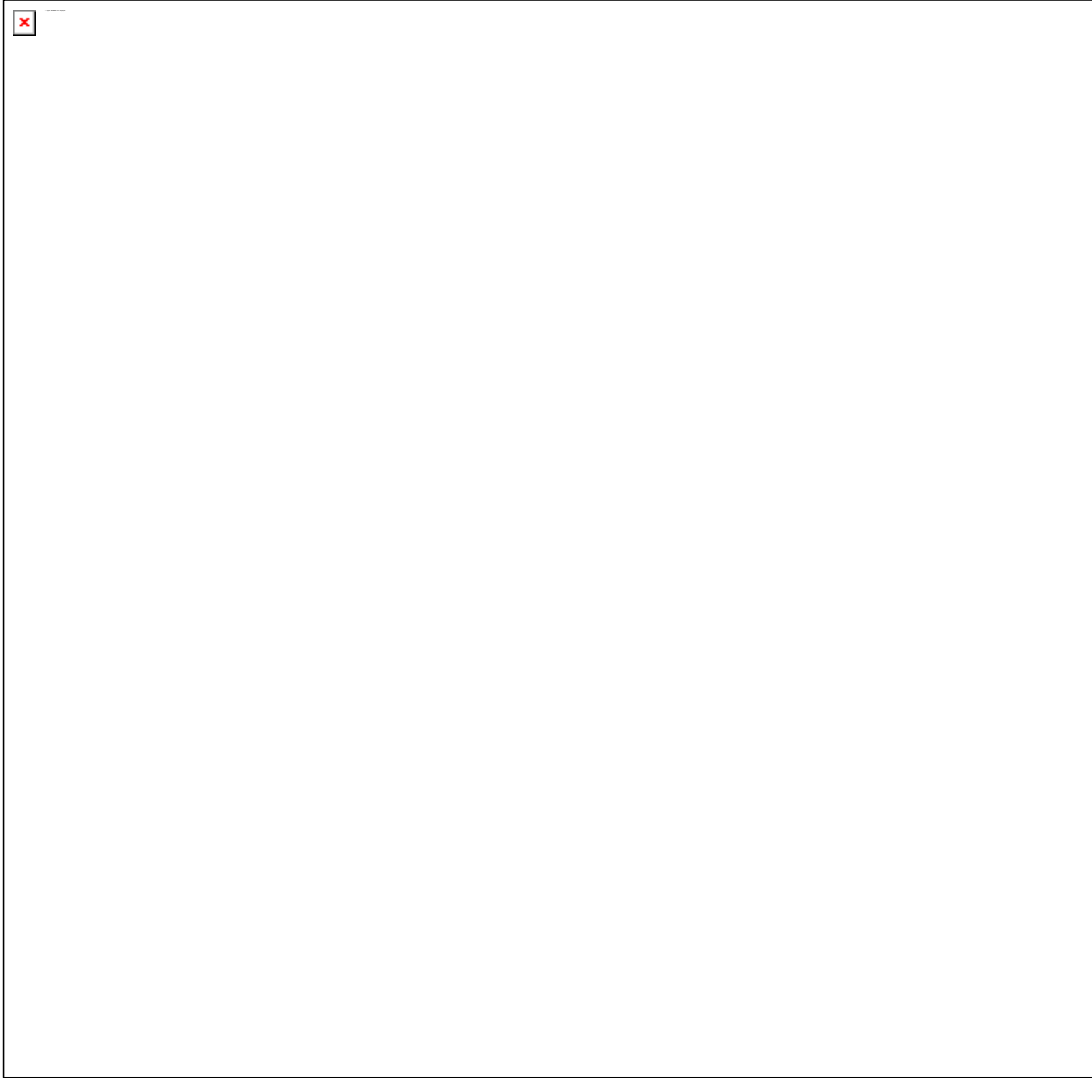

Notes:

Printer - Characters may vary as shown (ex. 00h through 1Fh).

Customer (2 x 20) Display - all codes are displayed as shown in the above code page **except** 00h through 1Fh, ABh-ACH, B0h-F5h, and F6h-FEh. These code page characters display as a blank.

11.1.6 [Code Page 00864 \(Arabic\)](#)



Notes:

Printer - Characters may vary as shown (ex. 00h through 1Fh).

Customer (2 x 20) Display - all codes are displayed as shown in the above code page **except** 00h through 1Fh, 80h-8Fh, 91h, 94h-96h, 9Bh-9Ch, A0h, A6h-A7h, B0h, and FEh. These code page characters display as a blank.

11.1.7 [Code Page 00866 \(Russia\)](#)



Notes:

Printer - Characters may vary as shown (ex. 00h through 1Fh).

Customer (2 x 20) Display - all codes are displayed as shown in the above code page **except** 00h through 1Fh, B0h-DFh, F8h-FBh, and FEh. These code page characters display as a blank.

11.1.8 [Code Page 00869 \(Greece\)](#)

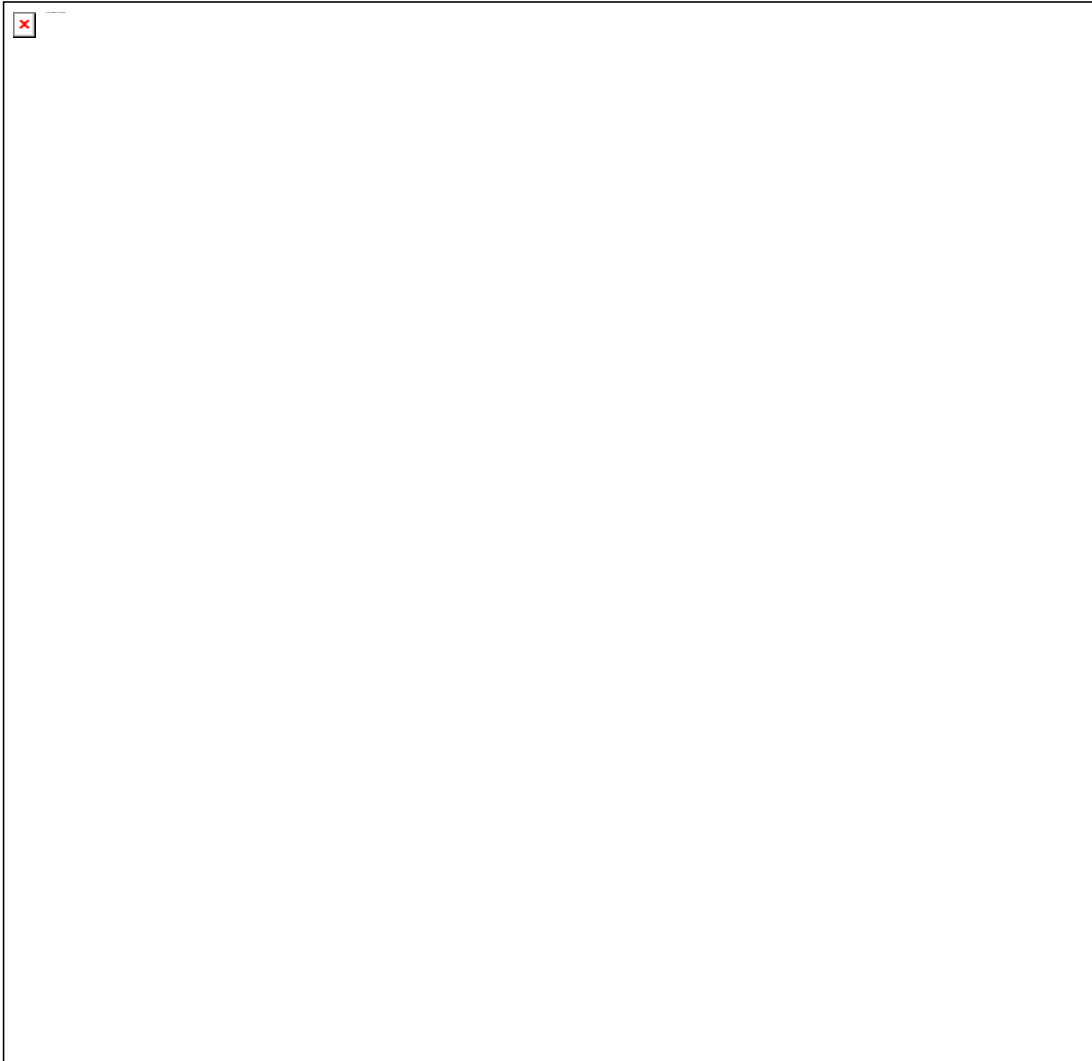

Notes:

Printer - Characters may vary as shown (ex. 00h through 1Fh). Code page not supported on the thermal printer.

Customer (2 x 20) Display - all codes are displayed as shown in the above code page **except** 00h through 1Fh, 80h-85h, 87h, 93h-94h, ABh, B0h-B4h, B9h-BCh, BFh, C0h-C5h, C8h-CEh, D9h-DCh, DFh, and FEh. These code page characters display as a blank.

11.1.9 [Code Page 00874 \(Thailand\) \(Printer Only\)](#)



Notes:

Printer - Characters may vary as shown.

Customer (2 x 20) Display - code page is **not** supported.

11.1.10 [Code Page 00897 \(Japan\)](#)

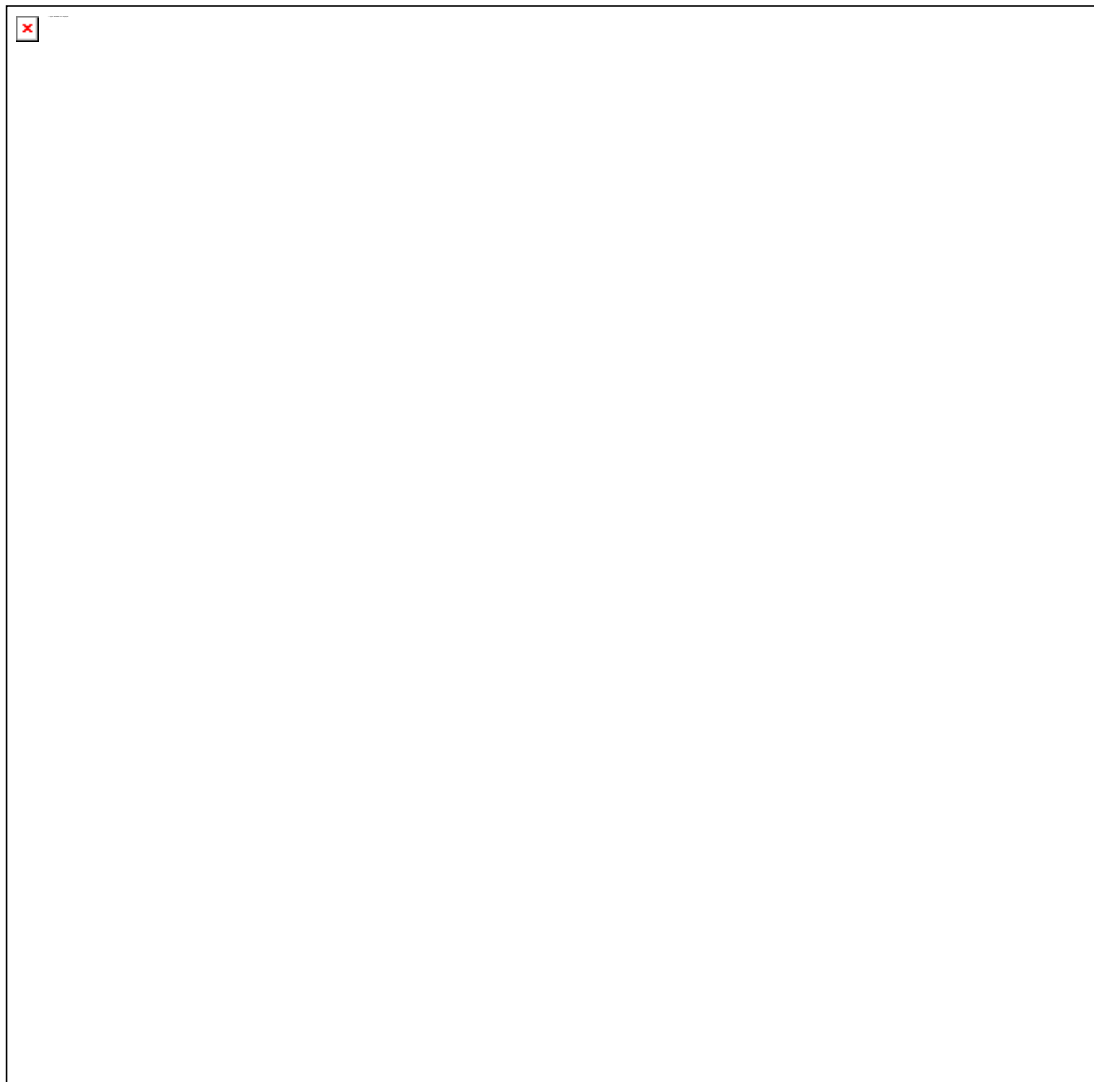

Notes:

Printer - Characters may vary as shown (ie. 00h through 1Fh).

Customer (2 x 20) Display - all codes are displayed as shown in the above code page **except** 00h through 1Fh.

12.0 PC DOS 7.0 Reference Publications

IBM PC DOS publications and backup diskettes are not shipped with the SurePOS 100 POS Terminal.

North America

The following U.S. English publications are available from Mechanicsburg. To order, contact your IBM representative or IBM Authorized Personal Computer Dealer.

Title	Order Number
PC DOS User's Guide	S83G-9260
PC DOS Command Reference and Error Messages (See Note 1)	S83G-9309
PC DOS REXX User's Guide and Command Reference	S83G-9228
PC DOS Keyboards and Code Pages	S83G-9310
PC DOS 7 Technical Update (See Note 2)	GG24-4459

Notes:

1. The PC DOS Command Reference is included as online documentation shipped with IBM PC DOS Version 7. The hardcopy version of the Command Reference can be ordered from your dealer or IBM representative.
2. The PC DOS 7 Technical Update also includes an online Technical Reference, viewable under IBM PC DOS Viewer, which ships with IBM PC DOS Version 7.

EMEA

The following publications can be ordered from ISMS Copenhagen.

Title	Order Number	Language
PC DOS User's Guide	S28H-8818-00	Danish
PC DOS User's Guide	S28H-8788-00	Dutch
PC DOS User's Guide	S28H-8766-00	Finnish
PC DOS User's Guide	S28H-8652-00	French
PC DOS User's Guide	S28H-8675-00	German
PC DOS User's Guide	S28H-8698-00	Italian
PC DOS User's Guide	S28H-8834-00	Norwegian
PC DOS User's Guide	S28H-8857-00	Portuguese
PC DOS User's Guide	S28H-8880-00	Russian
PC DOS User's Guide	S28H-8720-00	Spanish
PC DOS User's Guide	S28H-8743-00	Swedish
PC DOS User's Guide	S28H-8629-00	U.K. English
PC DOS Keyboards and Code Pages	S28H-8911-00	Danish
PC DOS Keyboards and Code Pages	S28H-8904-00	French
PC DOS Keyboards and Code Pages	S28H-8906-00	German
PC DOS Keyboards and Code Pages	S28H-8908-00	Italian
PC DOS Keyboards and Code Pages	S28H-8910-00	Spanish
PC DOS Keyboards and Code Pages	S28H-8901-00	U.K. English
PC DOS Command Reference and Error Messages	S28H-8647-00	French
PC DOS Command Reference and Error Messages	S28H-8905-00	German
PC DOS Command Reference and Error Messages	S28H-8903-00	Russian
PC DOS Command Reference and Error Messages	S28H-8909-00	Spanish
PC DOS Command Reference and Error Messages	S28H-8900-00	U.K. English
PC DOS REXX User's Guide and Command Reference	S28H-8907-00	German
PC DOS REXX User's Guide and Command Reference	S28H-8902-00	U.K. English

PC DOS 7 Technical Update GG24-4459 U.S. English

SurePOS 100 Technical Reference

Document packages are also available for order.

The package contains: PC DOS User's Guide, Keyboard Code and Code Pages, and Coupon book.

Language	Part Number
Danish	19H6691
Dutch	19H6692
Finnish	19H6693
French	19H6694
German	19H6695
Italian	19H6696
Norwegian	19H6697
Portuguese	19H6698
Russian	19H6699
Spanish	19H6700
Swedish	19H6701
U.K. English	19H6702

Asia Pacific

The following national language publications are available in the countries indicated.

Title	Order (Form) Number
Japan:	
PC DOS J7.0/V User's Guide	SB88-5602
PC DOS J7.0/V Command Reference and Error Messages	SB88-5603
PC DOS J7.0/V REXX User's Guide and Reference	SB88-5601
PC DOS J7.0/V Keyboard and Code Pages	SB88-5604
PC DOS J7.0/V Technical Reference	GG88-5500

Taiwan:

PC DOS T7 User's Guide	SC40-1414
PC DOS T7 REXX User's Guide and Reference	SC40-1415
PC DOS T7 Chinese Functions User's Guide	SC40-1401

Korea:

PC DOS H7 Command Reference and Error Messages	S29G-0001
PC DOS H7 REXX User's Guide and Reference	S29G-0002

PRC:

PC DOS P7 Installation Guide	SA84-0074
PC DOS P7 Getting Started	SA84-0075
PC DOS P7 BIOS and DOS-CPI Reference	SA84-0076

13.0 Keyboard Programming Utility Guide

Overview

This section provides a User's Guide for the IBM SurePOS100 Keyboard Utility.

13.1 Requirements

IBM SurePOS100 Keyboard with 96 programmable PF keys.
IBM SurePOS100 Keyboard Utility V1.0.11 or later version for Win 98, 2000, XP.
IBM SurePOS100 Keyboard FW V1.2.7 or later version.
An external keyboard for data input (PS/2 or USB Keyboard).

13.2 Utility Functions

There are four main functions:

Check Connection: Check Connection function will check whether the SurePOS100 Keyboard is detected or not. If the SurePOS100 Keyboard is detected, the utility will show the related information and enable the Upload Configuration, Download Configuration and Code Update functions to be executed. Must be performed once during each programming utility session.

Upload Configuration: Upload Configuration will read the current keyboard configuration into the programming utility.

Download Configuration: Download Configuration will save the Utility Configuration results to the SurePOS100 Keyboard.

Code Update: Code Update will renew the firmware of the SurePOS100 Keyboard.

Additional configuration items:

Configure MSR Track Headers and Trailers: To configure each MSR Track Header/Trailer display. Each Header/Trailer can store a maximum of 20 chars. This setting must combine with Configure MSR Characteristics setting.

Configure MSR Characteristics: To configure MSR each Track characteristics, including Sentinels Enable/Disable, Carriage Return Enable/Disable, Programmable Sentinels Enable/Disable, Track Enable/Disable and MSR Data Speed Selection.

Configure MSR Translation: To configure MSR Track swipe card display, you can select one translation mode from below modes: USA, Canadian/French, UK English, French, German, Latin American, Spanish, Brazilian Portuguese and User Defined. The Track 1 and Track 2 & 3 Configuration Panel setting are for User Defined mode used.

Configure Prefix and Keyboard: To Configure Prefix/Suffix display of Internal Keyboard Device, MSR Device, and External Device; the Prefix will be sent while a device is in first use, the Suffix of a device will be sent while next device is going to be used; we can use Prefix/Suffix to distinguish different devices usage status. To select the active keyboard mode from 101, 102, 103 and pos; we have four keyboard mode can be used for SurePOS100 Keyboard, three nonprogrammable keyboard mode (101, 102, and 103), and one programmable keyboard mode (pos), we must select one keyboard mode as active keyboard mode (default is 101 mode). Below Double Key Setup and PF Key Programming Setup are only used for pos mode.

Double Key Setup: PF Key group function key setting, there are three group function key mode, which are horizontal double key, vertical double key, and quaternary double key.

PF Key Programming Setup: There are 96 PF keys can be programmed, each PF key can store maximum 20 chars. This setting can combine with Double Key Setup. To let the PF Key work properly, the active key mode must set to pos mode.

Load Default Keyboard mode: There are three default keyboard mode can be loaded to PF Key Programming setup panel, which are 101, 102, and 103 mode. Once you load one default keyboard mode, you can make some

slight modify to it, set active keyboard to pos mode, and store it to SurePOS100 keyboard. This function can help you to generate PF Keys which are default keyboard mode alike easily.

Configuration File: We can save current configuration results to a SurePOS100 keyboard configuration file(.pcf), load a configuration file to keyboard utility, and set keyboard utility all configuration items to default value.

13.3 Procedures

Check Connection

Connect external keyboard to IBM SurePOS100 Keyboard by PS/2 or USB and open IBM SurePOS100 Keyboard Configuration Utility (AP).

A dialog which title is 'Query/Download/Upload' appears and presses 'OK' to start keyboard communication. You can also Check Connection from menu 'System→Check Connection' (PIC_01).

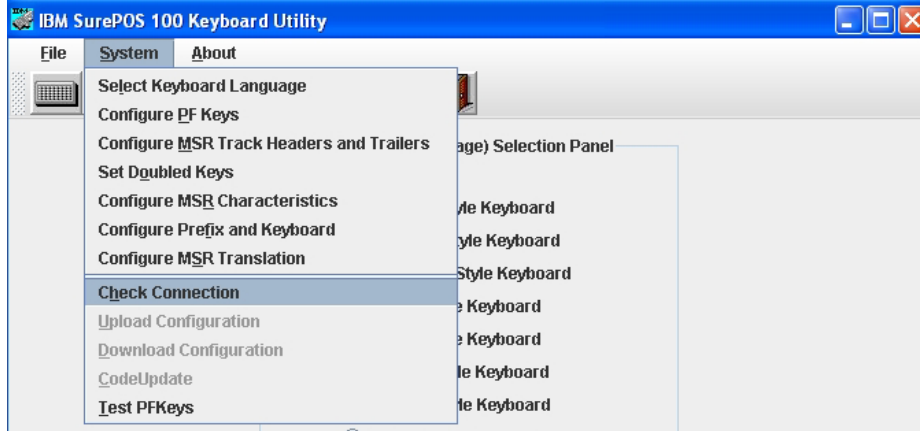

PIC_01

After Keyboard Query finished, a message box appeared. Utility will show the related information and enable the Upload Configuration, Download Configuration and Code Update functions execution ability. Otherwise, a message 'IBM SurePOS 100 Keyboard not Found' appeared.

Upload Configuration from SurePOS100 Keyboard

Connect external keyboard to IBM SurePOS100 Keyboard by PS/2 or USB and open IBM SurePOS100 Keyboard Configuration Utility (AP).



A dialog which title is 'Query/Download/Upload' appears and presses 'OK' to start keyboard communication. You can also Check Connection from menu 'System→Check Connection'. If SurePOS100 Keyboard is detected, the Upload Current Configuration from the Keyboard hot key is enabled. See the above picture.

Press Upload Current Configuration from the Keyboard hot key or from menu 'System→Upload Configuration' to update Utility current configuration from SurePOS100 Keyboard.

Download Configuration to SurePOS100 Keyboard

Connect external keyboard to IBM SurePOS100 Keyboard by PS/2 or USB and open IBM SurePOS100 Keyboard Configuration Utility (AP).



A dialog which title is 'Query/Download/Upload' appears and presses 'OK' to start keyboard communication. You can also Check Connection from menu 'System→Check Connection'. If SurePOS100 Keyboard is detected, the Download Current Configuration to the Keyboard hot key is enabled. See the above picture. Setup properly configuration items from IBM SurePOS100 Keyboard Configuration Utility (AP). Press Download Current Configuration to the Keyboard hot key or from menu 'System→Download Configuration' to download Utility current configuration to SurePOS100 Keyboard.

Code Update

Connect external keyboard to IBM SurePOS100 Keyboard by PS/2 or USB and open IBM SurePOS100 Keyboard Configuration Utility (AP).

A dialog which title is 'Query/Download/Upload' appears and presses 'OK' to start keyboard communication. You can also Check Connection from menu 'System→Check Connection'. If SurePOS100 Keyboard is detected, the menu 'System→CodeUpdate' item is enabled.

To run the menu 'System→CodeUpdate' item and input a FW file to run code update (renew firmware).

Configure MSR Track Headers and Trailers

Press the MSR Track Header and Trailer Programming Hot Key of the below picture or from menu 'System->Configure MSR Track Headers and Trailers' to enter MSR Configuration Panel.



To select configuration Track from the Track Selection Panel.

To configure each Track Header/Trailer from the Header and Terminator Setup Panel, press the Edit button to edit Header/Trailer, or press Default button to load default Header/Trailer. Each Header/Trailer can store maximum 20 chars.(The default Header/Trailer (H/T)for each Track is: T1(H): %, T1(T): ?+Enter, T2(H): ;, T2(T): ?+Enter, T3(H): ;, T3(T): ?+Enter)

This setting must combine with Configure MSR Characteristics setting. We will describe both relations in the Configure MSR Characteristics setting.

Configure MSR Characteristics

From menu 'System->Configure MSR Characteristics' to enter MSR Characteristics Configuration Panel.

To set each Track Configuration from the Track-X Configuration Panel. The setting meaning are as below:

- 2.1. Sentinels Enable/Disable: To let Track Header and Trailer visible/invisible.
- 2.2. Programmable Sentinels Enable: To let Track Header and Trailer display as we defined in Configure MSR Track Headers and Trailers
- 2.3. Programmable Sentinels Disable: To let Track Header and Trailer display use default value.

The default Header/Trailer (H/T) for each Track is:

T1(H): %, T1(T): ?+Enter, T2(H): ;, T2(T): ?+Enter, T3(H): ;, T3(T): ?+Enter

- 2.4. Carriage Return Enable/Disable: To let each Track Carriage Return (Enter) visible/invisible.

This setting is valid while Programmable Sentinels is disabled.

To configure each Track visible/invisible property from the Individually Selectable Panel.

To configure each Track swipe card data display speed from the Data Speed Selectable Panel.

Configure MSR Translation

From menu 'System->Configure MSR Translation' to enter MSR Translation Configuration Panel.

To select a MSR Translation mode from the MSR Translation mode Configuration Panel.

To set MSR Track display value from the Track1 Configuration Panel and Track 2 & 3 Configuration Panel. This setting is valid while the MSR Translation mode is User Defined.

Press Apply button to let setting take effect.

Configure Prefix and Keyboard

Data identification will take place via a set of special keycodes in front of and behind the datastream from the particular device, for example:

<data id character> <device datastream> <data id character>

The data ID character is represented by a sequence of keycodes that mimics the depression of keys on a PC keyboard that generate an equivalent binary value to applications that read ASCII keyboard characters (ALT+numeric pad characters). The data id character can be explicitly specified to be any value between 00h and Ffh

From menu 'System->Configure Prefix and Keyboard' to enter Prefix/Suffix and Keyboard mode Configuration Panel.

To Configure Internal Keyboard Prefix/Suffix from the Internal Configuration Panel.

To Configure MSR Prefix/Suffix from the MSR Configuration Panel.

To Configure External Device Prefix/Suffix from the External Configuration Panel.

To select active keyboard from the Active Keyboard Mode Selection Panel.

Press Apply button to let setting take effect.

Double Key Setup

Connect external keyboard to IBM SurePOS100 Keyboard by PS/2 or USB and open IBM SurePOS100 Keyboard Configuration Utility (AP).



Press the Double Key Setup Hot Key of the above picture or from menu 'System->Set Doubled Keys' to enter double key setup panel. The original double key setup panel is as PIC_02.



Drag a function Key of the above picture (make horizontal double key, make vertical double key, make quaternary double key, remove horizontal double key, remove vertical double key, remove quaternary double key) to a group of PF Keys and drop to define a double key or remove a double key. PIC_03 is an example of double key setup. We use the same PX to indicate all PX are in the same group PF keys.



Press the PF Key Programming Hot Key of the above picture or from menu 'System->Configure PF Keys' to enter PF Key Programming setup panel and check the setup results.

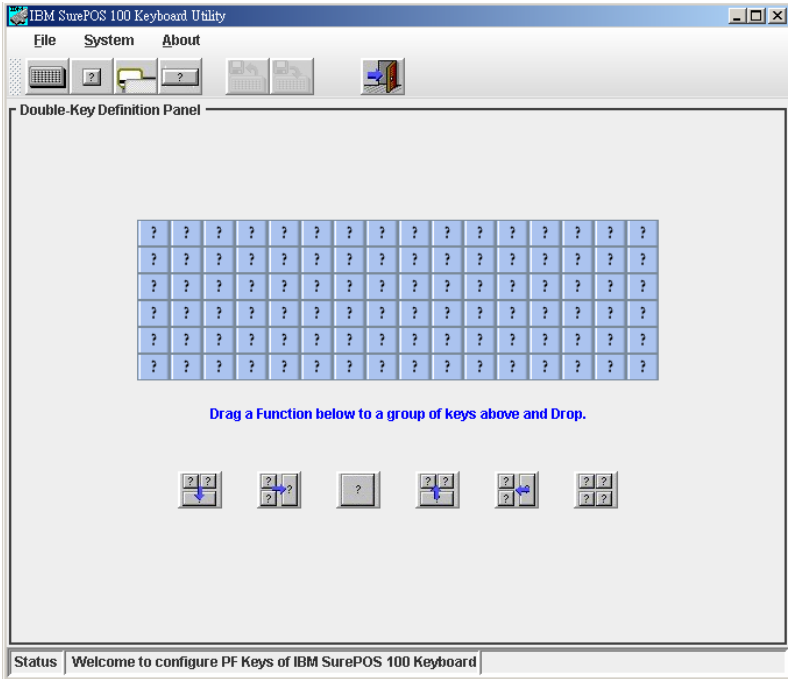

PIC_02

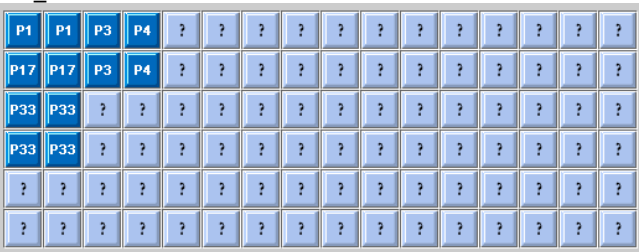

PIC_03

PF Key Programming Setup

Connect external keyboard to IBM SurePOS100 Keyboard by PS/2 or USB and open IBM SurePOS100 Keyboard Configuration Utility (AP).

A dialog which title is 'Query/Download/Upload' appears. You can skip check connection for now.

Enter double key setup panel to set up group key if you need. If you don't setup any group key, there are 96 independent PF keys by default.



Press the PF Key Programming Hot Key of the above picture or from menu 'System->Configure PF Keys' to enter PF Key Programming setup panel. PIC_04 is an example of PF Key Programming. P1 is quaternary group PF key, P3 is vertical group PF key, P33 is horizontal group PF key, and question mark key is empty PF key (non-group key). P1 with red color means active PF key, P1 with black color means non-empty PF key, P3 and P33 with white color means empty PF key, P39 with black color means non-empty PF key (non-group key).

Press any PF key acts active PF key, press Simulated Keyboard key to input PF key data, each PF key can store maximum 20 chars data. Press Save button to save the PF key configuration.

To let the PF Key function work properly, you should set the keyboard mode to pos mode from menu 'System->Configure Prefix and Keyboard'.

After you finish the key programming, you can use Download Configuration to save the results to the SurePOS100 Keyboard. And you can use Upload Configuration to update the Utility Configuration status from the SurePOS100 Keyboard.

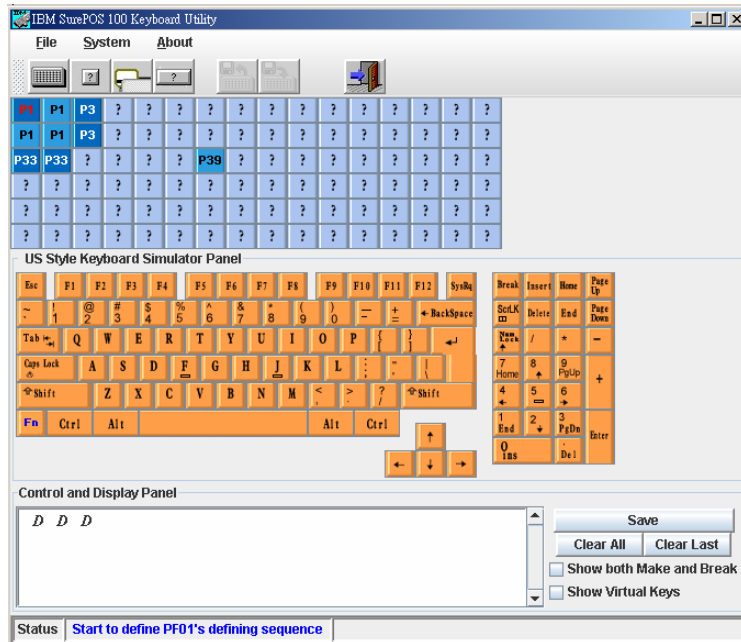

PIC_04

Load Default Keyboard mode

Connect external keyboard to IBM SurePOS100 Keyboard by PS/2 or USB and open IBM SurePOS100 Keyboard Configuration Utility (AP).

From menu 'File->Load 10X Keyboard' to load one default Keyboard mode to PF Key Programming setup panel. Make some proper modify to it, set active keyboard to pos mode, and store it to SurePOS100 keyboard. This function can help you to generate PF Keys which are default keyboard mode alike easily.

Configuration File

Connect external keyboard to IBM SurePOS100 Keyboard by PS/2 or USB and open IBM SurePOS100 Keyboard Configuration Utility (AP).

From menu 'File->New Configuration File' to set utility all configuration items to default value.

From menu 'File->Open Configuration File' to load a configuration file to keyboard utility.

From menu 'File->Save Configuration File' or 'File->Save Configuration File As' to save current configuration results to a SurePOS100 keyboard configuration file(.pcf).

13.4 Programming Limitations

Any combination of a key defined to be a double key and either a SHIFT, CTRL, ALT or Fn key is not supported. This limitation is due to the way the basic keyboard is constructed and is derived from the fact that certain three key combinations cannot be detected by the keyboard controller software.

Each programmed key has the ability to generate up to 20 different scan codes. Depending on the key selected and it's shift/alt/ctl state, this can represent as few as 5 or as many as 20 different keys.

Details of the command/data structure required to setup the keyboard will use proprietary extensions to the existing PC keyboard command/data port. These commands are subject to change. (Typically, only the utility program that sets up the keyboard will use this interface.)

END OF DOCUMENT

Free Manuals Download Website

<http://myh66.com>

<http://usermanuals.us>

<http://www.somanuals.com>

<http://www.4manuals.cc>

<http://www.manual-lib.com>

<http://www.404manual.com>

<http://www.luxmanual.com>

<http://aubethermostatmanual.com>

Golf course search by state

<http://golfingnear.com>

Email search by domain

<http://emailbydomain.com>

Auto manuals search

<http://auto.somanuals.com>

TV manuals search

<http://tv.somanuals.com>