



ThinkPad 770X



Setup Guide

27L3405

This guide provides information for setting up your computer for the first time.

Front View

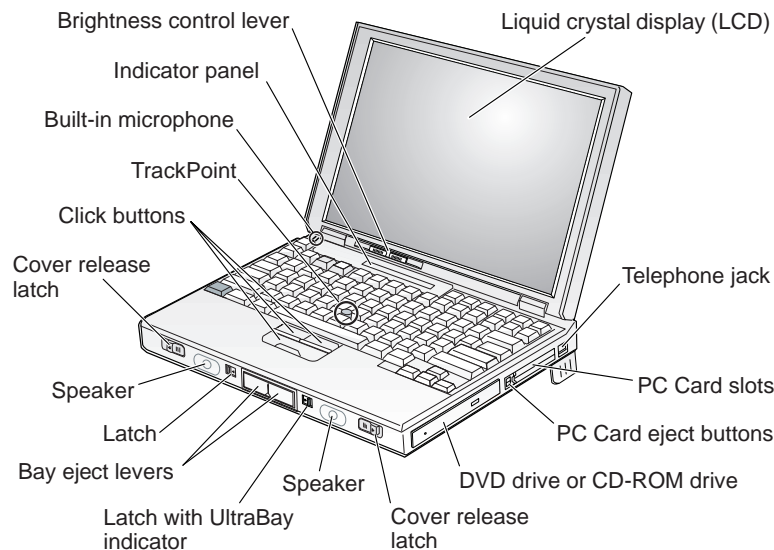

Rear View

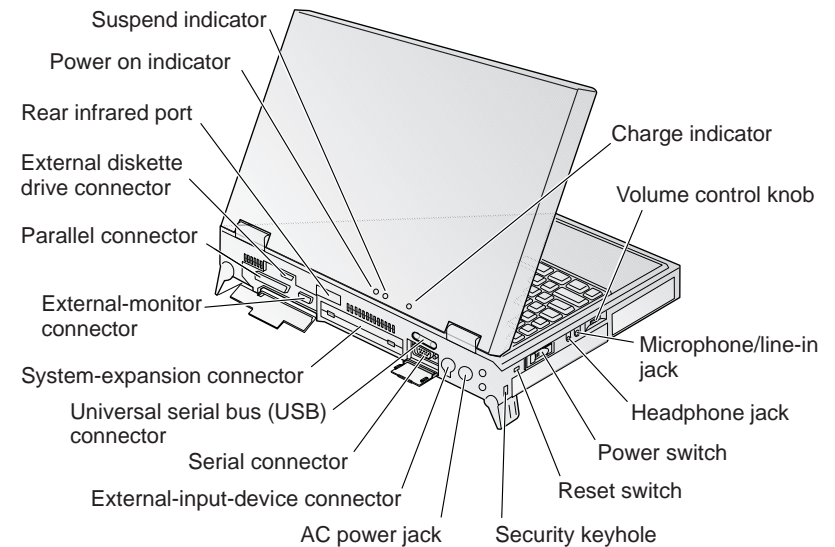

Electrical Safety



Electrical current from power, telephone, and communication cable is hazardous. To avoid shock hazard, connect and disconnect cables as shown below when installing, moving, or opening the covers of the product or attached devices. The 3-pin power cord must be used with a proper outlet.

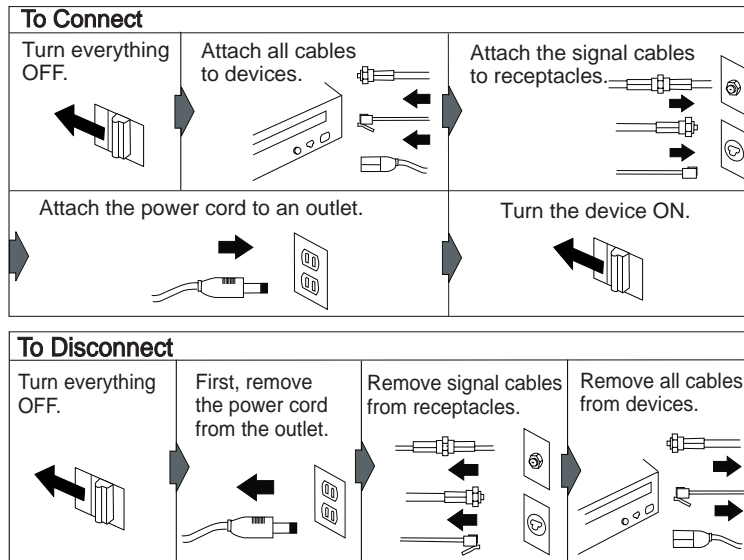

Note: In the U.K., by law:

The telephone line cable must be connected after the power cord.

The power cord must be disconnected after the telephone line cable.

Setting Up Your Computer

You are now ready to assemble and start your computer.

- 1 If you want to connect a printer to your computer, open the connector cover. Connect one end of the printer cable to the parallel connector and the other end to your printer. Then power on the printer.

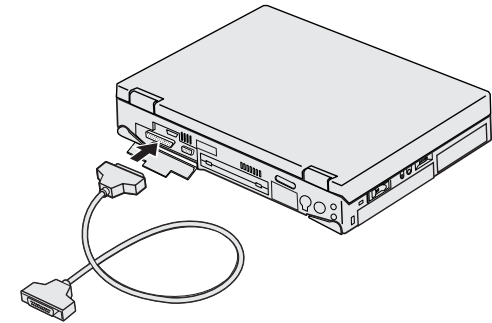

- 2 Connect the AC Adapter to the computer's power jack (at the rear of the computer) in the order shown.

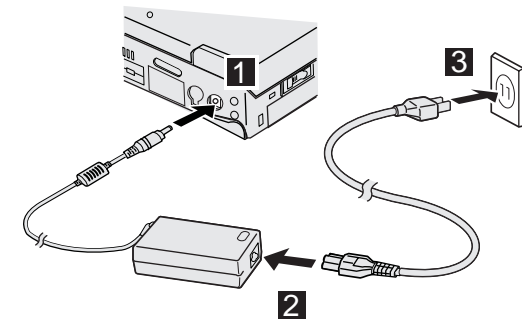

3 Open the liquid crystal display (LCD).

Press the LCD latches **1** and open the LCD **2**. Then position the LCD so that it is convenient for viewing.

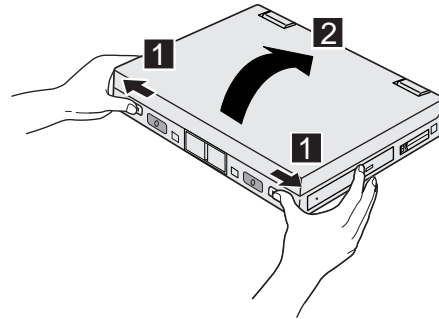

4 Power on the computer.

- a) Push and release the power switch **1**. The power switch automatically snaps back to its original position.
- b) Adjust the brightness of the display with the brightness control **2**.

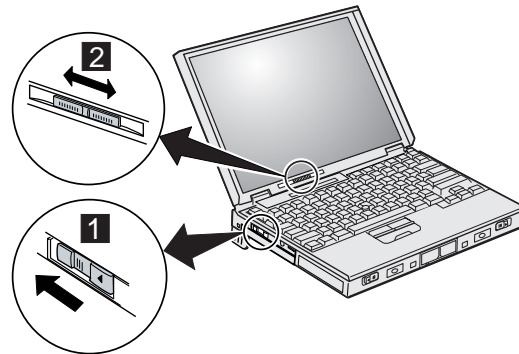

5 If the DVD software not installed in your system, install it according to the *DVD Installation Instruction*.

Customizing Your Computer

After you complete the Windows setup by following the instructions on the screen, the **ThinkPad Customization Center** icon is on your Windows desktop. To help you customize your computer for your specific needs, we have provided a collection of setup wizards known as *ThinkPad Customization Center*.

To start the ThinkPad Customization Center, double-click on the **ThinkPad Customization Center** icon. The ThinkPad Customization Center is launched into the browser, Internet Explorer (Version 4.0 or later). Follow the instructions on the screen.

Note: The **ThinkPad Customization Center** icon does not appear on the desktop of Windows NT. If you are using Windows NT, insert the ThinkPad Customization CD into the CD-ROM drive to start the Customization Center. To use the Customization Center, you need Internet Explorer Version 4.0 or later.

Registering Your Computer

After setting up your computer, take a few moments to complete the ThinkPad registration. The information you provide will help IBM to serve you better in the future. To register from the Windows 98 or Windows NT desktop, do the following:

- 1 Double-click on **Register**.
- 2 Follow the instructions on the screen to complete the registration.
(If you want to register your computer later, follow the same procedure.)

If your computer uses another operating system, go to the following Web site to complete registration:
<http://www.pc.ibm.com/register>

Getting More Information

After you have completed setting up your computer, you can start using it. If you want to learn more about your computer and its options, see the following:

ThinkPad 770X User's Reference	Online User's Guide
Getting familiar with your computer Extending the features of your computer Protecting your computer Solving computer problems Features and specifications	Using your computer outside your home country Using audio, modem, and DVD features Protecting your computer Using your computer with a battery pack Using your computer with a PC Card Getting service Resolving system resource conflicts Frequently asked questions Installing software Using system management Using PS2 commands Handling tips
Note: To start the <i>Online User's Guide</i> , click on Start and move the cursor to Programs and ThinkPad 770 ; then click on ThinkPad 770 User's Guide .	

Check the following ThinkPad Web site for the latest information. When updates become available, they will be posted on:
<http://www.pc.ibm.com/thinkpad>

Free Manuals Download Website

<http://myh66.com>

<http://usermanuals.us>

<http://www.somanuals.com>

<http://www.4manuals.cc>

<http://www.manual-lib.com>

<http://www.404manual.com>

<http://www.luxmanual.com>

<http://aubethermostatmanual.com>

Golf course search by state

<http://golfingnear.com>

Email search by domain

<http://emailbydomain.com>

Auto manuals search

<http://auto.somanuals.com>

TV manuals search

<http://tv.somanuals.com>