

**Handbook
for the
WorkPad® c3 PC Companion**

Copyright

Copyright © 1998 3Com Corporation or its subsidiaries. All rights reserved. 3Com, the 3Com logo, Palm Computing, Graffiti, and HotSync are registered trademarks, and Palm OS, Palm, the Palm Computing Platform logo, and the HotSync logo are trademarks of Palm Computing, Inc., 3Com Corporation or its subsidiaries. The following are registered trademarks of International Business Machines Corporation in the United States and/or other countries: IBM and WorkPad. Other product and brand names may be trademarks or registered trademarks of their respective owners.

Disclaimer and Limitation of Liability

3Com Corporation and its subsidiaries assume no responsibility for any damage or loss resulting from the use of this handbook.

3Com Corporation and its subsidiaries assume no responsibility for any loss or claims by third parties which may arise through the use of this software. 3Com Corporation and its subsidiaries assume no responsibility for any damage or loss caused by deletion of data as a result of malfunction, dead battery, or repairs. Be sure to make backup copies of all important data on other media to protect against data loss.

Important: Please read the 3Com End User Software License Agreement contained in the CD-ROM package before using the accompanying software program(s). Using any part of the software indicates that you accept the terms of the 3Com End User Software License Agreement.

P/N: 405-0436

A/N: 423-0238

Contents

About This Book	1
Chapter 1: Introducing Your WorkPad c3 Companion	
Getting to know your WorkPad c3 companion	3
What is a WorkPad c3 companion?	3
System requirements	4
Upgrade information	4
WorkPad c3 components	5
Recharging the battery	10
Palm Desktop software for IBM WorkPad	11
Using your companion with another PIM	13
Tapping and typing	14
Tap with the stylus to get things done	14
Elements of the companion interface	15
Opening applications	16
Using menus	17
Three ways to enter data	19
Customizing your companion.....	23
Chapter 2: Entering Data in Your WorkPad c3 Companion	
Using Graffiti writing to enter data	25
Writing Graffiti characters	25
Graffiti tips	27
The Graffiti alphabet	28
Writing capital letters	29
Writing numbers	29
Graffiti numbers	30
Writing punctuation marks	30
Writing symbols and extended characters	31
Writing accented characters	32
Accent strokes	32
Additional non-English characters	32
Navigation strokes	33
Graffiti ShortCuts	33
Using the onscreen keyboard	35
Using your computer keyboard	35
Importing data	36
Chapter 3: Managing Your Applications	
Using the Applications Launcher	39
Selecting applications	39
Switching between applications	39

Categorizing applications	39
Changing the Applications Launcher display	40
Choosing preferences.....	41
Installing and removing applications.....	42
Installing add-on applications	42
Installing games	44
Removing applications	45
Removing Palm Desktop for IBM WorkPad	45
Security.....	46
Assigning a password	46
Changing or deleting a password	47
Locking your companion	47
Recovering from a forgotten password	48

Chapter 4: Using Your Basic Applications

Overview of basic applications.....	50
Date Book	50
Address Book	51
To Do List	52
Memo Pad	53
Calculator	53
Expense	54
Common tasks.....	55
Creating records	55
Editing records	55
Deleting records	57
Purging records	58
Exchanging and updating data: HotSync operations	58
Categorizing records	61
Finding records	64
Sorting lists of records	68
Making records private	69
Attaching notes	71
Choosing fonts	72
Application-specific tasks.....	73
Date Book	73
Address Book	86
To Do List	91
Memo Pad	96
Calculator	99
Expense	101

Chapter 5: Communicating Using Your Companion

Managing desktop E-Mail away from your desk.....	111
Setting up Mail on the desktop	112
Synchronizing Mail with your E-Mail application	114
Opening the Mail application on your companion	114
Viewing e-mail items	114
Creating e-mail items	115
Looking up an address	118
Adding details to e-mail items	119
Storing e-mail to be sent later	122
Editing unsent e-mail	122
Draft e-mail	123
Filing e-mail	124
Deleting e-mail	125
Removing e-mail from the Deleted folder	125
Purging deleted e-mail	126
Message List options	126
HotSync options	128
Creating special filters	129
Truncating e-mail items	133
Mail menus	134
Beaming information	135

Chapter 6: Advanced HotSync® Operations

Selecting HotSync setup options.....	137
Customizing HotSync application settings	140
Conducting a HotSync operation via modem.....	142
Preparing your computer	142
Preparing your companion	143
Selecting the conduits for a modem HotSync operation	145
Performing a HotSync operation via a modem	146
Conducting a HotSync operation via a network	146
Connecting to your company's dial-in server	146
Using File Link.....	148
Creating a user profile	148

Chapter 7: Setting Preferences for Your Companion

Viewing preferences	151
Buttons preferences.....	152
Pen preferences	152
HotSync buttons preferences	154
Digitizer preferences.....	154

Formats preferences	154
Country default	155
Time, date, week start, and numbers formats	155
General preferences	156
Auto-off delay	156
Cradle settings	156
System, alarm, and game sounds	157
Beam Receive	157
Modem preferences	158
Network preferences and TCP/IP software	159
Selecting a service	159
Entering a user name	160
Entering a password	161
Adding telephone settings	162
Connecting to your service	165
Creating additional service templates	165
Adding detailed information to a service template	166
Creating a login script	169
Deleting a service template	170
Network preferences menu commands	171
TCP/IP troubleshooting	171
Owner preferences.....	173
ShortCuts preferences	174
Creating a ShortCut	174
Editing a ShortCut	175
Deleting a ShortCut	175

Appendix A: Maintaining Your Companion

Caring for your companion.....	177
Battery considerations.....	178
Resetting your companion.....	179
Performing a soft reset	179
Performing a hard reset	180

Appendix B: Frequently Asked Questions

Software installation problems	183
Operating problems.....	184
Tapping and writing problems.....	185
Application problems.....	186
HotSync problems	187
Beaming problems	191
Recharging problems	192
Password problems	193
Getting Help, Service, and Information	194

Hardware Warranty Summary	194
Before You Call for Service	194
Getting Customer Support and Service	195
Purchasing Additional Services	195
Product Registration and Getting Help by Telephone	195

Appendix C: Creating a Custom Expense Report

About mapping tables	199
Customizing existing sample templates	200
Determining the layout of the Expense Report.....	201
Labels	201
Sections	202
Analyzing your custom Expense Report	203
Programming the mapping table.....	204
Using applications other than Microsoft Excel	208
Expense file details.....	208

Appendix D: Non-ASCII Characters for Login Scripts

Use of ^char	209
Carriage return and line feed	209
Literal characters	210

Warranty and Other Product Information

Product warranties.....	211
IBM U.K. Statement of Warranty	212
Part 1 - General Terms	212
IBM U.K. Statement Of Warranty	
Part 2 - Country-unique Terms	215
IBM U.S., Canada, and Puerto Rico	
Statement Of Limited Warranty.....	219
Part 1 - General Terms	219
IBM U.S. Statement Of Limited Warranty	
Part 2 - Country-unique Terms	222
Notices	226
Year 2000 Readiness and Instructions	226
Trademarks	227
Electronic Emissions Notices.....	227
Federal Communications Commission (FCC) Statement	227
Canadian ICES-003 Statement	228
Australia and New Zealand Class A Statement	228
CE Compliance Statement	228
Statement of Conformity	228
UL/CSA Statement	229

Index	231
--------------------	-----

About This Book

Welcome to the IBM® WorkPad® c3 PC companion. This handbook describes all you need to know about how to use your WorkPad c3 companion and the applications that come with it. It walks you through viewing and entering data, using your WorkPad c3 companion with your computer, and personalizing the companion with your own preferences.

This book is designed to help you get up and running quickly on your companion. The beginning chapter explains the following:

- All the parts of your companion
- The WorkPad c3 interface
- Entering data
- Setting up security and other preferences

After you become familiar with the basic functionality, you can use the rest of this handbook as a reference for less common tasks and for maintaining your WorkPad c3 companion, and also as a source of information if you have problems operating it.

Important: Before using this information and the product it supports, be sure to read the general information under “Notices” in the Warranty and Other Product Information section of this manual.

Chapter 1

Introducing Your WorkPad c3 Companion

This chapter explains the physical buttons and controls on your WorkPad c3 PC companion, how to use your WorkPad c3 companion for the first time, and how to use HotSync® technology to synchronize your WorkPad c3 companion and Palm™ Desktop software for IBM WorkPad.

Getting to know your WorkPad c3 companion

What is a WorkPad c3 companion?

With your WorkPad c3 companion you will no longer have trouble getting to meetings and appointments on time, remembering people's names and personal details, or keeping track of all the items on your to do list. The WorkPad c3 companion can help you improve your track record in all these areas, both at work and at home.

You can enter all your schedule details in Date Book so you can view them by the day, week, or month; you can even set an alarm to remind you of important meetings. Keep all your contact names, addresses, phone numbers, and other details in Address Book, so you can find them as soon as you need them. Add your tasks to To Do List, prioritize them so you do not overlook them, and assign them a due date.

To make sure you do not lose any of this important information, you can synchronize your data with Palm Desktop for IBM WorkPad on your computer so you always have a backup copy. You can set different levels of security for your WorkPad c3 companion so unauthorized eyes cannot view your data.

When you are out of the office, track your expenses for your expense reports; then transfer the data to your computer to print it out. You can write, edit, and view your e-mail, and then synchronize your e-mail with your desktop E-Mail application when you return to your office.

System requirements

To install and operate Palm Desktop for IBM WorkPad, your computer system must meet the following requirements:

Minimum requirements

- Windows 98, Windows 95, or Windows NT 4.0
- IBM-compatible 486 computer or higher
- 8 MB RAM (memory) *minimum*, 16 MB recommended (required with Windows NT 4.0)
- 20 MB available hard disk space
- VGA monitor or better (the WorkPad c3 Quick Tour requires a 256 color video display)
- CD-ROM drive
- Pointing device
- One available serial port

Optional equipment

- WorkPad c3 Modem
- Windows-compatible printer

Upgrade information

If you already own a WorkPad companion, install the version of Palm Desktop for IBM WorkPad that comes with your new WorkPad c3 companion into the same folder as your current Palm Desktop for IBM WorkPad software. All your data will be preserved when you install the new version in the same folder as the previous version. If you use another personal information manager (PIM), such as Microsoft Outlook, you still need to install the most recent HotSync Manager and conduit software from the Palm Desktop software for IBM WorkPad CD-ROM that came with your new companion.

You can perform HotSync operations in exactly the same way, so you can quickly synchronize your data with your new companion. Just remember to synchronize your old companion with Palm Desktop for IBM WorkPad before you synchronize with your new companion, so you have all your latest information. When you synchronize your companion for the first time, select the Desktop overwrites handheld option for all the conduits. See “Customizing HotSync application settings” in Chapter 6 for more information.

WorkPad c3 components

Locating front panel controls

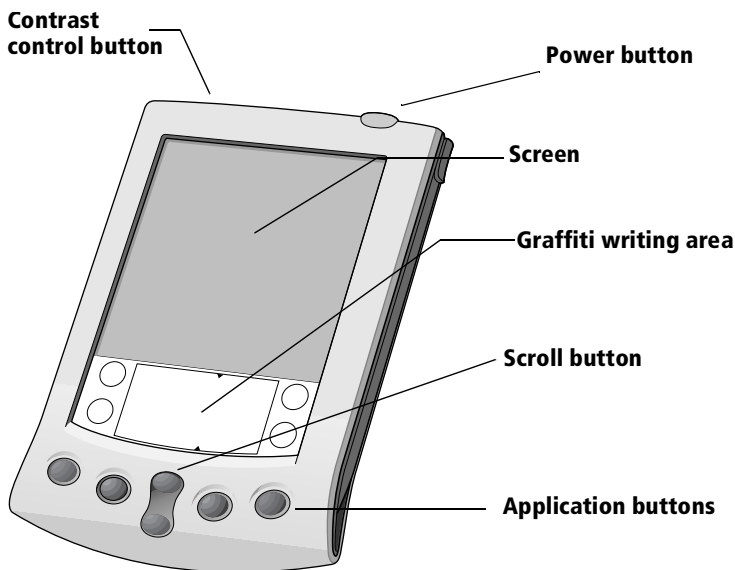

WorkPad c3 companion screen

Displays the applications and information stored in your WorkPad c3 companion. It is touch-sensitive and responds to the stylus.

Graffiti® writing area

The area where you write letters and numbers using the Graffiti® alphabet. See Chapter 2 to learn how to write Graffiti characters.

Application buttons

Activates the individual WorkPad c3 companion applications that correspond to the icons on the buttons: Date Book, Address Book, To Do List, and Memo Pad. See “Buttons preferences” in Chapter 7 for details on reassigning these buttons to activate any application on your WorkPad c3 companion.

Tip: If your WorkPad c3 companion is turned off, pressing any application button activates the WorkPad c3 companion and opens the corresponding application.

Scroll button

Displays text and other information that extends beyond the area of the WorkPad c3 companion screen. Pressing the lower half of the scroll button scrolls down to view information below the viewing area, and pressing the upper half of the button scrolls up to view the information above the viewing area.

Contrast control button

Turns on the onscreen contrast control so you can adjust the screen for the clearest screen display as required by the lighting conditions or temperature of the environment where you use your companion. See “Using the onscreen contrast control” later in this chapter for more information.

Power button

Turns your WorkPad c3 companion on or off and controls the backlight feature. If your WorkPad c3 companion is turned off, pressing the power button turns the unit on and returns you to the last screen you viewed.

If your WorkPad c3 companion is turned on, pressing the power button turns the unit off. Holding the power button down for about two seconds turns the backlight on or off.

Using the onscreen contrast control

Even with the backlight on, you may need to make further adjustments by changing the amount of contrast on the screen.

To adjust the contrast:

1. Press the Contrast control button.
2. To change the contrast in small increments, tap to the left or right of the slider.

To change the contrast in larger increments, drag the slider to the left or right.

Tip: You can also press the scroll button to move the slider incrementally.

3. Tap Done.

Using the backlight

If you have difficulty seeing the information on your WorkPad c3 companion, you can use the backlight to illuminate your screen.

To activate the backlight:

- Press the power button and hold it down for about two seconds. Release the button when the backlight turns on.

To turn off the backlight:

- Press and hold the power button for about two seconds. The backlight also turns off automatically (after a period of inactivity) with the Auto-off feature. See “General preferences” in Chapter 7 for more information.

In addition, you can assign the full-screen pen stroke to activate the backlight. See “Pen preferences” in Chapter 7 for more information.

Locating back panel components

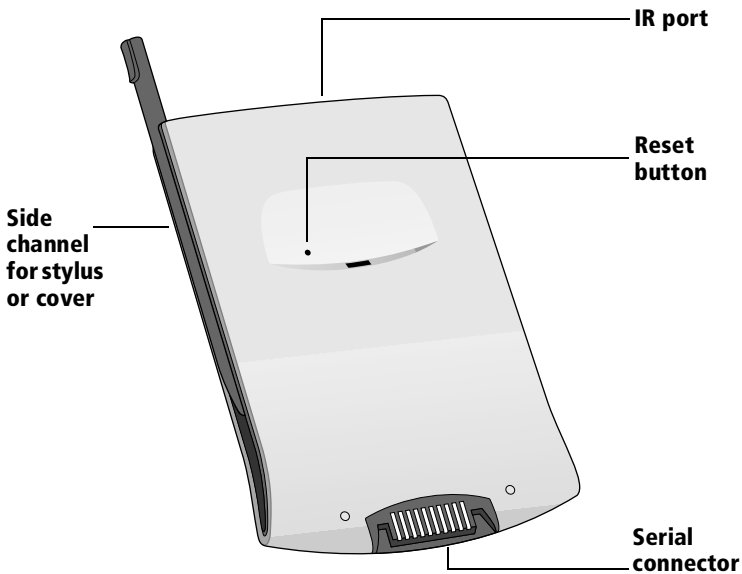

Side channels Hold the stylus or front cover, which slide in and out of either side channel and click into place. To use the stylus, remove it from the side channel and hold it as you would a pen or pencil.

IR port Uses infrared technology to transmit data to and receive data from other infrared enabled WorkPad companions or other Palm Computing® platform devices nearby. See “Beaming information” in Chapter 5 for more information.

Reset button Under normal use, you should not have to use the reset button. See Appendix A for information about when and how to use the reset button.

Serial connector Connects your companion to the cradle, which in turn connects to the back of your computer and through the AC adapter to the wall current. This allows you to recharge your WorkPad c3 companion as well as update the information between your companion and computer using HotSync technology.

Note: The cradle must be plugged into the serial (COM) port at the back of your computer.

Danger: To avoid a shock hazard, do not connect or disconnect any cables or perform installation, maintenance, or reconfiguration of this product during an electrical storm.

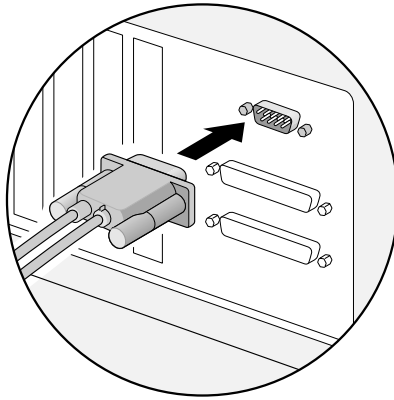

Your WorkPad c3 companion requires a dedicated port. It cannot share a port with an internal modem or other device. If you are unsure about the exact location of the serial port on your computer, refer to the user's manual supplied with the computer.

An additional connection is made from the back of the cradle's serial (COM) port connector to the AC adapter which plugs into any AC current outlet.

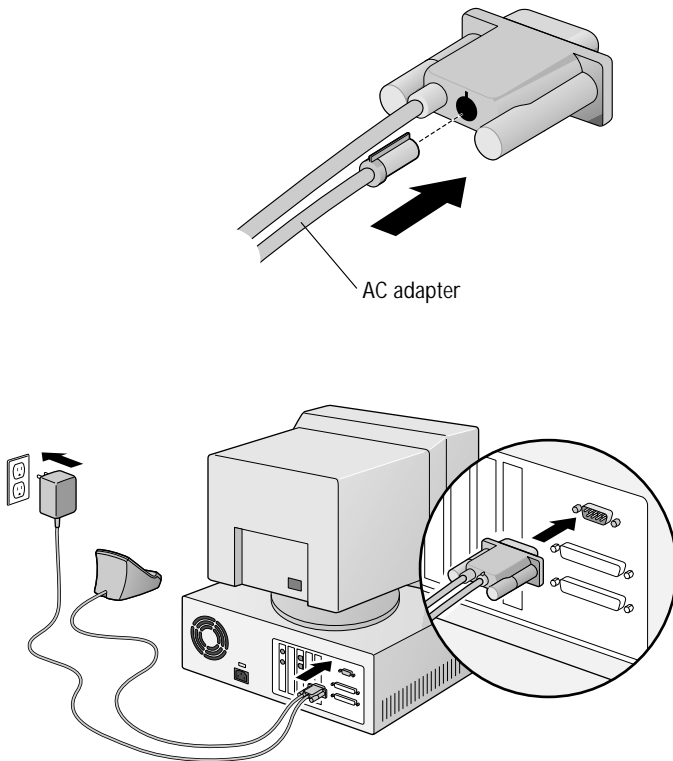

Recharging the battery

The WorkPad c3 companion contains a Lithium-ion battery that is recharged each time you place the companion in the cradle. You never need to replace the battery. Just place your WorkPad c3 companion in the cradle for three hours for an initial charge before you use your companion. Then place it in the cradle for a few minutes each day to recharge the battery to full capacity.

If the battery gets low, your WorkPad c3 companion displays a warning message. If this occurs, perform a HotSync operation and then recharge the battery as soon as possible. If your WorkPad c3 companion shuts down, you still have about a week to recharge the battery before you lose the data on your companion.

Viewing data while in the cradle

You can set a preference so that you can continue to view data while your companion is in the cradle and while the battery is being recharged. See “General preferences” in Chapter 7 for more information.

Palm Desktop software for IBM WorkPad

Palm Desktop for IBM WorkPad extends many of the functions of your WorkPad c3 companion to your computer and serves to back up all your data. Viewing and editing your data using Palm Desktop for IBM WorkPad is optional. However, when you use it with your WorkPad c3 companion and the built-in HotSync technology, you can fully synchronize the information on your WorkPad c3 companion with the information on your computer.

It is a good idea to back up your data in case something happens to the data on your WorkPad c3 companion. Changes you make on your WorkPad c3 companion or Palm Desktop for IBM WorkPad appear in both places after you synchronize.

With Palm Desktop for IBM WorkPad, you can do the following:

- Work with your WorkPad c3 companion applications on your computer. Palm Desktop for IBM WorkPad duplicates the Date Book, Address Book, To Do List, and Memo Pad applications on your companion, so you can view, enter, and modify any data stored on your companion.
- Back up the data stored on your companion with HotSync technology and synchronize the data on your Palm Desktop for IBM WorkPad. Synchronization is a one-step procedure that ensures your data is always safe and up-to-date. See “Exchanging and updating data: HotSync operations” in Chapter 4 for more information.
- Import and export data, so you can easily transfer data from other desktop applications into any of your main applications. See “Importing data” in Chapter 2 for more information.
- Print your Date Book, Address Book, To Do List, and Memo Pad information on any printer.

Installing Palm Desktop for IBM WorkPad

The following instructions guide you through installing Palm Desktop for IBM WorkPad. After installation, refer to the online Help in Palm Desktop for IBM WorkPad for information about how to use the software.

To ensure a safe and uninterrupted installation of Palm Desktop for IBM WorkPad, please do the following before installing:

- Turn off your computer and connect the cradle to it. Do not insert your companion in the cradle until instructed.
- Do *not* simply copy the Palm Desktop for IBM WorkPad files to your computer's hard disk. You must use the installer to place the files in their proper locations and to decompress the files.

To install Palm Desktop for IBM WorkPad:

1. Exit any open programs, including those that run automatically at startup such as Microsoft Office, and disable any virus-scanning software.
2. Insert the Palm Desktop for IBM WorkPad CD-ROM into the computer's CD-ROM drive.
3. Click the Install button to begin the installation procedure.

4. Follow the onscreen instructions to complete the installation. During installation you will be asked to insert your companion into the cradle.

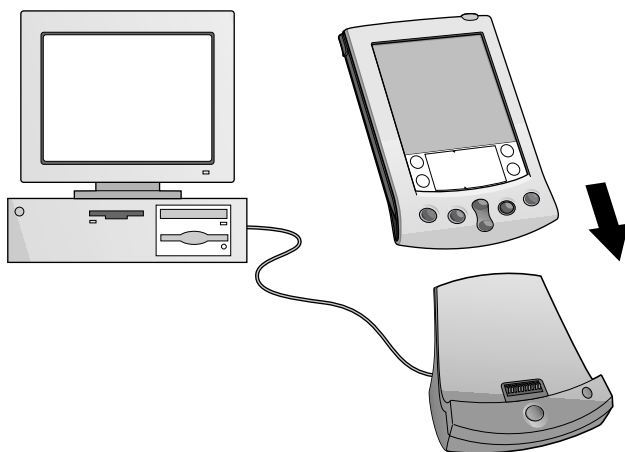

Using your companion with another PIM

If you prefer to use a personal information manager (PIM) other than Palm Desktop for IBM WorkPad or Microsoft Outlook, all you need is HotSync Manager and the connection software, called a conduit, that lets you synchronize the data between your companion and your PIM. For information on conduit software, go to this web site: <http://www.palm.com>.

The installation program can detect that you have Microsoft Outlook on your computer. If it finds Outlook, the program lets you choose between installing Palm Desktop for IBM WorkPad or installing the conduit for Outlook so that you can use that application as your PIM.

Tapping and typing

Tap with the stylus to get things done

Like using a mouse to click elements on a computer screen, using the stylus to tap elements on your companion screen is the basic action that gets things done on your companion.

The first time you start your WorkPad c3 companion, setup instructions appear on the screen. These instructions include a calibration screen, or digitizer. Calibration aligns the internal circuitry of your companion with its touch-sensitive screen so that when you tap an element on the screen, the companion can detect exactly which task you want to perform.

Important: Always use the point of the stylus for tapping or making strokes on the companion screen. Never use an actual pen, pencil, or other sharp object to write on the companion screen.

With your companion turned on, you can tap the companion screen to do many operations, such as the following:

- Open applications
- Choose menu commands
- Initiate a global Find operation
- Select options in dialog boxes
- Open the onscreen keyboards



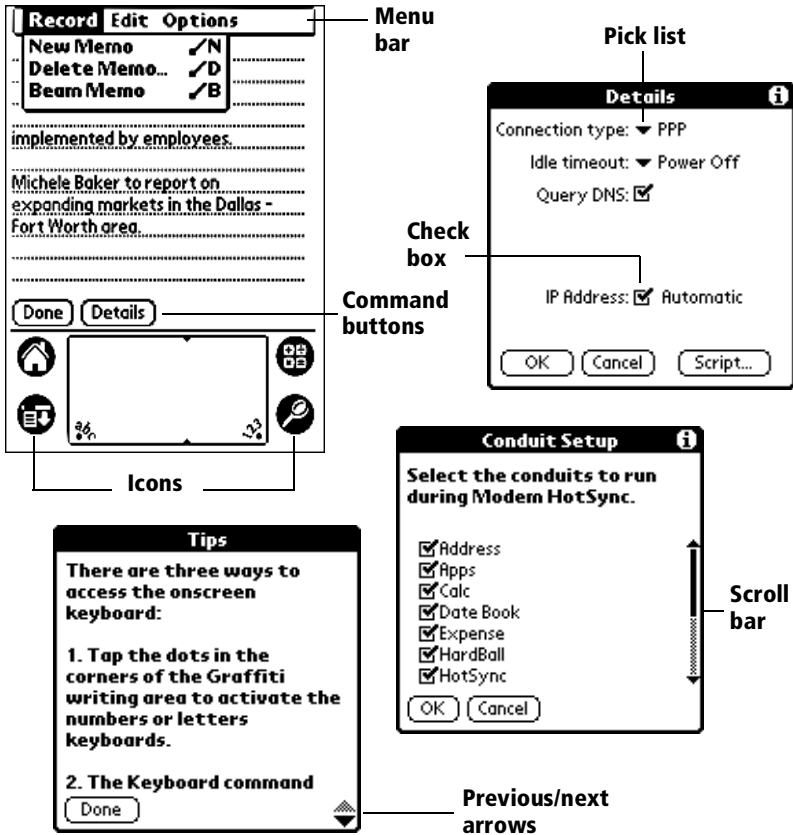

Just as you can drag the mouse to select text or move objects on your computer, you can also drag the stylus to select text. You can also use the stylus to drag the slider of any scroll bar.

Elements of the companion interface



Menu bar A set of commands that are specific to the application. Not all applications have a menu bar.

Command buttons Tap a button to perform a command. Command buttons appear in dialog boxes and at the bottom of application screens.

Icons Tap the icons to open applications , menus , Calculator , and to find text anywhere in your data .

abc With the cursor in an input field, tap the dot to activate the alphabetic keyboard.

- 123** With the cursor in an input field, tap the dot to activate the numeric keyboard.
- Check box** When a check mark appears in a check box, the corresponding option is active. If a check box is empty, tapping it inserts a check mark. If a check box is checked, tapping it removes the check mark.
- Pick list** Tap the arrow to display a list of choices, and then tap an item in the list to select it.
- Scroll bar** Drag the slider, or tap the top or bottom arrow, to scroll the display one line at a time. To scroll to the previous page, tap the scroll bar just above the slider. To scroll to the next page, tap the scroll bar just below the slider.
- You can also scroll to the previous and next pages by pressing the upper and lower portions of the scroll button on the front panel of the companion.
- Next/previous arrows** Tap the up and down arrows to display the previous and next page of information; tap the left and right arrows to display the previous and next record.

Opening applications

You can use the Applications Launcher to open any application installed on your companion. You can also open the four main applications — Date Book, Address Book, To Do List, and Memo Pad — with the application buttons on the front panel of your companion.

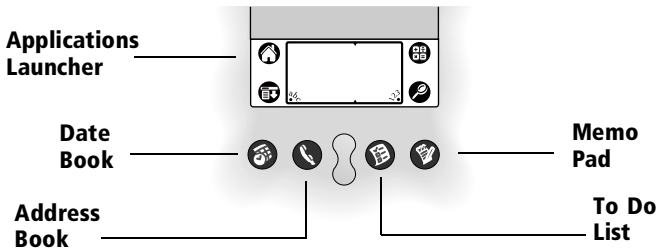

Tip: When you press an application button on the front panel, you have instant access to the selected application. You do not even need to turn on your companion first.

In addition to providing a way for you to open applications, the Applications Launcher displays the current time, battery level, and application category.

To open an application:

1. Tap the Applications icon .



2. Tap the icon of the application that you want to open. If you have many applications installed on your WorkPad c3 companion, tap the scroll bar to see all of your applications.

Tip: To find an application quickly, you can write the Graffiti character for the first letter of its name. The Applications Launcher scrolls to the first application with a name that begins with that letter. You can also assign application icons to different categories. See “Categorizing applications” in Chapter 3.

Using menus

Menus on your companion are easy to use. Once you have mastered them in one application, you can use them the same way in all other applications.

The menus of each application are illustrated in the section on that application in Chapter 4. The Edit menu is described in “Editing records” in Chapter 4.

To open the menu bar:

1. Open an application (such as Memo Pad).
2. Tap the Menu icon .

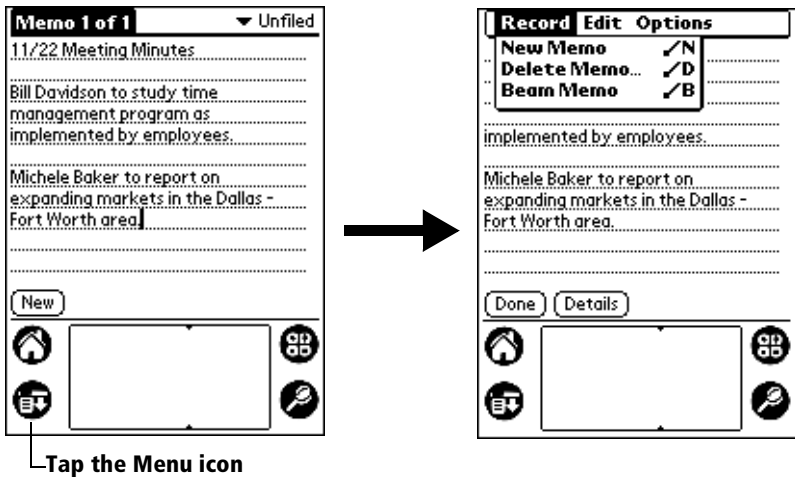

In this example, three menus are available: Record, Edit, and Options. The Record menu is selected and contains the commands New Memo, Delete Memo, and Beam Memo.

Choosing a menu

After you open the menu bar for an application, tap the menu that contains the command you want to use.

The menus and menu commands that are available depend on the application that is currently open. Also, the menus and menu commands vary depending on *which part* of the application you are currently using. For example, in Memo Pad, the menus are different for the Memo List screen and the Memo screen.

Graffiti menu commands

Most menu commands have an equivalent Graffiti Command stroke, which is similar to the keyboard shortcuts used to execute commands on computers. The command letters appear to the right of the command names.



To use the Graffiti menu commands, the menu bar must be closed.

Draw the Command stroke anywhere in the Graffiti area, and immediately write the corresponding command letter in the Graffiti letter area. When you draw the Command stroke, the word “Command” appears just above the Graffiti writing area to indicate that you are in Command mode.

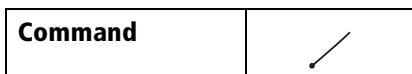

For example, to choose Select All in the Edit menu, draw the Command stroke, followed by the letter “s.”

Note: Command mode is active for approximately two seconds, so you must write the command letter immediately to choose the menu command.

Displaying online tips

Many of the dialog boxes that appear on your companion contain an online Tips icon in the upper-right corner. Online tips anticipate questions you have in a dialog box, provide shortcuts for using the dialog box, or give you other useful information.

To display an online tip:

1. Tap the Tips icon .
2. After you review the tip, tap Done.

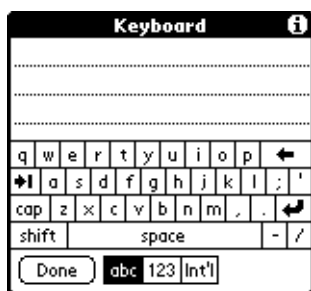

Three ways to enter data

There are three ways to enter data into your WorkPad c3 companion:

- Using the onscreen keyboard
- Using Graffiti writing
- Entering or importing data in Palm Desktop for IBM WorkPad and then synchronizing with your companion

Onscreen keyboard

When you create or edit a record in an application such as Address Book, you can open the onscreen alphabetic and numeric keyboards to enter data.

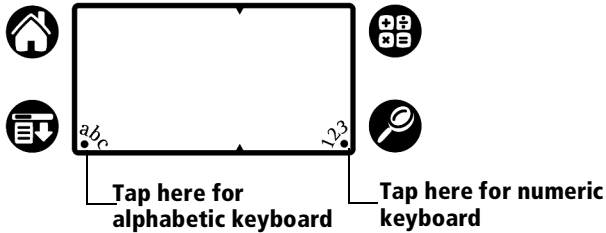

After a keyboard is open, you can tap to open any of the other keyboards, including the international keyboard. See “Using the onscreen keyboard” in Chapter 2 for more information.

Note: You cannot enter Graffiti characters while using the onscreen keyboard.

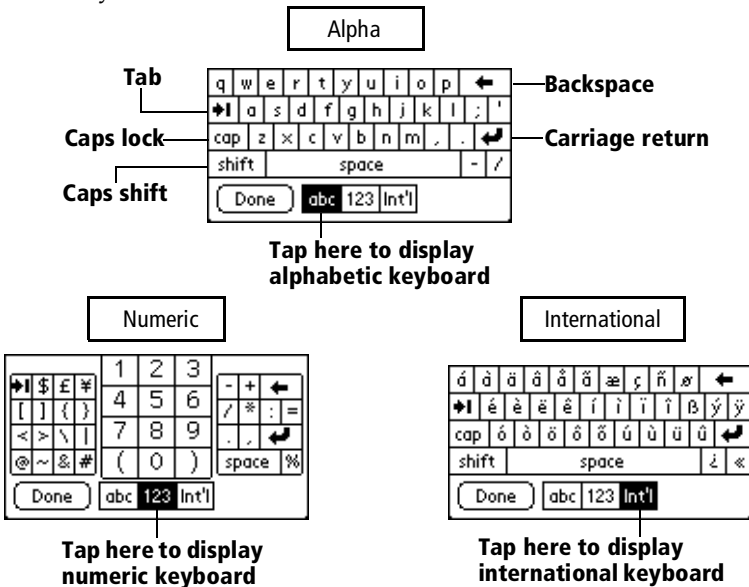

Graffiti writing

Your WorkPad c3 companion includes Graffiti writing software as the primary system for entering text and numbers. With Graffiti writing, you write simple strokes with the stylus and they are instantly recognized as letters or numbers.

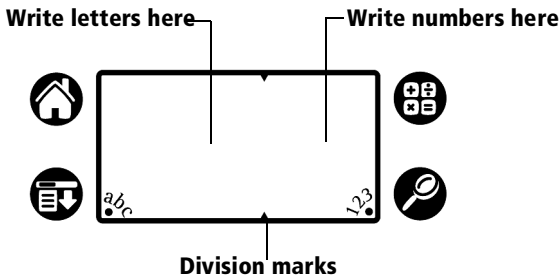

Your WorkPad c3 companion also includes Giraffe, a game you can use to practice Graffiti writing. See “Installing and removing applications” in Chapter 3 for installation instructions. The Memo Pad application is ideal for practicing Graffiti writing. This section explains how to open Memo Pad and use it to practice Graffiti writing.

To open Memo Pad:

1. Press the Memo Pad application button .
2. Tap New.

Note: A blinking cursor appears on the first line of the new memo to indicate where new text will appear.

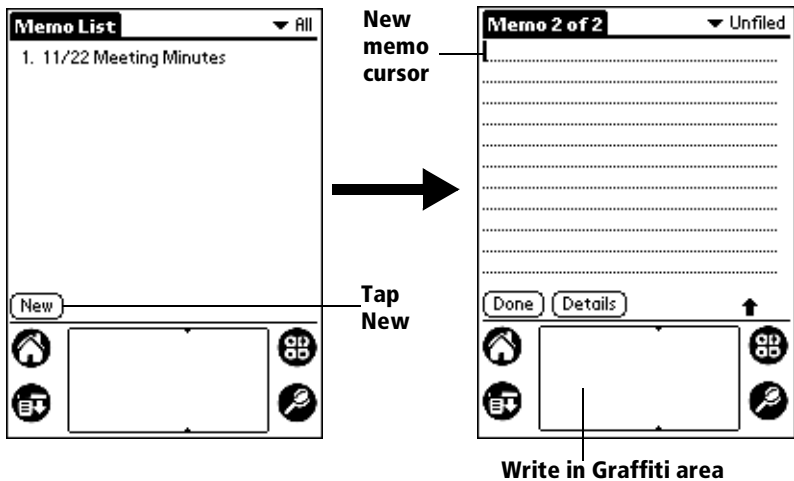

See “Using Graffiti writing to enter data” in Chapter 2 for more information.

Using Palm Desktop for IBM WorkPad

If you have new records you want to add to your WorkPad c3 companion and prefer to use the computer keyboard rather than Graffiti writing or the onscreen keyboard, enter the data in the Palm Desktop for IBM WorkPad or the PIM you have installed to use with your companion.

After the information is in Palm Desktop for IBM WorkPad, perform a HotSync operation to synchronize your companion with your computer. See “Exchanging and updating data: HotSync operations” in Chapter 4 for more information.

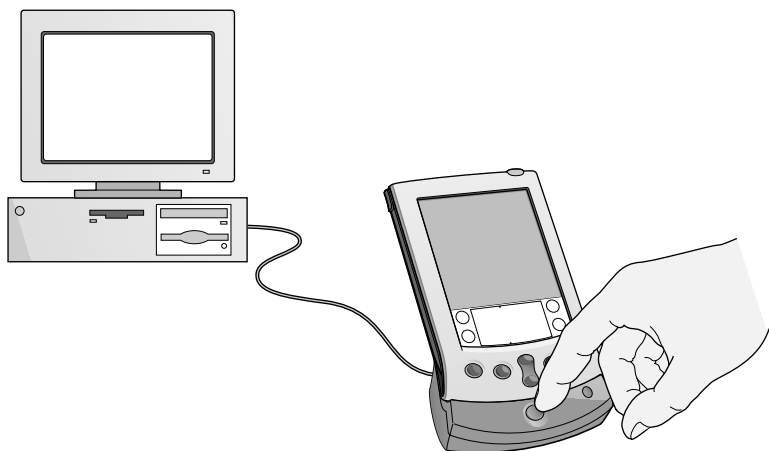



Importing data

If you already have data in a database on your computer, you can import it into the Palm Desktop for IBM WorkPad software. You can import data stored in computer applications such as spreadsheets and databases, or from another WorkPad PC companion or an organizer based on the Palm Computing® platform. When you import data, you transfer the records to your WorkPad c3 companion without having to enter them manually. See “Importing data” in Chapter 2 for more information.

Customizing your companion

You can customize your companion by using the Preferences application. You can enter your personal information such as your name and address; change the time and date; view different date and time formats when you travel; turn off sounds; and configure your companion to work with a modem or network. See Chapter 7 for more information on customizing your companion.

To open the Preferences screens:

1. Tap the Applications icon .
2. Tap the Preferences icon .
3. Tap the category pick list in the upper-right corner of the screen.
4. Tap the Preferences category you want to view.

The following procedures for setting the time and date give you an example of how to customize your companion.

You make changes to the time and date in General preferences.

To set the current time:

1. Tap the Set Time box.

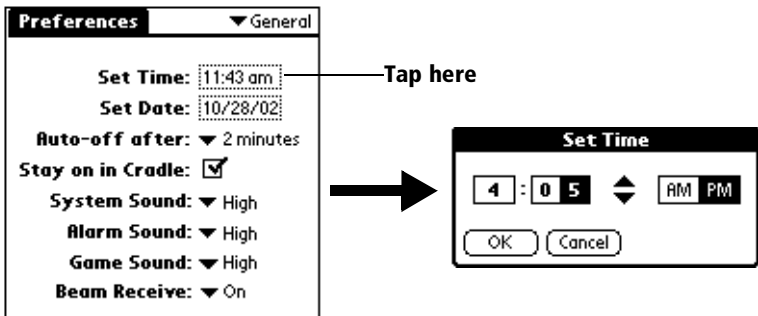

2. Tap the up or down arrows to change the hour.
3. Tap each number of the minute, and then tap the arrows to change them.
4. Tap AM or PM.

Note: Your companion can also display time based on a 24-hour clock. See “Formats preferences” in Chapter 7 for more information.

5. Tap OK.

To set the current date:

1. Tap the Set Date box.
2. Tap the arrows to select the current year.



3. Tap a month.
4. Tap the current date.

Chapter 2

Entering Data in Your WorkPad c3 Companion

This chapter explains how to enter data into your WorkPad c3 companion, by writing with the stylus in the Graffiti® writing area, by using the onscreen keyboard, by using the computer keyboard, or by importing data from another application.

Using Graffiti writing to enter data

Chapter 1 introduced Graffiti writing and briefly described how to use it to enter text in your applications. In this section, you learn the procedures for creating letters, numbers, punctuation, and symbols as well as some Graffiti tips and tricks.

Writing Graffiti characters

Most people find they can enter text quickly and accurately with only minutes of practice. Graffiti writing includes any character you can type on a standard keyboard. The Graffiti strokes closely resemble the uppercase letters of the regular alphabet, which makes Graffiti writing easy to learn.

There are four basic concepts for success with Graffiti writing:

- If you draw the character shape exactly as shown in the tables later in this chapter (like the shapes shown in the following diagram), you achieve 100% accuracy.



- The heavy dot on each shape shows where to begin the stroke. Certain characters have similar shapes, but different beginning and end points. Always begin the stroke at the heavy dot (you should not create the heavy dot; it is only there to show you where to begin the stroke).

- Most characters require only a single stroke. When you lift the stylus from the Graffiti writing area, your companion recognizes and displays the text character immediately. To accomplish single strokes, some Graffiti strokes are portions of the regular alphabet equivalents.
- The Graffiti writing area is divided into two parts: one for writing the letters of the alphabet and one for writing numbers. The small marks at the top and bottom of the Graffiti writing area indicate the two areas.

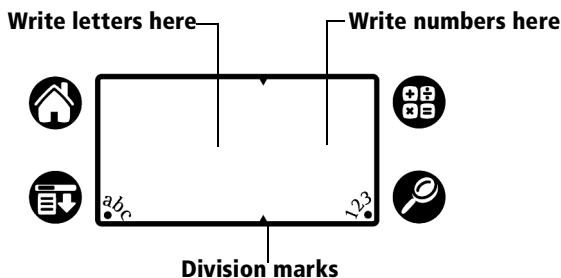

To write Graffiti letters:

1. Tap the screen where you want your text to go.

Note: You need to tap above the Graffiti writing area, and must see a blinking cursor before you write the text.

2. Use the tables on the following pages to find the stroke shape for the letter you want to create. For example, the stroke shown below creates the letter “n.”

Note: There are two different stroke shapes available for some letters. For these letters, choose the one that is easiest for you.

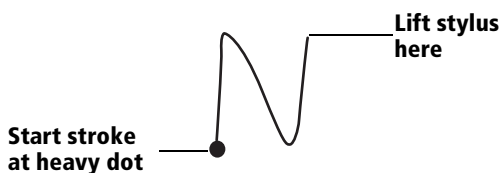

As you will see later, you use the same shape to create both the uppercase and lowercase version of a letter.

3. Position the stylus in the left-hand side of the Graffiti writing area.

4. Start your stroke at the heavy dot and draw the stroke shape as it appears in the tables.
5. Lift the stylus from the screen at the end of the stroke shape.

That is all there is to it! When you lift the stylus from the screen, your companion recognizes your stroke immediately and prints the letter at the insertion point on the screen.

As soon as you lift the stylus from the screen, you can begin the stroke for the next character you want to write.

Important: You must begin the character strokes in the Graffiti writing area. If you do not make Graffiti strokes in the Graffiti writing area, your companion does not recognize them as text characters.

Graffiti tips

When using Graffiti writing, keep these tips in mind:

- Accuracy improves when you write large characters. You should draw strokes that nearly fill the Graffiti writing area.
- To delete characters, simply set the insertion point to the right of the character you want to delete and make the backspace stroke (a line from right to left) in the Graffiti writing area.
- Write at natural speed. Writing too slowly can generate recognition errors.
- Do not write on a slant. Vertical strokes should be parallel to the sides of the Graffiti writing area.
- Press firmly.

The Graffiti alphabet

Letter	Strokes	Letter	Strokes
A		N	
B		O	
C		P	
D		Q	
E		R	
F		S	
G		T	
H		U	
I		V	
J		W	
K		X	
L		Y	
M		Z	
Space		Back Space	
Carriage Return		Period	<i>tap twice</i>

Writing capital letters

You make capital letters with the same stroke shapes as the basic alphabet characters. To make capital letters, you must first “shift” to caps — just as you press the Shift key on a keyboard — and then write the character strokes.

Note: Graffiti writing includes a feature that automatically capitalizes the first letter when you create a new sentence or a new record (by tapping New or a blank line).

To draw the first letter of a word as a capital letter:

- Use the Caps Shift stroke:

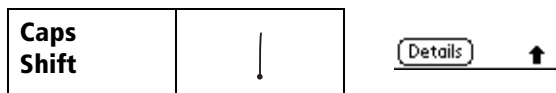

Tip: When Caps Shift is active, an “up arrow” symbol appears in the lower-right corner of the companion screen. If you accidentally activate Caps Shift, backspace will cancel it.

To enter only capital letters (Caps Lock):

- Use the Caps Lock stroke:













Tip: When Caps Lock is active, an underlined “up arrow” symbol appears in the lower-right corner of the companion screen. To return to lowercase, make the Caps Shift stroke.

Writing numbers

Writing numbers with Graffiti writing is similar to writing letters of the alphabet, except that you make the character strokes on the right-hand side (numbers side) of the Graffiti writing area.

Graffiti numbers

Number	Strokes	Number	Strokes
0		5	
1		6	
2		7	
3		8	
4		9	

Writing punctuation marks

Graffiti writing can create any punctuation symbol that you can enter from a standard keyboard. All punctuation marks begin with a single tap on the Graffiti writing area. When you make this tap, you activate Punctuation Shift and a dot appears to show it is active. The next stroke you make with the stylus creates a punctuation mark.

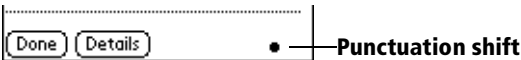

Note: When Punctuation Shift is active, you can make a symbol stroke anywhere in the Graffiti writing area (the letters *or* numbers side).

Symbol	Stroke	Symbol	Stroke
Period .	•	Dash —	—
Comma ,	↗	Left Paren (↷
Apostrophe '	↘	Right Paren)	↶
Question ?	?	Slash /	/
Exclamation !	!	Dollar \$	\$

Additional Graffiti punctuation

@	#	%	^	&	*	<	>	-	+	=	
⓪	∩	∞	∧	Ⓢ	∞	<	>	-	+	=	
\	{	}	[]	~	`	:	:	"	tab	
\	ε	3	ε	3	N	\	/	∩	N	∩	∩

Writing symbols and extended characters

All symbols and extended characters begin with the stroke in the Graffiti writing area of your companion:

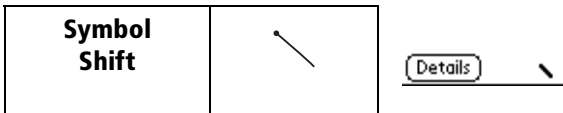

When the Symbol Shift is active, a slanted shift symbol appears in the lower-right corner of the screen. The next stroke that you make creates the symbol or extended character.

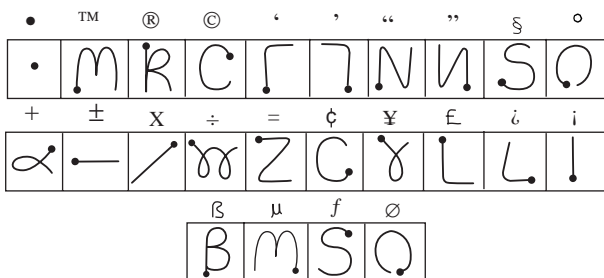

Writing accented characters

To create accented characters, draw the stroke normally used to create the letter, followed by an accent stroke. Graffiti writing then adds the accent to the letter.

For example, the following diagram shows the strokes required to draw an accented “e.”

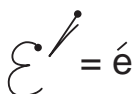

Accent strokes

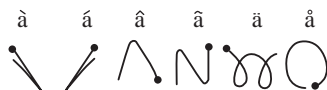

Using these accent strokes, you can write the following accented letters:

à á â ã ä å è é ê ì í î ï ò ó ô õ ö ù ú û ü ý ÿ ñ

Additional non-English characters



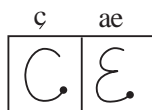

You can write the following characters in the lowercase alphabet mode without any special punctuation or shifting:



Note: You must write these non-English characters in the left side of the Graffiti writing area.

Navigation strokes

In addition to character symbols, Graffiti writing includes special strokes that you can use to navigate within text or fields in your applications.

Command	Stroke
Move cursor right	
Move cursor left	
Previous field (Address Book only)	
Next Field (Address Book only)	
Open Address Record (Address Book only)	

Graffiti ShortCuts

Graffiti ShortCuts make entering commonly used words or phrases quick and easy. ShortCuts are similar to the Glossary or Autotext features of some word processors.

Graffiti writing comes with several predefined ShortCuts, and you can also create your own. Each ShortCut can represent up to 45 characters. For example, you might create a ShortCut for your name, or for the header of a memo. See “ShortCuts preferences” in Chapter 7 to learn about creating your own ShortCuts.

To use a ShortCut, draw the ShortCut stroke followed by the ShortCut characters. When you draw the ShortCut stroke, the ShortCut symbol appears at the insertion point to show that you are in ShortCut mode.

ShortCut	
----------	---

Your companion includes the following predefined Graffiti ShortCuts:

Entry	ShortCut
Date stamp	ds
Time stamp	ts
Date / time stamp	dts
Meeting	me
Breakfast	br
Lunch	lu
Dinner	di

Using the onscreen keyboard

You can open the onscreen keyboard anytime you need to enter text or numbers on your companion. Note that you cannot enter Graffiti characters while using the onscreen keyboard.

To use the onscreen keyboard:

1. Open any application (such as Memo Pad).
2. Tap any record, or tap New.
3. Tap “abc” to open the alphabetic keyboard, or tap “123” to open the numeric keyboard.

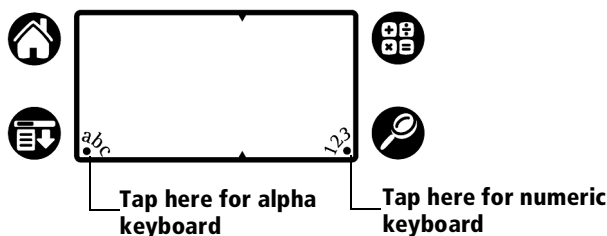

4. Tap the characters to enter text and numbers.

Note: The onscreen keyboard also includes a dialog box for international characters. You can switch among the three dialogs at any time to enter the exact text you need.

5. After you finish, tap Done to close the onscreen keyboard and place the text in the record.

Using your computer keyboard

If you have a lot of data to enter, or prefer to use the computer keyboard, you can use Palm™ Desktop for IBM WorkPad, or any supported PIM, to enter information. You can then perform a HotSync® operation to synchronize the information on your computer with the information on your companion. All the main applications on your companion are also available in Palm Desktop for IBM WorkPad and in most PIMs, so you do not need to learn different applications.

Refer to the online Help for more information on entering data on your computer.

Importing data

If you have data stored in computer applications such as spreadsheets and databases, or if you want to import data from another companion, you can transfer the data to your WorkPad c3 companion without having to key it in manually. Save the data in one of the file formats listed below, import it into Palm Desktop for IBM WorkPad, and then perform a HotSync operation to transfer the data to your companion.

Palm Desktop for IBM WorkPad can import data in the following file formats:

- Comma delimited (.csv, .txt): Address Book and Memo Pad only
- Tab delimited (.tab, .tsv, .txt): Address Book and Memo Pad only
- CSV (Lotus Organizer 2.x/97 Mapping): Address Book only
- Date Book archive (.dba)
- Address Book archive (.aba)
- To Do List archive (.tda)
- Memo Pad archive (.mpa)

Archive formats can only be used with Palm Desktop for IBM WorkPad. Use the archive file formats to share information with other companion users or to create a copy of your important Palm Desktop information.

To import data:

1. Open Palm Desktop for IBM WorkPad.
2. Click the application into which you want to import data.
3. If you are importing records that contain a field with category names, do the following:

Select All in the Category box.

Be sure that the same categories that appear in the imported file also exist in the application. If the categories do not exist, create them now; otherwise, the records are imported into the Unfiled category.

4. From the File menu, choose Import.
5. Select the file you want to import.
6. Click Open.

7. To import data into the correct Palm Desktop fields, drag fields in the left-hand column so that they are opposite the corresponding imported field on the right.
8. If you do not want to import a field, deselect the check box for that field.
9. Click OK.

The imported data is highlighted in the application.

10. To add the imported data to your companion, perform a HotSync operation.

See Palm Desktop online Help for more information on importing and exporting data.

Chapter 3

Managing Your Applications

This chapter explains how to switch between applications on your WorkPad c3 companion, how to change application settings so they are personalized to your work methods, and how to categorize applications so you view them in related groups.

Using the Applications Launcher

To open the Applications Launcher, tap the Applications icon .

Selecting applications

Your WorkPad c3 companion is equipped with a variety of applications. All the applications installed on your companion appear in the Applications Launcher. See “Opening applications” in Chapter 1 for details.



Switching between applications

When working in any application, tap the Applications icon  or press an application button on the front panel of your companion to switch to another application. Your companion automatically saves your work in the current application and displays it when you return to that application.

Categorizing applications

The category feature enables you to manage the number of application icons that appear onscreen in the Applications Launcher. You can assign an application to a category and then display a single category or all your applications.

To categorize an application:

1. Tap the Applications icon .
2. Tap the Menu icon .
3. Tap App, and then tap Category.
4. Tap the pick list next to each application to select a category.



Tip: To create a new category, tap Edit Categories from the pick list. Tap New, enter the category name, and then tap OK to add the category. Tap OK.

5. Tap Done.

To display applications by category:

1. Tap the Applications icon .
2. Do one of the following:



Tap the Applications icon repeatedly to cycle through all your categories.

Tap the pick list in the upper-right corner of the screen and select the category you want to display.

Changing the Applications Launcher display



By default, the Applications Launcher displays each application as an icon. As an alternative, you can choose to show a list of applications. You can also choose to view the same category of applications each time you open the Applications Launcher.

To change the Applications Launcher display:

1. Tap the Applications icon .
2. Tap the Menu icon .
3. Tap Options, and then tap Preferences.
4. Tap the View By pick list and select List.
5. Tap OK.



To open the Applications Launcher to the last opened category:

1. Tap the Applications icon .
2. Tap the Menu icon .
3. Tap Options, and then tap Preferences.
4. Tap the Remember Last Category check box to select it.
5. Tap OK.

Choosing preferences

You can set options that affect an entire application in the application's Preferences dialog box.

To change preferences for an application:

1. Open an application.
2. Tap the Menu icon .
3. Tap Options, and then tap Preferences.

Note: Not all applications have a Preferences command.

4. Make changes to the settings.
5. Tap OK.

Installing and removing applications

This section explains how to install and remove applications on your WorkPad c3 companion and how to remove Palm™ Desktop for IBM WorkPad from your computer.

Installing add-on applications

Your WorkPad c3 companion comes with the Date Book, Address Book, To Do List, Memo Pad, Expense, Calculator, and Mail applications installed and ready to use.

You can also install additional applications on your companion, such as games and other software. The Install Tool makes it easy to install software on your WorkPad c3 companion during a HotSync® operation. There are a variety of third-party applications available for your WorkPad c3 companion. To learn more about these applications, go to the web site: <http://www.palm.com>.

Note: Any game or application that you install on your companion resides in RAM memory; you can delete them at any time.

To install add-on software on your companion:

1. On your computer, copy or download the application you want to install into the add-on folder in your Palm Desktop for IBM WorkPad directory on your computer.

Note: If the software you download is compressed, you need to decompress it into this folder. If you prefer to place the application into another folder, you need to navigate to that folder before you complete step 5.

2. Double-click the Palm Desktop for IBM WorkPad icon on your desktop.

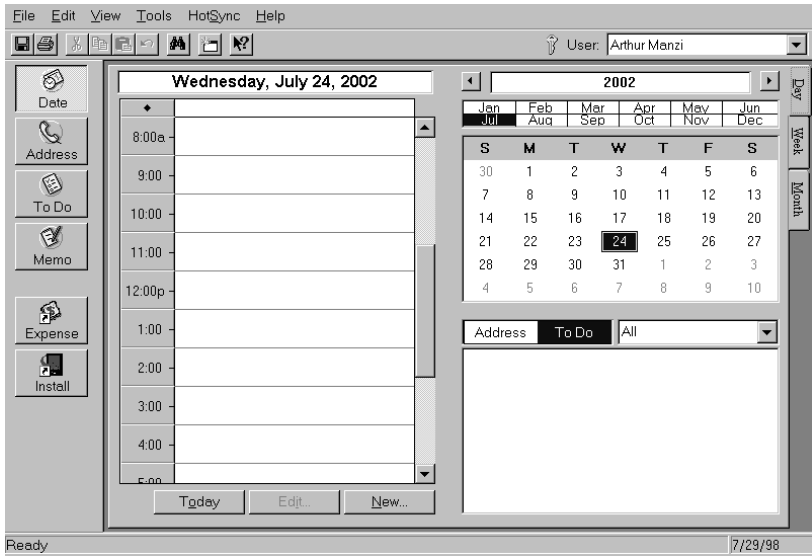

3. Click Install.

Tip: You can also access the Install Tool dialog by selecting Install Tool from the Palm Desktop for IBM WorkPad program group or by double-clicking any file with a PRC file extension.

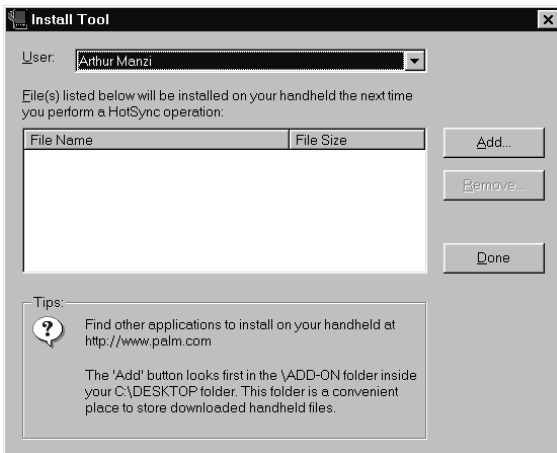

- In the User drop-down list, select the name that corresponds to your WorkPad c3 companion.
- Click Add.

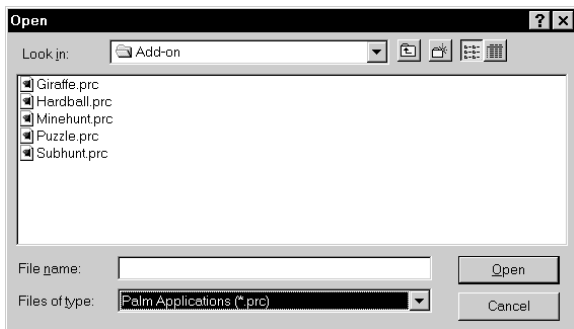

- Select the application(s) you want to install on your companion.
- Click Open.

Note: Review the list of applications you selected in the Install Tool dialog box. If you do not want to install an application, select it, and then click Remove. (This does not remove the application from your computer; it simply removes it from the list of applications to install.)

- Perform a HotSync operation to install the application(s) you selected in step 6. See “Exchanging and updating data: HotSync operations” in Chapter 4 for details.

Installing games

The CD-ROM also includes several games that you can install with the Install Tool:

- Giraffe
- HardBall
- MineHunt
- Puzzle
- SubHunt



Note: Giraffe is a fun, easy way for you to practice Graffiti® writing.

After you install and start a game, the instructions appear in the Game menu. Depending on the game, the Game menu may also contain commands to show high scores, to start a new game, or to set preferences for the game.

Removing applications

In the event that you run out of memory or decide that you no longer need an application you installed, you can remove applications from your companion. You can remove only add-on applications, patches, and extensions that you install; you cannot remove the applications that reside in the ROM portion of your companion.

To remove an add-on application:

1. Tap the Applications icon .
2. Tap the Menu icon .
3. Tap App, and then tap Delete.
4. Tap the application that you want to remove.



5. Tap Delete.
6. Tap Yes.
7. Tap Done.

Removing Palm Desktop for IBM WorkPad

If you no longer want to use Palm Desktop for IBM WorkPad, you can remove it from your computer.

To remove Palm Desktop for IBM WorkPad:

1. From the Windows Start menu, select Settings, then Control Panel.
2. Double-click the Add/Remove Programs icon.
3. On the Install/Uninstall tab, select Palm Desktop for IBM WorkPad.
4. Click Add/Remove.

Note: You need to install the HotSync Manager from the installation CD if you want to synchronize data with another PIM.

Security

Your companion comes with a Security application so that unauthorized users cannot view the entries you wish to protect.

In Security, you can do the following:

- Turn off and lock your companion so that it does not operate until you enter the correct password.
- Hide records that you mark as private. You can hide private records with or without a password. Without a password, private records are hidden until you set the Security application to show them. With a password, you must enter the password to view the private entries. See “Making records private” in Chapter 4 for information on making records private.

Assigning a password

You can assign a password to protect your private records and to lock your companion.

To assign a password:

1. Tap the Applications icon .
2. Tap the Security icon.
3. Tap the Password box.
4. Enter a password.

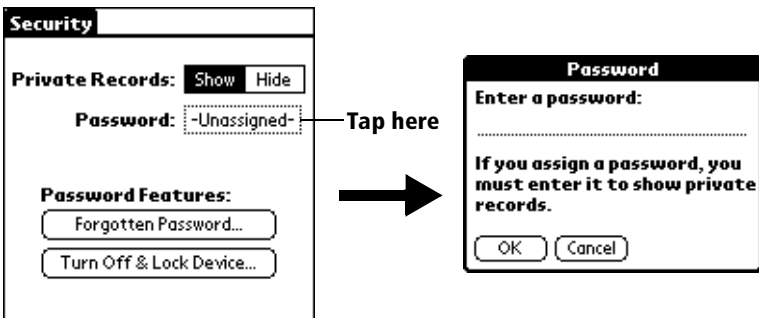

5. Tap OK.
6. Enter the *same* password a second time, and tap OK.

Changing or deleting a password

Once you define a password for your companion, you can change or delete it at any time. You must enter the current password before you can change or delete it.

To change or delete your password:

1. Tap the Password box.
2. Enter the current password.

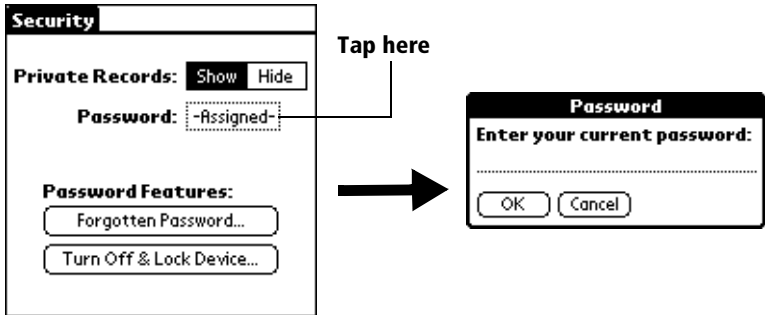

3. Tap OK.
4. Do one of the following:
 - To change the password, enter the new password, and tap OK.
 - To delete the password, tap Delete.



Locking your companion

You can also lock your companion so that you need to enter your password to operate it.

Important: If you lock your companion, you must enter the exact password to re-activate your companion. If you forget the password, you need to perform a hard reset to resume using your companion. Performing a hard reset deletes all the records in your companion; however, you can restore all synchronized data at the next HotSync operation. See “Performing a hard reset” in Appendix A for more information.

To lock your companion with a password:

1. Perform a HotSync operation to synchronize the data between your companion and your computer. See “Exchanging and updating data: HotSync operations” in Chapter 4 for information on synchronizing your data.
2. Assign a password.
3. Tap Turn Off & Lock Device.

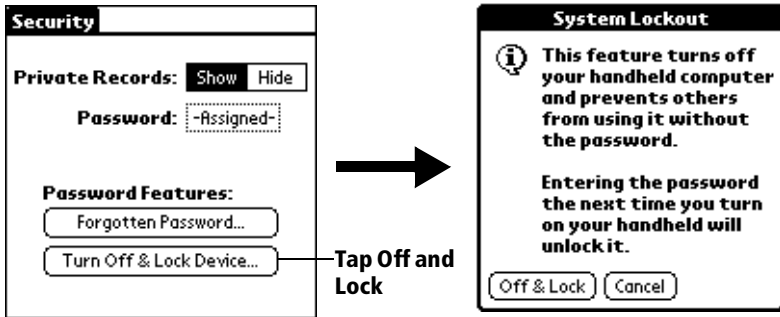

4. Tap Off & Lock.
5. To start your companion, turn it on, and then enter the password.

Recovering from a forgotten password

If you did not activate the Off & Lock feature and you forget your password, you can delete the password from your companion. Deleting a forgotten password also deletes all entries and files marked as Private.

Important: If you synchronize with your computer before deleting a forgotten password, your companion restores your private entries the next time you perform a HotSync operation, but it does not restore the password.

To delete a forgotten password:

1. Tap Forgotten Password.
2. Tap Yes.

Chapter 4

Using Your Basic Applications

Your WorkPad c3 PC companion includes these basic applications:

- Date Book
- Address Book
- To Do List
- Memo Pad
- Calculator
- Expense

This chapter is divided into three sections:

- “Overview of basic applications” briefly describes each application and explains how to open it.
- “Common tasks” gives instructions on how to do tasks that you can do in most or all of the basic applications. It is easy to transfer what you learn in one application to the others because the structure and behavior of all the applications are quite similar.
- “Application-specific tasks” is organized by application and gives instructions on how to do tasks that are specific to each application.

Overview of basic applications

Date Book



Date Book lets you quickly and easily schedule appointments or any kind of activity associated with a time and date.

In Date Book, you can do the following:

- Enter a description of your appointment and assign it to a specific time and date.
- Display a chart of your appointments for an entire week. The Week View makes it easy to spot available times and any potential scheduling overlaps or conflicts.
- Display a monthly calendar to quickly spot days where you have morning, lunch, or afternoon appointments.
- Set an alarm to sound prior to the scheduled activity.
- Create reminders for events that are based on a particular date, rather than time of day. Birthdays and anniversaries are easy to track with your PC companion.
- Attach notes to individual events for a description or clarification of the entry in your Date Book.

To open Date Book:

- Press the Date Book application button on the front panel of your companion. Date Book opens to today's schedule.

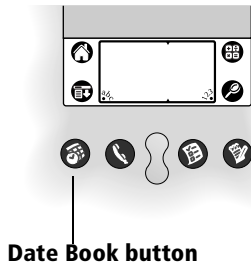

Note: Press the Date Book application button repeatedly to cycle through the Day, Week, and Month views.

Address Book



Address Book enables you to keep names, addresses, phone numbers, and other information about your personal or business contacts.

In Address Book, you can do the following:

- Quickly look up or enter names, addresses, phone numbers, and other information.
- Enter up to five phone numbers (home, work, fax, car, etc.) or e-mail addresses for each name.
- Define which phone number appears in the Address List for each Address Book entry.
- Attach a note to each Address Book entry, in which you can enter additional information about the entry.
- Assign Address Book entries to categories so that you can organize and view them in logical groups.

To open Address Book:

- Press the Address Book application button on the front panel of your companion. Address Book opens to display the list of all your records.

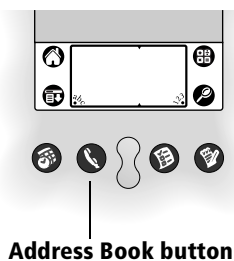

Note: Press the Address Book application button repeatedly to cycle through the categories in which you have records.

To Do List



To Do List is a convenient place to create reminders and prioritize the things that you have to do.

In To Do List, you can do the following:

- Make a quick and convenient list of things to do.
- Assign a priority level to each task.
- Assign a due date for any or all of your To Do List items.
- Assign To Do List items to categories so that you can organize and view them in logical groups.
- Sort your To Do List items either by due date, priority level, or category.
- Attach notes to individual To Do List items for a description or clarification of the task.

To open To Do List:

- Press the To Do List application button on the front panel of your companion. To Do List opens to display the category of items you last viewed.

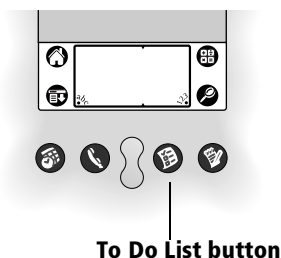

Note: Press the To Do List application button repeatedly to cycle through the categories in which you have items.

Memo Pad



Memo Pad provides a place to take notes that are not associated with records in Date Book, Address Book, or To Do List.

In Memo Pad, you can do the following:

- Take notes or write any kind of message on your PC companion.
- Drag and drop memos into popular computer applications like Microsoft Word when you synchronize using Palm™ Desktop for IBM WorkPad and HotSync® technology.
- Assign memos to categories so that you can organize and view them in logical groups.
- Write down phone numbers and other types of information. Later, you can copy and paste this information to other applications.

To open Memo Pad:

- Press the Memo Pad application button on the front panel of your companion. Memo Pad opens to display the last Memo Pad screen that you viewed.

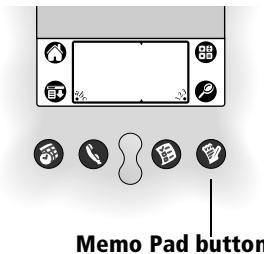

Note: Press the Memo Pad application button repeatedly to cycle through the categories in which you have memos.

Calculator



Calculator enables you to perform addition, subtraction, multiplication, and division.

In Calculator, you can do the following:

- Perform basic calculations.
- Store and retrieve values.
- Display the last series of calculations, which is useful for confirming a series of “chain” calculations.

To open Calculator:

- Tap the Calculator icon  next to the Graffiti® writing area.

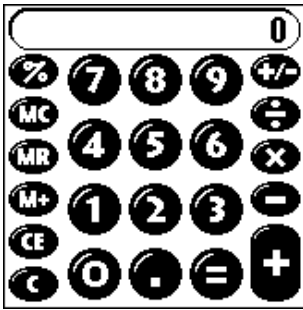



Expense

-  Expense lets you keep track of your expenses and then transfer the information to a spreadsheet on your computer.

In Expense, you can do the following:

- Record dates, types of expenses, amount spent, payment method, and other details associated with any money that you spend.
- Assign expense items to categories so that you can organize and view them in logical groups.
- Keep track of vendors (companies) and people involved with each particular expense.
- Log miles traveled for a particular date or expense category.
- Sort your expenses by date or expense type.
- Transfer your expense information to a Microsoft Excel spreadsheet (version 5.0 or later) on your computer. (Microsoft Excel is *not* included in the WorkPad c3 companion package.)

To open Expense:

1. Tap the Applications icon .
2. Tap the Expense icon .

Common tasks

The tasks described in this section use the term “records” to refer to an individual item in any of the basic applications: a single Date Book event, Address Book entry, To Do List item, Memo Pad memo, or Expense item.

Creating records

You can use the following procedure to create a new record in Date Book, Address Book, To Do List, Memo Pad, and Expense.

To create a record:

1. Select the application in which you want to create a record.
2. Tap New.
3. In Date Book only: Select start and end times for your appointment and tap OK.
4. Enter text for the record.
5. (Optional) Tap Details to select attributes for the record.
6. In Address Book and Memo Pad only: Tap Done.

There is no need to save the record because your companion saves it automatically.

Editing records

After you create a record, you can change, delete, or enter new text at any time. Two screen features tell you when your companion is in editing mode:

- A blinking cursor
- One or more edit lines

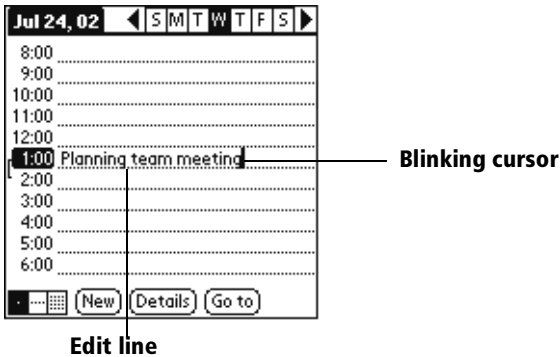

Entering text

For information on how to enter text using Graffiti writing, the onscreen keyboard, or the keyboard attached to your computer, see Chapter 2.

Edit menu

The Edit menu is available with any screen where you enter or edit text. In general, commands available in the Edit menu apply to text that you *select* in an application.

To select text in an application:

1. Tap the beginning of the text that you want to select.
2. Drag the stylus over the text to highlight it (in black).

Note: You can drag *across* the text to select additional words, or drag *down* to select a group of lines.

The following commands may appear in an Edit menu:

Undo	Reverses the action of the <i>last edit</i> command. For example, if you used Cut to remove text, Undo restores the text you removed. Undo also reverses deletions done by using backspace.
Cut	Removes the selected text and stores it temporarily in the memory of your companion. You can paste the text you cut into another area of the current application or into a different application.
Copy	Copies the selected text and stores it temporarily in the memory of your companion. You can paste the text that you copy into another area of the current application or into a different application.
Paste	Inserts the text that you cut or copied at the selected point in a record. The text you paste replaces any selected text. If you did not previously cut or copy text, Paste does nothing.
Select All	Selects all of the text in the current record or screen. This enables you to cut or copy all of the text and paste it elsewhere.

- Keyboard** Opens the onscreen keyboard. When you finish with the onscreen keyboard, tap Done.
- Graffiti Help** Opens screens that show all the Graffiti character strokes. Use this command anytime you forget a stroke for a character.

Deleting records

To delete a record in any of the basic applications:

1. Select the record you want to delete.
2. Tap the Menu icon .
3. Tap Record, and then tap the Delete command:

Date Book: Delete Event

Address Book: Delete Address

To Do List: Delete Item

Memo Pad: Delete Memo

Expense: Delete Item

A confirmation dialog box appears. If you want to save a copy of the deleted item to an archive file in Palm Desktop for IBM WorkPad, be sure that the check box is checked. If you do not want to save a copy, tap the check box to remove the check.

4. Tap OK.

If you choose to save a copy of the selected item, your companion transfers it to the archive file on your desktop the next time you perform a HotSync operation.

Other ways to delete records

You can also delete records in the following ways:

- In the Details dialog box of the application, tap Delete, and then tap OK.
- Delete the text of the record.

Note: In Date Book, if you delete the text of a repeating event, you delete all instances of that event.

Purging records

Over time, as you use Date Book, To Do List, and Expense, you will accumulate records in these applications that have outlived their usefulness. For example, events that occurred months ago remain in the Date Book, and To Do List items that you marked as completed remain in the list, as do Expense items.

All these outdated records take up memory on your companion, so it is a good idea to remove them by using Purge. If you think Date Book or To Do List records might prove useful later, you can purge them from your companion and save them in an archive file.

Purging is also available in Mail. See Chapter 5 for more information.

Purging is not available in Address Book or Memo Pad, so delete outdated records from these applications.

To purge records:

1. Open the application.
2. Tap the Menu icon .
3. Tap Record, and then tap Purge.

A confirmation dialog box appears.

Date Book: Tap the pick list and select how old a record must be to be purged. Purge deletes repeating events if the last of the series ends before the date that you purge records.

Date Book, To Do List: If you want to save a copy of the purged records to an archive file on your desktop, be sure that the check box is checked. If you do not want to save a copy, tap the check box to remove the check box.

4. Tap OK.

If you chose to save a copy of the purged records, your companion transfers them to an archive file on your desktop the next time you perform a HotSync operation.

Note: Purging does not happen automatically. You must tap the command to make it happen.

Exchanging and updating data: HotSync operations

The HotSync process automatically synchronizes — that is, exchanges and updates — data between your companion and Palm Desktop for IBM WorkPad. Changes you make on your companion or Palm

Desktop for IBM WorkPad appear in both places after a HotSync operation. HotSync technology synchronizes only the needed portions of files, thus reducing synchronization time.

You can synchronize your data by connecting your companion directly to your computer with the cradle or indirectly with a WorkPad c3 Modem or network. See Chapter 6 for information about performing HotSync operations via a modem or network.

Performing a HotSync operation for the first time

The first time you synchronize your data, you need to enter user information on both the companion and Palm Desktop for IBM WorkPad. After you enter this information and synchronize, the HotSync Manager recognizes your companion and does not ask for this information again.

If you are a System Administrator preparing several PC companions for a group of users, see “Creating a user profile” in Chapter 6 before performing the following steps.

Important: You must perform your *first* HotSync operation with a local, direct connection, rather than using a modem.

The following steps assume that you have already installed the Palm Desktop for IBM WorkPad. If you have not installed this software, see “Installing Palm Desktop for IBM WorkPad” in Chapter 1 for details.

To perform a local HotSync operation:

1. Insert your companion into the cradle.

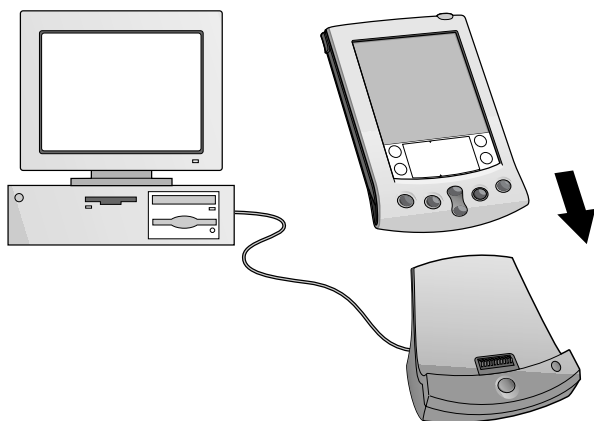

Tip: The bottom edge of the companion should align smoothly with the cradle when it is inserted properly.

2. If the HotSync Manager is not running, start it: click the Windows Start button, choose Programs, choose the Palm Desktop for IBM WorkPad program group, and then choose HotSync Manager. Alternatively, you can start Palm Desktop for IBM WorkPad which automatically opens the HotSync Manager.
3. Press the HotSync button ™ on the cradle.

Note: If you are using an optional HotSync cable instead of a cradle, click the HotSync icon in the Windows system tray and select Local from the menu.

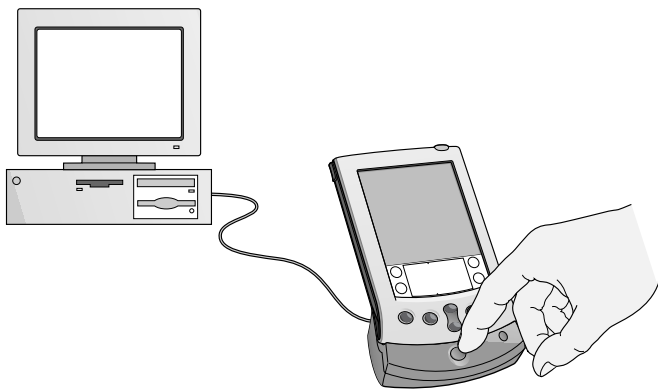

Important: The first time you perform a HotSync operation, you must enter a user name in the New User dialog box and click OK. Every companion should have a unique name. To prevent loss of a user's data, never try to synchronize more than one companion to the same user name.

The HotSync Progress dialog box appears and synchronization begins.

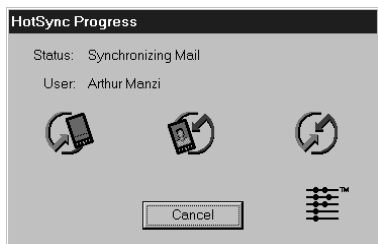

4. Wait for a message on your companion indicating the process is complete.

After the HotSync process is complete, you can remove your companion from the cradle.

Categorizing records

Categorize records in the Address Book, To Do List, Memo Pad, and Expense applications so that they are grouped logically and are easy to review. (You can also categorize applications. See “Using the Applications Launcher” in Chapter 3 for more information.)

When you create a record, your companion automatically places it in the category that is currently displayed. If the category is All, your companion assigns it to the Unfiled category. You can leave an entry as Unfiled or assign it to a category at any time.

You can define up to 15 categories for each application.

Default categories

Your companion comes with two default categories: Business and Personal. In addition, the Address Book contains the QuickList category, which you can use as a quick reference of names, addresses, and phone numbers (such as emergency numbers, doctor, lawyer, etc.).

Expense contains two default categories, New York and Paris, to show how you might sort your expenses for different business trips.

You can rename or delete these default categories.

Note: The illustrations shown are from Address Book, but you can use these procedures in all the applications in which categories are available. Categorizing is not available in Date Book.

To move a record into a category:

1. Select the record you want to categorize.
2. In Address Book only: Tap Edit.
3. Tap Details.
4. Tap the Category pick list to display the list of available categories.



5. Select the category for the record.
6. Tap OK.

To display a category of records:

1. Tap the category pick list in the upper-right corner of the List screen.

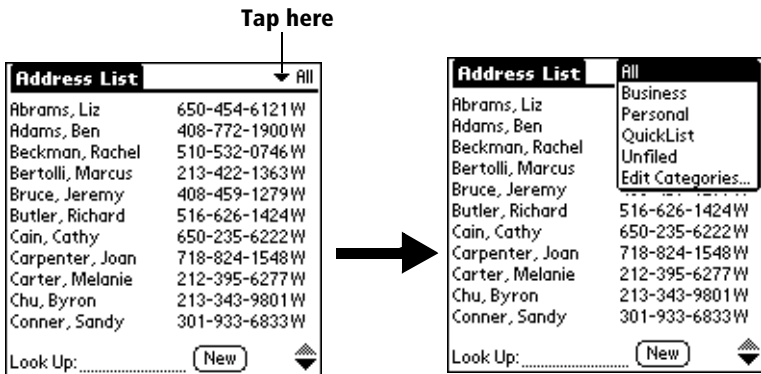

2. Select the category you want to view.

The List screen now displays only the records assigned to that category.

Tip: Pressing an application button on the front panel of the companion toggles through all the categories of that application.

To define a new category:

1. Tap the category pick list in the upper-right corner of the screen.

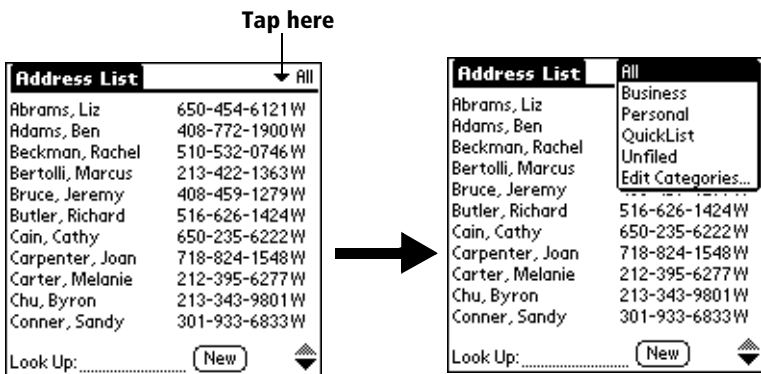

2. Tap Edit Categories.
3. Tap New.



4. Enter the name of the new category, and then tap OK.



5. Tap OK.

You can assign any of your records to the new category.

To rename a category:

1. Tap the category pick list in the upper-right corner of the screen.
2. Tap Edit Categories.
3. Select the category that you want to rename, and then tap Rename.



4. Enter the new name for the category, and then tap OK.



5. Tap OK.

Tip: You can group the records in two or more categories into one category by giving the categories the same name. For example, if you change the name of the Personal category to Business, all records formerly in the Personal category appear in the Business category.

Finding records

Your companion offers several ways to find information quickly:

- **All applications:** Find locates any text that you specify, always starting with the current application.
- **Date Book, To Do List, Memo Pad:** Phone Lookup displays the Address List screen and lets you add the information that appears in this list to a record.
- **Address Book:** The Look Up line lets you enter the first letters of a name to scroll immediately to that name.
- **Expense:** Lookup displays the names in your Address Book that have data in the Company field. You can add these names to a list of attendees associated with an Expense record.

Looking up Address Book records

When working with Address Book, the scroll button on the front panel of the companion makes it easy to navigate among your address entries.

- In the Address List screen, the scroll button moves up or down an entire screen of records. If you hold down the scroll button, you accelerate the scrolling and display every third screen.
- In the Address View screen, the scroll button moves to the previous or next address record.

You can also use the Address List Look Up feature to quickly scroll to any of your Address Book entries.

To look up an Address Book record:

1. Display the Address List screen.
2. Enter the first letter of the name you want to find.

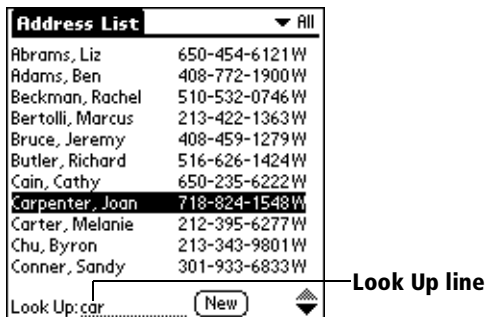

The list scrolls to the first entry that begins with that letter. If you write another letter, the list scrolls to the first entry that starts with those *two* letters. For example, writing an “s” scrolls to “Sands,” and writing “sm” scrolls further to “Smith.” If you sort the list by company name, the Look Up feature scrolls to the first letter of the company name.

3. Tap the record to view its contents.

Using Find

You can use Find to locate any text that you specify, in any application.

To use Find:

1. Tap the Find icon .

Tip: If you select text in an application before you tap Find, the selected text automatically appears in the Find dialog box.

2. Enter the text that you want to find.

Find is *not* case-sensitive. For example, searching for the name “davidson” also finds “Davidson.”

Find locates any words that begin with the text you enter. For example, searching for “plane” finds “planet,” but not “air-plane.”

3. Tap OK.

Find searches for the text in all records and all notes.

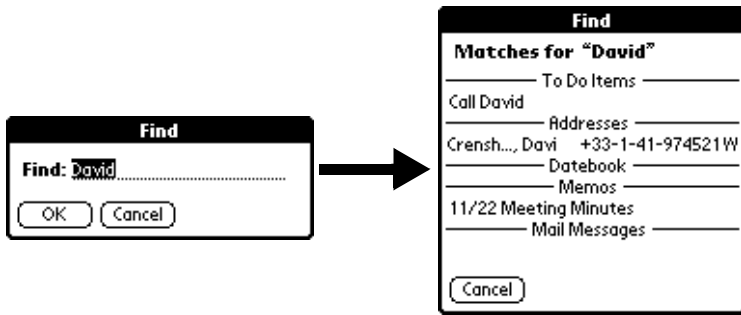

As your companion searches for the text, you can tap Stop at any time. You may want to do this if the entry you want appears before your companion finishes the search. To continue the search after you tap Stop, tap Find More.

4. Tap the text that you want to review.

Using Phone Lookup

Phone Lookup displays the Address List screen and lets you add the information that appears in this list to a record.

To use Phone Lookup:

1. Display the record in which you want to insert a phone number. The record can be in Date Book, To Do List, or Memo Pad.
2. Tap the Menu icon .
3. Tap Options, and then tap Phone Lookup.
4. Begin to spell the last name of the name you want to find.

The list scrolls to the first record in the list that starts with the first letter you enter. Continue to spell the name you are looking for, or when you see the name, tap it.



5. Tap Add.

The name you selected, along with the other information associated with it, is pasted into the record you selected in step 1.

Phone Lookup tips

Write the Graffiti Command stroke “/L” to activate the Phone Lookup feature. You can also activate it in the following circumstances:

- **While entering text:** For example, to insert the full name and phone number for someone with the last name “Williams,” write the Graffiti characters for “Wi” and then the Phone Lookup Command stroke “/L.”

Assuming you have only one Address Book record that begins with “Wi,” your companion inserts the full name “Williams” (and its associated information). If you have more than one name that begins with “Wi,” the Phone Lookup screen appears and highlights the first record that begins with “Wi.”

- **For selected text:** Drag to highlight the text, and then write the Phone Lookup Command stroke “/L.” Your companion replaces the selected text and adds the name and its associated information.

Looking up names to add to expense records

In Expense, Lookup displays the names in your Address Book that have data in the Company field. You can add these names to a list of attendees associated with an Expense record.

To add names to an Expense record:

1. Tap the Expense record to which you want to add names.
2. Tap Details.



The image shows a dialog box titled "Receipt Details" with a black header. It contains several fields with dropdown menus and text input fields. The fields are: "Category:" with a dropdown set to "Unfiled"; "Type:" with a dropdown set to "Lunch"; "Payment:" with a dropdown set to "Unfiled"; "Currency:" with a dropdown set to "\$"; "Vendor:" followed by a dotted line for text input; "City:" followed by a dotted line for text input; and "Attendees:" followed by a dotted line and a small box containing "Who...". At the bottom, there are four buttons: "OK", "Cancel", "Delete", and "Note", followed by a small upward-pointing arrow icon.

3. Tap Who.

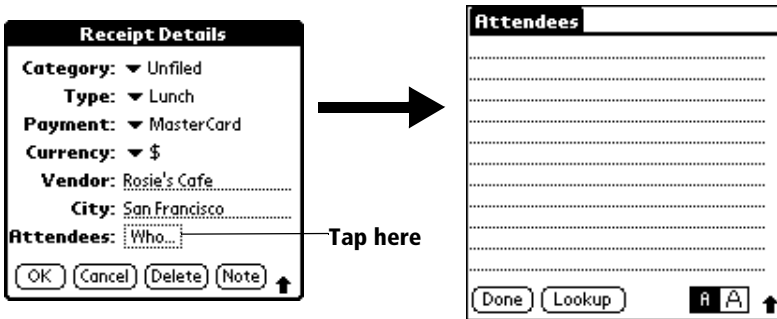

4. Tap Lookup.

The Attendees Lookup screen displays all the names in your Address Book that have data in the Company field.

5. Select the name you want to add, and then tap Add.

The name appears in the Attendees screen.

6. Repeat steps 4 and 5 to add more names.
7. Tap Done.
8. Tap OK.

Sorting lists of records

You can sort lists of records in various ways, depending on the application. Sorting is available in applications that have List screens: Address Book, To Do List, Memo Pad, and Expense.

Note: You can also assign records to categories. See “Categorizing records” earlier in this chapter.

To sort records in To Do List and Expense:

1. Open the application to display the List screen.
2. Tap Show.
3. Tap the Sort by pick list and select an option.
4. Tap OK.

To sort records in Address Book and Memo Pad:

1. Open the application to display the List screen.
2. Tap the Menu icon .

3. Tap Options, and then tap Preferences.

Address Book:



Memo Pad:

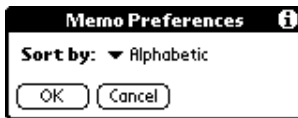

4. Do one of the following:

Address Book: Tap the setting you want.

Memo Pad: Tap the Sort by pick list and select Alphabetic or Manual.

5. Tap OK.

To sort the Memo List manually, tap and drag a memo to a new location in the list.

Note: To make the list of your memos appear in Palm Desktop for IBM WorkPad as you manually sorted it on your companion, open Memo Pad in Palm Desktop for IBM WorkPad and click List by. Then select Order on handheld.

Making records private

In all basic applications except Expense, you can make individual records private. Private records remain visible and accessible, however, until you select the Security setting to hide all private records. See “Security” in Chapter 3 for more information.

Hiding private records

You can hide records that you mark as private. If you define a password for your companion, you must enter it to display private records.

To hide private records:

1. Tap the Applications icon .
2. Tap Security.
3. Tap Hide.

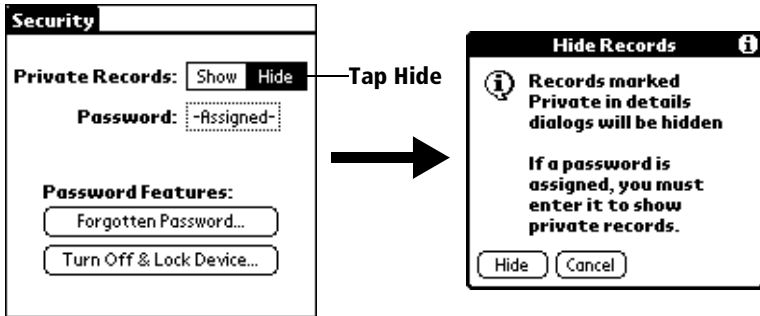

4. Tap Hide to confirm that you want to hide private records.

To display private records:

1. Tap the Applications icon .
2. Tap Security.
3. Tap Show.

If you do not have a password, hidden records become visible.

If you have a password, the Show Private Records dialog box appears. Go to step 4.

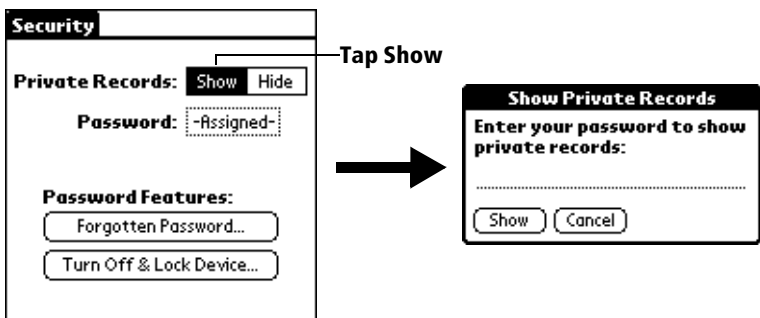

4. Enter your password, and then tap Show.

To make a record private:

1. Display the entry that you want to make private.
2. Tap Details.
3. Tap the Private check box to select it.
4. Tap OK.

Attaching notes

In all basic applications except Memo Pad, you can attach a note to a record. A note can be up to several thousand characters long. For example, for an appointment in Date Book, you can attach a note with directions to the location.

To attach a note to a record:

1. Display the entry to which you want to add a note.
2. In Address Book only: Tap Edit.
3. Tap Details.
4. Tap Note.
5. Enter your note.
6. Tap Done.

A small note icon appears at the right side of any item that has a note.

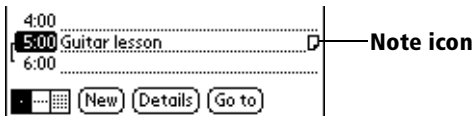

To review or edit a note:

1. Tap the Note icon .

To delete a note:

1. Tap the Note icon .
2. Tap Delete.
3. Tap Yes.

Choosing fonts

In all basic applications except Expense, you can change the font style to make text easier to read. You can choose a different font style for each application.

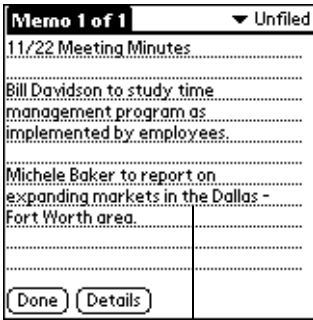

Small font



Large font

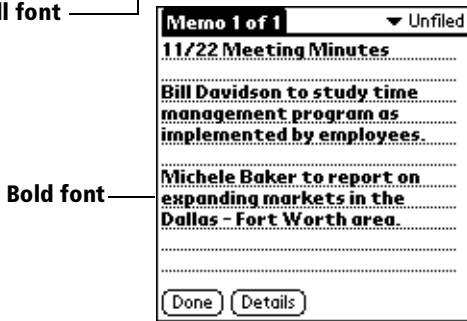

Bold font

To change the font style:

1. Open an application.
2. Tap the Menu icon .
3. Tap Options, and then tap Font.
4. Tap the font style you want to use.

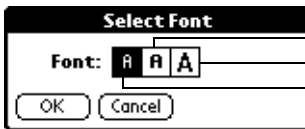

Tap here for bold font

Tap here for large font

Tap here for small font

5. Tap OK.

Application-specific tasks

Date Book

When you open Date Book, the screen shows the current date and a list of times for a normal business day.

Scheduling an event

A record in Date Book is called an “event.” An event can be any kind of activity that you associate with a day. You can enter a new event on any of the available time lines.

When you schedule an event, its description appears on the time line, and its duration is automatically set to one hour. You can easily change the start time and duration for any event.

Note: It is possible to schedule events that overlap, but Date Book makes it easy to find such conflicts. See “Spotting event conflicts” later in this chapter.

You can also schedule events in your Date Book that occur on a particular date but have no specific start or end times, such as birthdays, holidays, and anniversaries. These are referred to as “untimed events.” Untimed events appear at the top of the list of times, marked with a diamond. You can have more than one untimed event on a particular date.

You can also schedule a repeating event, such as a weekly meeting, and continuous events, such as a three-day conference or a vacation.

To schedule an event for the current day:

1. Tap the time line that corresponds to the beginning of the event.

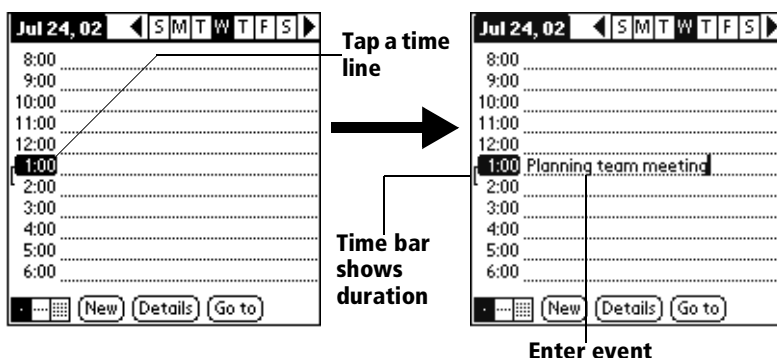

2. Enter a description of the event. You can enter up to 255 characters.
3. If the event is one hour long, skip to step 7. If the event is longer or shorter than an hour, tap the time of the event to open the Set Time dialog box.

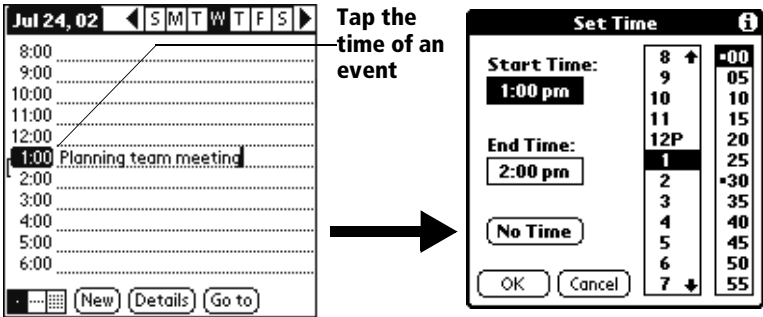

Tip: You can also open the Set Time dialog (to select a start time) by making sure no event is selected, and then writing a number on the number side of the Graffiti writing area.

4. Tap the time columns on the right side of the Set Time dialog to set the Start Time.

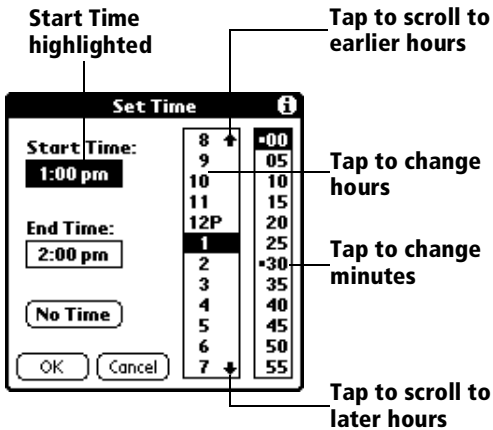

5. Tap the End Time box, and then tap the time columns to set the End Time.
6. Tap OK.
7. Tap a blank area of the screen to deselect the event. A vertical line appears next to the time, indicating the duration of the event.

To schedule an event for another day:

1. Select the date you want for the event by doing one of the following:
 - Tap the day of the week that you want in the date bar at the top of the screen. If necessary, tap the Previous week or Next week scroll arrows to move to another week.

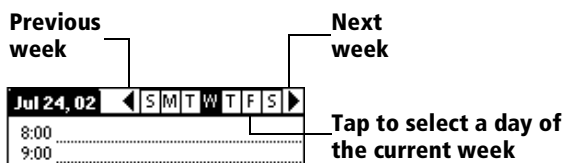

Tip: You can also use the scroll button on the front panel of your companion to move forward or backward one day at a time.

- Tap Go To at the bottom of the screen to open the Go to Date dialog box. Select a date by tapping a year, month, and day in the calendar.

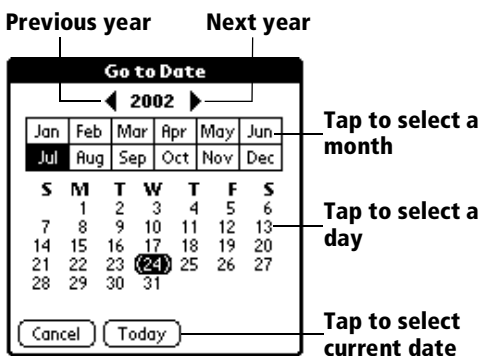

Tip: In the Go to Date dialog box, you can also use the scroll button on the front panel of the companion to move forward or backward one month at a time.

2. After you locate the date, follow the steps for scheduling an event for the current day.

To schedule an untimed event:

1. Select the date that you want for the event as described in "To schedule an event for another day."
2. Tap New.
3. Tap OK, so that no start or end times are defined for the new event.

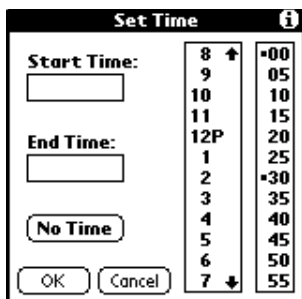

Tip: You can also create a new untimed event by making sure no event is selected and then writing letters in the Graffiti writing area.

4. Enter a description of the event.

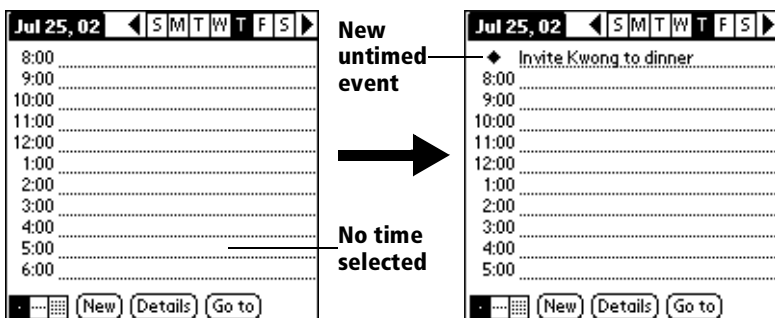

5. Tap a blank area on the screen to deselect the untimed event.

Note: If you create an event and decide later that there is no particular start or end time, you can easily change it to an untimed event. Tap the time of the event in the Date Book screen, tap No Time, and then tap OK.

Rescheduling an event

You can easily make changes to your schedule with your companion.

To reschedule an event:

1. Tap the event you want to reschedule.
2. Tap Details.
3. To change the time, tap the Time box and select a new time.
4. To change the date, tap the Date box and select a new date.
5. Tap OK.

Setting an alarm for an event

The Alarm setting enables you to set an audible alarm for events in your Date Book. You can set an alarm to sound minutes, hours, or days before an event. The default Alarm setting is 5 minutes before the time of the event, but you can change this to any number of minutes, hours, or days.

When you set an alarm, this icon  appears to the far right of the event with the alarm. When the alarm tone sounds, a reminder message also appears onscreen.

To set an alarm for an event:

1. Tap the event to which you want to assign an alarm.
2. Tap Details.
3. Tap the Alarm check box to select it.

The default setting, 5 Minutes, appears.

4. Tap the pick list to select Minutes, Hours, or Days.
5. Select the 5 and enter any number from 0 to 99 (inclusive) as the number of time units.

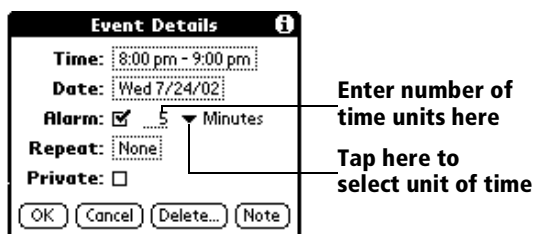

6. Tap OK.

Alarm for untimed events: You can set a silent alarm for an untimed event. In this case, the alarm triggers at the specified period of minutes, hours, or days before midnight (beginning) of the day of the untimed event. No audible alarm sounds for an untimed event; instead, the reminder message appears onscreen.

For example, you set an alarm for an untimed event that occurs on February 4th. If the alarm is set for 5 minutes, the reminder message appears at 11:55 PM on the night of February 3rd. The reminder remains onscreen until you turn on your companion and tap OK to dismiss it.

Scheduling repeating or continuous events

The Repeat function lets you schedule events that recur at regular intervals or extend over a period of consecutive days.

A birthday is a good example of an event that repeats annually. Another example is a weekly guitar lesson that falls on the same day of the week and the same time of day.

A business trip or a vacation is an example of a continuous event.

To schedule a repeating or continuous event:

1. Tap the event.

Typically, a continuous event is an untimed event.

2. Tap Details.
3. Tap the Repeat box to open the Change Repeat dialog box.

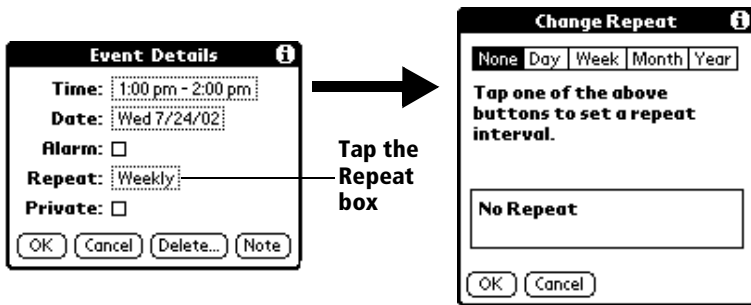

4. Tap Day, Week, Month, or Year to set how often event repeats.

For a continuous event, tap Day.

5. Enter a number that corresponds to how often you want the event to repeat on the Every line.

For example, if you select Month and enter the number 2, the event repeats every other month.

6. To specify an end date for the repeating or continuous event, tap the End on pick list and tap Choose Date. Use the date picker to select an end date.
7. Tap OK.

After you schedule a repeating or continuous event, this icon  appears to the far right of the event.

Considerations for repeating or continuous events: Keep the following points in mind.

- If you change the start date of a repeating event, your companion calculates the number of days you moved the event. Your companion then automatically changes the end date to maintain the duration of the repeating event.
- If you change the repeat interval (e.g., daily to weekly) of a repeating event, past occurrences (prior to the day on which you change the setting) are not changed, and your companion creates a new repeating event.
- If you change the date of an occurrence of a repeating event (e.g., from January 14th to January 15th) and apply the change to all occurrences, the new date becomes the start date of the repeating event. Your companion adjusts the end date to maintain the duration of the event.
- If you change other repeat settings (e.g., time, alarm, private) of a repeating event and apply the change to all occurrences, your companion creates a new event. The start date of this new event is the day on which the setting is changed. Past occurrences (prior to the day of the change) are not changed.
- If you apply a change to a single occurrence of a repeating event (e.g., time), that occurrence no longer shows the Repeat icon .

Changing the Date Book view

In addition to displaying the time list for a specific day, you can also display a whole week or month. You can also display the current time.

To cycle through Day, Week, and Month views:

- Press the Date Book application button repeatedly to display the next view.

To display the current time:

- Tap the date in the date bar to display the current time. After a few seconds, the date reappears.

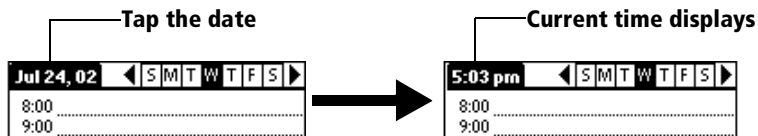

Working in Week View: Week View shows the calendar of your events for an entire week. This view lets you quickly review your appointments and available time slots. In addition, the graphical display helps you spot overlaps and conflicts in your schedule.

To display the Week View:

1. Tap the Week View button.



2. Tap the navigation controls to move forward or backward a week at a time, or to display details of an event.

Note: The Week View also shows untimed events and events that are before and after the range of times shown.

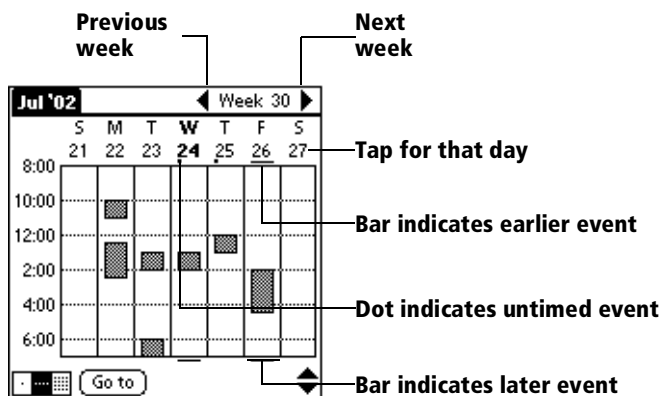

3. Tap an event to show a description of the event.

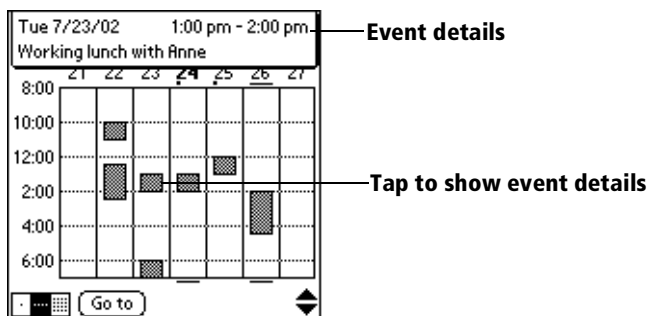

Tips for using Week View: Keep the following points in mind.

- To reschedule an event, tap and drag the event to a different time or day.
- Tap a blank time on any day to move to that day and have the time selected for a new event.
- Tap any day or date that appears at the top of the Week View to move directly to that day without selecting an event.
- The Week View shows the time span defined by the Start Time and End Time in the Date Book Preferences settings. If you have an event before or after this time span, a bar appears at the top or bottom of that day's column. Use the onscreen scroll arrows  to scroll to the event.

Spotting event conflicts

With the ability to define specific start and end times for any event, it is possible to schedule events that overlap (an event that starts before a previous event finishes).

An event conflict (time overlap) appears in the Week View as overlapping bars. The Day View displays overlapping brackets to the left of the conflicting times.

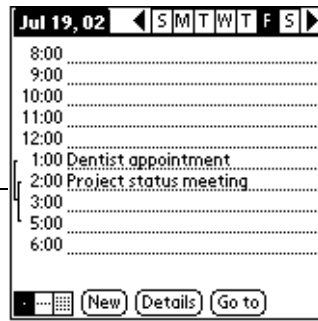
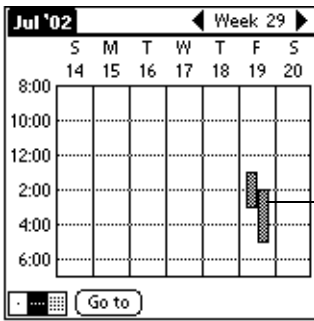

Working in Month View

The Month View screen shows which days have events scheduled. Dots and lines in the Month View indicate events, repeating events, and untimed events.



Previous/next month

Dashed line indicates continuous event

Dots on right side indicate events

Dots below date indicate untimed events

Month View button

You can control the dots and lines that appear in the Month View. See “Options menu” later in this chapter.

Tips for using Month View: Keep the following points in mind.

- Tap a day in the Month View to display that day in the Day View.
- Tap the scroll arrows in the upper-right corner to move forward or backward a month.
- Tap Go to to open the date selector and select a different month.
- Use the scroll button on the front panel of your companion to move between months. Press the upper half of the button to display the previous month, the lower half to display the next month.

Date Book menus, preferences, and display options

Date Book menus are shown here for your reference, and Date Book features that are not explained elsewhere in this book are described here.

See “Using menus” in Chapter 1 for information about choosing menu commands.

Record menu

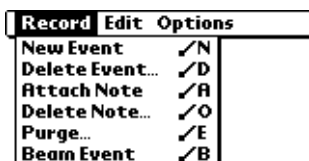

Options menu



Display Options Allows you to change Date Book's appearance and which events display.



- **Show Time Bars.** Activates the time bars that appear in the Day View. The time bars show the duration of an event and illustrate event conflicts.
- **Compress Day View.** Controls how times appear in the Day View. When Compress Day View is off, all time slots display. When it is on, start and end times display for each event, but blank time slots toward the bottom of the screen disappear to minimize scrolling.
- **Month View settings.** These check boxes apply to the Month View of the Date Book. You can activate any or all of these settings to show that you have Timed, Untimed, or Daily Repeating events in the Month View *only*.

Preferences



- **Start/End Time.** Defines the start and end times for Date Book screens. If the time slots you select do not fit on one screen, you can tap the scroll arrows  to scroll up and down.
- **Alarm Preset.** Automatically sets an alarm for each new event. The silent alarm for untimed events is defined by minutes, days, or hours before midnight of the date of the event.
- **Alarm Sound.** Sets the tone of the alarm.
- **Remind Me.** Defines how many times the alarm sounds. The choices are Once, Twice, 3 Times, 5 Times, and 10 Times.
- **Play Every.** Defines how often the alarm sounds. The choices are Minute, 5 minutes, 10 minutes, and 30 minutes.

About Date Book

Shows version information for Date Book.

Address Book

Address Book is the application in which you store name and address information about people or businesses.

Creating an Address Book entry

A record in Address Book is called an “entry.” You can create entries on your companion, or you can use Palm Desktop for IBM WorkPad to create entries on your computer and then download the entries to your companion with your next HotSync operation.

Palm Desktop for IBM WorkPad also has data import capabilities that enable you to load database files into Address Book on your companion.

See “Importing data” in Chapter 2 and Palm Desktop online Help for more information.

To create a new Address Book entry:

1. Press the Address Book application button  on the front of your companion to display the Address List.
2. Tap New.

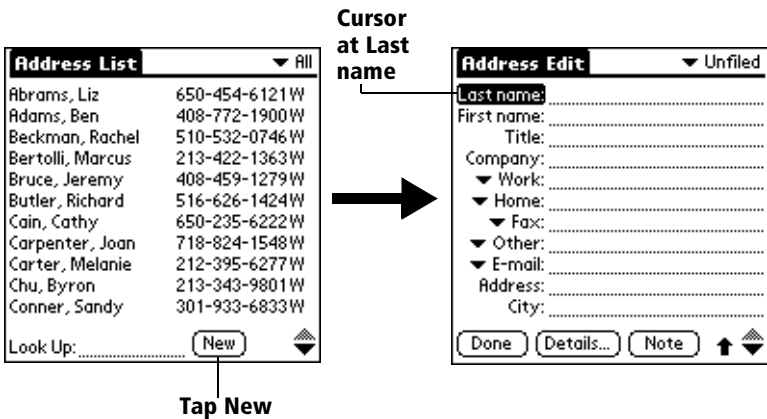

3. Enter the last name of the person you want to add to your Address Book.

Note: The companion automatically capitalizes the first letter of each field (except numeric and e-mail fields). You do not have to use the Graffiti capital stroke to capitalize the first letter of the name.

4. Use the Next Field Graffiti stroke to move to the First Name field.



Tip: You can also move to any field by tapping it directly.

5. Enter the person's first name in the First Name field.
6. Enter the other information that you want to include in this entry.
7. Tap the scroll arrows  to move to the next page of information.
8. After you finish entering information, tap Done.

Tap Done

Tip: To create an entry that always appears at the top of the Address List, begin the Last name or Company field with a symbol, as in *If Found Call*. This entry can contain contact information in case you lose your companion.

Selecting types of phone numbers

You can select the types of phone numbers or e-mail addresses that you associate with an Address Book entry. Any changes you make apply only to the current entry.

To select other types of phone numbers in an entry:

1. Tap the entry that you want to change.
2. Tap Edit.

3. Tap the pick list next to the label you want to change.

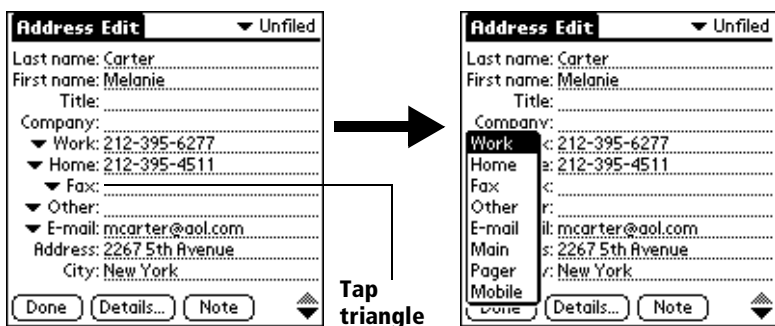

4. Select a new label.

Changing Address Entry details

The Address Entry Details dialog box provides a variety of options that you can associate with an entry.

To open the Address Entry Details dialog box:

1. Tap the entry whose details you want to change.
2. Tap Edit.
3. Tap Details.



4. Select any of the following settings:

Show in List Select which type of phone or other information appears in the Address List screen. Your options are Work, Home, Fax, Other, and E-mail.

Category Assign the entry to a category.

Private Hide this entry when Security is turned on.

Address Book menus

Address Book menus are shown here for your reference, and Address Book features that are not explained elsewhere in this book are described here.

See “Using menus” in Chapter 1 for information about choosing menu commands.

The Record and Options menus differ depending on whether you are displaying the Address List screen or the Address View screen.

Record menus

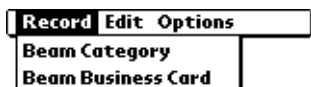

Address List

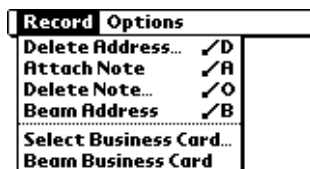

Address View

Options menus



Address List



Address View

Preferences

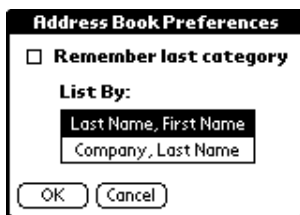

- **Remember last category.** Determines how Address Book appears when you return to it from another application. If you select this check box, Address Book shows the last category you selected. If you clear it, Address Book displays the All category.

Rename Custom Fields

These custom fields appear at the end of the Address Edit screen. Rename them to identify the kind of information you enter in them. The names you give the custom fields appear in all entries.

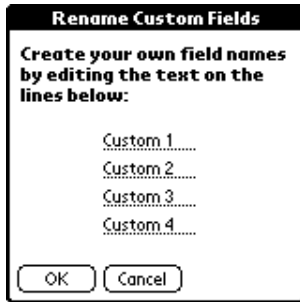

About Address Book

Shows version information for Address Book.

To Do List

A To Do List item is a reminder of some task that you have to complete. A record in To Do List is called an “item.”

To create a To Do List item:

1. Press the To Do List application button  on the front of your companion to display the To Do List.
2. Tap New.

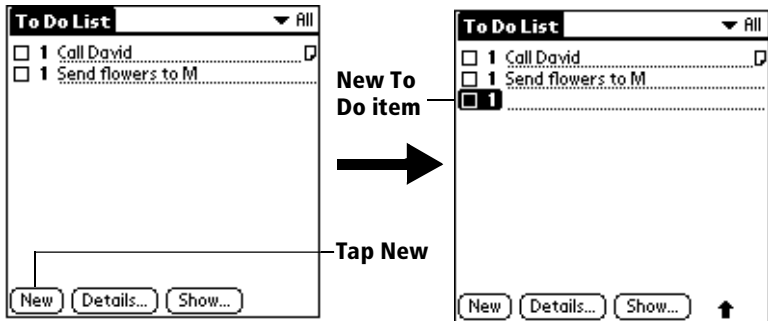

3. Enter the text of the To Do List item. The text can be longer than one line.
4. Tap anywhere onscreen to deselect the To Do List item.

Tip: If no To Do List item is currently selected, writing in the Graffiti writing area automatically creates a new item.

Setting priority

The priority setting for items lets you arrange the tasks in your To Do List according to their importance or urgency. The default setting for the To Do List is to arrange items by priority and due date, with priority 1 items at the top. If you have a number of items in your list, changing an item’s priority setting may move its position in the list.

Note: When you create a new To Do List item, its priority is automatically set to level 1, the highest (most important) level. If you select another item first, however, the item you create appears beneath the selected item and is given the same priority as the selected item.

To set the priority of a To Do List item:

1. Tap the Priority number on the left side of the To Do List item.

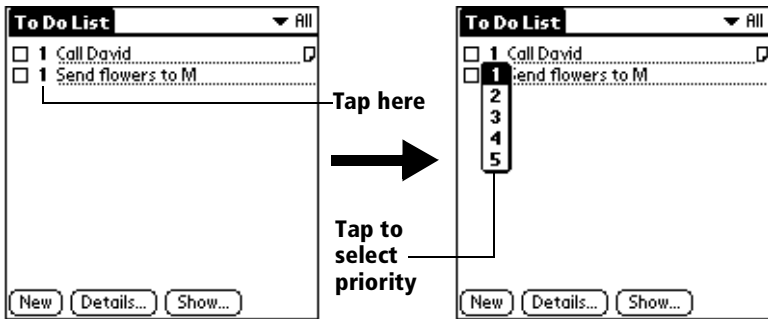

2. Tap the Priority number that you want to set (1 is most important).

Checking off a To Do List item

You can check off a To Do List item to indicate that you have completed it. You can set the To Do List to record the date that you complete the To Do List item, and you can choose to show or hide completed items. See “To Do Show Options” later in this chapter.

To check off a To Do List item:

- Tap the check box on the left side of the item.

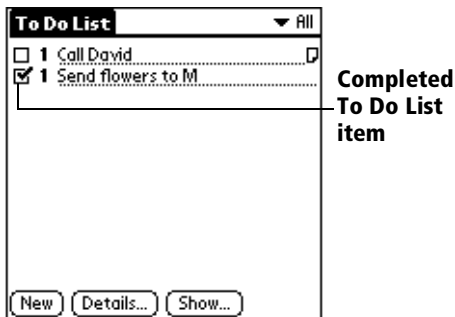

Changing To Do List item details

The To Do Item Details dialog box enables you to change settings for individual items.

To display the To Do Item Details dialog box:

1. Tap the text of the item whose details you want to change.
2. Tap Details.



Setting a due date

You can associate a due date with any To Do List item. You can also sort the items that appear in the list based on their due date.

To set a due date for a To Do List item:

1. In the Details dialog box, tap “No Date” to open the Due Date pick list.

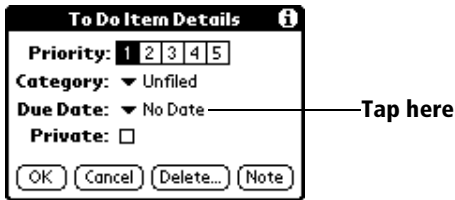

2. Tap the date that you want to assign the item:

Today	Assigns the current date.
Tomorrow	Assigns tomorrow’s date.
One week later	Assigns the date exactly one week from the current date.
No Date	Removes the due date from the item.
Choose date	Opens the date selector, where you can choose any date that you want for the item.

3. Tap OK.

Tip: If you turn on the Show Due Dates option in the To Do Show options dialog, you can tap directly on the due date in the To Do List to open the pick list shown in step 2.

To Do Show Options

The Show Options dialog box enables you to control the appearance of To Do List.

To change the Show Options settings:

1. In To Do List, tap Show.



2. Select any of the following settings:

Show Completed Items

Displays your completed items in the To Do List. If you turn off this setting, your To Do items disappear from the list when you complete (check) them.

Items that no longer appear on the list because you turn off this setting have not been deleted. They are still in the memory of your companion. Purge completed items to remove them from memory.

Show Only Due Items

Shows only the items that are currently due, past due, or have no due date specified. When this setting is active, items that are not yet due do not appear in the list until their due date.

Record Completion Date

Replaces the due date with the actual date when you complete (check) the item. If you do not assign a due date to an item, the completion date still records when you complete the item.

Show Due Dates Displays the due dates associated with items in the To Do List and displays an exclamation mark next to items that remain incomplete after the due date passes.

Show Priorities Shows the priority setting for each item.

Show Categories Shows the category for each item.

3. Tap OK.

To Do List menus

To Do List menus are shown here for your reference, and To Do List features that are not explained elsewhere in this book are described here.

See “Using menus” in Chapter 1 for information about choosing menu commands.

Record menu



Options menu



About To Do List Shows version information for To Do List.

Memo Pad

A memo can contain up to 4,000 characters. The number of memos you can store is dependent only on the memory available on your companion. A record in Memo Pad is called a “memo.”

To create a new memo:

1. Press the Memo Pad application button  on the front of your companion to display the Memo List.
2. Tap New.

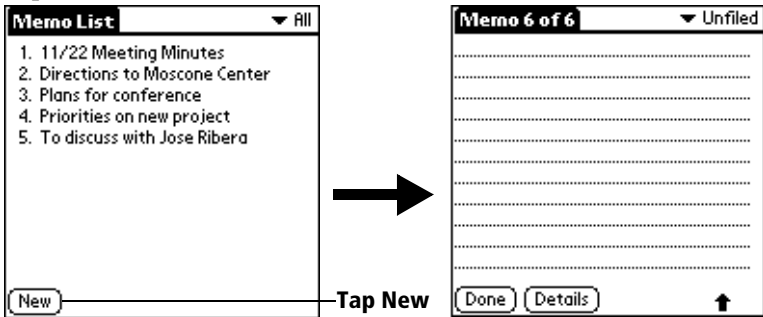

Tip: In the Memo List screen, you can also begin writing in the Graffiti writing area to create a new memo. The first letter is automatically capitalized and begins your new memo.

3. Enter the text you want to appear in the memo. Use the carriage return stroke to move down to new lines in the memo.
4. Tap Done.

Reviewing memos

The first line of a memo appears in the Memo List. This makes it easy to locate and review your memos.

To review a memo:

1. In the Memo List, tap the text of the memo.

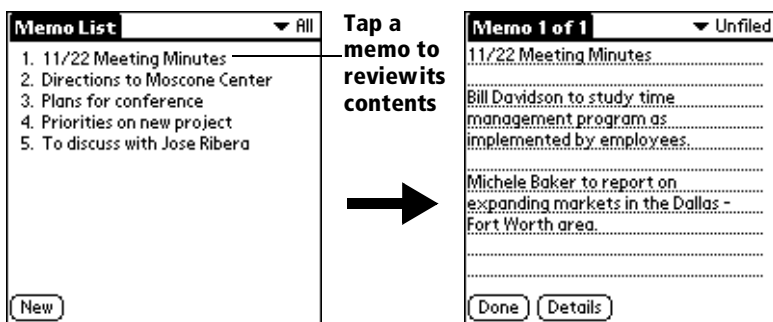

2. Review or edit the text in the memo.
3. Tap Done.

Memo Pad menus

Memo Pad menus are shown here for your reference, and Memo Pad features that are not explained elsewhere in this book are described here.

See "Using menus" in Chapter 1 for information about choosing menu commands.

The Record and Options menus differ depending on whether you are displaying the Memo List or an individual memo.

Record menus

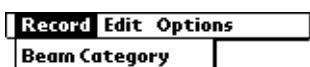

Memo List

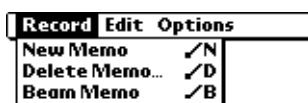

Memo screen

Options menus

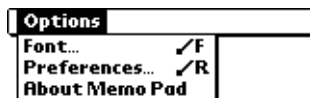

Memo List



Memo screen

Go to Top of Page	Moves to the top (first) line of the memo.
Go to Bottom of Page	Moves to the bottom (last) line of the memo.
Preferences	Displays the Memo Preferences dialog box, where you define the sort order for memos.
About Memo Pad	Shows version information for Memo Pad.

Calculator

The Calculator includes several buttons to help you perform calculations.



Clears the last number you entered. Use this button if you make a mistake while entering a number in the middle of a calculation. This button enables you to re-enter the number without starting the calculation over.



Clears the entire calculation and enables you to begin a fresh calculation.



Toggles the current number between a negative and positive value. If you want to enter a negative number, enter the number first *and then press* the +/- button.



Places the current number in memory. Each new number you enter with the M+ button is *added to the total* already stored in memory. The number that you add can be either a calculated value or any number you enter by pressing the number buttons. Pressing this button has no effect on the current calculation (or series of calculations); it merely places the value into memory until it is recalled.



Recalls the stored value from memory and inserts it in the current calculation.



Clears any value that is stored in the Calculator memory.

Recent Calculations

The Recent Calculations command enables you to review the last series of calculations and is particularly useful for confirming a series of “chain” calculations.

To display recent calculations:

1. Tap the Menu icon .
2. Tap Options, and then tap Recent Calculations.

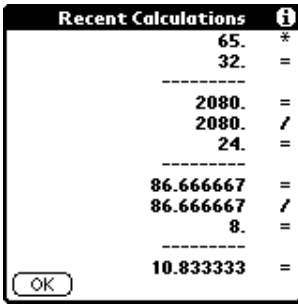

3. After you finish reviewing the calculations, tap OK.

Calculator menus

Calculator menus are shown here for your reference, and Calculator features that are not explained elsewhere in this book are described here.

See “Using menus” in Chapter 1 for information about choosing menu commands.

Options menus

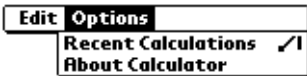

About

Shows version information for Calculator.

Calculator

Expense

Expense enables you to record the date, expense type, and the amount that you spent. A record in Expense is called an “item.” You can sort your Expense items into categories or add other information that you want to associate with the item.

To create an Expense item:

1. Tap the Applications icon .
2. Tap Expense.
3. Tap New.

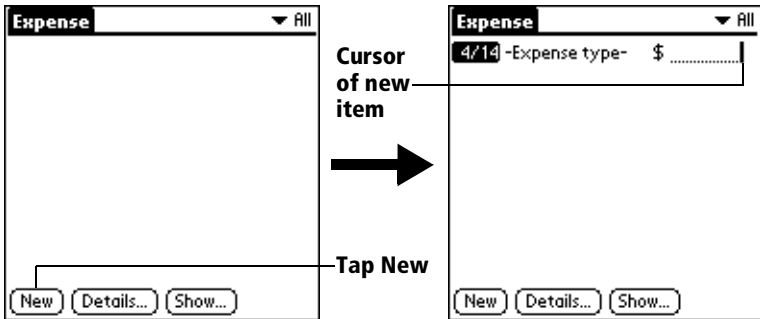

Tip: You can also create a new Expense item by writing on the number side of the Graffiti writing area while in the Expense List screen. The first number you write begins your new Expense item.

4. Enter the amount of the expense.
5. Tap the Expense type pick list and select a type from the list.

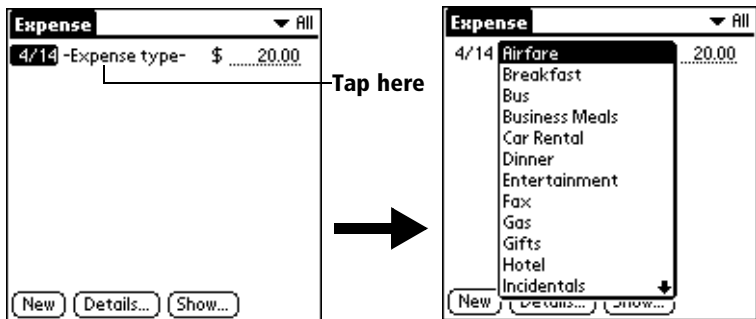

Note: As soon as you select an expense type, your companion saves your entry. If you do not select an expense type, it does not save the entry.

Tip: A quick way to create a new Expense item is to make sure that no Expense item is selected in the Expense List, write the first letter(s) of the expense type, and then write the numerical amount of the Expense item. This technique takes advantage of the automatic fill feature. See “Options menu” later in this chapter for details.

Changing the date of an Expense item

Initially, Expense items appear with the date you enter them. You can use Expense to change the date associated with any Expense item.

To change the date of an Expense item:

1. Tap the Expense item you want to change.
2. Tap the date of the selected item.

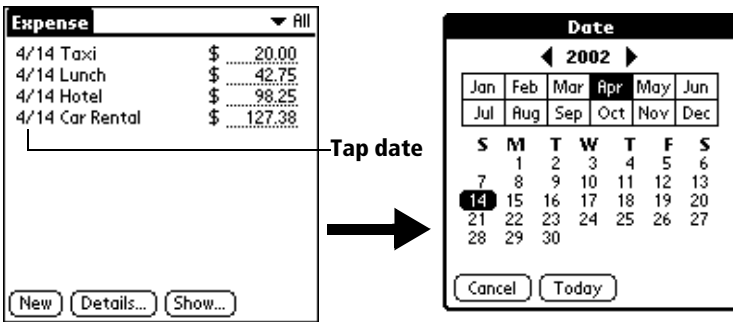

3. Tap the new date.

Entering receipt details

Expense provides a variety of options that you can associate with an item. These options appear in the Receipt Details dialog box.

To open the Receipt Details dialog box:

1. Tap the Expense item to which you want to assign details.
2. Tap Details.

The screenshot shows the Receipt Details dialog box with the following fields and values:

- Category:** ▼ Unfiled
- Type:** ▼ Lunch
- Payment:** ▼ Unfiled
- Currency:** ▼ \$
- Vendor:**
- City:**
- Attendees:** Who...

Buttons at the bottom: OK, Cancel, Delete, Note, and an upward arrow.

3. Select any of the following options:

Category	See “Categorizing records” earlier in this chapter.
Type	Opens a pick list of expense types.
Payment	Lets you choose the payment method used to pay the Expense item. If the item is prepaid (such as airline tickets supplied by your company), you can choose Prepaid to place your expense in the appropriate company-paid cell of your printed expense report spreadsheet. See “Transferring your data to Microsoft Excel” later in this chapter for more information.
Currency	Enables you to choose the type of currency used to pay the Expense item. The default currency unit is defined in the Preferences dialog (see See “Options menu” later in this chapter). You can also display up to four other common types of currency. See “Customizing the Currency pick list” later in this chapter for more information.
Vendor and City	Lets you record the name of the vendor (usually a company) associated with the expense and the city where the expense was incurred. For example, a business lunch might be at Rosie's Cafe (Vendor) in San Francisco (City).
Attendees	See “Looking up names to add to expense records” earlier in this chapter.

4. Tap OK.

Customizing the Currency pick list

You can select the currencies and symbols that appear in the Currency pick list.

To customize the Currency pick list:

1. Tap the Currency pick list in the Receipt Details dialog box, and then select Edit currencies.

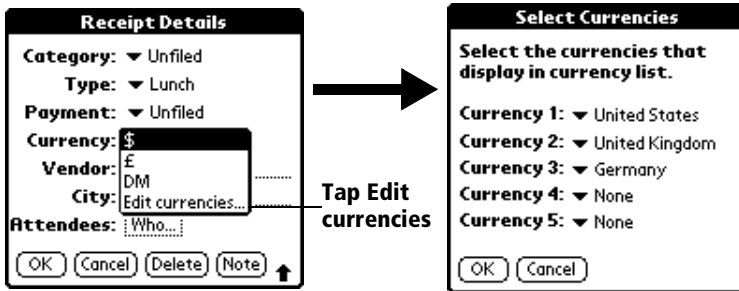

2. Tap each Currency pick list and select the country whose currency you want to display on that line.
3. Tap OK to close the Select Currencies dialog box.
4. Tap OK.

Defining a custom currency symbol

If the currency you want to use is not in the list of countries, you can create your own custom country and currency symbol.

To define a custom currency symbol:

1. Tap the Menu icon .
2. Tap Options, and then tap Custom Currencies.
3. Tap one of the four Country boxes.

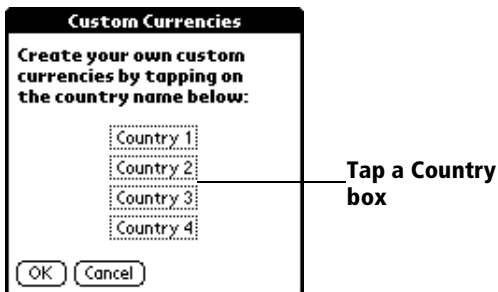

4. Enter the name of the country and the symbol that you want to appear in Expense.



5. Tap OK to close the Currency Properties dialog box.
6. Tap OK.

Note: If you want to use your custom currency symbol as the default for all Expense items, select the symbol in the Preferences dialog box. If you want to use your custom currency symbol only for a particular Expense item, select the symbol in the Receipt Details dialog box associated with that item.

Show Options

Show Options define the sort order and other settings that relate to your Expense items.

To open the Show Options dialog box:

1. In the Expense List, tap Show.
2. Select any of the options.

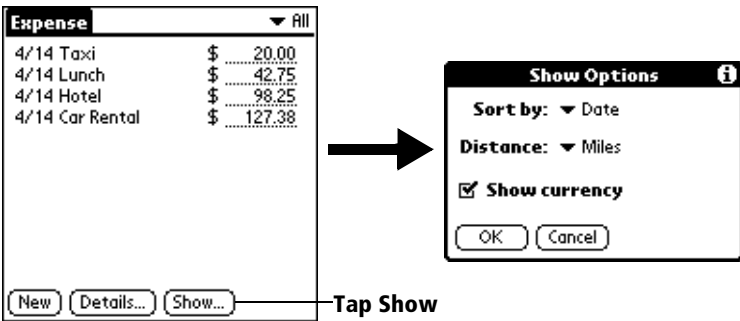

Sort by

Enables you to sort expense items by date or type.

Distance

Enables you to display Mileage entries in miles or kilometers.

Show currency

Shows or hides the currency symbol in the Expense List.

3. Tap OK.

Transferring your data to Microsoft Excel

After you enter your expenses into the Expense application on your companion, Palm Desktop for IBM WorkPad enables you to view and print the data with your computer.

Note: You need Microsoft Excel version 5.0 (or later) to view and print your Expense data using one of the provided templates. Microsoft Excel is *not* included with the WorkPad c3 companion package. The procedures in this section also assume that you have installed Palm Desktop for IBM WorkPad. See “Palm Desktop software for IBM WorkPad” in Chapter 1 for more information.

Creating or printing an expense report

Palm Desktop for IBM WorkPad makes it quick and easy to view and print your Expense data in a Microsoft Excel spreadsheet.

To create or print an expense report:

1. Perform a HotSync operation to transfer your latest Expense data to your computer.
2. Click Expense in Palm Desktop for IBM WorkPad to open Microsoft Excel and the Expense Report configuration dialog box.

Note: If you launch Expense from the Start menu instead of Palm Desktop for IBM WorkPad, you must first choose your companion user name.

3. Click the expense category that you want.

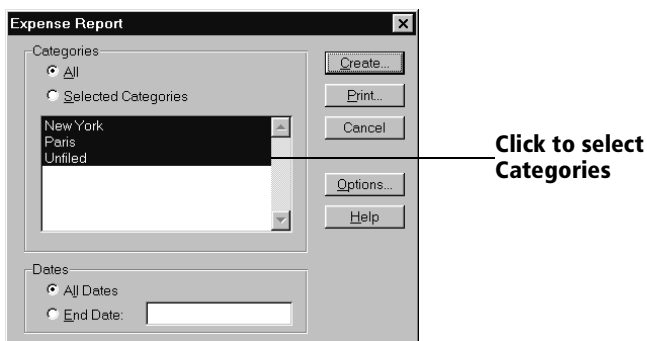

Tip: You can press Ctrl+click to select multiple categories. To print the expenses associated with all of your Expense categories, select All in the Categories group.

4. If you want to define an end date for the expense report, enter the date in the End Date box.

Note: If you do not specify an end date, all expense entries for the selected categories appear — up to the date of the last HotSync operation.

5. Do one of the following:

Click Print to display the expense report in the Print Preview window, and then click Print in the Microsoft Excel window to print your expense report.

Click Create to display a Microsoft Excel spreadsheet containing your expense data. Your data appears in Microsoft Excel spreadsheet form. You can enter information, make formatting changes, and save and print the file in the normal manner.

Using expense report templates

Palm Desktop for IBM WorkPad includes several expense report templates. When you use one of these templates, you can edit your expense data in Microsoft Excel.

The templates have the extension .xlt and are stored in the template folder in the Palm Desktop for IBM WorkPad directory on your computer. To see what a template looks like before you use it, open the template in Microsoft Excel. For example, the template Sample2.xlt looks like this:

Sample2.xlt

	1	2	3	4	6	8	10	12	14	16	18	20	22	24	25
1	Travel Expense Report														
2	Expense type	Expense number	Expense date	Date											
3	2/3/98														
4	Travel														
5	Date:														
6	Bill to:														
7	TOTAL														
8	TOTAL														
9	TOTAL														
10	TOTAL														
11	LODGING														
12	Lodging & Hotel														
13	Laundry														
14	Tips														
15	Lodging total														
16	MEALS														
17	Breakfast														
18	Lunch & Snacks														
19	Dinner														
20	Meals total														
21	BUSINESS														
22	Business meals														
23	Conference														
24	Entertainment														
25	Business total														
26	TRANSPORTATION														
27	Airfare														
28	Auto Rental														
29	Auto Maint./Gas														
30	Local Transportation														
31	Tolls/Parking														
32	Miles @ \$\$\$\$ / mile														
33	Trans. total														
34	MISCELLANEOUS														
35	Gifts														
36	Telephone & Fax														
37	Supplies														
38	Postage														
39	Other														
40	Misc. total														
41	TOTAL														
42	Less cash advance														
43	Due employee														
44	Due company														
45	Expense equalizer														
46	Expense equalizer														
47	Expense equalizer														
48	Expense equalizer														
49	Expense equalizer														
50	Expense equalizer														
51	Expense equalizer														
52	Expense equalizer														
53	Expense equalizer														
54	Expense equalizer														
55	Expense equalizer														
56	Expense equalizer														
57	Expense equalizer														
58	Expense equalizer														
59	Expense equalizer														
60	Expense equalizer														
61	Expense equalizer														
62	Expense equalizer														
63	Expense equalizer														
64	Expense equalizer														
65	Expense equalizer														

If you want to streamline or customize your expense reports, you can change these templates. For example, you can add your company name to a template. See Appendix C for information on changing templates.

To view your expense data using a Microsoft Excel template:

1. Display your expense data in a Microsoft Excel spreadsheet as described in the previous procedure.
2. Click Options.



The dialog box titled "Expense Report Options" contains the following fields and controls:

- Name: [Text Input]
- Department: [Text Input]
- Phone No.: [Text Input]
- Project: [Text Input]
- Bill To: [Text Input]
- Buttons: OK, Cancel, Help
- Template section: Select an Expense template from the list. Dropdown menu showing "SAMPLE1.XLT".
- Local Currency section: Select a country name from the list below or type in your local currency's country. Dropdown menu showing "United States".

Enter name and other information

Choose expense template

3. Enter name, department, and other information as necessary for your expense report.
4. Click the Templates menu; then select an expense template.

Note: If you want to create your own custom expense template and have it appear in the Templates menu, see Appendix C for more information.

5. Click OK.

Expense menus

Expense menus are shown here for your reference, and Expense features that are not explained elsewhere in this book are described here.

See "Using menus" in Chapter 1 for information about choosing menu commands.

Record menu

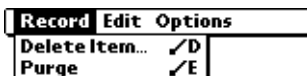

Options menu



Preferences

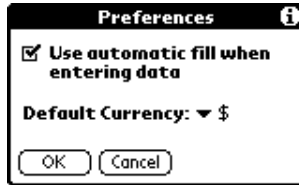

- **Use automatic fill.** Lets you select an expense type by writing the first letter of an expense type in the Graffiti writing area. For example, if you write the letter “T,” it enters the “Taxi” expense type. Writing “T” and then “E” enters “Telephone” which is the first expense type beginning with the letters “TE.”
- **Default currency.** Sets the default currency symbol for Expense.

About Expense Shows version information for Expense.

Chapter 5

Communicating Using Your Companion

The previous chapter described the features of your WorkPad c3 companion that help you stay organized. This chapter describes the features that help you stay connected.

- **Managing desktop E-Mail:** Using your companion, you can read, reply to, compose, and delete e-mail from your desktop E-Mail application while you are away from your desk.
- **IR beaming:** The infrared port located at the top of your companion lets you send data from your companion — including entire applications — to any other infrared-enabled WorkPad companion or other Palm Computing® platform device nearby.

Managing desktop E-Mail away from your desk



Mail lets you manage the e-mail that you send and receive through the E-Mail application on your desktop computer. You can read, reply to, compose, and delete e-mail on your companion; but to send or receive e-mail, you must perform a HotSync® operation either locally, using the companion cradle, or remotely, using a WorkPad c3 Modem.

The key to Mail is that it truly synchronizes the mail in the Inbox of your desktop E-Mail application with the mail on your companion. For example, if you delete e-mail items from Mail, your next HotSync operation also deletes the e-mail items from your desktop E-Mail application, so you never have to delete e-mail items twice. Similarly, if you read an e-mail item on your companion and leave it in your Inbox, your next HotSync operation marks it as read in your desktop E-Mail application.

In Mail, you can do the following:

- View, delete, file, and reply to incoming mail.
- Create outgoing e-mail items and drafts of e-mail items.
- Create simple or complex filters, which allow you to decide the type of e-mail that your companion retrieves from your desktop E-mail application.
- Use your companion in its cradle to send and retrieve e-mail items from your desktop E-Mail application.

Setting up Mail on the desktop

Before you use Mail for the first time, make sure your desktop E-Mail application is up and running. You must also set up Palm™ Desktop for IBM WorkPad for use with your desktop E-Mail application.

Your companion supports a number of desktop E-Mail applications, such as Microsoft Exchange (version 4.0 or higher), Eudora (version 3.0.3 or higher), and Lotus cc:Mail (versions 2.5, 6.0, and 7.0). You can see the full list of the supported applications when you set up Mail.

If your desktop E-Mail application does not appear on the list, you may still be able to manage your desktop E-Mail application from your companion by means of special connection software, called a conduit, that lets you synchronize your desktop E-Mail application and your companion. Contact the vendor of your E-Mail application or visit the web site <http://www.palm.com> for more information.

Note: The following instructions assume that you have already installed Palm Desktop for IBM WorkPad on your computer and that you did not set up Mail during the installation. If you have not yet installed the Palm Desktop for IBM WorkPad, the installation procedure prompts you to set up Mail as part of the Palm Desktop for IBM WorkPad installation.

To set up Mail:

1. Click Start in the Windows taskbar.
2. Highlight Programs, highlight Palm Desktop for IBM WorkPad, and then click Mail Setup to begin setup.
3. Follow the instructions onscreen to set up your companion for use with your desktop E-Mail application.

To select HotSync options:

1. Click the HotSync icon  in the Windows system tray (bottom-right corner of the taskbar).
2. Choose Custom.

Tip: You can also choose Custom from the HotSync menu in Palm Desktop for IBM WorkPad.

3. Select Mail in the list box.
4. Click Change.

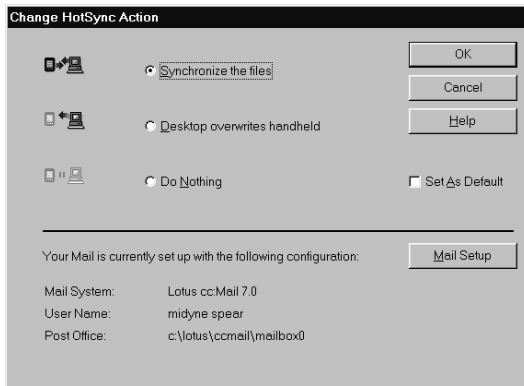

5. Click one of the following settings:

Synchronize the files

Synchronizes the mail on your companion and your desktop E-Mail application.

Desktop overwrites handheld

Replaces the mail on your companion with the mail in your desktop E-Mail application. You should use this option only if, for some reason, the two inboxes get out of sync. This setting applies for only one HotSync operation and then reverts back to the default setting.

Do Nothing

Turns off communication between your companion and desktop E-Mail application. This setting applies for only one HotSync operation and then reverts back to the default setting.

Set As Default

Changes the default setting on an ongoing basis. (When you first set up Mail, Synchronize the files is the default setting.)

Tip: To turn off Mail, select Do Nothing and then select the Set As Default check box.

To change your Mail setup options:

1. Click the HotSync icon  in the Windows system tray.
2. Choose Custom.

Tip: You can also choose Custom from the HotSync menu in Palm Desktop for IBM WorkPad.

3. Select Mail in the list box.
4. Click Change.
5. Modify your settings as needed.
6. Click OK.

Synchronizing Mail with your E-Mail application

After you enable and configure Mail, you need to perform a HotSync operation to synchronize Mail with your desktop E-Mail application. For a complete explanation of HotSync technology, see Chapter 6.

Opening the Mail application on your companion

To open Mail:

1. Tap the Applications icon .
2. Tap the Mail icon .

Viewing e-mail items

The Message List displays a list of your incoming e-mail, who sent them, and the date they were received. E-mail items you have read have a check next to them. High-priority e-mail items appear in bold.



Previously read

To open an e-mail item:

- Tap an e-mail item to open it.

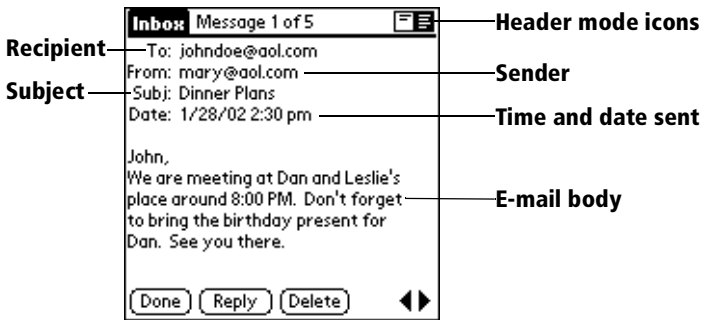

To close an e-mail item:

- Tap Done to close the e-mail item.

Displaying full header information

By default, Mail displays abbreviated header information, which comprises only the From: and Subj: fields. The full header provides complete information about the sender, receiver, and copied recipients, in addition to the subject and date the e-mail item was created. Mail uses the header type you select for all your e-mail items.

To display full header information:

1. Open an e-mail item.
2. Tap the Complete Header icon.

Tip: To redisplay the abbreviated header, tap the Abbreviated Header icon.

Creating e-mail items

You create e-mail items with your companion the same way you create e-mail with your desktop E-mail application: you identify the recipient(s) of the e-mail item, define a subject, and create the body of the e-mail item.

You create original e-mail items and replies in the New Message screen. All e-mail items must, at the very least, contain information in the To: and Subj: fields.

To create an e-mail item:

1. Tap New.

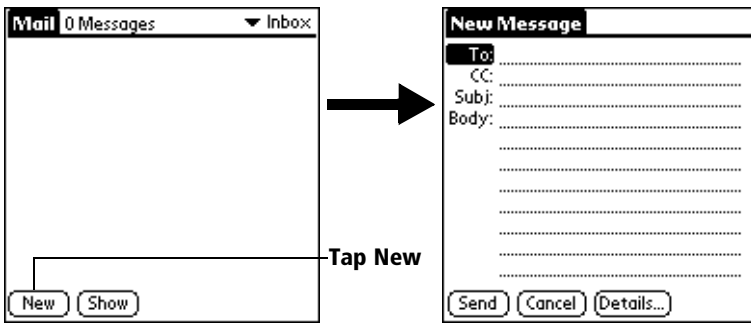

Tip: You can also create an e-mail item by tapping New from the Message menu.

2. Enter the e-mail address of the recipient.



Note: Enter the address as if you were entering it from your desktop E-Mail application. For example, network users sending an e-mail item to a user on the same network do not need to add Internet information, such as @mycorp.com.

3. To send a copy of this e-mail item to additional recipients, tap the CC: field, and then enter the e-mail addresses of the additional recipients, separating the addresses with a comma followed by a space.
4. Tap the Subj: field and enter a subject for your e-mail item.
5. Tap the Body: field and enter the text of your e-mail item.

Tip: If the address, CC, subject, or body exceeds the capacity of the screen display, tap the name of the field (for example, tap "To:") to expand that field. Tap the Done button to return to the New Message screen.

Tap the name of the field to open

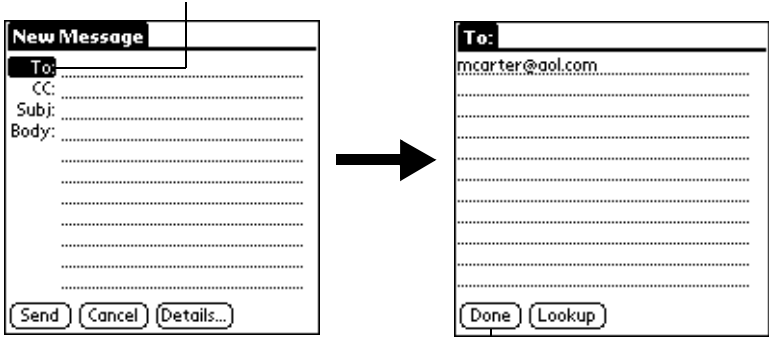

Tap to return to New Message screen

To reply to an e-mail item:

1. Tap an e-mail item in the Message List to display it onscreen.
2. Tap Reply.
3. Select whom you want to receive the reply: Sender only, All recipients, or someone who did not see the original e-mail item (Forward).



4. Select whether you want to include original text or comment original text.
5. Tap OK.
6. Enter the text of your reply.

Tip: You have several options including setting the priority. See "Adding details to e-mail items" later in this chapter.

7. Tap Send to place your reply in the Outbox.

Looking up an address

To identify the recipient of an e-mail item, you need to enter that person's e-mail address. You can do this either by entering the data directly into the field or by using the Look Up command to access the information in your Address Book.

To look up an e-mail address:

1. Tap either the To: or CC: field name to expand it.
2. Enter the first few letters of the last name of the person whose address you want to find.
3. Tap Lookup.
4. If the letters you enter identify a unique listing from your Address Book, your companion completes the address for you. If not, the Lookup dialog box appears and lists all records that contain information in an E-mail field.

Tip: You can also open the Look Up dialog box in the New Message screen by tapping Lookup from the Options menu or by using the Graffiti® Command stroke /L.

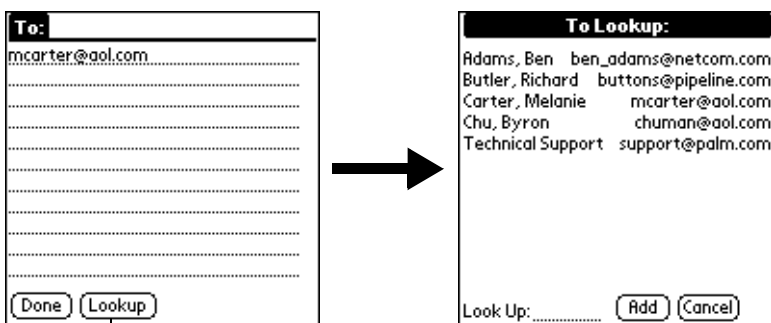

Tap Lookup

5. Enter the first letter of the entry you want to find to scroll to the first entry that begins with that letter. If you write an additional letter, the list scrolls to the first entry that starts with those two letters. For example, writing an "s" scrolls to "Sanders," and writing "sm" scrolls to "Smith."
6. Tap an address to select it.
7. Tap Add.

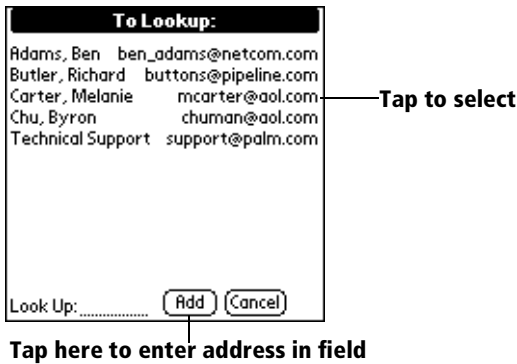

Adding details to e-mail items

Before you send your e-mail item, you can attach additional attributes to it, such as a signature or a priority level. These features are dependent on the desktop E-mail application you use. If your application does not support the attribute you select, your companion cannot attach that attribute to the e-mail item.

The following details are available:

- | | |
|-------------------------|--|
| Priority | Flags an e-mail item as High, Normal, or Low priority. |
| BCC | Creates a blind carbon copy field in the New Message screen. |
| Signature | Attaches previously defined text as the closing of an e-mail item. See “Adding a signature to your e-mail item” later in this chapter. |
| Confirm Read | Requests a confirmation telling you when the e-mail item was read. |
| Confirm Delivery | Requests a confirmation telling you when the e-mail item was delivered. |

Note: The Priority and BCC settings are valid only for the current e-mail item and must be set for each item you create.

Setting a priority

To set a priority for your e-mail item:

1. In the New Message screen, tap Details.

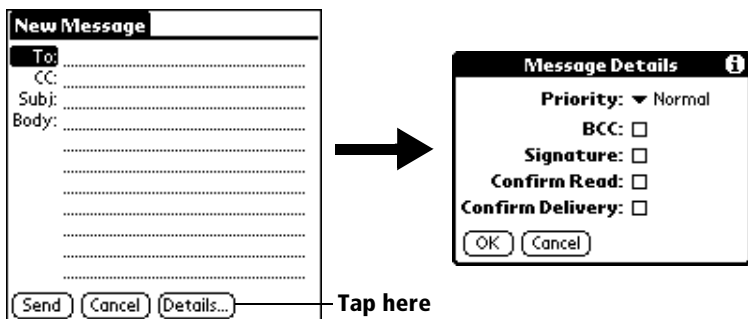

2. Tap the Priority pick list and select the priority you want.

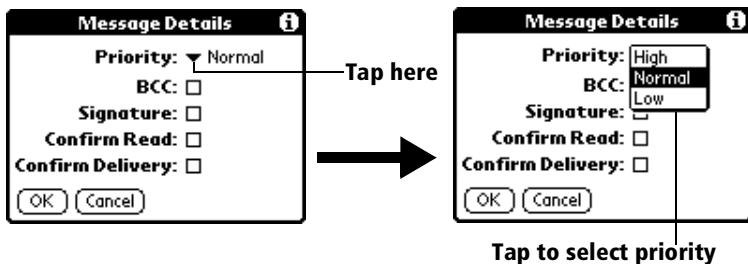

3. Tap OK.

Tip: Your companion can flag e-mail items with a specific priority only if your desktop E-Mail application supports this feature.

Sending a blind carbon copy

To add a BCC field to your e-mail item:

1. In the New Message screen, tap Details.
2. Tap the BCC check box to select it.
3. Tap OK.

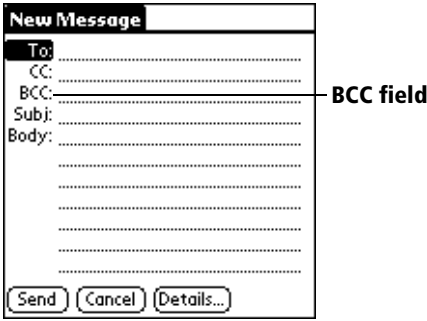

4. Tap the BCC: field and enter an address.

Adding a signature to your e-mail item

A signature consists of information about yourself that is appended to your e-mail item as its closing. For example, a signature can contain your name, address, phone and fax numbers, and any other text you want to include. By defining such information as a signature, you save yourself the trouble of having to enter it every time you create an e-mail item.

Adding a signature to your message is a two-part process. First, you create your signature. Then you select the Signature option.

To create a signature:

1. Tap the Menu icon .
2. Tap Options, and then tap Preferences.
3. Tap the Signature text field and enter the text of your signature.

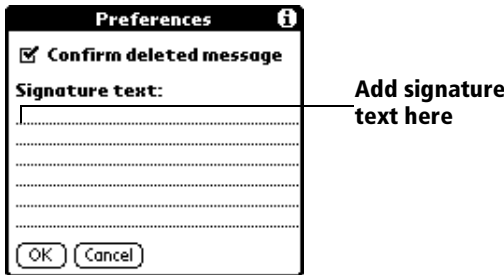

4. Tap OK.

To add a signature to your e-mail item:

1. In the New Message screen, tap Details.
2. Tap the Signature check box to select it and add your signature to the e-mail item.

Note: The check box stays selected, so all subsequent e-mail items you create will also contain your signature until you deselect the Signature option.

3. Tap OK.

Note: The signature does not display in your e-mail item; only your recipient sees the signature.

Requesting confirmations

To receive a confirmation when your e-mail item is read:

1. In the New Message screen, tap Details.
2. Tap the Confirm Read check box to select it.
3. Tap OK.

To receive a confirmation when your e-mail item is delivered:

1. In the New Message screen, tap Details.
2. Select the Confirm Delivery check box to select it.
3. Tap OK.

Storing e-mail to be sent later

When you send e-mail from your companion, it actually stores the e-mail in the Outbox folder until the next time you synchronize your companion with your computer. During synchronization, all e-mail stored in the Outbox folder is transferred to the Outbox folder in your desktop E-Mail application. E-mail created on your companion is sent out the next time you send mail from your desktop E-Mail application.

To send e-mail:

- After you create an e-mail item, tap Send.

Editing unsent e-mail

You can make changes to an e-mail that has not yet been sent, as long as you have not yet performed a HotSync operation. When you edit an e-mail item, your companion removes the item from the Outbox folder and takes you back to the New Message screen, where you can edit the item and resend it, save it as a draft, or delete it.

To retrieve an e-mail item:

1. In the Message List, tap Outbox from the pick list in the upper-right corner.

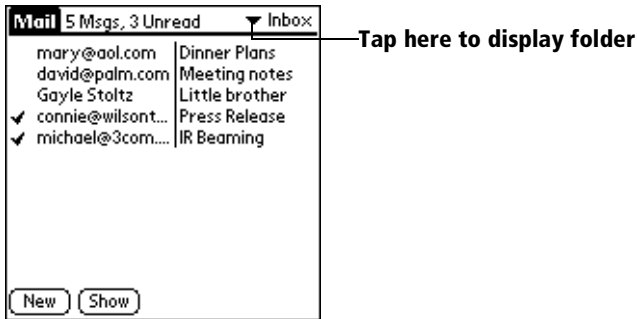

2. Tap the e-mail item you want to retrieve.

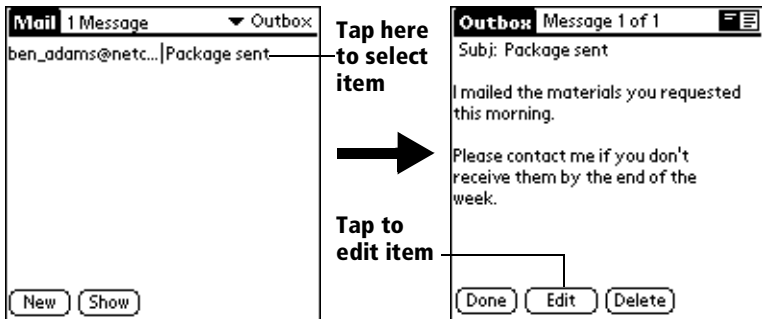

3. Tap Edit.

Draft e-mail

Sometimes you may not want to send an e-mail item immediately; for example, you may want to add additional information before sending it. Your companion stores such e-mail items in the Draft folder until you are ready to edit them again.

Note: When you are creating or editing an e-mail item, you can also save the item as a draft by canceling it. When you cancel an item, your companion opens a dialog asking if you want to save the e-mail item. If you tap Yes, your companion saves the item in the Draft folder.

To save an e-mail item as a draft:

1. Create an e-mail item.
2. Tap the Menu icon .
3. Tap Message, and then tap Save Draft.

To edit an e-mail item saved as a draft:

1. In the Message List, tap Draft from the pick list in the upper-right corner.
2. Tap the draft you want to display.

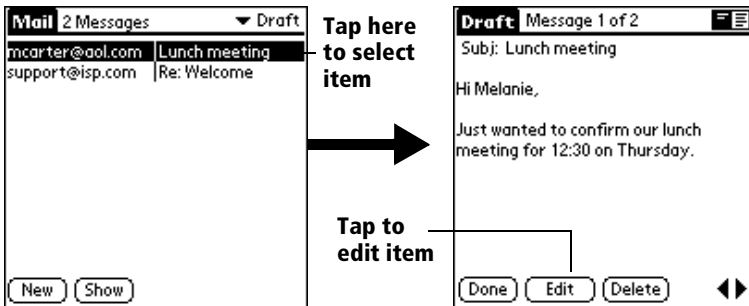

3. Tap Edit.
4. Enter your changes; then either save the e-mail item again as a draft, or tap Send to move the item to your Outbox folder.

Filing e-mail

Your companion can store e-mail you receive or create in the Filed folder. The contents of this folder do not automatically synchronize with your desktop E-Mail application during a HotSync operation. Your companion, however, stores a backup copy of the Filed folder on your computer hard disk.

To file e-mail:

1. Open an e-mail item.
2. Tap the Menu icon .
3. Tap Message, and then tap File.
4. Tap No to save the e-mail item and move it to the Filed folder, or tap Yes to file the item and keep a copy in the Inbox.

To remove e-mail from the Filed folder:

1. In the Message List, tap Filed from the pick list in the upper-right corner.
2. Tap the e-mail item you want to restore.
3. Tap Edit to display and modify the item.

Tip: After you display and modify the e-mail item, you can send it, save it as a draft, or return it to the Filed folder.

Deleting e-mail

Your companion stores deleted e-mail in the Deleted folder until you perform the next HotSync operation. If you delete an e-mail item from the companion, it is also deleted from your desktop E-Mail application when you perform the next HotSync operation.

To delete e-mail:

1. Open the e-mail item you want to delete.
2. Tap Delete.
3. If you selected the Preferences option to confirm deletion, tap Yes.

Removing e-mail from the Deleted folder

You can reverse the deletion of an e-mail item (by removing it from the Deleted folder) as long as you have not performed a HotSync operation or purged the contents of the Deleted folder.

To remove an e-mail item you received from the Deleted folder:

1. In the Message List, tap Deleted from the pick list in the upper-right corner.
2. Tap the e-mail item you want to restore.
3. Tap Undelete to move the selected item to the Inbox and mark it as read.

To remove an e-mail item you created from the Deleted folder:

1. In the Message List, tap Deleted from the pick list in the upper-right corner.
2. Tap the e-mail item you want to restore.
3. Tap Edit to display and modify the item.

Note: After you display and modify the e-mail item, you can send it or save it as a draft.

Purging deleted e-mail

Because your companion stores deleted e-mail in the Deleted folder until you perform a HotSync operation, deleted e-mail can monopolize storage space. To avoid or correct this problem, purge your Deleted folder. E-mail that you purge is still deleted from your desktop E-Mail application during the next HotSync operation.

To purge the contents of the Deleted folder:

1. Tap the Menu icon .
2. Tap Message, and then tap Purge Deleted.
3. Tap Yes.

Note: You cannot restore e-mail items after you purge them.

Message List options

Message List options enable you to manage the way the Message List displays information.

Folders

Your companion provides folders for categorizing your mail. The Message List displays the e-mail items in the folder you select.

To select a folder:

1. Tap the pick list in the upper-right corner to open the list of folders:

- | | |
|----------------|---|
| Inbox | Contains the e-mail from your desktop E-Mail application Inbox, minus any that you have excluded using filtering options. See “Creating special filters” later in this chapter. |
| Outbox | Contains the e-mail you created and sent on the companion since the last HotSync operation. |
| Deleted | Contains the e-mail you deleted since the last HotSync operation. |
| Filed | Contains the e-mail you want to store on the companion. |
| Draft | Contains the e-mail you created using the companion but are not yet ready to send. |

2. Select the folder you want to display in the Message List screen.

Date column

The Date column is optional in the Message List. By default, the Date column is hidden to increase the available screen space.

To show the Date column:

1. In the Message List, tap Show.

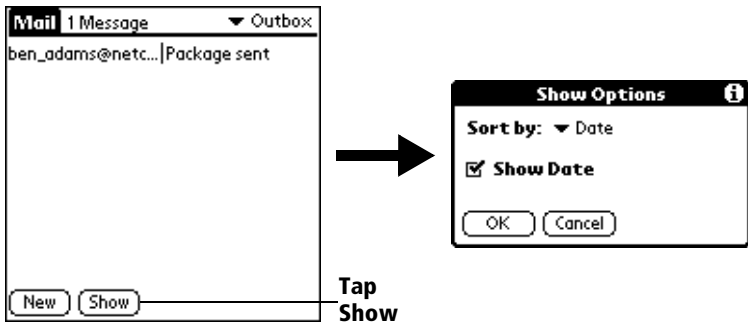

2. Tap the Show Date check box to select it.
3. Tap OK.

Sorting the Message List

You can sort e-mail items by the date sent, by sender, or by subject.

Note: High-priority e-mail items always appear first, no matter how you sort the list.

To sort the Message List:

1. In the Message List, tap Show.
2. Tap the Sort by pick list and select one of the following options:

Date Sorts e-mail by date and displays the most recent e-mail item at the top of the screen.

Sender Sorts e-mail by the sender's user name and displays items in ascending alphabetical order, based on the first word of the From: field.

Subject Sorts e-mail by the subject and displays items in ascending alphabetical order, based on the first word of the Subj: field.

3. Tap OK.

HotSync options

HotSync options enable you to manage your e-mail more effectively by selecting which e-mail items download when you synchronize your computer and your companion. You can define different settings for local and remote synchronization. For example, you may want to download all of your e-mail during local synchronization and only urgent e-mail during remote synchronization. Once defined, your companion determines if synchronization is occurring locally or remotely and uses the appropriate settings for the HotSync operation.

To open the HotSync Options dialog box:

1. Tap the Menu icon .
2. Tap Options, and then tap HotSync Options.
3. Tap the Settings for pick list and select Local HotSync or Remote HotSync.

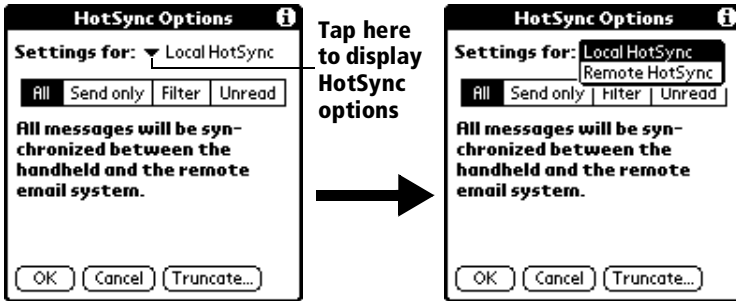

Note: For more information about Local and Remote HotSync operations, see Chapter 6.

4. Tap the filtering option you want to apply:

All During synchronization, all e-mail items in your desktop E-Mail Inbox synchronize with your companion, and all e-mail items in your companion Outbox are sent to your desktop E-Mail application.

Send Only During synchronization, only the e-mail items in your companion Outbox are sent to your desktop E-Mail application; from there, they are sent to their destinations.

Filter During synchronization, all e-mail items in your companion Outbox are sent to your desktop E-Mail application, and items in your desktop E-Mail Inbox that meet specific criteria download to your companion. When you select the Filter setting, the HotSync Options dialog box opens and displays additional filter settings. See “Creating special filters” later in this chapter.

Unread During synchronization, only unread e-mail items download to your companion from your desktop E-Mail Inbox, and all items in your companion Outbox are sent to your desktop E-Mail application.

Note: The All setting does not mean that all information included in each e-mail item downloads to your companion. Truncation settings (explained in a following section) for long e-mail items still apply. Also, Mail never downloads any attachments to your companion. The e-mail item and any text information appear, but the attachment is left in your desktop E-Mail application.

5. If you selected All, Send only, or Unread, tap OK. If you selected Filter, continue to the next section.

Creating special filters

You can create special filters to control the type of e-mail items that download to your companion during synchronization. Special filters work on the premise of ignoring or retrieving items that contain specific information in their header fields.

To create a special filter, you must decide whether you want to ignore or retrieve certain e-mail items. Then, based on that decision, you must tell your companion what it needs to look for in the To:, From:, and Subj: fields to single out those e-mail items.

To access the special filter settings:

- Tap the Filter box in the HotSync Options dialog box.

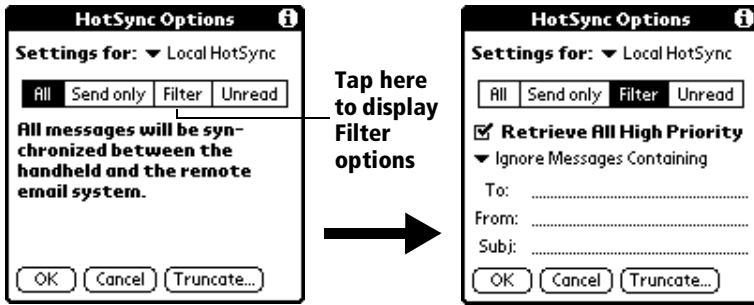

Ignoring or receiving e-mail

The first step in establishing a special filter is to determine whether you want to ignore or retrieve e-mail that matches the information you specify.

To define whether to ignore or receive e-mail:

- Tap the pick list in the center of the HotSync Options dialog box and select one of the following settings:

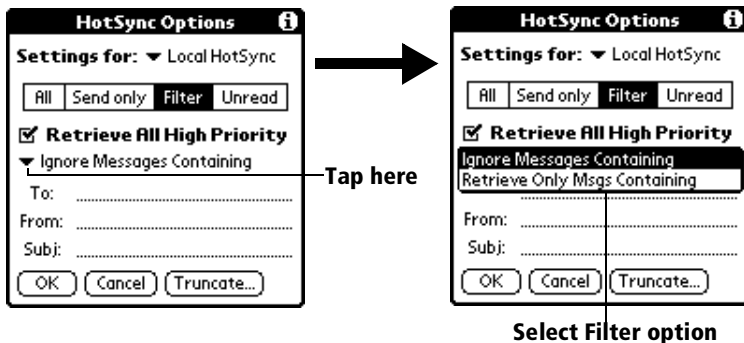

Ignore Messages Containing

Tells your companion to *exclude* the e-mail items that meet the criteria you define and download *all other e-mail items* during synchronization. In general, this filter downloads more e-mail during synchronization because it blocks only one defined subset of e-mail.

**Retrieve
Only Msgs
Containing**

Tells your companion to *include* only the e-mail items that meet the criteria you define and to ignore all other e-mail items during synchronization. This filter has the potential to block more e-mail during synchronization because it downloads only one subset of e-mail.

Defining filter strings

E-mail items are filtered based on the information contained in their To:, From:, and Subj: fields. The information that defines what your companion is looking for is called a *filter string*. You create a filter string by listing the words you want your companion to find and separating them with either a comma or a space. Each word in the filter string is joined by an implicit OR, so you do not need to enter logical connectors like AND or OR.

To create a more complex filter, you can define filter strings for the To:, From:, and Subj: fields simultaneously. Your companion joins the filter strings for these fields using an implicit AND; once again, you do not need to add the logical connector. Your companion does that for you.

For example, suppose you want to receive only e-mail items from John Smith (jsmith@aol.com) or Jack Jones (jjones@aol.com) concerning the Apollo Project. You would create the following filter strings:

In the To: field: jsmith@aol.com, jjones@aol.com

In the Subj: field: Apollo Project

Your companion interprets this as, "Accept e-mail items about the Apollo Project from John Smith or Jack Jones. Do not accept e-mail items from other people. Do not accept e-mail items from John or Jack about any other subject."

When you define a string, note that your companion searches for any instance of that *sequence* of characters. For example, if you create a filter that retrieves only e-mail items containing the string "info," your companion considers "info," "rainforest" and "kinfolk" appropriate matches.

To define a filter string:

1. Tap a header field in the HotSync Options dialog box.

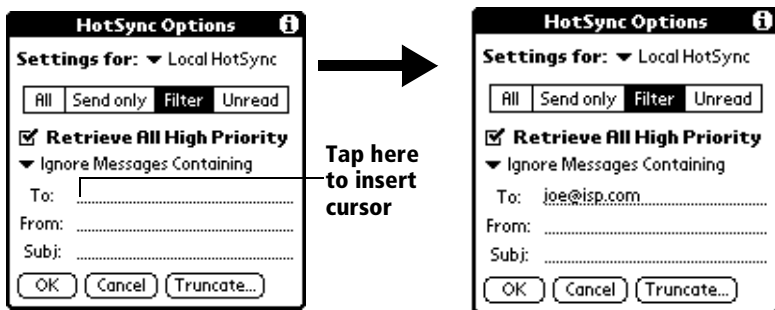

2. Enter your filter string, using commas or spaces to separate the words. Do not add connectors, such as AND or OR, between words in a string.
3. If your string exceeds the length of the field, tap the name of the field to display the Notes screen for that header field. For more information about header field Notes screens, see “Creating e-mail items” earlier in this chapter.

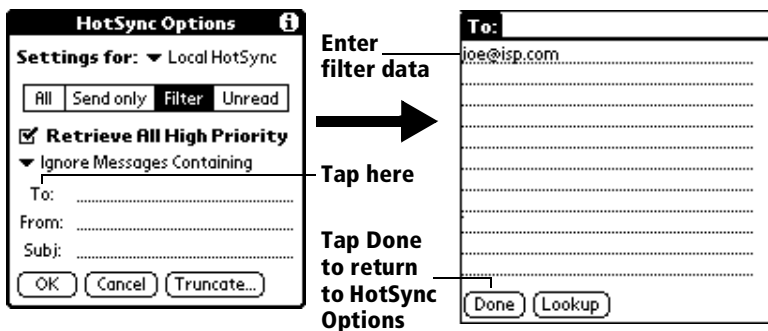

4. Tap Done to return to the HotSync Options dialog box.
5. Tap OK.

High-priority e-mail

The Retrieve All High Priority setting lets you retrieve e-mail items marked high-priority, even if those items would have been blocked by a defined filter.

To retrieve high-priority e-mail items:

1. Tap the Filter box in the HotSync Options dialog box.

2. Tap the Retrieve All High Priority check box to select it.

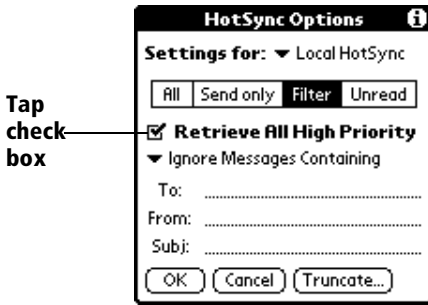

3. Tap OK.

Note: This setting is applicable only if your E-Mail application has the capacity to flag high-priority e-mail items.

Truncating e-mail items

The Truncate feature lets you set a point at which long e-mail items truncate when downloading to your companion. By default, this Truncate value is 4,000 characters. By truncating long messages, you reduce the time it takes to synchronize your desktop E-Mail and Mail, as well as the amount of storage space e-mail uses on your companion.

Note: Truncation is separate and independent from filtering.

To truncate e-mail items:

1. Tap Truncate in the HotSync Options dialog box.

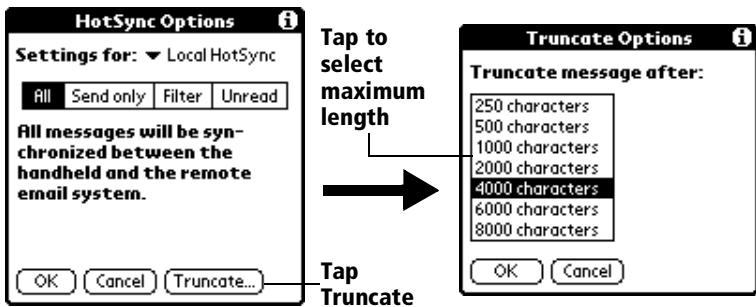

2. Tap to select the truncation setting you want.

Tip: If you select the maximum setting, messages can be 8,000 characters; longer messages are truncated. If you select a lower value, you will have more room for e-mail items.

3. Tap OK.

Mail menus

Mail menus are shown here for your reference, and Mail features that are not explained elsewhere in this book are described here.

See “Using menus” in Chapter 1 for information about choosing menu commands.

Message menu

The Message menu varies depending on whether you are viewing an e-mail item, creating an e-mail item, or viewing the Message List.

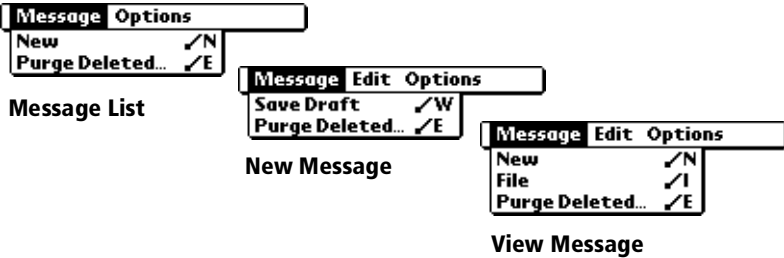

Options menus

The Options menu varies depending on whether you are creating or editing an e-mail item.



About Mail Shows version information for Mail.

Beaming information

Your WorkPad c3 companion is equipped with an IR (infrared) port that you can use to beam information to another WorkPad PC companion that is close by and also has an IR port. The IR port is located at the top of the companion, behind the small dark shield.

You can beam the following information between WorkPad PC companions:

- The record currently displayed in Date Book, Address Book, To Do List, or Memo Pad
- All records of the category currently displayed in Address Book, To Do List, or Memo Pad
- A special Address Book record that you designate as your business card, containing information you want to exchange with business contacts
- An application installed in RAM memory

To select a business card:

1. Create an Address Book record that contains the information you want on your business card.
2. Tap the Menu icon .
3. Tap Record, and then tap Select Business Card.
4. Tap Yes.

To beam a record, business card, or category of records:

1. Locate the record, business card, or category you want to beam.
2. Tap the Menu icon .
3. Tap Record, and then tap one of the following:
 - The Beam command for an individual record
 - In Address Book only: Beam Business Card
 - Beam Category
4. When the Beam Status dialog box appears, point the IR port directly at the IR port of the receiving companion.

Tip: For best results, WorkPad c3 companions should be between 10 centimeters (approximately 4 inches) and 1 meter (approximately 39 inches) apart, and the path between the two devices must be clear of obstacles. Beaming distance to other WorkPad PC companions may be different.



5. Wait for the Beam Status dialog box to indicate that the transfer is complete before you continue working on your companion.

To beam an application:

1. Open the Applications Launcher.
2. Tap the Menu icon .
3. Tap App, and then tap Beam.
4. Tap the application you want to transfer.

Note: Some applications are copy-protected and cannot be beamed. These are listed with a lock icon next to them.

5. Tap Beam.
6. When the Beam Status dialog box appears, point the IR port directly at the IR port of the receiving companion.
7. Wait for the Beam Status dialog box to indicate that the transfer is complete before you continue working on your companion.

To receive beamed information:

1. Turn on your companion.
2. Point the IR port directly at the IR port of the transmitting companion to open the Beam Status dialog box.
3. Tap Yes.
4. Wait for the Beam Status dialog box to indicate that the transfer is complete, and then tap OK to display the new entry.

Incoming records are placed in the Unfiled category.

Tips on beaming information

- You can press the Address Book application button  for about two seconds to beam your business card.
- You can set the full-screen pen stroke to beam the current entry. See “Pen preferences” in Chapter 7 for more information.
- You can use the Graffiti Command stroke /B to beam the current entry.

Chapter 6

Advanced HotSync® Operations

HotSync® technology enables you to synchronize data between one or more WorkPad PC companions and Palm™ Desktop for IBM WorkPad or another PIM such as Microsoft Outlook. To synchronize data, you must connect your WorkPad c3 companion and Palm Desktop for IBM WorkPad either directly, by placing your companion in the cradle attached to your computer, or indirectly, with a WorkPad c3 Modem or network.

This chapter describes how to select HotSync options and perform a HotSync operation via a modem or network. See “Exchanging and updating data: HotSync operations” in Chapter 4 for information about performing your first and subsequent local HotSync operations.

Selecting HotSync setup options

You can choose when you want HotSync Manager to run. If necessary, you can adjust the local and modem HotSync settings as well.

To set the HotSync options:

1. Click the HotSync Manager icon in the Windows system tray.
2. Choose Setup.

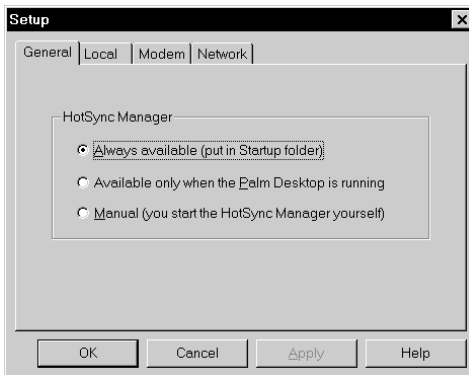

3. Click the General tab and select one of the following options:

Always available Adds HotSync Manager to the Startup folder and constantly monitors the communication port for synchronization requests from your companion. With this option, the HotSync Manager synchronizes data even when Palm Desktop for IBM WorkPad is not running.

Available only when Palm Desktop for IBM WorkPad is running Starts HotSync Manager and monitors requests automatically when you open Palm Desktop for IBM WorkPad.

Manual Monitors requests only when you select HotSync Manager from the Start menu.

Tip: If you are not sure which option to use, keep the default setting: Always available.

- 4. Click the Local tab to display the settings for the connection between your computer and the companion cradle, and adjust the following options as needed.

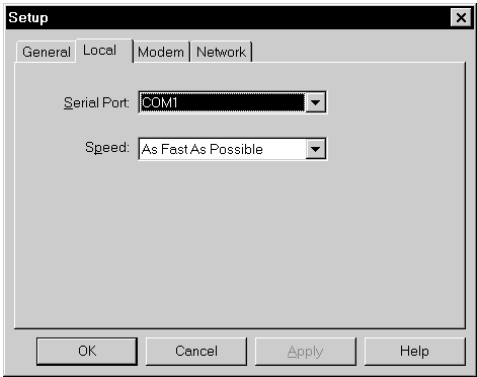

Serial Port

Identifies the port that Palm Desktop for IBM WorkPad uses to communicate with the cradle. This selection should match the number of the port to which you connected the cradle.

Note: Your companion cannot share this port with an internal modem or other device. See “WorkPad c3 components” in Chapter 1 if you have trouble identifying the serial port.

Speed

Determines the speed at which data is transferred between your companion and Palm Desktop for IBM WorkPad. Try the As Fast As Possible rate first, and adjust downward if you experience problems. This setting allows Palm Desktop for IBM WorkPad and your companion to find and use the fastest speed.

5. Click the Modem tab to display the modem settings and adjust the options as needed. See “Conducting a HotSync operation via modem” later in this chapter for more information.
6. If you are attached to a network, click the Network tab to display the network settings and adjust the options as needed. See “Conducting a HotSync operation via a network” later in this chapter for more information.
7. Click OK.

Customizing HotSync application settings

For each application, you can define a set of options that determines how records are handled during synchronization. These options are called a “conduit.” By default, a HotSync operation synchronizes all files between the companion and Palm Desktop for IBM WorkPad.

In general, you should leave the settings to synchronize all files. The only reason you might want to change these settings is to overwrite data on either your companion or Palm Desktop for IBM WorkPad, or to avoid synchronizing a particular type of file because you do not use it.

In addition to the conduits for Date Book, Address Book, To Do List, Memo Pad, and Expense, Palm Desktop for IBM WorkPad includes System and Install conduits. The System conduit backs up the system information stored on your companion, including Graffiti® ShortCuts. The Install conduit installs applications on your companion.

To customize HotSync application settings:

1. Click the HotSync icon ™ in the Windows system tray (bottom-right corner of the taskbar).

Tip: You can also click the HotSync command on the Palm Desktop for IBM WorkPad menu bar.

2. From the HotSync Manager menu, choose Custom.

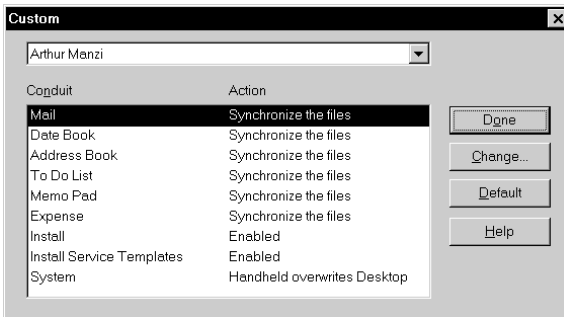

3. Select the appropriate user name from the list.
4. Select an application in the Conduit list.
5. Click Change.

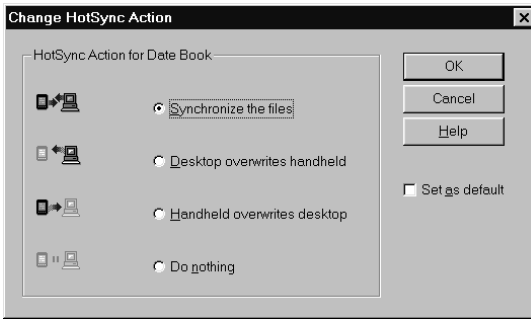

6. Click the direction in which you want to write data, or click Do Nothing to skip data transfer for an application.

Note: Changing the HotSync setting from the default affects only the *next* HotSync operation. Thereafter, the HotSync Actions revert to their default settings. To use a new setting on an ongoing basis, select the Set As Default box. Thereafter, whatever you selected as the default setting is used when you click the Default button in the Custom dialog.

7. Click OK.
8. Repeat steps 4 through 7 to change conduit settings for other applications.
9. Click Done to activate your settings.

Conducting a HotSync operation via modem

You can use a modem to synchronize your companion when you are away from your computer.

Note: The first HotSync operation must be local, using the cradle. After that, you can perform a modem HotSync operation.

To perform a HotSync operation via modem, you must complete the following steps:

- A modem connected to your computer
- Palm Desktop for IBM WorkPad configured for use with the modem
- A WorkPad c3 Modem connected to your organizer
- Modem Preferences configured for use with the WorkPad c3 Modem

Preparing your computer

There are a few steps you must perform to prepare your computer for a modem HotSync operation. Be sure to perform these steps before you leave your office so that your computer is ready to receive a call from your companion.

To prepare your computer for a modem HotSync operation:

1. Confirm that the computer modem is connected and turned on, and that no communications applications, such as fax or telephony software, are running on a COM port.

Note: Make sure the computer is disconnected from all online services, such as America Online (AOL) and CompuServe. This helps to avoid conflicts with the COM port.

2. Start HotSync Manager if it is not already running, and from the HotSync Manager menu, choose Modem.
3. Adjust the following options as needed.

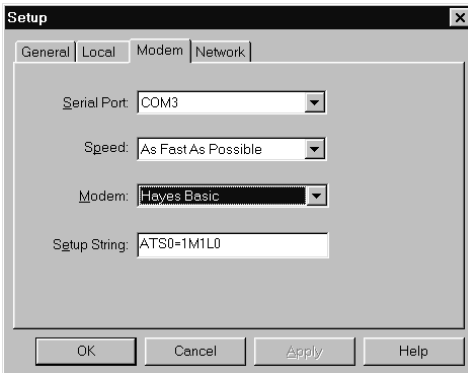

Serial Port

Identifies the port for the modem. If you are unsure of the port assignment, look at the Modem Properties in the Windows Control Panel.

Speed

Determines the speed at which data is transferred. Try the As Fast As Possible rate first, and adjust downward if you experience problems. This setting allows Palm Desktop for IBM WorkPad and your companion to find and use the fastest speed.

Modem

Identifies the modem type or manufacturer. Refer to your modem manual or face plate for its type or settings. If you are not sure of your modem type or your modem does not match any that appear in the list, select Hayes Basic.

Setup String



Identifies the setup string for your particular modem. Not all modems require a setup string. Refer to your modem manual and enter the setup string if recommended by the manufacturer.

4. Click OK.

Preparing your companion

There are a few steps you must perform to prepare your companion for a modem HotSync operation.

To prepare your companion for a modem HotSync operation:

1. Tap the Applications icon .
2. Tap the HotSync icon .
3. Tap the Enter Phone # field.

Note: If you plan to connect to your company's dial-in server (network modem) instead of connecting to a computer modem, see "Conducting a HotSync operation via a network" later in this chapter.

4. Enter the telephone number to access the modem connected to your computer.



The image shows a dialog box titled "Phone Setup" with an information icon in the top right corner. It contains the following fields and options:

- Phone #:** A text field with a dotted line indicating where to enter a number.
- Dial prefix:** 9..... (The "9" is pre-filled in the field)
- Disable call waiting:** 1170.....
- Use calling card:**
.....

At the bottom of the dialog are two buttons: "OK" and "Cancel".

5. If needed, enter a dial prefix (such as "9") to access an outside line, and then tap the Dial Prefix check box.



Tip: You can enter a comma in the field to introduce a "pause" in the dialing sequence.

6. If the phone line you are using for the companion has Call Waiting, select the Disable call waiting check box to avoid an interruption during the modem HotSync operation.
7. If you want to use a calling card to place the call, select the check box and enter the calling card number.
8. Tap OK.
9. Tap the Menu icon .
10. Tap Options, and then tap Modem Setup.
11. Enter the settings. See "Modem preferences" in Chapter 7 for more information.

Selecting the conduits for a modem HotSync operation

The Conduit Setup dialog box on your companion enables you to define which files and/or applications synchronize during a modem HotSync operation. You can use these settings to minimize the time required to synchronize data with a modem.

To change the Conduit Setup for a modem HotSync operation:

1. Tap the Applications icon .
2. Tap the HotSync icon .
3. Tap the Menu icon .
4. Tap Options, and then tap Conduit Setup.
5. Tap the check boxes to deselect the files and applications that you do *not* want to synchronize during a modem HotSync operation. The default setting is to synchronize all files.





Note: Applications that do not have a database (such as games) do not synchronize — even if you select the item in the Conduit Setup dialog box.

6. Tap OK.

Performing a HotSync operation via a modem

After you prepare your computer and your companion, and select your Conduit Setup options, you are ready to perform a modem HotSync operation.

To perform a modem HotSync operation:

1. Tap the Applications icon .
2. Tap the HotSync icon .
3. Tap the Modem icon  to dial the desktop modem and synchronize the applications.
4. Wait for the HotSync operation to complete. If you have any problems conducting a successful HotSync operation, see Appendix B.

Conducting a HotSync operation via a network

When you use the Network HotSync software, you can take advantage of the LAN and WAN connectivity available in many office environments. The Network HotSync software enables you to perform a HotSync operation by dialing in to a network or by using a cradle that is connected to any computer on your LAN or WAN (provided that the computer connected to the cradle also has the Network HotSync software installed, your computer is on, and the HotSync Manager is running).

Connecting to your company's dial-in server

The Network HotSync software requires the following:

- Your computer has TCP/IP support installed.
- Both your company's network system and its remote access server support TCP/IP. (Your System Administrator has this information.)
- You have a remote access account. (If you do not have an account, consult your System Administrator.)

Everything you need to connect to your company's dial-in server (network modem) is included with Palm Desktop for IBM WorkPad and companion software. You need to activate the feature, however, on both Palm Desktop for IBM WorkPad and your companion.

To prepare your computer for a network HotSync operation:

1. Click the HotSync Manager icon  in the Windows system tray.

Tip: The Windows system tray is usually in the lower-right corner on your computer display. The location may vary depending on the location of the taskbar and the version of Windows you are using.

2. From the HotSync Manager menu, choose Network.



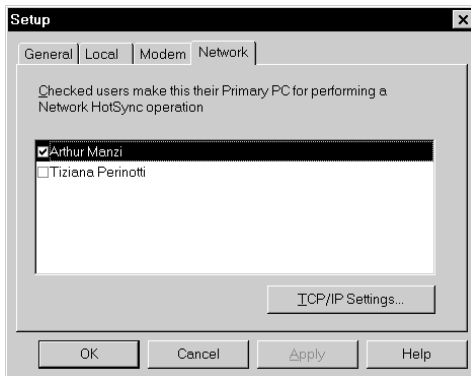

3. From the HotSync Manager menu, choose Setup.
4. Click the Network tab and make sure your user name has a check mark next to it. If the check mark is not there, click the check box next to your user name.



5. Click OK.
6. Place your companion in the cradle and perform a HotSync operation.

The HotSync operation records network information about your computer on your companion. With this information, your companion can locate your computer when you perform a HotSync operation over the network.

To prepare your companion for a network HotSync operation:

1. Tap the Applications icon .
2. Tap the HotSync icon .
3. Tap the Menu icon .
4. Tap Options, then tap Modem Sync Prefs.
5. Tap Network.
6. Tap OK.

Note: See “Network preferences and TCP/IP software” in Chapter 7 for information on configuring Network HotSync preferences.

Using File Link

The File Link feature enables you to import Address Book and Memo Pad information onto your companion from a separate external file such as a company phone list. HotSync Manager stores the data in a separate category on your Palm Desktop for IBM WorkPad and your companion. You can configure the File Link feature to check for changes to the external file when you perform a HotSync operation.

With File Link, you can import data stored in any of the following formats:

- Comma delimited (.csv)
- Tab delimited (.tsv)
- Memo Pad archive (.mpa)
- Address Book archive (.aba)
- Text (.txt)

For information on how to set up a file link, see the Palm Desktop online Help.

Creating a user profile

If you use the File Link feature to configure several WorkPad PC companions with specific information (such as a company phone list) before distributing them to their actual users, you can create a user profile to load the data into a companion without associating that data with a user name. The User Profile feature is designed only for the first-time HotSync operation, before you assign a User ID to a particular companion.

To create a user profile:

1. Open Palm Desktop for IBM WorkPad.
2. From the Tools menu, choose Users.
3. Click Profiles.
4. Click New.

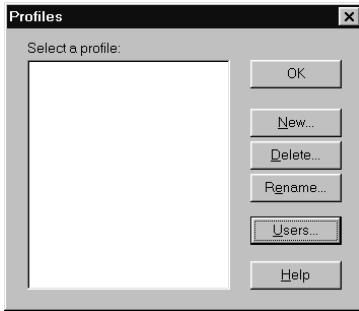

5. Enter a unique name for the profile, and click OK.



6. Repeat steps 3 and 4 for each profile that you want to create, and then click OK to return to Palm Desktop for IBM WorkPad.
7. Select the profile from the User list and create the data for the profile (e.g., company phone list, etc.).

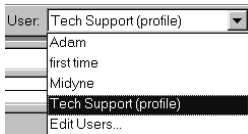

To use a profile for the first-time HotSync operation:

1. Place the new companion in the cradle.
2. Press the HotSync button  on the cradle.
3. Click Profiles.
4. Select the profile that you want to load on the companion, and click OK.

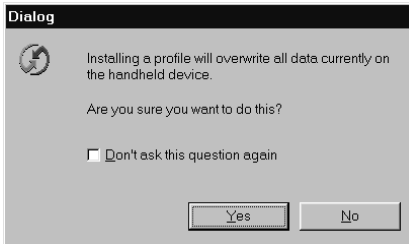

5. Click Yes to transfer all the profile data to the companion.

The next time you perform a HotSync operation, Palm Desktop for IBM WorkPad prompts you to assign a user name to the companion.

Chapter 7

Setting Preferences for Your Companion



The Preferences screens enable you to customize the configuration options on your WorkPad c3 companion.

In the Preferences screens, you can do the following:

General	Set the current date and time, the auto shut-off interval, the Stay on in cradle feature, the Beam Receive feature, and the system, alarm, and game sounds.
Formats	Set the country default and the formats for dates, times, calendar, and numbers.
Modem	Configure your companion for use with a modem.
Owner	Assign your name, phone number, and other owner information to your companion.
Buttons	Assign different applications to the buttons on the front panel of your companion and the HotSync® button on the cradle, and reassign the full-screen pen stroke command.
ShortCuts	Define a list of Graffiti® abbreviations.
Digitizer	Calibrate the screen on your companion.
Network	Configure your companion for use with a network.

Viewing preferences

To open the Preferences screens:

1. Tap the Applications icon .
2. Tap the Preferences icon .
3. Tap the pick list in the upper-right corner of the screen.
4. Select the Preferences screen you want to view.

Buttons preferences

The Buttons Preferences screen enables you to associate different applications with the buttons on the front of the companion.

For example, if you find that you seldom use To Do List and often use Expense, you can assign the To Do List button to start Expense.

Any changes you make in the Buttons Preferences screen become effective immediately; you do not have to change to a different screen or application.

If you assign a different application to a button, you can still access the original application using the Applications Launcher.

To change the Buttons preferences:

1. Tap the pick list next to the button you want to re-assign.

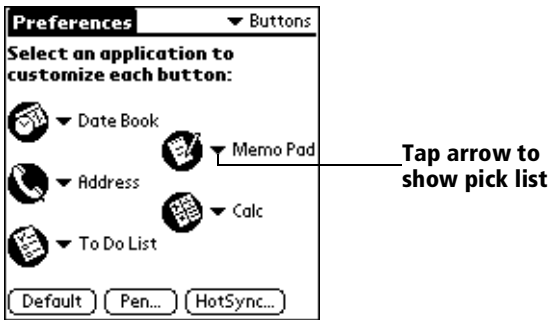

2. Tap the application that you want to assign to the button.

Tip: To restore all of the buttons to their factory settings, tap Default.

Pen preferences

The Buttons Preferences screen enables you to change the assignment of the full-screen pen stroke. By default, the full-screen pen stroke activates Graffiti Help.

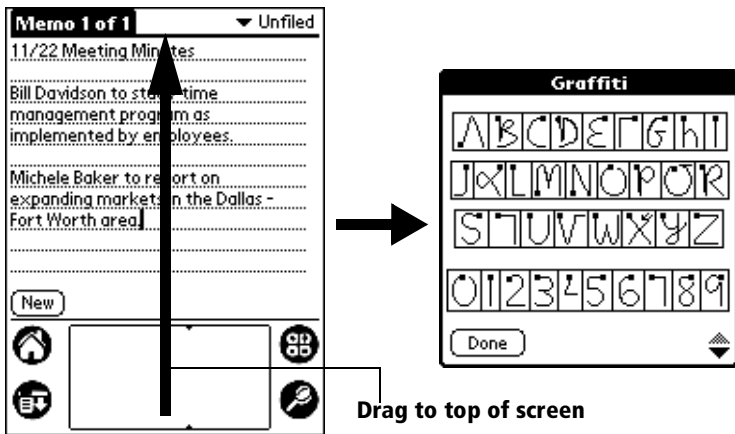

To change the Pen preferences:

1. Tap Pen.

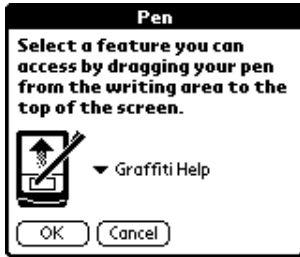

2. Tap the pick list and select one of the following settings for the full-screen pen stroke:

- Backlight** Turns on the backlight of your companion.
- Keyboard** Opens the onscreen keyboard for entering text characters.
- Graffiti Help** Opens a series of screens that show the complete Graffiti character set.
- Turn Off & Lock** Turns off and locks the companion. You must assign a password to lock the companion. When locked, you need to enter the password to use your companion.
- Beam Data** Beams the current record to another WorkPad PC companion.

3. Tap OK.

HotSync buttons preferences

The Buttons Preferences screen also enables you to associate different applications with the HotSync button on the cradle and the HotSync button on the optional WorkPad c3 Modem. Any changes that you make in the HotSync Buttons dialog box become effective immediately; you do not have to change to a different screen or application.

To change the HotSync buttons preferences:

1. Tap HotSync.
2. Tap the pick list next to the button you want to assign.

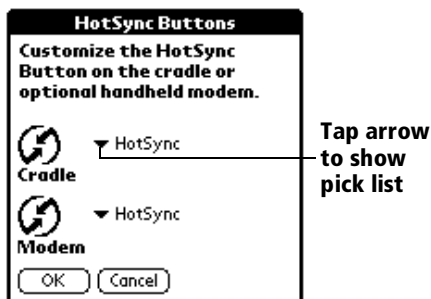

3. Tap the application that you want to assign to each button.
The default setting for each button is the HotSync setting, which means the cradle and optional WorkPad c3 Modem perform their normal HotSync functions.
4. Tap OK.

Digitizer preferences

The Digitizer Preferences screen opens the digitizer calibration screen. This is the same screen that appears when you start your companion for the first time.

You can recalibrate your screen after a hard reset, or if your digitizer drifts.

Formats preferences

Use the Formats Preferences screen to set the country default and the display format of the dates, times, and numbers on your companion.

Country default

The country default sets date, time, week start day, and number conventions based on geographic regions where you might use your companion. For example, in the United Kingdom, time often is expressed using a 24-hour clock. In the United States, time is expressed using a 12-hour clock with an AM or PM suffix.

All your companion applications use the Country default settings. You can, however, customize your own preferences. See the “Time, date, week start, and numbers formats” section later in this chapter.

To set the country default:

1. Tap the country name pick list.

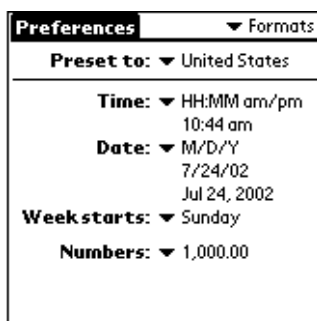

2. Tap the setting you want to use.

Time, date, week start, and numbers formats

The Time setting defines the format for the time of day. The time format that you select appears in all applications on your companion.

To select the time, date, week start, and numbers format:

1. Tap the Time pick list and select a format.
2. Tap the Date pick list and select a format.
3. Tap the Week starts pick list, and select whether you want the first day of the week to be Sunday or Monday.

Note: This setting controls the Day, Week, and Month views in Date Book and all other aspects of your companion that display a calendar.

4. Tap the Numbers pick list, and select formats for the decimal point and thousands separator.

General preferences

The General Preferences screen enables you to set the time, date, auto shutoff interval, and sounds for your companion.

See Chapter 1 for information on setting the time and date.

Auto-off delay

Your companion has an automatic shutoff feature that turns off the power and backlight after a period of inactivity. This feature helps conserve battery power in case you forget to turn off your companion.

If you find that your companion shuts itself off before you finish reviewing the information on the screen, you should increase the time setting of the automatic shutoff feature.

To set the Auto-off delay:

1. Tap the Auto-off pick list.
2. Tap the setting you want to use for the automatic shutoff feature: 1 minute, 2 minutes, or 3 minutes.

Cradle settings

You can choose to leave your companion on when it is in the cradle during a HotSync operation, or when you are recharging the battery, so you can continue to view your data.

To change the cradle setting:

- Tap the Stay on in Cradle check box to leave your companion on when it is in the cradle.

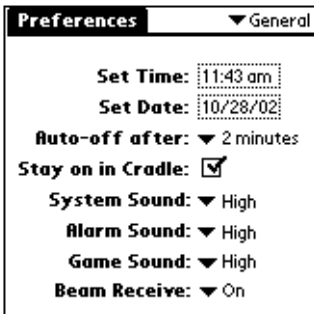

System, alarm, and game sounds

Your companion uses a variety of sounds. The System, Alarm, and Game Sound settings enable you to turn the sounds on or off, and to adjust the volume level.

To set the system and alarm sounds:

1. Tap the System Sound pick list and select the sound level.

Note: When you turn off the System Sounds, you also turn off the “chime” tones associated with the HotSync operation.

2. Tap the Alarm Sound pick list and select the sound level.
3. Tap the Game Sound pick list and select the sound level.

Note: The Game Sound setting works only with games that are programmed to respond to this setting. Older games typically do not respond to this setting.

Beam Receive

You can choose to turn off the Beam Receive feature. This prohibits anyone from beaming information to your companion. It also results in a slight saving of battery power.

To change the Beam Receive setting:

- Tap the Beam Receive pick list and select On or Off.

Modem preferences

The Modem Preferences screen enables you to define the settings for a modem that is directly connected to your companion. These settings are for applications that activate and use the modem.

To define the Modem preferences:

1. Tap TouchTone or Rotary.

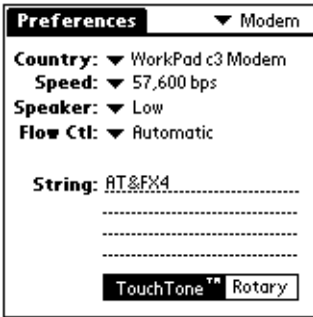

Note: Select the Rotary setting only if you are certain that your telephone service does not support TouchTone dialing.

2. Tap the Speed pick list and select the maximum speed for your modem.

Note: This is the speed at which your modem communicates with your companion, not the speed at which your modem communicates with your telephone service.

3. Tap the Speaker pick list and select the speaker volume that you want for the modem.
4. Tap the Flow Ctl (Flow Control) pick list and select either Automatic, On (Xon), or Off (Xoff) flow control for the modem connection.
5. Tap the Country pick list and select the country where you are using your companion.
6. If necessary, edit the String text to change the modem setup string.

Network preferences and TCP/IP software

The Network Preferences settings enable you to use the TCP/IP software that is included in the companion operating system. You can use the TCP/IP software to connect with Internet Service Providers (ISPs) or dial-in (remote access) servers. Because the TCP/IP software is a feature of the operating system, you configure all parameters relating to it from the Preferences application.

To use TCP/IP, you must configure both the Modem Preferences and the Network Preferences settings.

Note: Modem Preferences settings enable your WorkPad c3 companion to use the WorkPad c3 Modem to communicate with remote devices. For example, you can communicate with your ISP server, or with your computer if you are away on travel. See “Modem preferences” earlier in this chapter for a complete explanation on how to configure modem parameters.

After you configure both the Network and Modem Preferences, you can establish a PPP (Point-to-Point Protocol), SLIP (Serial Line Internet Protocol), or CSLIP (Compressed Serial Line Internet Protocol) connection with your ISP or dial-in server. You can do this either by using menu commands from the Network Preferences screen or by using a third-party application.

Note: TCP/IP provides the ability to connect to your ISP or dial-in server with applications that allow you to view the transmitted data. Visit the web site <http://www.palm.com> for information on third-party applications that take advantage of TCP/IP.

Selecting a service

Use the Service setting to select the service template for your Internet Service Provider or a dial-in server. Service templates are a set of ISP and dial-in server configuration settings that you can create, save, and reuse.

To select a service:

1. Tap the Service pick list.

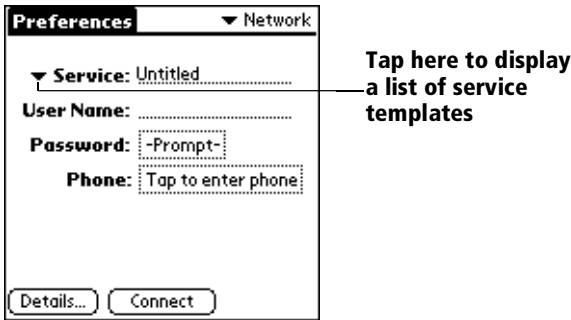

2. Tap the predefined service template you want to use.

Entering a user name

The User Name setting identifies the name you use when you log into your Internet Service Provider or your dial-in server. Although this field can contain multiple lines of text, only two lines appear onscreen.

To enter a user name:

1. Tap the User Name field.
2. Enter your user name.

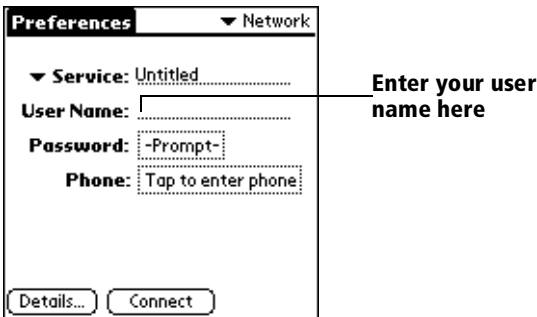

Note: Most dial-in servers do not accept spaces in the user name.

Entering a password

The Password box identifies the password you use to log into your server or ISP. Your entry in this field determines whether your companion prompts you to enter a password each time you log into your network:

- If you do not enter a password, your companion displays the word “Prompt” in this field and asks you to enter a password during the login procedure.
- If you enter a password, your companion displays the word “Assigned” in this field and does not prompt you to enter a password during the login procedure.

Note: If you are concerned about security, select the Prompt option and do not enter a password.

To enter a password:

1. Tap the Password field.
2. Enter the password you use to log into your server.

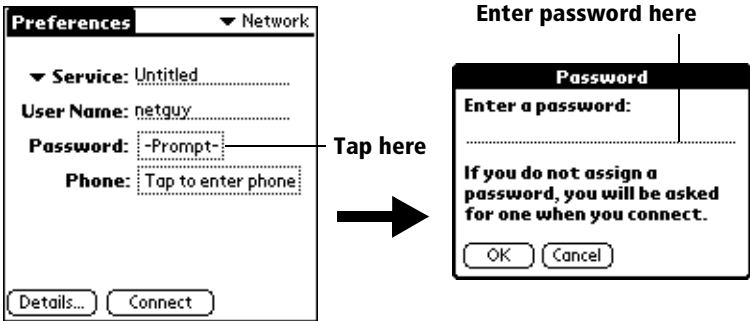

3. Tap OK.

Note: The Password field updates to display the word “Assigned.”

Adding telephone settings

When you select the Phone field, your companion opens a dialog box in which you define the telephone number you use to connect with your ISP or dial-in server. In addition, you can also define a prefix, disable Call Waiting, and give special instructions for using a calling card.

Note: The Phone Setup dialog box works correctly for AT&T and Sprint long-distance services. However, because MCI works differently, MCI customers need to put the calling card number in the Phone # field and the phone number in the Use calling card field.

To enter your server phone number:

1. Tap the Phone # field.
2. Enter the phone number you use to reach your ISP or dial-in server.

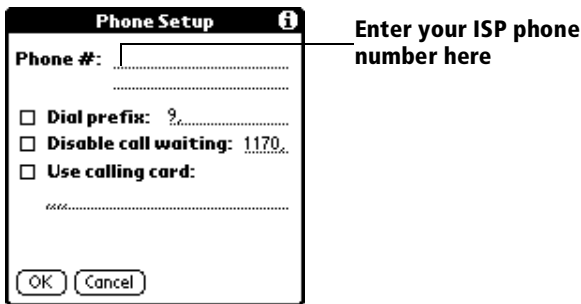

3. If you need to enter a prefix or disable Call Waiting, skip to those procedures. Otherwise, tap OK.

Entering a prefix

A prefix is a number that you dial before the telephone number to access an outside line. For example, many offices require that you dial “9” to dial a number outside the building.

To enter a prefix:

1. Tap the Dial Prefix check box to select it.

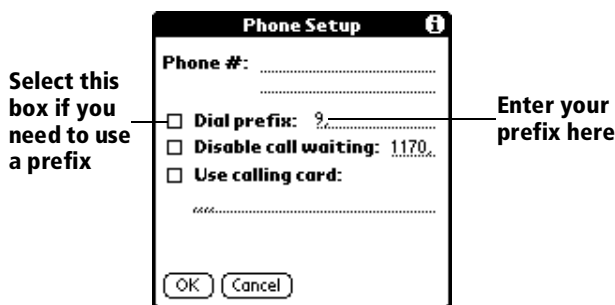

2. Enter the prefix.
3. Tap OK.

Disabling Call Waiting

Call Waiting can cause your session to terminate if you receive a call while you are connected. If your telephone has Call Waiting, you need to disable this feature before logging into your ISP or dial-in server.

To disable Call Waiting:

1. Tap the Disable call waiting check box to select it.

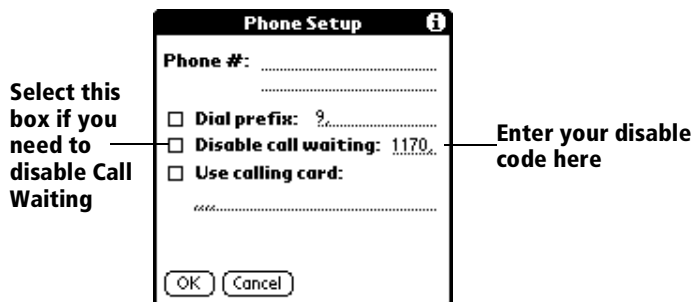

2. Enter the code to disable Call Waiting on the Disable call waiting line.

Note: Each telephone company assigns a code to disable Call Waiting. Contact your local telephone company for the code that is appropriate for you.

3. Tap OK.

Using a calling card

The Use calling card field enables you to use your calling card when dialing your ISP or Intranet server. Keep in mind that there is usually a delay before you enter your calling card number. When you define your calling card number, you need to add commas at the beginning to compensate for this delay. Each comma delays transmission of your calling card number for two seconds.

To use a calling card:

1. Tap the Use calling card check box to select it.

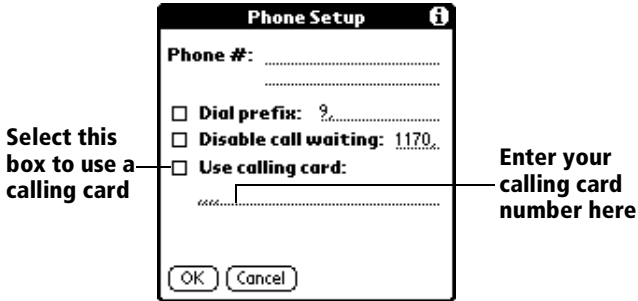

2. Enter your calling card number on the Use calling card line.

Note: It is a good idea to add at least three commas at the beginning of your calling card number to compensate for the cue delay.

3. Tap OK.

Connecting to your service

After you set your Modem and Network Preferences, establishing a connection to your Internet Service Provider (ISP) or your company's network (dial-in server) is easy.

Note: If you are connecting to an ISP, you need a third-party application, such as a web browser or news reader, to take advantage of this connection. For information about third-party applications that support TCP/IP, check the web site <http://www.palm.com>.

To establish a connection:

- Tap Connect to dial the current service and display the Service Connection Progress messages.

Tip: To see expanded Service Connection Progress messages, press the lower half of the Scroll button.

To close a connection:

- Tap Disconnect to terminate the connection between your companion and your service.

Creating additional service templates

You can create additional service templates from scratch or by duplicating existing templates and editing information. After you create a new or duplicate template, you can add and edit settings.

To add a new service template:

1. Tap the Menu icon .
2. Tap Service, and then tap New.

A new service template (called Untitled) is added to the Service pick list.

To duplicate an existing service template:

1. Tap the Service pick list.
2. Tap the predefined service template you want to duplicate.
3. Tap the Menu icon .
4. Tap Service, and then tap Duplicate.

A copy of the service template is added to the Service pick list.

Adding detailed information to a service template

If you are using one of the predefined service templates, you probably only need to enter your user name and telephone number. If you are creating a new service template, you may need to provide additional information to your ISP or dial-in server. You use the Details dialog box to add additional information to a selected service template.

To select a connection type:

1. Tap the service field.
2. Tap Details.

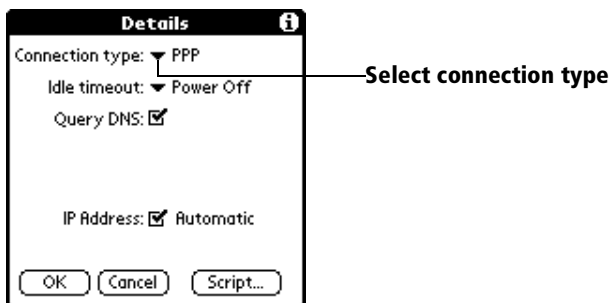

3. Tap the Connection type pick list and select one of the following connection types:

PPP	Point-to-Point protocol
SLIP	Serial Line Internet Protocol
CSLIP	Compressed Serial Line Internet Protocol

Note: If you are not sure, try PPP; if that does not work, ask your Internet Service Provider or your System Administrator for the correct connection type.

Idle timeout

The Idle timeout setting defines how long your companion waits before dropping the connection with your ISP or dial-in server when you switch out of a TCP/IP application.

To set the Idle timeout:

1. Tap the Idle timeout pick list and select one of the following options:

Immediate	Drops the connection to your ISP immediately when you switch to another application.
1 minute	Waits one minute for you to open another application before it drops the connection.
2 minutes	Waits two minutes.
3 minutes	Waits three minutes.
Power Off	Keeps your PPP or SLIP connection until you turn off your companion (or until it times out). This option works best with the WorkPad c3 Modem.

2. Tap OK.

Defining primary and secondary DNS

The Domain Naming System (DNS) is a mechanism in the Internet for translating the names of host computers into IP addresses. When you enter a DNS number (or IP address), you are identifying a specific server that handles the translation services.

Each IP address has four sections, separated by periods. In the Details dialog box, you enter each section separately. Each section of an IP address is made up of a number from 0 to 255; numbers are the only allowable characters in this field.

Ask your Internet Service Provider or System Administrator for the correct Primary or Secondary DNS IP numbers.

Tip: Many systems do not require that you enter a DNS. If you are not sure, leave the DNS field blank.

To enter a primary and secondary DNS:

1. Tap the Query DNS check box to deselect it.
2. Tap the space to the left of the first period in the Primary DNS field, and then enter the first section of the IP address.

Note: Each section must be a number from 0 to 255.

3. Repeat step 2 for the second, third, and last sections of the Primary DNS field.
4. Repeat steps 2 and 3 for the Secondary DNS number.
5. Tap OK.

IP address

Everyone who logs on to the Internet needs to have a unique identifier (an IP address), whether permanent or temporary. Some networks dynamically assign a temporary IP address when clients log in. The IP Address field lets you identify whether your network provides automatic (dynamic) temporary IP addressing.

Note: If your IP address is permanently assigned, you need to get that information from your System Administrator. If you are not sure, select Automatic.

To identify dynamic IP addressing:

- Tap the IP Address check box to select it.

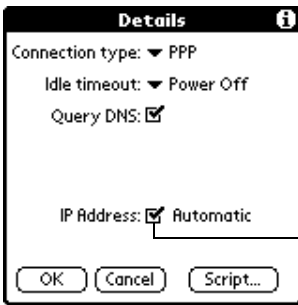

Tap to select automatic
IP address

To enter a permanent IP address:

1. Tap the IP Address check box to deselect it and display a permanent IP address field below the check box.
2. Tap the space to the left of the first period then enter the first section of the IP address.

Note: Each section must be a number from 0 to 255.

3. Tap and enter the remaining sections of the IP address.
4. Tap OK.

Creating a login script

A login script is a series of commands, similar to an autoexec.bat file, that automates logging into your ISP. You can create login script files by selecting commands from the Command pick list in the Login Script dialog. Some commands from the Command pick list, such as Send, require you to supply additional information. Those commands have a parameter field so that you can add the necessary data.

Note: You can also use non-ASCII and literal characters in your login script. See Appendix D for more information.

To create a login script:

1. Tap Script.
2. Tap the End pick list.

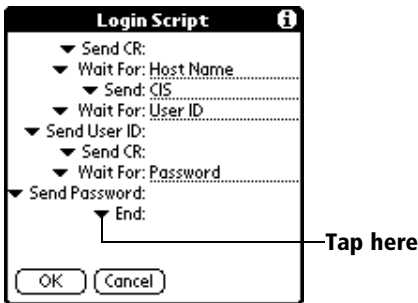

3. Tap the command you want from the Command list. If the command requires additional information, a field appears to the right of it for you to enter the information. The following commands are available:

Wait For	Tells your companion to wait for specific characters from the TCP/IP server before executing the next command.
Send	Transmits specific characters to the TCP/IP server to which you are connecting.
Send CR	Transmits a carriage return or LF character to the TCP/IP server to which you are connecting.

Send User ID	Transmits the User ID information entered in the User ID field of the Network Preferences screen.
Send Password	Transmits the password entered in the Password field of the Network Preferences screen. If you did not enter a password, this command prompts you to enter one. The Password command is usually followed by a Send CR command.
Delay	Tells your companion to wait a specific number of seconds before executing the next command in the login script.
Get IP	Reads an IP address and uses it as the IP address for your companion. This command is used with SLIP connections.
Prompt	Opens a dialog box and prompts you to enter text of some kind (for example, a password or a security code).
End	Identifies the last line in the login script.

4. Repeat steps 2 and 3 until the login script is complete.
5. Tap OK.

Deleting a service template

There is only one way to delete a service template: use the Delete command from the Service menu.

To delete a service template:

1. Tap the Service pick list.
2. Tap the service template you want to delete.
3. Tap the Menu icon .
4. Tap Service, and then tap Delete.
5. Tap OK.

Network preferences menu commands

The Network Preferences screen includes menu commands to make it fast and easy to create and edit service templates. TCP/IP application menus are show here for your reference.

See “Using menus” in Chapter 1 for more information about choosing menu commands.

Service menu

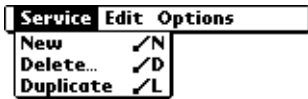

Options menu



TCP/IP troubleshooting

If you are having a problem establishing a network connection using TCP/IP, check this section and try the suggestions listed.

Displaying expanded Service Connection Progress messages

It is helpful to identify at what point in the login procedure the connection fails. An easy way to do this is to display the expanded Service Connection Progress messages. Expanded Service Connection Progress messages describe the current stage of the login procedure. Press the lower half of the scroll button at any point during login to display these messages.

Viewing the Network Log

If viewing the expanded Service Connection Progress messages does not give you enough information to find out why you cannot connect to your ISP or dial-in server, take a look at the Network Log. The Network Log lists all of the communication that occurs between your modem and your dial-in server during the login procedure. The information in the Network Log can help your ISP or your System Administrator pinpoint where the login procedure communication fails and why.

To view the Network Log:

1. Tap Options, and then tap View Log.
2. Tap the up and down arrows of the scroll bar to see the entire Network Log.
3. Tap Done.

Adding a DNS number

If your ISP or dial-in server requires a DNS number and you did not enter that information in the Network Preferences screen, it will appear that you successfully logged into your network. When you try to use an application or look up information, however, the connection fails. If this occurs, try adding a DNS number. Ask your ISP or your System Administrator for the correct Primary and Secondary DNS IP numbers.

Owner preferences

The Owner Preferences screen enables you to record a name, company name, phone number, or any other information that you want to associate with your companion.

If you use the Security application to turn off and lock your companion with a password, information that you put in the Owner Preferences displays the next time you turn on your companion. See Chapter 1 for more information.

To enter the Owner preferences:

- Enter the text that you want to associate with your companion in the Owner Preferences screen. If you enter more text than can fit on one screen, a scroll bar automatically appears on the right side of the screen.

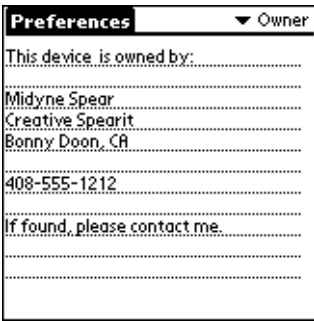

If you assign a password with the Security application, the information in the Owner Preferences screen cannot be changed. In this case, an Unlock button appears at the bottom of the screen.

To unlock the Owner Preferences screen:

1. Tap Unlock.
2. Enter the password that you defined in the Security application.
3. Tap OK.

ShortCuts preferences

The ShortCuts Preferences screen enables you to define abbreviations for entering text with Graffiti strokes. This section describes how to create, edit, and delete a ShortCut. See Chapter 2 for more information on the use of ShortCuts.

Creating a ShortCut

You can create a ShortCut for any words, letters, or numbers. All ShortCuts you create appear on the list in the ShortCut Preferences screen. All the ShortCuts are available in any of your companion applications and are backed up on your computer when you perform a HotSync operation.

To create a ShortCut:

1. Tap New.
2. On the ShortCut name line, enter the letters you want to use to activate the ShortCut.

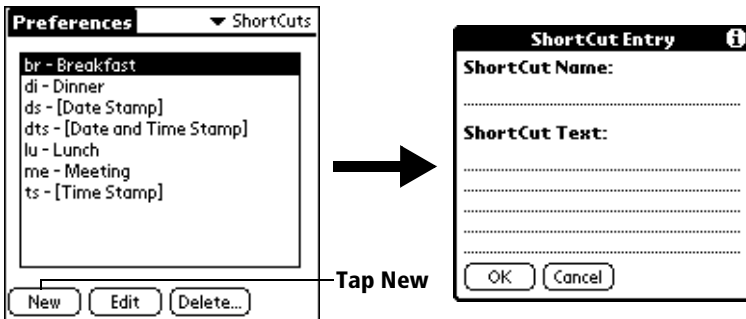

3. Tap the ShortCut Text area and enter the text that you want to appear when you write the ShortCut characters.

Tip: You may want to add a space (space character) after the last word in your ShortCut text. This way, a space automatically follows the ShortCut text.

4. Tap OK.

Tip: To use a ShortCut, draw the ShortCut stroke followed by the ShortCut characters. When you draw the ShortCut stroke, the ShortCut symbol appears at the insertion point to show that you are in ShortCut mode.

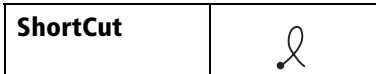

Editing a ShortCut

After you create a ShortCut, you can modify it at any time.

To edit a ShortCut:

1. Tap the ShortCut you want to edit.
2. Tap Edit.
3. Make the changes you want and tap OK.

Deleting a ShortCut

If you no longer need a ShortCut, you can delete it from the list of ShortCuts.

To delete a ShortCut:

1. Tap the ShortCut you want to delete.
2. Tap Delete.
3. Tap Yes.

Appendix A

Maintaining Your Companion

This chapter provides information on the following:

- Proper care of your companion
- Prolonging battery life
- Resetting your companion

Caring for your companion

Your companion is designed to be rugged and reliable and to provide years of trouble-free service. Please observe the following general tips when using your companion:

- Take care not to scratch the screen of your companion. Keep the screen clean. When working with your companion, use the supplied stylus or plastic-tipped pens intended for use with a touch-sensitive screen. Never use an actual pen or pencil or other sharp object on the surface of the companion screen.
- Your companion is not waterproof and should not be exposed to rain or moisture. Under extreme conditions, water may enter the circuitry through the front panel buttons. In general, treat your companion as you would a pocket calculator or other small electronic instrument.
- The touch-sensitive screen of your companion contains a glass element. Take care not to drop your companion or subject it to any strong impact. Do not carry your companion in your back pocket: if you sit on it, the glass may break.
- Protect your companion from temperature extremes. Do not leave your companion on the dashboard of a car on a hot day, and keep it away from heaters and other heat sources.
- Do not store or use your companion in any location that is extremely dusty, damp, or wet.
- Use a soft, damp cloth to clean your companion. If the surface of the companion screen becomes soiled, clean it with a soft cloth moistened with a diluted window-cleaning solution.

Battery considerations

Please note the following considerations for the battery in your companion:

- Under normal conditions, your companion battery should remain charged by placing it in the cradle for just a few minutes each day. You can conserve battery life by minimizing the use of the backlight feature, and changing the Auto-off setting that automatically turns the companion off after a period of inactivity. See “General preferences” in Chapter 7 for more information.
- If the batteries become low in the course of normal use, an alert appears on the companion screen describing the low battery condition. If this alert appears, perform a HotSync® operation to back up your data; then recharge the unit. This helps prevent accidental data loss.
- If the battery drains to the point where your companion does not operate, it stores your data safely for about a week. In this case, there is enough residual energy in the battery to store the data, but not enough to turn on your companion. If your companion does not turn on when you press the power button, you should recharge the unit immediately.
- If your battery drains and you have the unit in an uncharged state for an extended period of time, you can lose all of the stored data.
- There are no serviceable parts inside your companion, so do not attempt to open the unit. You never need to replace the battery, even if the charge runs out.
- If you ever dispose of your WorkPad c3 companion, please dispose of it without damaging the environment by depositing your companion at your nearest environmental recycling center.

Resetting your companion

Under normal circumstances, you will not have to use the reset button. On rare occasions, however, your companion may no longer respond to buttons or the screen. In this case, you need to perform a reset to get your companion running again.

Performing a soft reset

A soft reset tells your companion to stop what it is doing and start over again. All records and entries stored in your companion are retained with a soft reset. After a soft reset, the Welcome screen appears, followed by the General Preferences screen (to set time and date).

To perform a soft reset:

- Use the reset tip tool, or the tip of an unfolded paper clip (or similar object *without* a sharp tip), to gently press the reset button inside the hole on the back panel of your companion.

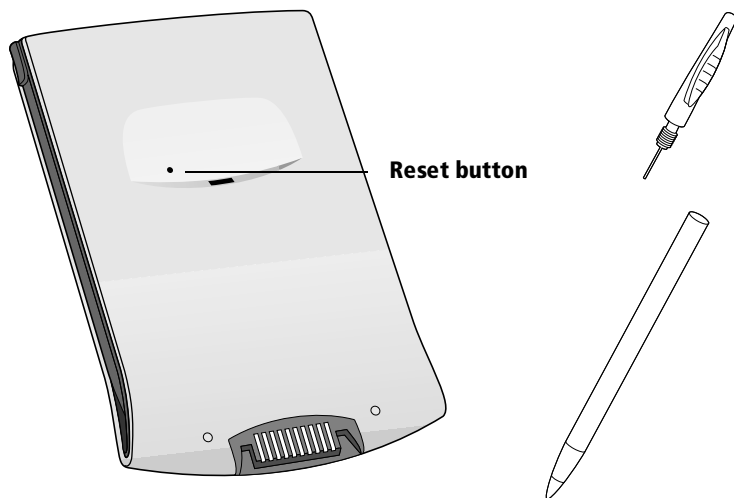

Tip: The metal and plastic stylus that comes with your companion has a reset tip inside. To use it, unscrew the metal barrel from the stylus quill.

Performing a hard reset

With a hard reset, all records and entries stored in your companion are erased. Never perform a hard reset unless a soft reset does not solve your problem.

Note: You can restore any data previously synchronized with your computer during the next HotSync operation.

To perform a hard reset:

1. Hold down the power button on the front panel of the companion.
2. While holding down the power button, use the tip of an unfolded paper clip (or similar object *without* a sharp tip) to gently press the reset button.
3. Release the power button.
4. When a message appears on the companion screen warning that you are about to erase all the data stored on your companion, do one of the following:

Press the upper half of the scroll button on the front panel of the companion to complete the hard reset and display the Digitizer screen.

Press any other button to perform a soft reset.

Note: With a hard reset, the current date and time are retained. Formats Preferences and other settings are restored to their factory default settings.

To restore your data after a hard reset:

1. Click the HotSync icon ™ in the Windows system tray (bottom-right corner of the taskbar).

Tip: You can also click the HotSync command on the Palm Desktop for IBM WorkPad menu bar.

2. From the HotSync Manager menu, choose Custom.

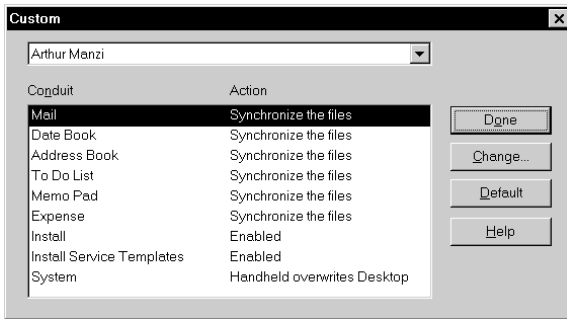

3. Select the appropriate user name from the list.
4. Select an application in the Conduit list.
5. Click Change.

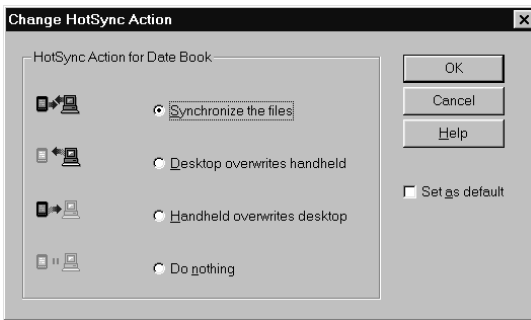

6. Select Desktop overwrites handheld.

Note: Changing the HotSync setting from the default affects only the *next* HotSync operation. Thereafter, the HotSync Actions revert to their default settings.

7. Click OK.
8. Repeat steps 4 through 7 to change conduit settings for other applications.
9. Click Done to activate your settings.
10. Perform a HotSync operation.

Appendix B

Frequently Asked Questions

If you encounter a problem with your WorkPad c3 companion, do not call Technical Support until you have reviewed the following list of frequently asked questions, and you have also reviewed the following:

- The README file and HelpNotes located in the folder where you installed the Palm™ Desktop for IBM WorkPad on your computer (or on your installation CD)
- The Palm Desktop for IBM WorkPad online Help
- The most recent WorkPad c3 companion HelpNotes on your regional web site

If you are still having problems, contact your local IBM HelpCenter for technical support. See “Product Registration and Getting Help by Telephone” later in this Appendix.

Note: Thousands of third-party add-on applications have been written for the Palm Computing® platform. Unfortunately, we are not able to support such a large number of third-party applications. *If you are having a problem with a third-party application, please contact the developer or publisher of that software.*

Software installation problems

Problem

When I install Palm Desktop for IBM WorkPad I get an error that a modem is attached to my serial port, but there is no modem attached.

Solution

Take your companion out of the cradle and install again.

Operating problems

Problem

Solution

My companion will not turn on.

Try each of these in turn:

- Press the contrast control button and adjust the contrast.
- Recharge the unit. If your companion still does not operate, try a soft reset. See “Resetting your companion” in Appendix A.

I get a warning message telling me my companion memory is full.

- Purge Date Book and To Do List. This deletes To Do List items and past Date Book events from the memory of your companion. See “Purging records” in Chapter 4. You may need to perform a HotSync® operation to recover the memory.
- Delete unused memos and records. If necessary, you can save these records. See “Deleting records” in Chapter 4.
- If you have installed additional applications on your companion, remove them to recover memory. See “Removing applications” in Chapter 3.

My companion keeps turning itself off.

Your companion is designed to turn itself off after a period of inactivity. This period can be set at one, two, or three minutes. Check the Auto-off setting. See “General preferences” in Chapter 7.

My companion is not making any sounds.

Check the System Sound setting. See “General preferences” in Chapter 7.

My companion has frozen.

Perform a soft reset. See “Resetting your companion” in Appendix A.

I do not see anything on my companion’s screen.

- Change the contrast settings.
- Check the battery power. If necessary, recharge the unit.

Tapping and writing problems

Problem

When I tap the buttons or screen icons, my companion activates the wrong feature.

When I tap the Menu icon , nothing happens.

I cannot get my companion to recognize my handwriting.

Solution

Calibrate the screen. See “Digitizer preferences” in Chapter 7.

Not all applications or screens have menus. Try changing to a different application.

- For your companion to recognize handwriting input with the stylus, you need to use Graffiti® writing. See “Using Graffiti writing to enter data” in Chapter 2.
- Make the Graffiti character strokes in the Graffiti writing area, not on the display part of the screen.
- Write Graffiti strokes for letters in the left-hand side, and the strokes for numbers in the right-hand side of the Graffiti writing area.
- Make sure that Graffiti is not shifted into extended or punctuation modes. See “Using Graffiti writing to enter data” in Chapter 2.
- See “Graffiti tips” in Chapter 2 for tips on increasing your accuracy when you write Graffiti characters.

Application problems

Problem

I tapped the Today button, but it does not show the correct date.

I know I entered some records, but they do not appear in the application.

I am having problems listing memos the way I want to see them.

I created an event in Date Book, but it does not appear in the Week View.

Solution

Your companion is not set to the current date. Make sure the Set Date box in the General Preferences screen displays the current date. See “General preferences” in Chapter 7 for more information.

- Check the Categories pick list (upper-right corner of the screen). Choose All to display all of the records for the application.
- Check Security and make sure that the Private Records setting is set to Show private records.
- In To Do List, tap Show and check whether Show Only Due Items is selected.
- If you cannot manually arrange the order of the memos in the List screen, check the Memo Preferences setting. Make sure that Sort by is set to Manual.
- If you choose to view your memos alphabetically on Palm Desktop for IBM WorkPad and then perform a HotSync operation, the memos on your companion still appear in the order defined in the Memo Preferences setting. In other words, the sort settings that you use with Palm Desktop for IBM WorkPad *are not* transferred to your companion.

In the Week View, you cannot select overlapping events that have the same start time. If you have two or more events with the same start time, choose the Day View for the particular day to see the overlapping events.

HotSync problems

Problem

Solution

I cannot do a HotSync operation; what should I check to make sure I am doing it correctly?

- Check the Windows system tray to make sure the HotSync Manager is running. If it is not, open Palm Desktop for IBM WorkPad.
- Click the HotSync Manager, choose Setup and click the Local tab. Check that the Serial Port setting displays the correct COM port where your cradle is attached.
- Make sure the cradle is connected securely.

I did a HotSync operation, but one of my applications did not synchronize.

- Click the HotSync Manager and choose Custom. Check that the correct conduit is active.

I am using Outlook as my PIM, but I cannot do a HotSync operation.

- Click the HotSync Manager and choose Custom. Check that the correct conduit is active.
- Check that the correct conduit is installed. Reinstall the HotSync Manager and make sure the correct conduit is selected.

I cannot launch the HotSync Manager.

- Make sure you are not running another program, such as America Online, CompuServe, or WinFax, that uses the serial port you selected in the Setup dialog box.
- Reinstall the Palm Desktop for IBM WorkPad.

I tried to do a local HotSync operation, but it did not complete successfully.

Try each of these in turn:

- Make sure HotSync Manager is running. If HotSync Manager is running, exit and restart it.
- Make sure you selected Local from the HotSync Manager menu or the Palm Desktop for IBM WorkPad menu.
- Check the cable connection between the cradle and the serial port on your computer.
- Make sure you selected the correct serial port on the Local tab in the Setup dialog. It should be set to the port where you connected the cradle.
- Try a lower baud rate setting on the Local tab in the Setup dialog.
- Make sure you are not running another program, such as America Online, CompuServe, or WinFax, that uses the serial port you selected in the Setup dialog box.
- Read the HotSync Log for the user account for which you are performing a HotSync operation.
- Make sure your companion is seated in the cradle correctly.
- Make sure the gold-plated connectors on the cradle and your companion are clean. Use a pencil eraser to clean them.

I tried to do a modem HotSync operation, but it did not complete successfully.

Check the following on your computer:

- Make sure your computer is turned on and that it does not shut down automatically as part of an energy-saving feature.
- Make sure the modem connected to your computer is turned on and is connected to the outgoing phone line.
- Make sure Modem is checked in the HotSync Manager menu.
- Make sure the modem has an on-off switch. Your companion cannot “wake up” a modem with an auto-off feature.
- Make sure the modem is connected properly to a serial port on your computer and is connected to the incoming phone line.
- Confirm that the Setup String in the Setup dialog box configures your modem correctly. You may need to select a different Modem Type or enter a custom Setup String. Most modems have a Setup String that causes them to send initial connection sounds to a speaker. You can use these sounds to check the modem connection.
- Confirm that the Speed setting in the Setup dialog box works for your modem.
- If you have problems using the As Fast As Possible option or a specific speed, try using a slower speed.
- Make sure you are not running another program, such as America Online, CompuServe, or WinFax, that uses the serial port you selected in the Setup dialog box.
- Make sure your modem resets before you try again. (Turn off your modem, wait a minute, then turn it back on.)

I tried to do a modem HotSync operation, but it did not complete successfully.
(continued)

Check the following on your companion:

- Confirm that the telephone cable is securely attached to your modem.
- Make sure the dialing instruction dials the correct phone number.
- If you need to dial an outside line prefix, make sure you selected the Dial Prefix option on your companion and entered the correct code.
- If the telephone line you are using has Call Waiting, make sure you selected the Disable call waiting option under Modem Sync Phone Setup on your companion and entered the correct code.
- Make sure the telephone line you are using is not noisy, which can interrupt communications.
- Check the batteries in your modem and replace them if necessary.

Beaming problems

Problem

I cannot beam data to another WorkPad PC companion.

Solution

- Confirm that your WorkPad companion and the other WorkPad companion are between ten centimeters (approximately 4") and one meter (approximately 39") apart, and that the path between the two devices is clear of obstacles. Beaming distance to other WorkPad PC companions may be different.
- Move your companion closer to the receiving device.
- Perform a soft reset. See "Performing a soft reset" in Appendix A for more information.

When someone beams data to my companion, I get a message telling me it is out of memory.

- Your companion requires at least twice the amount of memory available as the data you are receiving. For example, if you are receiving a 30K application, you must have at least 60K free.
- Perform a soft reset. See "Performing a soft reset" in Appendix A for more information.

Recharging problems

Problem

When I place my WorkPad companion in the cradle, the cradle light does not go on.

Solution

- Confirm that your companion is well seated in the cradle.
- Confirm that your recharger cable is properly connected to the back of the cradle's serial (COM) port connector that plugs into your computer.
- Confirm that your recharger is plugged into an AC outlet and that the AC outlet has power.

Password problems

Problem

I forgot the password, and my companion is not locked.

Solution

You can use Security to delete the password. If you do this, your companion deletes all entries marked as private. You can, however, perform a HotSync operation *before* you delete the password: the HotSync process backs up all entries, whether or not they are marked private. In this case, the following procedure restores your private entries and lets you access them:

1. Use the Palm Desktop for IBM Work-Pad and the cradle to synchronize your data.
2. Tap Forgotten Password in Security to remove the password and delete all private records.
3. Perform a HotSync operation to synchronize your data and restore the private records by transferring them from your computer to your companion.

I forgot the password and my companion is locked.

- If you assign a password and lock your companion, you must perform a hard reset to continue using your companion. See “Performing a hard reset” in Appendix A for more information.

Getting Help, Service, and Information

If you need help, service, technical assistance, or just want more information about IBM products, you will find a wide variety of sources available from IBM to assist you.

See the IBM WorkPad Home Page at:
<http://www.pc.ibm.com/workpad>.

Help is also available from bulletin boards and online services, as well as by fax and telephone. This section provides information about these sources. Services available and telephone numbers listed are subject to change without notice.

Hardware Warranty Summary

When you purchase an IBM hardware product, you get comprehensive warranty coverage. During the IBM hardware product warranty period, you may call the IBM HelpCenter for hardware product assistance. See “Product Registration and Getting Help by Telephone” later in this Appendix for a list of numbers.

Be sure to retain your proof of purchase to obtain warranty service. For additional information, refer to the IBM warranty statement included with your product or available from your reseller.

Before You Call for Service



Many problems can be solved without outside assistance, by using the online help or by reviewing the online or printed documentation supplied with your WorkPad. If you suspect a software problem, consult the documentation (including README files) for the operating system or application program.

If, after reviewing these sources, you cannot solve your problem, call your regional IBM HelpCenter.

Before requesting support, please experiment a bit to reproduce and isolate the problem. When you do contact support, please be ready to provide the following information:

- The name and version of the operating system you are using
- The actual error message or state you are experiencing
- The steps you take to reproduce the problem
- The version of Palm Desktop software for IBM WorkPad software you are using and available memory on the device

To find version and memory information:

1. Tap the Applications icon .
2. Tap the Menu icon .
3. Tap App, and then tap Info.

Note: Thousands of third-party add-on applications have been written for the Palm Computing platform. Unfortunately, we are not able to support such a large number of third-party applications. *If you are having a problem with a third-party application, please contact the developer or publisher of that software.*

4. Tap Version to see version numbers, and tap Size to see the amount of free memory, in kilobytes.

Getting Customer Support and Service

Purchasing an IBM product entitles you to standard help and support during the warranty period. If you need additional support and services, a wide variety of extended services are available for purchase that address almost any need.

Purchasing Additional Services

During and after the warranty period, you can purchase additional services, such as support for IBM and non-IBM hardware, operating systems, and application programs; network setup and configuration; upgraded or extended hardware repair services; and custom installations. Service availability and name might vary by country.

Product Registration and Getting Help by Telephone

To register your WorkPad and to receive your personalized registration number prior to receiving technical support, refer to the Registration Number listing below.

For direct access to technical support during your entitlement period, have your personalized registration number available and refer to the Support Number provided to you when you registered. Expert technical-support representatives are available to assist you with questions you have. These services are available 24 hours a day, 7 days week. Response time will vary depending on the number and complexity of incoming calls.

Country Name	Phone Number	Language	Hours	Days
ASIA PACIFIC				
Australia	131-426	English	7:00AM-6:00PM	Monday - Friday
New Zealand	0800-472-435	English	9:00AM-5:00PM	Monday - Friday
Japan	0120-141-666	Japanese	10:00AM-6:00PM	7 days/week
CANADA				
Canada	800-565-3344	English	24 hours/day	7 days/week
	800-565-3344	French	24 hours/day	7 days/week
EUROPE				
Austria	01-54658-5075	German	9:00AM-6:00PM	Monday - Friday
Belgium	02-717-2504	Dutch	9:00AM-6:00PM	Monday - Friday
	02-717-2503	French	9:00AM-6:00PM	Monday - Friday
Denmark	3-525-6905	Danish	9:00AM-6:00PM	Monday - Friday
Finland	9-22-931805	Finnish	9:00AM-6:00PM	Monday - Friday
France	01-6932-4003	French	9:00AM-6:00PM	Monday - Friday
Germany	069-6654-9003	German	9:00AM-6:00PM	Monday - Friday
Ireland	01-815-9207	English	9:00AM-6:00PM	Monday - Friday
Italy	02-482-75003	Italian	9:00AM-6:00PM	Monday - Friday
Luxembourg	298-977-5060	French	9:00AM-6:00PM	Monday - Friday
Netherlands	020-504-0531	Dutch	9:00AM-6:00PM	Monday - Friday
Norway	2-305-3203	Norwegian	9:00AM-6:00PM	Monday - Friday
Portugal	01-791-5147	Portuguese	9:00AM-6:00PM	Monday - Friday
Spain	91-662-4270	Spanish	9:00AM-6:00PM	Monday - Friday
Sweden	08-632-0063	Swedish	9:00AM-6:00PM	Monday - Friday
Switzerland	01-212-1810	German	9:00AM-6:00PM	Monday - Friday
	022-310-0418	French	9:00AM-6:00PM	Monday - Friday
	091-971-0523	Italian	9:00AM-6:00PM	Monday - Friday
United Kingdom	01475-555555	English	9:00AM-6:00PM	Monday - Friday
LATIN AMERICA				
Argentina	717-4357	Spanish	9:00AM-6:00PM	Monday - Friday
Bolivia	(591-2) 361-555	Spanish	8:00AM-5:00PM	Monday - Friday
Brazil	55-11-889-8986	Portuguese	8:00AM-10:00PM	Monday - Friday
Chile	800-20-3300	Spanish	8:00AM-5:00PM	Monday - Friday
Colombia	623-2300(local) 9-800-18811	Spanish	8:00AM-10:00PM 8:00AM-4:00PM	Monday - Friday Saturday
Costa Rica	506-233-6222	Spanish	8:00AM-5:00PM	Monday - Friday

Country Name	Phone Number	Language	Hours	Days
Ecuador	(2) 565-130	Spanish	8:30AM-6:00PM	Monday - Friday
El Salvador	503-298-5011	Spanish	8:00AM-12:00PM 1:30PM-5:30PM	Monday - Friday
Guatemala	502-331-5859	Spanish	8:00AM-5:00PM	Monday - Friday
Honduras	504-332-2319	Spanish	8:00AM-5:00PM	Monday - Friday
Mexico	387-5991(local) 01-800-426-1000	Spanish	8:00AM-8:00PM	Monday - Friday
Nicaragua	505-266-4141	Spanish	8:00AM-5:00PM	Monday - Friday
Panama	507-263-9977	Spanish	8:00AM-5:00PM	Monday - Friday
Peru	349-0050	Spanish	8:30AM-8:30PM	Monday - Friday
Rep. Dominican	809-556-5161	Spanish	8:00AM-5:00PM	Monday - Friday
Venezuela	800-426-72	Spanish	8:00AM-5:00PM	Monday - Friday
UNITED STATES				
United States	800-772-2227	English	24 hours/day	7 days/week
Puerto Rico	800-772-2227	English	24 hours/day	7 days/week

Appendix C

Creating a Custom Expense Report

This section explains how to modify existing Expense application templates and how to create your own custom expense report templates for use with the Expense application.

Note: This section assumes that you are familiar with Microsoft Excel or a similar spreadsheet application. If you are not familiar with Microsoft Excel, consult your company's Information Services department or another experienced user.

About mapping tables

Before creating or modifying an Expense template, it is important to understand the Palm™ Desktop for IBM WorkPad Expense application. In simple terms, the Expense application moves Expense data from your companion to a Microsoft Excel spreadsheet.

Each Expense item in your companion represents a group of related data. You can associate the following data with an expense item:

- Category
- Date
- Expense Type
- Amount
- Payment Method
- Payment Currency
- Vendor
- City
- Attendees
- Note

When you perform a HotSync® operation between your companion and Palm Desktop for IBM WorkPad, the Expense data is stored on your computer (in a file named Expense.txt). When you open the Expense application in Palm Desktop for IBM WorkPad, an Excel macro starts, and populates an expense template with your data based on the rules specified in a spreadsheet file named Mappable.xls.

The Mappable.xls file is an editable spreadsheet that functions as a "mapping table." The function of the mapping table is to guide the Excel macro in extracting the Expense data. The mapping table tells the Excel macro how large the spreadsheet is and provides the data-cell layout of the Excel template used for the Expense Report.

Customizing existing sample templates

Four sample Expense Report templates come with Palm Desktop for IBM WorkPad. These templates are stored in the Template folder (which is in the same folder as the Palm Desktop for IBM WorkPad application).

If the layout of one (or more) of these templates is appropriate for your reporting needs, you can easily customize the templates with your company name and other information.

To customize a sample Expense Report template:

1. Make a backup copy of the contents of the Template folder.

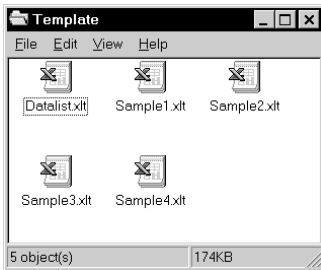

2. Double-click the name of the sample template you want to modify to open it in Microsoft Excel.
3. Make any changes that you want to the names (or other information) in the sample template.

Important: *Do not* insert rows or columns in the sample template. Doing so changes the way your Expense data maps to the template and causes errors. If you want to move the cells to a different location or add or delete rows or columns, you have to make changes to the Mappable.xls file.

Note: You can insert your own company logo without changing the Mappable.xls file. If you change the file name, however, you need to make a corresponding change in the Mappable.xls file.

You can also rename cells without changing the Mappable.xls file, provided that the expense type corresponds to your companion data. For example, you can change "Snack" to "Munchies," and then all items entered on your companion as "Snack" map to the cell(s) labeled "Munchies."

4. From the File menu, choose Save As.
5. Click the Save as type drop-down list and choose Template (*.xlt).
6. Navigate to the Template folder (in the Palm Desktop for IBM WorkPad directory).

Note: If you *do not* need to change the Mappable.xls file, save the template file with its *original file name* (e.g., Sample2.xlt).

If you *do* need to change the Mappable.xls file, give your modified template a unique name. Be sure to use the .xlt file suffix, which defines the file as a Microsoft Excel template.

7. Click Save to save your modified template and make it available for future use.

Note: If you need to modify the Mappable.xls file, you must do this before you can use the modified template with your Expense data. To modify the Mappable.xls file for your new template, see “Programming the mapping table” later in this appendix. *Read all of the sections of this appendix before making changes to the Mappable.xls file.*

Determining the layout of the Expense Report

This section describes the layout considerations for the Expense Report and explains the terms used for creating the report.

Labels

There are two kinds of labels that you need to define for your report: day/date and expense type. Each kind of label can be either Fixed or Variable. A Fixed label means that the label *always* appears as a header at the beginning of a row or column. If a label is not Fixed, it is variable.

For example, a list table of expenses could have variable labels in the rows for day/date, and variable labels in the columns for expense type. In this case, neither day/date or expense type information would be “fixed” (as a header). Instead, the date and expense type information would be filled into the cells of the spreadsheet as appropriate.

Examples of both Fixed and Variable labels appear in the sample expense templates.

Sections

A Section is an area of the report that has common formatting. It is common for an Expense report to have more than one Section. For example, the following sample Expense Report named Sample3.xlt contains several Sections.

File Edit View Insert Format Tools Data Window Help									
1	2	3	4	5	6	7	8	9	10
				Employee			Emp. #	Dept.	Project
Expense Report									
ITINERARY			DATE						
			CITY						
			CITY						
M E A L S	Breakfast	Employee paid							
		Company paid							
		Employee paid							
	Lunch & Snack	Company paid							
		Employee paid							
	Dinner	Company paid							
		Employee paid							
	Business meals & entertainment	Company paid							
		Employee paid							
	Conference	Company paid							
M I S C	Postage	Company paid							
		Employee paid							
	Parking & Tolls	Company paid							
		Employee paid							
	Gifts, Tips, Suppl	Company paid							
	Incidentals, Other	Employee paid							
BUSINESS MEALS AND ENTERTAINMENT EXPENDITURES									
	Date	Expense Type	Amount	Vendor	City				

Section 1 (not prepaid)
Section 2 (prepaid)
Section 3

Because your Expense data maps to row and column areas of your final report, different Sections require different definitions for the data mapping. To create additional Sections with different mapping, you create corresponding additional lines to the mapping table file named Maptable.xls. This procedure is explained later in this appendix.

If a section contains cells for prepaid (company paid) expenses, you need to create an additional line in the mapping table for “prepaid.” This will count as an additional section in the mapping table. The only data that differs in the prepaid section (from the non-prepaid section) is the row/column numbers for the expense type.

Analyzing your custom Expense Report

If you already have a custom Excel expense report, you can use it with a modified mapping table. However, before you can create a Mappable.xls file that corresponds to your custom Expense Report, you must first analyze the characteristics of your report.

Perform the following before you begin a custom mapping table:

- Print a copy of your custom expense report. Activate the Row and Column Headings option in the Sheet settings of the Page Setup command. This enables you to quickly determine the size of the Section(s), as well as the numbers for the start rows and columns.
- On the printed copy, identify the data Sections. A Section is an area of data with common row and column formatting. A yellow highlighter marking pen can make it easy to see the Sections as you work with programming the mapping table. Your custom Expense Report can contain any number of Sections, and the same data can be repeated in any Section.
- On the printed copy, identify the type of Labels that apply to each Section. Each Section can have only one kind of Fixed or Variable Label for rows. Likewise, each Section can have only one kind of Fixed or Variable Label for columns.
- Place a copy of your custom Expense Report in the Template folder (in the Palm Desktop for IBM WorkPad directory). Change the file name so it has the file extension .xlt (which defines it as a Microsoft Excel template). Make a note of the exact file name so it can be defined in the mapping table file.

Programming the mapping table

Once you have analyzed the components of your custom Expense Report, you can program the mapping table to fill the report with data from the companion.

To program a new custom mapping table:

1. Open a copy of the Maptable.xls file in Microsoft Excel.

Note: This file is located in the same folder as the Palm Desktop for IBM WorkPad application. *Make a backup copy of this file before you make your modifications.*

2. **Mapping a new template.** Scroll to where you find the name of the original template that you chose for your modifications. The name of the template will appear in column B of the Maptable.xls file, next to the cell highlighted in green that reads "Template Name:". If you did not modify an existing template, move to any table in the Maptable.xls file.
3. Select all the *rows* associated with the template name. To select the rows, click and drag on the row numbers (left side), so they appear highlighted.

	1	2	3	4	5
5	Template Name:	SAMPLE1.XLT			
6		ROW			
7		Fixed Label		Variable Label by	
8		Day/Date	Expense Type	Day/Date	Expense Type
9	Section1			X	
10					
11					
12					
13	Template Name:	SAMPLE2.XLT			
14		ROW			
15		Fixed Label		Variable Label by	
16		Day/Date	Expense Type	Day/Date	Expense Type
17	Main		X		
18	Business&Entertainment			X	
19					
20					
21					
22	Template Name:	SAMPLE3.XLT			
23		ROW			
24		Fixed Label		Variable Label by	
25		Day/Date	Expense Type	Day/Date	Expense Type
26	Main (PREPAID)		X		
27	Main		X		

All rows related to template are selected

4. From the Edit menu, choose Copy.

5. Scroll down to a blank area of the Mappable.xls file (below the rows used for Sample4.xls), and click on a row number to select a blank row.
6. From the Edit menu, choose Paste. A copy of the rows you selected in step 3 is pasted into the Mappable.xls file.
7. **Name the table.** In the cell immediately to the right of the cell entitled Template Name, enter the *exact* file name of your custom Expense Report template.
8. **Define the number of Sections.** Each row in a table defines how your companion data will be placed in a Section of your custom Expense Report. Note that the prepaid portion of a section has its own row and counts as a separate section for map table purposes, *even though it is not a separate section in your template.*

22	Template Name:	SAMPLE3.XLT	
23			ROW
24		Fixed Label	
25		Day/Date	Expense Type
26	Main (PREPAID)		X
27	Main		X
28	Business Meals & Entertainment		
29	Mileage Log		

Table with four sections

You may add or delete rows as necessary so that the total number of rows corresponds to the number of Sections in your custom Expense Report. To clear all of the existing settings in a row, click to select the row and press Ctrl+Delete. Name each row to correspond to a Section of your custom Expense Report.

9. **Determine the Label settings.** The orientation of the data fields (Row, Column) appears in the yellow section of the table.

SAMPLE1.XLT		ROW				COLUMN			
Fixed Label		Variable Label by		Fixed Label		Variable Label by			
Day/Date	Expense Type	Day/Date	Expense Type	Day/Date	Expense Type	Day/Date	Expense Type		
		X					X		

Determine whether the **Rows** will contain expense or date information, and place an “x” in the appropriate cell. When you do this, you also define whether the label is Fixed or Variable. You can place only one “x” in the Row section (columns 2–5).

Determine whether the **Columns** will contain expense or date information, and place an “x” in the appropriate cell. When you do this, you also define whether the label is Fixed or Variable. You can place only one “x” in the Column section (columns 6–9).

10. **Define the dimensions of the Section.** The dimensions of the Section appear in the green columns (10–13).

# of Rows	# of Columns	Start Row	Start Column
36		12	1

of Rows Represents the total number of rows in the Section, excluding any header or total rows. In other words, this includes only the number of rows in the Section where your companion data will be placed.

of Columns Represents the total number of columns in the Section, excluding any header or total columns. In other words, this includes only the number of columns in the Section where your companion data will be placed.

Start Row Is the number of the first row of the Section that will be filled with your companion data.

Start Column Is the number of the first column of the Section that will be filled with your companion data.

11. **Define the Dates and Intervals.** The dates and intervals between dates appears in the light blue columns (14–17).

Date	Intervals		
Date	Dates	Start day	Day
1	0		

In the **Date** cell, enter the row or column number where all the date information will be placed.

In the **Dates** cell, enter the number of blank columns (or rows) separating the date fields. If there are no blank columns (or rows) between date entries, leave this number set to zero.

In the **Start Day** cell, enter the day of the week that starts the expense reporting period. Enter a three-character abbreviation for the day (e.g., Sun, Mon, Tue).

In the **Day** cell, enter the row or column number where all the day information will be placed. If the dates are in a row, enter the row number. If the dates are in a column, enter the column number.

12. **Define whether the Section is in list format.** This setting appears in the light purple columns (18–19).

Listing Format	Expense Type
YES	8

If the Section will present the data in a list format, enter the word “yes”. Otherwise, enter the word “no”. The following diagram shows data presented in a list format:

6	Date	Category	Type	Amount	Country	Payment Type
7						
8						
9						
10						
11						

Only if your section is in list format: In the Expense Type cell, enter the number of the row or column where the expense description will be placed. Expense amounts can be entered in several different columns or rows if required by your template. *Expense type labels* must all appear in the same column.

13. **Enter the row or column numbers for the expense types that appear in the Section.** These settings appear in the aqua columns (20–48).

Expense Types					
Airfare	Breakfast	Bus	Business Meals	Car Rental	Dinner
4	4	4	4	4	4

For these settings, simply enter the row or column number for the expense types you want to appear in the Section. Note that the same row or column number can be used more than once. An example would be meals that encompass breakfast, lunch, dinner, and snacks. In the previous example, all expense items would be populated into row/column 4 of the custom Expense Report.

14. **Complete the table.** The remaining columns (49–57) are used to define the column or row number that corresponds to the description.
15. **Mark a Section for prepaid expenses (yellow column).** If a row in the map table is for prepaid (company paid) expenses, type a “yes” in the cell on that Section’s row. Type “no” in all the cells of this column that do not pertain to prepaid expenses.

57
PrePaid
NO
YES
NO

16. Repeat steps 9 through 15 for each Section that you have defined for your custom Expense Report.
17. **Map Expense Report Options dialog (magenta section).** The Expense Report Options dialog has five fields where you can fill in data for the header on your expense report. Use this section to specify the row and column on your template where this information will be mapped.

Employee Name		Department	
Header1Row	Header1Col	Header2Row	Header2Col
2	5	2	9

Because header data is not related to any particular Section, you have to fill in only one row. If the item does not appear on your template, leave these cells blank.

Using applications other than Microsoft Excel

You can use applications other than Microsoft Excel (such as Lotus 1-2-3 or Quattro Pro) to open and manipulate the Expense data on your computer. The data file is named "Expense.txt," and is stored in the Expense folder, within the folder containing the companion user data.

Expense data in the Expense.txt file is in tab-delimited format.

Expense file details

The Expense.txt file contains four groups of data. It will be easier to see these four distinct groups of data if you open the file with a spreadsheet application.

- Trips** Shows the number of Expense application categories, and lists each one followed by an "end" statement.
- Currency** Shows how many currencies were used for the Expense data, and lists the countries that correspond to that currency.
- Trip** Shows the number of expenses by category, and lists the expenses for each category.
- Expenses** Shows the total number of expenses, and lists them chronologically.

Appendix D

Non-ASCII Characters for Login Scripts

The following information enables you to create custom login scripts that require non-ASCII characters. It is provided for advanced users who understand the use and requirements of such characters in a custom login script.

Use of ^char

You may use the caret (^) to transmit ASCII command characters. If you send ^*char*, and the ASCII value of *char* is between @ and _, then the character is automatically translated to a single-byte value between 0 and 31.

For example, ^M is converted to a carriage return. If *char* is a value between a and z, then the character sequence is translated to a single-byte value between 1 and 26. If *char* is any other value, then the character sequence is not subject to any special processing.

For example, the string "Joe^M" transmits Joe, followed by a carriage return.

Carriage return and line feed

You may include carriage return and line feed commands as part of the login script, when entered in the following format:

<cr>	Sends or receives a carriage return
<lf>	Sends or receives a line feed

For example, the string "waitfor Joe<cr><lf>" waits to receive Joe followed by a carriage return and line feed from the remote computer before executing the next command in the script.

Literal characters

The backslash (\) character defines that the *next character* is transmitted as a literal character, and is not subject to any special processing ordinarily associated with that character.

Examples:

- \^ Includes a caret as part of the string
- \< Includes a < as part of the string
- \\ Includes a backslash as part of the string

Warranty and Other Product Information

Product warranties

The following product warranties are included in this handbook.

- IBM U.K. Statement of Warranty
- IBM U. S., Canada, and Puerto Rico Statement of Limited Warranty

Additional translations of the product warranties are included on the Palm™ Desktop software for IBM WorkPad CD-ROM. Refer to the Documentation folder on the CD-ROM for these warranties.

IBM U.K. Statement of Warranty

Part 1 - General Terms

This Statement of Warranty includes Part 1 - General Terms and Part 2 - Country-unique Terms. **The terms of Part 2 may replace or modify those of Part 1.** The warranties provided by IBM in this Statement of Warranty apply only to Machines you purchase for your use, and not for resale, from IBM or your reseller. The term "Machine" means an IBM machine, its features, conversions, upgrades, elements, or accessories, or any combination of them. The term "Machine" does not include any software programs, whether pre-loaded with the Machine, installed subsequently or otherwise. Unless IBM specifies otherwise, the following warranties apply only in the country where you acquire the Machine. Nothing in this Statement of Warranty affects any statutory rights of consumers that cannot be waived or limited by contract. If you have any questions, contact IBM or your reseller

MACHINE - WorkPad c3

WARRANTY PERIOD* - One (1) Year

*Contact your place of purchase for warranty service information. Some IBM Machines are eligible for On-site warranty service depending on the country where service is performed.

The IBM Warranty For Machines

IBM warrants that each Machine 1) is free from defects in materials and workmanship and 2) conforms to IBM's Official Published Specifications. The warranty period for a Machine is a specified, fixed period commencing on its Date of Installation. The date on your sales receipt is the Date of Installation, unless IBM or your reseller informs you otherwise.

During the warranty period IBM or your reseller, if approved by IBM to provide warranty service, will provide repair and exchange service for the Machine, without charge, under the type of service designated for the Machine and will manage and install engineering changes that apply to the Machine.

If a Machine does not function as warranted during the warranty period, and IBM or your reseller are unable to either 1) make it do so or 2) replace it with one that is at least functionally equivalent, you may return it to your place of purchase and your money will be refunded. The replacement may not be new, but will be in good working order.

Extent of Warranty

The warranty does not cover the repair or exchange of a Machine resulting from misuse, accident, modification, unsuitable physical or operating environment, improper maintenance by you, or failure caused by a product for which IBM is not responsible. The warranty is voided by removal or alteration of Machine or parts identification labels.

THESE WARRANTIES ARE YOUR EXCLUSIVE WARRANTIES AND REPLACE ALL OTHER WARRANTIES OR CONDITIONS, EXPRESS OR IMPLIED, INCLUDING, BUT NOT LIMITED TO, THE IMPLIED WARRANTIES OR CONDITIONS OF MERCHANTABILITY AND FITNESS FOR A PARTICULAR PURPOSE. THESE WARRANTIES GIVE YOU SPECIFIC LEGAL RIGHTS AND YOU MAY ALSO HAVE OTHER RIGHTS WHICH VARY FROM JURISDICTION TO JURISDICTION. SOME JURISDICTIONS DO NOT ALLOW THE EXCLUSION OR LIMITATION OF EXPRESS OR IMPLIED WARRANTIES, SO THE ABOVE EXCLUSION OR LIMITATION MAY NOT APPLY TO YOU. IN THAT EVENT, SUCH WARRANTIES ARE LIMITED IN DURATION TO THE WARRANTY PERIOD. NO WARRANTIES APPLY AFTER THAT PERIOD.

Items Not Covered by Warranty

IBM does not warrant uninterrupted or error-free operation of a Machine.

Unless specified otherwise, IBM provides non-IBM machines **WITHOUT WARRANTIES OF ANY KIND**.

Any technical or other support provided for a Machine under warranty, such as assistance via telephone with "how-to" questions and those regarding Machine set-up and installation, will be provided **WITHOUT WARRANTIES OF ANY KIND**.

Warranty Service

To obtain warranty service for the Machine, contact your reseller or IBM. You may be required to present proof of purchase.

IBM or your reseller provides certain types of repair and exchange service, either at your location or at a service centre, to keep Machines in, or restore them to, conformance with their Specifications. IBM or your reseller will inform you of the available types of service for a Machine based on its country of installation. IBM may repair the failing Machine or exchange it at its discretion.

When warranty service involves the exchange of a Machine or part, the item IBM or your reseller replaces becomes its property and the replacement becomes yours. You represent that all removed items are genuine and unaltered. The replacement may not be new, but will be in good working order and at least functionally equivalent to the item replaced. The replacement assumes the warranty service status of the replaced item.

Any feature, conversion, or upgrade IBM or your reseller services must be installed on a Machine which is 1) for certain Machines, the designated, serial-numbered Machine and 2) at an engineering-change level compatible with the feature, conversion, or upgrade. Many features, conversions, or upgrades involve the removal of parts and their return to IBM. A part that replaces a removed part will assume the warranty service status of the removed part.

Before IBM or your reseller exchanges a Machine or part, you agree to remove all features, parts, options, alterations, and attachments not under warranty service.

You also agree to

1. ensure that the Machine is free of any legal obligations or restrictions that prevent its exchange;

2. obtain authorisation from the owner to have IBM or your reseller service a Machine that you do not own; and
3. where applicable, before service is provided
 - a. follow the problem determination, problem analysis, and service request procedures that IBM or your reseller provides,
 - b. secure all programs, data, and funds contained in a Machine,
 - c. provide IBM or your reseller with sufficient, free, and safe access to your facilities to permit them to fulfil their obligations, and
 - d. inform IBM or your reseller of changes in a Machine's location.

IBM is responsible for loss of, or damage to, your Machine while it is 1) in IBM's possession or 2) in transit in those cases where IBM is responsible for the transportation charges.

Neither IBM nor your reseller is responsible for any of your confidential, proprietary or personal information contained in a Machine which you return to IBM or your reseller for any reason. You should remove all such information from the Machine prior to its return.

Production Status

Each IBM Machine is manufactured from new parts, or new and used parts. In some cases, the Machine may not be new and may have been previously installed. Regardless of the Machine's production status, IBM's appropriate warranty terms apply.

Limitation of Liability

Circumstances may arise where, because of a default on IBM's part or other liability, you are entitled to recover damages from IBM. In each such instance, regardless of the basis on which you are entitled to claim damages from IBM (including fundamental breach, negligence, misrepresentation, or other contract or tort claim), IBM is liable for no more than

1. damages for bodily injury (including death) and damage to real property and tangible personal property; and
2. the amount of any other actual direct damages, up to the greater of U.S. \$100,000 (or equivalent in local currency) or the charges (if recurring, 12 months' charges apply) for the Machine that is the subject of the claim.

This limit also applies to IBM's suppliers and your reseller. It is the maximum for which IBM, its suppliers, and your reseller are collectively responsible.

UNDER NO CIRCUMSTANCES IS IBM LIABLE FOR ANY OF THE FOLLOWING: 1) THIRD-PARTY CLAIMS AGAINST YOU FOR DAMAGES (OTHER THAN THOSE UNDER THE FIRST ITEM LISTED ABOVE); 2) LOSS OF, OR DAMAGE TO, YOUR RECORDS OR DATA; OR 3) SPECIAL, INCIDENTAL, OR INDIRECT DAMAGES OR FOR ANY ECONOMIC CONSEQUENTIAL DAMAGES (INCLUDING LOST PROFITS OR SAVINGS), EVEN IF IBM, ITS SUPPLIERS OR YOUR RESELLER IS INFORMED OF THEIR POSSIBILITY. SOME JURISDICTIONS DO NOT ALLOW THE EXCLUSION OR LIMITATION OF INCIDENTAL OR CONSEQUENTIAL DAMAGES, SO THE ABOVE LIMITATION OR EXCLUSION MAY NOT APPLY TO YOU.

IBM U.K. Statement Of Warranty

Part 2 - Country-unique Terms

ASIA PACIFIC

AUSTRALIA: The IBM Warranty for Machines: The following paragraph is added to this Section: The warranties specified in this Section are in addition to any rights you may have under the Trade Practices Act 1974 or other legislation and are only limited to the extent permitted by the applicable legislation.

Extent of Warranty: The following replaces the first and second sentences of this Section: The warranty does not cover the repair or exchange of a Machine resulting from misuse, accident, modification, unsuitable physical or operating environment, operation in other than the Specified Operating Environment, improper maintenance by you, or failure caused by a product for which IBM is not responsible.

Limitation of Liability: The following is added to this Section:

Where IBM is in breach of a condition or warranty implied by the Trade Practices Act 1974, IBM's liability is limited to the repair or replacement of the goods or the supply of equivalent goods. Where that condition or warranty relates to right to sell, quiet possession or clear title, or the goods are of a kind ordinarily acquired for personal, domestic or household use or consumption, then none of the limitations in this paragraph apply.

PEOPLE'S REPUBLIC OF CHINA: Governing Law: The following is added to this Statement:

The laws of the State of New York govern this Statement.

INDIA: Limitation of Liability: The following replaces items 1 and 2 of this Section:

1. liability for bodily injury (including death) or damage to real property and tangible personal property will be limited to that caused by IBM's negligence; 2. as to any other actual damage arising in any situation involving nonperformance by IBM pursuant to, or in any way related to the subject of this Statement of Warranty, IBM's liability will be limited to the charge paid by you for the individual Machine that is the subject of the claim.

NEW ZEALAND: The IBM Warranty for Machines: The following paragraph is added to this Section:

The warranties specified in this Section are in addition to any rights you may have under the Consumer Guarantees Act 1993 or other legislation which cannot be excluded or limited. The Consumer Guarantees Act 1993 will not apply in respect of any goods which IBM provides, if you require the goods for the purposes of a business as defined in that Act.

Limitation of Liability: The following is added to this Section: Where Machines are not acquired for the purposes of a business as defined in the Consumer Guarantees Act 1993, the limitations in this Section are subject to the limitations in that Act.

EUROPE, MIDDLE EAST, AFRICA (EMEA)

The following terms apply to all EMEA countries.

The terms of this Statement of Warranty apply to Machines purchased from an IBM reseller. If you purchased this Machine from IBM, the terms and conditions of the applicable IBM agreement prevail over this warranty statement.

Warranty Service

If you purchased an IBM Machine in Austria, Belgium, Denmark, Estonia, Finland, France, Germany, Greece, Iceland, Ireland, Italy, Latvia, Lithuania, Luxembourg, Netherlands, Norway, Portugal, Spain, Sweden, Switzerland or United Kingdom, you may obtain warranty service for that Machine in any of those countries from either (1) an IBM reseller approved to perform warranty service or (2) from IBM.

If you purchased an IBM Personal Computer Machine in Albania, Armenia, Belarus, Bosnia and Herzegovina, Bulgaria, Croatia, Czech Republic, Georgia, Hungary, Kazakhstan, Kirghizia, Federal Republic of Yugoslavia, Former Yugoslav Republic of Macedonia (FYROM), Moldova, Poland, Romania, Russia, Slovak Republic, Slovenia, or Ukraine, you may obtain warranty service for that Machine in any of those countries from either (1) an IBM reseller approved to perform warranty service or (2) from IBM.

The applicable laws, Country-unique terms and competent court for this Statement are those of the country in which the warranty service is being provided. However, the laws of Austria govern this Statement if the warranty service is provided in Albania, Armenia, Belarus, Bosnia and Herzegovina, Bulgaria, Croatia, Czech Republic, Federal Republic of Yugoslavia, Georgia, Hungary, Kazakhstan, Kirghizia, Former Yugoslav Republic of Macedonia (FYROM), Moldova, Poland, Romania, Russia, Slovak Republic, Slovenia, and Ukraine.

The following terms apply to the country specified:

EGYPT: Limitation of Liability: The following replaces item 2 in this Section:
2. as to any other actual direct damages, IBM's liability will be limited to the total amount you paid for the Machine that is the subject of the claim.

Applicability of suppliers and resellers (unchanged).

FRANCE: Limitation of Liability: The following replaces the second sentence of the first paragraph of this Section:
In such instances, regardless of the basis on which you are entitled to claim damages from IBM, IBM is liable for no more than: (items 1 and 2 unchanged).

GERMANY: The IBM Warranty for Machines: The following replaces the first sentence of the first paragraph of this Section:
The warranty for an IBM Machine covers the functionality of the Machine for its normal use and the Machine's conformity to its Specifications.

The following paragraphs are added to this Section:
The minimum warranty period for Machines is six months.

In case IBM or your reseller are unable to repair an IBM Machine, you can alternatively ask for a partial refund as far as justified by the reduced value of the unrepaired Machine or ask for a cancellation of the respective agreement for such Machine and get your money refunded.

Extent of Warranty: The second paragraph does not apply.

Warranty Service: The following is added to this Section:

During the warranty period, transportation for delivery of the failing Machine to IBM will be at IBM's expense.

Production Status: The following paragraph replaces this Section:

Each Machine is newly manufactured. It may incorporate in addition to new parts, re-used parts as well.

Limitation of Liability: The following is added to this Section:

The limitations and exclusions specified in the Statement of Warranty will not apply to damages caused by IBM with fraud or gross negligence and for express warranty. In item 2, replace "U.S. \$100,000" with "1.000.000 DEM."

The following sentence is added to the end of the first paragraph of item 2:

IBM's liability under this item is limited to the violation of essential contractual terms in cases of ordinary negligence.

IRELAND: Extent of Warranty: The following is added to this Section:

Except as expressly provided in these terms and conditions, all statutory conditions, including all warranties implied, but without prejudice to the generality of the foregoing all warranties implied by the Sale of Goods Act 1893 or the Sale of Goods and Supply of Services Act 1980 are hereby excluded.

Limitation of Liability: The following replaces items one and two of the first paragraph of this Section: 1. death or personal injury or physical damage to your real property solely caused by IBM's negligence; and 2. the amount of any other actual direct damages, up to the greater of Irish Pounds 75,000 or 125 percent of the charges (if recurring, the 12 months' charges apply) for the Machine that is the subject of the claim or which otherwise gives rise to the claim.

Applicability of suppliers and resellers (unchanged).

The following paragraph is added at the end of this Section:

IBM's entire liability and your sole remedy, whether in contract or in tort, in respect of any default shall be limited to damages.

ITALY: Limitation of Liability: The following replaces the second sentence in the first paragraph: In each such instance unless otherwise provided by mandatory law, IBM is liable for no more than: (item 1 unchanged) 2) as to any other actual damage arising in all situations involving non-performance by IBM pursuant to, or in any way related to the subject matter of this Statement of Warranty, IBM's liability, will be limited to the total amount you paid for the Machine that is the subject of the claim.

Applicability of suppliers and resellers (unchanged).

The following replaces the second paragraph of this Section:

Unless otherwise provided by mandatory law, IBM and your reseller are not liable for any of the following: (items 1 and 2 unchanged) 3) indirect damages, even if IBM or your reseller is informed of their possibility.

SOUTH AFRICA, NAMIBIA, BOTSWANA, LESOTHO AND SWAZILAND: Limitation of Liability: The following is added to this Section:

IBM's entire liability to you for actual damages arising in all situations involving non-performance by IBM in respect of the subject matter of this Statement of Warranty will be limited to the charge paid by you for the individual Machine that is the subject of your claim from IBM.

TURKIYE: Production Status: The following replaces this Section:

IBM fulfils customer orders for IBM Machines as newly manufactured in accordance with IBM's production standards.

UNITED KINGDOM: Limitation Of Liability: The following replaces items 1 and 2 of the first paragraph of this Section:

1. death or personal injury or physical damage to your real property solely caused by IBM's negligence; 2. the amount of any other actual direct damages or loss, up to the greater of Pounds Sterling 150,000 or 125 percent of the charges (if recurring, the 12 months' charges apply) for the Machine that is the subject of the claim or which otherwise gives rise to the claim. The following item is added to this paragraph: 3. breach of IBM's obligations implied by Section 12 of the Sale of Goods Act 1979 or Section 2 of the Supply of Goods and Services Act 1982.

Applicability of suppliers and resellers (unchanged).

The following is added to the end of this Section:

IBM's entire liability and your sole remedy, whether in contract or in tort, in respect of any default will be limited to damages.

NORTH AMERICA

CANADA: Warranty Service: The following is added to this Section:

To obtain warranty service from IBM, call 1-800-465-6666.

UNITED STATES OF AMERICA: Warranty Service: The following is added to this Section:

To obtain warranty service from IBM, call 1-800-IBM-SERV.

IBM U.S., Canada, and Puerto Rico Statement Of Limited Warranty

Part 1 - General Terms

This Statement of Limited Warranty includes Part 1 - General Terms and Part 2 - Country-unique Terms. THE TERMS OF PART 2 MAY REPLACE OR MODIFY THOSE OF PART 1.

The warranties provided by IBM in this Statement of Limited Warranty apply only to Machines you purchase for your use, and not for resale, from IBM or your reseller. The term "Machine" means an IBM machine, its features, conversions, upgrades, elements, or accessories, or any combination of them. The term "Machine" does not include any software programs, whether pre-loaded with the Machine, installed subsequently or otherwise. Unless IBM specifies otherwise, the following warranties apply only in the country where you acquire the Machine. Nothing in this Statement of Warranty affects any statutory rights of consumers that cannot be waived or limited by contract. If you have any questions, contact IBM or your reseller.

MACHINE - WorkPad c3

WARRANTY PERIOD* - One (1) Year

*Contact your place of purchase for warranty service information. Some IBM Machines are eligible for On-site warranty service depending on the country where service is performed.

The IBM Warranty for Machines

IBM warrants that each Machine 1) is free from defects in materials and workmanship and 2) conforms to IBM's Official Published Specifications. The warranty period for a Machine is a specified, fixed period commencing on its Date of Installation. The date on your sales receipt is the Date of Installation, unless IBM or your reseller informs you otherwise.

During the warranty period IBM or your reseller, if approved by IBM to provide warranty service, will provide repair and exchange service for the Machine, without charge, under the type of service designated for the Machine and will manage and install engineering changes that apply to the Machine.

If a Machine does not function as warranted during the warranty period, and IBM or your reseller are unable to either 1) make it do so or 2) replace it with one that is at least functionally equivalent, you may return it to your place of purchase and your money will be refunded. The replacement may not be new, but will be in good working order.

Extent of Warranty

The warranty does not cover the repair or exchange of a Machine resulting from misuse, accident, modification, unsuitable physical or operating environment, improper maintenance by you, or failure caused by a product for which IBM is not responsible. The warranty is voided by removal or alteration of Machine or parts identification labels.

THESE WARRANTIES ARE YOUR EXCLUSIVE WARRANTIES AND REPLACE ALL OTHER WARRANTIES OR CONDITIONS, EXPRESS OR IMPLIED, INCLUDING, BUT NOT LIMITED TO, THE IMPLIED WARRANTIES OR CONDITIONS OF MERCHANTABILITY AND FITNESS FOR A PARTICULAR PURPOSE. THESE WARRANTIES GIVE YOU SPECIFIC LEGAL RIGHTS AND YOU MAY ALSO HAVE OTHER RIGHTS WHICH VARY FROM JURISDICTION TO JURISDICTION. SOME JURISDICTIONS DO NOT ALLOW THE EXCLUSION OR LIMITATION OF EXPRESS OR IMPLIED WARRANTIES, SO THE ABOVE EXCLUSION OR LIMITATION MAY NOT APPLY TO YOU. IN THAT EVENT, SUCH WARRANTIES ARE LIMITED IN DURATION TO THE WARRANTY PERIOD. NO WARRANTIES APPLY AFTER THAT PERIOD.

Items Not Covered by Warranty

IBM does not warrant uninterrupted or error-free operation of a Machine.

Unless specified otherwise, IBM provides non-IBM machines **WITHOUT WARRANTIES OF ANY KIND**.

Any technical or other support provided for a Machine under warranty, such as assistance via telephone with "how-to" questions and those regarding Machine set-up and installation, will be provided **WITHOUT WARRANTIES OF ANY KIND**.

Warranty Service

To obtain warranty service for the Machine, contact your reseller or IBM. In the United States, call IBM at 1-800-IBM-SERV (426-7378). In Canada, call IBM at 1-800-465-6666. You may be required to present proof of purchase.

IBM or your reseller provides certain types of repair and exchange service, either at your location or at a service center, to keep Machines in, or restore them to, conformance with their Specifications. IBM or your reseller will inform you of the available types of service for a Machine based on its country of installation. IBM may repair the failing Machine or exchange it at its discretion.

When warranty service involves the exchange of a Machine or part, the item IBM or your reseller replaces becomes its property and the replacement becomes yours. You represent that all removed items are genuine and unaltered. The replacement may not be new, but will be in good working order and at least functionally equivalent to the item replaced. The replacement assumes the warranty service status of the replaced item.

Any feature, conversion, or upgrade IBM or your reseller services must be installed on a Machine which is 1) for certain Machines, the designated, serial-numbered Machine and 2) at an engineering-change level compatible with the feature, conversion, or upgrade. Many features, conversions, or upgrades involve the removal of parts and their return to IBM. A part that replaces a removed part will assume the warranty service status of the removed part.

Before IBM or your reseller exchanges a Machine or part, you agree to remove all features, parts, options, alterations, and attachments not under warranty service.

You also agree to

1. ensure that the Machine is free of any legal obligations or restrictions that prevent its exchange;

2. obtain authorization from the owner to have IBM or your reseller service a Machine that you do not own; and
3. where applicable, before service is provided
 - a. follow the problem determination, problem analysis, and service request procedures that IBM or your reseller provides,
 - b. secure all programs, data, and funds contained in a Machine,
 - c. provide IBM or your reseller with sufficient, free, and safe access to your facilities to permit them to fulfill their obligations, and
 - d. inform IBM or your reseller of changes in a Machine's location.

IBM is responsible for loss of, or damage to, your Machine while it is 1) in IBM's possession or 2) in transit in those cases where IBM is responsible for the transportation charges.

Neither IBM nor your reseller is responsible for any of your confidential, proprietary or personal information contained in a Machine which you return to IBM or your reseller for any reason. You should remove all such information from the Machine prior to its return.

Production Status

Each IBM Machine is manufactured from new parts, or new and used parts. In some cases, the Machine may not be new and may have been previously installed. Regardless of the Machine's production status, IBM's appropriate warranty terms apply.

Limitation of Liability

Circumstances may arise where, because of a default on IBM's part or other liability, you are entitled to recover damages from IBM. In each such instance, regardless of the basis on which you are entitled to claim damages from IBM (including fundamental breach, negligence, misrepresentation, or other contract or tort claim), IBM is liable for no more than

1. damages for bodily injury (including death) and damage to real property and tangible personal property; and
2. the amount of any other actual direct damages, up to the greater of U.S. \$100,000 (or equivalent in local currency) or the charges (if recurring, 12 months' charges apply) for the Machine that is the subject of the claim.

This limit also applies to IBM's suppliers and your reseller. It is the maximum for which IBM, its suppliers, and your reseller are collectively responsible.

UNDER NO CIRCUMSTANCES IS IBM LIABLE FOR ANY OF THE FOLLOWING: 1) THIRD-PARTY CLAIMS AGAINST YOU FOR DAMAGES (OTHER THAN THOSE UNDER THE FIRST ITEM LISTED ABOVE); 2) LOSS OF, OR DAMAGE TO, YOUR RECORDS OR DATA; OR 3) SPECIAL, INCIDENTAL, OR INDIRECT DAMAGES OR FOR ANY ECONOMIC CONSEQUENTIAL DAMAGES (INCLUDING LOST PROFITS OR SAVINGS), EVEN IF IBM, ITS SUPPLIERS OR YOUR RESELLER IS INFORMED OF THEIR POSSIBILITY. SOME JURISDICTIONS DO NOT ALLOW THE EXCLUSION OR LIMITATION OF INCIDENTAL OR CONSEQUENTIAL DAMAGES, SO THE ABOVE LIMITATION OR EXCLUSION MAY NOT APPLY TO YOU.

IBM U.S. Statement Of Limited Warranty

Part 2 - Country-unique Terms

ASIA PACIFIC

AUSTRALIA: The IBM Warranty for Machines: The following paragraph is added to this Section:

The warranties specified in this Section are in addition to any rights you may have under the Trade Practices Act 1974 or other legislation and are only limited to the extent permitted by the applicable legislation.

Extent of Warranty: The following replaces the first and second sentences of this Section:

The warranty does not cover the repair or exchange of a Machine resulting from misuse, accident, modification, unsuitable physical or operating environment, operation in other than the Specified Operating Environment, improper maintenance by you, or failure caused by a product for which IBM is not responsible.

Limitation of Liability: The following is added to this Section:

Where IBM is in breach of a condition or warranty implied by the Trade Practices Act 1974, IBM's liability is limited to the repair or replacement of the goods or the supply of equivalent goods. Where that condition or warranty relates to right to sell, quiet possession or clear title, or the goods are of a kind ordinarily acquired for personal, domestic or household use or consumption, then none of the limitations in this paragraph apply.

PEOPLE'S REPUBLIC OF CHINA: Governing Law: The following is added to this Statement:

The laws of the State of New York govern this Statement.

INDIA: Limitation of Liability: The following replaces items 1 and 2 of this Section:

1. liability for bodily injury (including death) or damage to real property and tangible personal property will be limited to that caused by IBM's negligence;
2. as to any other actual damage arising in any situation involving nonperformance by IBM pursuant to, or in any way related to the subject of this Statement of Warranty, IBM's liability will be limited to the charge paid by you for the individual Machine that is the subject of the claim.

NEW ZEALAND: The IBM Warranty for Machines: The following paragraph is added to this Section:

The warranties specified in this Section are in addition to any rights you may have under the Consumer Guarantees Act 1993 or other legislation which cannot be excluded or limited. The Consumer Guarantees Act 1993 will not apply in respect of any goods which IBM provides, if you require the goods for the purposes of a business as defined in that Act.

Limitation of Liability: The following is added to this Section:

Where Machines are not acquired for the purposes of a business as defined in the Consumer Guarantees Act 1993, the limitations in this Section are subject to the limitations in that Act.

EUROPE, MIDDLE EAST, AFRICA (EMEA)

The following terms apply to all EMEA countries.

The terms of this Statement of Warranty apply to Machines purchased from an IBM reseller. If you purchased this Machine from IBM, the terms and conditions of the applicable IBM agreement prevail over this warranty statement.

Warranty Service

If you purchased an IBM Machine in Austria, Belgium, Denmark, Estonia, Finland, France, Germany, Greece, Iceland, Ireland, Italy, Latvia, Lithuania, Luxembourg, Netherlands, Norway, Portugal, Spain, Sweden, Switzerland or United Kingdom, you may obtain warranty service for that Machine in any of those countries from either (1) an IBM reseller approved to perform warranty service or (2) from IBM.

If you purchased an IBM Personal Computer Machine in Albania, Armenia, Belarus, Bosnia and Herzegovina, Bulgaria, Croatia, Czech Republic, Georgia, Hungary, Kazakhstan, Kirghizia, Federal Republic of Yugoslavia, Former Yugoslav Republic of Macedonia (FYROM), Moldova, Poland, Romania, Russia, Slovak Republic, Slovenia, or Ukraine, you may obtain warranty service for that Machine in any of those countries from either (1) an IBM reseller approved to perform warranty service or (2) from IBM.

The applicable laws, Country-unique terms and competent court for this Statement are those of the country in which the warranty service is being provided. However, the laws of Austria govern this Statement if the warranty service is provided in Albania, Armenia, Belarus, Bosnia and Herzegovina, Bulgaria, Croatia, Czech Republic, Federal Republic of Yugoslavia, Georgia, Hungary, Kazakhstan, Kirghizia, Former Yugoslav Republic of Macedonia (FYROM), Moldova, Poland, Romania, Russia, Slovak Republic, Slovenia, and Ukraine.

The following terms apply to the country specified:

EGYPT: Limitation of Liability: The following replaces item 2 in this Section:
2. as to any other actual direct damages, IBM's liability will be limited to the total amount you paid for the Machine that is the subject of the claim.

Applicability of suppliers and resellers (unchanged).

FRANCE: Limitation of Liability: The following replaces the second sentence of the first paragraph of this Section:

In such instances, regardless of the basis on which you are entitled to claim damages from IBM, IBM is liable for no more than: (items 1 and 2 unchanged).

GERMANY: The IBM Warranty for Machines: The following replaces the first sentence of the first paragraph of this Section:

The warranty for an IBM Machine covers the functionality of the Machine for its normal use and the Machine's conformity to its Specifications.

The following paragraphs are added to this Section:

The minimum warranty period for Machines is six months.

In case IBM or your reseller are unable to repair an IBM Machine, you can alternatively ask for a partial refund as far as justified by the reduced value of the unrepaired Machine or ask for a cancellation of the respective agreement for such Machine and get your money refunded.

Extent of Warranty: The second paragraph does not apply.

Warranty Service: The following is added to this Section:
During the warranty period, transportation for delivery of the failing Machine to IBM will be at IBM's expense.

Production Status: The following paragraph replaces this Section:
Each Machine is newly manufactured. It may incorporate in addition to new parts, re-used parts as well.

Limitation of Liability: The following is added to this Section:
The limitations and exclusions specified in the Statement of Warranty will not apply to damages caused by IBM with fraud or gross negligence and for express warranty.

In item 2, replace "U.S. \$100,000" with "1.000.000 DM."

The following sentence is added to the end of the first paragraph of item 2:
IBM's liability under this item is limited to the violation of essential contractual terms in cases of ordinary negligence.

IRELAND: Extent of Warranty: The following is added to this Section:
Except as expressly provided in these terms and conditions, all statutory conditions, including all warranties implied, but without prejudice to the generality of the foregoing all warranties implied by the Sale of Goods Act 1893 or the Sale of Goods and Supply of Services Act 1980 are hereby excluded.

Limitation of Liability: The following replaces items one and two of the first paragraph of this Section:

1. death or personal injury or physical damage to your real property solely caused by IBM's negligence; and 2. the amount of any other actual direct damages, up to the greater of Irish Pounds 75,000 or 125 percent of the charges (if recurring, the 12 months' charges apply) for the Machine that is the subject of the claim or which otherwise gives rise to the claim.

Applicability of suppliers and resellers (unchanged).

The following paragraph is added at the end of this Section:
IBM's entire liability and your sole remedy, whether in contract or in tort, in respect of any default shall be limited to damages.

ITALY: Limitation of Liability: The following replaces the second sentence in the first paragraph:

In each such instance unless otherwise provided by mandatory law, IBM is liable for no more than: (item 1 unchanged) 2) as to any other actual damage arising in all situations involving non-performance by IBM pursuant to, or in any way related to the subject matter of this Statement of Warranty, IBM's liability, will be limited to the total amount you paid for the Machine that is the subject of the claim.

Applicability of suppliers and resellers (unchanged).

The following replaces the second paragraph of this Section:

Unless otherwise provided by mandatory law, IBM and your reseller are not liable for any of the following: (items 1 and 2 unchanged) 3) indirect damages, even if IBM or your reseller is informed of their possibility.

SOUTH AFRICA, NAMIBIA, BOTSWANA, LESOTHO AND SWAZILAND: Limitation of Liability: The following is added to this Section:

IBM's entire liability to you for actual damages arising in all situations involving non-performance by IBM in respect of the subject matter of this Statement of Warranty will be limited to the charge paid by you for the individual Machine that is the subject of your claim from IBM.

TURKIYE: Production Status: The following replaces this Section:

IBM fulfills customer orders for IBM Machines as newly manufactured in accordance with IBM's production standards.

UNITED KINGDOM: Limitation of Liability: The following replaces items 1 and 2 of the first paragraph of this Section:

1. death or personal injury or physical damage to your real property solely caused by IBM's negligence;
2. the amount of any other actual direct damages or loss, up to the greater of Pounds Sterling 150,000 or 125 percent of the charges (if recurring, the 12 months' charges apply) for the Machine that is the subject of the claim or which otherwise gives rise to the claim.

The following item is added to this paragraph:

3. breach of IBM's obligations implied by Section 12 of the Sale of Goods Act 1979 or Section 2 of the Supply of Goods and Services Act 1982.

Applicability of suppliers and resellers (unchanged).

The following is added to the end of this Section:

IBM's entire liability and your sole remedy, whether in contract or in tort, in respect of any default will be limited to damages.

Notices

References in this publication to IBM products, programs, or services do not imply that IBM intends to make these available in all countries in which IBM operates. Any reference to an IBM product, program, or service is not intended to state or imply that only that IBM product, program, or service may be used. Subject to IBM's valid intellectual property or other legally protectable rights, any functionally equivalent product, program, or service may be used instead of the IBM product, program, or service. The evaluation and verification of operation in conjunction with other products, except those expressly designated by IBM, are the responsibility of the user.

IBM may have patents or pending patent applications covering subject matter in this document. The furnishing of this document does not give you any license to these patents. You can send license inquiries, in writing, to:

IBM Director of Licensing
IBM Corporation
500 Columbus Avenue
Thornwood, NY 10594
U.S.A.

Year 2000 Readiness and Instructions

A product is Year 2000 Ready if the product, when used in accordance with its associated documentation, is capable of correctly processing, providing and/or receiving date data within and between the 20th and 21st centuries (the years 1999 and 2000), provided all other products (for example, software, hardware, and firmware) used with the product properly exchange date data with it.

This IBM hardware product has been designed to process four-digit date information correctly within and between the 20th and 21st centuries (the years 1999 and 2000). If your IBM computer is on when the century changes (the year changes to 2000), you should turn it off and then back on again once, or restart the operating system, to ensure that the internal clock resets itself for the year 2000. The date and time utilities for the IBM WorkPad platform use 32 bits to store seconds, starting at January 1, 1904. This approach allows the correct representation of dates up to 6:28:15 A.M. on February 6, 2040. Provided the product is still being sold, IBM will make software enhancements to remove this limitation to the IBM WorkPad platform well in advance of this date.

This IBM PC product cannot prevent errors that might occur if software you use or exchange data with is not ready for the Year 2000. IBM software that comes with this product is Year 2000 Ready. However, software from other companies might come with this IBM PC product. IBM cannot take responsibility for the readiness of that software.

You should contact the software developers directly if you wish to verify readiness, understand limitations, or look for any software updates.

To learn more about IBM products and the Year 2000, visit our Web site at <http://www.pc.ibm.com/year2000>.

The information and tools there can help you with your Year 2000 transition plan, especially if you have multiple IBM PCs. IBM encourages you to check periodically for updated information.

Trademarks

The following terms are trademarks or service marks of the IBM Corporation in the United States and other countries:

IBM
WorkPad
HelpCenter

Other company, product, and service names may be trademarks or service marks of others.

Electronic Emissions Notices

Federal Communications Commission (FCC) Statement

IBM WorkPad

This equipment has been tested by 3COM PALM COMPUTING, a subsidiary of 3COM Corporation, and found to comply with the limits for the Class B digital device, pursuant to Part 15 of the FCC Rules. These limits are designed to provide reasonable protection against harmful interference in a residential installation. This equipment generates, uses, and can radiate frequency energy and, if not installed and used in accordance with the instructions, may cause harmful interference to radio communication. However, there is no guarantee that interference will not occur in a particular installation. If this equipment does cause harmful interference to radio or television reception, which can be determined by turning the equipment off and on, the user is encouraged to try to correct the interference by one of more of the following measures:

- Reorient or relocate the receiving antenna.
- Increase the separation between the equipment or receiver.
- Connect the equipment into an outlet on a circuit different from that to which the receiver is connected.
- Consult an authorized dealer or an experienced service technician for help.

Properly shielded and grounded cables and connectors must be used when connecting this equipment to any and all optional peripheral or host devices in order to meet FCC emission limits. Proper cables and connectors are available from the authorized dealers.

Changes or modification not covered in this manual must be approved in writing by 3COM PALM COMPUTING's Regulatory Engineering Department. 3COM PALM COMPUTING is not responsible for any radio or television interference caused by using other than the recommended cables and connectors or by unauthorized changes to this equipment. Unauthorized changes or modification could void the user's authority to operate this equipment.

This device complies with Part 15 of the FCC Rules. Operation is subject to the following two conditions: (1) this device may not cause harmful interference, and (2) this device must accept any interference received, including interference that may cause undesired operation.

Responsible Party: Palm Computing, Inc., a subsidiary of 3Com Corporation
5400 Bayfront Plaza
PO Box 58007
Santa Clara, CA 95052-8007
United States of America
Telephone: 408-326-5000

Canadian ICES-003 Statement

This Class B digital apparatus meets all of the requirements of the Canadian Interference-Causing Equipment Regulations.

Cet appareil numérique de la classe B respecte toutes les exigences du Règlement sur le matériel brouilleur du Canada.

Australia and New Zealand Class A Statement

Attention: This is a Class A product. In a domestic environment this product may cause radio interference in which case the user may be required to take adequate measures.



CE Compliance Statement

This product was tested by Palm Computing, Inc., a subsidiary of 3Com Corporation and found to comply with all the requirements of the EMC Directive 89/336/EEC as amended.

Statement of Conformity

Statement Of Conformity to the Voluntary Control Council for Interference from Information Technology Equipment (VCCI) Class B ITE for Regular Members



This is a Class B product based on the standard of the Voluntary Control Council for Interference from Information Technology Equipment (VCCI). If this is used near a radio or television receiver in a domestic environment, it may cause radio interference. Install and use the equipment according to the instruction manual.

この装置は、情報処理装置等電波障害自主規制協議会（VCCI）の基準に基づく第二種情報技術装置です。この装置は、家庭環境で使用することを目的としていますが、この装置がラジオやテレビジョン受信機に近接して使用されると、受信障害を引き起こすことがあります。取扱説明書に従って正しい取り扱いをして下さい。

UL/CSA Statement

For your safety, a power cord with a grounded attachment plug is provided to use with this product. To avoid electrical shock, always use the power cord and plug with a properly grounded outlet.

Power cords used in the United States and Canada are listed by Underwriter's Laboratories (UL) and certified by the Canadian Standards Association (CSA).

For units intended to be operated at 115 volts:

Use a UL-listed and CSA-certified cord set consisting of a minimum 18 AWG, Type SVT or SJT, three-conductor cord, a maximum of 15 feet in length and a parallel blade, grounding-type attachment plug rated 15 amperes, 125 volts.

For units intended to be operated at 230 volts (U.S. use):

Use a UL-listed and CSA-certified cord set consisting of a minimum 18 AWG, Type SVT or SJT, three-conductor cord, a maximum of 15 feet in length and a tandem blade, grounding-type attachment plug rated 15 amperes, 250 volts.

For units intended to be operated at 230 volts (outside the U.S.):

Use a cord set with a grounding-type attachment plug. The cord set should have the appropriate safety approvals for the country in which the equipment will be installed.

Index

A

ABA (Address Book archive file) 36

AC adapter for recharging battery 10

Accented characters

 Graffiti writing 32

 onscreen keyboard 35

Add-on applications 42–45

Address Book

 If Found Call entry 87

 adding custom fields 90

 archive files (.aba) 36

 business card for beaming 135

 categorizing records 61

 conduit for synchronizing 140

 creating records 55, 86–87

 deleting records 57

 displaying category 89

 displaying data in the Address
 List 88

 finding records 64–65

 fonts 72

 menus 88

 notes for records 71

 opening 51

 overview 51

 pressing button to beam
 information 136

 private records 71

 sorting records 68

Alarm

 preset 85

 setting 77

 sound 85, 157, 184

 for untimed events 78

Alphabet

 Graffiti writing 28

 onscreen keyboard 15, 20

Application buttons 5, 16, 50, 51, 52,
53, 136, 152

Applications

 Address Book 51

 beaming 135–136

 Calculator 53

 categories 39–40

 Date Book 50

 Expense 54

 font style 72

 installing 42–44

 Memo Pad 53

 opening 17

 preferences for 41

 removing 45

 security 46

 size in kilobytes 195

 To Do List 52

 version of 195

 viewing as icons 40

 viewing as list 40

See also Add-on applications

Applications Launcher 16–17, 39–41

Archive files

 importing data from 36

 for main applications 36

 saving deleted records 57

 saving purged records 58

Automatic fill, in Expense 110

Auto-off delay 156

Autotext. *See* Graffiti ShortCuts

B

Backlight 6, 7, 153

Battery

 conserving power 156

 gauge 17

 recharging 10

 recycling 178

Battery, life and use 178

BCC (blind carbon copy) 120

Beaming information 135–136

 location of IR port 8

 pen stroke to activate 153

 problems with 191

Bold font for text 72

Business card for beaming 135

Buttons preferences 152

C

- Calculator
 - buttons explained 99
 - memory 99
 - opening 54
 - overview 53
 - recent calculations 53, 99
- Calibration 14, 154, 185
- Call Waiting, disabling 144, 163
- Calling card, using in phone settings 144, 164
- Capital letters (Graffiti writing) 29
- Caring for the companion 177
- Categories
 - application 39–40
 - assigning records to 61
 - beaming 135–136
 - creating 62–63
 - default 61
 - displaying 62, 89, 186
 - folders for e-mail 126
 - merging 64
 - renaming 63
 - using in Applications Launcher 40
- cc:Mail 112
- Chain calculations 99
- Channels for cover and stylus 8
- Characters, Graffiti 25
- Check boxes 16
- Clearing Calculator entries 99
- COM port. *See* Serial port
- Combining categories 64
- Comma delimited files, importing data from 36
- Command buttons 15
- Command equivalents (Graffiti writing) 18
- Compressing Day view 84
- Computer keyboard, entering data with 22
- Conduits
 - for connecting to PIMs 13
 - for modem HotSync operations 145
 - for synchronizing applications 187, 140–141, 181
- Confirming e-mail 122
- Conflicting events 81
- Connecting
 - service templates 165
 - to server or ISP 165
- Continuous events
 - deleting from Date Book 57
 - scheduling 78
- Contrast control 6
- Copying text 56
- Country default setting 155
- Cover for companion 8
- Cradle
 - connecting to computer 9
 - for local HotSync operations 59
 - viewing data from 156
- Creating
 - Address Book entries 86–87
 - categories 39–40, 62–63
 - currency symbols 104
 - custom fields in Address Book 90
 - Date Book events 73
 - e-mail 115–117
 - Expense items 101
 - expense reports in Excel 106–109
 - memos 96
 - notes for records 71
 - records 55
 - To Do List items 91
- Currency
 - default 110
 - defining 104
 - for Expense items 103
- Current date 24, 186
- Current time 17
 - displaying in Date Book 80
 - setting 23
- Custom currencies and symbols 104
- Custom expense reports 199–208
- Custom fields in Address Book 90
- Customizing. *See* Preferences
- Cutting text 56
- Cycling through views 50, 51, 52, 53

D

Data entry. *See* Entering data

Date Book

- adding Address Book data to records 66–67
- alarm 77
- archive files (.dba) 36
- changing event time 77
- changing event to untimed 76
- conduit for synchronizing 140
- conflicting events 81
- continuous events 78–79
- creating records 55, 73–77
- Day view 79
- deleting records 57
- display options 84
- end time for Day view 85
- fonts 72
- menus 83
- Month view 82
- notes for records 71
- opening 50
- overview 50
- private records 71
- purging records 58
- repeating events 57, 78–79
- scheduling events 73–77
- selecting dates 75
- start time for Day view 85
- Sunday or Monday to start week 155
- switching views 79
- untimed events 73, 76
- Week view 80, 155, 186

Dates

- Expense item 102
- setting current 24, 186
- showing in Mail list 127
- To Do List record due 93
- Year 2000 warranty 226

Day (Date Book view) 73, 84

DBA (Date Book archive file) 36

Decimal point 155

Default

- categories 61
- currency in Expense 110
- settings. *See* Preferences

Deleted

- data, saving in archive files 57
- e-mail, recovering 125

Deleting

- applications 42, 45
- Desktop software 45
- e-mail 125
- Graffiti characters 27
- passwords 47
- records 57
- service templates 170
- text 56
- See also* Purging records

Delivering e-mail 119, 122

Desktop E-Mail application

- applications supported 112
- managing 111–134
- support of Mail features 119

Desktop software 11–13

- configuring mail 112–114
- for entering data 22
- linking to external files 148
- removing 45
- saving deleted data to an archive file 57
- system requirements 4
- upgrading 4
- See also* PIM

Digitizer 14, 154, 185

DNS (Domain Naming System) 167

Double-booked events 81

Draft e-mail 123

Dragging

- memos into other applications 53
- stylus to activate features 153
- using the stylus 14

E

Editing

- records 55–57
- unsent e-mail 122

E-mail addresses

- in Address Book 87, 88
- looking up 118–119

E-mail items. *See* Mail

- Entering data 19–22
 - importing from other applications 36–37
 - problems with 185
 - using Graffiti writing 25–34
 - using the computer keyboard 35
 - using the onscreen keyboard 35

Entries. *See* Address Book

Eudora 112

Events. *See* Date Book

Excel, transferring Expense data to 106–109

Exchange 112

Exchanging data. *See* HotSync

Exclamation marks in To Do List 95

Expense

- adding Address Book data to records 67–68

- categorizing records 61

- conduit for synchronizing 140

- creating records 55, 101

- currency 103, 110

- date of item 102

- defining new currency 104

- deleting records 57

- menus 109

- notes for records 71

- opening 54

- overview 54

- purging records 58

- receipt details 102

- reports in Excel 106–109, 199–208

- sorting records 68

- templates for reports 107

- type 103, 110

- vendor 103

F

Files, linking to external 148

Filing e-mail 124

Filters for e-mail 129–133

Finding

- applications, using Graffiti writing 17

e-mail addresses 118–119

information in

- applications 64–68

- phone numbers 66–67

- using the Find application 65

Folders for e-mail 126

Fonts 72

Formats preferences 154

Front cover, inserting in a side channel 8

Frozen companion 184

G

Games 44, 157

General preferences

- alarm sounds 157

- auto-off delay 156

- system sounds 157

Glossary. *See* Graffiti ShortCuts

Graffiti

- accented characters 32

- alphabet 25, 28

- basic concepts 25

- capital letters 29

- Command stroke 19

- defined 20

- Giraffe game for practicing 44

- how to write characters 26

- menu commands 18

- moving the cursor 33

- numbers 29

- online Help 57, 152

- problems using 185

- punctuation marks 30

- ShortCuts for entering data 33, 174–175

- symbols 31

- tips 27

- writing 25–34

- writing area 5, 26

H

Hard reset 180

Header information (e-mail) 115, 117

Help

- Graffiti 57
- online tips 19

Hiding records 69

High Priority e-mail filter 132

HotSync

- buttons preferences 154
- conduits for synchronizing
 - applications 140–141, 181
- customizing 140
- defined 58
- first-time operation 59–60, 148–150
- for managing desktop
 - E-Mail 113–114
- HotSync Manager 59
- linking to external files 148
- local operation 60, 138, 188
- modem operation 139, 142–146, 189–190
- modem settings 143
- network operation 146
- options for filtering
 - e-mail 128–133
- problems with 187–190
- setting options 137–139
- for synchronizing data 11
- using with another PIM 45

I

Icons

- alarm 77
- application 15, 40
- note 71
- online Tips 19
- onscreen 185
- repeating event 79

Idle timeout of ISP or server connection 166

Ignoring e-mail. *See* Filters for e-mail

Importing data 22, 36–37

Inbox 126

Infrared port. *See* IR port

Installing

- applications 42–44
- conduit to install
 - applications 140
- Desktop software 12–13, 183
- Mail. *See* Mail, desktop configuration

International characters

- Graffiti writing 32
- onscreen keyboard 35

IP address 166, 168

IR port 8

See also Beaming information

Items. *See* To Do List or Expense

K

Keyboard

- computer 35
- onscreen 15, 35, 153

L

Letters

- font style 72
- Graffiti 25, 28
- onscreen keyboard 35

List, in Applications Launcher 40

Lithium-ion battery 10

Locking the companion with a password 47–48, 153, 173

Login scripts 169, 209

Looking up Address Book data - to add to other records 66–67 - scrolling in Address List 64 - to add to e-mail - addresses 118–119

Lost companion, contact for 87

Lost records 186

Lotus

- 1-2-3, for expense reports 208
- cc:Mail 112
- Organizer, importing data

M

Mail

- address lookup 118–119
- attachments 129
- BCC (blind carbon copy) 119, 120
- changing setup 114
- closing 115
- confirm delivery 119, 122
- confirm read 119, 122
- creating 115–117
- deleting e-mail 125
- desktop configuration 112–114
- draft e-mail 123
- editing unsent e-mail 122
- filing e-mail 124
- filtering options 128–133
- folders 126
- HotSync options 113–114
- menus 134
- opening 114
- overview 111–112
- priority of delivery 119, 120
- purging deleted e-mail 126
- recovering deleted 125
- replying to e-mail 117
- sending 122
- showing dates 127
- signature 119, 121–122
- sorting 127
- synchronizing 114
- truncating 133
- viewing e-mail 114

Main applications 16

Maintenance information 177

Memo Pad

- adding Address Book data to records 66–67
- archive files (.mpa) 36
- categorizing records 61
- conduit for synchronizing 140
- creating records 55, 96
- deleting records 57
- dragging memos into other applications 53
- fonts 72
- menus 97, 100

- opening 53
- overview 53
- private records 71
- reviewing memos 96
- sorting records 68, 186

Memory

- amount of free 195
- for beaming 191
- Calculator 99
- regaining 58, 184

Memos. *See* Memo Pad

Menus 17–19, 185

- Address Book 88
- choosing 18
- command equivalents (Graffiti writing) 18
- Date Book 83
- Edit menu 56–57
- Expense 109
- Mail 134
- Memo Pad 97, 100
- menu bar 15, 17
- Network Preferences 171
- To Do List 95

Microsoft

- Excel, transferring Expense data to 106–109
- Exchange 112
- Outlook, connecting to 13, 187

Modem

- HotSync operations via 142–146, 189–190
- preferences 158

Monday, to start week 155

Month (Date Book view) 82, 84

Moving the cursor (Graffiti writing) 33

MPA (Memo Pad archive file) 36

N

Network

- connecting 165
- connection type 166
- idle timeout 166
- login scripts 169
- password 161

- phone settings 162
- preferences 159–172
- primary DNS 167
- secondary DNS 167
- selecting service 159
- TCP/IP 159
- user name 160

Network HotSync operation 146

Notes, attaching to records 71

Numbers

- decimal point and thousands separator 155
- Graffiti writing 29
- onscreen keyboard 16, 20, 35

O

1-2-3, for expense reports 208

Onscreen keyboard 20, 35, 57

- pen stroke to open 153

Opening

- Address Book 51
- applications 16–17
- Calculator 54
- Date Book 50
- Expense 54
- Mail 114
- Memo Pad 53
- To Do List 52

Organizer (Lotus PIM) 36

Outbox 122, 126

Outlook, connecting to 13, 187

Overlapping events 81

Owner preferences 173

P

Palm Desktop for IBM WorkPad. *See* Desktop software

Passwords 46–48

- changing 47
- creating 46
- deleting 47
- for network 161
- forgotten 48, 193

Pasting text 56

Payment, Expense item 103

Pen stroke, full-screen 152–153

Personal information managers. *See* PIM

Phone Lookup 66–67

Phone numbers

- selecting for Address List 88
- selecting types 87

Phone settings for ISP or dial-in server 162–164

Pick lists 16

PIM (personal information manager)

- using HotSync Manager with 45
- using with companion 13

See also Desktop software

Port. *See* Serial port

Power button 6

PPP 166

PRC (application file extension) 43

Preferences 23

- Buttons 152
- choosing 41
- cradle setting 156
- Digitizer 154
- Formats 154
- General 156
- HotSync buttons 154
- Modem 158
- Network 159–172
- Owner 173
- ShortCuts 174

Primary DNS 167

Printing

- expense reports from
 - Excel 106–109
 - records from applications 11

Prioritizing To Do List records 91, 95

Priority of delivery (e-mail) 120

Private records

- displaying and creating 69–71, 186
- lost with forgotten password 48

See also Security

Profiles 148

Punctuation marks

- Graffiti writing 30
- onscreen keyboard 35

Purging
deleted e-mail 126
records 58
See also Deleting

Q

Quattro Pro, for expense reports 208

R

Range of times in Day view 85
Reading e-mail on companion 114
Receipts, recording in Expense 102
Receiving data. *See* Beaming information
Recharging the battery 10, 156
Records
Address Book 86
beaming 135–136
choosing categories 61
creating 55
Date Book 73
defined 55
deleting 57
displaying a category of 62
editing 55–57
Expense 101
fonts 72
hiding private 46, 69
lost 186
Memo Pad 96
notes for 71
number of 195
private 69–71
purging 58
sorting 68–69
To Do List 91
Recovering
deleted e-mail 125
filed mail 125
Removing
applications 45
Desktop software 45
Renaming categories 63

Repeating events
deleting from Date Book 57
scheduling 78
Replying to e-mail 117
Rescheduling events 77
Resetting companion
hard reset 180
location of reset button 8, 179
soft reset 179
Retrieving e-mail. *See* Filters for e-mail

S

Saving
data 39, 55, 57
draft e-mail 123
Scheduling events 73–77
Screen
backlight 6, 7
blank 184
calibrating 14, 154
caring for 177
contrast control 6
touching with your finger 5
Scroll bar 16
Scroll button 6
Searching. *See* Finding
Secondary DNS 167
Security 46–48
changing password 47
deleting password 47
displaying owner's name 173
forgotten password 48
locking the companion 47
private records 69–71
Selecting
date for event 75
e-mail to be synchronized. *See* Filters for e-mail 129
phone numbers in Address Book 87
text 56
Sending
data. *See* Beaming information
e-mail 115–117, 122

Serial connector 9
Serial port 9, 139, 142
Service templates 165, 170
Service, selecting for network 159
Settings. *See* Preferences
ShortCuts
 backing up 140
 managing 174–175
 menu commands 18
 predefined 34
 using 33
Showing dates in Mail list 127
Side channels for stylus and front cover 8
Signature for e-mail 121–122
Soft reset 179
Sorting
 applications 40
 e-mail items 127
 records 68–69, 186
Sounds. *See* Alarm *and* System sounds
Starting applications 17
Storing e-mail 124
Stylus
 dragging with 14
 inserting in a side channel 8
 pen stroke to activate a feature 152
 tapping with 14
 writing with 8, 25
Sunday, to start week 155
Symbols
 for currency 103
 in Graffiti writing 31
Synchronizing data. *See* HotSync
System conduit 140
System requirements for Desktop software 4
System sounds 157

T

Tab delimited files, importing data from 36
Tapping 14, 185

TCP/IP 159, 171
TDA (To Do List archive file) 36
Technical Support 183, 194
Templates for expense reports 107
Text
 copying 56
 cutting 56
 entry. *See* Entering data
 fonts for 72
 selecting all 56
Text files, importing data from 36
Thousands separator 155
Time
 alarm setting 77
 format 155
 setting current 23
 setting event 73
 start and end for Date Book Day view 85
Time bars in Date Book 84
Tips, online 19
To Do List
 adding Address Book data to records 66–67
 archive files (.tda) 36
 categorizing records 61, 95
 checking off items 92
 completed items 94
 completion date 94
 conduit for synchronizing 140
 creating records 55, 91
 deleting records 57
 due date 93, 94, 95
 fonts 72
 menus 95
 notes for records 71
 opening 52
 overview 52
 prioritizing records 91, 95
 private records 71
 purging records 58, 94
 sorting records 68
Today. *See* Current date
Transferring data. *See* HotSync
Transmitting data. *See* Beaming information

- Truncating e-mail 133
- Turning off companion
 - automatically 156
 - pen stroke for 153
 - problems with 184
- Turning on companion
 - application buttons 5
 - displaying owner's name 173
 - power button 6
 - problems with 184
- 2000, Year 226

U

- Undoing actions 56
- Uninstalling Desktop software 45
- Unresponsive companion 184
- Unsent e-mail, editing 122
- Untimed events 73, 76, 78
- Updating data. *See* HotSync
- Upgrading Desktop software 4
- User name
 - for ISP 160
 - identifying companion 173

- User profiles 148

V

- Vendor for Expense item 103

W

- Web sites 13
- Week (Date Book view) 80–81, 155, 186
- Writing area 5
- Writing. *See* Entering data

X

- XLT (Expense report template in Excel) 107

Y

- Year 2000 warranty 226

Free Manuals Download Website

<http://myh66.com>

<http://usermanuals.us>

<http://www.somanuals.com>

<http://www.4manuals.cc>

<http://www.manual-lib.com>

<http://www.404manual.com>

<http://www.luxmanual.com>

<http://aubethermostatmanual.com>

Golf course search by state

<http://golfingnear.com>

Email search by domain

<http://emailbydomain.com>

Auto manuals search

<http://auto.somanuals.com>

TV manuals search

<http://tv.somanuals.com>