

Infoprint 1585 (MT 4539)



User's Guide

Infoprint 1585 (MT 4539)



User's Guide

Edition: March 2005

The following paragraph does not apply to any country where such provisions are inconsistent with local law: LEXMARK INTERNATIONAL, INC., PROVIDES THIS PUBLICATION "AS IS" WITHOUT WARRANTY OF ANY KIND, EITHER EXPRESS OR IMPLIED, INCLUDING, BUT NOT LIMITED TO, THE IMPLIED WARRANTIES OF MERCHANTABILITY OR FITNESS FOR A PARTICULAR PURPOSE. Some states do not allow disclaimer of express or implied warranties in certain transactions; therefore, this statement may not apply to you.

This publication could include technical inaccuracies or typographical errors. Changes are periodically made to the information herein; these changes will be incorporated in later editions. Improvements or changes in the products or the programs described may be made at any time.

Comments about this publication may be addressed to Lexmark International, Inc., Department F95/032-2, 740 West New Circle Road, Lexington, Kentucky 40550, U.S.A. In the United Kingdom and Eire, send to Lexmark International Ltd., Marketing and Services Department, Westhorpe House, Westhorpe, Marlow Bucks SL7 3RQ. Lexmark may use or distribute any of the information you supply in any way it believes appropriate without incurring any obligation to you. You can purchase additional copies of publications related to this product by calling 1-800-553-9727. In the United Kingdom and Eire, call +44 (0)8704 440 044. In other countries, contact your point of purchase.

References in this publication to products, programs, or services do not imply that the manufacturer intends to make these available in all countries in which it operates. Any reference to a product, program, or service is not intended to state or imply that only that product, program, or service may be used. Any functionally equivalent product, program, or service that does not infringe any existing intellectual property right may be used instead. Evaluation and verification of operation in conjunction with other products, programs, or services, except those expressly designated by the manufacturer, are the user's responsibility.

© 2005 Lexmark International, Inc.

All rights reserved.

UNITED STATES GOVERNMENT RIGHTS

This software and any accompanying documentation provided under this agreement are commercial computer software and documentation developed exclusively at private expense.

Trademarks

MarkVision is a trademark of Lexmark International, Inc., registered in the United States and/or other countries.

Drag'N'Print and PrintCryption are trademarks of Lexmark International, Inc.

PCL[®] is a registered trademark of the Hewlett-Packard Company. PCL is Hewlett-Packard Company's designation of a set of printer commands (language) and functions included in its printer products. This printer is intended to be compatible with the PCL language. This means the printer recognizes PCL commands used in various application programs, and the printer emulates the functions corresponding to the commands.

PostScript[®] is a registered trademark of Adobe Systems Incorporated. PostScript 3 is Adobe Systems' designation of a set of printer commands (language) and functions included in its software products. This printer is intended to be compatible with the PostScript 3 language. This means the printer recognizes PostScript 3 commands used in various application programs, and the printer emulates the functions corresponding to the commands.

Details relating to compatibility are included in the *Technical Reference*.

Other trademarks are the property of their respective owners.

Safety information

- Connect the power cord to a properly grounded electrical outlet that is near the product and easily accessible.
CAUTION: Do not set up this product or make any electrical or cabling connections, such as the power cord or telephone, during a lightning storm.
- Refer service or repairs, other than those described in the operating instructions, to a professional service person.
- This product is designed, tested, and approved to meet strict global safety standards with the use of specific Lexmark components. The safety features of some parts may not always be obvious. Lexmark is not responsible for the use of other replacement parts.
- Your product uses a laser.
CAUTION: Use of controls or adjustments or performance of procedures other than those specified herein may result in hazardous radiation exposure.
- Your product uses a printing process that heats the print media, and the heat may cause the media to release emissions. You must understand the section in your operating instructions that discusses the guidelines for selecting print media to avoid the possibility of harmful emissions.

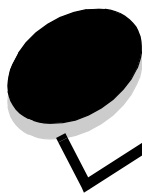

Contents

Chapter 1: Learning about the printer	6
Printer overview	6
Understanding the printer operator panel	9
Chapter 2: Installing drivers for local printing	11
Windows	11
Macintosh	15
UNIX/Linux	16
Chapter 3: Installing drivers for network printing	17
Printing a network setup page	17
Assigning a printer IP address	17
Verifying the IP settings	18
Windows	18
Macintosh	21
UNIX/Linux	24
NetWare	24
Chapter 4: Installing options	25
Accessing the printer system board	26
Installing a printer memory card	28
Installing a flash memory or firmware card	29
Installing an option card	30
Installing a hard disk	32
Replacing the access panel	34
Chapter 5: Understanding paper and specialty media guidelines	35
Supported print media	35
Selecting print media	42
Storing print media	47
Avoiding jams	48
Chapter 6: Printing	49
Loading standard or optional 500-sheet trays	49
Loading the multipurpose feeder	52
Loading the 2000-sheet dual input trays	55
Loading the 2000-sheet high capacity feeder	56
Loading Letter or A4 size print media in the short-edge feed orientation	58
Linking trays	59

Contents

Identifying and linking output bins	60
Sending a job to print	61
Printing from a USB flash memory device	62
Canceling a print job	63
Printing the menu settings page	64
Printing a network setup page	64
Printing a font sample list	64
Printing a directory list	65
Printing confidential and held jobs	65
Printing A5/Statement or JIS-B5/Executive sizes	69
Chapter 7: Maintaining the printer	70
Determining the status of supplies	70
Photoconductor kit end-of-life	71
Conserving supplies	71
Ordering supplies	71
Chapter 8: Clearing jams	73
Identifying jams	73
Access doors and trays	74
Understanding jam messages	75
Clearing printer jams	75
Clearing staple jams	92
Chapter 9: Troubleshooting	94
Calling for service	94
Checking an unresponsive printer	94
Printing multiple-language PDFs	95
Solving printing problems	95
Solving option problems	97
Solving paper feed problems	99
Solving print quality problems	100
Chapter 10: Administrative support	104
Adjusting operator panel brightness and contrast	104
Disabling operator panel menus	104
Enabling operator panel menus	105
Restoring factory default settings	105
Adjusting Power Saver	106
Disabling Power Saver	106
Encrypting the disk	107
Setting security using the Embedded Web Server (EWS)	108
Notices	112

Contents

Index	116
-------------	-----

1

Learning about the printer

Conventions used in this book

Note: A *note* identifies something that could help you.

CAUTION: A *caution* identifies something that could cause you harm.

Warning: A *warning* identifies something that could damage your product hardware or software.

Printer overview

CAUTION: Do not set up this product or make any electrical or cabling connections, such as the power cord or telephone, during a lightning storm.

CAUTION: The printer weighs 49 kg (108 lb) and requires at least two people to lift it safely.

Basic model

The following illustration shows a printer with its base features.

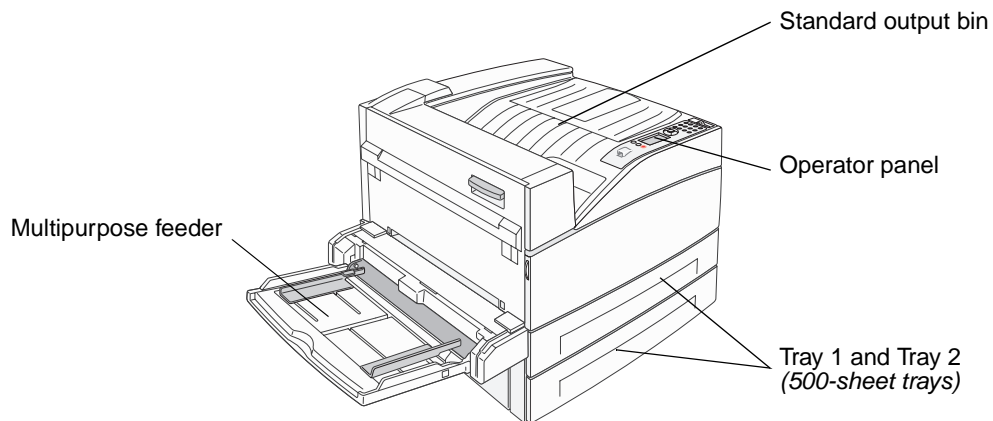

Configured model

The following illustration shows a fully configured printer. Items denoted with an asterisk (*) are options.

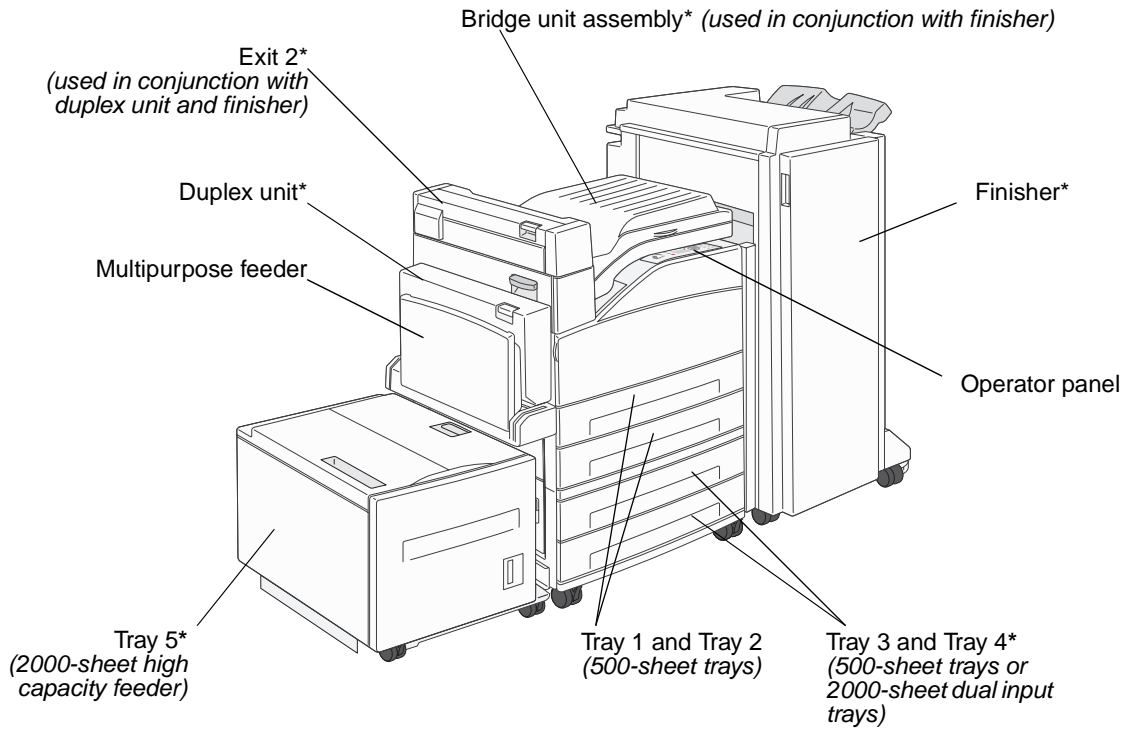

Learning about the printer

A number of menus are available to make it easy for you to change printer settings. The diagram shows the menu index on the operator panel and the menus and items available under each menu. For more information about menus and menu items, see the *Menus and Messages* book on the publications CD.

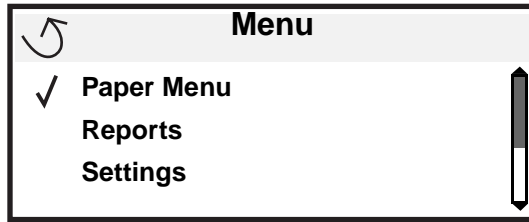

- Paper Menu**
- Default Source
 - Paper Size/Type
 - Configure MP
 - Substitute Size
 - Paper Texture
 - Paper Loading
 - Custom Types
 - Universal Setup
 - Bin Setup

- Reports**
- Menu Settings Page
 - Device Statistics
 - Network Setup Page
 - Network [x] Setup Page
 - Profiles List
 - Print Quick Ref
 - NetWare Setup Page
 - Print Fonts
 - Print Directory

- Settings**
- Setup Menu
 - Finishing Menu
 - Quality Menu
 - Utilities Menu
 - PDF Menu
 - PostScript Menu
 - PCL Emul Menu
 - HTML Menu
 - Image Menu

- Network/Ports**
- TCP/IP
 - IPv6
 - Standard Network
 - Network [x]
 - Standard USB
 - USB [x]
 - Front USB
 - Parallel
 - Parallel [x]
 - Serial [x]
 - NetWare
 - AppleTalk
 - LexLink

- Security**
- Max Invalid PIN
 - Job Expiration

- Help**
- Print All
 - Print Quality
 - Printing Guide
 - Media Guide
 - Print Defects
 - Menu Map
 - Information Guide
 - Connection Guide
 - Moving Guide





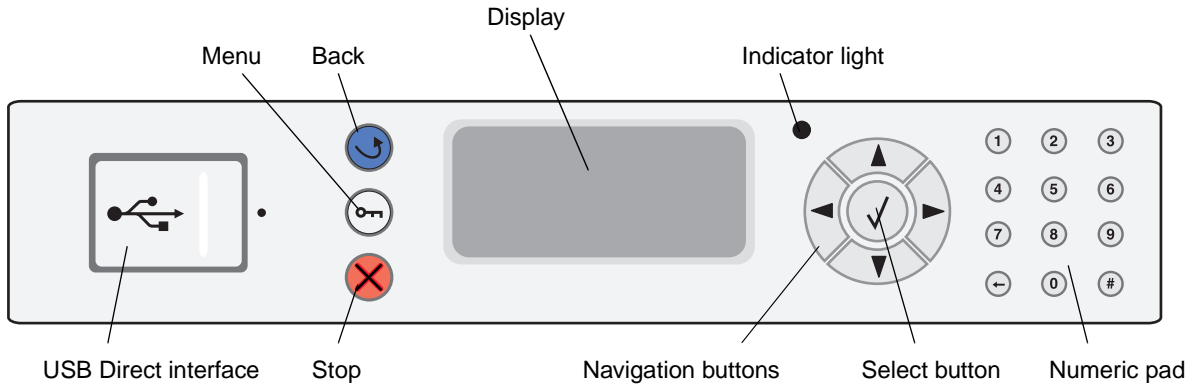

Understanding the printer operator panel

The operator panel consists of these items:

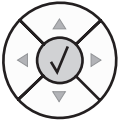

- A 4-line, back-lit, gray-scale display that can show both graphics and text
- Eight buttons: Back, Menu, Stop, Select (✓), ◀, ▶, ▲, and ▼
- Indicator light
- Numeric pad
- USB Direct Interface



The use of the buttons and the layout of the display panel are described in the following table.

Button or operator panel item	Function
Back 	Press the Back button to return to the last screen you viewed. Note: Changes made on a screen will not be applied if you press the Back button.
Menu 	Press the Menu button to open the menu index. Note: The printer must be in the Ready state to access the menu index. A message indicating the menus are unavailable will appear if the printer is not ready.
Stop 	Press the Stop button to stop the mechanical operation of the printer. After pressing Stop , the message stopping appears. When the printer has stopped, the status line in the operator panel will show stopped , and a list of options will appear.
Navigation buttons 	<div style="display: flex; flex-direction: column;"> <div style="display: flex; align-items: flex-start; margin-bottom: 10px;">  <p>The Up or Down buttons are used to move up and down lists.</p> </div> <div style="display: flex; align-items: flex-start; margin-bottom: 10px;">  <p>When navigating through a list using the Up or Down button, the cursor moves one line at a time. Pressing the Down button at the bottom of the screen changes the screen to the next whole page.</p> </div> <div style="display: flex; align-items: flex-start; margin-bottom: 10px;">  <p>The Left or Right buttons are used to move within a screen such as moving from one menu index item to another. They are also used to scroll through text that will not fit on the screen.</p> </div> <div style="display: flex; align-items: flex-start;">  <p>The Select button is used to initiate action on a selection. Press Select when the cursor appears next to the selection you want such as following a link, submitting a configuration item, or when you want to start or cancel a job.</p> </div> </div>

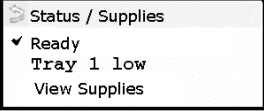
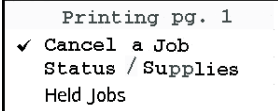
Learning about the printer

Button or operator panel item	Function												
<p>Indicator light</p>	<p>A two-toned LED is used on the operator panel, one color being green and the other being red. The lights indicate whether the printer power is on, the printer is busy, idle, processing a job, or requires operator intervention.</p> <table border="1" style="margin-left: auto; margin-right: auto; border-collapse: collapse; text-align: center;"> <thead> <tr style="background-color: #444; color: white;"> <th style="padding: 2px 5px;">Status</th> <th style="padding: 2px 5px;">Indicates</th> </tr> </thead> <tbody> <tr> <td style="padding: 2px 5px;">Off</td> <td style="padding: 2px 5px;">Power is off</td> </tr> <tr> <td style="padding: 2px 5px;">Solid green</td> <td style="padding: 2px 5px;">Printer is on, but idle</td> </tr> <tr> <td style="padding: 2px 5px;">Flashing green</td> <td style="padding: 2px 5px;">Printer is warming up, processing data, or printing a job</td> </tr> <tr> <td style="padding: 2px 5px;">Solid red</td> <td style="padding: 2px 5px;">Operator intervention is required</td> </tr> </tbody> </table>	Status	Indicates	Off	Power is off	Solid green	Printer is on, but idle	Flashing green	Printer is warming up, processing data, or printing a job	Solid red	Operator intervention is required		
Status	Indicates												
Off	Power is off												
Solid green	Printer is on, but idle												
Flashing green	Printer is warming up, processing data, or printing a job												
Solid red	Operator intervention is required												
<p>Numeric pad</p> <div style="text-align: center; margin: 10px 0;"> <table border="1" style="border-collapse: collapse; width: 60px; margin: 0 auto;"> <tr><td style="padding: 2px 5px;">1</td><td style="padding: 2px 5px;">2</td><td style="padding: 2px 5px;">3</td></tr> <tr><td style="padding: 2px 5px;">4</td><td style="padding: 2px 5px;">5</td><td style="padding: 2px 5px;">6</td></tr> <tr><td style="padding: 2px 5px;">7</td><td style="padding: 2px 5px;">8</td><td style="padding: 2px 5px;">9</td></tr> <tr><td style="padding: 2px 5px;">←</td><td style="padding: 2px 5px;">0</td><td style="padding: 2px 5px;">#</td></tr> </table> </div>	1	2	3	4	5	6	7	8	9	←	0	#	<p>The numeric pad consists of numbers, a pound '#' sign, and a backspace button. The 5 button has a raised bump for non-visual orientation.</p> <p>The numbers are used to enter numeric values for items like quantities or PINs. The backspace is used to delete the number to the left of the cursor. Pressing the backspace multiple times will delete additional entries.</p> <p>Note: The pound '#' sign is not used.</p>
1	2	3											
4	5	6											
7	8	9											
←	0	#											
<p>Display</p> <div style="margin: 5px 0;">  </div> <div style="margin: 5px 0;">  </div> <div style="margin: 5px 0;">  </div>	<p>The display shows messages and graphics describing the current state of the printer and indicating possible printer problems you must resolve.</p> <p>The top line of the display is the header line. If applicable, it will contain the graphic indicating the Back button can be used. It will also display the current status and the Supplies (Warnings) status. If multiple warnings are present, each warning will be separated by a comma.</p> <p>The other three lines of the display are the body of the screen. This is where you view printer status, supplies messages, show-me screens, and make selections.</p>												

2

Installing drivers for local printing

A local printer is a printer attached to the computer using a USB or parallel cable. The local printer is intended to be used by the computer to which it is attached. If attaching a local printer, install the printer driver on the computer before setting up the printer.

The printer driver is software that lets the computer communicate with the printer.

The procedure to install drivers depends on the operating system used. Use the following table to find driver installation instructions for the particular operating system. For additional help, see the documentation that shipped with the computer and the software.

Operating system	Go to page
Windows	11
Windows Server 2003, Windows 2000, Windows XP, Windows 98 SE, Windows Me, Windows NT 4.x	11
Windows 95 and Windows 98 (first edition)	12
Serial printing	13
Macintosh	15
UNIX/Linux	16

Windows

Some Windows operating systems may already include a printer driver that is compatible with the printer.

Note: Installing a custom driver will not replace the system driver. A separate printer object will be created and appear in the Printers folder.

Use the drivers CD that shipped with the printer to install the custom printer driver and obtain enhanced printer features and functionality.

Using Windows Server 2003, Windows 2000, Windows XP, Windows 98 SE, Windows Me, or Windows NT

Note: Install the printer software before connecting the USB cable.

- 1 Insert the drivers CD.

If the CD does not launch automatically, click **Start** → **Run**, and type `D:\setup.exe` in the Run dialog (where D is the letter of the CD-ROM drive).

Note: USB support is not available for Windows NT operating systems.

Installing drivers for local printing

- 2 Click **Install Printer and Software**.

Note: Some Windows operating systems require that the user has administrative access to install printer drivers on the computer.

- 3 Click **Agree** to accept the license agreement.

- 4 Select **Suggested**, and click **Next**.

The Suggested option is the default installation for local and network-attached setup. To install utilities, change settings, or customize device drivers, select **Custom**, and follow the instructions on the screen.

- 5 Select **Local Attach**, and click **Finish**.

Follow the instructions on the screen. It may take some time for the drivers to load.

- 6 Close the drivers CD installer application.

- 7 Connect the USB cable, and turn on the printer.

The Plug and Play screen appears, and a printer object is created in the printers folder of the computer.

Using Windows 95 and Windows 98 (first edition)

- 1 Turn on the computer.

- 2 Insert the drivers CD. If the CD launches automatically, click **Exit** to return to the Add Printer Wizard.

- 3 Click **Start** → **Settings** → **Printers**, and double-click **Add Printer**.

Note: USB support is not available for Windows 95 and Windows 98 (first edition) operating systems.

- 4 When prompted, select **Local printer**.

- 5 Click **Have Disk**.

Note: Some Windows operating systems require that the user has administrative access to install printer drivers on the computer.

- 6 Specify the location of the custom printer driver on the drivers CD.

The path should be similar to the following:

D:\Drivers\Print\Win_9xMe\<language>

Where D is the letter of the CD-ROM drive.

- 7 Click **OK**.

It may take some time for the drivers to load.

- 8 Close the drivers CD.

Serial printing













With serial printing, data is transferred one bit at a time. Although serial printing is usually slower than parallel printing, it is the preferred option when there is a great deal of distance between the printer and computer, or when a parallel interface is not available.

Note: A serial interface card is required and can be purchased separately.

Before printing, establishing communication between the printer and computer is required. To do this:

- 1 Set serial parameters in the printer.
- 2 Install a printer driver on the attached computer.
- 3 Match the serial settings in the COM port.







Setting parameters in the printer

- 1 Press  on the operator panel.
- 2 Press  until  **Network/Ports** appears, and then press .
- 3 Press  until  **Serial Option X** appears, and then press .
- 4 Press  until  **<Parameter>** appears, and then press  (where **<Parameter>** is the parameter required for a change).
- 5 Press  until  **<Setting>** appears, and then press  (where **<Setting>** is the setting required for a change).

Note the following restrictions:

- Maximum baud rate supported is 115,200.
 - Data Bits must be set to 7 or 8.
 - Parity must be set to Even, Odd, or None.
 - Stop Bits must be set to 2.
 - Flow Control recommended protocol setting is Xon/Xoff.
- 6 Press  repeatedly to return the printer to the Ready state.
 - 7 Print a Menu Settings page, and verify that the serial parameters are correct.

Note: Keep this page for later use.

- a Press  on the operator panel.
- b Press  until  **Reports** appears, and then press .
- c Press  until  **Menu Settings Page** appears, and then press .
- d Look under the Standard Serial (or Serial Option X if a serial interface card is installed) heading to find the serial parameters.

Installing a printer driver

A printer driver must be installed on the computer that is connected to the printer.

Note: Windows 95 and Windows 98 (first edition) users should follow the installation directions in **Using Windows 95 and Windows 98 (first edition)**.

- 1 Insert the drivers CD. It should launch automatically. If the CD does not launch automatically, click **Start → Run**, and type the following in the Run dialog:

D: \Setup.exe

Where D is the letter of the CD-ROM drive.

Installing drivers for local printing

- 2 Click **Install Printer and Software**.
- 3 Click **Agree** to accept the Printer Software License Agreement.
- 4 Select **Custom**, and click **Next**.
- 5 Select **Components**, and click **Next**.
- 6 Select **Local**, and click **Next**.
- 7 Select the printer from the list, and click **Add Printer**.
- 8 Expand the printer item listed below Selected Components.
- 9 Click **PORT: <LPT1>**, and select the communications port (COM1 or COM2) needed for use.
- 10 Click **Finish** to complete the printer software installation.

Setting parameters in the communications (COM) port

After the printer driver is installed, the serial parameters must be set for the communications port assigned to the printer driver.

The serial parameters in the communications port must match exactly to the serial parameters set in the printer.

- 1 Click **Start → Settings → Control Panel**, and double-click **System**.
- 2 On the **Device Manager** tab, click **+** to expand the list of available ports.
- 3 Select the communications port assigned to the printer (COM1 or COM2).
- 4 Click **Properties**.
- 5 On the **Port Settings** tab, set the serial parameters to the exact same serial parameters in the printer.
Look for the printer settings under the Serial Standard (or Serial Option X) heading on the Menu Settings page printed previously.
- 6 Click **OK**, and close all the windows.
- 7 Print a test page to verify printer installation.
 - a Click **Start → Settings → Printers**.
 - b Select the printer just added.
 - c Click **File → Properties**.
 - d Click **Print Test Page**. When a test page prints successfully, printer setup is complete.

Macintosh

Mac OS 9.x or later is required for USB printing. To print locally to a USB-attached printer, create a desktop printer icon (Mac OS 9) or create a queue in Print Center / Printer Setup Utility (Mac OS X).

Creating a queue in Print Center / Printer Setup Utility (Mac OS X)

- 1 Install a PostScript Printer Description (PPD) file on the computer.
 - a Insert the drivers CD.
 - b Double-click the installer package for the printer.

Note: A PPD file provides detailed information about the capabilities of a printer to the Macintosh computer.
 - c Click **Continue** on the Welcome screen and again after viewing the Readme file.
 - d Click **Continue** after viewing the license agreement, and click **Agree** to accept the terms of the agreement.
 - e Select a Destination, and click **Continue**.
 - f On the Easy Install screen, click **Install**.
 - g Enter the user password, and click **OK**. All the necessary software is installed on the computer.
 - h Click **Close** when installation is complete.
- 2 Open Finder, click **Applications**, and click **Utilities**.
- 3 Double-click **Print Center** or **Printer Setup Utility**.
- 4 Do one of the following:
 - If the USB-attached printer appears in the Printer List, quit Print Center or Printer Setup Utility. A queue has been created for the printer.
 - If the USB-attached printer does not appear in the Printer List, make sure the USB cable is properly connected and the printer is turned on. After the printer appears in the Printer List, quit Print Center or Printer Setup Utility.

Creating a desktop printer icon (Mac OS 9.x)

- 1 Install a PostScript Printer Description (PPD) file on the computer.
 - a Insert the drivers CD.
 - b Double-click **Classic**, and double-click the installer package for the printer.

Note: A PPD file provides detailed information about the capabilities of a printer to the Macintosh computer.
 - c Choose the language needed for use, and click **Continue**.
 - d Click **Continue** after viewing the Readme file.
 - e Click **Continue** after viewing the license agreement, and click **Agree** to accept the terms of the agreement.
 - f On the Easy Install screen, click **Install**. All the necessary files are installed on the computer.
 - g Click **Close** when installation is complete.
- 2 Do one of the following:
 - For *Mac OS 9.0*: Open **Apple LaserWriter**.
 - For *Mac OS 9.1–9.x*: Open **Applications**, and click **Utilities**.
- 3 Double-click **Desktop Printer Utility**.

Installing drivers for local printing

- 4 Select **Printer (USB)**, and click **OK**.
- 5 In the USB Printer Selection section, click **Change**.
If the printer does not appear in the USB Printer Selection list, make sure the USB cable is properly connected, and the printer is turned on.
- 6 Select the name of the printer, and click **OK**. The printer appears in the original Printer (USB) window.
- 7 In the PostScript Printer Description (PPD) File section, click **Auto Setup**. Make sure the printer PPD now matches the printer in use.
- 8 Click **Create**, and click **Save**.
- 9 Specify a printer name, and click **Save**. The printer is now saved as a desktop printer.

UNIX/Linux

Local printing is supported on many UNIX and Linux platforms, such as Sun Solaris and Red Hat.

If the drivers CD does not contain any UNIX/Linux printer driver packages, contact the place where you bought the printer to see if the printer is supported.

Some printer driver packages are available on the drivers CD. The UNIX/Linux *User's Guide* in each package gives detailed instructions for installing and using printers in UNIX and Linux environments.







All the printer driver packages support local printing using a parallel connection. The driver package for Sun Solaris supports USB connections to Sun Ray appliances and Sun workstations.

3

Installing drivers for network printing

Printing a network setup page

If the printer is attached to a network, print a network setup page on the printer to verify the network connection. This page also provides important information that helps in configuring for network printing.

- 1 Make sure the printer is on.
- 2 Press  on the operator panel.
- 3 Press  until  **Reports** appears, and then press .
- 4 Press  until  **Network Setup Page** appears, and then press .

Note: If an optional internal print server is installed, **Print Net1 Setup** appears on the display.

- 5 Check the first section on the network setup page, and confirm that Status is “Connected.”







If Status is “Not Connected” the LAN drop may not be active, or the network cable may be malfunctioning. Consult a system support person for a solution, and print another network setup page to verify that the printer is connected to the network.

Assigning a printer IP address











If the network is using DHCP, an IP address is automatically assigned after connecting the network cable to the printer.

- 1 Look for the address under the “TCP/IP” heading on the network setup page printed in **Printing a network setup page**.
- 2 Go to **Verifying the IP settings**, and begin with step 2.



If the network is not using DHCP, then manually assign an IP address to the printer. One of the easiest ways is to use the operator panel:

- 1 Press  on the operator panel.
- 2 Press  until  **Network/Ports** appears, and then press .
- 3 Press  until  **TCP/IP** appears, and then press .

Standard Network appears if the printer has a network port on the printer system board. If an internal print server is installed in the option card, **Network Option 1** appears.

- 4 Press  until  **Address** appears, and then press .
- 5 Using the numeric pad, enter the IP address. Once the address is entered, press .
submitting selection appears briefly.
- 6 Press  until  **Netmask** appears, and then press .
- 7 Using the numeric pad, enter the IP address. Once the address is entered, press .
submitting selection appears briefly.
- 8 Press  until  **Gateway** appears, and then press .

Installing drivers for network printing

- 9 Using the numeric pad, enter the IP address. Once the address is entered, press . **submitting selection** appears briefly.
- 10 Press  repeatedly until the printer returns to **Ready**.

Verifying the IP settings

- 1 Print another network setup page. Look under the “TCP/IP” heading, and make sure the IP address, netmask, and gateway are correct. See **Printing a network setup page on page 17** if help is needed.
- 2 Ping the printer, and verify that it responds. At a command prompt on a network computer, type `ping` followed by the new printer IP address (for example, `192.168.0.11`).

Note: On Windows computers, click **Start → Programs → Command prompt** (or **Accessories → Command prompt** if using Windows 2000).

If the printer is active on the network, a reply is sent.

After the TCP/IP settings are assigned and verified, install the printer on each network computer.

Windows

In Windows environments, network printers can be configured for direct printing or shared printing. Both network printing methods require the installation of a printer driver and the creation of a network printer port.

Supported printer drivers

- Windows system printer driver
- Custom printer driver

System drivers are built into Windows operating systems. Custom drivers are available on the drivers CD.

Supported network printer ports

- Microsoft Standard TCP/IP port—Windows 2000, Windows XP, and Windows Server 2003
- LPR—Windows NT 4.0
- Printer network ports—Windows 98 SE/Me, Windows 2000, Windows XP, and Windows Server 2003

For basic printer functionality, install a system printer driver and use a system network printer port, such as an LPR or a Standard TCP/IP port. The system printer driver and port allow for a consistent user interface for use with all the printers on the network. However, using a custom printer driver and network port provides enhanced functionality, such as printer status alerts.

Installing drivers for network printing

Follow the steps for the printing configuration and operating system in use to configure the network printer:

Printing configuration	Operating system	Go to page
Direct <ul style="list-style-type: none">Printer is connected directly to the network using a network cable, such as Ethernet.Printer drivers are typically installed on each network computer.	Windows 98 SE, Windows NT 4.0, Windows Me, Windows 2000, Windows XP, or Windows Server 2003	19
Shared <ul style="list-style-type: none">Printer is connected to one of the computers on the network using a local cable, such as USB.Printer drivers are installed on the computer attached to the printer.During driver installation, the printer is set up to be “shared” so that other network computers can print to it.	Windows NT 4.0, Windows 2000, Windows XP, or Windows Server 2003	19

Direct printing using Windows 98 SE, Me, Windows NT 4.0, Windows 2000, Windows XP, or Windows Server 2003

To install a custom printer driver and network port:

- 1 Launch the drivers CD.
- 2 Click **Install Printer and Software**.
- 3 Click **Agree** to accept the license agreement.
- 4 Select **Suggested**, and click **Next**.
- 5 Select **Network Attach**, and click **Next**.
- 6 Select the printer model from the list, and click **Next**.
- 7 Select the printer port from the list, and click **Finish** to complete the installation.

If the printer port is not listed:

- a Click **Add Port**.
- b Select **Enhanced TCP/IP Network Port**, and enter the information to create the port.
- c Enter a port name.
This can be any name to associate with the printer, such as `Color1-lab4`. After the port is created, this name appears in the list of available ports.
- d Enter the IP address in the text box.

Note: If the IP address is unknown, print a network setup page, and look under the TCP/IP heading. For help, see **Printing a network setup page** and **Verifying the IP settings**.

- 8 Print a test page to verify printer installation.

Shared printing using Windows NT 4.0, Windows 2000, Windows XP, or Windows Server 2003

Note: Install the printer software before connecting the USB cable.

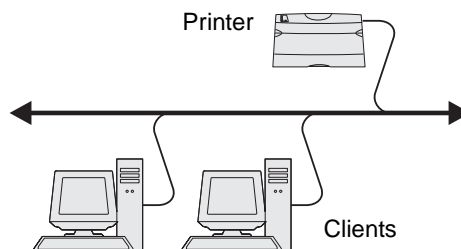

Installing drivers for network printing

After connecting the printer to a Windows NT 4.0, Windows 2000, Windows XP, or Windows Server 2003 computer (which will act as a server), follow these steps to configure the network printer for shared printing:

1 Install a custom printer driver.

- a Launch the drivers CD.
- b Click **Install Printer and Software**.
- c Click **Agree** to accept the license agreement.
- d Select **Suggested**, and click **Next**.

The Suggested option is the default installation for local and network-attached setup. To install utilities, change settings, or customize device drivers, select **Custom**, and follow the instructions on the screen.

- e Select **Local Attach**, and click **Finish**.

Follow the instructions on the screen. It may take some time for the drivers to load.

- f Close the drivers CD installer application.
- g Connect the USB cable, and turn on the printer.

The Plug and Play screen appears, and a printer object is created in the Printers folder of the computer. The printer is shared in step 2: "Share the printer on the network."

- h Print a test page to verify printer installation.

2 Share the printer on the network.

- a Click **Start** → **Settings** → **Printers**.
- b Select the printer just added.
- c Click **File** → **Sharing**.
- d Select the **Shared as** check box, and enter a name in the text box.
- e In the Alternate Drivers section, select the operating systems of all the network clients that will print to the printer.
- f Click **OK**.

Note: If files are missing, prompts may appear to request the server operating system CD.

- g Check the following to make sure the printer was successfully shared.

- The printer object in the Printers folder now has a shared indicator. For example, in Windows NT 4.0, a hand appears under the printer object.
- Browse Network Neighborhood. Find the host name of the server, and look for the shared name assigned to the printer.

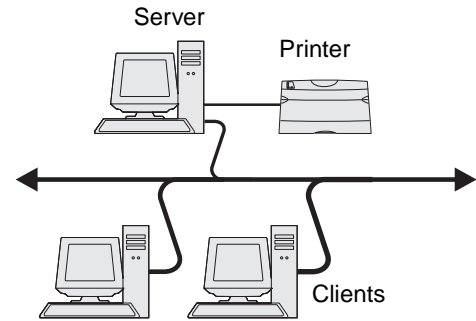

Install the printer driver (or subset) on network clients

Using the point and print method

Note: This method is usually the best use of system resources. The server handles driver modifications and the print job processing. This lets network clients return to applications much faster.

Installing drivers for network printing

With this method, a subset of driver information is copied from the server to the client computer. This is just enough information to send a print job to the printer.

- 1 Double-click **Network Neighborhood** on the Windows desktop of the client computer.
- 2 Locate the host name of the server computer, and double-click the host name.
- 3 Right-click the shared printer name, and click **Install**.

Wait a few minutes for the driver information to be copied from the server computer to the client computer and for a new printer object to be added to the Printers folder. The time this takes varies based on network traffic and other factors.

- 4 Close **Network Neighborhood**.
- 5 Print a test page to verify printer installation.

Using the peer-to-peer method

With this method, the printer driver is fully installed on each client computer. Network clients retain control of driver modifications. The client computer handles the print job processing.

- 1 Click **Start** → **Settings** → **Printers**.
- 2 Click **Add Printer** to launch the Add Printer wizard.
- 3 Click **Next**.
- 4 Click **Network Printer**, and click **Next**.
- 5 Enter the printer name or URL (if on the Internet or an intranet), and click **Next**.
If the printer name or URL is unknown, leave the text box blank, and click **Next**.
- 6 Select the network printer from the Shared printers list. If the printer is not listed, enter the path of the printer in the text box.

The path looks similar to the following:

```
\\<server host name>\<shared printer name>
```

Note: If this is a new printer, prompts may occur to install a printer driver. If no system driver is available, provide a path to available drivers.

The server host name is the name of the server computer that identifies it to the network. The shared printer name is the name assigned during the server installation process.

- 7 Click **OK**.
- 8 Select whether this printer will be the default printer for the client, and click **Finish**.
- 9 Print a test page to verify printer installation.

Configuring Drag'N'Print

Note: Drag'N'Print™ support is not available for all printers.

For detailed configuration instructions, launch the drivers CD, click **View Documentation**, and click **Software and utilities**.

Macintosh

Note: A PostScript Printer Description (PPD) file provides detailed information about the capabilities of a printer to UNIX or Macintosh computers.

Installing drivers for network printing

To print to a network printer, each Macintosh user must install a custom PostScript Printer Description (PPD) file, and either create a desktop printer on the computer (Mac OS 9.x) or create a print queue in Print Center (Mac OS X).

Mac OS X

Step 1: Install a custom PPD file

1 Install a PostScript Printer Description (PPD) file on the computer.

- a Insert the drivers CD.
- b Double-click the installer package for the printer.

Note: A PPD file provides detailed information about the capabilities of a printer to the Macintosh computer.

- c Click **Continue** on the Welcome screen and again after viewing the Readme file.
- d Click **Continue** after viewing the license agreement, and click **Agree** to accept the terms of the agreement.
- e Select a Destination, and click **Continue**.
- f On the Easy Install screen, click **Install**.
- g Enter the user password, and click **OK**. All the necessary software is installed on the computer.
- h Click **Close** when installation is complete.

Step 2: Create a print queue in Print Center or Printer Setup Utility

Using AppleTalk Printing

Follow these steps to create a print queue using AppleTalk Printing.

- 1 Open Finder, click **Applications**, and click **Utilities**.
- 2 Double-click **Print Center or Printer Setup Utility**.
- 3 Choose **Add Printer** from the "Printers" menu.
- 4 Choose **AppleTalk** from the pop-up menu.

Note: Look on the network setup page under the "AppleTalk" heading to know which zone or printer to select.

- 5 Select the AppleTalk zone from the list.
- 6 Select the new printer from the list, and click **Add**.
- 7 Verify printer installation:
 - a Open Finder, click **Applications**, and click **TextEdit**.
 - b Choose **Print** from the "File" menu.
 - c Choose **Summary** from the "Copies & Pages" pop-up menu.

Note: Look on the Network Setup page under the "AppleTalk" heading to find the default name of the printer to know which printer to select.

- If the PPD file displayed in the Summary window is correct for the printer, then printer setup is complete.
- If the PPD file displayed in the Summary window is *not* correct for the printer, delete the printer from the printer list in Print Center or Printer Setup Utility, and repeat **Step 1: Install a custom PPD file**.

Using IP Printing

Follow these steps to create a print queue using IP Printing. To create an AppleTalk print queue, see **Step 2: Create a print queue in Print Center or Printer Setup Utility**.

- 1 Open Finder, click **Applications**, and click **Utilities**.
- 2 Double-click **Print Center or Printer Setup Utility**.
- 3 Choose **Add Printer** from the "Printers" menu.
- 4 Choose **IP Printing** from the pop-up menu.
- 5 Enter the IP address or the printer DNS name in the Printer Address box.
- 6 Choose the printer manufacturer from the "Printer Model" pop-up menu.
- 7 Select the new printer from the list, and click **Add**.
- 8 Verify printer installation:
 - a Open Finder, click **Applications**, and click **TextEdit**.
 - b Choose **Print** from the "File" menu.
 - c Choose **Summary** from the "Copies & Pages" pop-up menu.
 - d Do one of the following:
 - If the PPD file displayed in the Summary window is correct for the printer, then printer setup is complete.
 - If the PPD file displayed in the Summary window is *not* correct for the printer, delete the printer from the printer list in Print Center or Printer Setup Utility, and repeat **Step 1: Install a custom PPD file**.

Mac OS 9.x

Step 1: Install a custom PPD file

- 1 Insert the drivers CD.
 - a Double-click **Classic**, and double-click the installer package for the printer.

Note: A PPD file provides detailed information about the capabilities of a printer to the Macintosh computer.
 - b Choose the language needed for use, and click **Continue**.
 - c Click **Continue** after viewing the Readme file.
 - d Click **Continue** after viewing the license agreement, and click **Agree** to accept the terms of the agreement.
 - e On the Easy Install screen, click **Install**. All the necessary files are installed on the computer.
 - f Click **Close** when installation is complete.

Note:

Step 2: Create a desktop printer

- 1 In the Chooser, select the **LaserWriter 8** driver.
- 2 For a routed network, select the default zone from the list. For the zone to select, look on the Network Setup page under AppleTalk for Zone.
- 3 Select the new printer from the list.
- 4 For printer to select, look on the Network Setup page under the "AppleTalk" heading to find the default name of the printer.

Installing drivers for network printing

- 5 Click **Create**.
- 6 Make sure there is an icon next to the printer name in the Chooser.
- 7 Close the Chooser window.
- 8 Verify printer installation.
 - a Click the desktop printer icon just added.
 - b Choose **Printing** → **Change Setup**.
 - If the PPD file displayed in the PostScript Printer Description (PPD) file portion of the menu is correct for the printer, printer setup is complete.
 - If the PPD file displayed in the PostScript Printer Description (PPD) file portion of the menu is *not* correct for the printer, repeat **Step 1: Install a custom PPD file**.

UNIX/Linux

The printer supports both UNIX and Linux network environments. For the latest information about installing a network printer in a UNIX or Linux environment, launch the drivers CD, and click **View Documentation**.

NetWare

The printer supports Novell Distributed Print Services (NDPS/iPrint). For the latest information about installing a network printer in a NetWare environment, launch the drivers CD, and click **View Documentation**.

4

Installing options

CAUTION: If you are installing memory or option cards sometime after setting up the printer, turn the printer off and unplug the power cord before continuing.

You can customize the printer memory capacity and connectivity by adding optional cards. The instructions in this section help you install any of the following options:

- Memory cards
 - Printer memory
 - Flash memory
- Firmware cards
 - Bar Code
 - Forms
 - IPDS and SCS/TNe
 - PRESCRIBE
 - PrintCryption™
- Other options
 - Printer hard disk
 - External Serial Adapter
 - Tri-Port Adapter
 - Infrared Adapter
 - USB/Parallel 1284-C interface card
 - Coax/Twinax Adapter
 - Internal print servers (also called internal network adapters or INAs)

Accessing the printer system board

You must access the printer system board to install printer memory, flash memory, a hard disk, or an option card.

CAUTION: Turn the printer off, and unplug the power cord before continuing.

- 1 Loosen the screws on the access panel located on the back side of the printer.

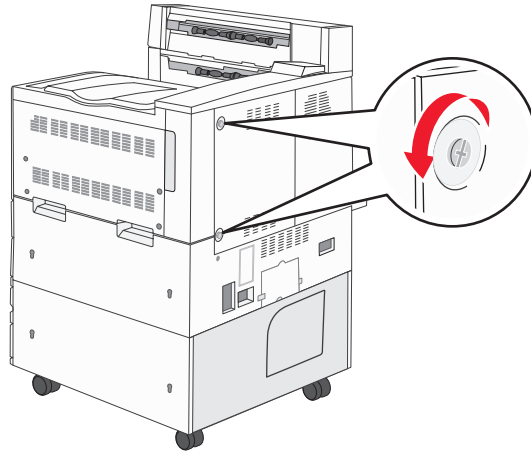

- 2 Remove the panel from the printer, and set it aside.

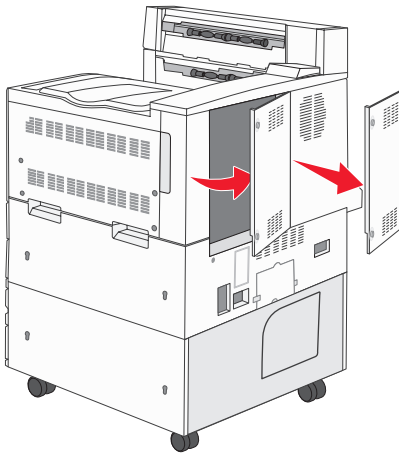

Installing options

Use the illustration to locate the connector for the option you want to install.

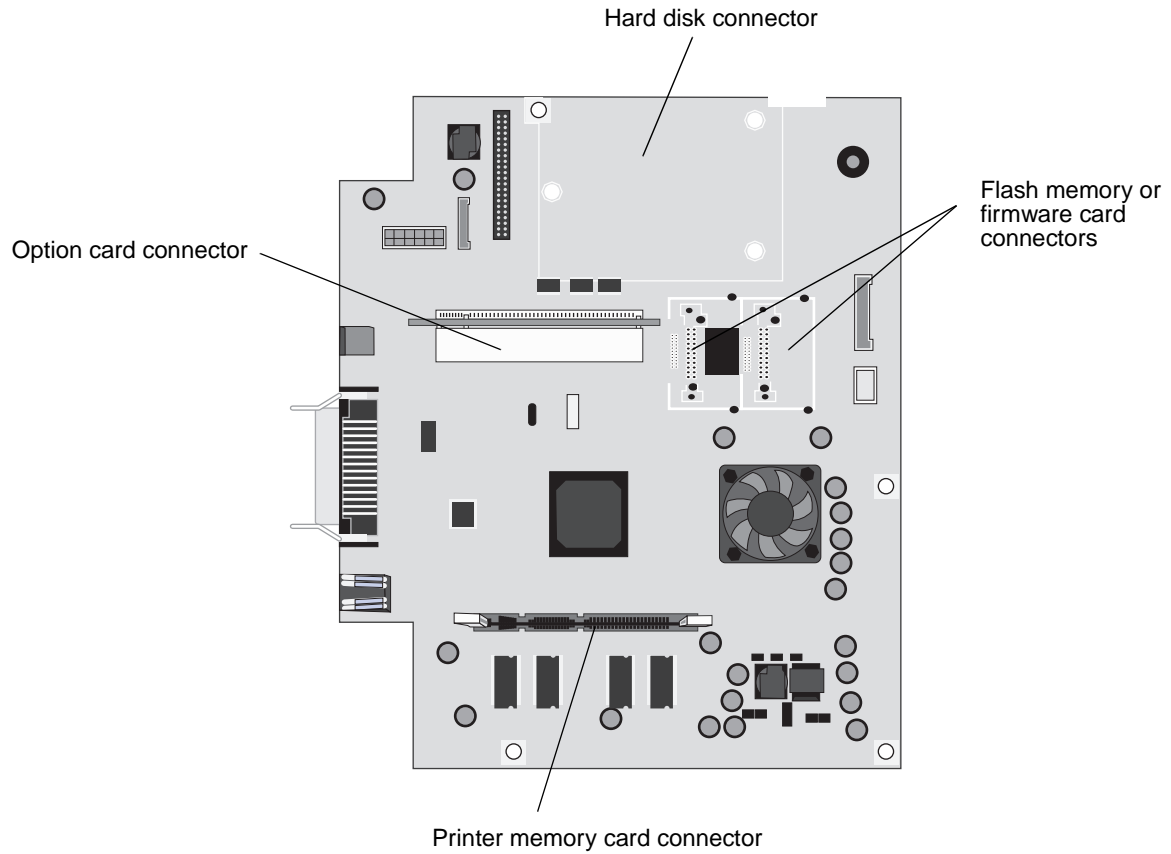

Installing a printer memory card

Complete the following instructions to install a printer memory card.

Note: Memory cards designed for other printers may not work with your printer.

- 1 Remove the system board access panel. (See **Accessing the printer system board.**)
- 2 Push open the latches on both ends of the memory card connector.
- 3 Unpack the memory card.

Warning: Printer memory cards are easily damaged by static electricity. Touch something metal such as the printer frame before you touch a memory card.

Avoid touching the connection points along the edge of the card. Save the packaging.

- 4 Align the notches on the bottom of the card with the notches on the connector.
- 5 Push the memory card firmly into the connector until the latches on either end of the connector *snap* into place. It may require some force to fully seat the card.

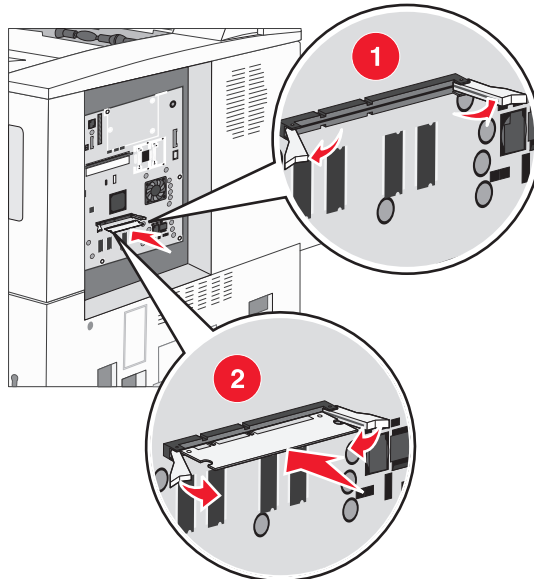

- 6 Make sure each latch fits over the notch on the end of the card.

Installing a flash memory or firmware card

Note: Flash memory and firmware cards designed for other printers may not work with your printer.

- 1 Remove the system board access panel. (See **Accessing the printer system board.**)
- 2 Unpack the flash memory or firmware card.

Warning: Flash memory and firmware cards are easily damaged by static electricity. Touch something metal such as the printer frame before you touch a card.

- 3 Holding the flash memory or firmware card by the locking clips, align the plastic pins on the card with the holes on the system board.

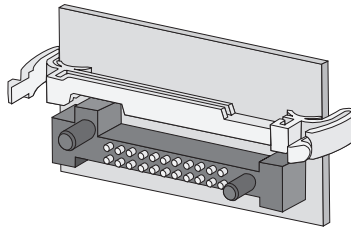

- 4 Push the flash memory or firmware card firmly into place, and release the locking clips.

The entire length of the connector on the flash memory or firmware card must touch the system board and be locked into the connector.

Be careful not to damage the connectors.

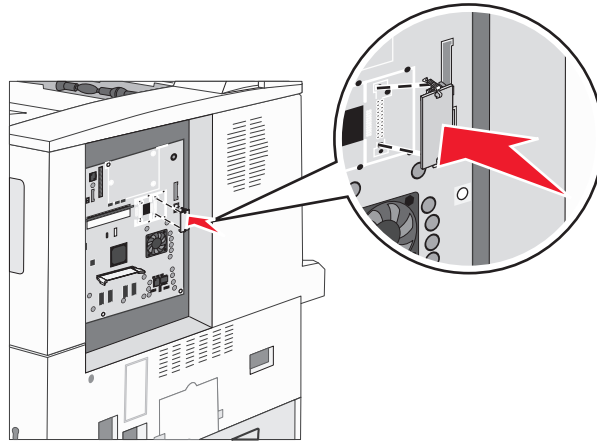

Installing an option card

Warning: Option cards are easily damaged by static electricity. Touch something metal such as the printer frame before you touch a memory card.

Note: You need a small Phillips screwdriver to attach the option card to the system board.

- 1 Remove the system board access panel. (See **Accessing the printer system board**.)
- 2 Open the system board door.

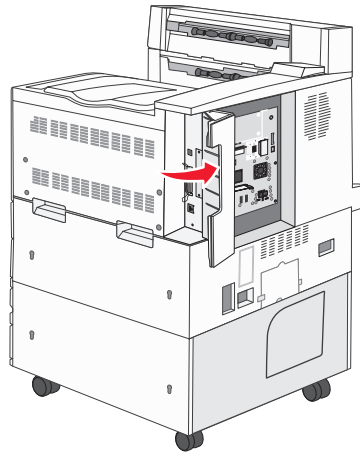

- 3 Locate the card connector on the system board.
- 4 Remove the screws and the cover plate, and save them.

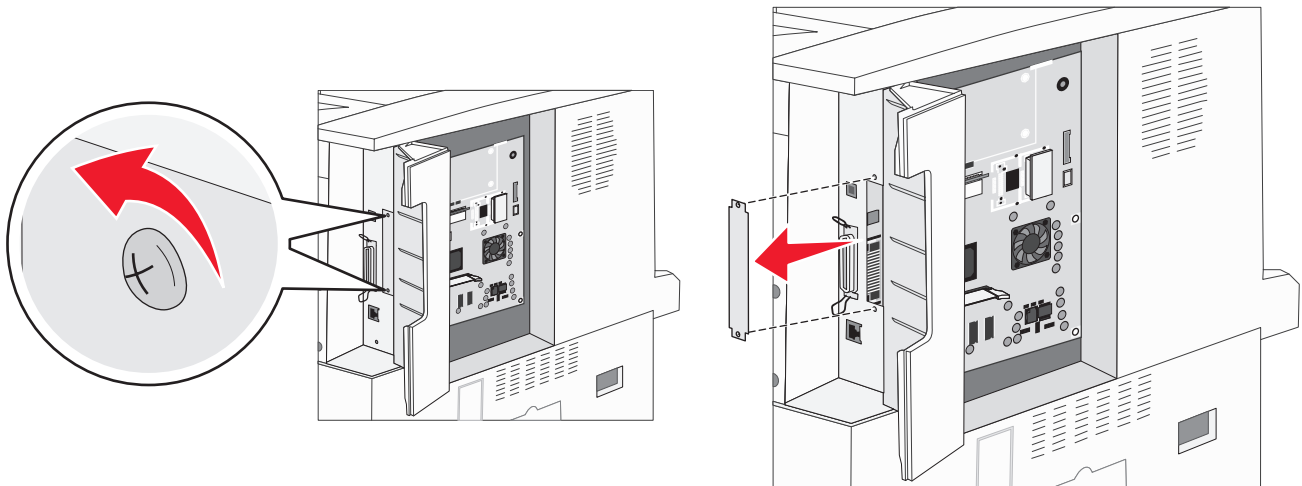

- 5 Unpack the card. Save the packaging materials.

Installing options

- 6 Align the connection points on the card with the connector on the system board, and push the card firmly into the system board connector.

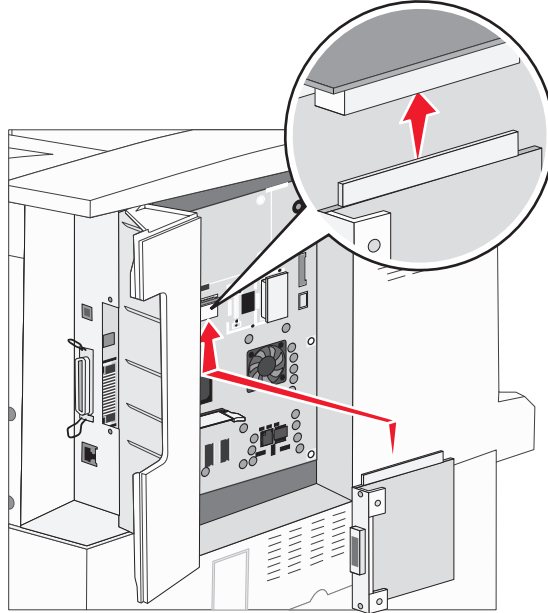

- 7 Insert the screws saved from the cover plate (or the extra screws shipped with the card).
- 8 Tighten the screws to secure the card.

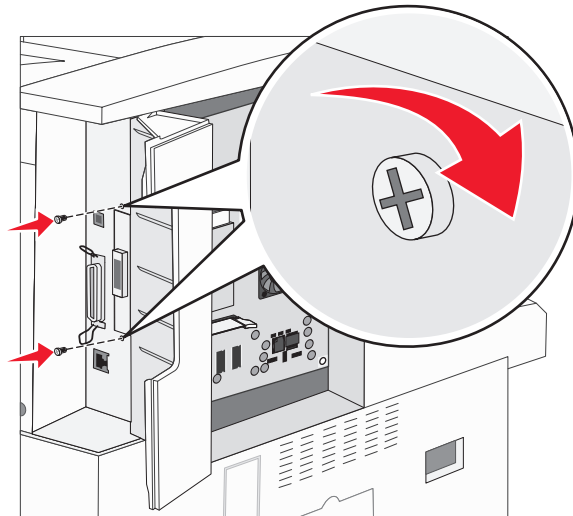

Installing a hard disk

Note: You need a small Phillips screwdriver to attach the hard disk to the mounting plate.

- 1 Remove the system board access panel. (See **Accessing the printer system board.**)
- 2 Remove the mounting plate, hard disk, ribbon cable, and attachment screws from the package.
- 3 Align the ribbon cable connector with the connector pins on the hard disk.
- 4 Attach the ribbon cable to the hard disk.

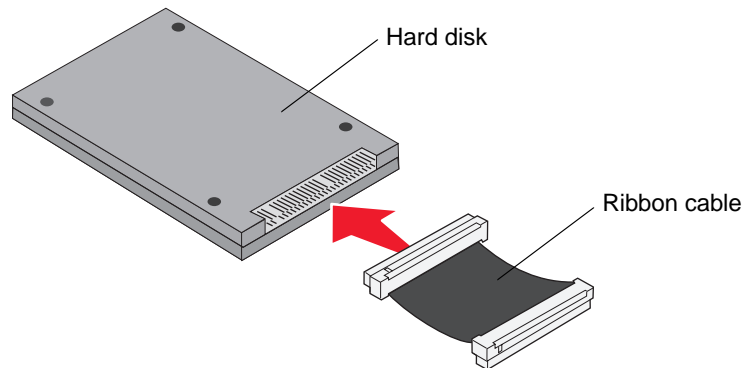

- 5 Align the screw holes on the mounting plate with the holes in the hard disk.
- 6 Secure the mounting plate to the hard disk with the screws.

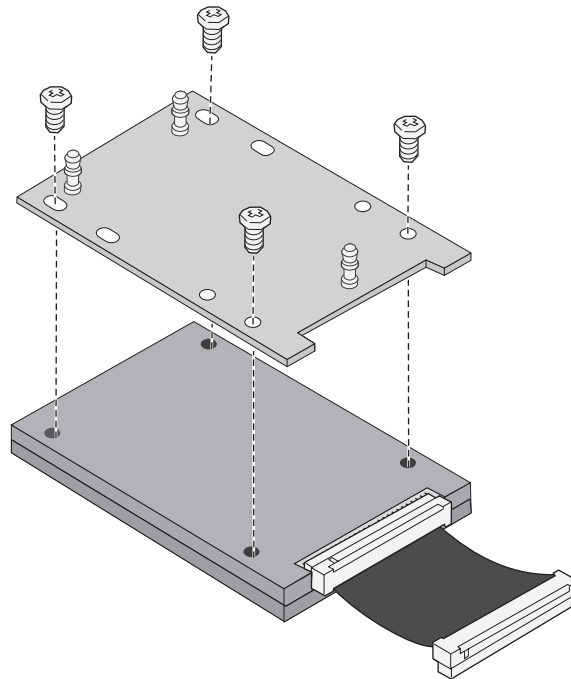

Installing options

- 7 Press the ribbon cable connector into the connector on the system board.

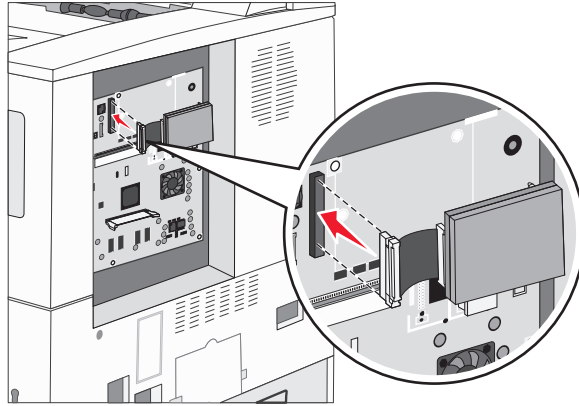

- 8 Press the three posts on the mounting plate into the holes on the system board. The hard disk *snaps* into place.

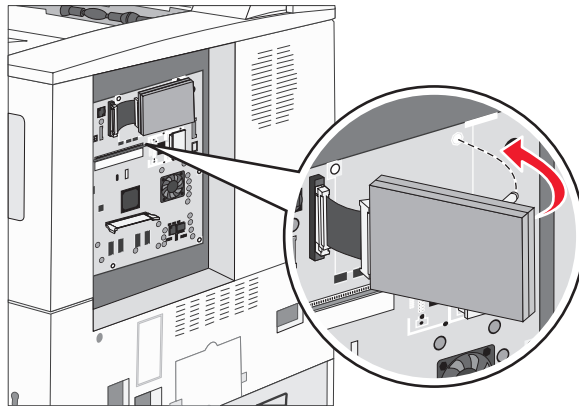

Replacing the access panel

After you have installed options on the printer system board, follow these steps to reattach the access panel.

- 1 Align the tabs on the right side of the access panel with the slots on the printer.
- 2 Slide the panel to the right and towards the printer.

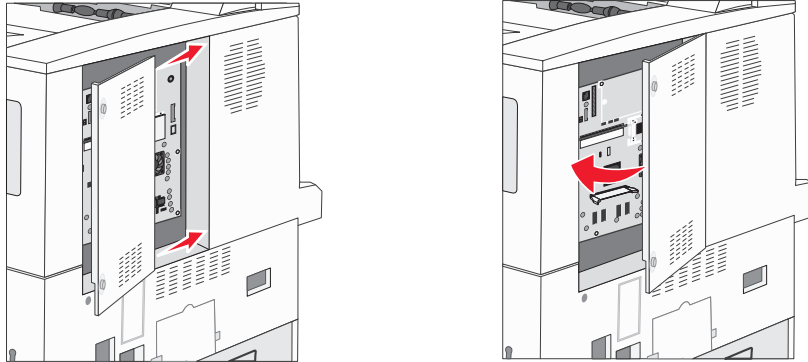

- 3 Tighten the screws.

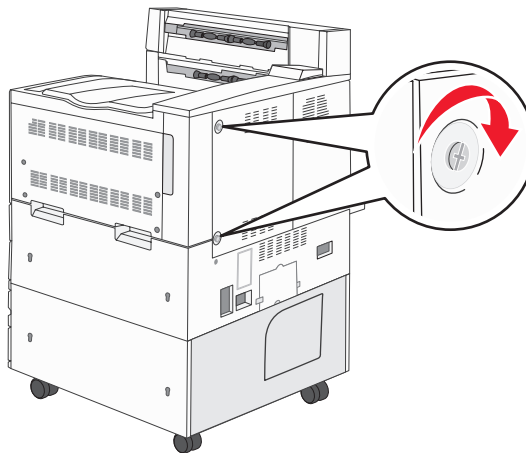

- 4 Plug the printer power cord back into a properly grounded electrical outlet and turn on the printer.

5

Understanding paper and specialty media guidelines

Print media is paper, card stock, transparencies, labels, and envelopes. The last four are sometimes referred to as *specialty media*. The printer provides high quality printing on a variety of media. A number of things must be considered concerning media before printing. This chapter provides information on making media selections and caring for media.

- **Supported print media**
- **Selecting print media**
- **Storing print media**
- **Avoiding jams**

We recommend that you try a limited sample of any paper or specialty media you are considering using with the printer before purchasing large quantities.

Supported print media

The following tables provide information on standard and optional sources for both input and output trays and bins.

- **Print media sizes**
- **Media sizes supported in the finisher**
- **Feed characteristics by print media size**
- **Print media types**
- **Print media weights**
- **Media weights supported in the finisher**

Note: If you use a print media size not listed, select the next larger size.

Print media sizes

✓ — indicates support		500-sheet trays (standard and option)	Multipurpose feeder	2000-sheet dual input trays (option)	2000-sheet high capacity feeder (option)	Duplex unit (option)	500-sheet standard output bin	300-sheet second exit output bin ³
Print media size	Dimensions							
A3	297 x 420 mm (11.7 x 16.5 in.)	✓	✓			✓	✓	✓
A4	210 x 297 mm (8.27 x 11.7 in.)	✓	✓	✓	✓	✓	✓	✓
A5 ¹	148 x 210 mm (5.83 x 8.27 in.)	✓	✓			✓	✓	✓

¹ These sizes may not appear in the Paper Size menu until Auto Size Sensing is changed. See **Printing A5/Statement or JIS-B5/Executive sizes on page 69** for more information.

² This size setting formats the page for 297.0 x 431.8 mm (11.7 x 17.0 in.) unless the size is specified by the software application.

³ This output bin is only available when the finisher is installed.

Understanding paper and specialty media guidelines

Print media sizes(continued)

✓ — indicates support		500-sheet trays (standard and option)	Multipurpose feeder	2000-sheet dual input trays (option)	2000-sheet high capacity feeder (option)	Duplex unit (option)	500-sheet standard output bin	300-sheet second exit output bin ³
Print media size	Dimensions							
JIS B4	257 x 364 mm (10.1 x 14.3 in.)	✓	✓			✓	✓	✓
JIS B5¹	182 x 257 mm (7.17 x 10.1 in.)	✓	✓	✓	✓	✓	✓	✓
Letter	215.9 x 279.4 mm (8.5 x 11 in.)	✓	✓	✓	✓	✓	✓	✓
Legal	215.9 x 355.6 mm (8.5 x 14 in.)	✓	✓			✓	✓	✓
Executive¹	184.2 x 266.7 mm (7.25 x 10.5 in.)	✓	✓	✓	✓	✓	✓	✓
Folio	216 x 330 mm (8.5 x 13 in.)	✓	✓			✓	✓	✓
Statement¹	139.7 x 215.9 mm (5.5 x 8.5 in.)	✓	✓			✓	✓	✓
Tabloid	279 x 432 mm (11.0 x 17.0 in.)	✓	✓			✓	✓	✓
Universal²	98.4 x 89.0 mm to 297.0 x 431.8 mm (3.9 x 3.5 in. to 11.7 x 17.0 in.)	✓	✓			✓	✓	✓
7 ¾ Envelope	98.4 x 190.5 mm (3.875 x 7.5 in.)		✓				✓	✓
10 Envelope	104.8 x 241.3 mm (4.12 x 9.5 in.)		✓				✓	✓
DL Envelope	110 x 220 mm (4.33 x 8.66 in.)		✓				✓	✓
C5 Envelope	162 x 229 mm (6.38 x 9.01 in.)		✓				✓	✓
Other Envelope	98.4 x 89.0 mm to 297.0 x 431.8 mm (3.9 x 3.5 in. to 11.7 x 17.0 in.)		✓				✓	✓

¹ These sizes may not appear in the Paper Size menu until Auto Size Sensing is changed. See **Printing A5/Statement or JIS-B5/Executive sizes on page 69** for more information.

² This size setting formats the page for 297.0 x 431.8 mm (11.7 x 17.0 in.) unless the size is specified by the software application.

³ This output bin is only available when the finisher is installed.

Understanding paper and specialty media guidelines

Media sizes supported in the finisher

Size	Bin 1				Bin 2			
	Standard*	Offset	Staple	Punch	Standard*	Offset	Staple	Punch
A3	✓				✓	✓	✓	✓
A4	✓				✓	✓	✓	✓
A5	✓							
JIS B4	✓				✓	✓	✓	✓
JIS B5	✓				✓	✓	✓	✓
Letter	✓				✓	✓	✓	✓
Legal	✓				✓	✓	✓	✓
Executive	✓				✓	✓	✓	✓
Folio	✓				✓	✓	✓	✓
Statement	✓							
Tabloid	✓				✓	✓	✓	✓
Universal								
7 ¾ Envelope								
10 Envelope								
DL Envelope								
C5 Envelope								
Other Envelope								

* Paper passes to the finisher bin without being stapled or offset.

Understanding paper and specialty media guidelines

Feed characteristics by print media size

Print media size	Feed orientation ¹	Print media orientation ²	Size supports duplex
A3	Portrait	Short-edge	✓
A4	Portrait or Landscape	Short-edge or Long-edge	✓
A5	Portrait	Short-edge	✓
JIS B4	Portrait	Short-edge	✓
JIS B5	Landscape	Long-edge	✓
Letter	Portrait or Landscape	Short-edge or Long-edge	✓
Legal	Portrait	Short-edge	✓
Executive	Landscape	Long-edge	✓
Folio	Portrait	Short-edge	✓
Statement	Portrait	Short-edge	✓
Tabloid	Portrait	Short-edge	✓
Universal	Portrait ³	Short-edge	✓
7 ¾ Envelope	Landscape	Long-edge	
10 Envelope	Landscape	Long-edge	
DL Envelope	Landscape	Long-edge	
C5 Envelope	Landscape	Long-edge	
Other Envelope	Portrait	Short-edge	

¹ Feed orientation indicates how the printer will place the image on the page, not whether the physical page will be short-edge or long-edge oriented.

² Short-edge Printing must be enabled for the printer to recognize letter or A4 size print media loaded in the short-edge orientation. For more information, see **Loading Letter or A4 size print media in the short-edge feed orientation on page 58**.

³ The feed orientation for Universal is actually variable.

Understanding paper and specialty media guidelines

Print media types

Print media	500-sheet trays	Multipurpose feeder	2000-sheet dual input trays	2000-sheet high capacity feeder	Duplex unit	Standard output bin	Second exit output bin	Finisher			
								Standard	Offset	Stapled	Hole Punch
Paper	✓	✓	✓	✓	✓	✓	✓	✓	✓	✓	✓
Card stock	✓	✓				✓	✓	✓	✓		
Transparencies	✓	✓				✓	✓				
Paper labels	✓	✓				✓	✓				
Bond	✓	✓	✓	✓	✓	✓	✓	✓	✓	✓	✓
Envelope		✓				✓	✓				
Letterhead	✓	✓	✓	✓	✓	✓	✓	✓	✓	✓	✓
Preprinted	✓	✓	✓	✓	✓	✓	✓	✓	✓	✓	✓
Colored paper	✓	✓	✓	✓	✓	✓	✓	✓	✓	✓	✓

Understanding paper and specialty media guidelines

Print media weights

Print media	Type	Print media weight				
		500-sheet trays	Multipurpose feeder	2000-sheet dual input trays	2000-sheet high capacity feeder	Duplex unit
Paper	Xerographic or business paper	<ul style="list-style-type: none"> • Tray 1: 64 to 105 g/m² grain long (17 to 28 lb bond) • Other 500-sheet trays: 64 to 216 g/m² grain long (17 to 58 lb bond) 	64 to 216 g/m ² grain long (17 to 58 lb bond)	64 to 105 g/m ² grain long (17 to 28 lb bond)		
Card stock—maximum (grain long) ¹	Index Bristol	163 g/m ² (90 lb)	120 g/m ² (67 lb)			
	Tag	163 g/m ² (100 lb)	120 g/m ² (74 lb)			
	Cover	176 g/m ² (65 lb)	135 g/m ² (50 lb)			
Card stock—maximum (grain short) ¹	Index Bristol	199 g/m ² (110 lb)	163 g/m ² (90 lb)			
	Tag	203 g/m ² (125 lb)	163 g/m ² (100 lb)			
	Cover	216 g/m ² (80 lb)	176 g/m ² (65 lb)			
Transparencies	Laser printer	138 to 146 g/m ² (37 to 39 lb bond)	138 to 146 g/m ² (37 to 39 lb bond)			
Labels	Paper	180 g/m ² (48 lb bond)	163 g/m ² (43 lb bond)			
Integrated forms	Pressure-sensitive area (must enter the printer first)	135 to 140 g/m ² (36 to 37 lb bond)	135 to 140 g/m ² (36 to 37 lb bond)			
	Paper base (grain long)	75 to 135 g/m ² (20 to 36 lb bond)	75 to 135 g/m ² (20 to 36 lb bond)			
Envelopes ²	Sulfite, wood-free or up to 100% cotton bonds		60 to 105 g/m ² (16 to 28 lb bond) ³			

¹ Grain short is preferred for papers over 135 g/m².

² 100% cotton content maximum weight—24 lb.

³ 28 lb bond envelopes are limited to 25% cotton content.

Understanding paper and specialty media guidelines

Media weights supported in the finisher

Print media	Type	Finisher media weight			
		Bin 2			
		Bin 1	Offset	Staple	Hole Punch
Paper	Xerographic or business paper	64 to 105 g/m ² grain long (17 to 28 lb bond)	64 to 216 g/m ² grain long (17 to 58 lb bond)	<ul style="list-style-type: none"> • 40 sheets of 90 g/m² grain long (24 lb bond) • 50 sheets of 64 to 75 g/m² grain long (17 to 20 lb bond) 	64 to 216 g/m ² grain long (17 to 58 lb bond)
Card stock—maximum (grain long)	Index Bristol	163 g/m ² (90 lb bond)		Not recommended	
	Tag	163 g/m ² (100 lb bond)			
	Cover	176 g/m ² (65 lb bond)			
Card stock—maximum (grain short)	Index Bristol	199 g/m ² (110 lb bond)		Not recommended	
	Tag	203 g/m ² (125 lb bond)			
	Cover	216 g/m ² (80 lb bond)			
Transparencies	Laser printer	138 to 146 g/m ² 37 to 39 lb bond)		Not recommended	
Integrated forms	Pressure sensitive area	140 to 175 g/m ² (up to 47 lb bond)	Not recommended		
	Paper base (grain long)	75 to 135 g/m ² (20 to 36 lb bond)			
Labels — upper limit	Paper	180 g/m ² (48 lb bond)	Not recommended		
Envelopes	Sulfite, wood-free or up to 100% cotton bond	60 to 105 g/m ² (16 to 28 lb bond)	Not recommended		

Selecting print media

Selecting the appropriate print media for the printer helps you avoid printing problems. The following sections contain guidelines for choosing the correct print media for the printer.

- **Paper**
- **Transparencies**
- **Envelopes**
- **Labels**
- **Card stock**

Paper

To ensure the best print quality and feed reliability, use 90 g/m² (24 lb) xerographic, grain long paper. Business papers designed for general business use may also provide acceptable print quality.

Always print several samples before buying large quantities of any type of media. When choosing any media, consider the weight, fiber content, and color.

The laser printing process heats paper to high temperatures of 230°C (446°F) for non-MICR applications. Use only paper able to withstand these temperatures without discoloring, bleeding, or releasing hazardous emissions. Check with the manufacturer or vendor to determine whether the paper chosen is acceptable for laser printers.

When loading paper, note the recommended print side on the paper package, and load paper accordingly. For detailed tray loading instructions, see the following:

- **Loading standard or optional 500-sheet trays on page 49**
- **Loading the multipurpose feeder on page 52**
- **Loading the 2000-sheet dual input trays on page 55**
- **Loading the 2000-sheet high capacity feeder on page 56**

Paper characteristics

The following paper characteristics affect print quality and reliability. It is recommended that these guidelines are followed when evaluating new paper stock.

Weight

The printer can automatically feed paper weights from 60 to 176 g/m² (16 to 47 lb bond) grain long in the integrated and optional trays and paper weights from 60 to 135 g/m² (16 to 36 lb bond) grain long in the multipurpose feeder. Paper lighter than 60 g/m² (16 lb) might not be stiff enough to feed properly, causing jams. For best performance, use 90 g/m² (24 lb bond) grain long paper. To use paper narrower than 182 x 257 mm (7.2 x 10.1 in.), it is recommended that the weight be greater than or equal to 90 g/m² (24 lb bond).

Curl

Curl is the tendency of media to curve at its edges. Excessive curl can cause paper feeding problems. Curl can occur after the paper passes through the printer, where it is exposed to high temperatures. Storing paper unwrapped in hot, humid, cold and dry conditions, even in the trays, can contribute to paper curling prior to printing and can cause feeding problems.

Smoothness

The degree of smoothness of paper directly affects print quality. If the paper is too rough, the toner does not fuse to the paper properly, resulting in poor print quality. If the paper is too smooth, it can cause paper feeding or print quality issues. Smoothness needs to be between 100 and 300 Sheffield points; however, smoothness between 150 and 250 Sheffield points produces the best print quality.

Moisture content

The amount of moisture in the paper affects both print quality and the ability of the printer to feed the paper properly. Leave the paper in its original wrapper until it is time to use it. This limits the exposure of the paper to moisture changes that can degrade its performance.

Condition paper while it is still in the original wrapper. To condition it, store it in the same environment as the printer for 24 to 48 hours before printing to let the paper stabilize in the new conditions. Extend the time several days if the storage or transportation environment is very different from the printer environment. Thick paper may also require a longer conditioning period because of the mass of material.

Grain direction

Grain refers to the alignment of the paper fibers in a sheet of paper. Grain is either *grain long*, running the length of the paper, or *grain short*, running the width of the paper.

For 60 to 90 g/m² (16 to 24 lb bond) paper, grain long fibers are recommended.

Fiber content

Most high-quality xerographic paper is made from 100% chemically pulped wood. This content provides the paper with a high degree of stability resulting in fewer paper feeding problems and better print quality. Paper containing fibers such as cotton possess characteristics that can result in degraded paper handling.

Unacceptable paper

The following papers are not recommended for use with the printer:

- Chemically treated papers used to make copies without carbon paper, also known as carbonless papers, carbonless copy paper (CCP), or no carbon required (NCR) paper
- Preprinted papers with chemicals that may contaminate the printer
- Preprinted papers that can be affected by the temperature in the printer fuser
- Preprinted papers that require a *registration* (the precise print location on the page) greater than ±0.09 in., such as optical character recognition (OCR) forms

In some cases, you can adjust registration with your software application to successfully print on these forms.

- Coated papers (erasable bond), synthetic papers, thermal papers
- Rough-edged, rough or heavily textured surface papers or curled papers
- Recycled papers containing more than 25% post-consumer waste that do not meet DIN 19 309
- Recycled paper having a weight less than 60 g/m² (16 lb)
- Multiple-part forms or documents

Selecting paper

Proper paper loading helps prevent jams and ensures trouble-free printing.

To help avoid jams or poor print quality:

- *Always* use new, undamaged paper.
- Before loading paper, know the recommended print side of the paper. This information is usually indicated on the paper package.
- *Do not* use paper that has been cut or trimmed by hand.
- *Do not* mix media sizes, weights, or types in the same source; mixing results in jams.
- *Do not* use coated papers unless they are specifically designed for electrophotographic printing.
- *Do not* forget to change the Paper Size setting when using a source that does not support auto size sensing.
- *Do not* remove trays while a job is printing or **Busy** appears on the operator panel.

Understanding paper and specialty media guidelines

- Make sure the Paper Type, Paper Texture, and Paper Weight settings are correct. (See “Paper Menu” in the *Menus and Messages Guide* located on the publications CD for detailed information about these settings.)
- Make sure the paper is properly loaded in the source.
- Flex paper back and forth. Do not fold or crease the paper. Straighten the edges on a level surface.

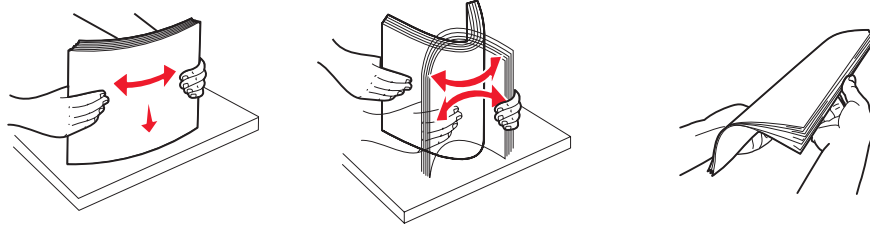

Selecting preprinted forms and letterhead

Use the following guidelines when selecting preprinted forms and letterhead paper for the printer:

- Use grain long papers for best results for 60 to 90 g/m² weights.
- Use only forms and letterhead printed using an offset lithographic or engraved printing process.
- Avoid papers with rough or heavily textured surfaces.

Use papers printed with heat-resistant inks designed for use in xerographic copiers. The ink must withstand temperatures of 230°C (446°F) without melting or releasing hazardous emissions. Use inks that are not affected by the resin in toner. Inks that are oxidation-set or oil-based should meet these requirements; latex inks might not. When in doubt, contact the paper supplier.

Preprinted papers such as letterhead must be able to withstand temperatures up to 230°C (446°F) without melting or releasing hazardous emissions.

Printing on letterhead

Check with the manufacturer or vendor to determine whether the chosen preprinted letterhead is acceptable for laser printers.

Page orientation is important when printing on letterhead. Use the following table for help when loading letterhead in the media sources.

Media source or process	Print side	Top of page
500-sheet trays	<ul style="list-style-type: none"> • Single-sided printing: Printed letterhead face-up • Duplex (two-sided) printing: Printed letterhead face-down 	<ul style="list-style-type: none"> • Long-edge fed: Letterhead top edge towards the front of the tray. • Short-edge fed: Letterhead top edge towards the left of the tray.
2000-sheet dual input trays		Letterhead goes toward the front of the tray.
2000-sheet high capacity feeder	<ul style="list-style-type: none"> • Single-sided printing: Printed letterhead face-down • Duplex (two-sided) printing: Printed letterhead face-up 	Letterhead goes toward the front of the tray.
Multipurpose feeder		<ul style="list-style-type: none"> • Long-edge fed: Letterhead top edge towards the front of the printer. • Short-edge fed: Letterhead top edge enters last.

Transparencies

Feed transparencies from the standard tray or the multipurpose feeder. Try a sample of any transparencies being considered for use with the printer before buying large quantities.

When printing on transparencies:

- Be sure to set the Paper Type to Transparency from the printer driver or from MarkVision™ Professional to avoid damaging the printer.
- Use transparencies designed specifically for laser printers. Transparencies must be able to withstand temperatures of 230°C (446°F) without melting, discoloring, offsetting or releasing hazardous emissions.
- To prevent print quality problems, avoid getting fingerprints on the transparencies.
- Before loading transparencies, fan the stack to prevent sheets from sticking together.

Selecting transparencies

The printer can print directly on transparencies designed for use in laser printers. Print quality and durability depend on the transparency used. Always print samples on the transparencies being considered for use before buying large quantities.

The Paper Type setting should be set to Transparency to help prevent jams. (See “Paper Type” on the publications CD for detailed information about this setting.) Check with the manufacturer or vendor to determine whether the transparencies are compatible with laser printers that heat transparencies to 230°C (446°F). Use only transparencies that are able to withstand these temperatures without melting, discoloring, offsetting, or releasing hazardous emissions.

Transparencies can be fed automatically from the multipurpose feeder and the standard 500-sheet trays (Tray 1 and Tray 2). See **Print media types on page 39** for information about transparency compatibility with output bins.

Be careful when you handle transparencies. Fingerprints on the surface of the transparency cause poor print quality.

Envelopes

You can load up to 10 envelopes in the multipurpose feeder. Try a sample of any envelopes you are considering using with the printer before buying large quantities. See **Loading the multipurpose feeder on page 52** for instructions on loading envelopes.

When printing on envelopes:

- To achieve the best possible print quality, use only high-quality envelopes that are designed for use in laser printers.
- Set the Paper Source in the Paper menu based on the source in use, set the Paper Type to Envelope, and select the correct envelope size from the operator panel, the printer driver, or from MarkVision Professional.
- For best performance, use envelopes made from 90 g/m² (24 lb bond) paper. Use up to 105 g/m² (28 lb bond) weight for the 500-sheet standard trays and multipurpose feeder as long as the cotton content is 25% or less. Envelopes with 100% cotton content must not exceed 90 g/m² (24 lb bond) weight.
- Use only new, undamaged envelopes.
- For best performance and to minimize jams, do not use envelopes that:
 - Have excessive curl or twist.
 - Are stuck together or damaged in any way.
 - Contain windows, holes, perforations, cutouts or embossing.
 - Use metal clasps, string ties, or metal folding bars.
 - Have an interlocking design.
 - Have postage stamps attached.
 - Have any exposed adhesive when the flap is in the sealed or closed position.
 - Have nicked edges or bent corners.
 - Have rough, cockle, or laid finishes.

Understanding paper and specialty media guidelines

- Use envelopes that can withstand temperatures of 230°C (446°F) without sealing, excessive curling, wrinkling, or releasing hazardous emissions. If you have any doubts about the envelopes you are considering using, check with the envelope supplier.
- Adjust the width guide to fit the width of the envelopes.
- Load only one size of envelope at a time.
- A combination of high humidity (over 60%) and the high printing temperatures may seal the envelopes.

Labels

The printer can print on many labels designed for use with laser printers, except for vinyl labels. These labels are supplied in letter size, A4 size, and legal size sheets. Label adhesives, face sheet (printable stock), and topcoats must be able to withstand temperatures of 230°C (446°F) and pressure of 25 pounds per square inch (psi).

Try a sample of any labels you are considering using with the printer before purchasing a large quantity.

After printing approximately 10,000 pages of labels (or each time you replace the toner cartridge), complete the following steps to maintain printer feeding reliability:

- 1** Print five sheets of paper.
- 2** Wait approximately five seconds.
- 3** Print five more sheets of paper.

When printing on labels:

- Set the Paper Type menu item to Labels in the Paper menu. Set the Paper Type from the printer operator panel, the printer driver, or from MarkVision Professional.
- Do not load labels together with paper or transparencies in the same source; mixing media can cause feeding problems.
- Do not use label sheets with a slick backing material.
- Use full label sheets. Partial sheets may cause labels to peel off during printing, resulting in a jam. Partial sheets also contaminate the printer and the cartridge with adhesive, and could void the printer and cartridge warranties.
- Use labels that can withstand temperatures of 230°C (446°F) without sealing, excessive curling, wrinkling, or releasing hazardous emissions.
- Do not print within 1 mm (0.04 in.) of the edge of the label, of the perforations, or between die-cuts of the label.
- Do not use label sheets that have adhesive to the edge of the sheet. Zone coating of the adhesive at least 1 mm (0.04 in.) away from edges is recommended. Adhesive material contaminates the printer and could void the warranty.
- If zone coating of the adhesive is not possible, remove a 3 mm (0.125 in.) strip on the leading and driver edge, and use a non-oozing adhesive.
- Remove a 3 mm (0.125 in.) strip from the leading edge to prevent labels from peeling inside the printer.
- Portrait orientation is preferred, especially when printing bar codes.
- Do not use labels that have exposed adhesive.

Card stock

Card stock is single ply, and has a large array of properties, such as the moisture content, thickness, and texture, that can significantly affect print quality. See **Supported print media on page 35** for information on the preferred weight and for the grain direction of print media.

Try a sample of any card stock you are considering using with the printer before purchasing a large quantity.

See **Print media weights on page 40** for information on the preferred weight of media.

When printing on card stock:

- Set the Paper Type menu item in the Paper Menu to Card Stock from the operator panel, from the printer driver, or from MarkVision Professional. Set the Paper Weight to CardStock Weight, and select the CardStock Weight as Normal or Heavy for the value. Set this from the operator panel, the printer driver, or from MarkVision Professional. Use Heavy for card stock weighing more than or heavier than 163 g/m² (90 lb).
- Be aware that preprinting, perforation, and creasing can significantly affect the print quality and cause media handling or jamming problems.
- Avoid using card stock that may release hazardous emissions when heated.
- Do not use preprinted card stock manufactured with chemicals that may contaminate the printer. Preprinting introduces semi-liquid and volatile components into the printer.
- The use of grain long card stock is recommended.

Storing print media

Use the following guidelines to avoid paper feeding problems and uneven print quality.

- For best results, store media in an environment where the temperature is approximately 21°C (70°F) and the relative humidity is 40%.
Most label manufacturers recommend printing in a temperature range of 18 to 24°C (65 to 75°F) with a relative humidity of 40 to 60%.
- Store cartons of media on a pallet or shelf, rather than directly on the floor.
- When storing individual packages of media out of the original carton, make sure they rest on a flat surface so the edges do not buckle or curl.
- Do not place anything on top of the media packages.
- Store paper in its original wrapper until you load it into the printer.

Avoiding jams

Use appropriate print media (paper, transparencies, labels, and card stock) to help ensure trouble-free printing. See **Supported print media on page 35** for more information.

Note: Try a limited sample of any print media you are considering using with the printer before purchasing large quantities.

By selecting the appropriate print media and loading it properly, you can avoid most jams. For detailed tray loading instructions, see the following:

- **Loading standard or optional 500-sheet trays on page 49**
- **Loading the multipurpose feeder on page 52**
- **Loading the 2000-sheet dual input trays on page 55**
- **Loading the 2000-sheet high capacity feeder on page 56**

The following hints can help you avoid jams:

- Use only recommended print media.
- Do not overload the print media sources. Make sure the stack height does not exceed the maximum height indicated by the stack line on the labels in the sources.
- Do not load wrinkled, creased, damp, or curled print media.
- Flex, fan, and straighten print media before you load it. If jams do occur with print media, try feeding one sheet at a time through the multipurpose feeder.
- Do not use print media that you have cut or trimmed yourself.
- Do not mix print media sizes, weights, or types in the same print media source.
- Make sure the recommended print side is loaded in the source according to your simplex or duplex needs.
- Keep print media stored in an acceptable environment. See **Storing print media on page 47**.
- Do not remove trays during a print job.
- Push all trays in firmly after loading them.
- Make sure the guides in the trays are properly positioned for the size of print media you have loaded. Make sure the guides are not placed too tightly against the stack of print media.

6

Printing

This chapter covers information about loading print media, linking output bins, sending a job to print, printing confidential jobs, canceling a print job, printing a menu settings page, a font list, and a directory list. For tips on paper jam prevention and print media storage, see **Avoiding jams on page 48** or **Storing print media on page 47**.

Loading standard or optional 500-sheet trays

Your printer has two 500-sheet standard trays. You may have also purchased an optional 2x500-sheet drawer which has two additional 500-sheet trays. Print media is loaded into all the 500-sheet trays the same way.

Note: The steps for loading the optional 2000-sheet dual input trays and the 2000-sheet high capacity feeder are different than the steps for loading a 500-sheet tray.

To load print media:

Note: Do not remove a tray when a job is printing or when the operator panel indicator light is blinking. Doing so may cause a jam.

- 1 Pull out the tray.

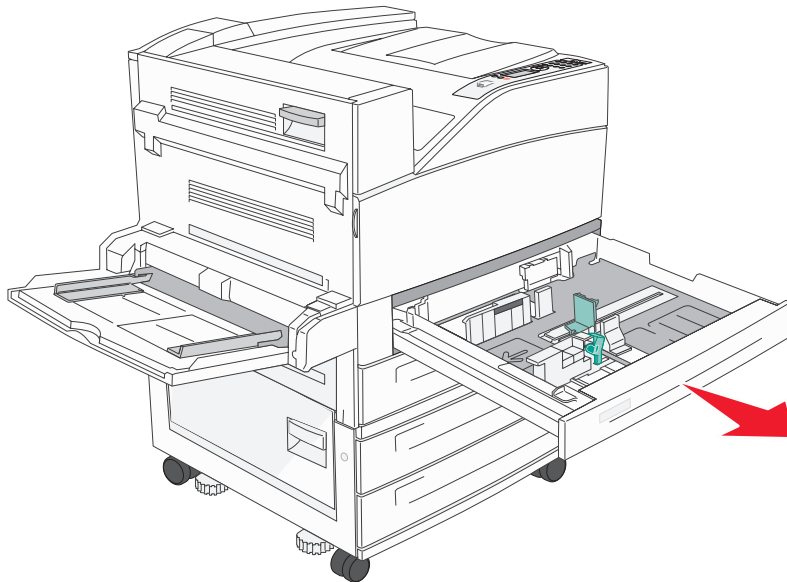

Printing

- 2 Squeeze the side guide tab, and slide the guide to outside of the tray.

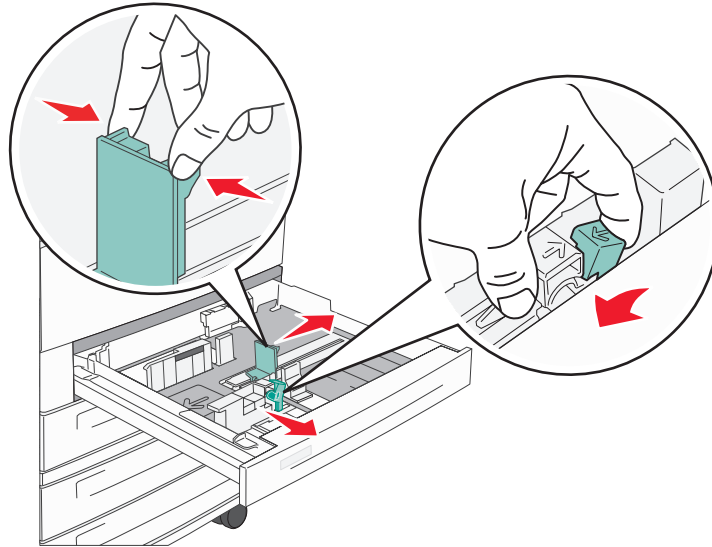

- 3 Squeeze the front guide tab and slide the guide to the correct position for the size media you are loading.
- 4 Flex the sheets back and forth to loosen them, then fan them. Do not fold or crease the print media. Straighten the edges on a level surface.

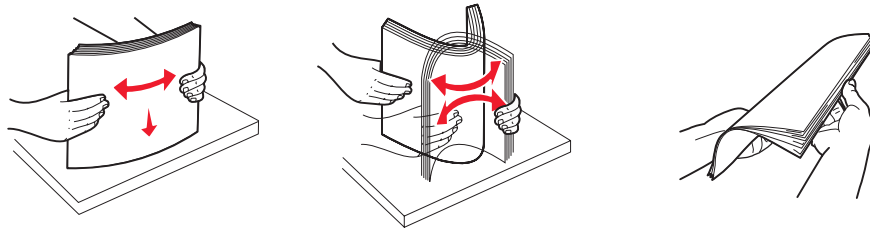

- 5 Load print media in the tray with the print side up.

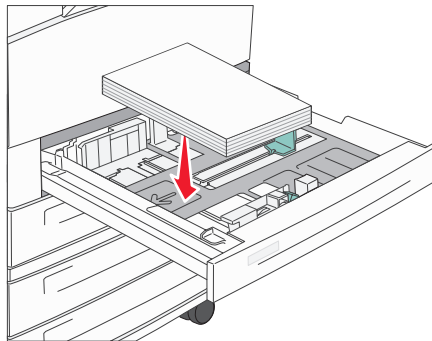

For information about loading Letter or A4 size media in the short-edge feed position, see **Loading Letter or A4 size print media in the short-edge feed orientation on page 58.**

Note: Make sure the print media is below the max fill line on the rear guide. Overloading may cause jams.

Printing

- 6 Squeeze the side guide tab, and slide the guide until it lightly rests against the edge of the media.

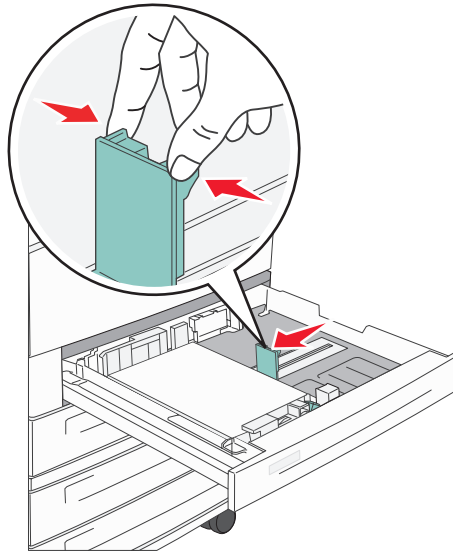

- 7 Insert the tray.

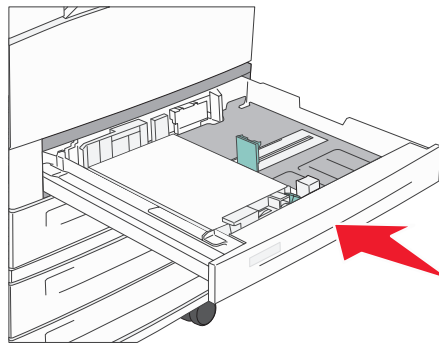

Loading the multipurpose feeder

The multipurpose feeder can hold several sizes and types of print media, such as transparencies, postcards, note cards, and envelopes. It can be used for single-page or manual printing or as an additional tray.

The multipurpose feeder can hold approximately:

- 100 sheets of 75 g/m² (20 lb) paper
- 10 envelopes
- 75 transparencies

The multipurpose feeder accepts print media within the following dimensions:

- Width—89 mm (3.5 in.) to 297 mm (11.7 in.)
- Length—98 mm (3.9 in.) to 432 mm (17.0 in.)

The icons on the multipurpose feeder show you how to load the multipurpose feeder with paper, how to turn an envelope for printing, and how to load letterhead paper for simplex and duplex printing.

To load print media:

Note: Do not add or remove print media when the printer is printing from the multipurpose feeder or when the operator panel indicator light is blinking. Doing so may cause a jam.

- 1 Lower the multipurpose feeder.

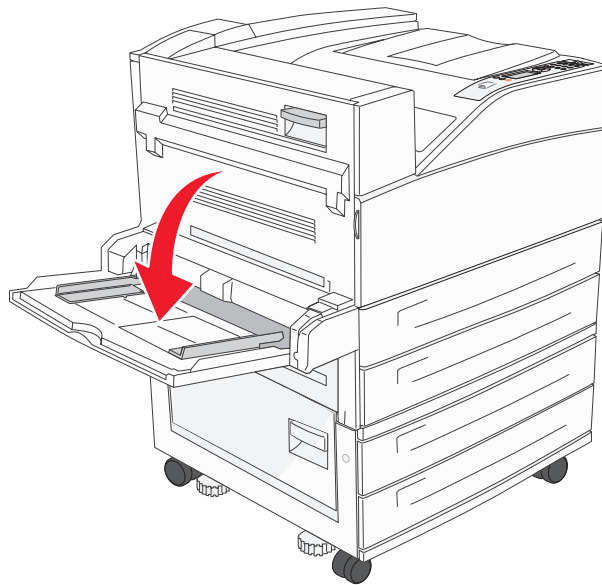

Printing

- 2 Pull the tray extension out.

Note: Do not place objects on the multipurpose feeder. Also, avoid pressing down or applying excessive force on it.

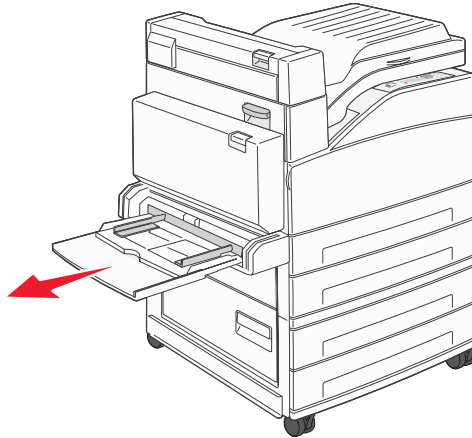

- 3 Slide the width guides to the outside of the feeder.
- 4 Flex the sheets or envelopes back and forth to loosen them, then fan them. Do not fold or crease the print media. Straighten the edges on a level surface.

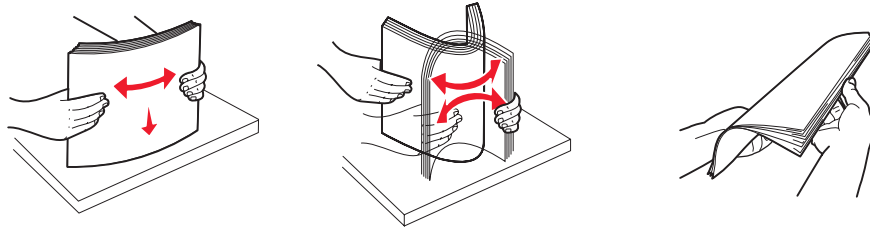

- 5 Load the media in the feeder.



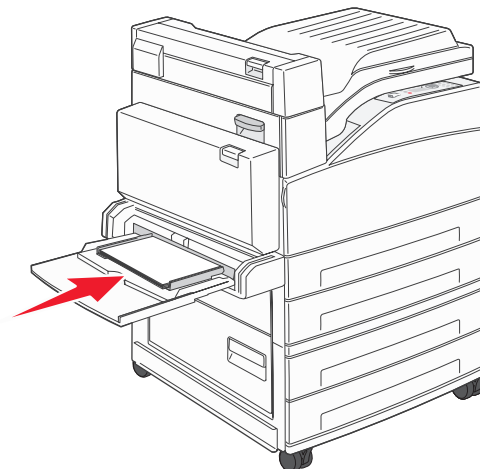





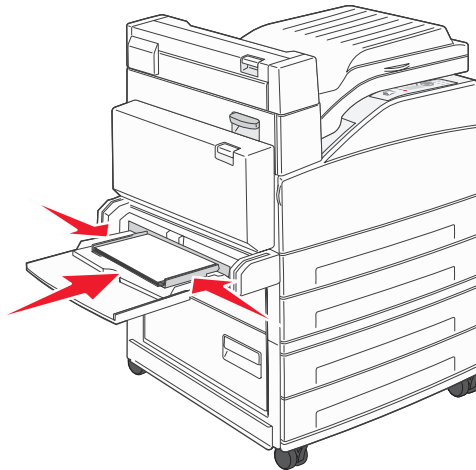







Note: Make sure the print media is below the max fill line. Overloading may cause jams.



Printing

- 6 Slide the width guides until they lightly rest against the edge of the media.



- 7 Set the Paper Size and Paper Type for the multipurpose feeder (MP Feeder Size and MP Feeder Type) to the correct value for the print media you loaded.
- Press  on the operator panel.
 - Press  until  **Paper Menu** appears, and then press .
 - Press  until  **Paper Size/Type** appears, and then press .
 - Press  until  **MP Feeder Size/Type** appears, and then press .
 - Press  until the  appears next to the media size you loaded, and then press .
 - Press  until the media type you loaded appears, and then press .
 - Press  repeatedly to return to the **Ready** state.

Loading the 2000-sheet dual input trays

The 2000-sheet dual input drawer includes two trays: an 850-sheet tray and an 1150-sheet tray. Although the trays are different in appearance, they both load the same way.

- 1 Pull out the tray.

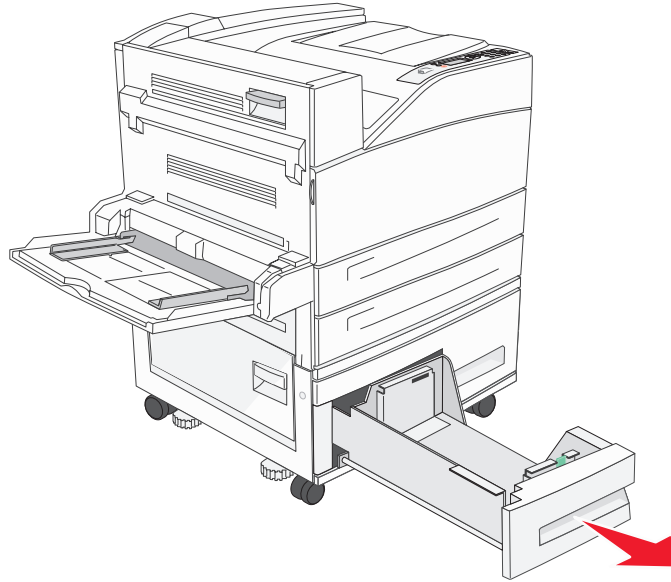

- 2 Squeeze the front guide tab, and slide the guide to the correct position for the size media you are loading.

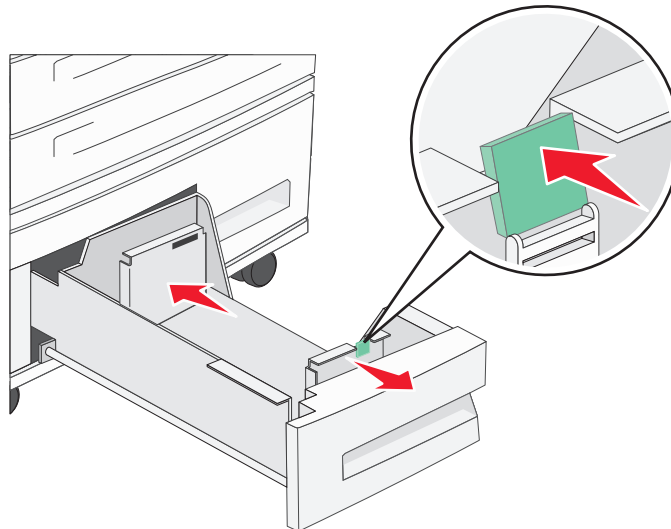

Printing

- 3 Flex the sheets back and forth to loosen them, then fan them. Do not fold or crease the print media. Straighten the edges on a level surface.

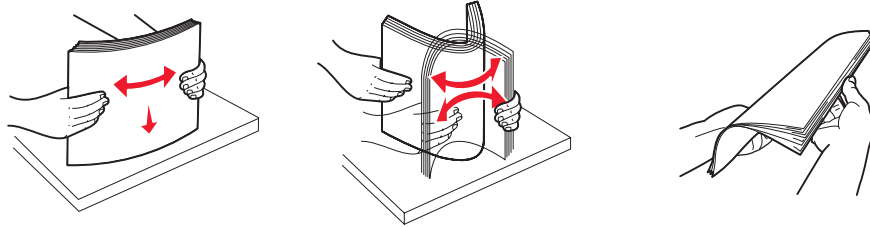

- 4 Load print media in the tray with the print side up.

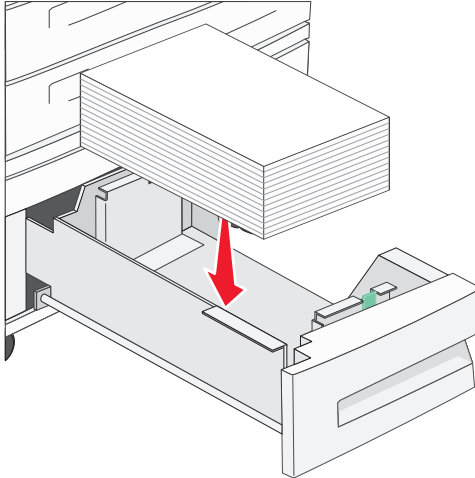

Note: Make sure the print media is below the max fill line on the rear guide. Overloading may cause jams.

- 5 Insert the tray into the printer.

Loading the 2000-sheet high capacity feeder

The high capacity feeder can hold 2000 sheets of Letter, A4, Executive, and JIS B5 paper (75 g/m² [20 lb]).

- 1 Pull out the tray.

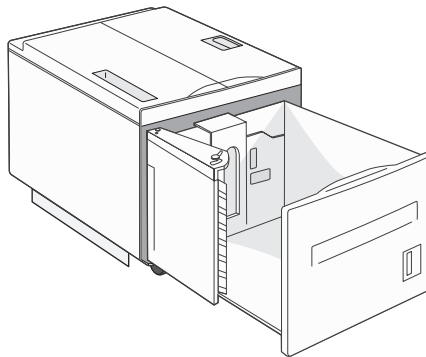

Printing

- 2 If loading print media with a different width or length, adjust the width and length guides.

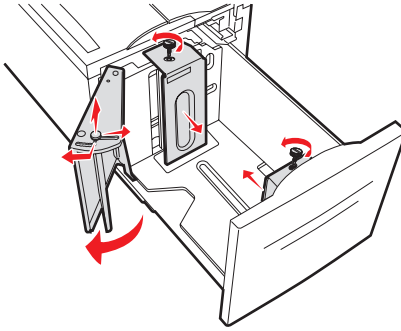

- 3 Flex the sheets back and forth to loosen them, then fan them. Do not fold or crease the print media. Straighten the edges on a level surface.

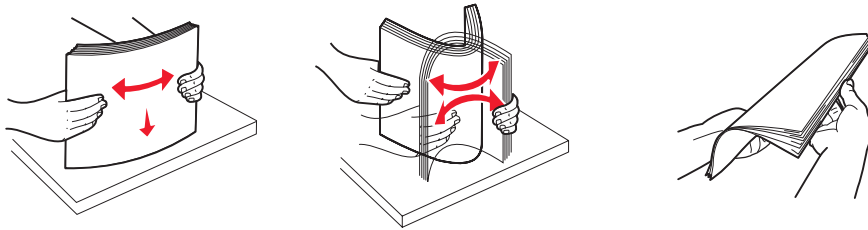

- 4 Load print media in the tray with the print side down.

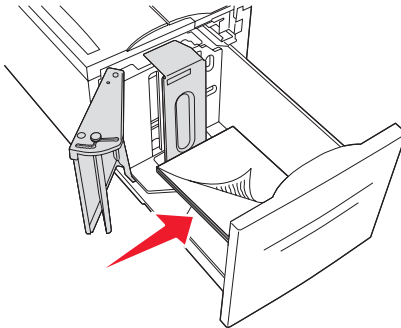







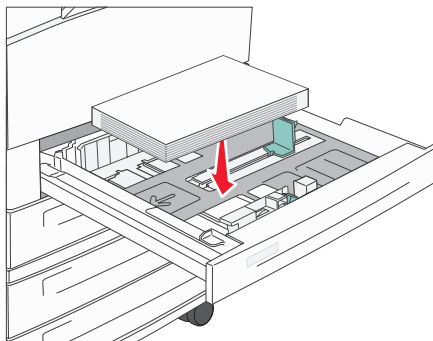





- Place pre-punched paper with the holes toward the left side of the tray.
- Place letterhead (or the top of the page) toward the front of the tray.

- 5 Insert the tray into the high capacity feeder.

Loading Letter or A4 size print media in the short-edge feed orientation



In order for the printer to recognize letter or A4 size print media loaded in the short-edge feed orientation, Short-edge Printing must be enabled.

- 1 Make sure the printer is off.
- 2 Press and hold the  and  buttons while you turn the printer on.
- 3 Release both buttons when **Performing Self Test** appears on the display.
The printer performs its power-on sequence, and then **Config Menu** appears on the first line of the display.
- 4 Press  until  **Short-edge Printing** appears, and then press .
Disabled appears on the second line of the display.
- 5 Press  or  to change the setting to **Enabled**, and then press .
Submitting Selection appears briefly on the display, and then is replaced by **Config Menu** on the first line and **Short-edge Printing** on the second line.
- 6 Press and release  or  until  **Exit Config Menu** appears, and then press .
Activating Menu Changes appears briefly, followed by **Performing Self Test**. The printer returns to **Ready**.

Setting up trays with different orientations

We recommend that you use the custom type settings to differentiate print media of the same size with different orientations. For example, if you want to have letter-size paper loaded into both standard trays, but one in the long-edge orientation and one in the short-edge orientation, you could set up the trays as follows:

- **Tray 1:** Long-edge Fed; Paper Size=Letter; Paper Type=Plain
- **Tray 2:** Short-edge Fed; Paper Size=Letter; Paper Type=Custom Type 1

By setting the printer menus like this, you can easily choose which orientation you want to use for a print job by selecting the appropriate tray.

Changing the Custom Type Name

You can use the printer Embedded Web Server or MarkVision to define a name other than "Custom Type [x]" for each of the custom media types that are loaded. When a custom name is defined for a Custom Type, then the printer displays this name wherever it would normally display "Custom Type [x]".

To define a custom name using the Embedded Web Server:

- 1 Open the printer Embedded Web Server by typing its IP address in the address bar of a browser. For example:
`http://192.168.0.11`
- 2 Click **Configuration**.
- 3 Click **PAPER MENU**.
- 4 Click **CUSTOM NAMES**.
- 5 Define one or more custom names.
For example, you could enter names such as “Short-edge Letter” or “Yellow Glossy.”
- 6 Click **Submit**.

Linking trays

















Tray linking enables the automatic linking feature for trays when you load the same size and type of print media in multiple sources. The printer automatically links the trays; when one tray is empty, print media feeds from the next linked tray.

For example, if you have the same size and type of print media loaded in tray 2 and tray 4, the printer selects print media from tray 2 until it becomes empty, and then the printer automatically feeds print media from the next linked tray—tray 4.

By linking all five trays, you effectively create a single source with a capacity of 4,000 sheets.

If you load the same size print media in each tray, make sure the print media is all the same type in order to link the trays.

To set the paper type or size:

- 1 Press  on the operator panel.
- 2 Press  until  **Paper Menu** appears, and then press .
- 3 Press  until  **Paper Size/Type** appears, and then press .
- 4 Press  until  **Tray <x> Size/Type** appears, and then press .
- 5 Press  until the  appears next to the media size you loaded, and then press .
- 6 Press  until the media type you loaded appears, and then press .
- 7 Press  repeatedly to return to the **Ready** state.

Once the trays you selected are loaded with the same size and type of print media, select the same Paper Type setting in the Paper menu for these sources.

To disable tray linking, set the Paper Type to a unique value in each one of the trays. If all the trays do not have the same type of print media when they are linked, you could mistakenly print a job on the wrong paper type.

Identifying and linking output bins

There is one standard output bin on all printer models. If you need additional output capacity, the optional finisher provides up to 3500 sheets of additional output capacity.

The following table provides information on output bin capacities.

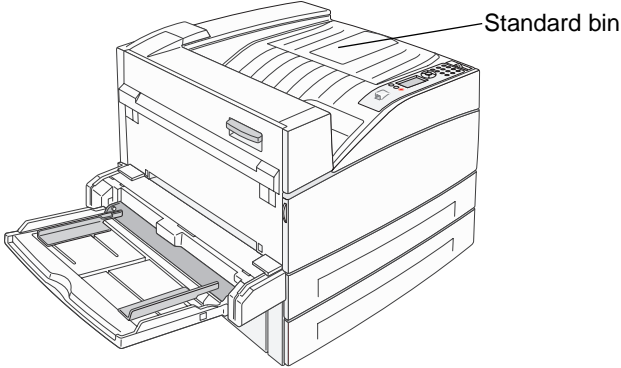
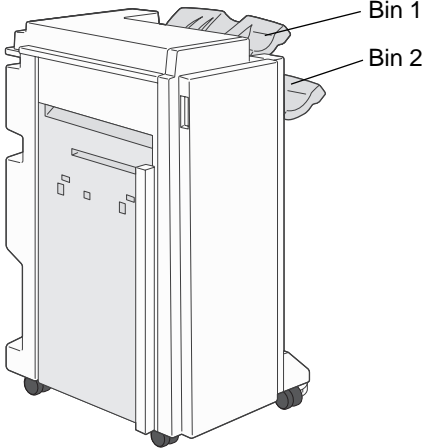
Output bin	Each bin accommodates	Illustration of output bin
Standard bin	<ul style="list-style-type: none"> • 500 sheets* (75 g/m² [20 lb]) plain paper • 300 transparencies • 200 labels • 50 envelopes (75 g/m² [20 lb]) 	
Finisher bin 1	500 sheets (75 g/m ² [20 lb]) plain paper	
Finisher bin 2	3000 sheets† (75 g/m ² [20 lb]) plain paper	





* Standard bin capacity with finisher installed: up to 300 sheets.
† This capacity may decrease if mixed print media sizes are sent to this bin.

Linking output bins

If you have multiple output bins, linking them lets you create a single output source so the printer can automatically switch output to the next available bin. For more information on the values available to configure your output bins, see the *Menus and Messages Guide*.

Note: The bin sequence for linking always starts with the standard bin and proceeds from the bin nearest to the floor to the bin farthest from the floor.

To link output bins:

- 1 Press  on the operator panel.
- 2 Press  until  **Paper Menu** appears, and then press .

- 3 Press ▼ until ✓ **Bin Setup** appears, and then press ✓.
- 4 Press ▼ until ✓ **Configure Bins** appears, and then press ✓.
- 5 Press ▼ until ✓ **Link** appears, and then press ✓.
- 6 Press ↻ repeatedly to return to the **Ready** state.

Sending a job to print

A printer driver is software that lets your computer communicate with your printer. When you choose **Print** from a software application, a window representing the printer driver opens. You can then select the appropriate settings for the specific job you are sending to the printer. Print settings selected from the driver override the default settings selected from the printer operator panel.

You may need to click **Properties** or **Setup** from the initial Print box to see all of the available printer settings you can change. If you are not familiar with a feature in the printer driver window, open the online Help for more information.

To support all the printer features, use the custom printer drivers supplied with your printer. You can also use the system drivers built into your operating system.

To print a job from a typical Windows application:

- 1 Open the file you want to print.
- 2 From the "File" menu, select **Print**.
- 3 Select the correct printer in the dialog. Modify the printer settings as appropriate (such as the pages you want to print or the number of copies).
- 4 Click **Properties** or **Setup** to adjust printer settings that were not available on the first screen, and then click **OK**.
- 5 Click **OK** or **Print** to send the job to the selected printer.

Printing from a USB flash memory device

A USB Direct interface is located on the operator panel so you can insert a USB flash memory device and print PDF documents. Printing a document from a USB flash memory device is similar to printing a held job.

For information regarding tested and approved USB flash memory devices, contact the place where you bought the printer.

Note the following when using a USB flash memory device with the printer USB Direct Interface:

- USB devices must be compatible with the USB 2.0 standard.
- Hi-Speed USB devices must support the Full-Speed standard as well. Devices only supporting USB low speed capabilities are not supported.
- USB devices must use the FAT file system. Devices formatted with NTFS or any other file system are not supported.
- You cannot print encrypted files or files without printing permissions.

To print from a USB flash memory device:

- 1 Make sure the printer is on and **Ready** or **Busy** appears.
- 2 Insert a USB flash memory device into the USB Direct interface.

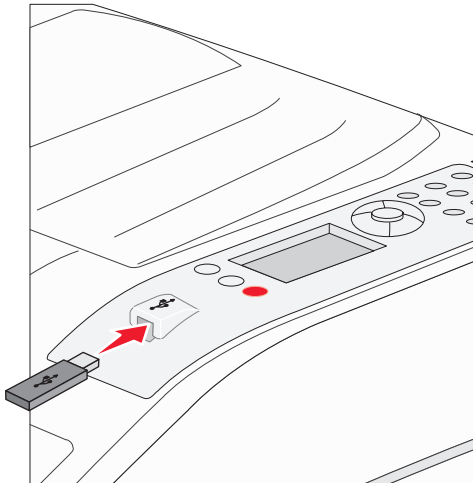



Note:

- If you insert the memory device when the printer requires attention such as when a paper jam has occurred, the printer ignores the memory device.
 - If you insert the memory device when the printer is busy printing other jobs, the message **Printer Busy** appears. Select **Continue**, and your job prints after the other jobs finish.
- 3 Press **▼** until the **✓** appears next to the document you want to print, and then press **✓**.

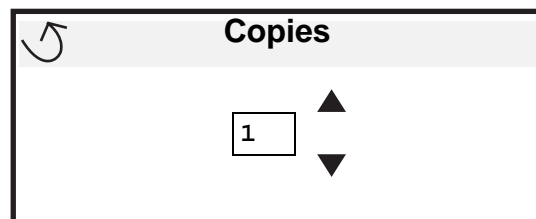
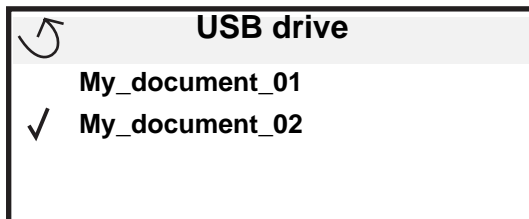
A screen asking the number of copies to be printed will appear.



- 4 To print only one copy, press , or manually input the number of copies with the number pad, then press .

Note: Do not remove the USB flash memory device from the USB Direct interface until the document has finished printing.

The document will begin printing.

If you leave the device in the printer after exiting the USB drive menu, you can still print PDFs on the device as held jobs. See **Printing confidential and held jobs on page 65**.



Canceling a print job

There are several methods for canceling a print job.

- **Canceling a job from the printer operator panel**
- **Canceling a job from a computer running Windows**
 - **Canceling a job from the taskbar**
 - **Canceling a job from the desktop**
- **Canceling a job from a Macintosh computer**
 - **Canceling a job from a Macintosh computer running Mac OS 9.x**
 - **Canceling a job from a Macintosh computer running Mac OS X**

Canceling a job from the printer operator panel

Note: For more information about the operator panel, see **Understanding the printer operator panel on page 9**.

If the job you want to cancel is printing, and **Busy** appears on the display, press  until  **Cancel a job** appears, and then press . The message **Canceling Job** appears until the job is canceled.

Canceling a job from a computer running Windows

Canceling a job from the taskbar

When you send a job to print, a small printer icon appears in the right corner of the taskbar.

- 1 Double-click the printer icon.
A list of print jobs appears in the printer window.
- 2 Select the job you want to cancel.
- 3 Press the **Delete** key on the keyboard.

Canceling a job from the desktop

- 1 Minimize all programs to reveal the desktop.
- 2 Double-click the **My Computer** icon.
- 3 Double-click the **Printers** icon.
A list of available printers appears.
- 4 Double-click the printer you selected when you sent the job.
A list of print jobs appears in the printer window.

- 5 Select the job you want to cancel.
- 6 Press the **Delete** key on the keyboard.

Canceling a job from a Macintosh computer

Canceling a job from a Macintosh computer running Mac OS 9.x

When you send a job to print, the printer icon for your selected printer appears on the desktop.







- 1 Double-click the printer icon on your desktop.
A list of print jobs appears in the printer window.
- 2 Select the print job you want to cancel.
- 3 Click the trash can icon.

Canceling a job from a Macintosh computer running Mac OS X

- 1 Open **Applications** → **Utilities**, and then double-click **Print Center** or **Printer Setup**.
- 2 Double-click the printer you are printing to.
- 3 In the printer window, select the print job you want to cancel.
- 4 Press **Delete**.

Printing the menu settings page

You can print a menu settings page to review the default printer settings and to verify printer options are installed correctly.





- 1 Make sure the printer is on and **Ready**.
 - 2 Press  on the operator panel.
 - 3 Press  until  **Reports** appears, and then press .
 - 4 Press  until  **Menu Settings Page** appears, and then press .
- Printing Menus Settings** appears on the display.
- The printer returns to the **Ready** state after the menu settings page prints.

Printing a network setup page

You can print a network settings page to review the default printer settings and to verify printer options are installed correctly. Go to **Printing a network setup page on page 17**.

Printing a font sample list

To print samples of the fonts currently available for your printer:

- 1 Make sure the printer is on and the **Ready** message appears.
- 2 Press  on the operator panel.
- 3 Press  until  **Reports** appears, and then press .

- 4 Press ▼ until ✓ **Print Fonts** appears, and then press ✓.
- 5 Press ▼ until the ✓ appears next to **PCL Emul Fonts**, **PostScript Fonts**, or **PPDS Fonts**, and then press ✓.

Printing a directory list

A directory listing shows the resources stored in flash memory or on the hard disk. To print a listing:

- 1 Make sure the printer is on and the **Ready** message appears.
- 2 Press  on the operator panel.
- 3 Press ▼ until ✓ **Reports** appears, and then press ✓.
- 4 Press ▼ until ✓ **Print Directory** appears, and then press ✓.

The message **Printing Directory List** appears on the display.

The printer returns to the Ready state after the directory list prints.

Printing confidential and held jobs

The term *held job* refers to any type of print job that can be initiated by the user at the printer. This includes a confidential job, a verify print job, a reserve print job, a repeat print job, a bookmark, a profile, or a file on a USB flash memory device.

When sending a job to the printer, you can specify in the driver that you want the printer to hold the job in memory. Once your job is stored in printer memory, go to the printer and use the printer operator panel to specify what you want to do with your print job.

All confidential and held jobs have a user name associated with them. To access confidential or held jobs, you must first select the type of job (confidential or held), and then select your user name from the user name list. Once you select your user name, you can print all your confidential jobs or select an individual print job. You can then choose the number of copies for the print job or you can delete the print job.

Printing a confidential job

When you send a confidential job to the printer, you must enter a personal identification number (PIN) from the driver. The PIN must be four digits using the numbers 0–9. The job is held in printer memory until you enter the same four-digit PIN from the operator panel and choose to print or delete the job. This ensures the job does not print until you are there to retrieve it. No one else using the printer can print the job without the PIN.

Windows

- 1 From a word processor, spreadsheet, browser, or other application, select **File** → **Print**.
- 2 Click **Properties**. (If there is no Properties button, click **Setup**, and then click **Properties**.)
- 3 Depending on the operating system, you may have to click the **Other Options** tab, and then click **Print and Hold**.

Note: If you have difficulty finding Print and Hold → Confidential Print, click **Help** and see the topic Confidential Print or Print and Hold, and then follow the driver instructions.

- 4 Enter a User Name and PIN.
- 5 Send your job to the printer.

Go to the printer when you are ready to retrieve your confidential print job, and follow the **At the printer** steps on page 66.

Macintosh

- 1 From a word processor, spreadsheet, browser, or other application, select **File** → **Print**.
- 2 In the “Copies & Pages” or “General” pop-up menu, select **Job Routing**.
 - a When using Mac OS 9, if Job Routing is not a choice on the pop-up menu, select **Plug-in Preferences** → **Print Time Filters**.
 - b Turn down the disclosure triangle to the left of **Print Time Filters**, and select **Job Routing**.
 - c In the pop-up menu, select **Job Routing**.

- 3 In the radio group, select **Confidential Print**.

- 4 Enter a User Name and PIN.

- 5 Send your job to the printer.

Go to the printer when you are ready to retrieve your confidential print job, and follow the **At the printer** steps on page 66.

At the printer

- 1 Press ▼ until ✓ **Held jobs** appears, and then press ✓.
- 2 Press ▼ until ✓ **Confidential jobs** appears, and then press ✓.
- 3 Press ▼ until the ✓ appears next to your user name, and then press ✓.
- 4 Enter your PIN.

For more information, see **Entering a personal identification number (PIN) on page 67**.

- 5 Press ▼ until the ✓ appears next to the job you want to print, and then press ✓.

Note: After your job prints, it is deleted from printer memory.

Entering a personal identification number (PIN)

When you select **Confidential Job** from the **Held job** menu, the following prompt appears on the display after you select your user name:

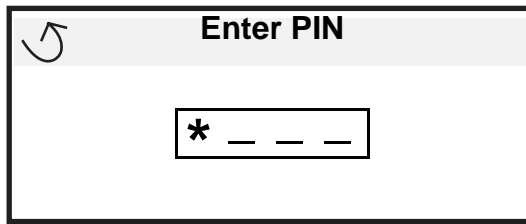

- 1 Use the numeric pad to enter the four-digit PIN associated with your confidential job.

Note: As you enter the PIN, asterisks appear on the display to ensure confidentiality.

If you enter an invalid PIN, the Invalid PIN screen appears.

- To reenter the PIN, make sure **✓ Try again** appears, and then press **✓**.
- To cancel, press **▼** until **✓ Cancel** appears, and then press **✓**.

- 2 Press **▼** until the **✓** appears next to the job you want to print, and then press **✓**.

Note: After your job prints, it is deleted from printer memory.

Printing and deleting held jobs

Held jobs such as Verify Print, Reserve Print, Repeat Print, Bookmarks, and USB flash memory files differ in function and do not require a PIN to print the job. These jobs are printed or deleted from the printer operator panel.

Verify Print

If you send a Verify Print job, the printer prints one copy and holds the remaining copies you requested in printer memory. Use Verify Print to examine the first copy to see if it is satisfactory before printing the remaining copies. Once all copies are printed, the Verify Print job is automatically deleted from printer memory.

Reserve Print

If you send a Reserve Print job, the printer does not print the job immediately. It stores the job in memory so you can print the job later. The job is held in memory until you delete it from the Held Jobs menu. Reserve Print jobs may be deleted if the printer requires extra memory to process additional held jobs.

Repeat Print

If you send a Repeat Print job, the printer prints all requested copies of the job *and* stores the job in memory so you can print additional copies later. You can print additional copies as long as the job remains stored in memory.

Note: Repeat Print jobs are automatically deleted from printer memory when the printer requires extra memory to process additional held jobs.

Windows

- 1 From a word processor, spreadsheet, browser, or other application, select **File → Print**.
- 2 Click **Properties**. (If there is no Properties button, click **Setup**, and then click **Properties**.)

Printing

- 3 Depending on the operating system, you may have to click the **Other Options** tab, and then click **Print and Hold**.

Note: If you have difficulty finding Print and Hold → Held Jobs, click **Help**, and see the topic Held Jobs or Print and Hold, then follow the driver instructions.

- 4 Select the type of held job you want, and then send your job to the printer.

Go to the printer when you are ready to retrieve your confidential print job, and follow the **At the printer** steps on **page 68**.

Macintosh

- 1 From a word processor, spreadsheet, browser, or other application, select **File** → **Print**.

- 2 In the **Copies & Pages** or **General** pop-up menu, select **Job Routing**.

- a When using Mac OS 9, if Job Routing is not a choice on the pop-up menu, select **Plug-in Preferences** → **Print Time Filters**.

- b Turn down the disclosure triangle to the left of **Print Time Filters**, and select **Job Routing**.

- c In the pop-up menu, select **Job Routing**.

- 3 In the radio group, select the type of held job you want, enter a user name, and then send your job to the printer.

Go to the printer when you are ready to retrieve your confidential print job, and follow the **At the printer** steps on **page 68**.

At the printer

- 1 Press ▼ until ✓ **Held jobs** appears, and then press ✓.

- 2 Press ▼ until the ✓ appears next to your user name, and then press ✓.

- 3 Press ▼ until the ✓ appears next to the type of action you want to perform:

Print All Jobs

Delete All Jobs

Print A Job

Delete A Job

Print Copies

- 4 Press ✓.















- 5 Press ▼ until the ✓ appears next to the job you want, and then press ✓.

The job will print or be deleted according to the type of print job and action you selected.

Printing A5/Statement or JIS-B5/Executive sizes

When Auto Size Sensing is set to On, the printer cannot distinguish between Statement and A5 or Executive and JIS-B5. Follow these directions to change the Size Sensing setting.

Note: This is not necessary when printing from the multipurpose feeder.

- 1 Make sure the printer is off.
- 2 Press and hold the  and  buttons while you turn the printer on.
- 3 Release both buttons when **Performing Self Test** appears on the display.
The printer performs its power-on sequence, and then **Config Menu** appears on the first line of the display.
- 4 Press  until  **size sensing** appears, and then press .
Tray 1 Sensing appears on the second line of the display.
- 5 Press and release  or  to select the input option that has A5/Statement or JIS-B5/Executive loaded, and then press .
The first line of the display shows the selected input option, and the second line shows the current setting.
- 6 Press  or  to change the setting to **Sense A5/Sense Statement** or **Sense JIS-B5/Sense Executive**, and then press .
Submitting Selection appears briefly on the display, and then is replaced by **Config Menu** on the first line and **Size Sensing** on the second line.
- 7 Press and release  or  until  **Exit Config Menu** appears, and then press .
Activating Menu Changes appears briefly, followed by **Performing Self Test**. The printer returns to **Ready**.

7

Maintaining the printer

Periodically, you need to complete certain tasks to maintain optimum print quality. These tasks are covered in this chapter.

If several people are using the printer, you may want to designate a key operator to do the setup and maintenance of your printer. Refer printing problems and maintenance tasks to this key operator.

Contact the place where you bought the printer for information about authorized supplies dealers in your area.

Storing supplies

Choose a cool, clean storage area for your printer supplies. Store supplies right side up in their original packaging until you are ready to use them.

Do not expose supplies to:

- Direct sunlight
- Temperatures above 35°C (95°F)
- High humidity (above 80%)
- Salty air
- Corrosive gases
- Heavy dust

Determining the status of supplies

The printer operator panel alerts you once a supply item or maintenance is required. You can also view the status of supplies in your printer on the operator panel unless the printer is printing or in a busy state. The header or gray area at the top of the display will indicate the printer is **Ready** and lets you know if any trays are low. Selecting **status / supplies** on the display will open the **status / supplies** screen where you can view the status of the various trays and open the supplies screen to view the current status of your toner cartridge.

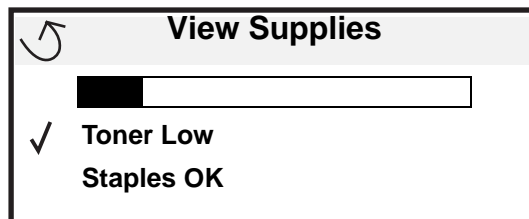
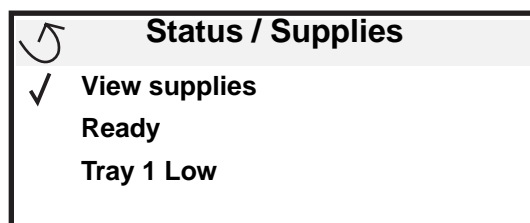

Photoconductor kit end-of-life

To ensure print quality and to avoid damage to the printer, the printer stops operating after the photoconductor kit has reached approximately 60,000 pages (Letter/A4). The message **84 Replace PC Unit** is displayed when the printer reaches this point. If the Toner Alarm setting is set to Single or Continuous (default is Off), the printer automatically notifies you before the photoconductor reaches this point and displays the message **84 PC Unit Life Warning**. To avoid having the printer stop operating, replace the photoconductor kit when you first receive the **84 PC Unit Life Warning** message. Once the photoconductor kit has been replaced, normal printer operation resumes.

Conserving supplies

Several settings in your application software or on the display let you conserve toner and paper. For more information on changing these settings, see the *Menus and Messages Guide*.

Supply	Menu selection item	What the setting does
Toner	Toner Darkness in the Defaults → Quality Menu	Lets you adjust the level of toner released on a sheet of print media. The values range from 1 (lightest setting) to 10 (darkest setting).
Print media	Multipage Print in the Defaults → Finishing Menu	Causes the printer to print the two or more page images on one side of a sheet. Values for Multipage Print are 2 Up, 3 Up, 4 Up, 6 Up, 9 Up, 12 Up, and 16 Up. Combined with the duplex setting, Multipage Print lets you print up to 32 pages on one sheet of paper (16 images on the front and 16 on the back).
	Duplex in the Defaults → Finishing Menu	Duplex printing is available when you attach the optional duplex unit. It lets you print on both sides of a sheet of paper.
	Use your software application or printer driver to send a Verify Print job.	Lets you examine the first copy of a multiple-copy job to be sure it is satisfactory before you print the other copies. If the job is unsatisfactory, you can cancel the job. See Printing and deleting held jobs on page 67 for more information about a Verify Print job.

Ordering supplies

To order supplies, contact the place where you bought your printer for more information.

Ordering a toner cartridge

When the **88 Toner Low** message appears, you should order a new toner cartridge. You can print a few hundred pages after the **88 Toner Low** message appears. You need to have a new cartridge available when the current one no longer prints satisfactorily.

For information about the toner cartridges available for your printer, contact the place where you bought the printer.

Ordering a photoconductor kit

When the **84 PC Life Warning** message appears, you should order a new photoconductor kit. You can print a few hundred pages after the **84 PC Life Warning** message appears.

To order a photoconductor kit, contact the place where you bought the printer for more information.

Maintenance kit

80 **scheduled Maintenance** appears on the display after 300,000 pages have printed to let you know it is time to replace printer maintenance items. Order a maintenance kit when 80 **scheduled Maintenance** first appears on the display. The maintenance kit contains all the items necessary to replace the pick rollers, the fuser, and the transfer roller.

For information about maintenance kits available for the printer, contact the place where you bought the printer.

Ordering staple cartridges

Staple cartridges hold 3,000 staples. To order this item, contact the place where you bought the printer for more information.

When **staples Low** or **staples Empty** appears on the operator panel display, insert a new staple cartridge in the finisher. See the illustrations inside the stapler access door for more information.

- If Staple Alarm is set to Single, the printer stops printing and the **Load Staples** message appears. Install a new staple cartridge, or press **Go** to clear the message and continue printing.
- If Staple Alarm is set to Continuous, the printer displays the **Load Staples** message and continues printing. A partial sheet of staples will remain in the staple cartridge holder when this message appears. Do not remove this sheet. Install a new staple cartridge to properly feed the partial sheet of staples.

8

Clearing jams

By carefully selecting print media and loading it properly, you should be able to avoid most paper jams. For more information on avoiding paper jams, see **Avoiding jams on page 48**. If jams do occur, follow the steps outlined in this section.

To resolve the paper jam messages, you must clear the entire paper path and then press  to clear the message and resume printing. The printer prints a new copy of the page that jammed if Jam Recovery is set to On or Auto; however, the Auto setting does not guarantee the page will print.

Identifying jams

When the printer jams, the appropriate jam message appears on the printer operator panel. If you select **Show Areas** on the operator panel, you can view one or more images to help you clear the jam.

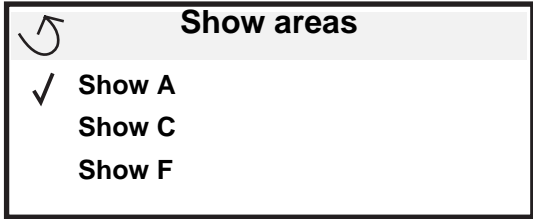
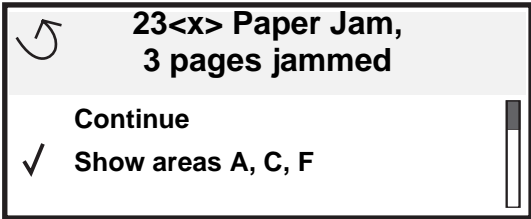

Access doors and trays

The following illustrations show the areas where jams may occur.

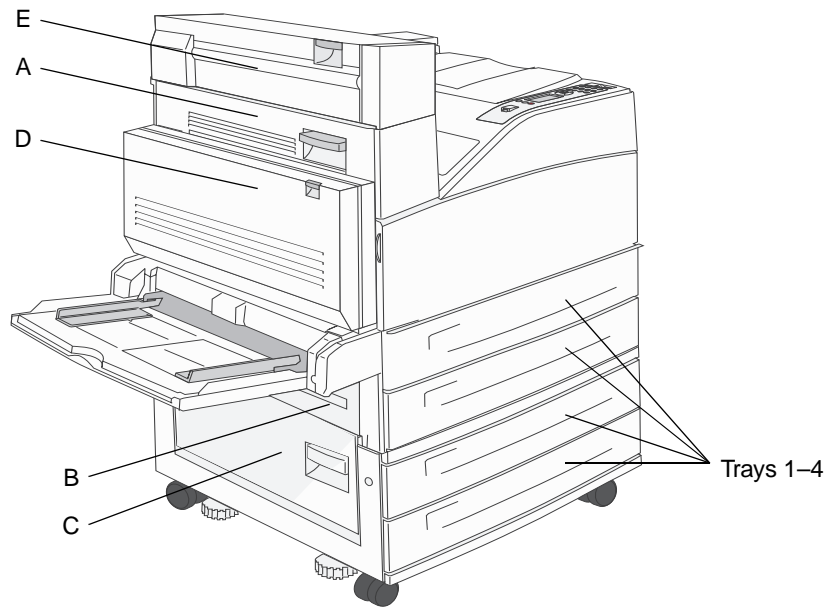

Understanding jam messages

The following table lists the jam messages that can occur and the action necessary to clear the message. The jam message indicates the area where the jam occurred. However, it is best to clear the entire paper path to ensure you have cleared all possible jams.

Message	What to do
200, 201, and 202 Paper Jam Check Door A	Open the side door, and remove the jam.
203 Paper Jam Check <Areas A/E>	Open the side door and the Exit 2 door, and remove the jam.
230 Paper Jam Check Door <A, E, D>	Lower the duplex unit, and remove the jam. Open the side door and the Exit 2 door, and remove the jam.
231 Paper Jam Check <A, D>	Lower the duplex unit, and remove the jam. Open the side door, and remove the jam.
24x Paper Jam Check Tray <x>	Open each tray, and remove any jammed media.
250 Paper Jam Check MP Feeder	Remove all media from the multipurpose feeder, flex and stack the media, reload the multipurpose feeder, and adjust the guide.
28x Paper Jam Check Finisher	Open the finisher door, bridge unit assembly, or output bin, then remove the jam.

Clearing printer jams

Although there are several places a jam can occur, clearing the paper path is fairly easy depending on the jam message or messages displayed on the operator panel.

Note: The following clearing jam instructions may seem out of sequence. However, they have been grouped to help you quickly clear the print path.

250 Paper Jam Check MP Feeder

- 1 Remove the paper from the multipurpose feeder.

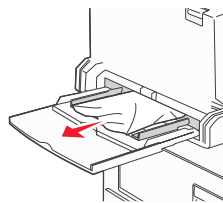

- 2 Flex, fan, and restack the media, and place it into the multipurpose feeder.
- 3 Load the print media.
- 4 Slide the side guide toward the inside of the tray until it lightly rests against the edge of the media.
- 5 Press .

24x Paper Jam Check Tray <x>

Paper jams in these areas can occur on the incline surface of a tray or across more than one tray. To clear these areas:

- 1 Open the tray. If necessary, remove the tray from the printer.

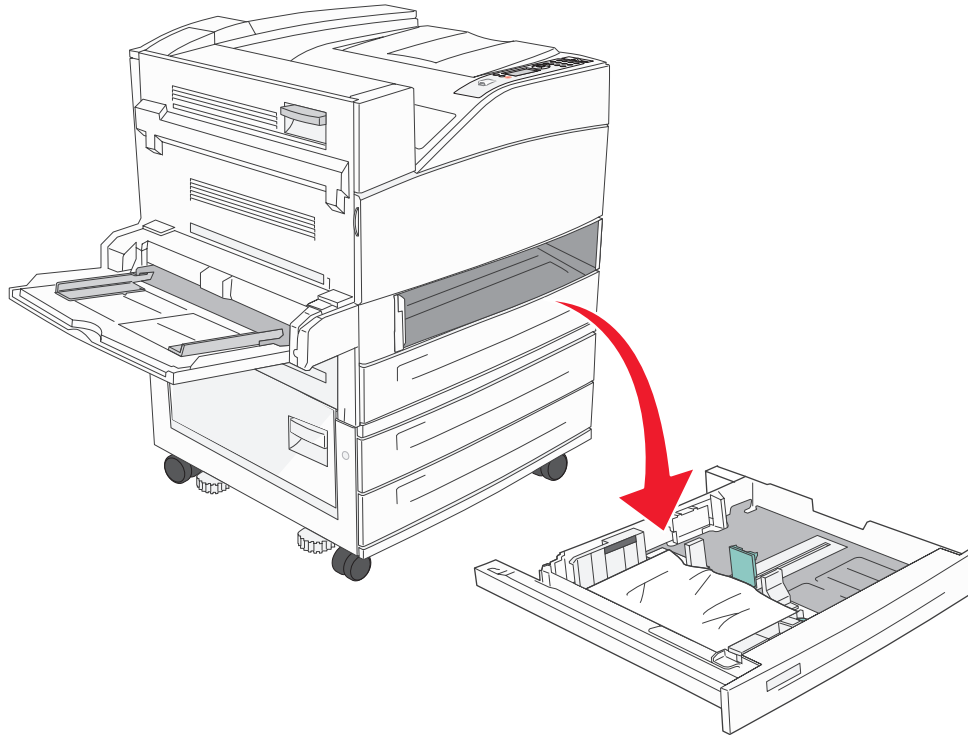

- 2 Remove the media from the printer tray slot.

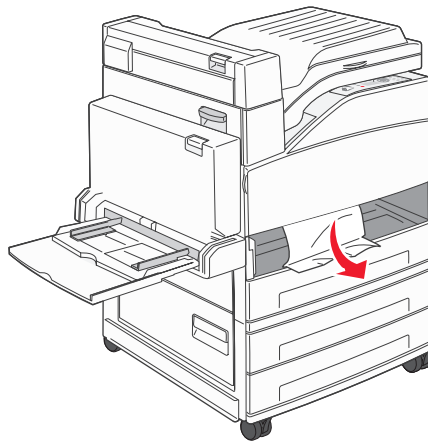

- 3 Remove any crumpled paper from the tray.
- 4 Insert the tray into the printer.
- 5 Press .

Clearing the 2000-sheet high capacity feeder (Tray 5)

- 1 If necessary, close the multipurpose feeder.
- 2 Slide the high capacity feeder away from the printer.

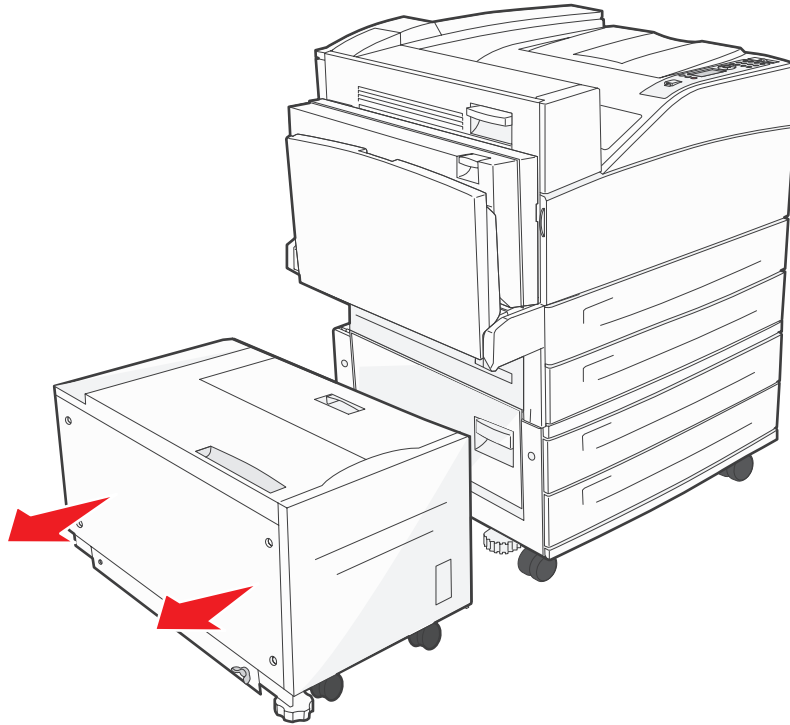

- 3 Raise the top door, and lift the jam access cover.

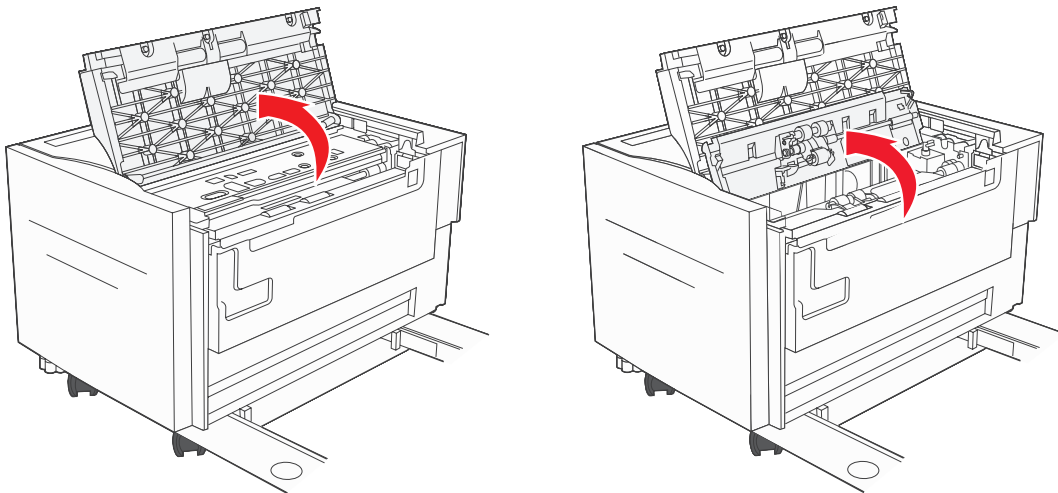

Clearing jams

- 4 Remove the jammed paper.

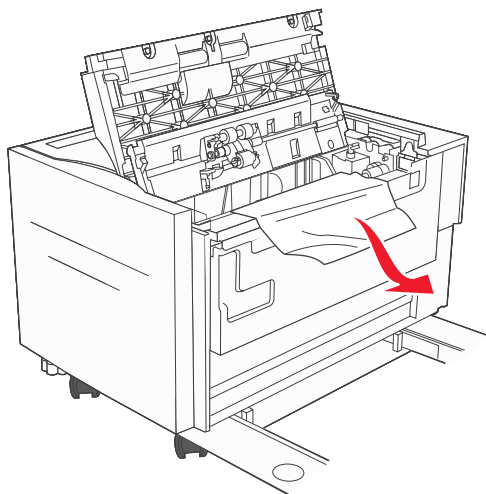

- 5 Close the jam access cover and top door.

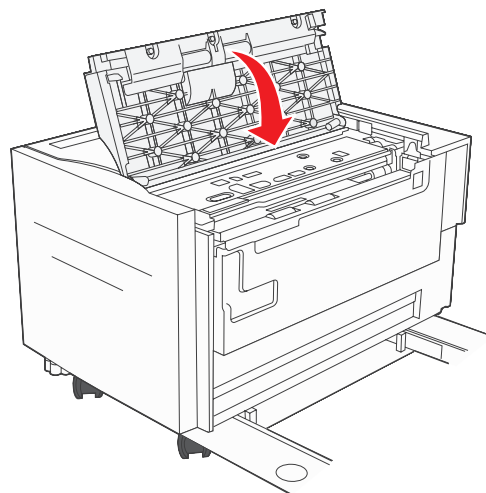
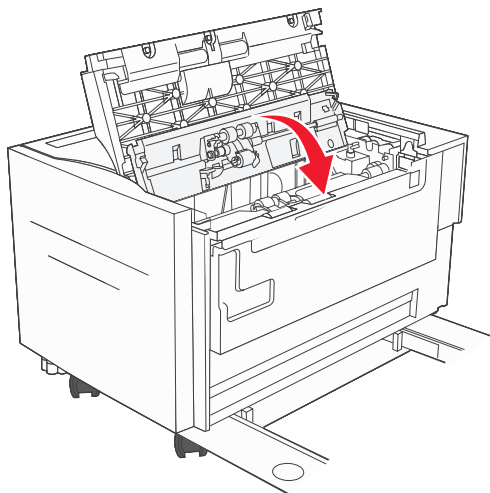

Clearing jams

- 6 Slide the feeder firmly against the printer.

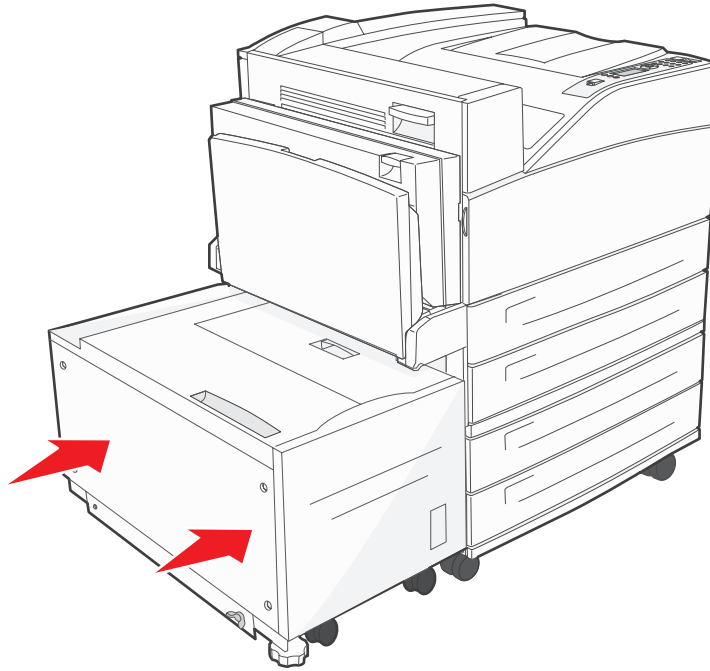

- 7 Press .

200, 201, and 202 Paper Jam Check Door A

- 1 Open Door A by pushing the release latch and lowering the door.

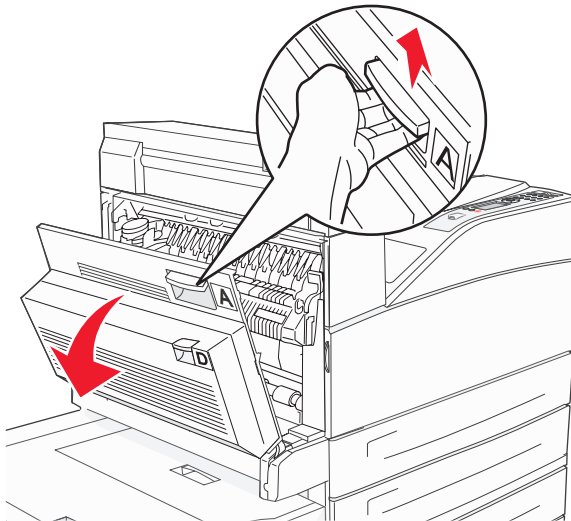

CAUTION: The inside of the printer might be hot.

Clearing jams

- 2 Pull the print media up and toward you.

Warning: If the print media does not move immediately when you pull, stop pulling. Push down and pull the green lever to make it easier to remove the media. Make sure all paper fragments are removed.

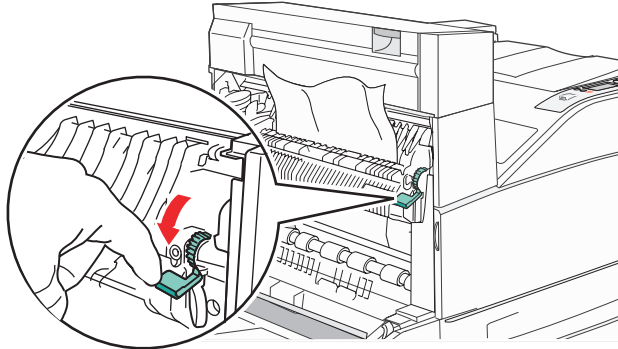

- 3 Close Door A.

- 4 Press .

203 Paper Jam Check <Areas A/E>

- 1 Open Door A by pushing the release latch and lowering the door.

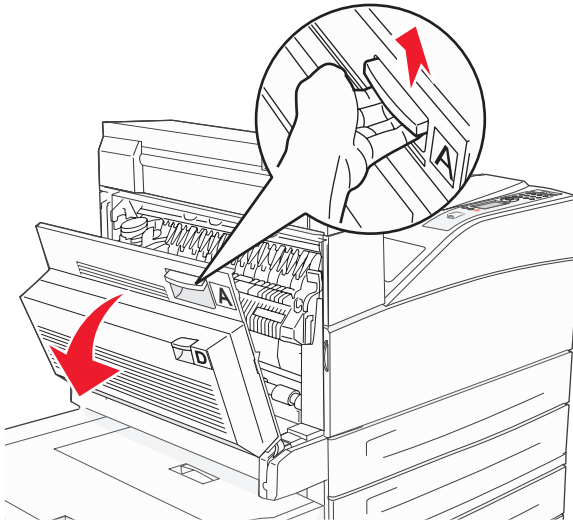

CAUTION: The inside of the printer might be hot.

Clearing jams

- 2 Open Door E by pushing the release latch and lowering the door.

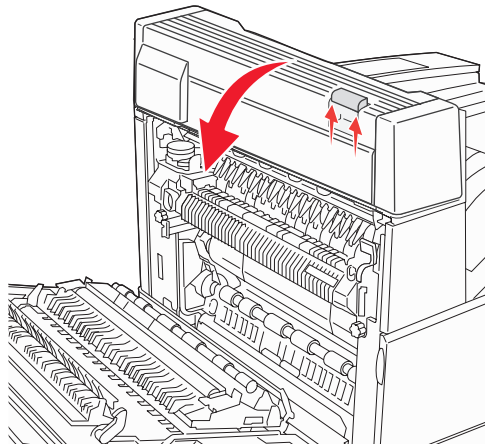

- 3 Pull the print media up.

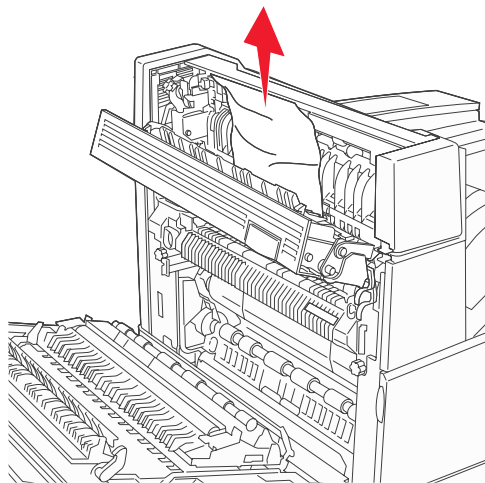

- 4 Close Door E.
- 5 Close Door A.
- 6 Press .

Clearing jams

230 Paper Jam Check Door <A, E, D>

- 1 Open Door D by the duplex rear door.

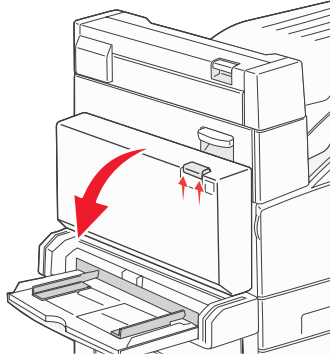

- 2 Remove the jammed media.

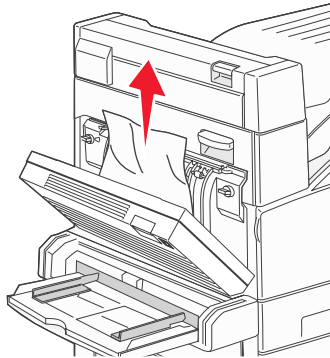

- 3 Close Door D.
- 4 Open Door A by pushing the release latch and lowering the door.

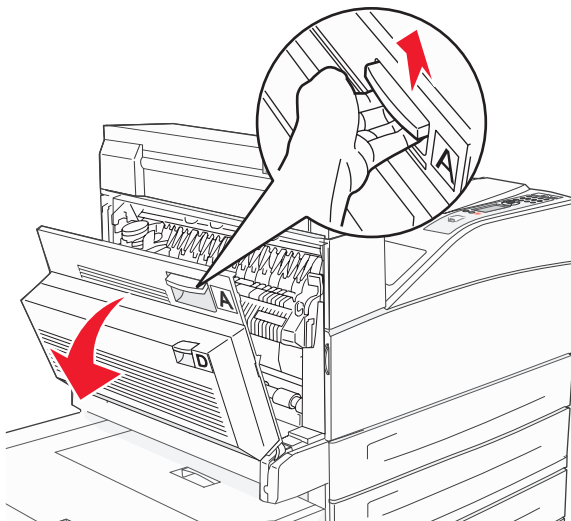

CAUTION: The inside of the printer might be hot.

Clearing jams

- 5 Open Door E by pushing the release latch and lowering the door.

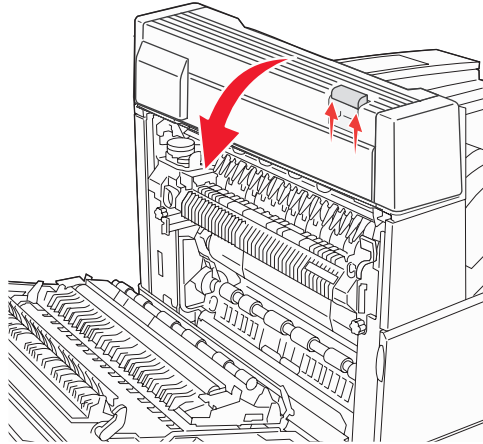

- 6 Pull the print media up.

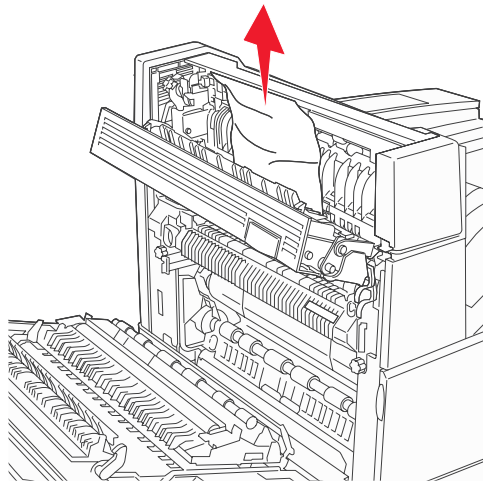

- 7 Close Door E.
- 8 Close Door A.
- 9 Press .

Clearing jams

231 Paper Jam Check <A, D>

- 1 Open Door D by the duplex rear door.

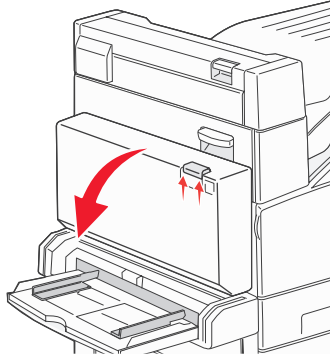

- 2 Remove the jammed media.

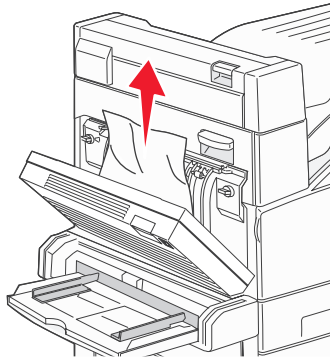

- 3 Close Door D.

- 4 Open Door A by pushing the release latch and lowering the door.

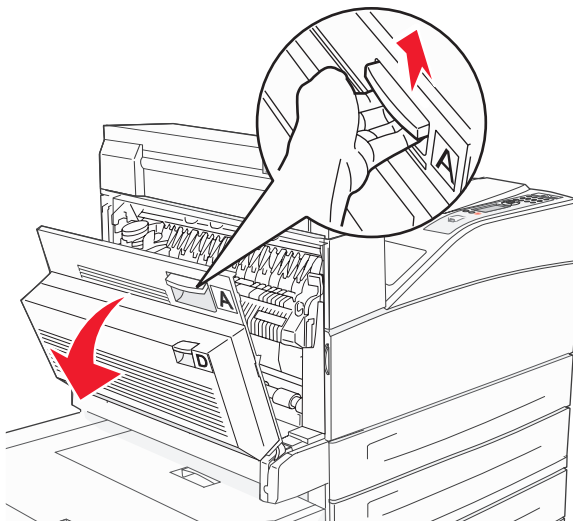

CAUTION: The inside of the printer might be hot.

Clearing jams

- 5 Pull the print media up.

Warning: If the print media does not move immediately when you pull, stop pulling. Pull the green lever to make it easier to remove the media. Make sure all paper fragments are removed.

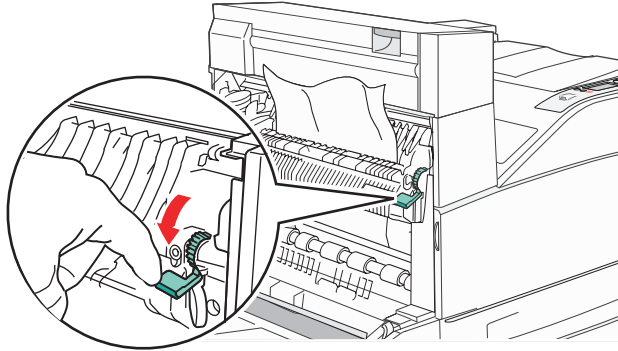

- 6 Close Door A.

- 7 Press .

Clearing Area B

- 1 If the printer is configured with a 2000-sheet high capacity feeder, slide the feeder away from the printer.

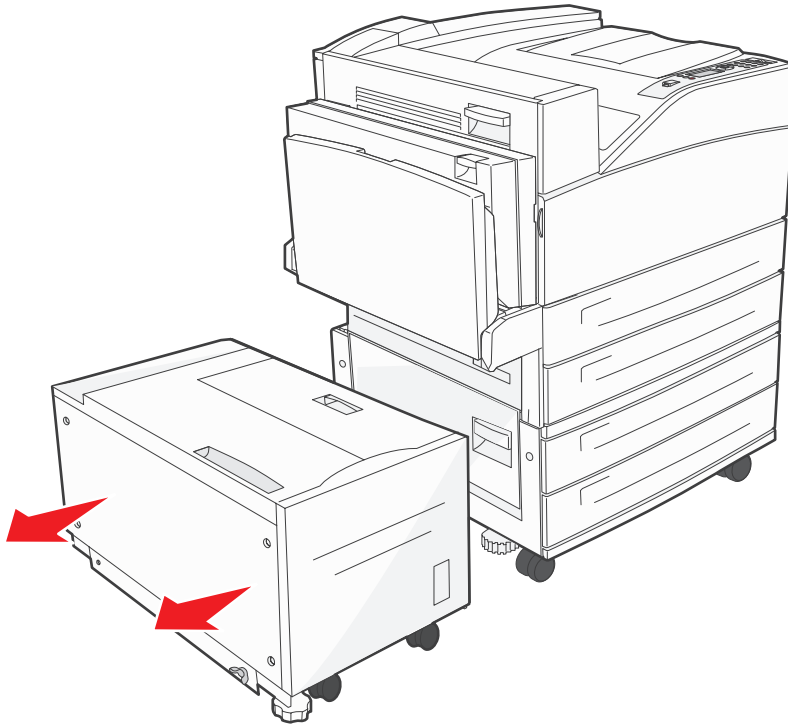

Clearing jams

- 2 Open Door B.

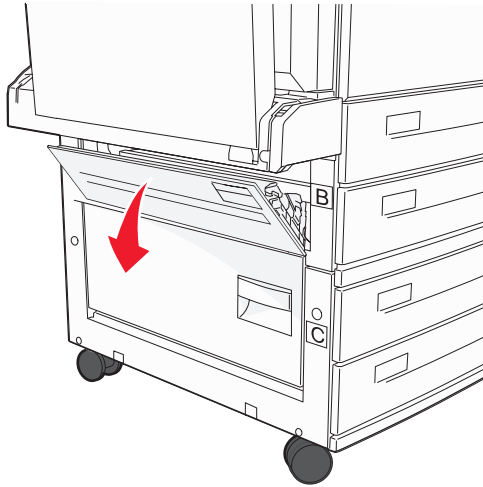

- 3 Remove the jammed media.

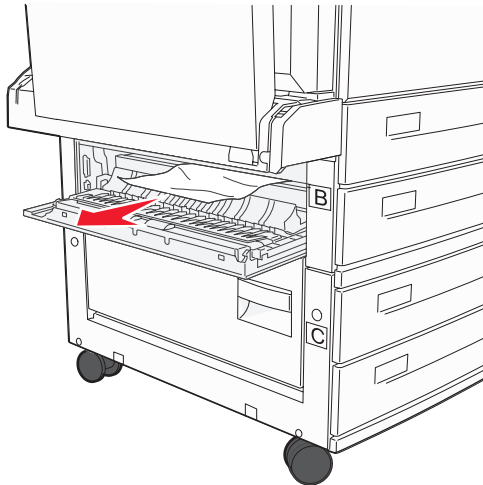

- 4 Close Door B.

Clearing jams

- 5 Slide the feeder firmly against the printer.

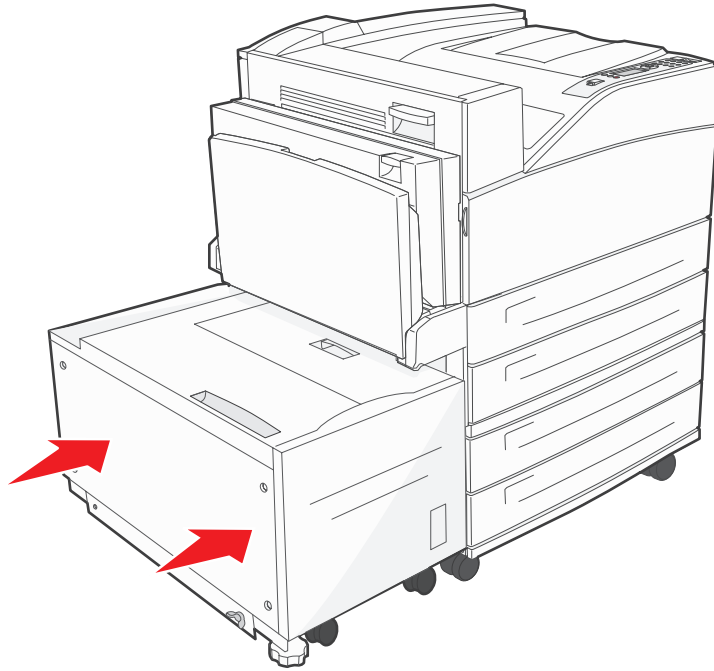

- 6 Press .

Clearing jams

Clearing Area C

- 1 If the printer is configured with a 2000-sheet high capacity feeder, slide the feeder away from the printer.

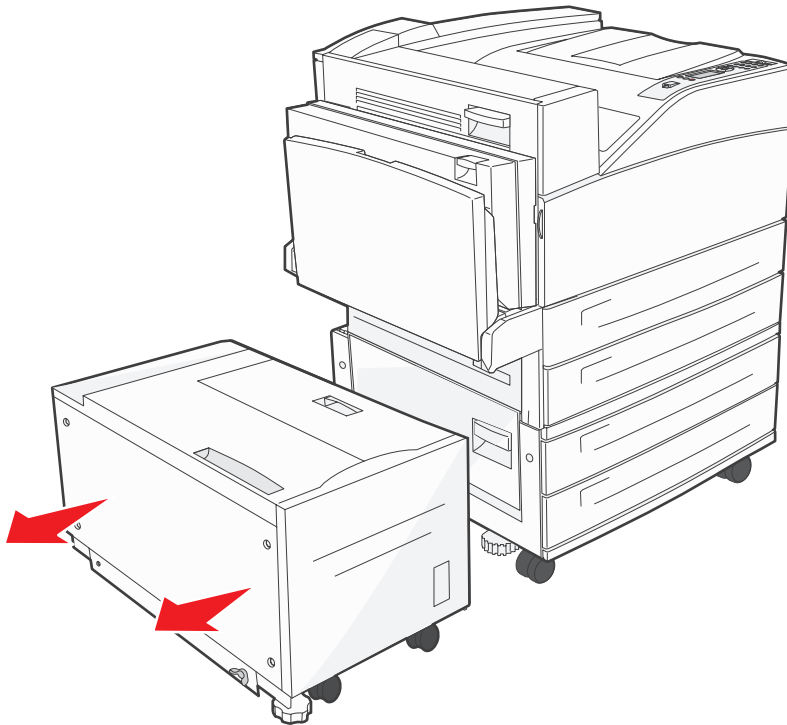

- 2 Open Door C.

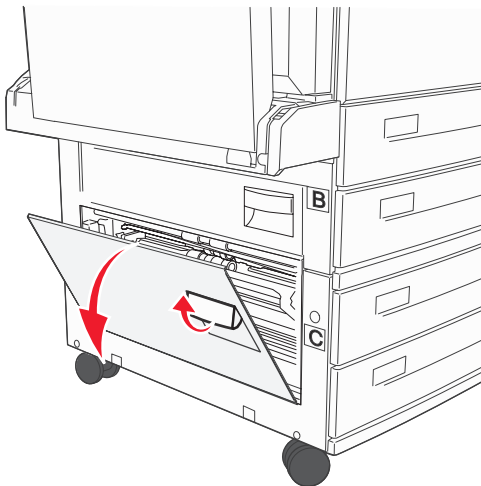

Clearing jams

- 3 Remove the jammed media.

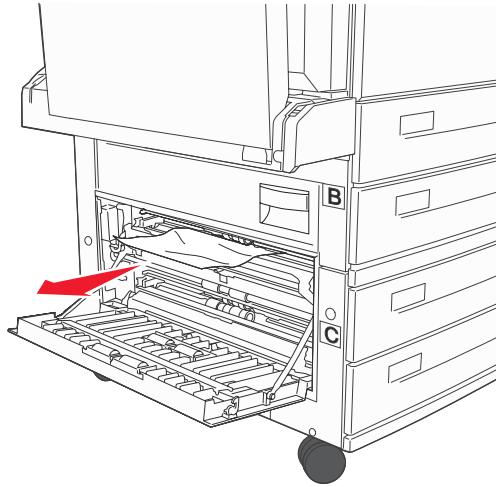

- 4 Close Door C.

- 5 Slide the feeder firmly against the printer.

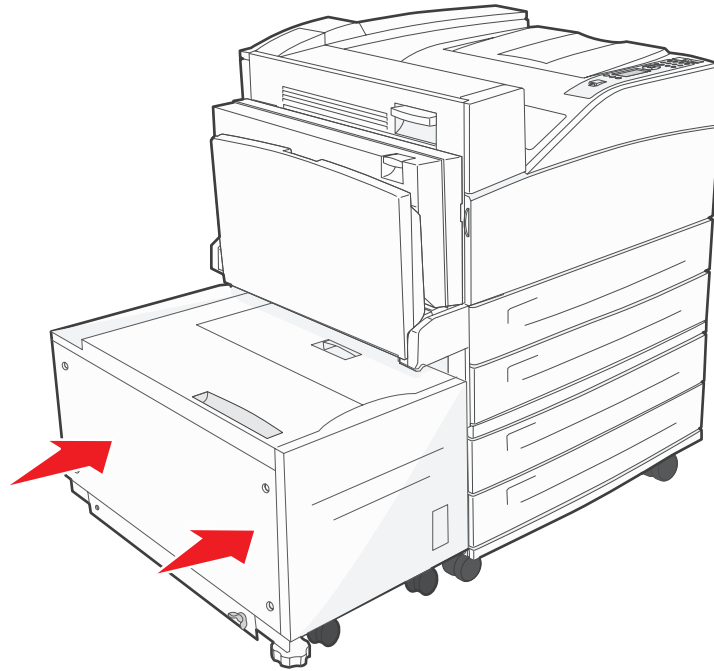

- 6 Press .

28x Paper Jam Check Finisher

There are three areas associated with the finisher. Follow the appropriate instructions to clear a jam in the finisher.

Clearing Area F

- 1 Lift the bridge unit assembly door.

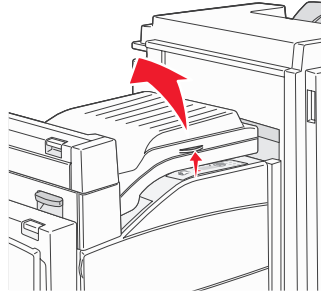

- 2 Remove the jammed media.

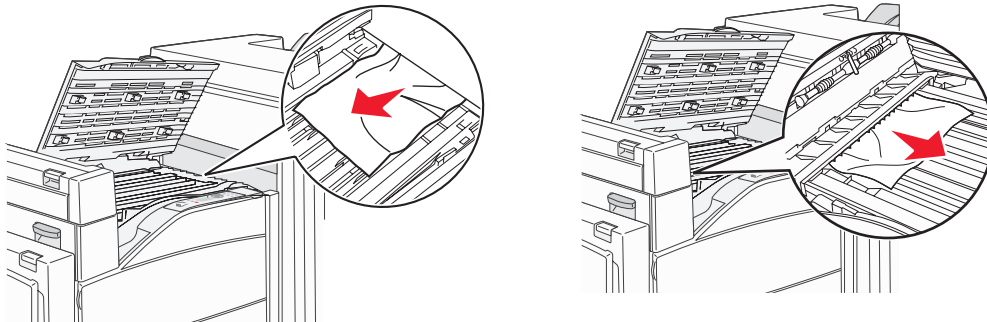



- 3 Close the door.
- 4 Press .

Clearing jams

Clearing Area G

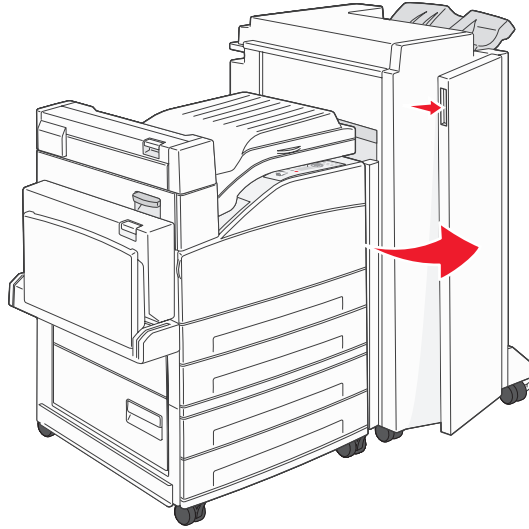
- 1 Open the finisher door.



- 2 Remove the jammed media, as indicated on the operator panel.
- 3 Close the door.
- 4 Press .

Clearing Area H

- 1 Lift Door H.

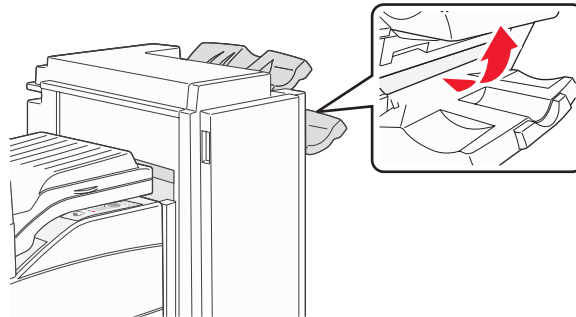

- 2 Remove the jammed media.

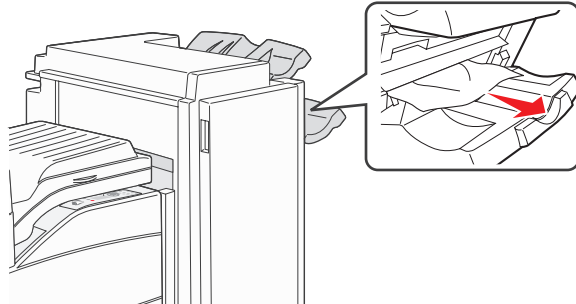

- 3 Close the door.
- 4 Press .

Clearing staple jams

A **Staples Empty** or **Misfed** message indicates staples are jammed in the stapler. This requires removing the staple cartridge holder from the printer.

- 1 Check that the machine stops operations, and open Door G (front door) of the finisher.
- 2 Hold the lever on the staple cartridge holder, and move the holder to the right (towards you).

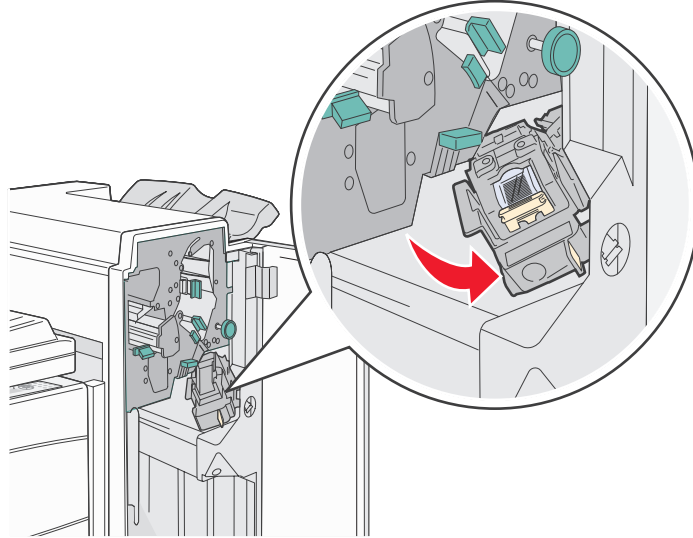

- 3 Firmly pull the colored tab to remove the staple cartridge.

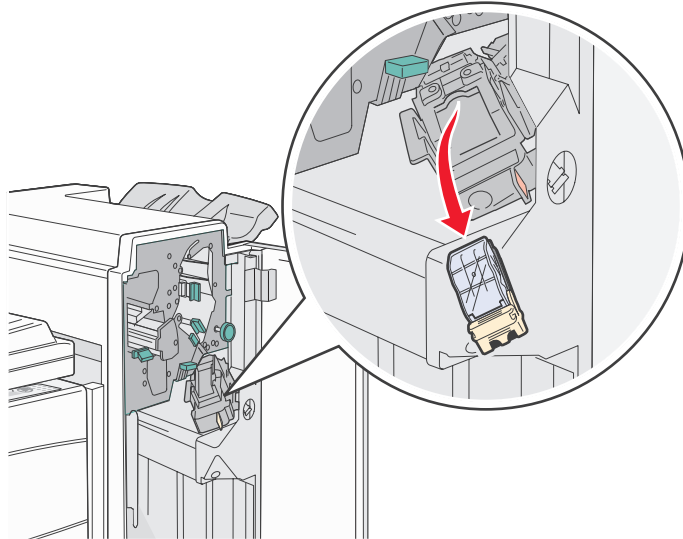

Clearing jams

- 4 Use the metal tab to lift the staple guard, and then pull out the sheet of staples.
Discard the entire sheet.

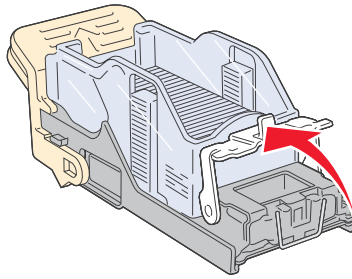

- 5 Remove any loose staples from the staple guard.
- 6 Look through the clear covering on the bottom of the cartridge holder to make sure no staples are jammed in the entry throat.
- 7 Press down on the staple guard until it *snaps* securely into place.

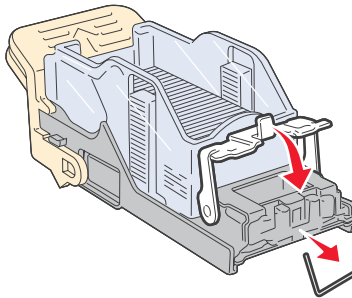

- 8 Push the cartridge holder firmly into the stapler until the holder *clicks* into place.

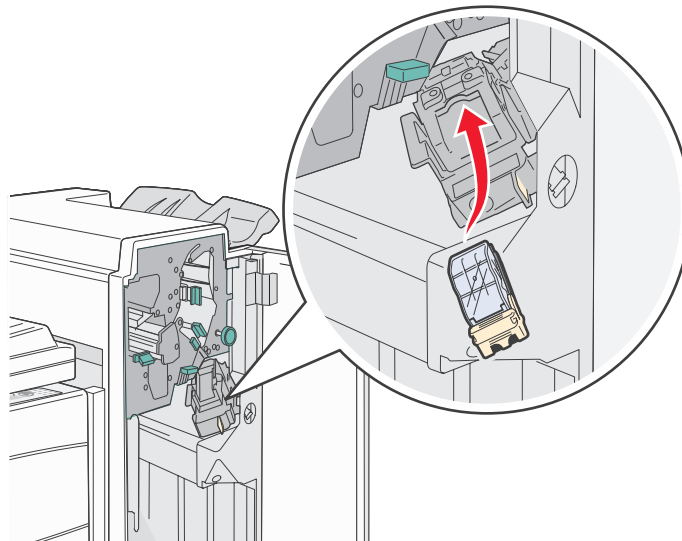

- 9 Close Door G.

Priming stapler appears on the operator panel display. Priming ensures the stapler is functioning properly.

9

Troubleshooting

Calling for service

When you call for printer service, describe the problem you are experiencing, the message on the display, and the troubleshooting steps you have already taken to find a solution.

You need to know your printer model type and serial number. See the label on the printer for this information.

The serial number is also listed on the menu settings page. See **Printing the menu settings page on page 64** for more information.

Note: When calling for service, call from the location of the printer.

Checking an unresponsive printer

If your printer is not responding, first make sure:



- The power cord is plugged into the printer and a properly grounded electrical outlet.
- The electrical outlet is not turned off by any switch or breaker.
- The printer is not plugged into any surge protectors, uninterrupted power supplies, or extension cords.
- Other electrical equipment plugged into the outlet is working.
- The printer is turned on.
- The printer cable is securely attached to the printer and the host computer, print server, option, or other network device.

Once you have checked each of these possibilities, turn the printer off and back on. This often fixes the problem.

Printing multiple-language PDFs

Symptom	Cause	Solution
Some documents do not print.	The documents contain unavailable fonts.	<ol style="list-style-type: none"> 1 Open the document you want to print in Adobe Acrobat. 2 Click the printer icon. The Print dialog appears. 3 Check the Print as image box. 4 Click OK.

Solving printing problems

Symptom	Cause	Solution
The operator panel display is blank or displays only diamonds.	The printer self test failed.	<p>Turn the printer off, wait about 10 seconds, and turn the printer back on.</p> <p>If the Performing Self Test and Ready messages do not appear, turn the printer off and call for service.</p>
The message USB device unsupported appears when using a USB device.	The USB device you are using may not be supported or has an error. Only specific USB flash memory devices are supported.	For information regarding tested and approved USB flash memory devices, contact the place where you bought the printer.
Jobs do not print.	The printer is not ready to receive data.	Make sure Ready or Power Saver appears on the display before sending a job to print. Press  to return the printer to the Ready state.
	The specified output bin is full.	Remove the stack of paper from the output bin, and then press  .
	The specified tray is empty.	Load paper in the tray.
	You are using the wrong printer driver or are printing to a file.	<ul style="list-style-type: none"> • Verify you are using the printer driver associated with your printer. • If you are using a USB Direct interface, make sure you are running Windows 98/Me, Windows 2000, Windows XP, or Windows Server 2003 and using a Windows 98/Me, Windows 2000, Windows XP, or Windows Server 2003 compatible printer driver.
	Your internal print server is not set up properly or is not connected properly.	Verify that you have properly configured the printer for network printing.
	You are using the wrong interface cable, or the cable is not securely connected.	<p>Make sure you are using a recommended interface cable.</p> <p>Make sure the connection is secure.</p>

Troubleshooting

Symptom	Cause	Solution
Held jobs do not print.	A formatting error has occurred.	<ul style="list-style-type: none"> Print the job. (Only part of the job may print.) Delete the job. Free up additional printer memory by scrolling through the list of held jobs and deleting others you have sent to the printer.
	The printer has insufficient memory.	
	The printer has received invalid data.	Delete the job.
Job takes longer than expected to print.	The job is too complex.	Reduce the complexity of your print job by eliminating the number and size of fonts, the number and complexity of images, and the number of pages in the job.
	Page Protect is set to On.	Set Page Protect to Off from the Setup Menu . For more information, see the <i>Menus and Messages Guide</i> .
Job prints from the wrong tray or on the wrong paper or specialty media.	The operator panel menu settings do not match the media loaded in the tray.	Make sure the Paper Size and Paper Type specified in the printer driver match the paper size and type in the tray.
Incorrect characters print.	You are using an incompatible parallel cable.	If you are using a parallel interface, make sure you are using an IEEE 1284-compliant parallel cable.
	The printer is in Hex Trace mode.	If Ready Hex appears on the display, you must exit Hex Trace mode before you can print your job. Turn the printer off and back on to exit Hex Trace mode.
Tray linking does not work.	Tray linking is not configured properly.	<ul style="list-style-type: none"> Make sure both the size and type of media are the same in both trays. Make sure the paper guides in the trays are set for the correct size media. Make sure the menu values for both size and type are set correctly in the Paper menu. See Linking trays on page 59 or see the <i>Menus and Messages Guide</i> for more information.
Large jobs do not collate.	Collate is not set to On.	Set Collation to On in the Finishing Menu or through the printer driver. Note: Setting Collation to Off in the driver overrides the setting in the Finishing Menu . See the <i>Menus and Messages Guide</i> for more information.
	The job is too complex.	Reduce the complexity of the print job by eliminating the number and size of fonts, the number and complexity of images, and the number of pages in the job.
	The printer does not have enough memory.	Add printer memory or an optional hard disk.
Unexpected page breaks occur.	The job has timed out.	Set Print Timeout to a higher value from the Setup Menu . See the <i>Menus and Messages Guide</i> for more information.

Solving option problems

If an option does not operate correctly after it is installed or if it quits working:

- Turn the printer off, wait for about 10 seconds, and turn the printer on. If this does not fix the problem, unplug the printer, and check the connection between the option and printer.
- Print the menu settings page, and check to see if the option is listed in the Installed Options list. If the option is not listed, reinstall it. See **Printing the menu settings page on page 64** for more information.
- Make sure the option is selected in the software application you are using.

For Macintosh computer users: Make sure the printer is set up in Chooser.

The following table lists printer options and suggested corrective actions for related problems. If the suggested corrective action does not fix the problem, call your service representative.



Option	Action
Drawers	<ul style="list-style-type: none"> • Make sure the connection between drawers and the printer is secure. • Make sure the print media is loaded correctly.
Duplex unit	Make sure the connection between the duplex unit and the printer is secure. If the duplex unit is listed on the menu settings page, but print media jams when it enters or exits the duplex unit, the printer and duplex unit may not be properly aligned.
Finisher	<ul style="list-style-type: none"> • Make sure the connection between the finisher and the printer is secure. If the finisher is listed on the menu settings page, but print media jams when it exits the printer and enters the finisher, it may not be properly installed. Reinstall the finisher. • Make sure you are using a print media size compatible with your optional output bins. See Supported print media on page 35.
Flash memory	Make sure flash memory is securely connected to the printer system board.
Hard disk with adapter	Make sure the hard disk is securely connected to the printer system board.
Infrared adapter	<p>If infrared communication stops or does not occur, make sure:</p> <ul style="list-style-type: none"> • The distance between the two infrared ports is 1 meter (39 in.) or less. If communication does not occur between ports, move the ports closer together. • Both ports are stable. • The computer and the printer are on a level surface. • The angle of communication between the two infrared ports is within 15 degrees of either side of an imaginary line drawn between the two infrared ports. • No bright light, such as direct sunlight, is interfering with communication. • No objects are placed between the two infrared ports.
Internal print server	<ul style="list-style-type: none"> • Make sure the internal print server (also called an internal network adapter or INA) is securely connected to the printer system board. • Make sure you are using the correct cable, that it is securely connected, and the network software is correctly set up. <p>See the drivers CD that shipped with your printer for more details.</p>
High capacity feeder (2000-sheet drawer)	See Solving 2000-sheet drawer problems on page 98 .
Printer memory	Make sure printer memory is securely connected to the printer system board.
USB/Parallel interface	<ul style="list-style-type: none"> • Make sure the USB/parallel interface card is securely connected to the printer system board. • Make sure you are using the correct cable and that it is securely connected.

Troubleshooting

Solving 2000-sheet drawer problems

Problem	Solution
The elevator tray does not raise when the loading door is closed, or the elevator tray does not lower when the door is opened and the elevator button is pushed.	Check the following: <ul style="list-style-type: none">• The printer is properly attached to the 2000-sheet drawer.• The printer is powered on.• The power cord is plugged firmly into the back of the 2000-sheet drawer.• The power cord is plugged into an outlet.• The outlet has power.
The elevator tray lowers unexpectedly.	Check to see if your printer is out of print media or has a jam.
More than one sheet of print media is fed or a sheet is fed improperly.	Remove the print media in the printer paper path, and check the stack to ensure the print media has been loaded properly. Be sure to remove the top and bottom sheets of each ream of paper that is loaded.
A jam occurs.	
Rubber feed rollers do not turn to advance print media.	Check the following: <ul style="list-style-type: none">• The power cord is plugged firmly into the back of the 2000-sheet drawer.• The power cord is plugged into an outlet.• The outlet has power.
Consistent misfeeds or jams in the drawer.	Try the following: <ul style="list-style-type: none">• Flex the paper.• Turn the print media over. Check the following: <ul style="list-style-type: none">• Drawer is properly installed.• Print media is loaded correctly.• Print media is not damaged.• Print media meets specifications.• Guides are positioned correctly for the print media size selected.
Service messages	A service message indicates printer failure that may require service. Turn the printer off, wait about 10 seconds, and then turn the printer on. If the error recurs, write down the error number, the problem, and a detailed description. Call for service.

Solving paper feed problems



Symptom	Cause	Solution
Paper frequently jams.	You are using paper that does not meet the printer specifications.	Use recommended paper and other specialty media. See Avoiding jams on page 48 for information that can help prevent jams from occurring.
	You have loaded too much paper or too many envelopes.	Make sure the stack of paper you load does not exceed the maximum stack height indicated in the tray or on the multipurpose feeder.
	Guides in the selected tray are not set to the appropriate position for the size paper loaded.	Move the guides in the tray to the correct position.
	The paper has absorbed moisture due to high humidity.	Load paper from a fresh package. Store paper in its original wrapper until you load it. See Storing print media on page 47 for more information.
The Paper Jam message remains after you remove the jammed paper.	You have not pressed  or have not cleared the entire paper path.	Clear paper from the entire paper path, and then press  . See Clearing printer jams on page 75 for more information.
The page that jammed does not reprint after you clear the jam.	Jam Recovery in the Setup menu is set to Off.	Set Jam Recovery to Auto or On. See the <i>Menus and Messages Guide</i> for more information.
Blank pages feed into the output bin.	An incorrect media type is loaded in the tray being printed from.	Load the correct type media for your print job, or change the Paper Type to match the type of media loaded. See the <i>Menus and Messages Guide</i> for more information.

Solving print quality problems

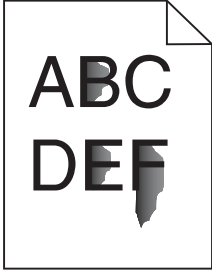
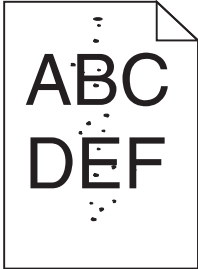
The information in the following table may help you solve print quality problems. If these suggestions still do not correct the problem, call for service. You may have a printer part that requires adjustment or replacement.

Problem	Action
<p>Print is too light.</p> 	<ul style="list-style-type: none"> • The toner may be low. • Change the Toner Darkness setting in the Quality menu. • Change the Brightness setting in the Quality menu. • Change the Contrast setting in the Quality menu. • If you are printing on an uneven print surface, change the Paper Weight and Paper Texture settings in the Paper menu. • Verify the correct print media is being used.
<p>Toner smears or print comes off the page.</p> 	<ul style="list-style-type: none"> • If you are printing on an uneven print surface, change the Paper Weight and Paper Texture settings in the Paper menu. • Verify the print media is within the printer specifications. See Understanding paper and specialty media guidelines on page 35 for more details. <p>If the problem continues, turn the printer off and contact the place you bought your printer.</p>
<p>Toner appears on the back of the printed page.</p>	<p>Toner is on the transfer roll. To help prevent this, do not load print media that is smaller than the page size of the job to be printed.</p> <p>Open and close the printer top front cover to run the printer setup cycle and clean the transfer roll.</p>
<p>Toner fog or background shading appears on the page.</p> 	<ul style="list-style-type: none"> • Check the photoconductor kit to make sure it is installed correctly. • Replace the photoconductor kit.

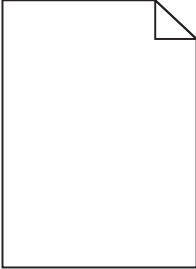
Troubleshooting

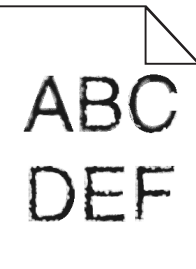
Problem	Action
<p>Entire page is white.</p> 	<ul style="list-style-type: none"> • Make sure the packaging material is removed from the photoconductor kit. • Check the photoconductor kit to be sure it is installed correctly. • Replace the photoconductor kit.
<p>Streaks appear on the page.</p> 	<ul style="list-style-type: none"> • If you are using preprinted forms, make sure the ink can withstand temperatures of 230°C (446°F). • Replace the photoconductor kit or toner cartridge.
<p>Printing is too dark.</p> 	<ul style="list-style-type: none"> • Change the Toner Darkness setting in the Quality menu. • Change the Brightness setting in the Quality menu. • Change the Contrast setting in the Quality menu. <p>Note: Macintosh computer users should make sure the lines per inch (lpi) setting is not set too high in the software application.</p>
<p>Characters have jagged or uneven edges.</p> 	<ul style="list-style-type: none"> • Change the Print Resolution setting in the Quality menu to 600 dpi, 1200 dpi, or 2400 Image Q. • Enable Enhance Fine Lines. • If you are using downloaded fonts, verify the fonts are supported by the printer, the host computer, and the software application.

Troubleshooting

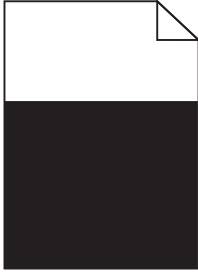
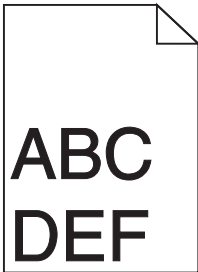
Problem	Action
<p>Part or all of the page is printed in black.</p> 	<p>Check the photoconductor kit to see if it is installed correctly.</p>
<p>The job prints, but the top and side margins are incorrect.</p> 	<ul style="list-style-type: none"> • Make sure the Paper Size setting in the Paper menu is correct. • Make sure the margins are set correctly in your software application.
<p>Ghost images appear.</p>	<ul style="list-style-type: none"> • Make sure the Paper Type setting in the Paper menu is correct. • Replace the photoconductor kit.
<p>Gray background prints.</p>	<ul style="list-style-type: none"> • The Toner Darkness setting may be too dark. Change the Toner Darkness setting in the Quality menu. • Adjust the Brightness to a darker setting. • Adjust the Contrast to a darker setting. • The photoconductor kit may be defective. Replace the photoconductor kit.
<p>Some of the print is cut off on the sides, top, or bottom of the media.</p>	<p>Move the guides in the tray to the proper positions for the size loaded.</p>
<p>Print is skewed, or inappropriately slanted.</p>	
<p>Transparency print quality is poor.</p>	<ul style="list-style-type: none"> • Use only transparencies recommended by the printer manufacturer. • Make sure the Paper Type setting in the Paper menu is set to Transparency.

Troubleshooting

The Quality menu operator panel options can be adjusted to help improve print quality.

Menu selection	Purpose	Values	
Print Resolution	To select printed output resolution	600 dpi 1200 dpi 2400 Image Quality*	
Toner Darkness	Lightens or darkens printed output and conserves toner	1–10	8* is the default setting. Select a lower number to lighten the printed output or save toner.
Brightness	Adjusts the gray value of printed objects	-6 – +6	0* is the default setting.
Contrast	Adjusts the contrast of printed objects	0–5	0* is the default setting.

In addition, the Enhance Fine Lines and Gray Correction options can be enabled to improve print quality. These settings are available on the driver and on the printer Embedded Web Server (EWS) interface. For more information about these options, see the driver help.













Driver option	Purpose	Values [†]	
Enhance Fine Lines	A selection to enable a print mode preferable for certain files containing fine line detail, such as architectural drawings, maps, electronic circuit diagrams and flow charts	On	In the driver, enable the check box.
		Off*	In the driver, disable the check box.
Gray Correction	Automatically adjusts the contrast enhancement applied to images	Auto	In the driver, enable the check box.
		Off*	In the driver, disable the check box.

[†] Values marked by an asterisk (*) are the factory default settings.

Adjusting operator panel brightness and contrast

The LCD operator panel contrast and brightness can be adjusted through the Utilities menu. For more information, see the *Menus and Messages Guide*.

The LCD Brightness and LCD Contrast settings are adjusted separately. To change the LCD Brightness or LCD Contrast settings:

- 1 Make sure your printer is on.
- 2 Press  on the operator panel.
- 3 Press  until  **Settings** appears, and then press .
- 4 Press  until  **Utilities Menu** appears, and then press .
- 5 Press  until  appears next to the LCD setting you want to change, and then press .
- 6 Press  to increase the brightness or contrast or press  to decrease the brightness or contrast.
- 7 When the adjustment is complete, press .

This saves this setting as the new user default and the printer returns to **Ready**.

Disabling operator panel menus

Since many people could be using the printer, an administrator may choose to lock the operator panel menus to keep others from changing menu settings from the operator panel.

To disable the operator panel menus so that changes cannot be made to the printer default settings:

- 1 Turn the printer off.

Note: Disabling the operator panel menus does not prevent access to Print and Hold functionality.

- 2 Press and hold  and  while turning the printer on.



- 3 Release both buttons when **Performing Self Test** appears on the display.

The printer performs its power-on sequence, and then **Config Menu** appears on the first line of the display.

- 4 Press  until  **Panel Menu** appears, and then press .

- 5 Press  until  **Disable** appears, and then press .











The following messages appear briefly: **Submitting Selection** and **Disabling Menus**. The operator panel returns to **Panel Menu**.

- 6 Press  until  **Exit Config Menus** appears, and then press .

Activating Menu Changes appears. The menus are disabled.

Resetting the Printer appears briefly followed by a clock. The operator panel then returns to **Ready**.

Enabling operator panel menus

- 1 Turn the printer off.
- 2 Press and hold  and  while turning the printer on.
- 3 Release both buttons when **Performing Self Test** appears on the display.
The printer performs its power-on sequence, and then **Config Menu** appears on the first line of the display.
- 4 Press  until  **Panel Menu** appears, and then press .
- 5 Press  until  **Enable** appears, and then press .
- The following messages appear briefly in succession: **Submitting Selection** and **Enabling Menus**.
The operator panel returns to **Panel Menu**.
- 6 Press  until  **Exit Config Menu** appears, and then press .
- Activating Menu Changes** appears. The menus are enabled.
Resetting the Printer appears briefly followed by a clock. The operator panel then returns to **Ready**.













Restoring factory default settings

When you first enter the printer menus from the operator panel, you may notice an asterisk (*) to the left of a value in the menus. This asterisk indicates the *factory default setting*. These settings are the original printer settings. (Factory defaults may vary for different regions.)

When you select a new setting from the operator panel, **Submitting Selection** appears. When the Submitting Selection message disappears, an asterisk appears next to the setting to identify it as the current *user default setting*. These settings are active until new ones are stored or the factory defaults are restored.

To restore the original printer factory default settings:

Warning: All downloaded resources (fonts, macros, and symbol sets) in printer memory (RAM) will be deleted. (Resources residing in flash memory or on the optional hard disk remain unaffected.)











- 1 Make sure the printer is on and **Ready** appears on the display.
- 2 Press  on the operator panel.
- 3 Press  until  **Settings** appears, and then press .
- 4 Press  until  **Setup Menu** appears, and then press .
- 5 Press  until  **Factory Defaults** appears, and then press .
- 6 Press  until  **Restore Now** appears, and then press .
- 7 The message **Restoring Factory Defaults** appears, followed by the **Ready** message.

When you select Restore:

- No other button actions are available on the operator panel while **Restoring Factory Defaults** appears.
- All menu settings return to the factory default values, except:
 - The operator panel Display Language setting in the Setup menu.
 - All settings in the Parallel menu, Serial menu, Network menu, and USB menu.

Adjusting Power Saver























To adjust the **Power Saver** setting:

- 1 Make sure the printer is on and **Ready** appears on the display.
- 2 Press  on the operator panel.
- 3 Press  until  **Settings** appears, and then press .
- 4 Press  until  **Setup Menu** appears, and then press .
- 5 Press  until  **Power Saver** appears, and then press .
- 6 Using the numeric pad or the right and left arrows on the operator panel, enter the number of minutes for the printer to wait before entering Power Saver.
The settings available range from 2–240 minutes. If you want to turn Power Saver off, see **Disabling Power Saver on page 106**.
- 7 Press .
Submitting Selection appears.

Note: You can also adjust the Power Saver setting by issuing a Printer Job Language (PDL) command.

Disabling Power Saver















Disabling Power Saver is a two step process. First, you must turn the variable on, and then select the variable. To disable Power Saver:

- 1 Turn the printer off.
- 2 Press and hold  and  while turning the printer on.
- 3 Release both buttons when **Performing Self Test** appears on the display.
The printer performs its power-on sequence, and then **Config Menu** appears on the first line of the display.
- 4 Press  until  **Energy Conserve** appears, and then press .
- 5 Press  until  **Off** appears, and then press .
Submitting Selection appears.
The operator panel returns to **Energy Conserve**.
- 6 Press  until  **Exit Config Menus** appears, and then press .
Resetting the Printer appears briefly followed by a clock. The operator panel then returns to **Ready**.
- 7 Make sure **Ready** appears.
- 8 Press  on the operator panel.
- 9 Press  until  **Settings** appears, and then press .
- 10 Press  until  **Setup Menu** appears, and then press .
- 11 Press  until  **Power Saver** appears, and then press .
- 12 Use either the numeric keypad or the right and left arrows to enter **0** (zero). **Disabled** appears, and then press .
Submitting Selection appears. Power Saver is now disabled.















Encrypting the disk

Warning: All resources on the hard disk will be deleted. (Resources residing in flash memory or in RAM remain unaffected.)

Note: This setting is only available when a hard disk is installed.

- 1 Turn the printer off.
- 2 Press and hold  and  while turning the printer on.
- 3 Release both buttons when **Performing Self Test** appears on the display.
The printer performs its power-on sequence, and then **Config Menu** appears on the first line of the display.
- 4 Press  until  **Disk Encryption** appears, and then press .
- 5 Press  until  **Enable** appears, and then press .
- Contents will be lost. Continue?** appears.
- 6 Press  until  **Yes** appears, and then press .
- The Encrypting Disk progress bar appears.
- 7 When disk encryption has finished, click .
- 8 Press  until  **Exit Config Menu** appears, and then press .

To disable disk encryption:

- 1 Turn the printer off.
- 2 Press and hold  and  while turning the printer on.
- 3 Release both buttons when **Performing Self Test** appears on the display.
The printer performs its power-on sequence, and then **Config Menu** appears on the first line of the display.
- 4 Press  until  **Disk Encryption** appears, and then press .
- 5 Press  until  **Disable** appears, and then press .
- Contents will be lost. Continue?** appears.
- 6 Press  until  **Yes** appears, and then press .
- The Encrypting Disk progress bar appears.
- 7 When disk encryption has finished, click .
- 8 Press  until  **Exit Config Menu** appears, and then press .

Setting security using the Embedded Web Server (EWS)

You can enhance the security of network communications and device configuration by using the advanced security options. These features are available through the Web page of the device.

Setting the system password

Setting the system password protects configuration of the Embedded Web Server. A system password is also required for Secure mode and confidential communication with MVP.

To set the system password:

- 1 Open your Web browser. In the address line, enter the IP address of the printer you want to configure using the format: *http://ip_address/*.
- 2 Click **Configuration**.
- 3 Under Other Settings, click **Security**.
- 4 Click **Create Password**, if one has not been set previously. If a password has already been set, click **Change or Remove Password**.

Using the secure Embedded Web Server

The SSL (Secure Sockets Layer) allows for secure connections to the Web server within the print device. You can connect to the Embedded Web Server more securely by connecting to the SSL port instead of the default HTTP port. The SSL port connection will encrypt all Web server network communications between the PC and the printer. To connect to the SSL port:

Open your Web browser. In the address line, enter the IP address of the printer you want to configure using the format: *https://ip_address/*.

Supporting SNMPv3 (Simple Network Management Protocol version 3)

SNMPv3 protocol allows for encrypted and authenticated network communications. It also lets the administrator select a desired level of security. Prior to use, at least one user name and password must be established from the settings page. To configure for SNMPv3 through the Embedded Web Server of the printer:

- 1 Open your Web browser. In the address line, enter the IP address of the printer you want to configure using the format: *http://ip_address/*.
- 2 Click **Configuration**.
- 3 Under Other Settings, click **Network/Ports**.
- 4 Click **SNMP**.

SNMPv3 authentication and encryption has three levels of support:

- No authentication and no encryption
- Authentication with no encryption
- Authentication and encryption

Note: Only the selected level and later may be used to communicate.

Supporting IPSec (Internet Protocol Security)

IP Security protocol provides authentication and encryption of communications at the network layer allowing all application and network communications over the IP protocol to be secure. IPSec can be set up between the printer and up to five hosts, using both IPv4 and IPv6. To configure IPSec through the Embedded Web Server:

- 1 Open your Web browser. In the address line, enter the IP address of the printer you want to configure using the format: *http://ip_address/*.
- 2 Click **Configuration**.
- 3 Under Other Settings, click **Network/Ports**.
- 4 Click **IPSec**.

Two types of authentication are supported for IPSec:

- **Shared Key Authentication**—Any ASCII phrase shared among all the participating hosts. This is the easiest way to configure when only a few hosts on the network use IPSec.
- **Certificate Authentication**—Allows any hosts or subnet of hosts to authenticate for IPSec. Each host must have a public/private key pair. *Validate Peer Certificate* is enabled by default, requiring each host to have a signed certificate and the authority certificate must be installed. Each host must have its identifier in the *Subject Alternate Name* of the signed certificate.

Note: After a device is configured for IPSec with a host, IPSec is required for any IP communication to take place.

Using Secure mode

You can configure the TCP and UDP ports to one of three modes:

- **Disabled**—Never allows network connections to this port.
- **Secure and Unsecure**—Allows the port to remain open, even in Secure mode.
- **Unsecured Only**—Allows the port to only open when the printer is not in Secure mode

Note: A password must be set to enable Secure mode. Once enabled, only the ports set to Secure and Unsecure will be open.

To configure the Secure mode for TCP and UDP ports from the Embedded Web Server:

- 1 Open your Web browser. In the address line, enter the IP address of the printer you want to configure using the format: *http://ip_address/*.
- 2 Click **Configuration**.
- 3 Under Other Settings, click **Network/Ports**.
- 4 Click **TCP/IP Port Access**.

Note: Disabling ports will disable function on the printer.

Using 802.1x Authenticating

802.1x port authentication allows the printer to join networks that require authentication before allowing access. 802.1x port authentication can be used with the WPA (Wi-Fi Protected Access) feature of an optional internal wireless print server to provide WPA-Enterprise security support.

Support for 802.1x requires the establishment of credentials for the printer. The printer must be known to the Authentication Server (AS). The AS will allow network access to devices presenting a valid set of credentials which typically involves a name/password combination and possibly a certificate. The AS will allow network access to printers presenting a valid set of credentials. You can manage the credentials by using the Embedded Web Server of the printer. To use certificates as part of the credentials:

- 1 Open your Web browser. In the address line, enter the IP address of the printer you want to configure using the format: *http://ip_address/*.
- 2 Click **Configuration**.
- 3 Under Other Settings, click **Network/Ports**.
- 4 Click **Certificate Management**.

To enable and configure 802.1x on the Embedded Web Server after installing the required certificates:

- 1 Open your Web browser. In the address line, enter the IP address of the printer you want to configure using the format: *http://ip_address/*.
- 2 Click **Configuration**.
- 3 Under Other Settings, click **Network/Ports**.
- 4 Click **802.1x Authentication**.

Note: If an optional internal wireless print server is installed, click **Wireless** instead of **802.1x Authentication**.

Locking the operator panel menus

Operator Panel Menu Lockout lets you create a PIN number and choose specific menus to lock. Each time a locked menu is selected, the user will be prompted to enter the correct PIN at the operator panel. The PIN does not affect any access through the EWS. To lock operator panel menus:

- 1 Open your Web browser. In the address line, enter the IP address of the printer you want to configure using the format: *http://ip_address/*.
- 2 Click **Configuration**.
- 3 Under Other Settings, click **Security**.
- 4 Click **Menu Lockout Setup**.

Printing Lockout

Printing Lockout lets you lock or unlock a printer using an assigned PIN. When locked, every job the printer receives will buffer to the hard disk. A user can print jobs only by entering the correct PIN on the operator panel. You can assign a PIN through the Web page of the device.

Note: This setting is only available when a hard disk is installed.

Note: Back channel data will be processed while the printer is locked. Reports such as user or event logs can be retrieved from a locked printer.

To set Printing Lockout:

- 1 Open your Web browser. In the address line, enter the IP address of the printer you want to configure using the format: *http://ip_address/*.
- 2 Click **Configuration**.
- 3 Under Other Settings, click **Security**.
- 4 Click **Printer Lockout PIN**.

Confidential Print Setup

Confidential Print Setup lets you designate a maximum number of PIN entry attempts and set an expiration time for print jobs. When a user exceeds a specific number of PIN entry attempts, all of that user's print jobs are deleted. When a user has not printed their jobs within a designated time period, the print jobs are deleted. To activate Confidential Print Setup:

Note: This feature is only available on network models.

- 1 Open your Web browser. In the address line, enter the IP address of the printer you want to configure using the format: *http://ip_address/*.
- 2 Click **Configuration**.
- 3 Under Other Settings, click **Security**.
- 4 Click **Confidential Print Setup**.

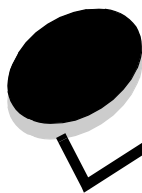

Notices

- **Licensing notice**
- **Electronic emission notices**
- **The United Kingdom Telecommunications Act 1984**
- **Noise emission levels**
- **Waste from Electrical and Electronic Equipment (WEEE) directive**
- **Laser notice**
- **Radio frequency statements**
- **European Community (EC) directives conformity**
- **India emissions notice**

Licensing notice

The printer resident software contains software developed and copyrighted by Lexmark.

In addition, the printer resident software may contain:

- Lexmark modified software licensed under the provisions of the GNU General Public License version 2 and/or the GNU Lesser General Public License version 2.1
- Software licensed under the BSD license
- Software licensed under other licenses

Click the title of the document you want to review:

- **BSD License and Warranty statements**
- **GNU General Public License**
- **Open Source License**

The Lexmark modified third-party software covered by these third-party licenses is free software; you can redistribute it and/or modify it under the terms of the licenses referenced above. These licenses do not provide you any rights to the Lexmark copyrighted software in this printer.

Since the third-party licensed software the Lexmark modifications are based on is supplied explicitly without warranty, use of the Lexmark modified version is similarly provided without warranty. See the warranty disclaimers in the referenced licenses for additional details.

For source code that is required to be made available with the product, see the publications CD in the en/OpenSource directory.

Electronic emission notices

Federal Communications Commission (FCC) compliance information statement

This printer, type 4024 or 4539, has been tested and found to comply with the limits for a Class A digital device, pursuant to Part 15 of the FCC Rules. Operation is subject to the following two conditions: (1) this device may not cause harmful interference, and (2) this device must accept any interference received, including interference that may cause undesired operation.

The FCC Class A limits are designed to provide reasonable protection against harmful interference when the equipment is operated in a commercial environment. This equipment generates, uses, and can radiate radio frequency energy and, if not installed and used in accordance with the instruction manual, may cause harmful interference to radio communications. Operation of this equipment in a residential area is likely to cause harmful interference, in which case the user will be required to correct the interference at his own expense.

The manufacturer is not responsible for any radio or television interference caused by using other than recommended cables or by

unauthorized changes or modifications to this equipment. Unauthorized changes or modifications could void the user's authority to operate this equipment.

Note: To assure compliance with FCC regulations on electromagnetic interference for a Class A computing device, use a properly shielded and grounded cable. Use of a substitute cable not properly shielded and grounded may result in a violation of FCC regulations.

Industry Canada compliance statement

This Class A digital apparatus meets all requirements of the Canadian Interference-Causing Equipment Regulations.

Avis de conformité aux normes de l'industrie du Canada

Cet appareil numérique de la classe A respecte toutes les exigences du Règlement sur le matériel brouilleur du Canada.

European Community (EC) directives conformity

A declaration of conformity with the requirements of the directives has been signed by the Director of Manufacturing and Technical Support, Lexmark International, S.A., Boigny, France. This product satisfies the Class A limits of EN 55022 and safety requirements of EN 60950.

Radio interference notice

Warning: This is a Class A product. In a domestic environment, this product may cause radio interference, in which case, the user may be required to take adequate measures.

Japanese VCCI notice

この装置は、情報処理装置等電波障害自主規制協議会(VCCI)の基準に基づくクラスA情報技術装置です。この装置を家庭環境で使用すると電波妨害を引き起こすことがあります。この場合には使用者が適切な対策を講ずるよう要求されることがあります。

Korean MIC statement

If this symbol appears on your product, the accompanying statement is applicable.



이 기기는 업무용으로 전자파적합등록을 한 기기이오니 판매자 또는 사용자는 이 점을 주의하시기 바라며 만약 잘못 판매 또는 구입하였을 때에는 가정용으로 교환하시기 바랍니다.

This equipment has undergone EMC registration as a business product. It should not be used in a residential area.

The United Kingdom Telecommunications Act 1984

This apparatus is approved under the approval number NS/G/1234/J/100003 for the indirect connections to the public telecommunications systems in the United Kingdom.

Noise emission levels

The following measurements were made in accordance with ISO 7779 and reported in conformance with ISO 9296.

1-meter average sound pressure, dBA	
Printing	56
Idling	30

Waste from Electrical and Electronic Equipment (WEEE) directive



The WEEE logo signifies specific recycling programs and procedures for electronic products in countries of the European Union. We encourage the recycling of our products. If you have further questions about recycling options, please contact the place where you bought your printer.

Laser notice

The printer is certified in the U.S. to conform to the requirements of DHHS 21 CFR Subchapter J for Class I (1) laser products, and elsewhere is certified as a Class I laser product conforming to the requirements of IEC 60825-1.

Class I laser products are not considered to be hazardous. The printer contains internally a Class IIIb (3b) laser that is nominally a 5 milliwatt gallium arsenide laser operating in the wavelength region of 770-795 nanometers. The laser system and printer are designed so there is never any human access to laser radiation above a Class I level during normal operation, user maintenance, or prescribed service condition.

LUOKAN 1 LASERLAITE

VAROITUS! Laitteen käyttäminen muulla kuin tässä käyttöohjeessa mainitulla tavalla saattaa altistaa käyttäjän turvallisuusluokan 1 ylittävälle näkymättömälle lasersäteilylle.

KLASS 1 LASER APPARAT

WARNING! Om apparaten används på annat sätt än i denna bruksanvisning specificerats, kan användaren utsättas för osynlig laserstrålning, som överskrider gränsen för laserklass 1.

Radio frequency statements

Exposure to radio frequency radiation

The radiated output power of this device is far below the FCC radio frequency exposure limits. A minimum separation of 20 cm (8 inches) must be maintained between the antenna and any persons for this device to satisfy the RF exposure requirements of the FCC.

Industry Canada compliance statement

This device complies with Industry Canada specification RSS-210. Operation is subject to the following two conditions: (1) this device may not cause interference, and (2) this device must accept any interference received, including interference that may cause undesired operation of the device.

Avis de conformité aux normes de l'industrie du Canada

Cet appareil est conforme à la spécification RSS-210 d'Industry Canada. Son fonctionnement est soumis aux deux conditions suivantes: (1) cet appareil ne peut engendrer aucune interférence et (2) il doit accepter toute interférence qu'il reçoit, y compris celles qui peuvent altérer son fonctionnement.

European Community (EC) directives conformity

This product is in conformity with the protection requirements of EC Council directives 89/336/EEC, 73/23/EEC, and 1999/5/EC on the approximation and harmonization of the laws of the Member States relating to electromagnetic compatibility, safety of electrical equipment designed for use within certain voltage limits and on radio equipment and telecommunications terminal equipment. Compliance is indicated by the CE marking.

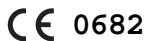

A declaration of conformity with the requirements of the directives is available from the Director of Manufacturing and Technical Support, Lexmark International, S. A., Boigny, France. This product satisfies the limits of EN 55022 (Class A); safety requirements of EN 60950; radio spectrum requirements of ETSI

EN 300 330-1 and ETSI EN 300 330-2; and the EMC requirements of EN 55024, ETSI EN 301 489-1 and ETSI EN 301 489-3.

English	Hereby, Lexmark International Inc., declares that this Short Range Device is in compliance with the essential requirements and other relevant provisions of Directive 1999/5/EC.
Finnish	Valmistaja Lexmark International Inc. vakuuttaa täten että Short Range Device tyyppinen laite on direktiivin 1999/5/EY oleellisten vaatimusten ja sitä koskevien direktiivin muiden ehtojen mukainen.
Dutch	Hierbij verklaart Lexmark International Inc. dat het toestel Short Range Device in overeenstemming is met de essentiële eisen en de andere relevante bepalingen van richtlijn 1999/5/EG
	Bij deze verklaart Lexmark International Inc. dat deze Short Range Device voldoet aan de essentiële eisen en aan de overige relevante bepalingen van Richtlijn 1999/5/EC.
French	Par la présente Lexmark International Inc. déclare que l'appareil Short Range Device est conforme aux exigences essentielles et aux autres dispositions pertinentes de la directive 1999/5/CE
	Par la présente, Lexmark International Inc. déclare que ce Short Range Device est conforme aux exigences essentielles et aux autres dispositions de la directive 1999/5/CE qui lui sont applicables
Swedish	Härmed intygar Lexmark International Inc. att denna Short Range Device står i överensstämmelse med de väsentliga egenskapskrav och övriga relevanta bestämmelser som framgår av direktiv 1999/5/EG.
Danish	Undertegnede Lexmark International Inc. erklærer herved, at følgende udstyr Short Range Device overholder de væsentlige krav og øvrige relevante krav i direktiv 1999/5/EF
German	Hiermit erklärt Lexmark International Inc., dass sich dieser/diese/dieses Short Range Device in Übereinstimmung mit den grundlegenden Anforderungen und den anderen relevanten Vorschriften der Richtlinie 1999/5/EG befindet". (BMW i)
	Hiermit erklärt Lexmark International Inc. die Übereinstimmung des Gerätes Short Range Device mit den grundlegenden Anforderungen und den anderen relevanten Festlegungen der Richtlinie 1999/5/EG. (Wien)
Greek	Με την παρουσία Lexmark International Inc. δηλώνει ότι Short Range Device συμμορφώνεται προς τις ουσιαστικές απαιτήσεις και τις λοιπές σχετικές διατάξεις της οδηγίας 1999/5/EK.
Italian	Con la presente Lexmark International Inc. dichiara che questo Short Range Device è conforme ai requisiti essenziali ed alle altre disposizioni pertinenti stabilite dalla direttiva 1999/5/CE.

Spanish	Por medio de la presente Lexmark International Inc. declara que el Short Range Device cumple con los requisitos esenciales y cualesquiera otras disposiciones aplicables o exigibles de la Directiva 1999/5/CE
Portuguese	Lexmark International Inc. declara que este Short Range Device está conforme com os requisitos essenciais e outras provisões da Directiva 1999/5/CE.
Czech	Lexmark International Inc. tímto prohlašuje, že tento výrobek s typovým označením Short Range Device vyhovuje základním požadavkům a dalším ustanovením směrnice 1999/5/ES, které se na tento výrobek vztahují.
Hungarian	Lexmark International Inc. ezennel kijelenti, hogy ez a Short Range Device termék megfelel az alapvető követelményeknek és az 1999/5/EC irányelv más vonatkozó rendelkezéseinek.
Estonian	Käesolevaga kinnitab Lexmark International Inc. seadme Short Range Device vastavust direktiivi 1999/5/EÜ põhinõuetele ja nimetatud direktiivist tulenevatele teistele asjakohastele sätetele.
Latvian	Ar šo Lexmark International Inc. deklare, ka Short Range Device atbilst Direktivas 1999/5/EK būtiskajam prasībam un citiem ar to saistītajiem noteikumiem.
Lithuanian	Lexmark International Inc. deklaruoja, kad irenginys Short Range Device tenkina 1999/5/EB Direktyvos esminius reikalavimus ir kitas sios direktyvos nuostatas
Maltese	Hawnhekk, Lexmark International Inc., jiddikjara li dan Short Range Device jikkonforma mal-htigijiet essenzjali u ma provvedimenti ohrajn rilevanti li hemm fid-Dirrettiva 1999/5/EC
Polish	Lexmark International Inc., deklarujemy z pełna odpowiedzialnoscia, ze wyrób Short Range Device spełnia podstawowe wymagania i odpowiada warunkom zawartym w dyrektywie 1999/5/EC
Slovak	Lexmark International Inc. týmto vyhlasuje, že tento Short Range Device vyhovuje technickým požiadavkám a ĩalším ustanoveniam smernice 1999/5/ES, ktoré sa na tento výrobok vzťahujú.
Slovenian	S tem dokumentom Lexmark International Inc., izjavlja, da je ta Short Range Device v skladu z bistvenimi zahtevami in z drugimi ustreznimi določili Direktive 1999/5/EC

India emissions notice

This device uses very low power low range RF communication that has been tested and found not to cause any interference whatsoever. The manufacturer is not responsible in case of any disputes arising out of requirement of permissions from any local authority, regulatory bodies or any organization, required by the end-user to install and operate this product at his premises.

भारतीय उत्सर्जन सूचना

यह यंत्र बहुत ही कम शक्ति, कम रेंज के RF कम्युनिकेशन का प्रयोग करता है जिसका परीक्षण किया जा चुका है, और यह पाया गया है कि यह किसी भी प्रकार का व्यथान उत्पन्न नहीं करता । इसके अंतिम प्रयोक्ता द्वारा इस उत्पाद को अपने प्रांगण में स्थापित एवं संचालित करने हेतु किसी स्थानीय प्राधिकरण, नियामक निकायों या किसी संगठन से अनुज्ञा प्राप्त करने की जरूरत के संबंध में उठे विवाद की स्थिति में विनिर्माता जिम्मेदार नहीं है।

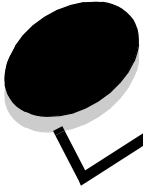

Index

A

- adjust paper tray 50, 55
- adjusting
 - Power Saver 106
- authorized supplies dealers 70
- automatic size sensing 59
- automatic tray linking 59

B

- bridge unit assembly 7

C

- card stock
 - guidelines 47
 - loading 49
- characteristics, media
 - letterhead 44
- characteristics, print media 42
 - paper 42
- confidential jobs 65
 - entering a PIN 65
 - entering user name 65
 - sending 65

D

- disabling operator panel menus 104
- Duplex unit 7

E

- electrical emission statement 112
- Embedded Web Server 108
- emission statement 112
- enabling operator panel menus 105
- envelopes
 - guidelines 45

F

- FCC statement 112
- Finisher 7
- front guide 50, 55

G

- guidelines
 - paper
 - unacceptable 43
 - print media 42

- printing letterhead 44

H

- held jobs
 - confidential jobs 65
 - entering a PIN 65
 - entering user name 65
 - overview 65
 - types of 65

I

- Identifying printers 6
- Indicator light 10
- integrated forms 40, 41
- Internet Protocol Security 109

J

- jams
 - avoiding 48
 - clearing 75

L

- labels
 - guidelines 46
- letterhead 44
 - guidelines 44
 - page orientation 44
 - printing 44
- linking 59
 - trays 59
- Linux 16, 24
- loading print media
 - card stock 49
 - paper
 - input tray 49
 - multipurpose feeder 52
 - transparencies
 - input tray 49
- lock feature, security 110

M

- Macintosh 15, 21, 64, 66
- maintaining the printer 70
 - ordering a toner cartridge 71
- maintenance
 - staple cartridge 72
- maximum stack height 50, 53, 56

Index

media
 guidelines
 letterhead 44
 letterhead, printing 44
 letterhead
 guidelines 44
 loading instructions based on source 44
 transparencies, guidelines 45
memory
 Print and Hold function 65
multipurpose feeder
 guidelines 52

N

NetWare 24
network setup page 17

O

operator panel 9, 17
 disabling menus 104
 enabling menus 105
ordering, toner cartridge 71

P

panel, operator 9
paper
 letterhead 44
 preprinted forms 44
 recommended types 42
 unsatisfactory types 43
paper tray adjustment 50, 55
photoconductor
 ordering 71
PIN
 entering at the printer 67
 entering from the driver 65
 for confidential jobs 65
Power Saver, adjusting 106
preprinted forms 44
print media
 guidelines 42
 paper 42
Print media guidelines 42
print media jams
 avoiding 48
print media specifications
 characteristics 42
 sizes 35, 38
 types 39
 weight 40
Printing 49
problems
 incorrect characters print 96
 job didn't print 95
 job prints 96
 from wrong tray 96

 on wrong paper or specialty media 96
 large jobs do not collate 96
 operator panel 95
 blank 95
 displays black diamonds 95
 paper feed
 blank pages in output bin 99
 frequent jams 99
 jammed page does not reprint 99
 Paper Jam message remains after clearing jam 99
 print time seems long 96
 tray linking does not work 96
 unexpected page breaks 96

R

repeat print 67
replacing
 staple cartridge 72
reserve print 67

S

safety information 2
Secure mode 109
security 108
sending a job to print 61
short-edge feed 58
side guide 50
Simple Network Management Protocol 108
staple and offset unit
 replacing staples 72
staple cartridge, replacing 72
staple jam 92
Staples Empty or Misfed message 92
supplies
 maintenance kit 72
 toner cartridge 71

T

toner cartridge
 ordering 71
transparencies
 loading
 input tray 49
tray linking 59

U

UNIX 16, 24
USB Direct interface 62
USB flash memory device 62

V

verify print 67

W

Windows 18

Readers' Comments — We'd Like to Hear from You

Infoprint 1585 (MT 4539)
User's Guide

Publication No. S510-4133-00

Overall, how satisfied are you with the information in this book?

	Very Satisfied	Satisfied	Neutral	Dissatisfied	Very Dissatisfied
Overall satisfaction	<input type="checkbox"/>	<input type="checkbox"/>	<input type="checkbox"/>	<input type="checkbox"/>	<input type="checkbox"/>

How satisfied are you that the information in this book is:

	Very Satisfied	Satisfied	Neutral	Dissatisfied	Very Dissatisfied
Accurate	<input type="checkbox"/>	<input type="checkbox"/>	<input type="checkbox"/>	<input type="checkbox"/>	<input type="checkbox"/>
Complete	<input type="checkbox"/>	<input type="checkbox"/>	<input type="checkbox"/>	<input type="checkbox"/>	<input type="checkbox"/>
Easy to find	<input type="checkbox"/>	<input type="checkbox"/>	<input type="checkbox"/>	<input type="checkbox"/>	<input type="checkbox"/>
Easy to understand	<input type="checkbox"/>	<input type="checkbox"/>	<input type="checkbox"/>	<input type="checkbox"/>	<input type="checkbox"/>
Well organized	<input type="checkbox"/>	<input type="checkbox"/>	<input type="checkbox"/>	<input type="checkbox"/>	<input type="checkbox"/>
Applicable to your tasks	<input type="checkbox"/>	<input type="checkbox"/>	<input type="checkbox"/>	<input type="checkbox"/>	<input type="checkbox"/>

Please tell us how we can improve this book:

Thank you for your responses. May we contact you? Yes No

When you send comments to IBM, you grant IBM a nonexclusive right to use or distribute your comments in any way it believes appropriate without incurring any obligation to you.

Name

Address

Company or Organization

Phone No.



Fold and Tape

Please do not staple

Fold and Tape



NO POSTAGE
NECESSARY
IF MAILED IN THE
UNITED STATES

BUSINESS REPLY MAIL

FIRST-CLASS MAIL PERMIT NO. 40 ARMONK, NEW YORK

POSTAGE WILL BE PAID BY ADDRESSEE

IBM Corporation
Information Development IBM Printing Systems Department
H7FE
Building 004N PO Box 1900 Boulder, CO
80301-9817



Fold and Tape

Please do not staple

Fold and Tape



Part Number: 75P6998

Printed in USA

S510-4133-00



(1P) P/N: 75P6998



Free Manuals Download Website

<http://myh66.com>

<http://usermanuals.us>

<http://www.somanuals.com>

<http://www.4manuals.cc>

<http://www.manual-lib.com>

<http://www.404manual.com>

<http://www.luxmanual.com>

<http://aubethermostatmanual.com>

Golf course search by state

<http://golfingnear.com>

Email search by domain

<http://emailbydomain.com>

Auto manuals search

<http://auto.somanuals.com>

TV manuals search

<http://tv.somanuals.com>