



iLV200/iLC200 IBM Data/Video Projector

User's Guide

OPTIONS
by IBM

Note: Before using this information and the product it supports, read the information under the Appendixes.

First Edition (January 2002)

© Copyright International Business Machines Corporation 2002. All rights reserved.
US Government Users Restricted Rights – Use, duplication or disclosure restricted by
GSA ADP Schedule Contract with IBM Corp.

Safety

Before installing this product, read the Safety Information.

مج، يجب قراءة دات السلامة

Antes de instalar este produto, leia as Informações de Segurança.

在安装本产品之前，请仔细阅读 **Safety Information** (安全信息)。

Prije instalacije ovog produkta obavezno pročitajte Sigurnosne Upute.

Před instalací tohoto produktu si přečtěte příručku bezpečnostních instrukcí.

Læs sikkerhedsforskrifterne, før du installerer dette produkt.

Ennen kuin asennat tämän tuotteen, lue turvaohjeet kohdasta Safety Information.

Avant d'installer ce produit, lisez les consignes de sécurité.

Vor der Installation dieses Produkts die Sicherheitshinweise lesen.

Πριν εγκαταστήσετε το προϊόν αυτό, διαβάστε τις πληροφορίες ασφάλειας (safety information).

לפני שתתקינו מוצר זה, קראו את הוראות הבטיחות.

A termék telepítése előtt olvassa el a Biztonsági előírásokat!

Prima di installare questo prodotto, leggere le Informazioni sulla Sicurezza.

製品の設置の前に、安全情報をお読みください。

본 제품을 설치하기 전에 안전 정보를 읽으십시오.

Пред да се инсталира овој продукт, прочитајте информацијата за безбедност.

Lees voordat u dit product installeert eerst de veiligheidsvoorschriften.

Les sikkerhetsinformasjonen (Safety Information) før du installerer dette produktet.

Przed zainstalowaniem tego produktu, należy zapoznać się z książką "Informacje dotyczące bezpieczeństwa" (Safety Information).

Antes de instalar este produto, leia as Informações sobre Segurança.

Перед установкой продукта прочтите инструкции по технике безопасности.

Pred inštaláciou tohto zariadenia si pečítajte Bezpečnostné predpisy.

Pred namestitvijo tega proizvoda preberite Varnostne informacije.

Antes de instalar este producto lea la información de seguridad.

Läs säkerhetsinformationen innan du installerar den här produkten.

安裝本產品之前，請先閱讀「安全資訊」。

Contents

Safety	iii
About this book	vii
Registering your option	vii
Installation and user's guide.	1-1
Introduction	1-1
Image resolution	1-1
Compatibility	1-1
Unpacking the projector	1-2
Usage guidelines	1-3
Setting up the projector	1-4
Connecting a computer	1-6
Connecting a video player	1-7
Starting the projector and adjusting the image	1-9
Turning off the projector	1-10
Maintenance and troubleshooting	1-25
Replacing the batteries in the remote control.	1-28
Appendix A. Product specifications and accessories	A-1
Specifications	A-1
Accessories	A-2
Appendix B. Portable and mobile computer activation	B-1
Appendix C. Using video mirroring	C-1
Using video mirroring with a PowerBook computer	C-1
Using Simulscan	C-1
Appendix D. Projected image size.	D-1
Appendix E. Product Warranty	E-1
Warranty Period	E-1
Service and support	E-1
Warranty information on the World Wide Web	E-1
Online technical support.	E-1
Telephone technical support	E-2
IBM Statement of Limited Warranty Z125-4753-06 8/2000.	E-3
Warranty information.	E-3
Warranty period	E-3
Service and support	E-3
IBM Statement of Limited Warranty Z125-4753-06 8/2000.	E-5

Appendix F. Notices	F-1
Federal Communications Commission (FCC) statement	F-1
Notices	F-4
Trademarks	F-5

About this book

This manual contains instructions for installing and using the IBM® iLV200 and iLC200 Multimedia Projectors. The manual is divided into the following parts:

Part 1: Installation and user's guide

This CD contains the online User's Guide for the iLV200 and iLC200 projectors in the following languages:

- English
- French
- Spanish
- Italian
- Brazilian Portuguese
- Traditional Chinese
- Simplified Chinese
- Japanese

Part 2: Appendixes

This section contains product specifications, portable and mobile computer activation, using video mirroring, projected image size, help and service, product warranty, and notice information.

Note: The illustrations in this manual might be slightly different from your hardware.

Registering your option

Thank you for purchasing OPTIONS by IBM. Please take a few moments to register your product and provide us with information that will help IBM to better serve you in the future. Your feedback is valuable to us in developing products and services that are important to you, as well as in developing better ways to communicate with you. Register your option on the IBM Web site at

<http://www.ibm.com/pc/register>

IBM will send you information and updates on your registered product unless you indicate on the Web site questionnaire that you do not want to receive further information.

Installation and user's guide

This section contains installation and usage information.

Introduction

The IBM® iLV200 and iLC200 Data/Video Projectors are specifically designed for multipurpose use. They generate crisp, clear images using Digital Light Processing™ (DLP) technology and feature an M1-DA connector for easy, built-in digital/analog and USB connectivity. They are easy to connect, easy to use, easy to transport, and easy to maintain. The iLV200 has native SVGA 800 x 600 resolution, the iLC200 has XGA 1024x768 resolution. The user-interfaces of the two products are identical; information in this user's guide applies to both products.

The projectors are compatible with these major broadcast video standards: NTSC, NTSC 4.43, PAL, PAL-M, PAL-N, PAL-60, and SECAM. They automatically adjust to optimize its performance for the incoming video.

Image resolution

The SVGA resolution of the iLV200 projected image is 800x600. The projector is compatible with screen resolutions up to 1280x1024. If your computer screen resolution is higher than 1280x1024, reset it to a lower resolution before you connect the projector.

Note: The iLV200 projector automatically expands 640 x480 images to 800 x 600. You can display these images at their native resolutions by turning off the Auto Resize feature. For more information, see "Resize" on page 1-20.

The XGA resolution of the iLC200 projected image is 1024x768. The projector is compatible with screen resolutions up to 1280x1024. If your computer screen resolution is higher than 1280x1024, reset it to a lower resolution before you connect the projector.

Note: The iLC200 projector automatically expands 640x480 and 800x600 images to 1024x768. You can display these images at their native resolutions by turning off the Auto Resize feature. For more information, see "Resize" on 1-20.

Compatibility

The projector is compatible with a wide variety of computers and video devices, including:

- IBM-compatible computers, including mobile computers, up to 1280 x 1024 resolution.
- Apple Macintosh and PowerBook computers up to 1280 x 1024 resolution.
- Most standard VCRs, DVD players, HDTV sources, camcorders, and laser disc players.

Note: The projector is compatible with 1080i and 720P HDTV formats.

Unpacking the projector

The projector comes with the items that are shown in the illustration. Check to make sure that all items are included. Contact your dealer if anything is missing. If you are experienced in setting up presentation systems, use the *Quick Start* card that comes with the projector. For complete details on connecting and operating the projector, refer to the *User's Guide*.

Attention: This product contains a Metal Arc Lamp which contains Mercury. Dispose of it as required by local ordinances and regulations.

Note: The items that come with your projector might vary depending on the projector configuration you have ordered.

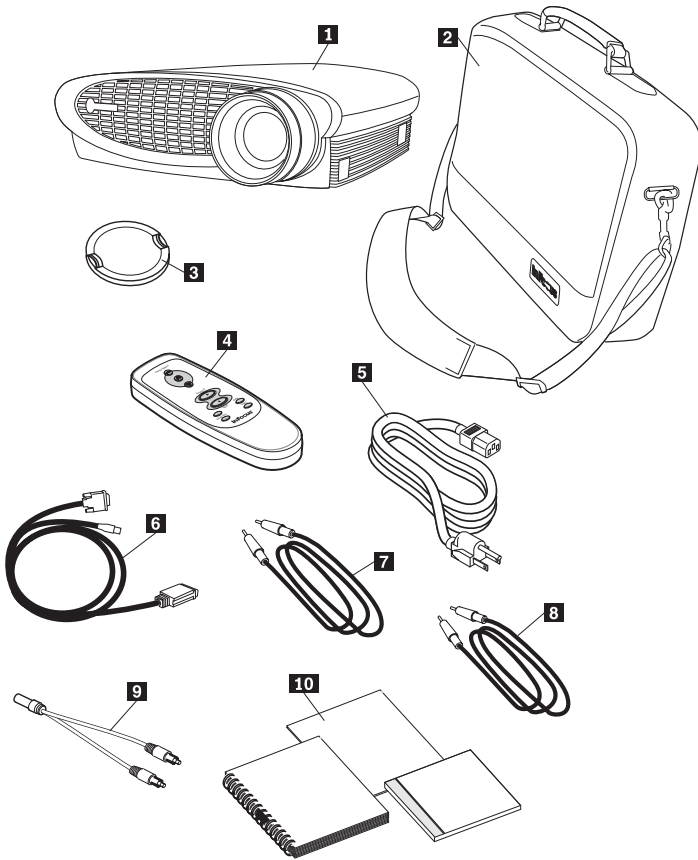

1 iLV200/iLC200 Projector

4 Remote control

7 Audio cable

10 Quick-Start card, multi-language User's Guide, and Safety information manual

2 Soft carry case

5 Power Cord

8 MI-DA analog computer cable

Usage guidelines

Observe the following guidelines when using the projector.

Attention: Do not look directly into the projection lens when the lamp is turned on. The bright light might harm your eyes.

Attention: Do not block the grills on the projector. Restricting the airflow can cause it to overheat and turn off. If this happens, you must wait a minute before attempting to turn it back on.

- Handle the projector as you would any product with glass components. Be especially careful not to drop it.
- Avoid leaving the projector in direct sunlight or extreme cold for extended periods of time. If this happens, allow it to reach room temperature before use.
- Transport the projector in a carrying case. Refer to Appendix A to determine what accessories are available for your projector.

Setting up the projector

Use the following procedure to set up the projector:

1. Place the projector on a flat surface.
 - The projector must be within 10 feet (3 m) of your power source and within 6 ft. (1.8 m) of your computer.
 - If you want to project from behind a translucent screen, set up the projector behind the screen. See "Rear projection" on page 1-22 for instructions for reversing the image.
2. Position the projector the desired distance from the screen.
 - The distance from the lens of the projector to the screen and the zoom setting determine the size of the projected image. The following illustration shows three projected image sizes. For more information about image size, see Appendix D, "Projected image size," on page 15.

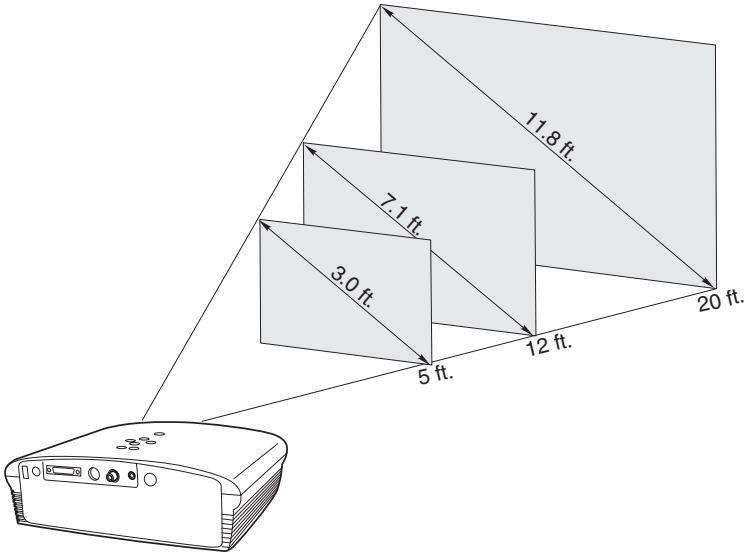

3. Make sure that the projector is unplugged and your computer is turned off.

Note: If you are connecting the projector to a computer, make sure that the distance between the computer and the projector is six ft. or less. Connect the cables to the corresponding control panel by matching the icons. Reference the following two illustrations.

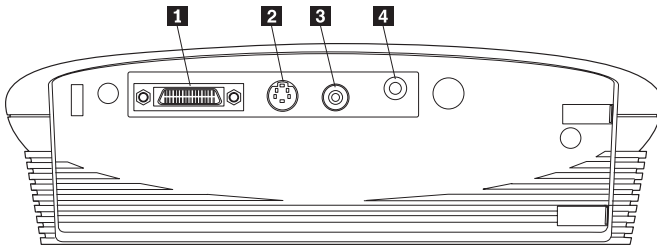

1 Computer

2 S-Video

3 Composite video

4 Audio in

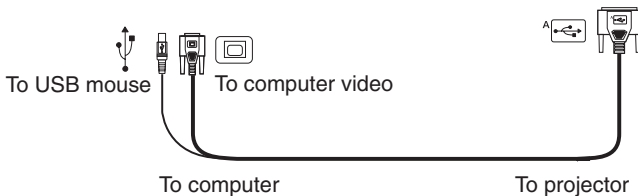



DANGER

Electrical current from power, telephone, and communication cables is hazardous.

To avoid a shock hazard:

- Do not connect or disconnect any cables or perform installation, maintenance, or reconfiguration of this product during an electrical storm.
- Connect all power cords to a properly wired and grounded electrical outlet.
- Connect to properly wired outlets any equipment that will be attached to this product.
- When possible, use one hand only to connect or disconnect signal cables.
- Never turn on any equipment when there is evidence of fire, water, or structural damage.
- Disconnect the attached power cords, telecommunications systems, networks, and modems before you open the device covers, unless instructed otherwise in the installation and configuration procedures.
- Connect and disconnect cables as described in the following table when installing, moving, or opening covers on this product or attached devices.

To connect:

1. Turn everything OFF.
2. First attach all cables to devices.
3. Attach signal cables to connectors.
4. Attach power cords to outlet.
5. Turn device ON.

To disconnect:

1. Turn everything OFF.
2. First, remove power cords from outlet.
3. Remove signal cables from connectors.
4. Remove all cables from devices.

Connecting a computer

The projector comes with an M1-DA analog computer cable. If your computer has a digital output, you can use the optional M1-DA digital computer cable, sold separately. See Appendix A for ordering accessories.

1. Plug the end of the M1-DA analog computer cable (marked A) into the connector marked AD on the projector.
2. Plug the end of the M1-DA analog computer cable into the video connector on your computer.

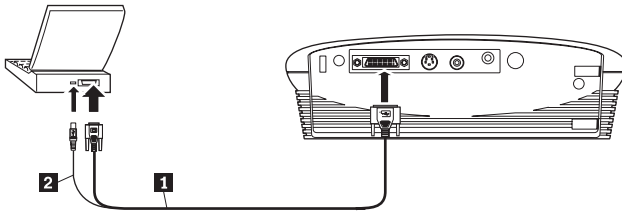

1 Computer cable

2 USB mouse

Note: Many mobile computers do not automatically turn on their external video port when a secondary display device such as a projector is connected. See your computer manual for the command that activates the external video port. Press F7 on your IBM ThinkPad to activate the external display. Activation commands for some mobile computers are listed in Appendix B.

Note: If you are connecting the projector to an older Macintosh computer that does not have a 15-pin connector, you must use a Mac adapter between the computer and the projector.

To control the computer mouse from the projector remote control or keypad, plug the end of the M1-DA analog computer cable into the mouse connector on your computer.

Note: The USB mouse is supported for use only with Microsoft® Windows® 98, Microsoft Windows 2000 Professional, and Apple OS 8.5 and later.

To play the audio from your computer audio on the projector, plug either end of the audio cable into the audio connector on your computer. Plug the other end of the audio cable into the speaker connector on the projector.

For information about starting the projector and computer, go to “Starting the projector and adjusting the image” on page 1-9.

Note: You do not need to restart your computer after connecting a USB mouse. It is hot-pluggable.

Connecting a video player

Use the following procedure to connect a video player.

If your video player uses a round, one-prong composite video connector, you'll need only the audio cable, audio adapter, and composite video cable that comes with the projector. If your video player uses a round, four-prong S-video

connector, you'll need an S-video cable in addition to the audio cable and audio adapter. The S-video cable is sold separately. See Accessories in Appendix A.

1. Plug the yellow connector of the composite video cable into the "video-out" connector on your video player. This connector might be labeled "To Monitor." Or, if you are using an S-video cable, connect it to the "S-video out" connector on the video player.
2. Plug the other yellow connector into the composite video connector on the projector. Or, if you are using S-video, plug the other end of the cable into the "S-video" connector on the projector.

Note: High Definition Television (HDTV) sources are connected to the projector using the M1-DA computer cable.

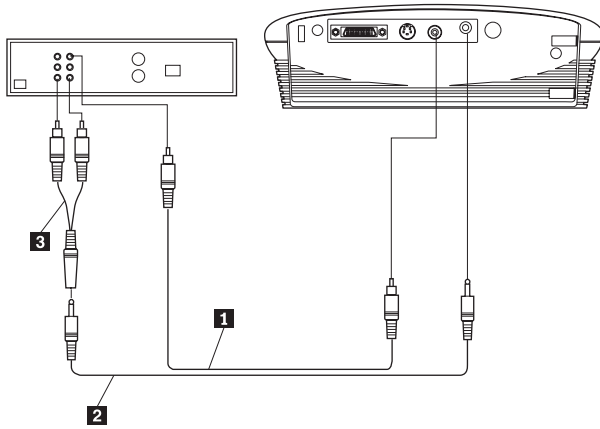

1 Composite cable

2 Audio cable

3 Audio adapter

3. Plug the white connector of the audio adapter into the left "audio out" connector on your video player. Plug the red connector of the adapter into the right "audio out" connector on the video player.
4. Plug the other end of the audio adapter into the audio cable.
5. Plug the audio cable into the "audio in" connector on the projector.

Note: The audio adapter is provided so that the same audio cable that is used to connect a computer can be used with the adapter to connect a VCR.

Note: Your video player might also have a "Video Out" connector for a coaxial cable connection. *Do not* use this to connect to the projector.



DANGER

Electrical current from power, telephone, and communication cables is hazardous.

To avoid a shock hazard:

- Do not connect or disconnect any cables or perform installation, maintenance, or reconfiguration of this product during an electrical storm.
- Connect all power cords to a properly wired and grounded electrical outlet.
- Connect to properly wired outlets any equipment that will be attached to this product.
- When possible, use one hand only to connect or disconnect signal cables.
- Never turn on any equipment when there is evidence of fire, water, or structural damage.
- Disconnect the attached power cords, telecommunications systems, networks, and modems and modems before you open the device covers, unless instructed otherwise in the installation and configuration procedures.
- Connect and disconnect cables as described in the following table when installing, moving, or opening covers on this product or attached devices.

To connect:

1. Turn everything OFF.
2. First attach all cables to devices.
3. Attach signal cables to connectors.
4. Attach power cords to outlet.
5. Turn device ON.

To disconnect:

1. Turn everything OFF.
2. First, remove power cords from outlet.
3. Remove signal cables from connectors.
4. Remove all cables from devices.

Starting the projector and adjusting the image

Use the following procedure to start the projector and adjust the image.

Note: Always use the power cord that comes with the projector.

1. Remove the lens cap.
2. Plug the power cord into the side of the projector, and then plug it into an electrical outlet. A surge-protected power strip is recommended. The fans start to run, and the Lamp LED on the top of the projector lights orange until the software has initialized. When initialization is complete, the Lamp LED lights green. A green Lamp LED indicates that you can press the lamp on/off button to turn the lamp on and off.

Note: The first time you connect your computer to the projector, the computer might display a message stating that new hardware was

found. The Add New Hardware Wizard window might open. Use the wizard to install the correct device driver (the computer considers the projector a Plug and Play monitor).

3. Turn on the lamp by pressing the lamp on/off button on the keypad. The startup window opens.
4. If you connected a video player, turn it on. The video image displays on the projection screen. If a computer source is active, press the source button on the keypad or the video button on the remote control to display your video image. You can select a default source to determine which source the projector examines first during power-up for active video; see “Default source” on page 1-22. Use the volume buttons to adjust the volume.
5. Turn on your computer.

Note: With some computers, the order in which you turn on the equipment is very important. Most computers should be turned on last, after all other peripheral devices have been turned on. See your computer documentation to determine the correct order.

- The computer image displays on the projection screen. If a video source is active, press the source button on the keypad or the computer button on the remote control to display the computer image. Make sure that your notebook computer’s external video port is activated; see “Portable and mobile computer activation chart” in Appendix B for details.
- If necessary, make adjustments to the image using the on-screen menus of the projector. To open the menus, press the menu button on the keypad or remote control, then select the Display or Image submenu. For information about the menus, see “Using the on-screen menus” on page 1-15.

Turning off the projector

If you want to turn off the projector for a short period of time, press the standby button on the keypad or remote control. This removes the image from the screen for 15 minutes, but keeps the projector running. (You can change the amount of time the projector stays in standby mode; see “Standby time” on page 1-22 for details.) After 15 minutes, the lamp turns off and the projector keeps running. To exit from standby mode, press the standby button again. It might take several seconds for the projection lamp to reach full power and project the image again.

Note: Lamp life will be extended if you turn the lamp off and then wait one minute while the lamp cools before you unplug the projector. The Lamp LED will light green when the lamp has cooled.

Using the projector

This section describes how to use and make adjustments to the projector. It also provides a reference to the keypad and remote-control buttons and the options that are available from the on-screen menus.

Basic image adjustment

To adjust the image, do the following.

- Make sure you have turned on your equipment in the right order. See “Starting the projector and adjusting the image” on page 1-9.
- If the image is not displayed completely, zoom the image (see “Adjusting the projector” on page 1-12), adjust the height of the projector (see “Adjusting the projector” on page 1-12) or center the image by adjusting its horizontal or vertical position (see page 1-21). Be sure that the projector is at a 90-degree angle to the screen.
- If the image is out of focus, rotate the focus lens (see “Adjusting the projector” on page 1-12).
- If the image appears to shimmer or if it has blurry vertical bars after you have adjusted the focus, turn Auto Image (see page 1-20) off and on again to reset the automatic sync and tracking option. If that does not improve the image, turn Auto Image off, and adjust the manual sync (see page 1-20), the tracking (see page 1-20), or both.
- If the colors do not display correctly, adjust the brightness (see page 1-17).

Using the remote control

The projector comes with a remote control that has four function buttons, a disk mouse, and two mouse buttons (one on the top of the remote and one on the bottom).

Point the remote control at the projection screen or at the front of the projector. The range for optimum operation is approximately 25 feet. If you point the remote control at the projection screen, the distance to the screen and back to the projector must be less than or equal to 25 feet. For best results, point the remote control directly at the projector.

Note: If the remote control is inactive for several minutes, it “sleeps” to conserve battery life. Press any button except the disk mouse to

reactivate the remote control.

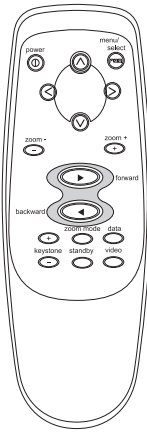

To use the forward and backward buttons on the remote to advance slides in PowerPoint[®], connect the USB connector on the computer cable to the computer. You must install the USB drivers on your computer to enable USB connectivity. To configure the PowerPoint for this, click **Options** from the Tools menu, click the **View** tab, deselect the **Popup Menu on Right Mouse Click** option in the Slide Show section, and then click **OK**. Then, when you are in the PowerPoint Slide Show mode, click the left mouse button to advance to the next slide, and click the right mouse button to return to the previous slide (other PowerPoint modes are not affected).

Adjusting the projector

To focus the image, rotate the focus ring **2** (see the following illustration) until the image is clear. To zoom the image, rotate the zoom ring **1**. This adjusts the image size without affecting focus.

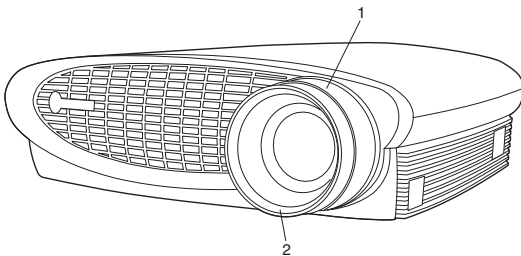

The projector is equipped with a self-locking, quick-release elevator foot and button. To raise the projector:

1. Press and hold the elevator button **1** (see the following illustration).

2. Raise the projector to the height that you want, and then release the button to lock the elevator foot **2** into position.

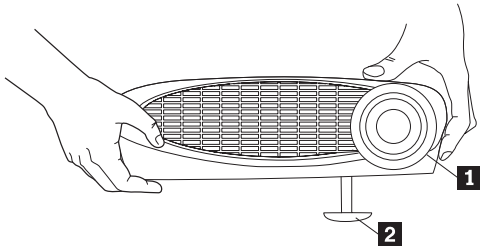

3. If necessary, turn the leveling knob to adjust the angle of the projected image as shown.

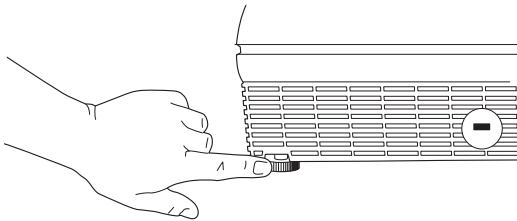

Using the keypad and remote control buttons

While the menus are displayed, the volume, source, and standby buttons on the keypad act as menu navigation buttons. See “Using the on-screen menus” on page 1-15.

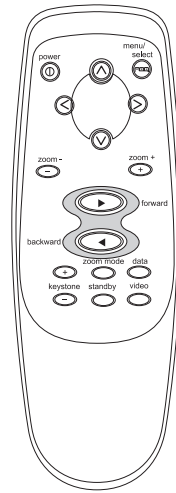

Lamp on/off (keypad only)

Press the lamp on/off button to turn the lamp on or off. The Lamp LED indicates the state of the lamp. When the Lamp LED lights green, you can turn the lamp on, or the lamp is currently on. An orange LED indicates the software is initializing or the lamp is cooling. Do not press the lamp on/off button when the LED is orange.

Menu

Press the menu button to open the on-screen menus. Press menu again to close the menus. When you close the menus, the projector saves any changes that you made. For more information about the on-screen menus, see “Using the on-screen menus” on page 1-15.

Source (keypad only) or computer and video (remote control only)

When you have more than one source (computer and video) connected to the projector, select between them by pressing the source button on the keypad or the computer or video button on the remote control.

Standby

When you press the standby button, the display and audio turn off and a blank screen is displayed for 15 minutes. You can change the amount of time the projector stays in standby mode; see “Standby time” on page 1-22 for details.

- If you press the standby button again within 15 minutes, the projector returns to operation immediately.
- If you press standby again after 15 minutes, there is approximately a 60-second delay before the lamp turns back on.
- If you do not press standby again, the lamp turns off after 15 minutes.

Volume (keypad only)

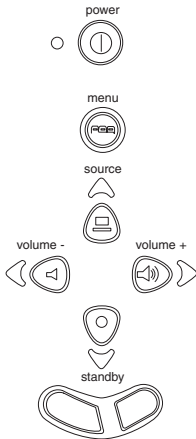

To increase the volume, press the volume + button. To decrease the volume, press the volume - button.

Volume adjustments are saved for each source that you have connected.

Using the on-screen menus

The projector has six drop-down menus that you can use to make image adjustments and change a variety of settings. Most of these adjustments are not available directly from the keypad.

Note: Some menu items might be unavailable at certain times. This indicates that the item is not applicable to your setup (for example, video standards do not apply to computer sources) or the item is not enabled

until another selection is made (for example, Manual Tracking is not available until Auto Image is turned off).

To open the on-screen menus, press the menu button on the keypad or remote control. This changes the volume, source, and standby buttons on the keypad to menu navigation buttons **1** (see following illustration). Press the buttons to move the cursor up, down, left, or right, or use the disk mouse on the remote control. To select a menu, move the cursor left or right to highlight the menu that you want. The drop-down menu is displayed.

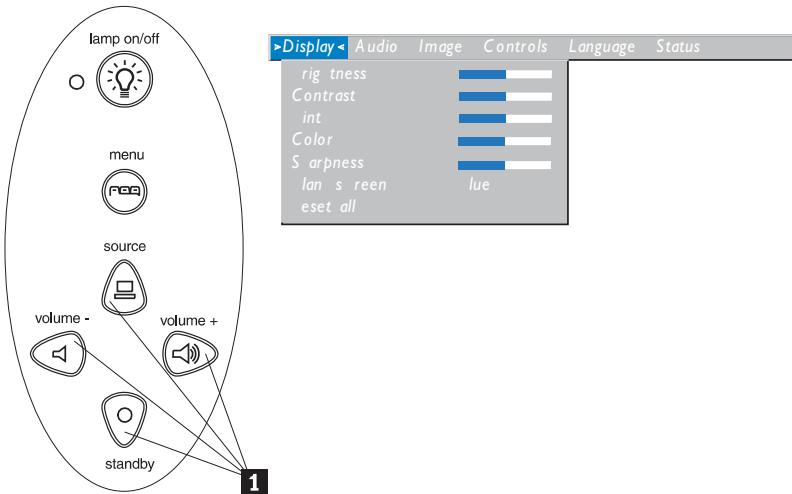

To change a menu setting, use the source (up) and standby (down) navigation buttons on the keypad or the disk mouse on the remote control to move the cursor up and down to the item that you want to change (the selected item is highlighted), and then use the volume - (left) and volume + (right) navigation buttons to adjust a setting. Some submenus, such as the Brightness menu, consist of a slider bar that you use to increase or decrease a value; some submenus, such as Standby Time menu, consist of options that you scroll through to select the one that you want. All changes are saved when you close the menus. To access another menu, use the up and down navigation buttons or the disk mouse to move back to the top of the current menu, then use the left and right navigation buttons to move to another menu.

Display menu

The following settings allow you to adjust the display.

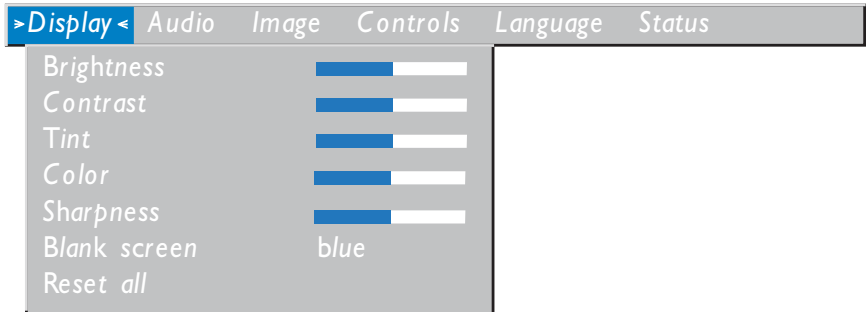

Brightness

Adjusting the brightness changes the intensity of the image.

- Press the left navigation button to darken the image.
- Press the right navigation button to lighten the image.

Contrast

The contrast controls the degree of difference between the lightest and darkest parts of the picture. Adjusting the contrast changes the amount of black and white in the image.

- Press the left navigation button to decrease the contrast.
- Press the right navigation button to increase the contrast, making the black areas appear blacker and the white areas appear whiter.

Tint

The tint adjusts the red-green color balance in the projected image. Changing the Tint setting has no effect on PAL or SECAM video sources.

- Press the left navigation button to increase the amount of green in the image.
- Press the right navigation button to increase the amount of red in the image.

Color

The color setting adjusts a video image from black and white to fully saturated color.

- Press the left navigation button to decrease the amount of color in the image.

- Press the right navigation button to increase the amount of color in the image.

Sharpness

This setting adjusts the sharpness of a video image.

- Press the left navigation button to decrease the sharpness.
- Press the right navigation button to increase the sharpness.

Blank screen

The **Blank screen** setting determines what color is displayed when there is no active source and when the projector is in standby. Click the left or right navigation button to change between blue and black.

Reset all

Click the left or right navigation button to reset all the options (except Language, Video Standard, Rear Projection, and Standby Time) in all the menus to their original settings.

Audio menu

The following setting allows you to adjust the audio.



Volume

Note: Changing the volume using the menu is the same as changing it using the keypad.

- Press the left navigation button to decrease the volume.
- Press the right navigation button to increase the volume.

Volume adjustments that you make are saved for each source.

Image menu: The following setting allows you to adjust the image.

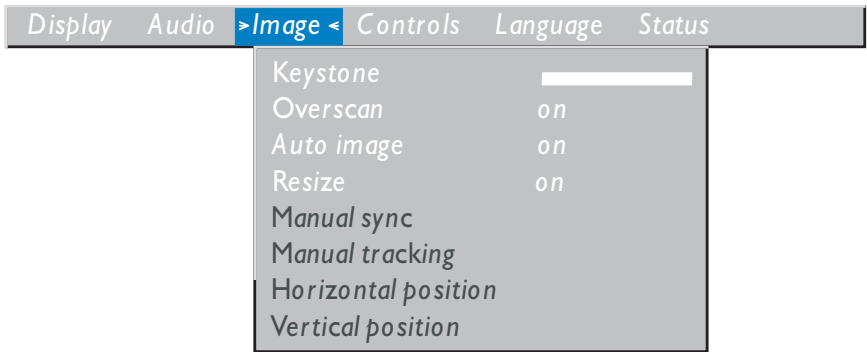

Keystone

Use this option to keep the image square as the angle of projection is changed. To adjust the keystone, highlight **Keystone**, and then click the right navigation button. This option is available for computer sources only in XGA 1024 x 768 resolution only.

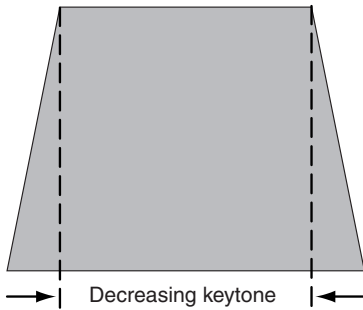
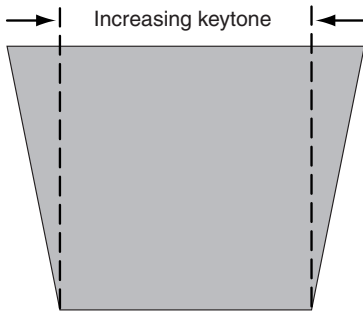

Overscan

Use this to crop all the edges of the image to remove noise that is generated on the edges by your source. This option is available for video sources only.

Note: Some screen savers interfere with the operation of Auto Image. If you are experiencing problems, try turning your screen saver off, and then turning Auto Image off and on again.

Auto Image

The projector automatically adjusts tracking, signal synchronization, and vertical and horizontal position for most computers (Auto Image does not apply to video sources). If you want to adjust these features manually, you must turn off AutoImage first by highlighting **Auto Image** in the Image menu and clicking the left or right navigation button to select **off**.

Resize

This option works differently for computer and video sources. For computer sources, the **Resize** option automatically resizes the image by scaling it up or down. It affects computer images that are not in the projector native resolution. When **Resize** option is on, the projector makes the best fit of the image to the computer screen. If you turn the **Resize** option off (by highlighting it in the Image menu and clicking the left or right navigation button to select **off**), the image might be either cropped or too small for the screen. For video sources, you can use the **Resize** option to select from among four different re-sizing options. The default is **Standard**, which resizes the image from its original version to fit a standard 4 x 3 aspect ratio screen. **Widescreen Letterbox** preserves the 16 x 9 aspect ratio of the original theater version, but the image is placed in a 4 x 3 space, so black bars are displayed at the top and bottom of the image. **Enhanced Widescreen** also preserves the aspect ratio of the original theater version and is designed to be used with content that is enhanced for wide-screen TVs. This option yields more detail than **Widescreen Letterbox**. **Native** reduces the **Standard** size to match the height of **Enhanced Widescreen**.

Manual sync

The projector adjusts signal synchronization automatically for most computers. But if the projected computer image looks fuzzy or streaked, try turning **Auto Image** off and then on again. If the image still looks bad, try adjusting the signal synchronization manually:

1. Turn **Auto Image** off.
2. Highlight **Manual sync**, and then press the left or right navigation button repeatedly until the image is sharp and free of streaks.

Manual tracking

The projector adjusts tracking automatically to match the video signal from your computer. However, if the image has evenly spaced, fuzzy, vertical lines or if the projected image is too wide or too narrow for the screen, try turning **Auto Image** off and on again. If the image is still bad, try adjusting the tracking manually:

Note: The **Manual sync**, **Manual tracking**, **Horizontal position** and **Vertical position** options are available only for computer sources. The projector sets these options automatically for video sources.

1. Turn **Auto Image** off.
2. Highlight **Manual tracking**, and then press the left or right navigation button repeatedly until the fuzzy vertical bars are gone.

Horizontal position

Follow these steps to manually adjust the horizontal position:

1. Turn **Auto Image** off.
2. Highlight **Horizontal position**, and then press the left navigation button to move the image right, or press the right navigation button to move the image left.

Vertical position

Follow these steps to manually adjust the vertical position:

1. Turn **Auto Image** off.
2. Highlight **Vertical position**, and then press the left navigation button to move the image down, or press the right navigation button to move the image up.

Positioning adjustments are saved when you turn off the projector.

Controls menu

The following settings allow you to adjust the controls.

Display	Audio	Image	> Controls <	Language	Status	
Video standard						
Standby time						1 minute
Rear projection						off
Default source						computer
Auto source select						off
Plug and Play						off
Display messages						on
Display startup screen						on

Video standard

When **Video standard** is set to **Auto**, the projector attempts to select the video standard (NTSC, NTSC 4.43, PAL, PAL-M, PAL-N, PAL-60, or SECAM) automatically based on the input signal that it receives. (The video standard options might vary depending on your region of the world.) The input signal for SECAM video is similar to other video signals and cannot be automatically detected; therefore, SECAM must be selected manually. If the projector is unable to detect the correct standard, the colors might not be displayed correctly or the image might appear broken. If this happens, manually select a standard by clicking the left or right navigation button and cycling through the standards.

Note: If you already know the video standard that is used in your geographical area, it is often best to manually select it.

Standby time

Use this option to select how long the lamp stays on and the blank screen is displayed when the projector enters standby mode before the projector turns off. Select among instant, 1, 5, 10, 15, and 30 minutes, and 1 and 2 hours by clicking the left or right navigation button and cycling through the options.

Rear projection

When you turn **Rear Projection** on, the projector reverses the image so that you can project from behind a translucent screen. Highlight **Rear Projection**, and then click the left or right navigation button to turn this feature on and off.

Default source

Use the **Default source** option to select among **Computer analog**, **Computer digital**, and **Video**. This determines which source the projector checks first for active video during power-on. Highlight **Default source**, and click the left or right navigation button to select among the options.

Auto source select

Use this setting to select between **On** and **Off**. When this feature is off, the projector defaults to the source that is selected in **Default source**. To display another source, you must manually select one by pressing the source button on the keypad or the computer or video button on the remote control. When this feature is on, the projector automatically finds the active source, checking the default source first. Highlight **Auto source select** and click the left or right navigation button to turn this feature on and off.

Plug and Play

Use this setting to select between **On** and **Off**. When it is on, most new computers will automatically recognize the projector and then set the monitor resolution and refresh rate accordingly. You need to set the **Plug and Play** setting to **Off** for the projector to properly display images from some older computers. The **Plug and Play** setting does not affect video images.

If the projector display constantly changes between the computer image and the message, “Perfecting the image,” you might need to turn **Plug and Play** off.

Display messages

Use this setting to select between **On** and **Off**. When this feature is on, status messages such as “No signal detected” or “Standby Active” are displayed in the lower-right corner of the screen. Click the left or right navigation button to turn this feature off and suppress status messages.

Display startup screen

Use this setting to select between **On** and **Off**. When this feature is on, the startup screen is displayed when the projector starts, and remains until an active source is detected. The startup screen contains projector support contact information. Click the left or right navigation button to turn this feature off and display a plain black or blue screen instead of the startup screen.

Language menu

The following settings allow you to adjust the language.



You can display the on-screen menus in English, French, German, Spanish, Chinese, or Japanese. Move the cursor to the language that you want and then click the left or right navigation button. The menus are redisplayed.

Status menu

This is a read-only window for informational purposes.

To display the status window, click **Show status** from the menu, and then click the left or right navigation button. To close the window, click the left or right navigation button.

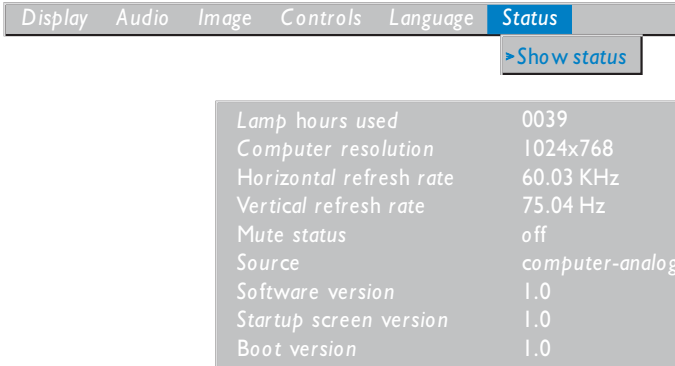

Lamp hours used

This shows how many hours the current lamp has been in use. The counter starts at zero hours and counts each hour the lamp is in use. Change the bulb when the brightness is no longer acceptable. See “Replacing the projection lamp” on page 1-26 for details.

Computer resolution

This shows your computer resolution setting. To change this, go to your computer Control Panel and adjust the resolution in the **Display** tab. See your computer documentation for details.

Horizontal refresh rate

This shows the time period that one horizontal line is displayed.

Vertical refresh rate

The time period that one video frame is displayed.

Mute status

This shows whether the audio is muted.

Source

This indicates the active source, (Computer analog, Computer digital, or Video).

Software version

This indicates the projector software version. This information is useful when you need to call an IBM technical support representative.

Startup screen version

This indicates the projector startup screen version. This information is useful when you need to call an IBM technical support representative.

Boot version

This indicates the projector startup software version. This information is useful when you need to call an IBM technical support representative.

Maintenance and troubleshooting

This section describes how to:

- Clean the lens
- Replace the projection lamp
- Replace the batteries in the remote
- Use the security lock feature
- Troubleshoot the projector

Cleaning the lens

Follow these steps to clean the projection lens:

1. Apply a non-abrasive camera lens cleaner to a soft, dry cloth.
 - Avoid using an excessive amount of cleaner.

- Abrasive cleaners, solvents or other harsh chemicals might scratch the lens.
2. Lightly wipe the cleaning cloth over the lens in a circular motion.
 3. If you do not intend to use the projector immediately, replace the lens cap.



CAUTION:

The following label indicates a hot surface nearby.



Replacing the projection lamp

WARNING:

To avoid burns, allow the projector to cool for at least 30 minutes before you open the lamp-module door. Never remove the lamp module while the lamp is operating.

The lamp-hour counter in the Status menu counts the number of hours the lamp has been in use. After 1980 hours of use, the message "Change Lamp" temporarily appears on the screen when the projector is turned on. Change the lamp within 20 hours. After 2000 hours, the LED flashes orange and the lamp will not light. Replace the lamp when the brightness is no longer acceptable. You can order new lamp modules from your dealer. See Appendix A for more details.

Follow these steps to replace the projection lamp:

1. Turn off the projector by unplugging the power cord.
2. Wait 30 minutes to allow the projector to cool thoroughly.
3. Invert the projector on a soft, flat surface, and then insert a small screwdriver or other flat object into the tab on the lamp-module door.

4. Pull the lamp-module door up and remove it as shown.

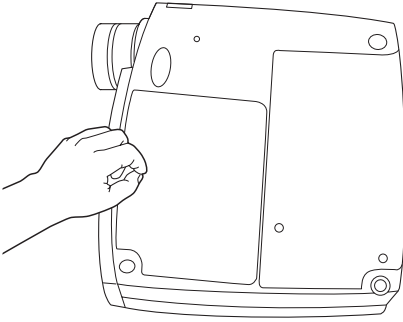

WARNING:

Be extremely careful when removing the lamp module. In the unlikely event that the bulb ruptures, small glass fragments might be generated. The lamp module is designed to contain these fragments, but use caution when removing the lamp module.

Attention: This product contains a Metal Arc Lamp which contains Mercury. Dispose of it as required by local ordinances and regulations.

5. Loosen the two nonremovable screws on the outside of the module.

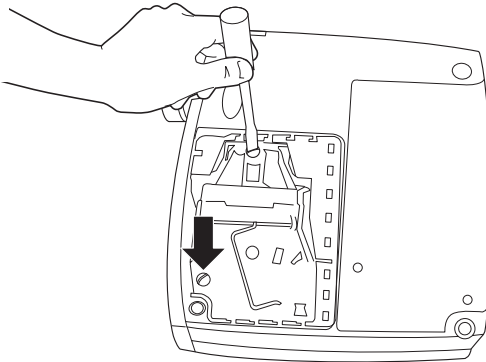

WARNING:

Never operate with the lamp door open or removed. This disrupts the air flow and causes the projector to overheat.

6. Grasp and lift the pull tab and lift the module out. Dispose of the lamp module in an environmentally proper manner.

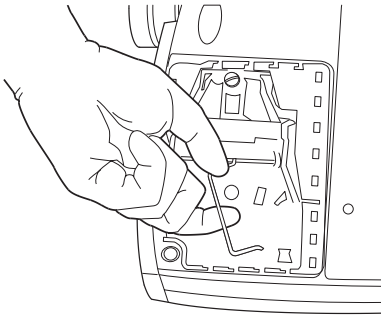

WARNING:

Do not drop the lamp module or touch the glass bulb. The glass might shatter and cause injury.

7. Install the new lamp module, being sure to align the connectors properly.
8. Push the module in until it is flush with the bottom case of the projector.
9. Tighten the screws on the outside of the module.
10. Replace the lamp-module door by inserting the hooks on the rear of the lamp-module door into the projector and pressing the lamp-module door into place. If the lamp-module door does not fit properly or bulges out, remove the door and reseal the lamp module.
11. Plug in the power cord to turn the projector back on.
12. To reset the lamp-hour counter in the Status window, press and hold the volume - button, then press the menu button (while still holding down the volume - button) for 5 seconds. Verify that the counter was reset by pressing the menu button and viewing the counter in the Status window.

Replacing the batteries in the remote control

The life of the batteries depends on how often and how long you use the remote control. Symptoms of low battery charge include erratic responses when you use the remote control and a reduced range of operation.

Follow these steps to replace the batteries:

1. Turn the remote control face down in your hand.
2. Slide the battery cover off the end of the remote control.
3. Remove the old batteries and dispose of them in an environmentally proper manner.

4. Install two new AAA alkaline batteries. Make sure that you install each in the correct direction.
5. Slide the battery cover back on to the remote control.

Using the security lock

The projector has a security connector for use with a computer lock system. Go to <http://www.compu-lock.com> for ordering information. Refer to the information that comes with the lock for instructions on how to secure it to the projector.

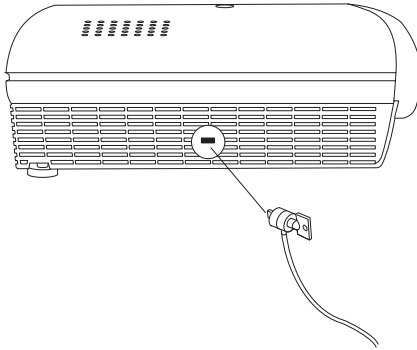

Troubleshooting

Problem: There is nothing on the projection screen.

- Make sure that the power cord is properly connected to a fully functional ac electrical outlet. Make sure that the power cord is also properly connected to the projector.
- If the projector is plugged into a power strip, make sure that the power strip is turned on.
- Make sure that you have removed the lens cap on the projection lens at the front of the projector.
- Make sure that the lamp is turned on.
- Check the projector lamp to ensure that it is securely connected in the lamp module. See “Replacing the projection lamp” on page 1-26.
- Make sure that the cables do not have any bent pins.

Problem: The color or text not being projected.

- You might need to adjust the brightness up or down until the text is visible. See “Brightness” on page 1-17 for more information.

Problem: The screen resolution is not correct.

- Make sure that the computer video adapter is set for a resolution of no greater than 1280 x 1024.

Problem: The image is not centered on the screen.

- Move the projector to reposition the image.
- Reposition the image using the software. See “Horizontal position” and “Vertical position” on page 1-21.
- Be sure that the projector is at a 90-degree angle to the screen.

Problem: Only the start-up screen is displayed.

- Verify that the cables are connected correctly.
- Verify that the proper input source is connected. See “Source (keypad only) or computer and video (remote control only)” on page 1-15.
- Turn off all the equipment and turn on the equipment again in the proper order. Refer to your computer documentation to determine the correct order.
- Make sure that your mobile computer’s external video port is turned on. See “Portable and mobile computer activation” in Appendix B. or your computer manual for details.
- Make sure that your computer video board is installed and configured correctly.
- Make sure that your computer has a compatible video board. The projector is not CGA, EGA, or SXGA compatible.

If you are using Windows 98:

1. From the desktop, double-click **My Computer**, double-click **Control Panel**, and double-click **Display**.
2. Click the **Settings** tab.
3. Verify that the desktop area is set to 1280 x 1024 or less.

Problem: The image is too wide or narrow for the screen.

- Adjust the zoom or the projector placement.
- Adjust the resolution of your video adapter if it’s greater than 1280 x 1024.

Problem: The image is out of focus.

- Turn the projection lens to focus the image.
- Make sure that the projection screen is at least 5 feet (1.5 m) from the projector.
- Check the projection lens to see if it needs cleaning.

Problem: The image and menus are reversed left to right.

- Rear projection mode is probably turned on. Turn off Rear Projection in the Controls menu. The image immediately returns to forward projection. See “Rear projection” on page 1-22.

Problem: The projector displays vertical lines, “bleeding,” or spots.

- Adjust the brightness. See “Brightness” on page 1-17.
- Check the projection lens to see if it needs cleaning.

Problem: There is no sound.

- Adjust the volume.
- Verify the audio/input connections.
- Adjust the audio source.

Problem: The image is “noisy” or streaked.

Try these steps in this order:

1. Deactivate the screen saver on your computer.
2. Turn **Auto Image** off, and then on again. See “Auto image” on page 1-20.
3. Turn **Auto Image** off, and adjust the synchronization and tracking manually to find an optimal setting. See “Manual sync” and “Manual tracking” on page 1-20.
 - The problem might be with your computer video adapter. If possible, connect the projector to a different computer.

Problem: The projected colors do not match the computer or video player colors.

- Just as there are differences in the displays of different monitors, there are often differences between the computer image and the projected image. Adjust the brightness, tint, or contrast from the Display menu. See “Brightness,” “Tint,” and “Contrast” on page 1-17.

Problem: The lamp seems to be getting dimmer.

- The lamp begins to lose brightness when it has been in use for a long time. Replace the lamp as described in “Replacing the projection lamp” on page 1-26.

Problem: The lamp shuts off.

- A minor power surge might cause the lamp to shut off. Unplug the projector, wait at least one minute, and then plug it back in.
- Make sure that the vents are not blocked.
- Make sure the lamp has not been in use for over 2000 hours. The lamp automatically shuts off after 2000 hours. See “Replacing the projection lamp” on page 27.

Appendix A. Product specifications and accessories

This section contains information on the product specifications and information for ordering accessories.

Specifications

The projector must be operated and stored within the temperature and humidity ranges specified.

Temperature

Operating	10 to 40° C (50 to 104° F)
Non-operating	-20 to 70° C (-4 to 158°F)

Humidity

Operating and non-operating.	10% to 95% relative humidity, non-condensing
------------------------------	--

Dimensions

26 x 8.5 x 28 cm (10.25 x 3.34 x 11 in.)

Weight

2.6 kg (5.7 lbs.) unpacked

Altitude

Operating	0 to 3048 meters (10000 feet)
Non-operating	0 to 6090 meters (20,000 feet)

Optics

Focus range	1.5 to 5 m (4.9 to 16 feet)
-------------	-----------------------------

Lamp

Type	270-watt VHP lamp
------	-------------------

Input power requirements

100-120 V ac, 5A; 50/60Hz
200-240 V ac 3A; 50Hz

Accessories

There are many accessories available for your new projector and new ones being added frequently. Please refer to <http://www.infocus.com/> and select from the many accessories listed there for purchase.

Appendix B. Portable and mobile computer activation

Many mobile computers do not automatically turn on their external video port when a projector is connected. Activation commands for some mobile computers are listed in the following table. (If your computer is not listed or the given command does not work, refer to the computer documentation for the appropriate command.) On many mobile computers, the activation function key is labeled with an icon such as that in the following illustration.



Note: Visit <http://www.infocus.com/> for the most current activation chart. It is located in the Service and Support link.

Note: Usually, pressing the key commands once activates the external video port, pressing it again activates both external and internal ports, and pressing it a third time activates the internal port. Refer to your computer's documentation for details on your specific model.

Computer	Key command to activate port	Key command to deactivate port
Acer	Ctrl+Alt+Esc (for setup)	Ctrl+Alt+Esc (for setup)
AST* **	FN+D or Ctrl+D Ctrl+FN+D FN+F5 type from A:\IVGA\CRT FN+F12	FN+D or Ctrl+D Ctrl+FN+D FN+F5 type from A:\IVGACRT FN+F12
AMS	FN+F2	FN+F2
AMT	setup screen	setup screen
AT&T	FN+F3 FN+F6	FN+F3 F+-F6
Advanced Logic Research	Ctrl+Alt+V	Ctrl+Alt+V
Altima	Shift-Ctrl-Alt-C setup VGA/Conf.Simulscan	Shift-Ctrl-Alt-L setup VGA/Conf.Simulscan
Ambra**	FN-F12 FN-F5 F2/Choose Option/F5	FN-F12 FN-F5 F2/Choose Option/F5
Amrel* **	setup menu Shift-Ctrl-D	setup menu Shift-Ctrl-D
Apple	see Mac Portable and Mac PowerBook	

Computer	Key command to activate port	Key command to deactivate port
Aspen	automatic	automatic
Award	FN-F6	FN-F6
BCC*	automatic	reboot computer
Bondwell	LCD or CRT options after bootup	reboot for LCD or CRT options to appear
Chaplet**	setup screen FN-F6 FN-F4	setup screen FN-F6 FN-F4
Chembook	FN-F6	FN-F6
Commax	Ctrl-Alt-#6	Ctrl-Alt-#5
Compaq* **	Ctrl-Alt-< FN-F4 automatic mode/? (for setup option)	Ctrl-Alt-> FN-F4 automatic mode/? (for setup option)
Compuadd* **	automatic Alt-F for screen setup option	automatic Alt-F for screen setup option
Data General	Ctrl-Alt-Command	Ctrl-Alt-Command
Data General Walkabout	2 CRT/X at DOS prompt	restart
Datavue	Ctrl-Shift-M	Ctrl-Shift-M
DEC**	FN-F5 FN-F4	FN-F5 FN-F4
Dell**	Ctrl-Alt-< Ctrl-Alt-F10 FN-F8 (CRT/LCD) FN-D FN-F12	Ctrl-Alt-> Ctrl-Alt-F10 FN-F8 FN-D FN-F12
Digital*	automatic FN-F2	reboot FN-F2
Dolch	dip switch to CRT	dip switch to LCD
Epson	dip switch to CRT	dip switch to LCD
Everex*	setup screen option	setup screen option
For-A	Ctrl-Alt-Shift-C	Ctrl-Shift-Alt-L
Fujitsu	FN-F10	

Computer	Key command to activate port	Key command to deactivate port
Gateway	FN-F3 FN-F1/FN-F1 again simultaneous	FN-F3 FN-F1
Grid* **	FN-F2, select auto or simultaneous Ctrl-Alt-Tab	FN-F2 Ctrl-Alt-Tab
Hitachi	FN-F7	FN-F7
Honeywell	FN-F10	FN-F10
Hyundai	setup screen option	setup screen option
IBM 970*	automatic	warm restart
IBM ThinkPad**	reboot, enter setup menu FN-F7, select choice from setup menu FN-F1, select choice FN-F5, select choice PS/2 SC select choice (such as CRT, LCD)	FN-F2
Infotel	FN-F12	FN-F12
Kaypro	start up, monitor plugged in	unplug monitor
Kris Tech	FN-F8	FN-F8
Leading Edge	FN-T	FN-T
Mac Portable 100	no video port; not compatible	
Mac PowerBook 140, 145, 150, 170 160, 165, 180, 520, 540, 5300 210, 230, 250, 270, 280, 2300	no video port; requires a third-party interface Control Panel folder, PowerBook Display folder; Activate Video Mirroring requires Apple Docking Station or Mini Dock	warm restart
Magitronic	FN-F4	FN-F4
Mastersport	FN-F2	FN-F1
Micro Express*	automatic	warm restart
Micron	FN-F2	FN-F2
Microslate*	automatic	warm restart
Mitsubishi	SW2 On-Off-Off-Off	SW2 Off-On-On-On

Computer	Key command to activate port	Key command to deactivate port
NCR	setup screen option	setup screen option
NEC* **	setup screen option CRT at the DOS prompt FN-F3	setup screen option LCD at the DOS prompt FN-F3
Olivetti*	automatic FN-O/*	automatic FN-O/*
Packard Bell* **	FN-F0 Ctrl-Alt-<	FN-F0 Ctrl-Alt->
Panasonic	FN-F2	FN-F2
Prostar	Ctrl-Alt-S at startup	Ctrl-Alt-S at startup
Samsung*	setup screen option	setup screen option
Sanyo	setup screen option	setup screen option
Sharp	dip switch to CRT	dip switch to LCD
Sun SPARC-Dataview	Ctrl-Shift-M	Ctrl-Shift-M
Tandy**	Ctrl-Alt-Insert setup screen option	Ctrl-Alt-Insert setup screen option
Tangent	FN-F5	FN-F5
Texas Instruments*	setup screen option	setup screen option
Top-Link* **	setup screen option FN-F6	setup screen option FN-F6
Toshiba* **	Ctrl-Alt-End FN-End FN-F5 setup screen option	Ctrl-Alt-Home FN-Home FN-F5 setup screen option
Twinhead*	FN-F7 FN-F5 automatic	FN-F7 FN-F5 automatic
WinBook	Ctrl-Alt-F10	Ctrl-Alt-F10
Wyse	software driven	software driven
Zenith**	FN-F10 FN-F2 FN-F1	FN-F10 FN-F2 FN-F1

Computer	Key command to activate port	Key command to deactivate port
Zeos **	Ctrl-Shift-D FN-F1	Ctrl-Shift-D FN-F1

* These manufacturers have models that automatically send video to the external video port when some type of display device is attached.

** These manufacturers offer more than one key command depending on the computer model.

Appendix C. Using video mirroring

This section contains information on video mirroring.

Using video mirroring with a PowerBook computer

When you turn on video mirroring (called SimulScan in newer PowerBook computers), the projector displays the same information that appears on a PowerBook built-in screen. When video mirroring is off, the projector operates like a separate display.

To turn on video mirroring for the first time:

1. Open the Monitors control panel; click **Monitor 2**.
2. Set the number of colors that you want.
3. Open the Control Strip, and then click the monitor icon.
4. Select **Turn Video Mirroring On**.

Now you can turn video mirroring on and off from the Control Strip without having to open the monitor control panel again. When using video mirroring and high-color graphics such as slide shows, the projected image occasionally might turn black and white. If this happens, perform the following steps:

1. Turn off video mirroring.
2. Open the monitor control panel.
3. Move the white menu bar to **Monitor 2** to set the projector as the primary monitor.
4. Restart the PowerBook computer.

Using Simulscan

Some newer PowerBook computers display images on an external monitor or projector differently than previous ones. When using SimulScan, the projector displays the same information that appears on your PowerBook computer. To select SimulScan:

1. Open the Control Panel, and then double-click **Monitors** and **Sound**.
2. In the Resolution list, select the SimulScan mode, and then click **OK**.
3. If this changes your display settings, a window opens. Click **OK** to confirm the change.

Appendix D. Projected image size

Use the following graph and tables to help you determine projected image sizes.

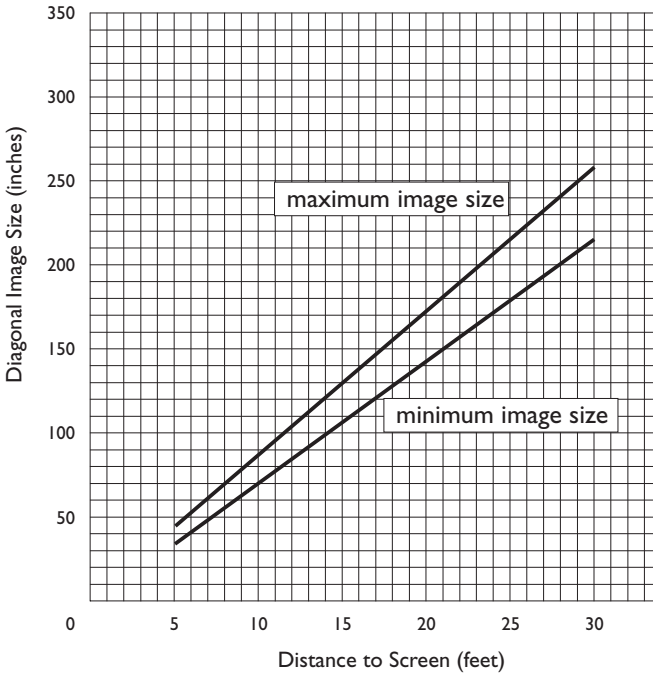

Distance to Screen (feet)	Diagonal (feet)	Width (feet)	Height (feet)
4.9	3.0	2.4	1.8
8	5.0	4.0	3.0
12	7.4	6.0	4.5
16	9.9	7.9	6.0
20	12.4	9.9	7.4
30	18.6	14.9	11.2

Distance to Screen (feet)	Diagonal (feet)	Width (feet)	Height (feet)
4.9	2.5	2.0	1.5
8	4.0	3.2	2.4

Distance to Screen (feet)	Diagonal (feet)	Width (feet)	Height (feet)
12	6.0	4.8	3.6
16	8.0	6.4	4.8
20	10.0	8.0	6.0
30	15.0	12.0	9.0

Appendix E. Product Warranty

This section contains the warranty period for your product, information about obtaining warranty service and support, and the IBM Statement of Limited Warranty.

Warranty Period

Contact your place of purchase for warranty service information. Some IBM Machines are eligible for on-site warranty service depending on the country or region where service is performed.

Machine - iLV200/iLC200 IBM Data/Video Projector

Warranty period - One year

The following information describes the technical support that is available for your product, during the warranty period or throughout the life of the product. Refer to your IBM Statement of Limited Warranty for a full explanation of IBM warranty terms.

Service and support

The following information describes the technical support that is available for your product, during the warranty period or throughout the life of the product. Refer to your IBM Statement of Limited Warranty for a full explanation of IBM warranty terms.

Warranty information on the World Wide Web

The IBM Machine Warranties Web site at http://www.ibm.com/servers/support/machine_warranties/ contains a worldwide overview of the IBM Limited Warranty for IBM Machines, a glossary of terms used in the Statement of Limited Warranty, Frequently Asked Questions (FAQ), and links to Product Support Web pages. The IBM Statement of Limited Warranty is available from this Web site in 29 languages in Portable Document Format (PDF).

Online technical support

Online technical support is available during the life of your product. Online assistance can be obtained through the Personal Computing Support Web site and the IBM Automated Fax System.

Online technical support

IBM Personal Computing Support Web site	http://www.ibm.com/pc/support/
IBM Automated Fax System	1-800-426-3395 (U.S. and Canada)

During the warranty period, assistance for replacement or exchange of defective components is available. In addition, if your IBM option is installed in an IBM computer, you might be entitled to service at your location. Your technical support representative can help you determine the best alternative.

Telephone technical support

Installation and configuration support through the IBM HelpCenter® will be withdrawn or made available for a fee, at IBM's discretion, 90 days after the option has been withdrawn from marketing. Additional support offerings, including step-by-step installation assistance, are available for a nominal fee.

To assist the technical support representative, have available as much of the following information as possible:

- Option name
- Option number
- Proof of purchase
- Computer manufacturer, model, serial number (if IBM), and manual
- Exact wording of the error message (if any)
- Description of the problem
- Hardware and software configuration information for your system

If possible, be at your computer. Your technical support representative might want to walk you through the problem during the call.

For the support telephone number and support hours by country, refer to the following table. If the number for your country or region is not listed, contact your IBM reseller or IBM marketing representative. Response time may vary depending on the number and nature of the calls received.

Support 24 hours a day, 7 days a week	
Canada (Toronto only)	416-383-3344
Canada (all other)	1-800-565-3344
U.S.A. and Puerto Rico	1-800-772-2227
All other countries and regions	Go to http://www.ibm.com/pc/support/ , and click Support Phone List .

IBM Statement of Limited Warranty Z125-4753-06 8/2000

his warranty statement consists of two parts: Part 1 and Part 2. Be sure to read Part 1 and the country-unique terms in Part 2 that apply to your country or region.

Warranty information

This section contains the warranty period for your product, information about obtaining warranty service and support, and the IBM Statement of Limited Warranty.

Warranty period

Contact your place of purchase for warranty service information. Some IBM Machines are eligible for on-site warranty service depending on the country or region where service is performed.

Machine - iLV200/iLC200 IBM Data/Video Projector

Warranty period - One year

The following information describes the technical support that is available for your product, during the warranty period or throughout the life of the product. Refer to your IBM Statement of Limited Warranty for a full explanation of IBM warranty terms.

Service and support

The following information describes the technical support that is available for your product, during the warranty period or throughout the life of the product. Refer to your IBM Statement of Limited Warranty for a full explanation of IBM warranty terms.

Warranty information on the World Wide Web

The IBM Machine Warranties Web site at http://www.ibm.com/servers/support/machine_warranties/ contains a worldwide overview of the IBM Limited Warranty for IBM Machines, a glossary of terms used in the Statement of Limited Warranty, Frequently Asked Questions (FAQ), and links to Product Support Web pages. The IBM Statement of Limited Warranty is available from this Web site in 29 languages in Portable Document Format (PDF).

Online technical support

Online technical support is available during the life of your product. Online assistance can be obtained through the Personal Computing Support Web site and the IBM Automated Fax System.

Online technical support	
IBM Personal Computing Support Web site	http://www.ibm.com/pc/support/
IBM Automated Fax System	1-800-426-3395 (U.S. and Canada)

During the warranty period, assistance for replacement or exchange of defective components is available. In addition, if your IBM option is installed in an IBM computer, you might be entitled to service at your location. Your technical support representative can help you determine the best alternative.

Telephone technical support

Installation and configuration support through the IBM HelpCenter® will be withdrawn or made available for a fee, at IBM's discretion, 90 days after the option has been withdrawn from marketing. Additional support offerings, including step-by-step installation assistance, are available for a nominal fee.

To assist the technical support representative, have available as much of the following information as possible:

- Option name
- Option number
- Proof of purchase
- Computer manufacturer, model, serial number (if IBM), and manual
- Exact wording of the error message (if any)
- Description of the problem
- Hardware and software configuration information for your system

If possible, be at your computer. Your technical support representative might want to walk you through the problem during the call.

For the support telephone number and support hours by country, refer to the following table. If the number for your country or region is not listed, contact your IBM reseller or IBM marketing representative. Response time may vary depending on the number and nature of the calls received.

Support 24 hours a day, 7 days a week	
Canada (Toronto only)	416-383-3344
Canada (all other)	1-800-565-3344
U.S.A. and Puerto Rico	1-800-772-2227
All other countries and regions	Go to http://www.ibm.com/pc/support/ , and click Support Phone List .

IBM Statement of Limited Warranty Z125-4753-06 8/2000

This warranty statement consists of two parts: Part 1 and Part 2. Be sure to read Part 1 and the country-unique terms in Part 2 that apply to your country or region.

Part 1 - General Terms

This Statement of Limited Warranty includes Part 1 - General Terms and Part 2 - Country-unique Terms. The terms of Part 2 replace or modify those of Part 1. The warranties provided by IBM in this Statement of Limited Warranty apply only to Machines you purchase for your use, and not for resale, from IBM or your reseller. The term "Machine" means an IBM machine, its features, conversions, upgrades, elements, or accessories, or any combination of them. The term "Machine" does not include any software programs, whether pre-loaded with the Machine, installed subsequently or otherwise. Unless IBM specifies otherwise, the following warranties apply only in the country where you acquire the Machine. Nothing in this Statement of Limited Warranty affects any statutory rights of consumers that cannot be waived or limited by contract. If you have any questions, contact IBM or your reseller.

The IBM Warranty for Machines

IBM warrants that each Machine 1) is free from defects in materials and workmanship and 2) conforms to IBM's Official Published Specifications ("Specifications"). The warranty period for a Machine is a specified, fixed period commencing on its Date of Installation. The date on your sales receipt is the Date of Installation unless IBM or your reseller informs you otherwise.

If a Machine does not function as warranted during the warranty period, and IBM or your reseller are unable to either 1) make it do so or 2) replace it with one that is at least functionally equivalent, you may return it to your place of purchase and your money will be refunded.

Extent of Warranty

The warranty does not cover the repair or exchange of a Machine resulting from misuse, accident, modification, unsuitable physical or operating environment, improper maintenance by you, or failure caused by a product for which IBM is not responsible. The warranty is voided by removal or alteration of Machine or parts identification labels.

THESE WARRANTIES ARE YOUR EXCLUSIVE WARRANTIES AND REPLACE ALL OTHER WARRANTIES OR CONDITIONS, EXPRESS OR IMPLIED, INCLUDING, BUT NOT LIMITED TO, THE IMPLIED WARRANTIES OR CONDITIONS OF MERCHANTABILITY AND FITNESS FOR A PARTICULAR PURPOSE. THESE WARRANTIES GIVE YOU SPECIFIC LEGAL RIGHTS AND YOU MAY ALSO HAVE OTHER RIGHTS

WHICH VARY FROM JURISDICTION TO JURISDICTION. SOME JURISDICTIONS DO NOT ALLOW THE EXCLUSION OR LIMITATION OF EXPRESS OR IMPLIED WARRANTIES, SO THE ABOVE EXCLUSION OR LIMITATION MAY NOT APPLY TO YOU. IN THAT EVENT, SUCH WARRANTIES ARE LIMITED IN DURATION TO THE WARRANTY PERIOD. NO WARRANTIES APPLY AFTER THAT PERIOD.

Items Not Covered by Warranty

IBM does not warrant uninterrupted or error-free operation of a Machine.

Any technical or other support provided for a Machine under warranty, such as assistance via telephone with “how-to” questions and those regarding Machine set-up and installation, will be provided **WITHOUT WARRANTIES OF ANY KIND.**

Warranty Service

To obtain warranty service for a Machine, contact IBM or your reseller. If you do not register your Machine with IBM, you may be required to present proof of purchase.

During the warranty period, IBM or your reseller, if approved by IBM to provide warranty service, provides without charge certain types of repair and exchange service to keep Machines in, or restore them to, conformance with their Specifications. IBM or your reseller will inform you of the available types of service for a Machine based on its country of installation. At its discretion, IBM or your reseller will 1) either repair or exchange the failing Machine and 2) provide the service either at your location or a service center. IBM or your reseller will also manage and install selected engineering changes that apply to the Machine.

Some parts of IBM Machines are designated as Customer Replaceable Units (called “CRUs”), e.g., keyboards, memory, or hard disk drives. IBM ships CRUs to you for replacement by you. You must return all defective CRUs to IBM within 30 days of your receipt of the replacement CRU. You are responsible for downloading designated Machine Code and Licensed Internal Code updates from an IBM Internet Web site or from other electronic media, and following the instructions that IBM provides.

When warranty service involves the exchange of a Machine or part, the item IBM or your reseller replaces becomes its property and the replacement becomes yours. You represent that all removed items are genuine and unaltered. The replacement may not be new, but will be in good working order and at least functionally equivalent to the item replaced. The replacement assumes the warranty service status of the replaced item. Many features,

conversions, or upgrades involve the removal of parts and their return to IBM. A part that replaces a removed part will assume the warranty service status of the removed part.

Before IBM or your reseller exchanges a Machine or part, you agree to remove all features, parts, options, alterations, and attachments not under warranty service.

You also agree to

1. ensure that the Machine is free of any legal obligations or restrictions that prevent its exchange;
2. obtain authorization from the owner to have IBM or your reseller service a Machine that you do not own; and
3. where applicable, before service is provided:
 - a. follow the problem determination, problem analysis, and service request procedures that IBM or your reseller provides;
 - b. secure all programs, data, and funds contained in a Machine;
 - c. provide IBM or your reseller with sufficient, free, and safe access to your facilities to permit them to fulfill their obligations; and
 - d. inform IBM or your reseller of changes in a Machine's location.

IBM is responsible for loss of, or damage to, your Machine while it is 1) in IBM's possession or 2) in transit in those cases where IBM is responsible for the transportation charges.

Neither IBM nor your reseller is responsible for any of your confidential, proprietary or personal information contained in a Machine which you return to IBM or your reseller for any reason. You should remove all such information from the Machine prior to its return.

Limitation of Liability

Circumstances may arise where, because of a default on IBM's part or other liability, you are entitled to recover damages from IBM. In each such instance, regardless of the basis on which you are entitled to claim damages from IBM (including fundamental breach, negligence, misrepresentation, or other contract or tort claim), except for any liability that cannot be waived or limited by applicable laws, IBM is liable for no more than

1. damages for bodily injury (including death) and damage to real property and tangible personal property; and
2. the amount of any other actual direct damages, up to the charges (if recurring, 12 months' charges apply) for the Machine that is subject of the claim. For purposes of this item, the term "Machine" includes Machine Code and Licensed Internal Code.

This limit also applies to IBM's suppliers and your reseller. It is the maximum for which IBM, its suppliers, and your reseller are collectively responsible.

UNDER NO CIRCUMSTANCES IS IBM LIABLE FOR ANY OF THE FOLLOWING: 1) THIRD-PARTY CLAIMS AGAINST YOU FOR DAMAGES (OTHER THAN THOSE UNDER THE FIRST ITEM LISTED ABOVE); 2) LOSS OF, OR DAMAGE TO, YOUR RECORDS OR DATA; OR 3) SPECIAL, INCIDENTAL, OR INDIRECT DAMAGES OR FOR ANY ECONOMIC CONSEQUENTIAL DAMAGES, LOST PROFITS OR LOST SAVINGS, EVEN IF IBM, ITS SUPPLIERS OR YOUR RESELLER IS INFORMED OF THEIR POSSIBILITY. SOME JURISDICTIONS DO NOT ALLOW THE EXCLUSION OR LIMITATION OF INCIDENTAL OR CONSEQUENTIAL DAMAGES, SO THE ABOVE LIMITATION OR EXCLUSION MAY NOT APPLY TO YOU.

Governing Law

Both you and IBM consent to the application of the laws of the country in which you acquired the Machine to govern, interpret, and enforce all of your and IBM's rights, duties, and obligations arising from, or relating in any manner to, the subject matter of this Agreement, without regard to conflict of law principles.

Part 2 - Country-unique Terms

AMERICAS

BRAZIL

Governing Law: *The following is added after the first sentence:*

Any litigation arising from this Agreement will be settled exclusively by the court of Rio de Janeiro.

NORTH AMERICA

Warranty Service: *The following is added to this Section:*

To obtain warranty service from IBM in Canada or the United States, call 1-800-IBM-SERV (426-7378).

CANADA

Governing Law: *The following replaces "laws of the country in which you acquired the Machine" in the first sentence:*

laws in the Province of Ontario.

UNITED STATES

Governing Law:*The following replaces “laws of the country in which you acquired the Machine” in the first sentence:*
laws of the State of New York.

ASIA PACIFIC

AUSTRALIA

The IBM Warranty for Machines:*The following paragraph is added to this Section:*
The warranties specified in this Section are in addition to any rights you may have under the Trade Practices Act 1974 or other similar legislation and are only limited to the extent permitted by the applicable legislation.

Limitation of Liability: *The following is added to this Section:*
Where IBM is in breach of a condition or warranty implied by the Trade Practices Act 1974 or other similar legislation, IBM’s liability is limited to the repair or replacement of the goods or the supply of equivalent goods. Where that condition or warranty relates to right to sell, quiet possession or clear title, or the goods are of a kind ordinarily acquired for personal, domestic or household use or consumption, then none of the limitations in this paragraph apply.

Governing Law: *The following replaces “laws of the country in which you acquired the Machine” in the first sentence:*
laws of the State or Territory.

CAMBODIA, LAOS, AND VIETNAM

Governing Law: *The following replaces “laws of the country in which you acquired the Machine” in the first sentence:*
laws of the State of New York.

The following is added to this Section:

Disputes and differences arising out of or in connection with this Agreement shall be finally settled by arbitration which shall be held in Singapore in accordance with the rules of the International Chamber of Commerce (ICC). The arbitrator or arbitrators designated in conformity with those rules shall have the power to rule on their own competence and on the validity of the Agreement to submit to arbitration. The arbitration award shall be final and binding for the parties without appeal and the arbitral award shall be in writing and set forth the findings of fact and the conclusions of law.

All proceedings shall be conducted, including all documents presented in such proceedings, in the English language. The number of arbitrators shall be three, with each side to the dispute being entitled to appoint one arbitrator.

The two arbitrators appointed by the parties shall appoint a third arbitrator before proceeding upon the reference. The third arbitrator shall act as chairman of the proceedings. Vacancies in the post of chairman shall be filled by the president of the ICC. Other vacancies shall be filled by the respective nominating party. Proceedings shall continue from the stage they were at when the vacancy occurred.

If one of the parties refuses or otherwise fails to appoint an arbitrator within 30 days of the date the other party appoints its, the first appointed arbitrator shall be the sole arbitrator, provided that the arbitrator was validly and properly appointed.

The English language version of this Agreement prevails over any other language version.

HONG KONG AND MACAU

Governing Law: *The following replaces "laws of the country in which you acquired the Machine" in the first sentence:*

laws of Hong Kong Special Administrative Region.

INDIA

Limitation of Liability: *The following replaces items 1 and 2 of this Section:*

1. liability for bodily injury (including death) or damage to real property and tangible personal property will be limited to that caused by IBM's negligence;
2. as to any other actual damage arising in any situation involving nonperformance by IBM pursuant to, or in any way related to the subject of this Statement of Limited Warranty, IBM's liability will be limited to the charge paid by you for the individual Machine that is the subject of the claim.

JAPAN

Governing Law: *The following sentence is added to this Section:*

Any doubts concerning this Agreement will be initially resolved between us in good faith and in accordance with the principle of mutual trust.

NEW ZEALAND

The IBM Warranty for Machines: *The following paragraph is added to this Section:*

The warranties specified in this Section are in addition to any rights you may have under the Consumer Guarantees Act 1993 or other legislation which cannot be excluded or limited. The Consumer Guarantees Act 1993 will not

apply in respect of any goods which IBM provides, if you require the goods for the purposes of a business as defined in that Act.

Limitation of Liability: *The following is added to this Section:*

Where Machines are not acquired for the purposes of a business as defined in the Consumer Guarantees Act 1993, the limitations in this Section are subject to the limitations in that Act.

PEOPLE'S REPUBLIC OF CHINA (PRC)

Governing Law: *The following replaces this Section:*

Both you and IBM consent to the application of the laws of the State of New York (except when local law requires otherwise) to govern, interpret, and enforce all your and IBM's rights, duties, and obligations arising from, or relating in any manner to, the subject matter of this Agreement, without regard to conflict of law principles.

Any disputes arising from or in connection with this Agreement will first be resolved by friendly negotiations, failing which either of us has the right to submit the dispute to the China International Economic and Trade Arbitration Commission in Beijing, the PRC, for arbitration in accordance with its arbitration rules in force at the time. The arbitration tribunal will consist of three arbitrators. The language to be used therein will be English and Chinese. An arbitral award will be final and binding on all the parties, and will be enforceable under the Convention on the Recognition and Enforcement of Foreign Arbitral Awards (1958).

The arbitration fee will be borne by the losing party unless otherwise determined by the arbitral award.

During the course of arbitration, this Agreement will continue to be performed except for the part which the parties are disputing and which is undergoing arbitration.

EUROPE, MIDDLE EAST, AFRICA (EMEA)

THE FOLLOWING TERMS APPLY TO ALL EMEA COUNTRIES:

The terms of this Statement of Limited Warranty apply to Machines purchased from IBM or an IBM reseller.

Warranty Service:

If you purchase an IBM Machine in Austria, Belgium, Denmark, Estonia, Finland, France, Germany, Greece, Iceland, Ireland, Italy, Latvia, Lithuania, Luxembourg, Netherlands, Norway, Portugal, Spain, Sweden, Switzerland or United Kingdom, you may obtain warranty service for that Machine in any of

those countries from either (1) an IBM reseller approved to perform warranty service or (2) from IBM. If you purchase an IBM Personal Computer Machine in Albania, Armenia, Belarus, Bosnia and Herzegovina, Bulgaria, Croatia, Czech Republic, Georgia, Hungary, Kazakhstan, Kirghizia, Federal Republic of Yugoslavia, Former Yugoslav Republic of Macedonia (FYROM), Moldova, Poland, Romania, Russia, Slovak Republic, Slovenia, or Ukraine, you may obtain warranty service for that Machine in any of those countries from either (1) an IBM reseller approved to perform warranty service or (2) from IBM.

If you purchase an IBM Machine in a Middle Eastern or African country, you may obtain warranty service for that Machine from the IBM entity within the country of purchase, if that IBM entity provides warranty service in that country, or from an IBM reseller, approved by IBM to perform warranty service on that Machine in that country. Warranty service in Africa is available within 50 kilometers of an IBM authorized service provider. You are responsible for transportation costs for Machines located outside 50 kilometers of an IBM authorized service provider.

Governing Law:

The applicable laws that govern, interpret and enforce rights, duties, and obligations of each of us arising from, or relating in any manner to, the subject matter of this Statement, without regard to conflict of laws principles, as well as Country-unique terms and competent court for this Statement are those of the country in which the warranty service is being provided, except that in 1) Albania, Bosnia-Herzegovina, Bulgaria, Croatia, Hungary, Former Yugoslav Republic of Macedonia, Romania, Slovakia, Slovenia, Armenia, Azerbaijan, Belarus, Georgia, Kazakhstan, Kyrgyzstan, Moldova, Russia, Tajikistan, Turkmenistan, Ukraine, and Uzbekistan, the laws of Austria apply; 2) Estonia, Latvia, and Lithuania, the laws of Finland apply; 3) Algeria, Benin, Burkina Faso, Cameroon, Cape Verde, Central African Republic, Chad, Congo, Djibouti, Democratic Republic of Congo, Equatorial Guinea, France, Gabon, Gambia, Guinea, Guinea-Bissau, Ivory Coast, Lebanon, Mali, Mauritania, Morocco, Niger, Senegal, Togo, and Tunisia, this Agreement will be construed and the legal relations between the parties will be determined in accordance with the French laws and all disputes arising out of this Agreement or related to its violation or execution, including summary proceedings, will be settled exclusively by the Commercial Court of Paris; 4) Angola, Bahrain, Botswana, Burundi, Egypt, Eritrea, Ethiopia, Ghana, Jordan, Kenya, Kuwait, Liberia, Malawi, Malta, Mozambique, Nigeria, Oman, Pakistan, Qatar, Rwanda, Sao Tome, Saudi Arabia, Sierra Leone, Somalia, Tanzania, Uganda, United Arab Emirates, United Kingdom, West Bank/Gaza, Yemen, Zambia, and Zimbabwe, this Agreement will be governed by English Law and disputes relating to it will be submitted to the exclusive jurisdiction of the English courts; and 5) in Greece, Israel, Italy, Portugal, and Spain any legal claim arising out of this Statement will be brought before, and finally settled by, the competent court of Athens, Tel Aviv, Milan, Lisbon, and Madrid, respectively.

THE FOLLOWING TERMS APPLY TO THE COUNTRY SPECIFIED:

AUSTRIA AND GERMANY

The IBM Warranty for Machines: *The following replaces the first sentence of the first paragraph of this Section:*

The warranty for an IBM Machine covers the functionality of the Machine for its normal use and the Machine's conformity to its Specifications.

The following paragraphs are added to this Section:

The minimum warranty period for Machines is six months. In case IBM or your reseller is unable to repair an IBM Machine, you can alternatively ask for a partial refund as far as justified by the reduced value of the unrepaired Machine or ask for a cancellation of the respective agreement for such Machine and get your money refunded.

Extent of Warranty:*The second paragraph does not apply.*

Warranty Service: *The following is added to this Section:*

During the warranty period, transportation for delivery of the failing Machine to IBM will be at IBM's expense.

Limitation of Liability: *The following paragraph is added to this Section:*

The limitations and exclusions specified in the Statement of Limited Warranty will not apply to damages caused by IBM with fraud or gross negligence and for express warranty.

The following sentence is added to the end of item 2:

IBM's liability under this item is limited to the violation of essential contractual terms in cases of ordinary negligence.

EGYPT

Limitation of Liability:*The following replaces item 2 in this Section:*

as to any other actual direct damages, IBM's liability will be limited to the total amount you paid for the Machine that is the subject of the claim. For purposes of this item, the term "Machine" includes Machine Code and Licensed Internal Code.

Applicability of suppliers and resellers (unchanged).

FRANCE

Limitation of Liability:*The following replaces the second sentence of the first paragraph of this Section:*

In such instances, regardless of the basis on which you are entitled to claim damages from IBM, IBM is liable for no more than: *(items 1 and 2 unchanged)*.

IRELAND

Extent of Warranty: *The following is added to this Section:*

Except as expressly provided in these terms and conditions, all statutory conditions, including all warranties implied, but without prejudice to the generality of the foregoing all warranties implied by the Sale of Goods Act 1893 or the Sale of Goods and Supply of Services Act 1980 are hereby excluded.

Limitation of Liability: *The following replaces items one and two of the first paragraph of this Section:*

1. death or personal injury or physical damage to your real property solely caused by IBM's negligence; and
2. the amount of any other actual direct damages, up to 125 percent of the charges (if recurring, the 12 months' charges apply) for the Machine that is the subject of the claim or which otherwise gives rise to the claim.

Applicability of suppliers and resellers (unchanged).

The following paragraph is added at the end of this Section:

IBM's entire liability and your sole remedy, whether in contract or in tort, in respect of any default shall be limited to damages.

ITALY

Limitation of Liability: *The following replaces the second sentence in the first paragraph:*

In each such instance unless otherwise provided by mandatory law, IBM is liable for no more than:

1. *(unchanged)*
2. as to any other actual damage arising in all situations involving nonperformance by IBM pursuant to, or in any way related to the subject matter of this Statement of Warranty, IBM's liability, will be limited to the total amount you paid for the Machine that is the subject of the claim.

Applicability of suppliers and resellers (unchanged).

The following replaces the third paragraph of this Section:

Unless otherwise provided by mandatory law, IBM and your reseller are not liable for any of the following: *(items 1 and 2 unchanged)* 3) indirect damages, even if IBM or your reseller is informed of their possibility.

SOUTH AFRICA, NAMIBIA, BOTSWANA, LESOTHO AND SWAZILAND

Limitation of Liability:*The following is added to this Section:*

IBM's entire liability to you for actual damages arising in all situations involving nonperformance by IBM in respect of the subject matter of this Statement of Warranty will be limited to the charge paid by you for the individual Machine that is the subject of your claim from IBM.

UNITED KINGDOM

Limitation of Liability:*The following replaces items 1 and 2 of the first paragraph of this Section:*

1. death or personal injury or physical damage to your real property solely caused by IBM's negligence;
2. the amount of any other actual direct damages or loss, up to 125 percent of the charges (if recurring, the 12 months' charges apply) for the Machine that is the subject of the claim or which otherwise gives rise to the claim;

The following item is added to this paragraph:

3. breach of IBM's obligations implied by Section 12 of the Sale of Goods Act 1979 or Section 2 of the Supply of Goods and Services Act 1982.

Applicability of suppliers and resellers (unchanged).

The following is added to the end of this Section:

IBM's entire liability and your sole remedy, whether in contract or in tort, in respect of any default shall be limited to damages.

Appendix F. Notices

This section contains information on the notices.

Federal Communications Commission (FCC) statement

iLV200/iLC200 Data/Video Projector

Note: This equipment has been tested and found to comply with the limits for a Class A digital device, pursuant to Part 15 of the FCC Rules. These limits are designed to provide reasonable protection against harmful interference when the equipment is operated in a commercial environment. This equipment generates, uses, and can radiate radio frequency energy and, if not installed and used in accordance with the instruction manual, may cause harmful interference to radio communications. Operation of this equipment in a residential area is likely to cause harmful interference, in which case the user will be required to correct the interference at his own expense.

Properly shielded and grounded cables and connectors must be used in order to meet FCC emission limits. IBM is not responsible for any radio or television interference caused by using other than recommended cables and connectors or by unauthorized changes or modifications to this equipment. Unauthorized changes or modifications could void the user's authority to operate the equipment.

This device complies with Part 15 of the FCC Rules. Operation is subject to the following two conditions: (1) this device may not cause harmful interference, and (2) this device must accept any interference received, including interference that may cause undesired operation.

Industry Canada Class A emission compliance statement

This Class A digital apparatus complies with Canadian ICES-003.

Avis de conformité a la réglementation d'Industrie Canada

Cet appareil numérique de la classe A est conforme à la norme NMB-003 du Canada.

Deutsche EMV-Direktive (electromagnetische Verträglichkeit)

Dieses Gerät ist berechtigt in Übereinstimmung mit dem deutschen EMVG vom 9.Nov.92 das EG-Konformitätszeichen zu führen.

Der Aussteller der Konformitätserklärung ist die IBM UK, Greenock.

Dieses Gerät erfüllt die Bedingungen der EN 55022 Klasse A. Für diese Klasse von Geräten gilt folgende Bestimmung nach dem EMVG:

Geräte dürfen an Orten, für die sie nicht ausreichend geschützt sind, nur mit besonderer Genehmigung des Bundesministers für Post und Telekommunikation oder des Bundesamtes für Post und Telekommunikation betrieben werden. Die Genehmigung wird erteilt, wenn keine elektromagnetischen Störungen zu erwarten sind.

(Auszug aus dem EMVG vom 9.Nov.92, Para.3. Abs.4)

Hinweis: Dieses Genehmigungsverfahren ist von der Deutschen Bundespost noch nicht veröffentlicht worden.

European Union - EMC directive

This product is in conformity with the protection requirements of EU Council Directive 89/336/ECC on the approximation of the laws of the Member States relating to electromagnetic compatibility.

IBM cannot accept responsibility for any failure to satisfy the protection requirements resulting from a non-recommended modification of the product, including the fitting of non-IBM option cards.

This product has been tested and found to comply with the limits for Class A Information Technology Equipment according to CISPR 22/European Standard EN 55022. The limits for Class A equipment were derived for commercial and industrial environments to provide reasonable protection against interference with licensed communication equipment.

Warning: This is a Class A product. In a domestic environment this product may cause radio interference in which case the user may be required to take adequate measures.

Union Européenne - Directive Conformité électromagnétique

Ce produit est conforme aux exigences de protection de la Directive 89/336/EEC du Conseil de l'UE sur le rapprochement des lois des États membres en matière de compatibilité électromagnétique.

IBM ne peut accepter aucune responsabilité pour le manquement aux exigences de protection résultant d'une modification non recommandée du produit, y compris l'installation de cartes autres que les cartes IBM.

Ce produit a été testé et il satisfait les conditions de l'équipement informatique de Classe A en vertu de CISPR22/Standard européen EN 55022. Les conditions pour l'équipement de Classe A ont été définies en fonction d'un contexte d'utilisation commercial et industriel afin de fournir une protection raisonnable contre l'interférence d'appareils de communication autorisés.

Avvertissement : Ceci est un produit de Classe A. Dans un contexte résidentiel, ce produit peut causer une interférence radio exigeant que l'utilisateur prenne des mesures adéquates.

Union Europea - Normativa EMC

Questo prodotto è conforme alle normative di protezione ai sensi della Direttiva del Consiglio dell'Unione Europea 89/336/CEE sull'armonizzazione legislativa degli stati membri in materia di compatibilità elettromagnetica.

IBM non accetta responsabilità alcuna per la mancata conformità alle normative di protezione dovuta a modifiche non consigliate al prodotto, compresa l'installazione di schede e componenti di marca diversa da IBM.

Le prove effettuate sul presente prodotto hanno accertato che esso rientra nei limiti stabiliti per le apparecchiature di informatica Classe A ai sensi del CISPR 22/Norma Europea EN 55022. I limiti delle apparecchiature della Classe A sono stati stabiliti al fine di fornire ragionevole protezione da interferenze mediante dispositivi di comunicazione in concessione in ambienti commerciali ed industriali.

Avvertimento: Questo è un prodotto appartenente alla Classe A. In ambiente domestico, tale prodotto può essere causa di interferenze radio, nel qual caso l'utente deve prendere misure adeguate.

Unione Europea - Directiva EMC (Conformidad electromagnética)

Este producto satisface los requisitos de protección del Consejo de la UE, Directiva 89/336/CEE en lo que a la legislatura de los Estados Miembros sobre compatibilidad electromagnética se refiere.

IBM no puede aceptar responsabilidad alguna si este producto deja de satisfacer dichos requisitos de protección como resultado de una modificación no recomendada del producto, incluyendo el ajuste de tarjetas de opción que no sean IBM.

Este producto ha sido probado y satisface los límites para Equipos Informáticos Clase A de conformidad con el Estándar CISPR22 y el Estándar Europeo EN 55022. Los límites para los equipos de Clase A se han establecido para entornos

comerciales e industriales a fin de proporcionar una protección razonable contra las interferencias con dispositivos de comunicación licenciados.

Advertencia: Este es un producto de Clase A. En un entorno doméstico este producto podría causar radiointerferencias en cuyo caso el usuario deberá tomar las medidas adecuadas.

この装置は、情報処理装置等電波障害自主規制協議会（VCCI）の基準に基づくクラスA情報技術装置です。この装置を家庭環境で使用すると電波妨害を引き起こすことがあります。この場合には使用者が適切な対策を講ずるよう要求されることがあります。

警告使用者：
這是甲類的資訊產品，在居住的環境中使用時，可能會造成射頻干擾，在這種情況下，使用者會被要求採取某些適當的對策。

Notices

IBM may not offer the products, services, or features discussed in this document in all countries. Consult your local IBM representative for information on the products and services currently available in your area. Any reference to an IBM product, program, or service is not intended to state or imply that only that IBM product, program, or service may be used. Any functionally equivalent product, program, or service that does not infringe any IBM intellectual property right may be used instead. However, it is the user's responsibility to evaluate and verify the operation of any non-IBM product, program, or service.

IBM may have patents or pending patent applications covering subject matter described in this document. The furnishing of this document does not give you any license to these patents. You can send license inquiries, in writing, to:

*IBM Director of Licensing
IBM Corporation*

*North Castle Drive
Armonk, NY 10504-1785
U.S.A.*

The following paragraph does not apply to the United Kingdom or any country where such provisions are inconsistent with local law:

INTERNATIONAL BUSINESS MACHINES CORPORATION PROVIDES THIS PUBLICATION "AS IS" WITHOUT WARRANTY OF ANY KIND, EITHER EXPRESS OR IMPLIED, INCLUDING, BUT NOT LIMITED TO, THE IMPLIED WARRANTIES OF NON-INFRINGEMENT, MERCHANTABILITY OR FITNESS FOR A PARTICULAR PURPOSE. Some states do not allow disclaimer of express or implied warranties in certain transactions, therefore, this statement may not apply to you.

This information could include technical inaccuracies or typographical errors. Changes are periodically made to the information herein; these changes will be incorporated in new editions of the publication. IBM may make improvements and/or changes in the product(s) and/or the program(s) described in this publication at any time without notice.

IBM may use or distribute any of the information you supply in any way it believes appropriate without incurring any obligation to you.

Trademarks

The following terms are trademarks of the IBM Corporation in the United States or other countries or both:

IBM

HelpCenter

Microsoft, PowerPoint, Windows, and Windows NT are trademarks of Microsoft Corporation in the United States or other countries or both.

Other company, product, and service names may be trademarks or service marks of others.



Part Number: 33L3369



Printed in the United States of America
on recycled paper containing 10%
recovered post-consumer fiber.

(1P) P/N: 33L3369



Free Manuals Download Website

<http://myh66.com>

<http://usermanuals.us>

<http://www.somanuals.com>

<http://www.4manuals.cc>

<http://www.manual-lib.com>

<http://www.404manual.com>

<http://www.luxmanual.com>

<http://aubethermostatmanual.com>

Golf course search by state

<http://golfingnear.com>

Email search by domain

<http://emailbydomain.com>

Auto manuals search

<http://auto.somanuals.com>

TV manuals search

<http://tv.somanuals.com>