



@server<sup>™</sup>  
xSeries 343

# Hardware Maintenance Manual

Second Edition (May 2002)

© **COPYRIGHT INTERNATIONAL BUSINESS MACHINES CORPORATION, 2002. All rights reserved.**

Note to U.S. Government Users — Documentation related to restricted rights — Use, duplication or disclosure is subject to restrictions set forth in GSA ADP Schedule Contract with IBM Corp.

# Contents

---

Safety .....	ix
<b>Part I: User's Guide.....</b>	<b>1</b>
<b>1 Introduction .....</b>	<b>5</b>
Notices and Statements Used in This Book.....	5
Before You Begin .....	6
Handling Static-sensitive Devices.....	6
<b>2 Chassis Description .....</b>	<b>7</b>
Physical Specifications .....	7
Features and Specifications .....	8
Environmental Specifications.....	9
Chassis Feature Location .....	10
Front Panel.....	10
Back Panel .....	13
Internal Chassis Features.....	14
Riser Boards.....	22
Power Supplies.....	23
DC Power Subsystem.....	23
Peripheral Bay .....	25
Hard Drive Tray .....	25
Cooling Subsystem.....	26
Server Management Summary.....	27
Server Board Management Controller.....	27
<b>3 Regulatory Specifications and Disclaimers .....</b>	<b>29</b>
Declaration of the Manufacturer or Importer.....	29
Electronic Emission Notices.....	29
<b>4 Configuration Software and Utilities.....</b>	<b>33</b>
Using BIOS Setup .....	34
Recording Your Setup Settings.....	34
If You Cannot Access Setup .....	34
Starting Setup.....	34
Setup Menus .....	35
Main Menu.....	36
Advanced Menu.....	37
Security Menu.....	39
Server Menu .....	40
Boot Menu .....	42
Exit Menu .....	43
Upgrading the BIOS .....	44
Preparing for the Upgrade .....	44
Upgrading the BIOS.....	45
Recovering the BIOS.....	46
Changing the BIOS Language .....	47

Using the System Setup Utility .....	47
What You Need to Do.....	47
Running the SSU from the CD.....	47
Running the SSU Remotely via an Emergency Management Card.....	48
Starting the SSU.....	48
Customizing the SSU.....	49
Launching a Task.....	50
SEL Manager Add-in.....	50
SDR Manager Add-in.....	51
FRU Manager Add-in.....	51
Exiting the SSU.....	52
FRU/SDR Load Utility.....	52
When to Run the FRU/SDR Load Utility.....	53
What You Need to Do.....	53
How You Use the FRU/SDR Load Utility.....	53
Using the Firmware Update Utility.....	56
Making a BMC Firmware Update Diskette.....	56
Updating the BMC Firmware.....	56
Making a FRU/SDR File Update Diskette.....	56
Updating the FRU/SDR Files.....	57
Using the Adaptec SCSI Utility.....	57
Running the SCSI Utility.....	57
<b>Part II: Service Technician's Guide.....</b>	<b>59</b>
Equipment Rack Precautions.....	60
<b>5 Upgrading the Hardware.....</b>	<b>61</b>
Tools and Supplies Needed.....	61
Caution and Danger Statements.....	61
Replacing Power Supply Modules.....	63
Replacing Hard Disk Drives.....	64
Working Inside the System.....	66
Safety: Before You Remove Server Covers.....	66
Caution and Danger Statements.....	66
Handling Static-sensitive Devices.....	68
Removing and Installing the Top Cover.....	68
Internal Chassis Layout.....	70
Removing and Installing Memory.....	71
Removing and Installing Processors.....	72
Replacing 3.3 Volt and 5 Volt PCI Add-in Cards.....	78
Replacing the Back Up Battery.....	79
<b>6 Upgrading the Chassis.....</b>	<b>83</b>
Replacing the Server Board.....	83
Replacing the CD-ROM and Floppy Disk Drives.....	85
Replacing the Front Panel Board.....	87
Replacing Fans.....	88
Removing the Power Supply Cage.....	90

<b>7</b>	<b>Technical Reference .....</b>	<b>91</b>
	Connector Pinouts.....	91
	Alarms 91	
	DC Power Input for DC-Input Power Supply Cage.....	92
	Serial Ports.....	93
	Configuration Jumpers .....	94
	System Recovery and Update Jumpers (J1E1) .....	95
	DSR/DCD Configuration Jumper (J6A2).....	95
	FRU List.....	96
<b>A</b>	<b>POST Error Codes, Messages and FRU to Failure Information .....</b>	<b>98</b>
	POST Codes and Error Messages.....	103
	POST Error Beep Codes .....	106
	PC Doctor Symptom to FRU.....	108
<b>B</b>	<b>Equipment Log and Configuration Worksheet .....</b>	<b>110</b>
	Equipment Log.....	110
<b>C</b>	<b>Solving Problems.....</b>	<b>112</b>
	Resetting the System .....	112
	Initial System Startup.....	112
	Initial System Startup Checklist.....	112
	Running New Application Software.....	113
	Running New Application Software Checklist.....	113
	After the System Has Been Running Correctly .....	113
	After the System Has Been Running Correctly Checklist .....	113
	More Problem Solving Procedures .....	114
	Preparing the System for Diagnostic Testing .....	114
	Monitoring POST .....	114
	Verifying Proper Operation of Key System Lights .....	114
	Confirming Loading of the Operating System.....	114
	Specific Problems and Corrective Actions .....	115
	Power Light Does Not Light .....	115
	No Characters Appear on Screen .....	115
	Characters Are Distorted or Incorrect.....	116
	System Cooling Fans Do Not Rotate Properly .....	116
	Diskette Drive Activity Light Does Not Light .....	116
	Hard Disk Drive Activity Light Does Not Light .....	116
	CD-ROM Drive Activity Light Does Not Light .....	117
	Cannot Connect to a Server .....	117
	Problems with Network .....	117
	PCI Installation Tips.....	118
	Problems with Application Software.....	118
	Bootable CD-ROM Is Not Detected .....	118
	Problem Determination Tips .....	119
<b>D</b>	<b>Getting Information, Help, and Services.....</b>	<b>120</b>
	Getting Information.....	120
	Getting Help and Service.....	120

<b>E</b>	<b>Safety Addendum .....</b>	<b>124</b>
	Related Service Information .....	124
	Safety Information .....	124
	General Safety.....	124
	Electrical Safety.....	125
	Safety Inspection Guide.....	127
	Handling Electrostatic Discharge-sensitive Devices.....	128
	Grounding Requirements.....	129
	Safety Notices (multi-lingual translations) .....	129
<b>F</b>	<b>Product Notices .....</b>	<b>168</b>
	Notices .....	168
	Trademarks .....	169
	Important Notes .....	169
	<b>Index.....</b>	<b>170</b>
	<b>Figures</b>	
	1. xSeries 343 Server Chassis.....	7
	2. Front Panel.....	10
	3. Front View with Bezel Removed .....	12
	4. Back Panel .....	13
	5. Server Board Connector and Component Locations .....	14
	6. 5 Volt Riser Board .....	22
	7. 3.3 Volt Riser Board.....	22
	8. Non-redundant DC-Power Supply Subsystem (Filler Module shown at Left).....	23
	9. Fan Array with Four System Fans Installed .....	26
	10. Tools and Supplies Needed.....	61
	11. Unlocking and Removing the Power Supply Modules.....	63
	12. Disconnecting the Hard Disk Drive Bay Cables .....	64
	13. Removing a Hard Disk Drive.....	65
	14. Removing the Top Cover.....	69
	15. Internal Chassis Layout .....	70
	16. Installing DIMMs .....	71
	17. Raising the Locking Bar and Removing the Terminator .....	73
	18. Inserting the Processor and Lowering the Locking Bar .....	74
	19. Aligning the Heatsink and Installing the Heatsink Retaining Clip.....	75
	20. Unlatching the Heatsink Retaining Clip.....	76
	21. Raising the Locking Bar on the Processor Socket .....	76
	22. Installing a Terminator .....	77
	23. Replacing 3.3 Volt or 5 Volt PCI Add-in Cards.....	78
	24. PCI Adapter Cable Installation.....	79
	25. Replacing the Backup Battery.....	81
	26. Removing the Server Board Cabling.....	83
	27. Removing the Server Board Retaining Screws .....	84
	28. Removing the Peripheral Bay from the Chassis.....	85
	29. Separating the CD-ROM and Floppy Disk Drives from the Peripheral Bay .....	86
	30. Front Panel Removal.....	87
	31. Replacing 80 mm Fans.....	88

32.	Replacing 40 mm Fans.....	89
33.	Removing the Power Supply Cage .....	90
34.	15-pin Alarms Connector .....	91
35.	DC Power Input Connector .....	92
36.	DC Power Terminal Lug .....	92
37.	Serial Ports A and B .....	93
38.	Jumper Locations (J1E1 and J6A2).....	94
39.	J6A2 Jumper Block Configured for DCD Signal.....	95
40.	J6A2 Jumper Block Configured for DSR Signal (Default).....	95

## Tables

1.	Server Physical Specifications.....	7
2.	Features and Specifications.....	8
3.	Environmental Specifications Summary.....	9
4.	Front Panel Features.....	11
5.	Back Panel Features .....	13
6.	Rear COM2 Port Adapter Pin-out .....	18
7.	Software Security Features.....	20
8.	LED Indicators .....	24
9.	DC Input Rating.....	25
10.	350 W Load Ratings .....	25
11.	Configuration Utilities.....	33
12.	Alarms Connector Pinout.....	91
13.	Serial Port Connector Pinout .....	93
14.	System Recovery and Update Jumper Options .....	95
15.	Port-80h Code Definition .....	98
16.	Boot Block POST Codes .....	98
17.	POST Code - Port 80h Codes .....	99
18.	POST Codes and Error Messages.....	103
19.	Extended POST Error Messages and Codes.....	104
20.	BMC Generated POST Beep Codes.....	106
21.	BIOS Generated POST Error Beep Codes .....	106
22.	POST Memory Error 3-Beep Codes .....	107
23.	Diagnostic Related Syndromes.....	108





# Safety

Before installing this product, read the Safety Information.

قبل تركيب هذا المنتج، يجب قراءة الملاحظات الأمنية

Antes de instalar este produto, leia as Informações de Segurança.

在安装本产品之前，请仔细阅读 **Safety Information** (安全信息)。

安裝本產品之前，請先閱讀「安全資訊」。

Prije instalacije ovog produkta obavezno pročitajte Sigurnosne Upute.

Před instalací tohoto produktu si přečtěte příručku bezpečnostních instrukcí.

Læs sikkerhedsforskrifterne, før du installerer dette produkt.

Lees voordat u dit product installeert eerst de veiligheidsvoorschriften.

Ennen kuin asennat tämän tuotteen, lue turvaohjeet kohdasta Safety Information.

Avant d'installer ce produit, lisez les consignes de sécurité.

Vor der Installation dieses Produkts die Sicherheitshinweise lesen.

Πριν εγκαταστήσετε το προϊόν αυτό, διαβάστε τις πληροφορίες ασφάλειας (safety information).

לפני שתתקינו מוצר זה, קראו את הוראות הבטיחות.

A termék telepítése előtt olvassa el a Biztonsági előírásokat!

Prima di installare questo prodotto, leggere le Informazioni sulla Sicurezza.

製品の設置の前に、安全情報をお読みください。

본 제품을 설치하기 전에 안전 정보를 읽으십시오.

Пред да се инсталира овој продукт, прочитајте информацијата за безбедност.

Les sikkerhetsinformasjonen (Safety Information) før du installerer dette produktet.

Przed zainstalowaniem tego produktu, należy zapoznać się z książką "Informacje dotyczące bezpieczeństwa" (Safety Information).

Antes de instalar este produto, leia as Informações sobre Segurança.

Перед установкой продукта прочтите инструкции по технике безопасности.

Pred inštaláciou tohto zariadenia si pečítajte Bezpečnostné predpisy.

Pred namestitvijo tega proizvoda preberite Varnostne informacije.

Antes de instalar este producto, lea la información de seguridad.

Läs säkerhetsinformationen innan du installerar den här produkten.

## Statement 1



### DANGER

**Electrical current from power, telephone, and communication cables is hazardous.**

**To avoid a shock hazard:**

- **Do not connect or disconnect any cables or perform installation, maintenance, or reconfiguration of this product during an electrical storm.**
- **Connect all power cords to a properly wired and grounded electrical outlet.**
- **Connect to properly wired outlets any equipment that will be attached to this product.**
- **When possible, use one hand only to connect or disconnect signal cables.**
- **Never turn on any equipment when there is evidence of fire, water, or structural damage.**
- **Disconnect the attached power cords, telecommunications systems, networks, and modems before you open the device covers, unless instructed otherwise in the installation and configuration procedures.**
- **Connect and disconnect cables as described in the following table when installing, moving, or opening covers on this product or attached devices.**

#### **To Connect:**

1. Turn everything OFF.
2. First, attach all cables to devices.
3. Attach signal cables to connectors.
4. Attach power cords to outlet.
5. Turn device ON.

#### **To Disconnect:**

1. Turn everything OFF.
2. First, remove power cords from outlet.
3. Remove signal cables from connectors.
4. Remove all cables from devices.

## Statement 2



### CAUTION

**When replacing the lithium battery, use only IBM Part Number 33F8354 or an equivalent type battery recommended by the manufacturer. If your system has a module containing a lithium battery, replace it only with the same module type made by the same manufacturer. The battery contains lithium and can explode if not properly used, handled, or disposed of.**

**Do not:**

- **Throw or immerse into water**
- **Heat to more than 100 °C (212 °F)**
- **Repair or disassemble**

**Dispose of the battery as required by local ordinances or regulations.**

**Statement 3**



**CAUTION**

When laser products (such as CD-ROMs, DVD drives, fiber optic devices, or transmitters) are installed, note the following:

- Do not remove the covers. Removing the covers of the laser product could result in exposure to hazardous laser radiation. There are no serviceable parts inside the device.
- Use of controls or adjustments or performance of procedures other than those specified herein might result in hazardous radiation exposure.



**DANGER**

Some laser products contain an embedded Class 3A or Class 3B laser diode. Note the following. Laser radiation when open. Do not stare into the beam, do not view directly with optical instruments, and avoid direct exposure to the beam.

**Statement 4**

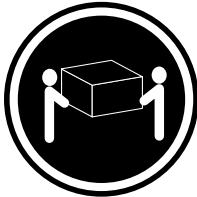

≥18 kg (39.7 lb)



≥32 kg (70.5 lb)

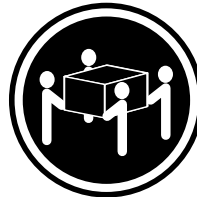

≥55 kg (121.2 lb)

**CAUTION**

Use safe practices when lifting.

**Statement 14**



**CAUTION**

Hazardous voltage, current, and energy levels might be present. Only a qualified service technician is authorized to remove the covers where the following label is attached.



**Statement 15**



**CAUTION**

**Make sure that the rack is secured properly to avoid tipping when the server unit is extended.**

# Part I: User's Guide

---

## 1 Introduction

## 2 Chassis Description

## 3 Regulatory Specifications and Disclaimers

## 4 Configuration Software and Utilities

This document provides an overview of the IBM® @server xSeries 343 server. This manual consists of two parts:

- *User's Guide*, beginning on page 1 describes procedures that **DO NOT REQUIRE** removing and replacing boards. You do not need to be a qualified service technician to perform procedures listed in the *User's Guide*.
- *Service Technician's Guide*, beginning on page 59 describes procedures that **REQUIRE** removing and replacing boards. You must be a qualified service technician to perform procedures listed in the *Service Technician's Guide*.

### Statement 14



### CAUTION

Hazardous voltage, current, and energy levels might be present. Only a qualified service technician is authorized to remove the covers where the following label is attached.



### Statement 15



### CAUTION

Make sure that the rack is secured properly to avoid tipping when the server unit is extended.

## Notes

Only use a screwdriver tip to push in the lock tabs on the rack slides. A pinch hazard exists if fingers are used for this purpose.

**DC Power supplies are installed:** The DC source must be electrically isolated by double or reinforced insulation from any hazardous DC source. The DC source must be capable of providing up to 350 W of continuous power per feed pair. Connection with a DC source should only be performed by trained service personnel.

**Mains DC power disconnect:** You are responsible for installing a DC power disconnect for the entire rack unit. This mains disconnect must be readily accessible, and it must be labeled as controlling power to the entire unit, not just to the servers(s).

**Grounding the rack installation:** To avoid the potential for an electrical shock hazard, you must include a third wire safety ground conductor with the rack installation. The safety grounding conductor must be a minimum 14AWG connected to the earth ground stud on the rear of the server. The safety ground conductor should be connected to the chassis stud with a two hole crimp terminal with a maximum width of 0.25 inch. The nuts on the chassis studs should be installed with a 10 in/lbs torque. The safety ground conductor provides proper grounding only for the server. You must provide additional, proper grounding for the rack and other devices installed in it.

**Overcurrent protection:** Overcurrent protection circuit breakers must be provided as part of each host equipment rack and must be installed between the DC source and the server. The server is designed for a DC line voltage power source with up to 10 amperes of overcurrent protection per feed pair. If the DC power system for the equipment rack is installed with more than 10 amperes of protection, you must provide supplemental protection for the server. The overall current rating of a server configured with two power supplies is less than 7 amperes.

**Temperature:** The temperature in which the server operates when installed in an equipment rack, must not go below 5 °C (41 °F) or rise above 40 °C (104 °F). Extreme fluctuations in temperature can cause a variety of problems in your server.

**Ventilation:** The equipment rack must provide sufficient airflow to the front of the server to maintain proper cooling. The rack must also include ventilation sufficient to exhaust a maximum of 1023 BTUs per hour for the server. The rack selected and the ventilation provided must be suitable to the environment in which the server will be used.

**Statement 4**

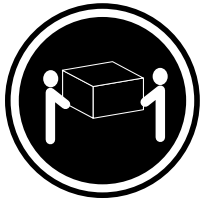

≥18 kg (39.7 lb)

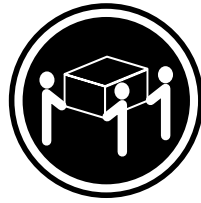

≥32 kg (70.5 lb)

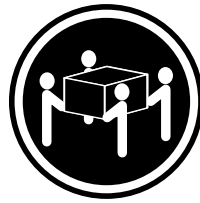

≥55 kg (121.2 lb)

**CAUTION**

Use safe practices when lifting.





# 1 Introduction

---

Thank you for purchasing an xSeries 343 server.

Your xSeries 343 server comes with a one-year limited warranty. If you have access to the World Wide Web, you can obtain up-to-date information about your xSeries 343 model and other IBM server products at <http://www.ibm.com/eserver/xseries>.

Record your product information in this table.	
Product name	_____
Type	_____
Model number	_____
Serial number	_____

This server serial number is located on labels on the rear of the server and on the front of the server on the bezel.

## Notices and Statements Used in This Book

The Caution and Danger statements also appear in the multilingual safety information book provided on the *Documentation and Resource CD*. Each statement is numbered for easy reference to the corresponding statement in the safety book.

Descriptions of the notices and statements that appear in this book are as follows:

- **Notes:** These notices provide important tips, guidance, or advice.
- **Attention:** These notices indicate possible damage to programs, devices, or data. An attention notice is placed just before the instruction or situation in which damage could occur.
- **Caution:** These statements indicate situations that can be potentially hazardous to you. A caution statement is placed just before the description of potentially hazardous procedure step or situation.
- **Danger:** These statements indicate situations that can be potentially lethal or extremely hazardous to you. A danger statement is placed just before the description of a potentially lethal or extremely hazardous procedure step or situation.

## Before You Begin

Before you begin to install options in your server, read the following information:

- Become familiar with the information provided in “Handling Static-sensitive Devices” and in the “Safety Addendum”. These guidelines will help you make changes to disk drives.
- Make sure that you have an adequate number of properly grounded electrical outlets for your server, monitor, and any other options that you intend to install.
- Back up all important data before you make changes to disk drives.
- For a list of supported options for the xSeries 343, refer to <http://www.ibm.com/pc/compat> on the World Wide Web.

## Handling Static-sensitive Devices

**Attention:** Static electricity can damage electronic devices and your system. To avoid damage, keep static-sensitive devices in their static-protective package until you are ready to install them.

To reduce the possibility of electrostatic discharge, observe the following precautions:

- Limit your movement. Movement can cause static electricity to build up around you.
- Handle the device carefully, holding it by its edges or its frame.
- Do not touch solder joints, pins, or exposed printed circuitry.
- Do not leave the device where others can handle and possibly damage the device.
- While the device is still in its anti-static package, touch it to an unpainted metal part of the system unit for at least two seconds. (This drains static electricity from the package and from your body.)
- Remove the device from its package and install it directly into your system unit without setting it down. If it is necessary to set the device down, place it in its static-protective package. Do not place the device on your system unit cover or on a metal table.
- Take additional care when handling devices during cold weather because heating reduces indoor humidity and increases static electricity.

## 2 Chassis Description

---

The xSeries 343 is a rack-mounted server that supports one to two Intel® Pentium® III processors and up to 6 GB of SDRAM memory. The server supports high availability features such as hot-swap and redundant power supply modules. The scalable architecture of the server supports symmetric multiprocessing (SMP) and a variety of operating systems.

### Physical Specifications

Table 1 lists the server's physical specifications while Figure 1 presents a view of the xSeries 343 server chassis.

**Table 1. Server Physical Specifications**

Specification	Value
Height	3.5 inches (89 mm)
Width	17.5 inches (445 mm)
Depth	20 inches (508 mm)
Front clearance	2 inches (76 mm)
Side clearance	1 inch (25 mm)
Rear clearance	3.6 inches (92 mm)



OM14189

**Figure 1. xSeries 343 Server Chassis**

## Features and Specifications

**Table 2. Features and Specifications**

Feature	Description										
Configuration	1-2 way capability in low profile and cost/value effective packaging Stand-alone system										
Processor Support	Intel Pentium III up to 2 GHz										
Power	Two hot-swap 350 W power supplies in a redundant (1+1) configuration										
System Management	Remote management Emergency management port (Serial and LAN) IPMI 1.5 compliant WfM 2.0 compliant Remote diagnostics support										
Upgrades	Supports Pentium III processor family Upgradeable to next generation Pentium IV processor family Multi-generational chassis										
Expansion	6 GB 133 MHz SDRAM memory support Dual Intel Pentium III processor support 3 Full Height Full Length 64-bit x 66 MHz PCI Slots or; 3 Full Height Full Length 64-bit x 33 MHz PCI Slots 3 Low Profile / Half Length 64-bit x 66 MHz PCI Slots 2 internal SCSI disk drives 1 Low Profile CD-ROM 1 Low Profile floppy drive										
Front panel controls and indicators	<table border="0"> <tr> <td>Power switch</td> <td>Telco power alarm fault LED/Relay</td> </tr> <tr> <td>Reset switch</td> <td>Telco critical alarm fault LED/Relay</td> </tr> <tr> <td>Main power LED</td> <td>Telco major alarm fault LED/Relay</td> </tr> <tr> <td>HDD activity LED</td> <td>Telco minor alarm fault LED/Relay</td> </tr> <tr> <td>NIC activity LED</td> <td></td> </tr> </table>	Power switch	Telco power alarm fault LED/Relay	Reset switch	Telco critical alarm fault LED/Relay	Main power LED	Telco major alarm fault LED/Relay	HDD activity LED	Telco minor alarm fault LED/Relay	NIC activity LED	
Power switch	Telco power alarm fault LED/Relay										
Reset switch	Telco critical alarm fault LED/Relay										
Main power LED	Telco major alarm fault LED/Relay										
HDD activity LED	Telco minor alarm fault LED/Relay										
NIC activity LED											

# Environmental Specifications

The xSeries 343 system has been tested to the environmental specifications as indicated in Table 3. All testing has been performed per procedures defined in Bellcore GR-63-CORE NEBS Physical Protection, Bellcore GR-3580 NEBS Criteria Levels, Bellcore GR-1089-CORE EMC and Electrical Safety – Generic Criteria for Network Telecommunications Equipment, and the Intel Environmental Standards Handbook.

**Table 3. Environmental Specifications Summary**

<b>Environment</b>	<b>Specification</b>
Temperature operating	5 °C to 40 °C (41 °F to 104 °F)
Temperature non-operating	-40 °C to 70 °C (-104 °F to 158 °F)
Altitude	0 to 1,800 m (0 to 5,905 ft)
Humidity non-operating	95%, non-condensing at temperatures of 23 °C (73 °F) to 40 °C (104 °F)
Vibration operating	Swept sine survey at an acceleration amplitude of 0.1 g from 5 to 100 Hz and back to 5 Hz at a rate of 0.1 octave/minute, 90 minutes per axis on all three axes as per Bellcore GR-63-CORE standards.
Vibration non-operating	Swept sine survey at an acceleration amplitude of 0.5 g from 5 to 50 Hz at a rate of 0.1 octaves/minute, and an acceleration amplitude of 3.0g from 50 to 500 Hz at a rate of 0.25 octaves/minute, on all three axes as per Bellcore GR-63-CORE standard.  2.2 Grms, 10 minutes per axis on all three axes as per the Intel Environmental Standards Handbook.
Shock operating	Half-sine 2 G, 11 ms pulse, 100 pulses in each direction, on each of the three axes as per the Intel Environmental Standards Handbook.
Shock non-operating	Trapezoidal, 25 G, 170-inch/sec delta V, three drops in each direction, on each of the three axes as per Intel Environmental Standards Handbook.
Electrostatic discharge (ESD)	Tested to ESD levels up to 15 kilovolts (kV) air discharge and up to 8 kV contact discharge without physical damage as per Intel Environmental Standards Handbook.
Acoustic	Sound pressure: < 55 dBA at ambient temperatures < 28 °C measured at bystander positions in operating mode.  Sound power: < 6.5 dBA at ambient temperatures < 28 °C in operating mode.

# Chassis Feature Location

## Front Panel

Figure 2 shows the front view of the system including the front panel. The front panel contains system control switches, alarm indicators and relays, and status indicators. Front panel controls and LEDs are summarized in Table 3.

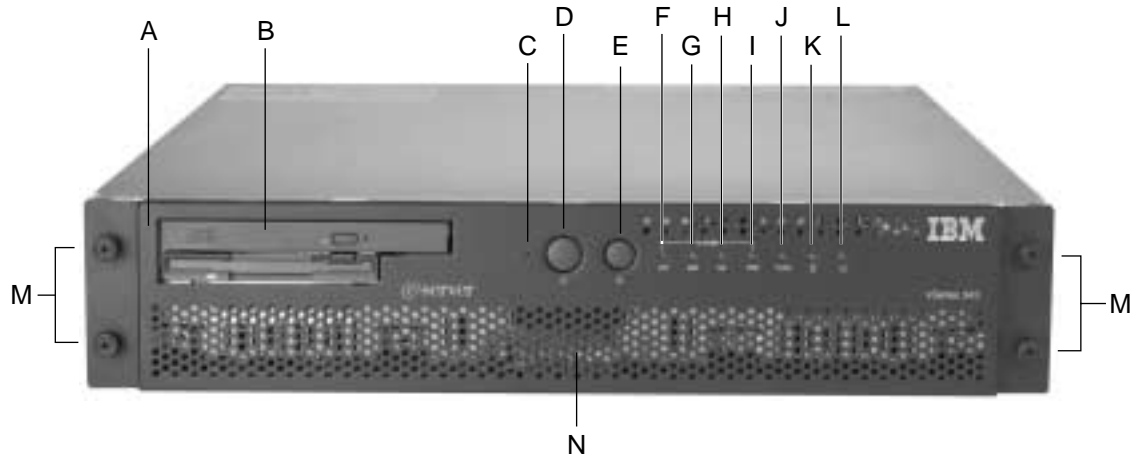

OM14188

A	Bezel	H	Alarm: MNR
B	Peripheral Bay	I	Alarm: PWR
C	NMI Switch	J	Status: NIC
D	Power Switch	K	Status: DSK
E	Reset Switch	L	Status: ON
F	Alarm: CRT	M	Bezel Removal Thumbscrews
G	Alarm: MJR	N	Hard Drive Tray

**Figure 2. Front Panel**

**Table 4. Front Panel Features**

Item	Feature	Description
<b>Front Panel Switches</b>		
C	NMI switch	A momentary contact switch used to instruct the processor to copy system memory to the hard drive. Pressing the recessed button with a paper clip or pin puts the server in a halt state for diagnostic purposes and allows you to issue a non-maskable interrupt. After issuing the interrupt, a memory dump can be performed to determine the cause of the problem.
D	Power switch	Toggles the system power on/off.
E	Reset switch	Reboots and initializes the system.
<b>Front Panel Alarm LEDs and Relays</b>		
F	Critical (amber)	When continuously lit, indicates the presence of a Critical System Fault. A critical system fault is an error or event that is detected by the system with a fatal impact to the system. In this case, the system cannot continue to operate. An example could be the loss of a large section of memory or other corruption that renders the system not operational. Additionally, the front panel critical alarm relay will engage.
G	Major (amber)	When continuously lit, indicates the presence of a Major System Fault. A major system fault is an error or event that is detected by the system that has discernable impact to system operation. In this case, the system can continue to operate but in a “degraded” fashion (reduced performance or loss of non-fatal feature reduction). An example could be the loss of one of two mirrored disks. Additionally, the front panel major alarm relay will engage.
H	Minor (amber)	When continuously lit, indicates the presence of a Minor System Fault. A minor system fault is an error or event that is detected by the system but has little impact to actual system operation. An example would be a correctable ECC error. Additionally, the front panel minor alarm relay will engage.
I	Power (amber)	When continuously lit, indicates the presence of a Power System Fault. Additionally, the front panel power alarm relay will engage.
<b>Front Panel Status LEDs</b>		
J	NIC activity LED (green)	Indicates NIC activity.
K	HDD activity LED (green)	Indicates any system SCSI hard drive activity.
L	Main power LED (green)	When continuously lit, indicates the presence of DC power in the server. The LED goes out when the power is turned off or the power source is disrupted. When it is blinking green, it indicates that the system is in ACPI sleep mode.

Figure 3 shows the front view of the system with the bezel removed.

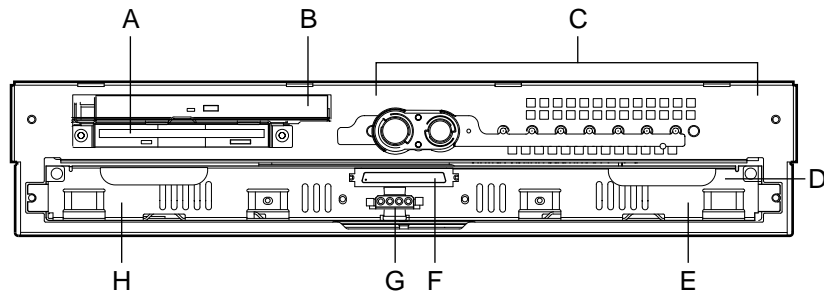

OM12817

- |   |                               |   |  |
|---|-------------------------------|---|--|
| A | Floppy Drive                  | E | Left SCSI Drive Bay                    |
| B | CD-ROM Drive                  | F | Hard Drive Tray Ribbon Cable Connector |
| C | Front Panel Switches and LEDs | G | Hard Drive Tray Power Connector        |
| D | Hard Drive Tray               | H | Right SCSI Drive Bay                   |

**Figure 3. Front View with Bezel Removed**



## Back Panel

Figure 4 shows the back panel view of the system.

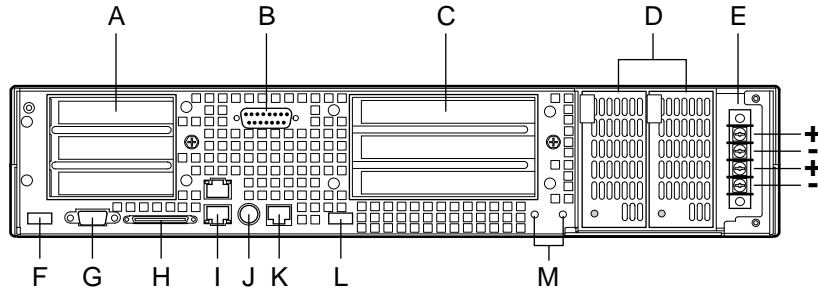

OM14192

**Figure 4. Back Panel**

**Table 5. Back Panel Features**

Item	Description
A	Three low profile, half-length 64-bit, 66 MHz PCI add-in board slots (3.3 V riser board)
B	DB-15 male connector for front panel alarm relay contacts
C	Three full height, full length 64-bit, 33 MHz PCI add-in board slots (5 V riser board)
D	Redundant, hot-plug power supplies
E	Four-terminal DC input power connector for DC input power supply cage
F	USB port 1
G	Video connector
H	External wide SCSI Ultra160 68-pin connector
I	Dual NIC 10/100 E/N RJ45 connectors NIC 1 (lower) and NIC 2 (upper)
J	The PS/2 port can accept both keyboard and mouse. Use the included “Y” splitter cable to connect a mouse and a keyboard to the PS/2 port at the same time.
K	Serial port (COM2), 8-pin RJ45 connector
L	USB port 0
M	Two grounding plugs for attachment of grounding wire to chassis

# Internal Chassis Features

Figure 5 shows the location of the server board's connectors and other components.

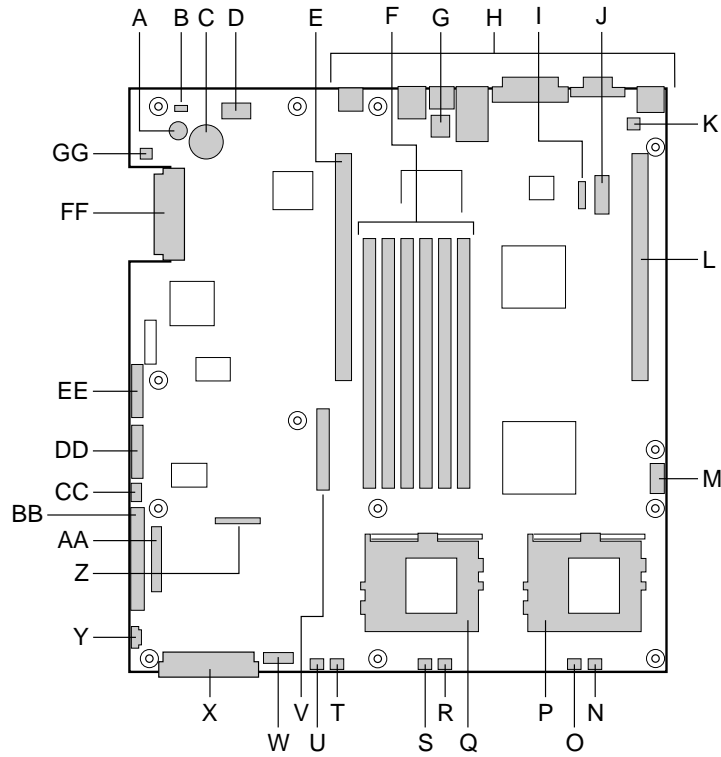

OM12815

- |   |  |    |                                    |
|---|--|----|------------------------------------|
| A | Speaker                                    | R  | Sys fan 2 connector                |
| B | ID LED                                     | S  | CPU 1 fan connector                |
| C | Battery                                    | T  | Sys fan 1 connector                |
| D | Diagnostic LEDs (POST code)                | U  | Aux fan connector                  |
| E | 66 MHz/64-bit PCI riser slot (full height) | V  | Floppy drive connector             |
| F | DIMM slots                                 | W  | Fan module connector               |
| G | DCD/DSR jumper block                       | X  | Main power connector               |
| H | I/O ports                                  | Y  | Auxiliary signal connector         |
| I | ICMB connector                             | Z  | Floppy/FP/IDE connector            |
| J | COM1 serial header                         | AA | Alternate front panel connector    |
| K | Chassis intrusion connector                | BB | ATA/IDE connector                  |
| L | 66 MHz/64-bit PCI riser slot (low profile) | CC | IPMB connector                     |
| M | USB 3 & 4 header                           | DD | SSI front panel connector          |
| N | Sys fan 3 connector                        | EE | Configuration jumper block         |
| O | CPU 2 fan connector                        | FF | SCSI connector (SCSI version only) |
| P | Secondary processor socket                 | GG | Hard Disk Drive LED header         |
| Q | Primary processor socket                   |    |                                    |

**Figure 5. Server Board Connector and Component Locations**

## Processor

The server board accommodates one or two Pentium III processors up to 1-26 GHz with 512k cache in the FC-PGA2 package.

## Memory

The system board contains six 168-pin DIMM slots each supporting 72-bit ECC (64-bit main memory plus ECC) registered SDRAM DIMMs (PC-133 compatible). You may install a minimum of 128 MB (64 MB x 2) and as much as 6 GB.

## Note

Use DIMMs that have been tested for compatibility with the server board. Contact your sales representative or dealer for a current list of approved memory modules.

## PCI Riser Slots

The server board has two PCI riser slots: a 5 V riser that supports 64-bit/33 MHz riser cards and a 3.3 V riser that supports 64-bit/66 MHz riser cards.

- Bus speed up to 66 MHz
- 32 bit memory addressing
- 5 V/3.3 V signaling environment
- Burst transfers of up to 512 Mbps
- 8, 16, 32, or 64-bit data transfers
- Plug and Play ready
- Parity enabled

## Video

The server board uses an ATI RAGE XL PCI graphics accelerator with 8 MB of video SDRAM that supports all standard IBM VGA modes. The embedded SVGA video subsystem supports:

- Pixel resolutions up to 1600 x 1200 under 2D and 1024 x 768 under 3D
- CRT and LCD monitors up to 100 Hz vertical refresh rate

The server board supports disabling of the onboard video through the BIOS setup menu or when a plug in video card is installed in any of the PCI slots.

## SCSI Controller

The SCSI version of the server board includes an embedded Adaptec AIC-7899W controller providing dual Ultra160 Low Voltage Differential (LVD) SCSI channels.

The SCSI bus is terminated on the server board with active terminators that cannot be disabled. The onboard device must always be at one end of the bus. The device at the other end of the cable is terminated with the active terminator on the SCSI cable installed in the system.

## Network Controller

### Note

To ensure EMC product regulation compliance for intra-building lighting surges, the system must only be used with shielded LAN cables that are grounded at both ends.

The server board uses two Intel 82550PM Fast Ethernet Controllers and supports two 10Base-T/100Base-TX network subsystems.

On the server board, NIC 1 can be used as both a network interface and server management interface.

### NIC Connector and Status LEDs

The 82550 controller drives LEDs on the network interface connector that indicate link/activity on the LAN and 10- or 100-Mbps operation. The green LED indicates network connection when on and TX/RX activity when blinking. The yellow LED indicates 100-Mbps operation when lit.

## Network Teaming Features

### Note

Using both on-board NICs in a team does not allow the use of NIC 1 for server management access. To support both network teaming features and server management features, a third NIC must be added and teamed to NIC 2.

The network controller provides several options for increasing throughput and fault tolerance when running Linux®:

- Adapter Fault Tolerance (AFT) - provides automatic redundancy for your adapter. If the primary adapter fails, the secondary takes over. AFT works with any hub or switch.
- Adaptive Load Balancing (ALB) - creates a team of 2 - 6 adapters to increase transmission throughput. Also includes AFT. Works with any 10Base-TX or 100Base-TX switch.
- Fast EtherChannel (FEC) or Intel Link Aggregation - creates a team of up to 6 adapters to increase transmission and reception throughput. Also includes AFT. Requires a FEC-enabled switch.

To set up an option, read the instructions in the Linux RH 7.1 readme files.

### Adapter Fault Tolerance

Adapter Fault Tolerance (AFT) is a simple, effective, and fail-safe approach to increase the reliability of server connections. AFT gives you the ability to set up link recovery to the server adapter in case of a cable, port, or network interface card failure. By assigning two server adapters as a team, AFT enables you to maintain uninterrupted network performance.

AFT is implemented with two server adapters: a primary adapter and a backup, or secondary, adapter. During normal operation, the backup will have transmit disabled. If the link to the primary adapter fails, the link to the backup adapter automatically takes over.

## Preferred Primary Adapter

With multiple adapters installed, you can specify one as the Preferred Primary adapter. For example if you have a server with a PRO/1000 server adapter as the primary adapter and a PRO/100+ adapter as the secondary, you could configure the PRO/1000 server adapter to be the preferred primary. In this scenario, if the PRO/1000 server adapter fails, the PRO/100+ will take over. Then when the PRO/1000 server adapter is replaced, it will automatically revert to being the primary adapter in the team.

If a Preferred Primary is not selected, PROSet will attempt to select the best adapter, based on adapter model and speed.

## Mixed Adapter Teaming

AFT supports up to six server adapters per team, in any mix.

## Adaptive Load Balancing

Adaptive Load Balancing (ALB) is a simple and efficient way to increase your server's transmit throughput. With ALB you group server adapters in teams to provide an increased transmit rate (up to 8 Gbps) using a maximum of eight adapters. The ALB software continuously analyzes transmit loading on each adapter and balances the rate across the adapters as needed. Adapter teams configured for ALB also provide the benefits of AFT. Receive rates remain at 100 Mbps or 1 Gbps depending on the primary adapter's capability.

To use ALB, you must have 2-6 server adapters installed in your server or workstation and linked to the same network switch.

## Cisco Fast EtherChannel

Fast EtherChannel (FEC) is a performance technology developed by Cisco to increase your server's throughput. Unlike ALB, FEC can be configured to increase both transmission and reception channels between your server and switch. FEC works only with FEC-enabled switches, such as the Catalyst 5000 series. With FEC, as you add adapters to your server, you can group them in teams to provide up to 18 Gbps at full duplex, with a maximum of 6 server adapters. The FEC software continuously analyzes loading on each adapter and balances network traffic across the adapters as needed. Adapter teams configured for FEC also provide the benefits of AFT.

To use FEC, you must have 2, 4, or 6 server adapters plus use of both onboard NIC adapters installed in your server and linked to the same FEC-enabled Cisco switch.

## Keyboard and Mouse

The keyboard controller is PS/2-compatible. If specified through the System Setup Utility (SSU), the server may be locked automatically if there is no keyboard or mouse activity for a predefined length of time. Once the inactivity (lockout) timer has expired, the keyboard and mouse do not respond until the previously stored password is entered. If a mouse is required, you can either connect a USB mouse to a USB port or a PS/2 mouse to the PS/2 port using the "Y"-splitter cable.

## RJ45 Serial Port

The rear RJ45 serial port is a fully functional COM port that supports any standard serial device and provides support for serial concentrators, which typically support RJ45 serial connectors. For server applications that use a serial concentrator to access the server management features of the baseboard, a standard 8-pin CAT-5 cable from the serial concentrator is plugged directly into the rear RJ45 serial port. The 8 pins of the RJ45 connector can be configured to match either of two pin-out standards used by serial port concentrators. To accommodate either standard, the J6A2 jumper block located directly behind the rear RJ45 serial port must be jumpered appropriately according to which standard is desired.

### Note

The RJ45 serial port's default configuration is DSR. For serial concentrators requiring a DCD signal, configure the jumper block as shown in Figure 39.

For serial concentrators that require a DCD signal, configure the J6A2 jumper block as shown in Figure 39.

For those server applications requiring a DB9 serial connector, use an 8-pin RJ45-to-DB9 adapter. Table 6 defines the pin-out required for the adapter to provide RS232 support.

**Table 6. Rear COM2 Port Adapter Pin-out**

RJ45	Signal	Abbreviation	DB9
1	Request to Send	RTS	7
2	Data Terminal Ready	DTR	4
3	Transmitted Data	TD	3
4	Signal Ground	SGND	5
5	Ring Indicator	RI	9
6	Received Data	RD	2
7	DCD or DSR	DCD/DSR	1 or 6
8	Clear To Send	CTS	8

### Note

The RJ45-to-DB9 adapter should match the configuration of the serial device used. One of two pin-out configurations are used depending on whether the serial device requires a DSR or DCD signal. The final adapter configuration should also match the desired pin-out of the RJ45 connector, as it can also be configured to support either DSR or DCD.

## ACPI

The server board supports the Advanced Configuration and Power Interface (ACPI) as defined by the ACPI 1.0 and PC97 specifications. An ACPI aware operating system can put the system into a state where the hard drives spin down, the system fans stop, and all processing is halted. However, the power supply will still be on and the processors will still be dissipating some power, so the power supply fans will still run.

The server board supports sleep states s0, s1, s4, and s5:

- s0: Normal running state.
- s1: Processor sleep state. No context will be lost in this state and the processor caches will maintain coherency.
- s4: Hibernate or Save to Disk: The memory and machine state are saved to disk. Pressing the power button or other wakeup event will restore the system state from the disk and resume normal operation. This assumes that no hardware changes have been made to the system while it was off.
- s5: Soft off: Only the RTC section of the CSB and the BMC are running in this state. No context is saved by the OS or hardware.

#### **Note**

The system is off only when the DC power cable is disconnected.

## **Security**

### **Software Locks**

The BIOS Setup and the System Setup Utility (SSU) provide a number of security features to prevent unauthorized or accidental access to the system. Once the security measures are enabled, you can access the system only after you enter the correct password(s). For example:

- Enable the keyboard lockout timer so that the server requires a password to reactivate the keyboard and mouse after a specified time out period—1 to 120 minutes.
- Set and enable a supervisor password.
- Set and enable a user password.
- Set secure mode to prevent keyboard or mouse input and to prevent use of the front panel reset and power switches.
- Activate a hot key combination to enter secure mode quickly.
- Disable writing to the diskette drive when secure mode is set.
- Disable access to the boot sector of the operating system hard disk drive.

### **Using Passwords**

You can set either the user password, the supervisor password, or both passwords.

If only the user password is set, you:

- Must enter the user password to enter BIOS Setup or the SSU.
- Must enter the user password to boot the server if Password on Boot is enabled in either the BIOS Setup or SSU.
- Must enter the user password to exit secure mode.

If only the supervisor password is set, you:

- Must enter the supervisor password to enter BIOS Setup or the SSU.
- Must enter the supervisor password to boot the server if Password on Boot is enabled in either the BIOS Setup or SSU.
- Must enter the supervisor password to exit secure mode.

If both passwords are set, you:

- May enter the user password to enter BIOS Setup or the SSU. However, you will not be able to change many of the options.
- Must enter the supervisor password if you want to enter BIOS Setup or the SSU and have access to all of the options.
- May enter either password to boot the server if Password on Boot is enabled in either the BIOS Setup or SSU.
- May enter either password to exit secure mode.

## Secure Mode

Configure and enable the secure boot mode by using the SSU. When secure mode is in effect:

- You can boot the server and the operating system will run, but you must enter the user password to use the keyboard or mouse.
- You cannot turn off system power or reset the server from the front panel switches.
- Secure mode has no effect on functions enabled via remote server management or power control via the watchdog timer.

Taking the server out of secure mode does not change the state of system power. That is, if you press and release the power switch while secure mode is in effect, the system will not be powered off when secure mode is later removed. However, if the front panel power switch remains depressed when secure mode is removed, the server will be powered off.

## Summary of Software Security Features

Table 7 lists the software security features and describes what protection each offers. In general, to enable or set the features listed here, you must run the SSU and go to the Security Subsystem Group, menu. The table also refers to other SSU menus and to the Setup utility.

**Table 7. Software Security Features**

Feature	Description
Secure mode	<p><b>How to enter secure mode:</b></p> <p>Setting and enabling passwords automatically places the system in secure mode. If you set a hot-key combination (through Setup), you can secure the system simply by pressing the key combination. This means you do not have to wait for the inactivity time-out period.</p> <p>When the system is in secure mode:</p> <p>The server can boot and run the operating system, but mouse and keyboard input is not accepted until the user password is entered.</p> <p>At boot time, if a CD is detected in the CD-ROM drive or a diskette in drive A, the system prompts for a password. When the password is entered, the server boots from CD or diskette and disables the secure mode.</p> <p>If there is no CD in the CD-ROM drive or diskette in drive A, the server boots from drive C and automatically goes into secure mode. All enabled secure mode features go into effect at boot time.</p> <p>To leave secure mode: Enter the correct password(s).</p>

continued



**Table 7. Software Security Features** (continued)

Feature	Description
Disable writing to diskette	<p>In secure mode, the server will not boot from or write to a diskette unless a password is entered.</p> <p>To write protect access to diskette whether the server is in secure mode or not, use the Setup main menu, Floppy Options, and specify Floppy Access as read only.</p>
<p>Set a time out period so that keyboard and mouse input are not accepted</p> <p>Also, screen can be blanked, and writes to diskette can be inhibited</p>	<p>Specify and enable an inactivity time out period of from 1 to 120 minutes.</p> <p>If no keyboard or mouse action occurs for the specified period, attempted keyboard and mouse input will not be accepted.</p> <p>The monitor display will go blank, and the diskette drive will be write protected (if these security features are enabled through Setup).</p> <p>To resume activity: Enter the correct password(s).</p>
Control access to using the SSU: set supervisor password	<p>To control access to setting or changing the system configuration, set a supervisor password and enable it through Setup.</p> <p>If both the supervisor and user passwords are enabled, either can be used to boot the server or enable the keyboard and/or mouse, but only the supervisor password will allow Setup to be changed.</p> <p>To disable a password, change it to a blank entry or press CTRL-D in the Change Password menu of the Supervisor Password Option menu found in the Security Subsystem Group.</p> <p>To clear the password if you cannot access Setup, change the Clear Password jumper (see Chapter 5).</p>
Control access to the system other than SSU: set user password	<p>To control access to using the system, set a user password and enable it through Setup.</p> <p>To disable a password, change it to a blank entry or press CTRL-D in the Change Password menu of the User Password Option menu found in the Security Subsystem Group.</p> <p>To clear the password if you cannot access Setup, change the Clear Password jumper (see Chapter 5).</p>
Boot without keyboard	The system can boot with or without a keyboard. During POST, before the system completes the boot sequence, the BIOS automatically detects and tests the keyboard if it is present and displays a message.
Specify the boot sequence	The sequence that you specify in setup will determine the boot order. If secure mode is enabled (a user password is set), then you will be prompted for a password before the server fully boots. If secure mode is enabled and the "Secure Boot Mode" option is also enabled, the server will fully boot but will require a password before accepting any keyboard or mouse input.

## Riser Boards

The server board includes two riser boards, a 5 Volt full height riser board, and a 3.3 Volt riser board. Features of the 5 Volt riser board include:

- Support for three 33 MHz 5 Volt 64-bit PCI add-in cards
- Provides 5 Volt to 3.3 Volt signal level translation

The 5 Volt riser board contains voltage level translation converting the 5 Volt PCI add-in card signals to conform to the server board, which has 3.3 Volt signaling levels. The board supports up to 50 W total with a limit of 25 Watts per slot. Figure 6 illustrates the 5 Volt riser board.



**Figure 6. 5 Volt Riser Board**

The 3.3 Volt riser board supports three 3.3 Volt 64-bit slots at 66 MHz. The board supports up to 30 W total power consumption. Figure 7 illustrates the 3.3 Volt riser board.

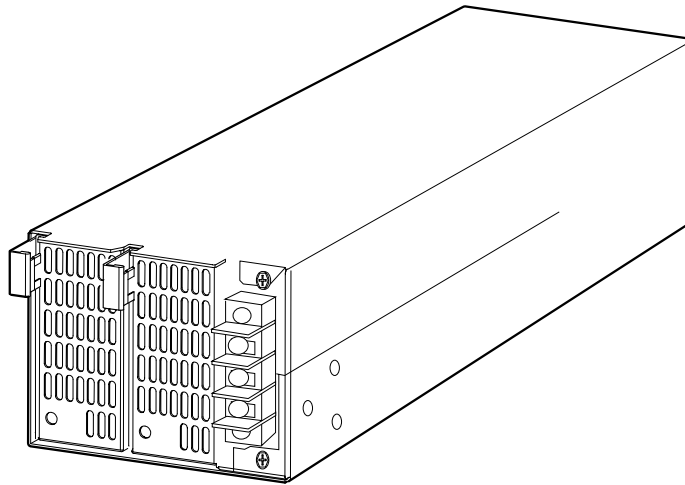

**Figure 7. 3.3 Volt Riser Board**

## Power Supplies

The power supply cage shown in Figure 8 is accessed from the rear of the chassis. The power supply cage supports up to two hot-swap 350 W DC input power supplies in a (1 + 1) redundant configuration. A power supply filler) for the empty power supply site is supplied for systems without redundancy.

The power supply is NEBS certified.



OM14224

**Figure 8. Non-redundant DC-Power Supply Subsystem (Filler Module shown at Left)**

## DC Power Subsystem

This section defines the features of the DC input switching power subsystem.

### Features

- 350 W output capability in full DC input voltage range
- “Power Good” indication LEDs
- Predictive failure warning
- Internal cooling fans with multi-speed capability
- Remote sense of 3.3 Volt, 5 Volt, and 12 Volt DC outputs
- “DC\_OK” circuitry for brown out protection and recovery
- Built-in load sharing capability
- Built-in overloading protection capability
- Onboard field replaceable unit (FRU) information
- I<sup>2</sup>C interface for server management functions
- Integral handle for insertion/extraction

## Introduction

The xSeries343 server system uses a -48 to -60 VDC input switching power subsystem, which provides up to 350 Watts with -48 to -60 VDC input and with current and remote sense regulation. The power subsystem consists of one or two 350-Watt power supply modules. A system with two modules forms a redundant, hot-swappable (1+1) power subsystem.

## Interface Requirements

### DC Input

The DC power source may produce hazardous voltage levels exceeding -60 VDC and high energy levels above 240VA that may cause electric shock or burns. All DC input connections should be made only by a qualified service person only to prevent injury. All wiring terminals connected to the DC input terminal block must be fully insulated with no exposed bare metal.

### DC Output Connectors

The power subsystem DC power and control signals are interfaced to the server system via wire harnesses when the power supply modules are inserted into the power subsystem enclosure. The safety ground pin of the power supply module is the first pin to connect and the last to disconnect when the module is being inserted or removed from the power subsystem housing. In addition to the 5 V Standby, -12 V, +3.3 V, +5 V and +12 V DC outputs, the following signals and output pins are included:

- +3.3 VDC remote sense
- +5 VDC remote sense
- +12 VDC remote sense
- Remote sense return
- Power Subsystem On (DC PWR enable)
- Power Good
- I<sup>2</sup>C\*

\* PS Failure, PS Presence, PS Predictive Fail, +12 V Mon, +5 V Mon, and the 5 V Standby rails failure are being monitored via an I<sup>2</sup>C interface chip.

## Power Supply Module LED Indicators

There is a single bi-color LED to indicate power supply status visible on the back of the system. Table 8 shows the conditions confirmed by the LED indicators.

**Table 8. LED Indicators**

Power Supply Condition	Power Supply LED
No DC power to all PSU	OFF
No DC power to this PSU only	AMBER
DC present / Only Standby Outputs On	BLINK GREEN
Power supply DC outputs ON and OK	GREEN
Power Supply in Alert Condition	BLINK AMBER
Power supply failure (OTP, OCP, OVP, UV)	AMBER

## DC Input Voltage Specification

The power supply will operate within all specified limits over the input voltage range outlined in Table 9. The power supply will power-off if the DC input is less than -34 V DC.

**Table 9. DC Input Rating**

Parameter	Minimum Tolerance	Nominal Rating	Maximum Tolerance <sup>1</sup>	Maximum Input Current
Voltage	-38 V DC	-48 to -60 V DC	-75 V DC	13.5 Amps

<sup>1</sup> Maximum input current is measured at the lowest input voltage that the power supply continues to operate. This is not to be used for determining agency input current markings.

## DC Output Current Specifications

The combined output power of all outputs will not exceed 350 W. Each output has a maximum and minimum current rating shown in Table 10. The power supply meets both static and dynamic voltage regulation requirements for the minimum dynamic loading conditions. The power supply meets only the static load voltage regulation requirements for the minimum static load conditions.

**Table 10. 350 W Load Ratings**

	+3.3 V	+5 V	+12 V	-12 V	5 V SB
PEAK (10sec)			30A		
MAX	20A	20A	25A	0.5A	1.5A
MIN DYNAMIC	2.0A	2.0A	1.5A	0A	0A
MIN STATIC	1A	1A	0A	0A	0A

Note: The maximum combined power of the 3.3 V and 5 V outputs is 150 W.

## Peripheral Bay

The peripheral bay consists of the following two bays for removable media:

- Low profile media bay 1 – for a ½-inch Floppy drive
- Low profile media bay 2 – for a ½-inch CD-ROM drive

## Hard Drive Tray

The hard drive tray supports two 3.5-inch x 1.0-inch Ultra160 SCSI hard disk drives (non-SCA). The hard drive tray is designed to accept 15 K RPM (and below) hard drives that consume up to 18 Watts of power.

## Cooling Subsystem

The cooling subsystem contains a fan array (as shown in Figure 9) consisting of two 80 x 38 mm fans and two 40 x 28 mm fans to cool the server board and other components. A fan failure is indicated by one of the fault LEDs located on the front panel.

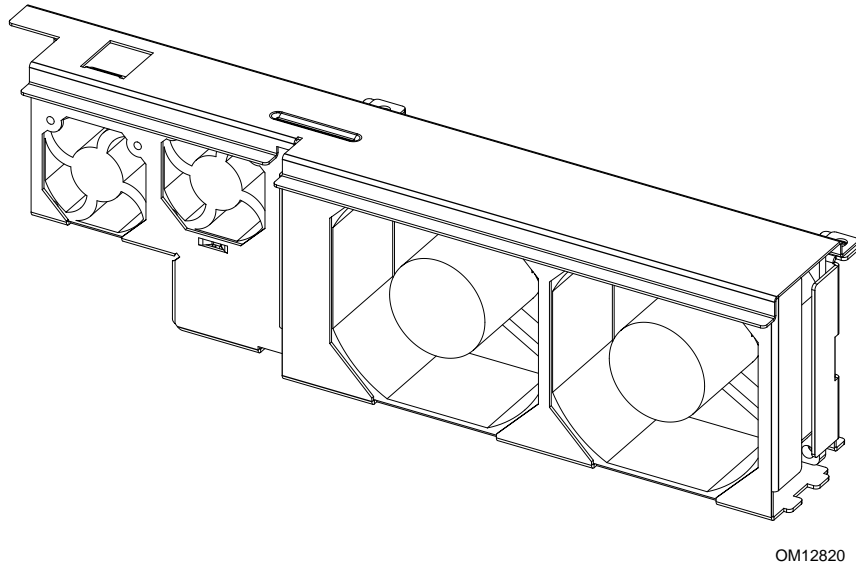

**Figure 9. Fan Array with Four System Fans Installed**

Air flows through the bezel, over the peripheral bay and the hard drive tray, passes through the fans, over the server board, and exhausts through the rear of the chassis.

Each fan provides a tachometer signal output to the server board to indicate a fan failure.

## Ambient Temperature Control

The server board contains a pulse-width-modulation (PWM) circuit, that cycles the 12 VDC fan voltage to provide quiet operation when system baseboard temperature is low, and there are no fan failures. Under normal baseboard temperature conditions (less than 45 °C), the fan power circuit supplies an effective fan voltage of 7.0 VDC. When the baseboard temperature exceeds 45 °C, the fan control circuit ceases cycling and delivers 12 VDC. Following a baseboard temperature excursion above 45 °C the fan voltage does not reenter PWM mode until the baseboard temperature drops below 45 °C and all fans are operational.

The cooling subsystem' design meets acoustic and thermal requirements at the lower fan speed settings. At the higher fan speed settings, thermal requirements are met for the maximum ambient temperatures but acoustic requirements are not met.

# Server Management Summary

The server board's server management architecture features a board management controller (BMC), which autonomously monitors server status and provides the interface to server management control functions. The BMC is responsible for controlling system power, resets, monitoring voltages, temperatures, fans, and communicating with secondary controllers on its Intelligent Platform Management Bus (IPMB).

The functions of each controller are summarized in the following sections.

## Server Board Management Controller

The BMC on the server board provides server management monitoring capabilities. Associated with the BMC is a flash memory that holds the operational code, sensor data records (SDR), and system event log (SEL). A serial EEPROM holds the BMC configuration defaults and field replaceable unit (FRU) information. The BMC supports the following:

- Server board voltage monitoring
- Fan failure detection
- Fan speed control
- Processor voltage monitoring
- Processor presence detection
- Processor internal error (IERR) monitoring
- Fault resilient booting (FRB)
- Processor disable control
- Watchdog timer
- Periodic system management interrupt (SMI) timer
- I<sup>2</sup>C master controller for the Intelligent Platform Management Bus (IPMB)
- Three private I<sup>2</sup>C management bus interfaces
- Server management software (SMS) and server management mode (SMM) IPMB message receiver
- Event message receiver
- System event log (SEL) management and access
- Sensor data record (SDR) repository management and access
- Processor nonmaskable interrupt (NMI) monitoring
- Processor SMI monitoring
- Time-stamp clock
- Secure mode, video blank, and floppy write protect
- Software front panel NMI generation





### 3 Regulatory Specifications and Disclaimers

---

#### Declaration of the Manufacturer or Importer

We hereby certify that this product is in compliance with European Union EMC Directive 89/336/EEC, using standards EN55022 (Class A) and EN55024 and Low Voltage Directive 73/23/EEC, Standard EN60950.

#### Safety Compliance

USA:	UL 1950 – 3rd Edition/CSA 22.2. No. 950-M93
Canada:	UL Certified – 3rd Edition/CSA 22.2. No. 950-M93 for Canada (product bears the single UL mark for U.S. and Canada)
Europe:	Low Voltage Directive, 73/23/EECTUV/GS to EN60950 2nd Edition with Amendments, A1 = A2 + A3 + A4
International:	TUV/CB to IEC 60950 3rd Edition, EN60 950 2nd Edition + Amd 1-4, EMKO-TSE (74-SEC) 207/94 plus international deviations
Australian / New Zealand:	CB Report to IEC 60950, 3rd Edition plus Australian deviations

#### Electronic Emission Notices

##### Federal Communications Commission (FCC) Statement

###### Note

This equipment has been tested and found to comply with the limits for a Class A digital device, pursuant to Part 15 of the FCC Rules. These limits are designed to provide reasonable protection against harmful interference when the equipment is operated in a commercial environment. This equipment generates, uses, and can radiate radio frequency energy and, if not installed and used in accordance with the instruction manual, may cause harmful interference to radio communications. Operation of this equipment in a residential area is likely to cause harmful interference, in which case the user will be required to correct the interference at his own expense.

Properly shielded and grounded cables and connectors must be used in order to meet FCC emission limits. IBM is not responsible for any radio or television interference caused by using other than recommended cables and connectors or by unauthorized changes or modifications to this equipment. Unauthorized changes or modifications could void the user's authority to operate the equipment.

This device complies with Part 15 of the FCC Rules. Operation is subject to the following two conditions: (1) this device may not cause harmful interference, and (2) this device must accept any interference received, including interference that may cause undesired operation.

## **Industry Canada Class A Emission Compliance Statement**

This Class A digital apparatus complies with Canadian ICES-003.

### **Avis de conformité à la réglementation d'Industrie Canada**

Cet appareil numérique de la classe A est conforme à la norme NMB-003 du Canada.

## **Australia and New Zealand Class A Statement**

**Attention:** This is a Class A product. In a domestic environment this product may cause radio interference in which case the user may be required to take adequate measures.

## **United Kingdom Telecommunications Safety Requirement**

### **Notice to Customers**

This apparatus is approved under approval number NS/G/1234/J/100003 for indirect connection to public telecommunication systems in the United Kingdom.

## **European Union EMC Directive Conformance Statement**

This product is in conformity with the protection requirements of EU Council Directive 89/336/EEC on the approximation of the laws of the Member States relating to electromagnetic compatibility. IBM cannot accept responsibility for any failure to satisfy the protection requirements resulting from a non recommended modification of the product, including the fitting of non-IBM option cards.

This product has been tested and found to comply with the limits for Class A Information Technology Equipment according to CISPR 22/European Standard EN 55022. The limits for Class A equipment were derived for commercial and industrial environments to provide reasonable protection against interference with licensed communication equipment.

**Attention:** This is a Class A product. In a domestic environment this product may cause radio interference in which case the user may be required to take adequate measures.

## German Union EMC Conformance Statement

Text für alle in Deutschland vertriebenen EN 55022 Klasse A Geräte:

Zulassungsbescheinigung laut dem Deutschen Gesetz über die elektromagnetische Verträglichkeit von Geräten (EMVG) vom 18. September 1998 (bzw. der EMC EG Richtlinie 89/336):

Dieses Gerät ist berechtigt in Übereinstimmung mit dem Deutschen EMVG das EG-Konformitätszeichen - CE - zu führen. Verantwortlich für die Konformitätserklärung nach Paragraph 5 des EMVG ist die:

IBM Deutschland GmbH, 70548 Stuttgart.

Informationen in Hinsicht EMVG Paragraph 4 Abs. (1) 4:

Das Gerät erfüllt die Schutzanforderungen nach EN 55024 und EN 55022 Klasse A.
--

EN 55022 Klasse A Geräte müssen mit folgendem Warnhinweis versehen werden:

"Warnung: dies ist eine Einrichtung der Klasse A. Diese Einrichtung kann im Wohnbereich Funkstörungen verursachen; in diesem Fall kann vom Betreiber verlangt werden, angemessene Maßnahmen durchzuführen und dafür aufzukommen." Anmerkung:

Um die Einhaltung des EMVG sicherzustellen sind die Geräte, wie in den IBM Handbüchern angegeben, zu installieren und zu betreiben.

## Taiwan Electrical Emission Statement

警告使用者：  
這是甲類的資訊產品，在居住的環境中使用時，可能會造成射頻干擾，在這種情況下，使用者會被要求採取某些適當的對策。

## Japanese Voluntary Control Council for Interference (VCCI) Statement

この装置は、情報処理装置等電波障害自主規制協議会（VCCI）の基準に基づくクラスA情報技術装置です。この装置を家庭環境で使用すると電波妨害を引き起こすことがあります。この場合には使用者が適切な対策を講ずるよう要求されることがあります。

## 4 Configuration Software and Utilities

---

This chapter describes the Power-On Self-Test (POST) and server configuration utilities. The table below briefly describes the utilities.

**Table 11. Configuration Utilities**

<b>Utility</b>	<b>Description and brief procedure</b>	<b>Page</b>
BIOS Setup	If the system does not have a diskette drive, or the drive is disabled or incorrectly configured, use Setup to enable it. Or, you can move the CMOS jumper on the server board from the default setting (Protect CMOS memory) to the Clear setting; this will allow most server configurations to boot. Then run the SSU to configure the server.	34
BIOS Upgrade Utility	Use to upgrade the BIOS.	45
System Setup Utility (SSU)	Use for viewing and clearing the system event log, viewing the system management FRU information, or viewing the system management SDR repository.	47
FRUSDR Load Utility	Use to update the Field Replacement Unit (FRU), Sensor Data Record (SDR), and SM BIOS (SMB) flash components.	52
Firmware Update Utility	Use to update the Firmware.	56
Using the Adaptec SCSI Utility	Use to configure or view the settings of the SCSI host adapter and onboard SCSI devices in the server.	57

## Using BIOS Setup

This section describes the BIOS Setup options. Use Setup to change the server configuration defaults. You can run Setup with or without an operating system being present. Setup stores most of the configuration values in battery backed CMOS; the rest of the values are stored in flash memory. The values take effect when you boot the server. POST uses these values to configure the hardware; if the values and the actual hardware do not agree, POST generates an error message. You must then run Setup to specify the correct configuration.

## Recording Your Setup Settings

If the default values ever need to be restored (after a CMOS clear, for example), you must run Setup again. Referring to the worksheets could make your task easier.

## If You Cannot Access Setup

If the diskette drive is incorrectly configured so that you cannot access it to run a utility from a diskette, you may need to clear CMOS memory. You will need to open the server, change a jumper setting, use Setup to check and set diskette drive options, and change the jumper back.

## Starting Setup

After rebooting, you will see this prompt:

```
Press <F2> to enter SETUP
```

### Note

If the BIOS setup option “POST Diagnostic Screen” is enabled (Default), you will not see the message “Press <F2> to enter SETUP”. This message is hidden by the Manufacturer’s Splash screen. To see the message, press the <ESC> key while the splash screen is displayed. This will temporarily disable the splash screen allowing you to see the message.

If CMOS/NVRAM is corrupted, you will see other prompts but not the <F2> prompt:

```
Warning:  cmos checksum invalid
```

```
Warning:  cmos time and date not set
```

In this condition, the BIOS will load default values for CMOS and attempt to boot.

## Setup Menu

To:	Press
Get general help	<F1> or <Alt+H>
Move between menus	← →
Go to the previous item	↑
Go to the next Item	↓
Change the value of an item	+ or -
Select an item or display a submenu	<Enter>
Leave a submenu or exit Setup	<Esc>
Reset to Setup defaults	<F9>
Save and exit Setup	<F10>

When you see this:	It means:
On screen, an option is shown but you cannot select it or move to that field.	You cannot change or configure the option in that menu screen. Either the option is auto-configured or auto-detected, or you must use a different Setup screen.
On screen, the phrase Press Enter appears next to the option.	Press <Enter> to display a submenu that is either a separate full screen menu or a popup menu with one or more choices.

The rest of this section lists the features that display onscreen after you press <F2> to enter Setup. Not all of the option choices are described, because (1) a few are not user selectable but are displayed for your information, and (2) many of the choices are relatively self-explanatory.

The BIOS Setup program menu bar is shown below.

Main	Advanced	Security	Server	Boot	Exit
Allocates resources for hardware components.	Configures advanced features available through the chipset.	Sets passwords and security features.	Selects serial port, LAN, and event log features. Also permits service boot.	Selects boot options and power supply controls.	Saves or discards changes to set program options.

## Main Menu

You can make the following selections on the Main Menu. Use the submenus indicated by “▶” for other selections.

Feature	Option	Description
System Time	HH:MM:SS	Sets the system time.
System Date	MM/DD/YYYY	Sets the system date.
Floppy A	Not installed <b>[1.44/1.25 MB 3 ½]</b> 2.88 MB 3 ½	Selects the diskette type. Note: The 1.25 MB 3 ½-inch references a 1024 Byte sector Japanese media format. Support for the 1.25, 3 ½-inch format requires a 3 ½ “3-mode” diskette drive.
Hard Disk Pre-Delay	<b>[Disabled]</b> 3 Seconds 6 Seconds 9 Seconds 12 Seconds 15 Seconds 21 Seconds 30 Seconds	Adds a delay before first access of the hard drive to accommodate slow spin-up hard disk drives.
▶ Primary IDE Master	<Enter>	Enters submenu.
▶ Primary IDE Slave	<Enter>	Enters submenu.
▶ Processor Settings	<Enter>	Enters submenu.
Language	<b>[English (US)]</b> Español (SP) Deutsch (DE) Italiano (IT) Français (FR)	Selects which language BIOS displays.

## Primary IDE Master and Primary IDE Slave Submenus

Feature	Option	Description
Type	None <b>[Auto]</b>	Select the type of device that is attached to the IDE channel. If you select User, you will need to enter the parameters of the IDE device (cylinders, heads and sectors).
LBA Mode Control	N/A	This field informational only.
Multi-Sector Transfers	N/A	This field informational only.
PIO Mode	N/A	This field informational only.
Ultra DMA	N/A	This field informational only.



## Processor Settings Submenu

Feature	Option	Description
Processor Type	N/A	This field is informational only.
Processor POST Speed	N/A	This field is informational only.
Processor Retest	<b>[Disabled]</b> Enabled	If enabled, BIOS will activate and retest all processors on the next system boot. Option automatically resets to Disabled on next system boot.
Processor 1 CPUID	N/A	This field is informational only.
Processor 1 L2 Cache	N/A	This field is informational only.
Processor 2 CPUID	N/A	This field is informational only.
Processor 2 L2 Cache	N/A	This field is informational only.

## Advanced Menu

You can make the following selections on the Advanced Menu itself. Use the submenus for the three other selections that appear on the Advanced Menu.

Feature	Option	Description
▶ PCI Configuration	<Enter>	Enters submenu.
▶ Peripheral Configuration	<Enter>	Enters submenu.
▶ Memory Configuration	<Enter>	Enters submenu.
▶ Advanced Chipset Control	<Enter>	Enters submenu.
Reset Configuration Data	Yes <b>[No]</b>	Select Yes if you want to clear the server configuration data during the next boot. The system automatically resets this field to No during the next boot.
Plug & Play O/S	Yes <b>[No]</b>	No, lets the BIOS configure all the devices in the system. Yes, lets the operating system configure Plug and Play (PnP) devices not required for boot if your system has a Plug and Play operating system.
Numlock	Off <b>[On]</b>	Switches Numlock on and off.

## PCI Configuration Submenu

Feature	Option	Description
USB Function	<Enter>	Enters submenu.
Onboard NIC 1	<Enter>	Enters submenu.
Onboard NIC 2	<Enter>	Enters submenu.
Onboard SCSI	<Enter>	Enters submenu.
Onboard Video	<Enter>	Enters submenu.
PCI Slot 1B ROM	<b>[Disabled]</b> Enabled	Full-Height PCI Riser Slot 1. Selects whether or not to load the Device's Option ROM. If the BIOS is reporting POST error 146, use this option to disable option ROMs that are not required to boot the system.
PCI Slot 2B ROM	<b>[Disabled]</b> Enabled	Full-Height PCI Riser Slot 2. Selects whether or not to load the Device's Option ROM. If the BIOS is reporting POST error 146, use this option to disable option ROMs that are not required to boot the system.
PCI Slot 3B ROM	<b>[Disabled]</b> Enabled	Full-Height PCI Riser Slot 3. Selects whether or not to load the Device's Option ROM. If the BIOS is reporting POST error 146, use this option to disable option ROMs that are not required to boot the system.
PCI Slot 1C ROM	<b>[Disabled]</b> Enabled	Low Profile PCI Riser Slot 1. Selects whether or not to load the Device's Option ROM. If the BIOS is reporting POST error 146, use this option to disable option ROMs that are not required to boot the system.
PCI Slot 2C ROM	<b>[Disabled]</b> Enabled	Low Profile PCI Riser Slot 2. Selects whether or not to load the Device's Option ROM. If the BIOS is reporting POST error 146, use this option to disable option ROMs that are not required to boot the system.
PCI Slot 3C ROM	<b>[Disabled]</b> Enabled	Low Profile PCI Riser Slot 3. Selects whether or not to load the Device's Option ROM. If the BIOS is reporting POST error 146, use this option to disable option ROMs that are not required to boot the system.

## USB Function Submenu

Feature	Option	Description
USB Function	<b>[Enabled]</b> Disable	Allows disabling the onboard USB ports.

## Onboard NIC 1 Function Submenu

Feature	Option	Description
Onboard NIC 1	<b>[Enabled]</b> Disable	Allows disabling onboard NIC 1 port.
Onboard NIC 1 ROM	<b>[Enabled]</b> Disable	Allows disabling onboard NIC 1 ROM.

## Onboard NIC 2 Function Submenu

Feature	Option	Description
Onboard NIC 2	<b>[Enabled]</b> Disable	Allows disabling onboard NIC 2 port.
Onboard NIC 2 ROM	<b>[Enabled]</b> Disable	Allows disabling onboard NIC 2 ROM.

## Onboard SCSI Function Submenu

Feature	Option	Description
Onboard SCSI	<b>[Enabled]</b> Disable	Allows disabling onboard SCSI port.
Onboard SCSI ROM	<b>[Enabled]</b> Disable	Allows disabling onboard SCSI ROM.

## Onboard Video Function Submenu

Feature	Option	Description
Onboard SCSI	<b>[Enabled]</b> Disable	Allows disabling onboard Video port.

## Security Menu

You can make the following selections on the Security Menu itself. Enabling the Supervisor Password field requires a password for entering Setup. The passwords are not case-sensitive.

Feature	Option	Description
User Password is	<b>[Not Installed]</b> Installed	This field is informational only.
Administrator Password is	<b>[Not Installed]</b> Installed	This field is informational only.
Set Administrator Password	<Enter>	Controls access to the setup utility. When the <Enter> key is pressed, you are prompted for a password, press the ESC key to abort. Once set, this can be cleared by setting it to a null string, or by using the clear-password jumper on server board.
Set User Password	<Enter>	Controls access to system boot. When the <Enter> key is pressed, you are prompted for a password, press the ESC key to abort. Also used to unlock the system when in the secure mode (secure mode is indicated by blinking keyboard lights). Once set, this can be cleared by setting it to a null string, or by using the clear-password jumper on server board.
User Access Level	<b>[Limited]</b> No access View Only Full	Limited: Allows access to certain fields only. No Access: Allows no access to change or view fields. View Only: Allows user to view fields but not change them. Full: Allows user to view and change all fields.

## Server Menu

Feature	Option	Description
▶ System Management	<Enter>	Enters the System Management submenu.
▶ Console Redirection	<Enter>	Enters the Console Redirection submenu.
▶ Event Log Configuration	<Enter>	Enters the Event Log Configuration submenu.
Service Boot	<b>[Disabled]</b> Enabled	Enables the Service Boot option. Option automatically resets to disabled on next system boot.
Assert NMI on PERR	<b>[Disabled]</b> Enabled	If enabled, NMI is generated. SERR option needs to be enabled to activate this option.
Assert NMI on SERR	<b>[Enabled]</b> Disabled	If enabled, NMI is generated on SERR and logged.
BMC IRQ	<b>[Disabled]</b> IRQ5 IRQ11	Sets the BMC IRQ.
After Power Failure	<b>[Last State]</b> Stays Off Power On	Determines the mode of operation if a power loss occurs.
Temperature Sensor	<b>[Disabled]</b> Enabled	If enabled, the system will not boot if the ambient temperature is outside the range specified in the SDR.
POST Error Pause	<b>[Enabled]</b> Disabled	If enabled, the system will wait for user intervention on critical POST errors. If disabled, the system will boot with no intervention, if possible.
Platform Event Filtering	<b>[Enabled]</b> Disabled	Enable/Disable trigger for system sensor events inside the BMC.

## System Management Submenu

Feature	Option	Description
Board Part Number	<b>[A46044-405]</b>	Field is informational only.
Board Serial Number	<b>[KKC212600176]</b>	Field is informational only.
System Part Number		Field is informational only.
System Serial Number		Field is informational only.
Chassis Part Number		Field is informational only.
Chassis Serial Number		Field is informational only.
BIOS Version		Field is informational only.
BMC Revision		Field is informational only.
HSBP Revision	<b>[ N/A ]</b>	Field is informational only.

## Console Redirection Submenu

Feature	Option	Description
Serial Console Redirection	<b>[Disabled]</b> Enabled	
Serial Port	<b>[COM1 3F8 IRQ4]</b> COM2 2F8 IRQ3 COM3 3E8 IRQ4	
Baud Rate	9600 <b>[19.2K]</b> 38.4K 115.2K	Selects the serial port's baud rate.
Flow Control	No Flow Control <b>[CTS/RTS]</b> XON / XOFF CTS / RTS + CD	Hardware control. Software control. Hardware + Carrier Detect (for Modem use).

## Event Log Configuration Submenu

Feature	Option	Description
Clear All Event Logs	<b>[No]</b> Yes	Allows user to clear all event logs. Setting to Yes will clear the DMI event log after system boot.
Event Logging	Disabled <b>[Enabled]</b>	Allows user to log DMI events.
Critical Event Logging	Disabled <b>[Enabled]</b>	Allows user to enable critical error event logging. Critical errors are fatal to system operation. They include PERR, SERR, ECC memory errors, and NMI.

## Boot Menu

Feature	Option	Description
Quiet Boot	Disabled <b>[Enabled]</b>	Disabled displays normal POST messages. Enabled displays OEM logo and disables serial redirection.
▶ Boot Device Priority	<Enter>	Enters submenu.
▶ Hard Disk Drives	<Enter>	Enters submenu.
▶ Removable Devices	<Enter>	Enters submenu.
▶ ATAPI CDROM Drives	<Enter>	Enters submenu.

### Boot Device Priority Submenu

Use the up or down arrow keys to select a device; then press the <+> or <-> keys to move the device higher or lower in the boot priority list.

Boot Priority	Device Option	Description
1 <sup>st</sup> Boot Device	<b>[Removable Device]</b> Hard Drive ATAPI CDROM Intel (R) Boot Agent Ve Intel (R) Boot Agent Ve Disabled	Attempts to boot from the diskette drive.
2 <sup>nd</sup> Boot Device	Removable Device <b>[Hard Drive]</b> ATAPI CDROM Intel (R) Boot Agent Ve Intel (R) Boot Agent Ve Disabled	Attempts to boot from a hard disk drive.
3 <sup>rd</sup> Boot Device	Removable Device Hard Drive <b>[ATAPI CDROM]</b> Intel (R) Boot Agent Ve Intel (R) Boot Agent Ve Disabled	Attempts to boot from the CD-ROM drive.
4 <sup>th</sup> Boot Device	Removable Device Hard Drive ATAPI CDROM <b>[Intel (R) Boot Agent Ve]</b> Intel (R) Boot Agent Ve Disabled	Attempts to boot from a network connection. Requires the presence of a PXE server.
5 <sup>th</sup> Boot Device	Removable Device Hard Drive ATAPI CDROM Intel (R) Boot Agent Ve <b>[Intel (R) Boot Agent Ve]</b> Disabled	Attempts to boot from a network connection. Requires the presence of a PXE server.

## Hard Disk Drives Submenu

Choices	Description
1st Hard Drive	[AIC 7899,B:06 IBM DPSS]

## Removable Devices Submenu

Choices	Description
1st Removable Device	[1 <sup>st</sup> Floppy Drive]

## ATAPI CD-ROM Drives Submenu

Choices	Description
1st ATAPI CDROM	[SR243T]

## Exit Menu

You can make the following selections on the Exit Menu. Select an option using the up or down arrow keys; then press <Enter> to execute the option. Pressing <Esc> does not exit this menu. You must select one of the items from the menu or menu bar to exit.

Feature	Option	Description
▶ Exit Saving Changes	Yes No	Exits after writing all modified Setup item values to NVRAM.
▶ Exit Discarding Change	Yes No	Exits leaving NVRAM unmodified.
▶ Load Setup Defaults	Yes No	Loads default values for all Setup items.
▶ Load Custom Defaults	Yes No	Loads values of all Setup items from previously saved custom defaults.
▶ Save Custom Defaults	Yes No	Writes all Setup item values to NVRAM.
▶ Discard Changes	Yes No	Exits discarding changes.

# Upgrading the BIOS

## Preparing for the Upgrade

Before you upgrade the BIOS, prepare for the upgrade by recording the current BIOS settings, obtaining the upgrade utility, and making a copy of the current BIOS.

### Recording the Current BIOS Settings

1. Boot the computer and press <F2> when you see the message:  
`Press <F2> Key if you want to run SETUP`
2. Write down the current settings in the BIOS Setup program.

#### Note

Do not skip step 2. You will need these settings to configure your computer at the end of the procedure.

### Obtaining the Upgrade Utility

You can upgrade to a new version of the BIOS using the new BIOS files and the BIOS upgrade utility, IFLASH.EXE. You can obtain the BIOS upgrade file and the IFLASH.EXE utility through your computer supplier or from the IBM Customer Support website at <http://www.ibm.com/pc/support>.

#### Note

Please review the instructions distributed with the upgrade utility before attempting a BIOS upgrade.

This upgrade utility allows you to:

- Upgrade the BIOS in flash memory.
- Update the language section of the BIOS.

The following steps explain how to upgrade the BIOS.



## Creating the BIOS Upgrade Diskette

The BIOS upgrade file is a compressed self-extracting archive that contains the files you need to upgrade the BIOS.

1. Insert the bootable diskette into the diskette drive.
2. Extract the contents of the BIOS.EXE file onto the bootable diskette. To do this, simply type the filename (with or without the extension) at the a:\ prompt, for example “BIOS.EXE”.
3. You will be prompted to confirm a folder in which to store the extracted files. The BIOS upgrade image is extracted in the specified folder.

## Upgrading the BIOS

1. Place the bootable diskette containing the BIOS update files into the diskette drive of your system. Boot the system with the diskette in the drive.
2. At this point you have a choice of two options. Press 1 and ENTER to automatically update the system BIOS. This will update the system BIOS and reset the system. Press 2 and ENTER to update the User Binary and reset the system.
3. Wait while the BIOS files are updated. Do not power down the system during the BIOS update process! The system will reset automatically when the BIOS update process is completed. Remove the diskette from the diskette drive.
4. Check to make sure the BIOS version displayed during POST is the new version as the system reboots.
5. Enter Setup by pressing the F2 key during boot. Once in Setup, press the F9 and ENTER to set the parameters back to default values.
6. Re-enter the values you wrote down at the beginning of this process. Press F10 and ENTER to exit BIOS Setup and Save Changes.
7. If you do not set the CMOS values back to defaults using the F9 key, the system may function erratically.

### Note

You may encounter a CMOS Checksum error or other problem after reboot. Try shutting down the system and booting up again. CMOS checksum errors require that you enter Setup, check your settings, save your settings, and exit Setup.

## Recovering the BIOS

It is unlikely that anything will interrupt the BIOS upgrade; however, if an interruption occurs, the BIOS could be damaged. The following steps explain how to recover the BIOS if an upgrade fails.

### Note

Because of the small amount of code available in the non-erasable boot block area, there is no video support. You will not see anything on the screen during the procedure. Monitor the procedure by listening to the speaker.

You **must** boot to DOS. The BIOS recovery diskette will not be created correctly under the DOS window of a Windows operating system.

1. Get the BIOS update file package from IBM iBL or <http://www.ibm.com/pc/support>.
2. A file called “crisis.zip” is one of the files included with each xSeries 343 BIOS release file package. Unzip the “crisis.zip” file to a directory on your hard drive.
3. Format a blank diskette (the diskette should not be a bootable DOS diskette). Insert the diskette into the diskette drive.
4. From the DOS, run the “crisdisk.bat” file from the directory you created on your hard drive. Follow the instructions on the screen to create the BIOS recovery diskette.

### Note

The BIOS recovery diskette will not be created correctly under the DOS window of a Windows operating system. You must boot to a DOS system to create the BIOS recovery diskette.

5. Power off the xSeries 343 system, unplug/disconnect the power cord, and remove the chassis panel.
6. Remove the spare jumper from pins 11-12 on jumper block 1J15 and install it on pins 9-10 (BIOS Recovery) of jumper block 1J15.
7. Insert the BIOS recovery diskette into the diskette drive.
8. Reinstall the chassis panel, plug-in/reconnect the power connection, and power-on the system.
9. The screen will remain blank while the BIOS Recovery is performed. A number of beeps will occur during the BIOS update. The diskette drive access light will not turn off when the BIOS recovery is completed. Allow four minutes for the BIOS recovery to complete. If a POST card is installed in a PCI slot during the BIOS recovery, you can tell that the BIOS recovery is complete when code “EC” is displayed. When the BIOS Recovery is complete, it is safe to power off the system.
10. Power off the system, unplug/disconnect the power cord, and remove the chassis panel.
11. Remove the BIOS Recovery jumper from pins 9-10 and store the jumper on pins 11-12.
12. Replace the chassis panel; plug in the power cord(s), and power on the system.
13. Perform a CMOS clear following the BIOS recovery.

## Changing the BIOS Language

You can use the BIOS upgrade utility to change the language the BIOS uses for messages and the Setup program. Use a bootable diskette containing the Intel Flash Utility and language files.

1. Boot the computer with the bootable diskette in drive A. The BIOS upgrade utility screen appears.
2. Select Update Flash Memory From a File.
3. Select Update Language Set. Press <Enter>.
4. Select drive A and use the arrow keys to select the correct .lng file. Press <Enter>.
5. When the utility asks for confirmation that you want to flash the new language into memory, select Continue with Programming. Press <Enter>.
6. When the utility displays the message `upgrade is complete`, remove the diskette. Press <Enter>.

The computer will reboot and the changes will take effect.

## Using the System Setup Utility

The System Setup Utility (SSU) is on the *Documentation and Resource CD* shipped with the server board. The SSU provides a graphical user interface (GUI) over an extensible framework for server configuration. The SSU framework supports the following functions and capabilities:

- Allows viewing and clearing of the system's critical event log
- Allows the viewing of the system management FRU information
- Allows the viewing of the system management SDR repository

## What You Need to Do

The SSU may be run directly from the *Documentation and Resource CD* (by booting the server system to the CD and selecting "Utilities") or from a set of DOS diskettes.

If you choose to run the SSU from a set of DOS diskettes, you must create the SSU diskettes from the *Documentation and Resource CD* by booting to the CD and selecting "Create Diskettes." Alternatively, if you have a Windows 95 or Windows NT workstation, you can insert the CD into that system and create diskettes from the "Utilities" menu of the graphical user interface.

If your diskette drive is disabled, or improperly configured, you must use the flash resident Setup utility to enable it so that you can use the SSU. If necessary, you can disable the drive after you exit the SSU. Information entered using the SSU overrides any entered using Setup.

## Running the SSU from the CD

Running the `ssu.bat` file provided on the SSU media starts the SSU. If the server boots directly from the SSU media, the `ssu.bat` file is automatically run. If it boots from a different media, the SSU can be started manually or by another application. When the SSU starts in the local execution mode (the default mode), the SSU accepts input from the keyboard and/or mouse. The SSU presents a VGA based Graphical User Interface (GUI) on the primary monitor.

The SSU runs from writable, non-writable, removable, and non-removable media. If the SSU is run from non-writable media, user preference settings (such as screen colors) cannot be saved.

The SSU supports the ROM-DOS V6.22 operating system. It may run on other ROM-DOS-compatible operating systems but they are not supported. The SSU will not operate from a “DOS box” running under an operating system such as Windows.

## Running the SSU Remotely via an Emergency Management Card

Using graphical hardware redirection via the emergency management card 2, you can see the SSU Console in VGA graphics mode, control the mouse, and control the keyboard from a local system connected to a remote server by a network or modem.

The emergency management card 2 provides video memory, keyboard, and mouse redirection support. Video memory and user input are sent to a remote location through either a modem or Ethernet link and displayed by the Remote Control console. This solution requires an emergency management card 2 card installed in the remote server and the Remote Control software available on the local system. The SSU will execute exclusively on the remote server. Any files required for the SSU to execute must be on the remote server.

## Starting the SSU

SSU consists of a collection of task-oriented modules plugged into a common framework called the Application Framework (AF). The Application Framework provides a launching point for individual tasks and a location for setting customization information. The SSU requires the availability of the AF.INI, AF.HLP, plus any .ADN files and their associated .HLP and .INI files.

1. **After creating set of three SSU diskettes from the CD:** Insert the first SSU diskette in drive A, and press the reset button or <Ctrl+Alt+Del> to reboot your server from the diskette. Insert the second diskette when prompted.
2. **Directly from the *Documentation and Resource CD*:** Insert the Documentation and Resource CD into your CD ROM drive and press the reset button or <Ctrl-Alt-Del> to reboot. When prompted to do so, press <F2> to enter BIOS Setup. From the Boot Menu, select the Boot Device Priority option and then select CD-ROM as your primary boot device. Save those settings and exit BIOS Setup. The server will boot from the CD-ROM and display a menu of options. Follow the instructions in the menu to start the SSU.
3. When the SSU title appears on the screen, press <Enter> to continue.
4. The mouse driver loads if it is available; press <Enter> to continue.
5. This message appears:  

```
Please wait while the Application Framework loads....
```
6. When the main window of the SSU appears, you can customize the user interface before continuing.

## Customizing the SSU

The SSU lets you customize the user interface according to your preferences. The AF sets these preferences and saves them in the AF.INI file so that they take effect the next time you start the SSU. There are four user customizable settings:

- **Color:** This button lets you change the default colors associated with different items on the screen with predefined color combinations. The color changes are instantaneous.
- **Mode:** This button lets you set the desired expertise level.
  - Novice
  - Intermediate
  - Expert

The expertise level determines which tasks are visible in the Available Tasks section and what action each task performs. For a new mode setting to take effect, you must exit the SSU and restart it.

- **Language:** This button lets you change the strings in the SSU to strings of the appropriate language. For a new language setting to take effect, you must exit the SSU and restart it.
- **Other:** This button lets you change other miscellaneous options in the SSU. The changes take effect immediately.

### To change the interface default values:

Use the mouse to click on the proper button in the Preferences section of the SSU Main window,

Or,

Use the tab and arrow keys to highlight the desired button, and press the spacebar or <Enter>,

Or,

Access the menu bar with the mouse or hot keys (Alt + underlined letter).

### Note

If you run the SSU from non-writable media (like a CD-ROM), these preferences will be lost when you exit the SSU.

## Launching a Task

It is possible to have many tasks open at the same time, although some tasks may require complete control to avoid possible conflicts. The tasks achieve complete control by keeping the task as the center of operation until you close the task window.

### To launch a task:

In the SSU Main window, double-click on the task name under Available Tasks to display the main window for the selected task.

Or,

Highlight the task name, and click on OK.

Or,

Use the tab and arrow keys to highlight the desired button, and press the spacebar or <Enter>.

## SEL Manager Add-in

Clicking on the SEL Manager Add-in task brings up the Server Event Log (SEL) viewer. You can load and view the current SEL data stored in the BMC, save the currently loaded SEL data to a file, view previously saved SEL data, or clear the SEL.

When the SEL Manager is first invoked, it loads the System Event Log entries from the server. If there are no SEL entries, a message box is displayed.

The SEL Manager main window is based on a multi-column format. All SEL entries are displayed in this window, one system event per row. Each column can be sorted by clicking on the column heading. The event number is tied to the particular event even if any other column sorts the list. The following keyboard keys are used to scroll the event columns. The F4 key shifts the event columns left, while the F5 key shifts the event columns right.

The SEL Manager has the following menus:

### File Menu

The File menu has the following options:

- **Open** Opens an SEL data file for viewing.
- **Save As...** Saves the currently loaded SEL data to a file.
- **Exit** Quits the SEL Viewer.

### SEL Menu

The SEL menu has the following options:

- **Properties** Displays information about the SEL. These fields are display only.
- **Clear SEL** Clears the SEL entries from the NV storage area and from the SEL Manager main window.
- **Reload** Reloads the SEL entries from the NV storage area.

### Help

The Help menu has the following option:

- **Help Topics** Displays the help information for the SEL Manager Add-in.

## SDR Manager Add-in

Clicking on the SDR Manager Add-in task brings up the Sensor Data Record (SDR) viewer. You can load and view the current SDR data stored in the NV storage area, save the currently loaded SDR data to a file, or view previously saved SDR data. The SDR Manager main window provides access to all the features of the add-in through menus. The F4 key shifts the SDR columns left, while the F5 key shifts the SDR columns right.

The SDR Viewer has the following menus:

### File Menu

The File menu has the following options:

- **Open:** Opens an SDR data file for viewing.
- **Save As:** Saves the currently loaded SDR data to a file.
- **Exit:** Quits the SDR Viewer.

### SDR Menu

The SDR menu has the following options:

- **Properties:** Displays SDR information from the BMC. These fields are display only.
- **Reload:** Reloads the SDR entries from the server.

### Help

The Help menu has the following option:

**Help Topics:** Displays the help information for the SDR Manager Add-in.

## FRU Manager Add-in

Clicking on the FRU Manager Add-in task brings up the Field Replacement Unit (FRU) viewer. You can load and view the current FRU data stored in the NV storage area, save the currently loaded FRU data to a file, or view previously saved FRU data. The FRU Manager main window provides access to all the features of the add-in through menus. The F4 key shifts the FRU columns left, while the F5 key shifts the FRU columns right.

The FRU Viewer has the following menus:

## File Menu

The File menu has the following options:

- **Open:** Opens an FRU data file for viewing.
- **Save As:** Saves the currently loaded FRU data to a file.
- **Exit:** Quits the FRU Viewer.

## FRU Menu

The FRU menu has the following options:

- **Properties:** Displays FRU information from the BMC. These fields are display only.
- **Reload:** Reloads the FRU entries from the server.

## Help

The Help menu has the following option:

- **Help Topics:** Displays the help information for the FRU Manager Add-in.

## Exiting the SSU

Exiting the SSU causes all windows to close.

- Exit the SSU by opening the menu bar item **F**ile in the SSU Main window.
- Click on Exit,  
Or,
- Highlight Exit, and press <Enter>.

## FRU/SDR Load Utility

The Field Replacement Unit (FRU) and Sensor Data Record (SDR) Load Utility is a DOS-based program used to update the server management subsystem's product level FRU, SDR, and the SM BIOS (SMB) nonvolatile storage components (EEPROMs). The load utility:

- Discovers the product configuration based on instructions in a master configuration file
- Displays the FRU information
- Updates the nonvolatile storage device (EEPROM) associated with the Baseboard Management Controller (BMC) that holds the SDR and FRU area
- Updates the SMB area located in the BIOS nonvolatile storage device
- Generically handles FRU devices that may not be associated with the BMC



## When to Run the FRU/SDR Load Utility

You should run the FRU/SDR Load Utility each time you upgrade or replace the hardware in your server, excluding add-in boards, hard drives, and RAM. For example, when you upgrade your processor or add a second power module to the 1+1 power supply.

Because the firmware must reload to properly initialize the sensors after programming, turn the server off and unplug/disconnect the power cords from the server. Wait approximately 30 seconds, and plug-in/reconnect the power cords.

## What You Need to Do

The FRU/SDR Load Utility may be run directly from the *Documentation and Resource CD* or from a diskette you create from the CD. It can be extracted from the CD by booting to the CD and selecting “Make Diskettes” or by inserting the CD into a PC running Windows 95 or NT and selecting the “Utilities” section.

### Note

If your diskette drive is disabled, or improperly configured, you must use BIOS Setup to enable it. If necessary, you can disable the drive after you are done with the FRU/SDR utility.

## How You Use the FRU/SDR Load Utility

This utility is compatible with ROM-DOS Version 6.22, MS-DOS Version 6.22, and later versions. The utility accepts CFG, SDR and FRU load files. The executable file for the utility is frusdr.exe. The utility requires the following supporting files:

- One or more .fru files describing the system’s field replaceable units
- A .cfg file describing the system configuration
- A .sdr file describing the sensors in the system

## Command Line Format

The basic command line format is

```
frusdr [/?] [/h] [/d {smb, fru, sdr}] [/cfg filename.cfg] /p
```

Command	Description
frusdr	Is the name of the utility
/? Or /h	Displays usage information
/d {smb, fru, sdr}	Only displays requested area
/cfg filename.cfg	Uses custom CFG file
/p	Pause between blocks of data

## Parsing the Command Line

The FRU/SDR Load Utility allows only one command line function at a time. A command line function may consist of two parameters; for example: `cfg filename.cfg`. Any invalid parameters result in displaying an error message and exiting the program. You can use either a slash (/) or a minus sign (-) to specify command line options. The /p flag may be used in conjunction with any of the other options.

## Displaying Usage Information

When the utility is run with the /? or /h command line flags, the following message is displayed:

```
FRU & SDR Load Utility Version X.XX

Usage:  Frusdr                Is the name of the utility.
        /? Or /h              Displays usage information.
        /d {smb,fru,sdr}     Only displays requested area.
        /cfg filename.cfg    Uses custom CFG file.
        /p                    Pause between blocks of data.
```

## Displaying a Given Area

When the utility is run with the /d SMB, /d FRU, or /d SDR command line flag, the indicated area is displayed. Each area represents a sensor; one sensor for each instrumented device in the server. If the given display function fails because of an inability to parse the data present or a hardware failure, the utility displays an error message and exits.

### Displaying SM BIOS Area

The SM BIOS area is displayed in ASCII format when the field is ASCII or as a number when the field is a number. Each SM BIOS area displayed is headed with the SM BIOS area designated name. Each field has a field name header followed by the field in ASCII or as a number.

### Displaying FRU Area

The FRU area is displayed in ASCII format when the field is ASCII or as a number when the field is a number. Each FRU area displayed is headed with the FRU area designated name. Each field has a field name header followed by the field in ASCII or as a number. The Board, Chassis, and Product FRU areas end with an END OF FIELDS CODE that indicates there is no more data in this area. The Internal Use area is displayed in hex format, 16 bytes per line.

### Displaying SDR Area

The SDR nonvolatile storage area is displayed in the following hex format. A Sensor Record Number X header separates the data; where X is the number of that sensor record in the SDR area. The next line after the header is the sensor record data in hex format delineated by spaces. Each line holds up to 16 bytes. The data on each line is followed by the same data in ASCII format; nonprintable characters are substituted by a period (.).

## Using Specified CFG File

The utility can be run with the command line parameter of `-cfg filename.cfg`. The filename can be any DOS accepted, eight-character filename string. The utility loads the specified CFG file and uses the entries in the configuration file to probe the hardware and to select the proper SDRs to load into nonvolatile storage.

## Displaying Utility Title and Version

The utility displays its title :

```
FRU & SDR Load Utility, Version X.XX
```

Where X.XX is the revision number for the utility.

## Configuration File

The configuration file is in ASCII text. The utility executes commands formed by the strings present in the configuration file. These commands cause the utility to perform various tasks needed to ultimately load the proper SDRs into the nonvolatile storage of the BMC and possibly generic FRU devices. Some of the commands may be interactive and require you to make a choice.

## Prompting for Product Level FRU Information

Through the use of a Configuration File, the utility may prompt you for FRU information.

## Filtering Sensor Data Record From the SDR File

The MASTER.SDR file has all the possible SDRs for the system. These records may need to be filtered based on the current product configuration. The configuration file directs the filtering of the SDRs.

## Updating the SDR Nonvolatile Storage Area

After the utility validates the header area of the supplied SDR file, it updates the SDR repository area. Before programming, the utility clears the SDR repository area. The SDR file is loaded via the .cfg File. Then the utility filters all tagged SDRs depending on the product configuration set in the Configuration File. Non-tagged SDRs are automatically programmed. The utility also copies all written SDRs to the SDR.TMP file. It contains an image of what was loaded, and the TMP file is also useful for debugging the server.

## Updating FRU Nonvolatile Storage Area

After the configuration is determined, the utility updates the FRU nonvolatile storage area. First it verifies the Common Header area and checksum from the specified FRU file. The Internal Use Area is read out of the specified .FRU file and is programmed into the nonvolatile storage. The Chassis, Board, Product and MultiRecord areas are read out of the specified .FRU file, if they exist, then those areas are programmed into the FRU nonvolatile storage. All the areas are also written to the FRU.TMP file, which is useful for debugging the server.

## Updating SMB FRU Nonvolatile Storage Area

After programming the BMC FRU area, the corresponding SMB fields are automatically updated when the server is re-booted.

## Cleaning Up and Exiting

If an update was successfully performed, the utility displays an appropriate message and then exits with a DOS exit code of zero.

If the utility fails, it immediately exits with an error message and a non-zero DOS exit code.

## Using the Firmware Update Utility

The Firmware Update Utility is a DOS-based program used to update the Baseboard Management Controller's firmware code. You only need to run the Firmware Update Utility if new firmware code becomes necessary.

## Making a BMC Firmware Update Diskette

1. Place a formatted diskette into the diskette drive.
2. Extract the contents of the TSRLT2\_BMC\_FW.EXE file onto the diskette. There is no need to make the diskette bootable; this is done automatically when the files are extracted to the diskette.

## Updating the BMC Firmware

1. Place the diskette containing the BMC Firmware update files into the diskette drive of your system. Boot the system while the diskette is in the drive.
2. The following prompt will appear:
  1. Single Fault LED (v11.17) Update
  2. Dual Fault LED (v01.17) Update
  3. ExitPlease choose from the above selections [1, 2, or 3].
3. Press "1" or "2" depending on the chassis you are using with the xSeries 343 server board.
4. The BMC Firmware update will start automatically. Do not power down the system during the BMC Firmware Update process! When the BMC Firmware update is successfully completed, the system is powered OFF automatically. This is normal operation. Remove the diskette from the diskette drive.
5. Power on the system. During boot, confirm that the BMC Firmware update was completed successfully by checking that the new BMC Firmware version is displayed. For example:

```
Base Board Management Controller
```

```
IPMI Version:1.0      Firmware version:01.17
```

## Making a FRU/SDR File Update Diskette

1. Place a formatted diskette in the diskette drive.
2. Extract the contents of the TSRLT2\_FRU\_SDR.EXE file onto the diskette. There is no need to make the diskette bootable; this is done automatically when the files are extracted to the diskette.

## Updating the FRU/SDR Files

1. Place the diskette containing the BMC FW update files into the diskette drive of your system. Boot the system while the diskette is in the drive.
2. Select one or two power supplies.
3. The following prompt will appear:  

```
Select the function you wish to perform:  
Update FRUs and the SDR repository  
Update just the SDR repository  
Modify the Asset Tag  
Exit
```

For a standard update, select option 1 to update the FRUs and the SDR repository.
4. Answer the questions on the screen to update the SDR repository appropriately for your chassis configuration.
5. When the update is complete, you will be returned to the DOS prompt. Remove the diskette from the diskette drive.
6. Reboot the system to complete the update process.

## Using the Adaptec SCSI Utility

The Adaptec SCSI utility detects the SCSI host adapters on the server board. The utility runs out of the BIOS and is used to:

- Change default values
- Check and/or change SCSI device settings that may conflict with those of other devices in the server

## Running the SCSI Utility

1. When this message appears on the video monitor:  

```
Press Ctrl-A to run SCSI Utility...
```
2. Press <Ctrl+A> to run this utility. When it appears, choose the host adapter that you want to configure.

Another Adaptec utility that is available on the *Documentation and Resource CD* is the Adaptec EZ SCSI utility. It is to be installed from diskettes onto a DOS or Windows operating system.



## Part II: Service Technician's Guide

---

### 5 Upgrading the Hardware

### 6 Upgrading the Chassis

### 7 Technical Reference

This section describes procedures that **REQUIRE** internal server access. You must be a qualified service technician to perform procedures listed in the *Service Technician's Guide*.

#### Statement 14



#### CAUTION

Hazardous voltage, current, and energy levels might be present. Only a qualified service technician is authorized to remove the covers where the following label is attached.



# Equipment Rack Precautions

## Statement 15



### CAUTION

Make sure that the rack is secured properly to avoid tipping when the server unit is extended.

### Notes

**Temperature:** The operating temperature of the server, when installed in an equipment rack, must not go below 5 °C (41 °F) or rise above 40 °C (104 °F). Extreme fluctuations in temperature can cause a variety of problems in your server.

**Ventilation:** The equipment rack must provide sufficient airflow to the front of the server to maintain proper cooling. The rack must also include ventilation sufficient to exhaust a maximum of 1023 BTU's per hour for the server. The rack selected and the ventilation provided must be suitable to the environment in which the server will be used.



## 5 Upgrading the Hardware

---

### Tools and Supplies Needed

Procedures in this section require the following tools and supplies:

- Jumper-removal tool or needle-nosed pliers
- Small flat-bladed screwdriver
- Phillips (cross-head) screwdriver (#2)
- Pen or pencil
- Anti-static wrist strap and conductive foam pad (recommended)



**Figure 10. Tools and Supplies Needed**

Equipment log: as you integrate new parts into the system, add information about them to your equipment log (Appendix B). Record the model and serial number of the system, all installed options, and any other pertinent information specific to the system.

### Caution and Danger Statements

Caution and danger statements apply throughout this chapter. Only a technically qualified person should configure the server hardware.

#### Note

**System power on/off:** The power button DOES NOT switch off system power. To remove power from the system, you must unplug/disconnect the power connections. Make sure power connections are unplugged/disconnected before you open the chassis, add, or remove any components.

**Statement 14**



**CAUTION**

Hazardous voltage, current, and energy levels might be present. Only a qualified service technician is authorized to remove the covers where the following label is attached.



**Statement 1**



**DANGER**

**Electrical current from power, telephone, and communication cables is hazardous.**

**To avoid a shock hazard:**

- **Do not connect or disconnect any cables or perform installation, maintenance, or reconfiguration of this product during an electrical storm.**
- **Connect all power cords to a properly wired and grounded electrical outlet.**
- **Connect to properly wired outlets any equipment that will be attached to this product.**
- **When possible, use one hand only to connect or disconnect signal cables.**
- **Never turn on any equipment when there is evidence of fire, water, or structural damage.**
- **Disconnect the attached power cords, telecommunications systems, networks, and modems before you open the device covers, unless instructed otherwise in the installation and configuration procedures.**
- **Connect and disconnect cables as described in the following table when installing, moving, or opening covers on this product or attached devices.**

**To Connect:**

1. Turn everything OFF.
2. First, attach all cables to devices.
3. Attach signal cables to connectors.
4. Attach power cords to outlet.
5. Turn device ON.

**To Disconnect:**

1. Turn everything OFF.
2. First, remove power cords from outlet.
3. Remove signal cables from connectors.
4. Remove all cables from devices.

## Replacing Power Supply Modules

To replace a power supply module, follow this procedure:

1. Depress the locking tab (A in Figure 11).
2. Rotate the handle downward (B in Figure 11).
3. Using the handle, pull the power supply outward (C in Figure 11).
4. Reverse these steps for installation.

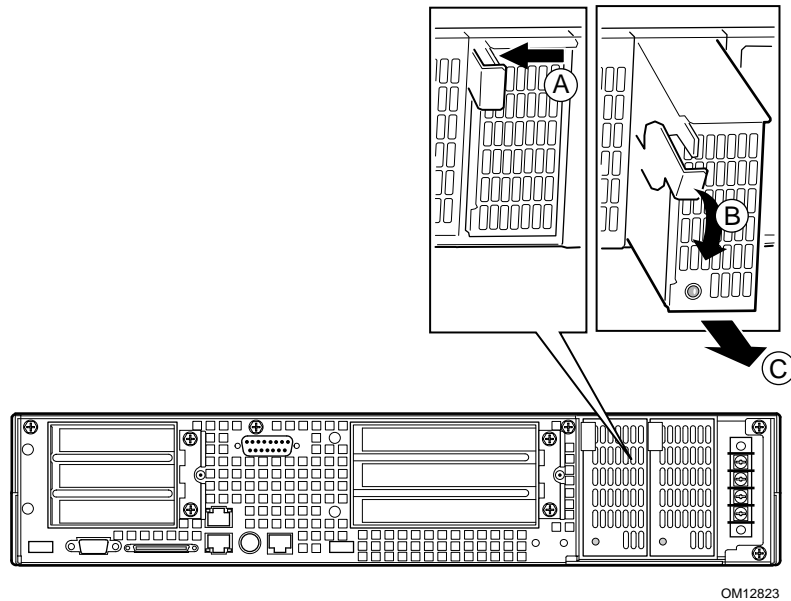
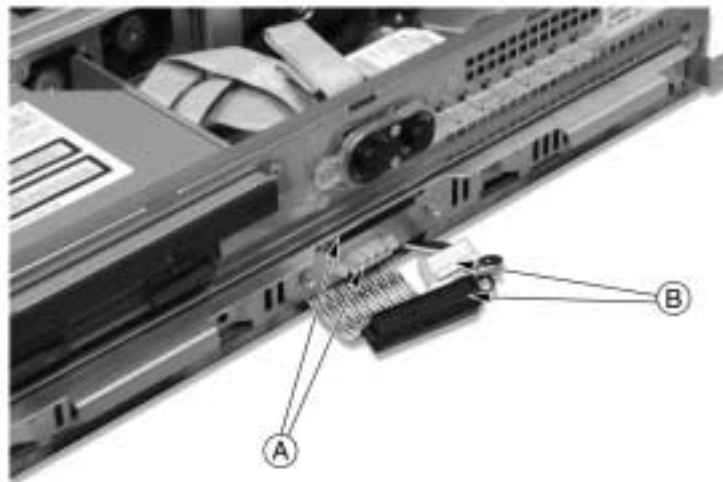

**Figure 11. Unlocking and Removing the Power Supply Modules**

## Replacing Hard Disk Drives

To replace a hard disk drive, follow this procedure:

1. Remove the bezel.
2. Disconnect the cables (B in Figure 12) from the connectors on the front of the hard disk drive bay (A in Figure 12).



OM12846

**Figure 12. Disconnecting the Hard Disk Drive Bay Cables**

3. Use the handles to pull the hard disk drive bay out of the chassis. Place it on a clean static-free work surface.

4. Remove the two screws securing the cable retention bracket (A in Figure 13) and lift the bracket out (B in Figure 13).
5. Disconnect the hard disk drive power cable (D in Figure 13).
6. Disconnect the hard disk drive ribbon cable (C in Figure 13).
7. Remove the three securing screws (E in Figure 13), lift the hard disk drive out of the hard disk drive carrier, and place on a clean, static-free work surface.

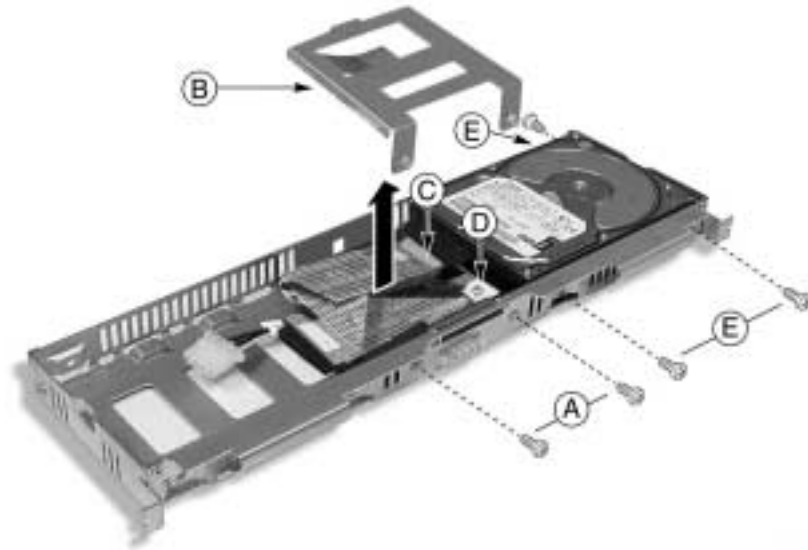

OM12524

**Figure 13. Removing a Hard Disk Drive**

## Working Inside the System

This section presents the following procedures that describe removal and installation of most components inside the system.

### Safety: Before You Remove Server Covers

Before removing covers at any time to work inside the system, observe these safety guidelines.

1. Turn off all peripheral devices connected to the system.
2. Power down the system by pressing and holding the Power button on the front of the chassis for several seconds. After the server shuts down disconnect the DC power to remove standby power from the server.
3. Label and disconnect all peripheral cables and all telecommunication lines connected to I/O connectors or ports on the back of the system.

Provide electrostatic discharge (ESD) protection by wearing an anti-static wrist strap attached to chassis ground of the system-any unpainted metal surface-when handling components.

### Caution and Danger Statements

Caution and danger statements apply whenever you remove covers of the system. Only a technically qualified person should integrate, configure, or service the system.

#### Statement 14



#### CAUTION

**Hazardous voltage, current, and energy levels might be present. Only a qualified service technician is authorized to remove the covers where the following label is attached.**



## Statement 1



### DANGER

**Electrical current from power, telephone, and communication cables is hazardous.**

**To avoid a shock hazard:**

- **Do not connect or disconnect any cables or perform installation, maintenance, or reconfiguration of this product during an electrical storm.**
- **Connect all power cords to a properly wired and grounded electrical outlet.**
- **Connect to properly wired outlets any equipment that will be attached to this product.**
- **When possible, use one hand only to connect or disconnect signal cables.**
- **Never turn on any equipment when there is evidence of fire, water, or structural damage.**
- **Disconnect the attached power cords, telecommunications systems, networks, and modems before you open the device covers, unless instructed otherwise in the installation and configuration procedures.**
- **Connect and disconnect cables as described in the following table when installing, moving, or opening covers on this product or attached devices.**

#### **To Connect:**

1. Turn everything OFF.
2. First, attach all cables to devices.
3. Attach signal cables to connectors.
4. Attach power cords to outlet.
5. Turn device ON.

#### **To Disconnect:**

1. Turn everything OFF.
2. First, remove power cords from outlet.
3. Remove signal cables from connectors.
4. Remove all cables from devices.

## Notes

**Hazardous conditions, processors and power supplies:** Thermal conditions may be present in the Processor/Memory Complex. Allow all fans to continue to run until they shut down on their own after power has been turned off. After the fans stop, you can unplug/disconnect the power cord.

**Cooling and airflow:** For proper cooling and airflow, always install the chassis covers before turning on the system. Operating the system without the covers in place can damage system parts.

## Handling Static-sensitive Devices

**Attention:** Static electricity can damage electronic devices and your system. To avoid damage, keep static-sensitive devices in their static-protective package until you are ready to install them.

To reduce the possibility of electrostatic discharge, observe the following precautions:

- Limit your movement. Movement can cause static electricity to build up around you.
- Handle the device carefully, holding it by its edges or its frame.
- Do not touch solder joints, pins, or exposed printed circuitry.
- Do not leave the device where others can handle and possibly damage the device.
- While the device is still in its anti-static package, touch it to an unpainted metal part of the system unit for at least two seconds. (This drains static electricity from the package and from your body.)
- Remove the device from its package and install it directly into your system unit without setting it down. If it is necessary to set the device down, place it in its static-protective package. Do not place the device on your system unit cover or on a metal table.
- Take additional care when handling devices during cold weather because heating reduces indoor humidity and increases static electricity.

## Removing and Installing the Top Cover

### Note

For proper cooling and airflow, do not operate the server with the cover removed. Always reinstall the cover before turning the server on.

The server comes with a removable Top Cover. Removal of this cover is necessary when installing or removing many components. You do not have to remove the Top Cover when removing or installing power supplies or hard drives.

### Statement 15



### CAUTION

**Make sure that the rack is secured properly to avoid tipping when the server unit is extended.**

### Note

Only use a screwdriver tip to push in the lock tabs on the rack slides. A pinch hazard exists if fingers are used for this purpose.



To remove the top cover, follow this procedure:

1. Remove the four screws along the rear panel (A in Figure 14) that secure the top cover to the chassis.
2. Slide the top cover rearward (B in Figure 14) to release it from the chassis.
3. Lift the top cover up to remove.



OM12825

**Figure 14. Removing the Top Cover**

## Internal Chassis Layout

The server board contains connectors for installing up to two Pentium III processors utilizing the FCPGA sockets. The server board has 6 DIMM slots and supports up to 6 GB error checking and correcting (ECC) SDRAM memory. The server board also contains 6 PCI slots (implemented via riser cards), input/output (I/O) ports and various controllers.

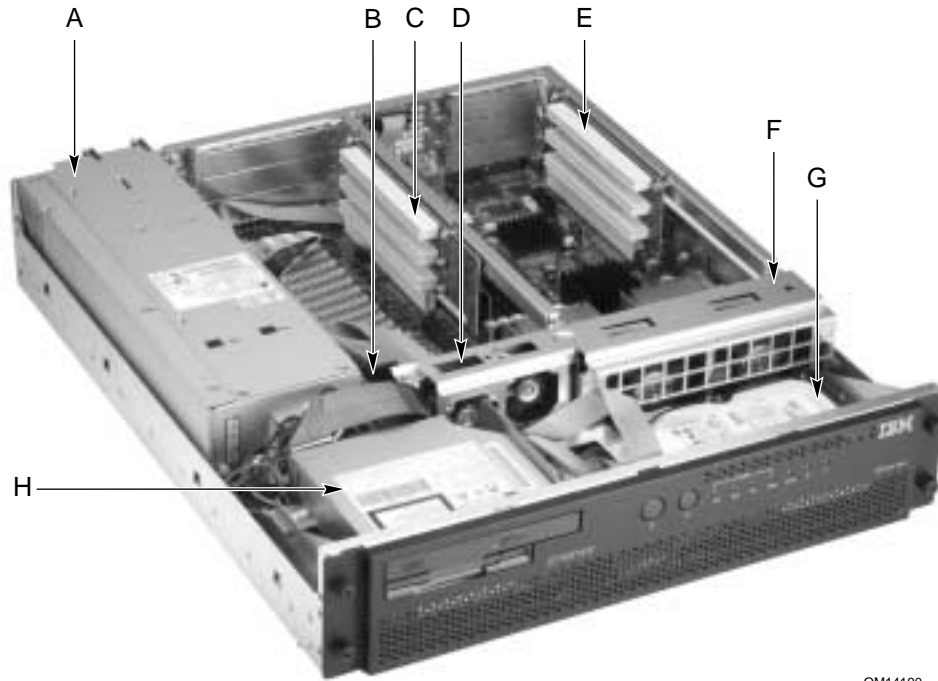

OM14190

- |   |                           |   |                           |
|---|---------------------------|---|---------------------------|
| A | Power Supply Cage         | E | 3.3 PCI Add-in Card Riser |
| B | Server Board              | F | Fan Bracket               |
| C | 5 V PCI Add-in Card Riser | G | SCSI Hard Disk Drive Tray |
| D | Fan Module                | H | Peripheral Bay            |

**Figure 15. Internal Chassis Layout**

The server board is mounted horizontally toward the rear of the chassis behind the system fan array. Up to two, 1.0-inch SCSI Ultra160 hard drives can be mounted in the hard drive tray that is mounted at the bottom front of the chassis. Above the hard drive tray and to the left are located the peripheral drives that consist of a slim-line (1/2-inch) floppy drive, and a slim-line (1/2-inch) CD-ROM drive.

The front panel is located above the hard drive tray and provides user interface for system management.

## Removing and Installing Memory

The server board supports only PC133-compliant SDRAM. Install from 128 MB to 6 GB of registered memory, using up to six single- or double-banked DIMMs.

DIMMs must be installed in pairs in the following order: 1A-1B, 2A-2B, and 3A-3B as shown in Figure 16. The DIMM sockets are further identified on the board's silkscreen.

Installed DIMMs must be the same speed and must all be registered. For a list of supported memory, call your service representative or visit the IBM Support website.

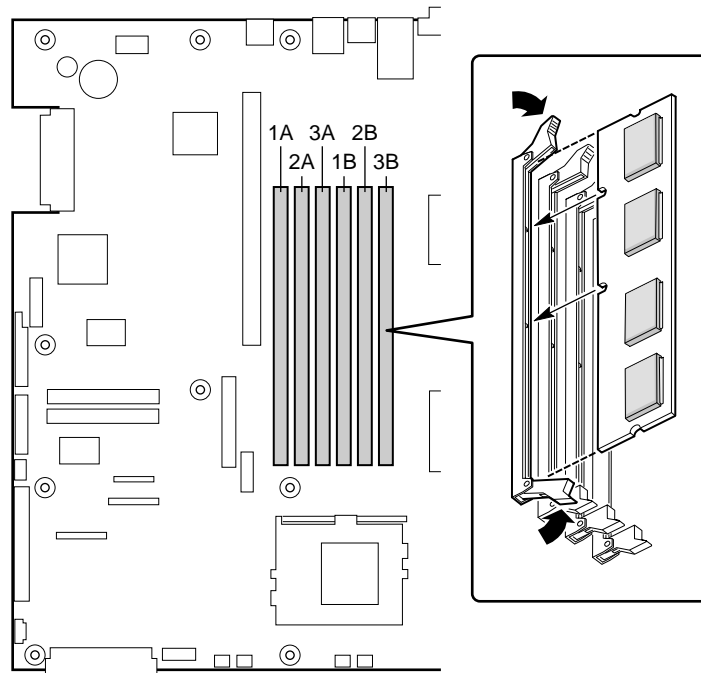

OM11790

**Figure 16. Installing DIMMs**

# Removing and Installing Processors

## Note

If the server has been running, any installed processor and heat sink on the processor board(s) will be hot. To avoid the possibility of a burn, allow the unit to cool-down and be careful when removing or installing server board components that are located near processors.

**Processor must be appropriate:** You may damage the server if you install a processor that is inappropriate for your server. Make sure your server can handle a newer, faster processor (thermal and power considerations). For exact information about processor interchangeability, contact your customer service representative.

## Handling Static-sensitive Devices

**Attention:** Static electricity can damage electronic devices and your system. To avoid damage, keep static-sensitive devices in their static-protective package until you are ready to install them.

To reduce the possibility of electrostatic discharge, observe the following precautions:

- Limit your movement. Movement can cause static electricity to build up around you.
- Handle the device carefully, holding it by its edges or its frame.
- Do not touch solder joints, pins, or exposed printed circuitry.
- Do not leave the device where others can handle and possibly damage the device.
- While the device is still in its anti-static package, touch it to an unpainted metal part of the system unit for at least two seconds. (This drains static electricity from the package and from your body.)
- Remove the device from its package and install it directly into your system unit without setting it down. If it is necessary to set the device down, place it in its static-protective package. Do not place the device on your system unit cover or on a metal table.
- Take additional care when handling devices during cold weather because heating reduces indoor humidity and increases static electricity.

## Adding or Replacing a Processor

If you are adding a second processor to your system, you must first remove the terminator from the secondary processor socket. The second processor must be compatible with the first processor (within one stepping, same voltage, same speed, see the IBM support website for details).

1. Observe the safety statements and “Handling Static-sensitive Devices”.
2. Remove the top cover.
3. Remove any PCI cards that may obscure the processors.
4. Raise the locking bar on the processor socket and remove the terminator as shown in Figure 17.

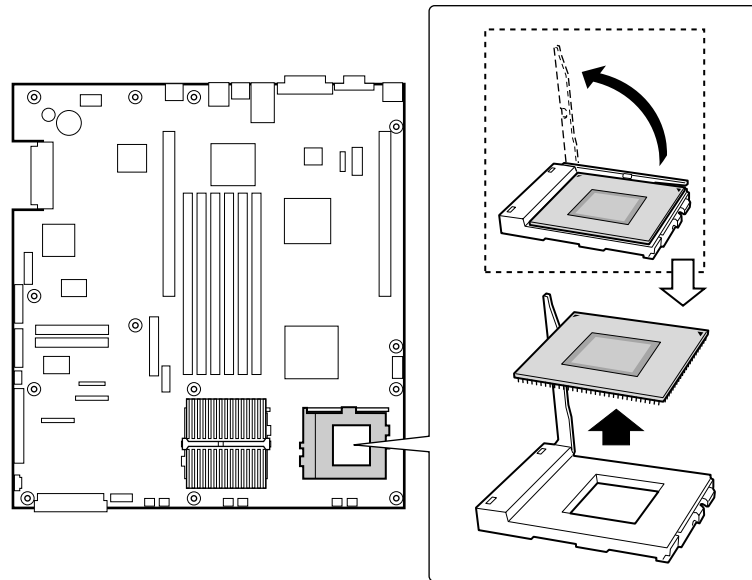

OM11814

**Figure 17. Raising the Locking Bar and Removing the Terminator**

5. Using Figure 18 as a guide, align the corner mark on the processor with the corner mark on the socket and insert the processor into the socket. Lower the locking bar completely and verify that it has fully latched.

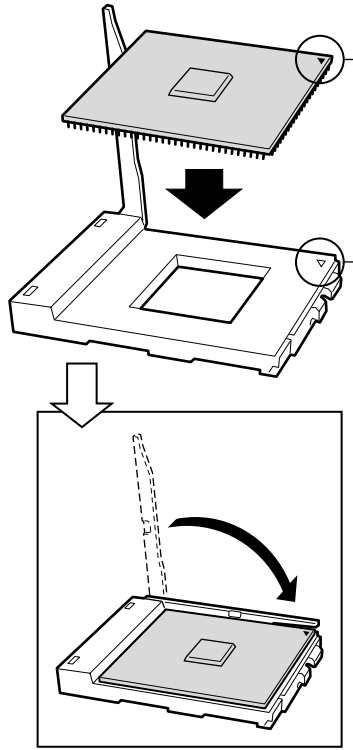

OM11789

**Figure 18. Inserting the Processor and Lowering the Locking Bar**

6. Align the processor and heatsink (D in Figure 19) so that the raised areas can make full contact when assembled (the blades of the heatsink should point toward the fans).
7. Place the heatsink (B in Figure 19) on top of the processor (A in Figure 19).
8. Hook the heatsink retention clip (C in Figure 19) to one end of the processor socket. Using a screwdriver or other tool, attach the other side of the clip to the other side of the processor socket.

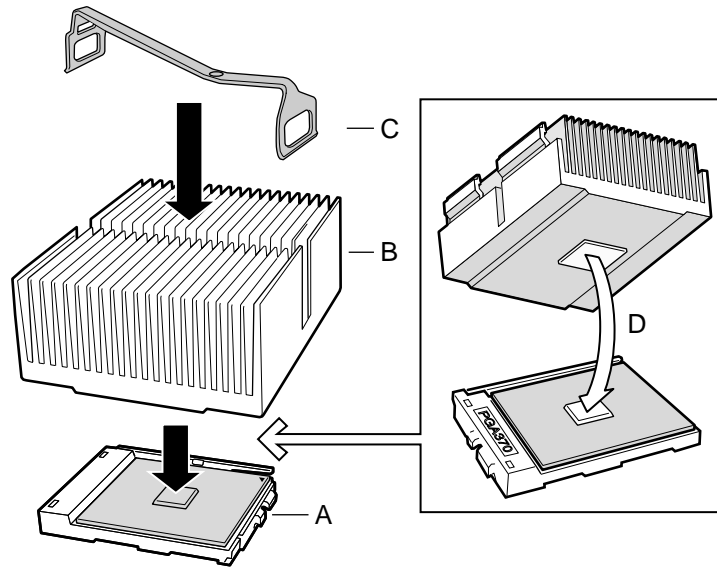

OM14223

**Figure 19. Aligning the Heatsink and Installing the Heatsink Retaining Clip**

## Removing a Processor

1. Observe the safety statements and “Handling Static-sensitive Devices”.
2. Detach the heatsink-retaining clip from the processor socket using a screwdriver or other tool as shown in Figure 20.

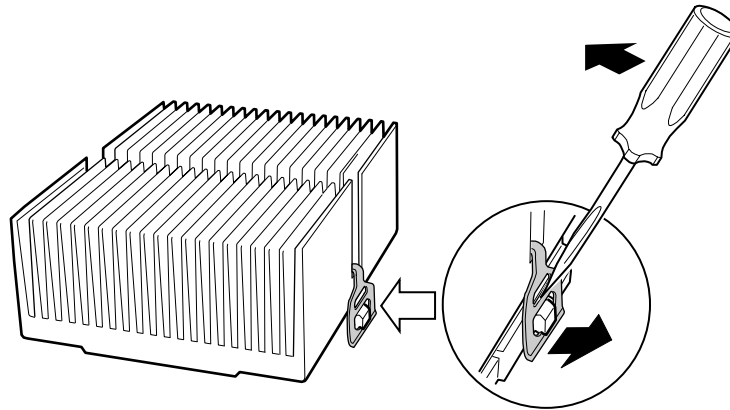

OM12827

**Figure 20. Unlatching the Heatsink Retaining Clip**

3. Remove the heatsink from the processor.
4. Raise the locking bar on the socket as shown in Figure 21.

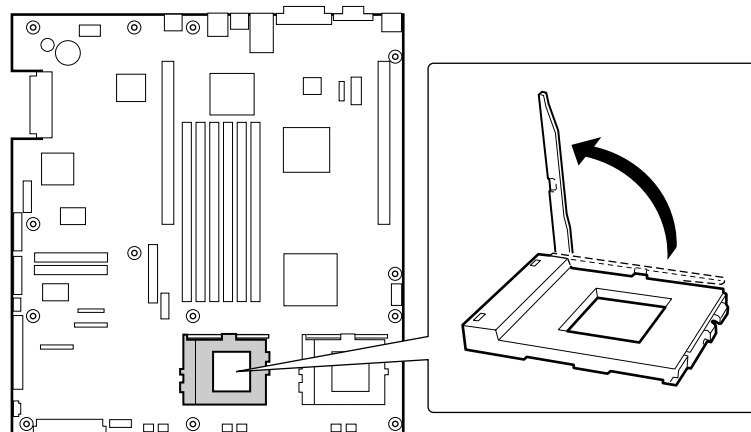

OM11788

**Figure 21. Raising the Locking Bar on the Processor Socket**

5. Remove the processor from the socket.
6. If you removed the processor from the secondary socket and are not replacing it, you must install a terminator in its place.



## Installing or Removing a Terminator

1. Observe the safety statements and “Handling Static-sensitive Devices”.
2. Raise the locking bar (B in Figure 22) on the socket (A in Figure 22).
3. Align the corner marks on the terminator (C in Figure 22) along the locking bar side of the processor socket.
4. Place the terminator into the socket.
5. Lower the locking bar (D in Figure 22) until it latches to the side of the processor socket.
6. Perform these steps in reverse to remove the terminator.

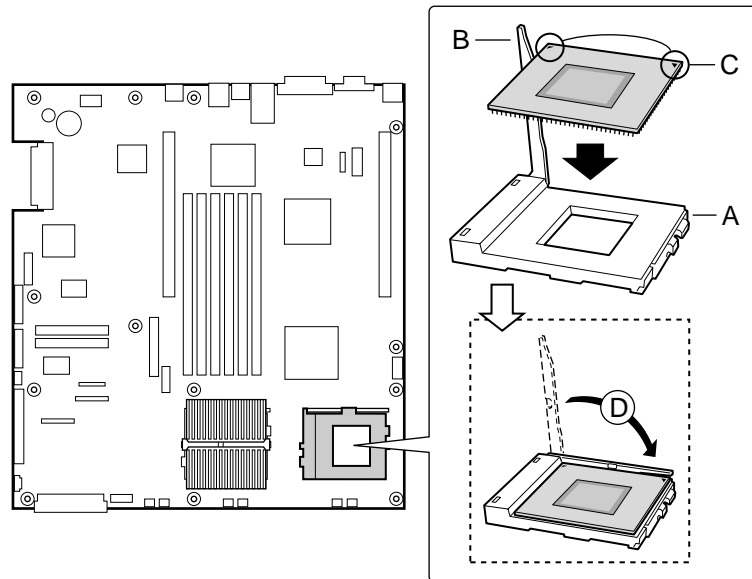

OM11787

**Figure 22. Installing a Terminator**

## Replacing 3.3 Volt and 5 Volt PCI Add-in Cards

The server supports two types of PCI riser boards: 3.3 Volt and 5 Volt. The riser boards may be installed as two 3.3 Volt, or one 3.3 Volt and one 5 Volt.

- The 5 Volt PCI riser supports three 64-bit 33 MHz PCI add-in cards.
- The 3.3 Volt PCI riser supports three, 64-bit, 66 MHz PCI add-in cards.

To replace the riser board, follow this procedure:

1. Remove the two screws securing the PCI retainer bracket.
2. Rotate the PCI retainer bracket to the left and slide out to remove.
3. Insert or remove the PCI add-in cards.
4. Replace the PCI retainer bracket. Make sure that it fully seats the PCI add-in cards.

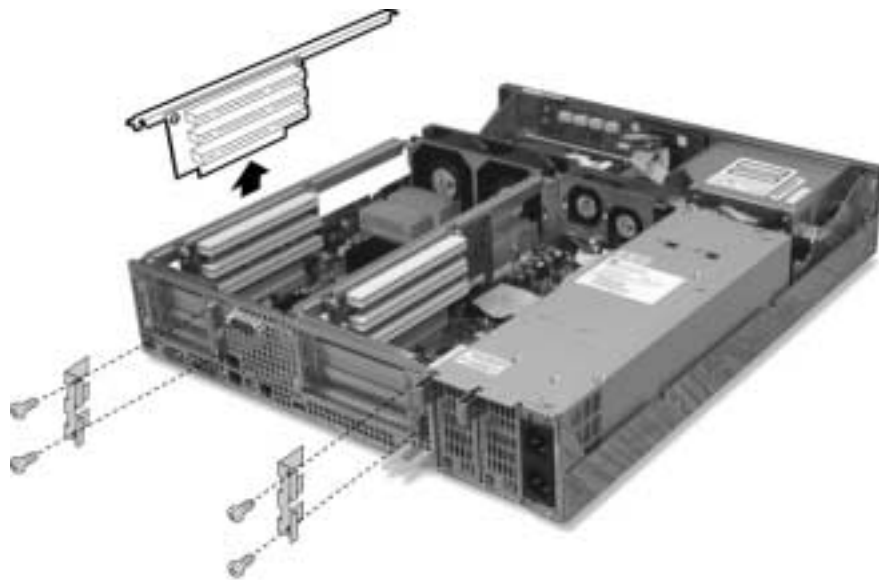

Figure 23. Replacing 3.3 Volt or 5 Volt PCI Add-in Cards

## PCI Add-in Card Cable Installation

It may be difficult to install a cable on the connector of a PCI add-in card configured at location A in Figure 24 due to interference from the power supply. If this occurs, it may be necessary to move the power supply cage out of the way, install the PCI cable on the PCI add-in card, then replace the power supply.

To connect a PCI cable to a PCI add-in card under these circumstances, follow these instructions:

1. Remove the two screws (B in Figure 24) holding the power supply cage in place.
2. Lift the back of the power supply and rotate it (C in Figure 24) so that it is placed outside of the unit. (This can be done without disconnecting the cable harness.)
3. Connect the cable to the PCI add-in card.
4. Replace the power supply cage and secure it with the two screws previously removed.

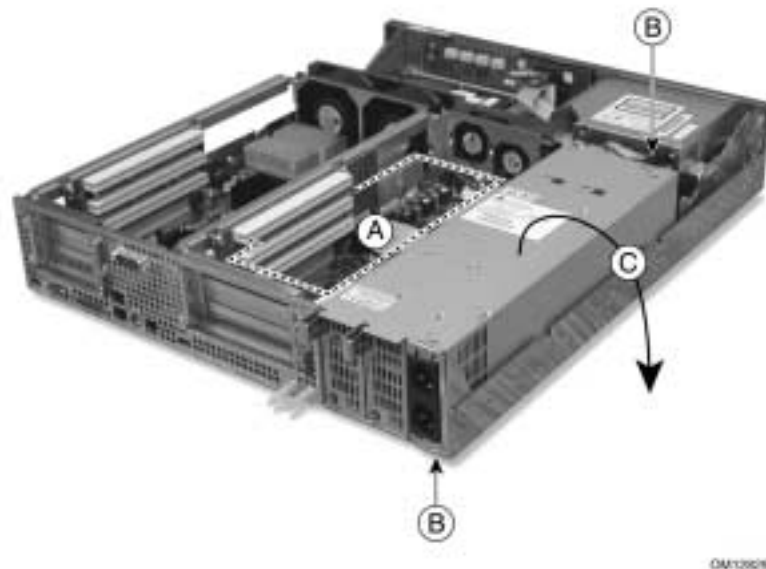

Figure 24. PCI Adapter Cable Installation

## Replacing the Back Up Battery

The lithium battery on the server board powers the real time clock (RTC) for up to 10 years in the absence of power. When the battery starts to weaken, it loses voltage, and the server settings stored in CMOS RAM in the RTC (for example, the date and time) may be wrong. Contact your customer service representative or dealer for a list of approved devices.

## Statement 2



### CAUTION

When replacing the lithium battery, use only IBM Part Number 33F8354 or an equivalent type battery recommended by the manufacturer. If your system has a module containing a lithium battery, replace it only with the same module type made by the same manufacturer. The battery contains lithium and can explode if not properly used, handled, or disposed of.

#### Do not:

- Throw or immerse into water
- Heat to more than 100 °C (212 °F)
- Repair or disassemble

Dispose of the battery as required by local ordinances or regulations.

## Statement 3



### CAUTION

When laser products (such as CD-ROMs, DVD drives, fiber optic devices, or transmitters) are installed, note the following:

- Do not remove the covers. Removing the covers of the laser product could result in exposure to hazardous laser radiation. There are no serviceable parts inside the device.
- Use of controls or adjustments or performance of procedures other than those specified herein might result in hazardous radiation exposure.



### DANGER

Some laser products contain an embedded Class 3A or Class 3B laser diode. Note the following. Laser radiation when open. Do not stare into the beam, do not view directly with optical instruments, and avoid direct exposure to the beam.

To replace the backup battery, follow this procedure:

1. Observe the safety statements and “Handling Static-sensitive Devices”.
2. Remove the top cover and locate the backup battery on the server board (see Figure 25).
3. Insert the tip of a small flat bladed screwdriver, or equivalent, under the tab in the plastic retainer. Gently push down on the screwdriver to lift the battery.
4. Remove the battery from its socket.
5. Dispose of the battery according to local ordinance.
6. Remove the new lithium battery from its package, and, being careful to observe the correct polarity, insert it in the battery socket.
7. Reinstall the plastic retainer on the lithium battery socket.
8. Replace the top cover.
9. Run Setup to restore the configuration settings to the RTC.

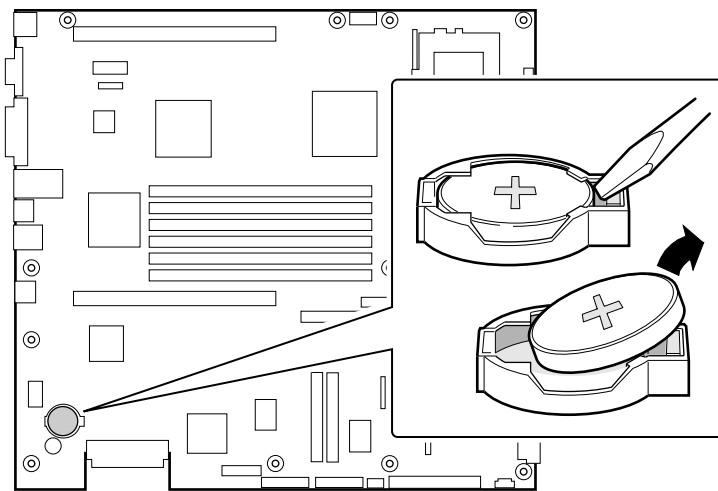

OM12830

**Figure 25. Replacing the Backup Battery**



## 6 Upgrading the Chassis

### Replacing the Server Board

To remove the server board, follow this procedure:

1. Remove the top cover.
2. Remove the fan bracket.
3. Remove any PCI cards that may be installed in a 3.3 Volt or 5 Volt riser boards and place them on a clean, static-free surface.
4. Unplug the PCI riser boards from the server board and place them on a clean, static-free surface. (The upper brackets may be left attached to the riser boards.)
5. Remove the heatsink(s) and processor(s) from the server board and place them on a clean, static-free surface.
6. Disconnect the cables attached to the board (see Figure 26) and fold them clear of the board.

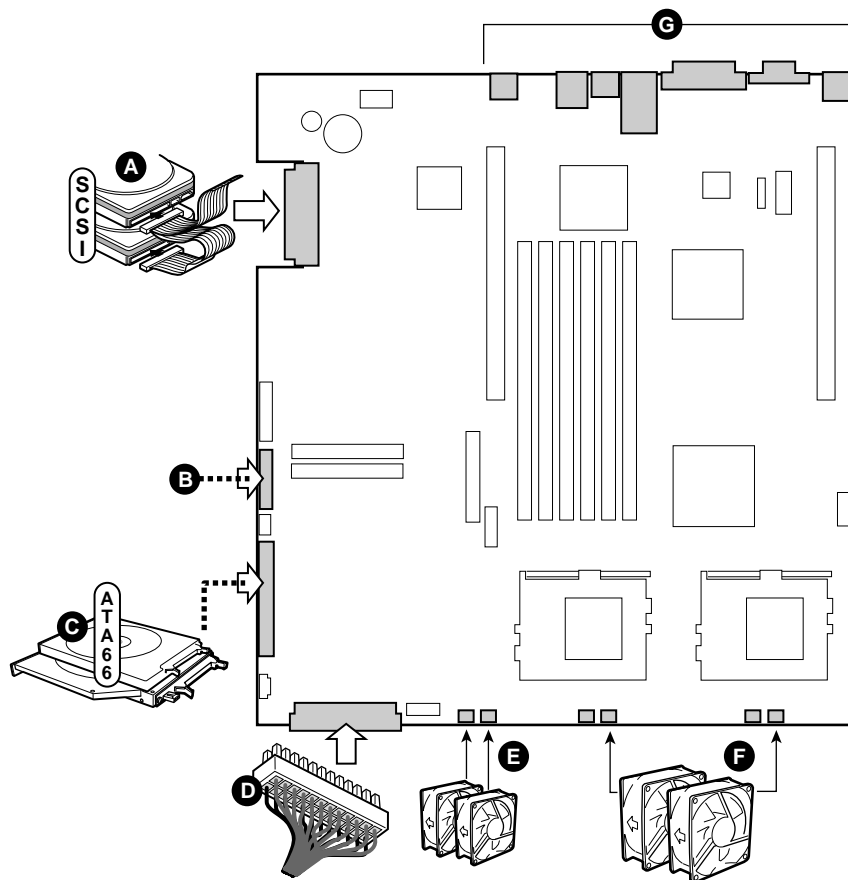

OM12831

Figure 26. Removing the Server Board Cabling

7. Remove the screws indicated in Figure 27.

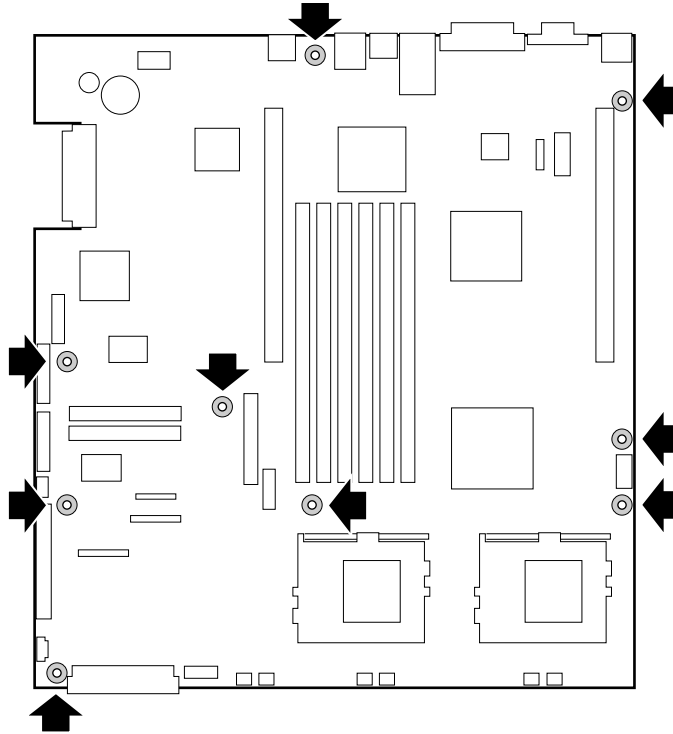

OM12832

**Figure 27. Removing the Server Board Retaining Screws**

8. Lift the server board out of the chassis and place on a clean, static-free surface.
9. Repeat this procedure in reverse to install the server board.



## Replacing the CD-ROM and Floppy Disk Drives

**Attention:** The cable can easily be damaged if not handled carefully. Refer to the installation instructions supplied with the replacement cable.

To replace the CD-ROM and/or floppy disk drives, follow this procedure:

1. Remove the bezel.
2. Remove the three screws securing the fan bracket and remove.
3. Unplug and remove the 40 mm-fan module.
4. Disconnect the ribbon cable (A in Figure 28) from the server board.
5. Disconnect the power cable (B in Figure 28). You can access the power cable by loosening the captive screw (C in Figure 28), and sliding the peripheral bay out an inch or two.
6. With the ribbon cable still attached to the CD-ROM drive, slide the peripheral bay out through the front panel (D in Figure 28) and place on a clean static-free work surface.

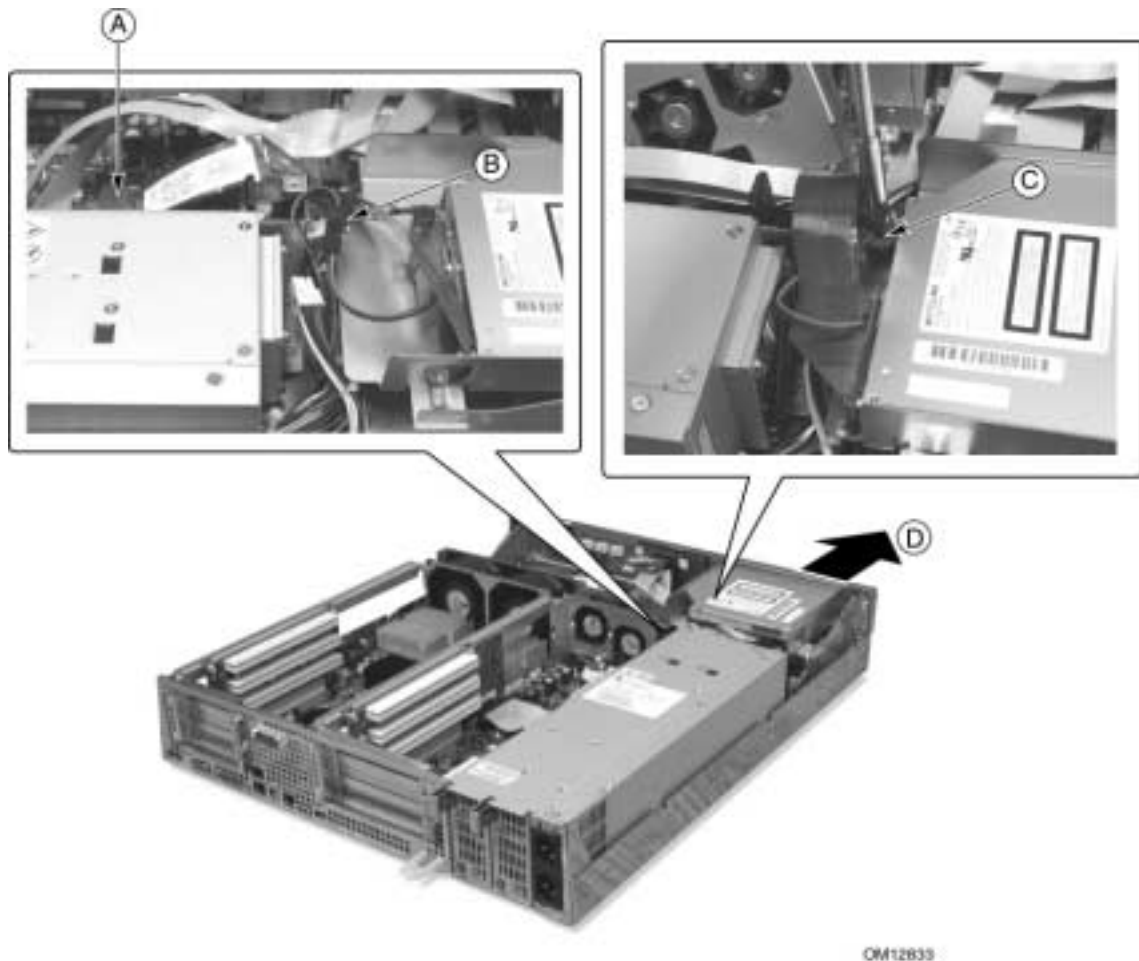
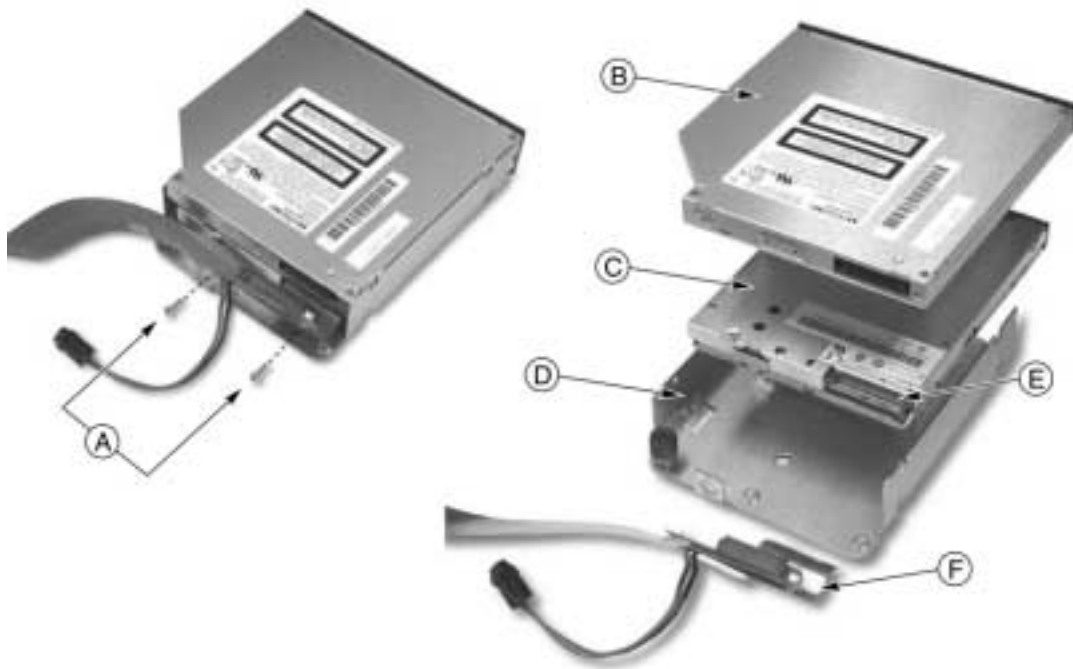

Figure 28. Removing the Peripheral Bay from the Chassis

7. Remove the two screws securing the cable to the CD-ROM drive (A in Figure 28) and disconnect the CD-ROM cable connector.
8. Raise the securing latch on the floppy disk drive's ribbon cable connector (E in Figure 29) and lift out the ribbon cable (F in Figure 29).
9. Apply pressure with a small screwdriver to the dimpled-side of the peripheral bay (D in Figure 29) to separate the CD-ROM drive (B in Figure 29) from the peripheral bay.
10. To remove the floppy disk drive (C in Figure 29) from the peripheral bay, apply pressure with a small screwdriver to the dimpled-side peripheral bay (D in Figure 29) to separate the floppy disk drive from the peripheral bay.
11. Place the CD-ROM drive and the floppy disk drive on a clean, static-free work surface.



DM13128

**Figure 29. Separating the CD-ROM and Floppy Disk Drives from the Peripheral Bay**

## Replacing the Front Panel Board

To replace the front panel board, follow this procedure:

1. Disconnect the small ribbon cable (A in Figure 30).
2. Disconnect the large ribbon cable (B in Figure 30).
3. Remove the screw (C in Figure 30) and release the snap-on fasteners (D in Figure 30).
4. Lift out the board and place it on a clean, static-free surface.
5. To install the new board, repeat the instructions above in reverse order.

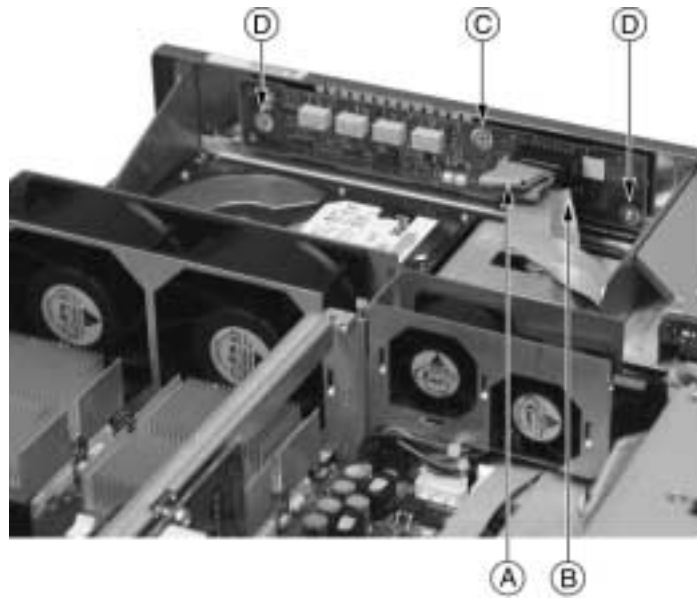

OM12634

**Figure 30. Front Panel Removal**

## Replacing Fans

### Replacing an 80 mm Fan

To replace an 80 mm fan, follow this procedure:

1. Loosen the three screws that secure the fan bracket and remove.
2. Disconnect the fan power cable from the server board (A in Figure 31).
3. Slide the fan upward (B in Figure 31) out of the fan housing.
4. When replacing fans, note the airflow arrow (C in Figure 31) on the fan. The airflow arrow should be pointing rearward toward the processors.

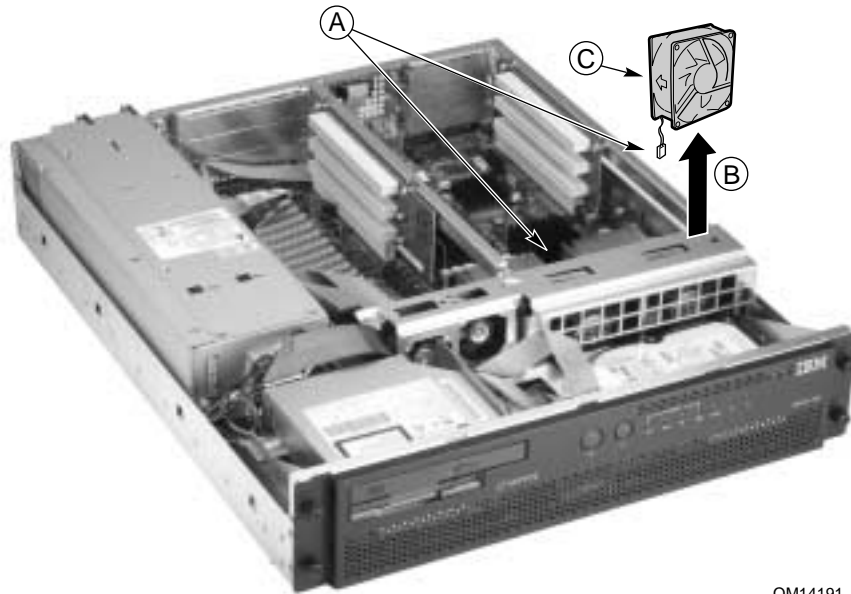

OM14191

**Figure 31. Replacing 80 mm Fans**

## Replacing a 40 mm Fan

To replace a 40 mm fan, follow this procedure:

1. Remove the three screws that secure the fan bracket and lift it out of the chassis.
2. Disconnect the fan power cables from both fans (A in Figure 31).
3. Slide the 40 mm fan module upward (B in Figure 31) out of the server.
4. Slide the fan (C in Figure 31) out of the 40 mm fan module.
5. When replacing fans, note the airflow arrow on the fan. The airflow arrow should be pointing rearward toward the processors.

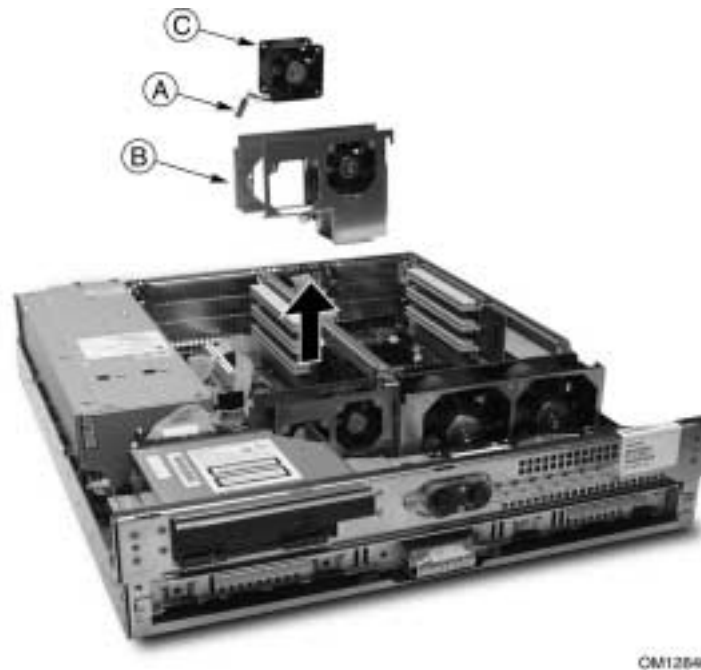

CM12640

**Figure 32. Replacing 40 mm Fans**

## Removing the Power Supply Cage

To replace the power supply cage, follow these instructions:

1. Remove the front bezel.
2. Disconnect the power cable and SCSI cable from the drive tray.
3. Remove the drive tray.
4. Remove the cable hold-down bracket located underneath the drive tray.
5. Disconnect the power connector from the floppy/CD-ROM signal cable.
6. Disconnect and remove the 40 mm fan array (A in Figure 33).
7. Disconnect the server board's main power connector and peripheral power connectors (B in Figure 33).
8. Remove the two securing screws (C in Figure 33) from the power supply cage.
9. Lift out the power supply cage (D in Figure 33).

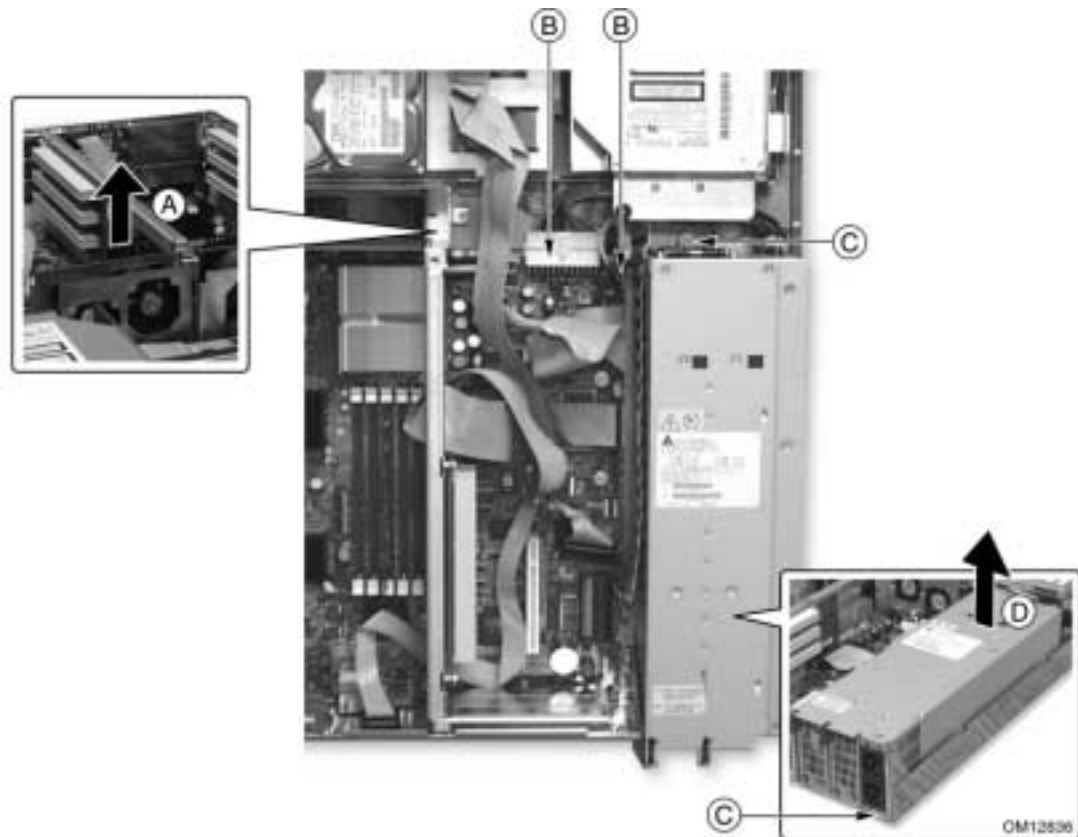

Figure 33. Removing the Power Supply Cage

# 7 Technical Reference

---

This section includes:

- Connector pinouts
- Information on jumpers

## Connector Pinouts

This section describes certain I/O interface connectors of the xSeries 343 server.

### Alarms

The alarms port interface is a standard DB15-pin connector (see Figure 34). This connector allows remote display of alarm conditions. Each alarm (Major, Minor, Critical and Power) is the output of a STDT relay contact. A common contact with normally open and normally closed connections is included. Power alarm has just a common and normally open contact outputs. The major and minor alarms contain external reset circuits. Table 12 gives the pinout of the alarms connector.

#### Note

Do not apply more than 60 Volts (maximum) to any pin or combination of pins on the Alarms connector.

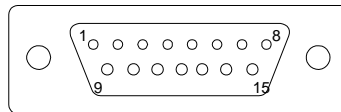

Figure 34. 15-pin Alarms Connector

Table 12. Alarms Connector Pinout

Pin	Description	Pin	Description
1	Minor reset positive	9	Minor alarm normally closed
2	Minor reset negative	10	Minor alarm common
3	Major reset positive	11	Major alarm normally open
4	Major reset negative	12	Major alarm normally closed
5	Critical alarm normally open	13	Major alarm common
6	Critical alarm normally closed	14	Power alarm normally open
7	Critical alarm common	15	Power alarm common
8	Minor alarm normally open		

## DC Power Input for DC-Input Power Supply Cage

A DC power terminal block is provided at the rear of the DC-input power supply cage. It is recommended to use appropriately sized power wire and DC mains.

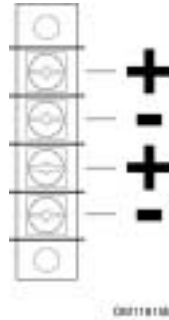

**Figure 35. DC Power Input Connector**

The terminal block will accept standard terminal lugs size Newark stock # 81N1501 type CRS-T0-1406-HT that accept 14 AWG wire gauge. The width (W in Figure 36) of the lug can be no larger than 0.25 inches.



**Figure 36. DC Power Terminal Lug**

To connect the earth ground conductor to the chassis stud:

1. Place a #8-32 nut on the chassis stud and tighten to 10 in-lb.
2. Place the earth ground wire terminal lug on the chassis stud.
3. Place another #8-32 nut on the chassis stud so that the earth ground wire terminal is between the two nuts and tighten the second nut to 10 in-lb.



## Serial Ports

One serial port is provided on the rear I/O to supply COM2 using an 8-pin RJ45 connector (see Table 13). The COM2 serial port can be used either as an emergency management port or as a normal serial port. As an emergency management port (EMP), COM2 is used as a communication path by the server management software that provides a level of emergency management through an external modem. Figure 37 describes the serial port's connections.

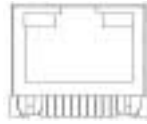

Figure 37. Serial Ports A and B

Table 13. Serial Port Connector Pinout

Pin	Signal	Description
1	RTS	Request to send
2	DTR	Data terminal ready
3	TXD	Transmit data
4	GND	
5	RIA	Ring indicator
6	RXD	Receive data
7	DSR/DCD	Date set ready / data carrier detect <sup>1</sup>
8	CTS	Clear to send

<sup>1</sup> Use jumper on server board to select

# Configuration Jumpers

This section describes the jumper blocks that control various configuration options. Figure 38 shows the names and location of the configuration jumpers. The shaded areas show the default jumper placement for each configurable option. Table 14 describes the system recovery and update jumper options.

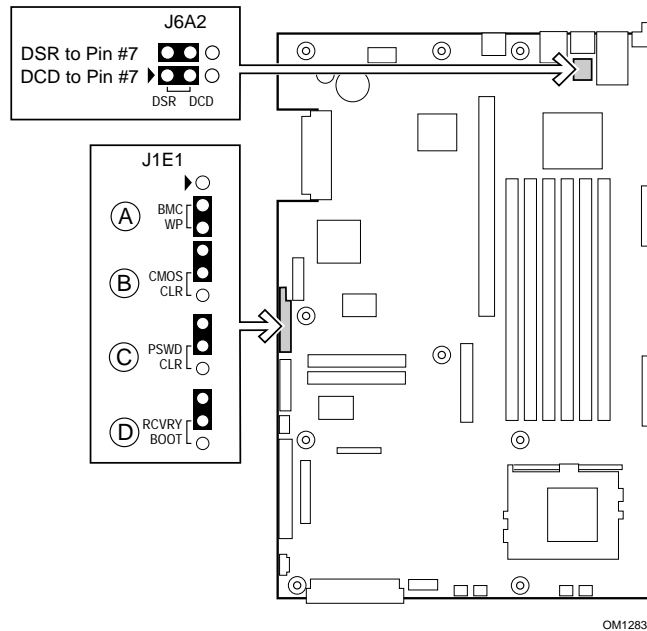

**Figure 38. Jumper Locations (J1E1 and J6A2)**

## System Recovery and Update Jumpers (J1E1)

**Table 14. System Recovery and Update Jumper Options**

Option	Description
BMC Write Protect	If pins 2 and 3 are jumpered (default), the BIOS boot block is write-protected. If pins 1 and 2 are jumpered, the boot block is erasable and programmable. <b>WARNING: Incorrect programming of the boot block will render the system unbootable.</b> With this option set to its default factory setting, the BMC's operational code can still be programmed without moving the jumper.
CMOS Clear	If pins 4 and 5 are jumpered (default), preservation of configuration CMOS through system reset is controlled by the BMC. If pins 5 and 6 are jumpered, CMOS contents are set to the manufacturing default during system reset.
Password Clear	If pins 7 and 8 are jumpered (default), the current system password is maintained during system reset. If pins 8 and 9 are jumpered, the password is cleared on reset.
Recovery Boot	If pins 10 and 11 are jumpered (default) the system will attempt to boot using the BIOS programmed in the Flash memory. If pins 11 and 12 are jumpered, the BIOS will attempt a recovery boot, loading BIOS code from a CD-ROM disk into the Flash device. This feature is typically used when the BIOS code has been corrupted.

## DSR/DCD Configuration Jumper (J6A2)

For serial concentrators that require a DCD signal, configure the J6A2 jumper block as shown in Figure 39.

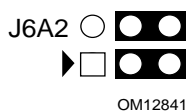

**Figure 39. J6A2 Jumper Block Configured for DCD Signal**

For serial concentrators that require a DSR signal, configure the J6A2 jumper block as shown in Figure 40.

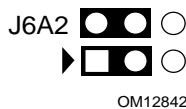

**Figure 40. J6A2 Jumper Block Configured for DSR Signal (Default)**

## FRU List

This section describes the orderable list of IBM FRU part numbers and the associated part number that appears on the actual part.

Description	IBM FRU P/N	Component P/N
Panel Cable Kit	01R0824	
Front Panel Cable		A55047
Telco Alarm Panel Cable		A42468
Power Cable Kit	01R0826	
Pwr Extender Cbl (PSU to Board)		A74242
Pwr Extender Cbl (PSU to HDD Housing)		A65990
Y Cable / RJ45/ 9Pin Conv (2)	01R0828	
Y-KBD/Mouse Combo Cable		A91939
RJ45 to 9 Pin Serial Cbl (DCD)		A93252
RJ45 to 9 Pin Serial Cbl (DSR)		A93251
Miscellaneous Chassis Part Kit	01R0847	
Front Panel Light Pipes		A59619
SCSI Cable Kit	01R0821	N/A
Hard Drive Power Cable		A51613
Battery	33F8354	N/A
Chassis	01R0808	N/A
Bezel	01R0809	N/A
Removable Drive Tray	01R0810	N/A
Fan Housing and Riser Bracket	01R0812	N/A
FDD/IDE Cable Kit	01R0819	N/A
Rack Mount Kit	01R0816	N/A
Telco Baseboard SE-HL Chipset (Systemboard)	01R0830	N/A
Front Panel Telco Alarm Board	01R0831	N/A
PCI Riser Board 3.3V	01R0832	N/A
PCI Riser Board 5V	01R0833	N/A
1 GB PC133 DIMM	33L3327	N/A
512 MB PC 133 DIMM	33L3325	N/A
Intel PIII 1.26GHz/512K Processor*	01R0835	N/A
Slim Floppy Drive	01R0836	N/A
Slim CDROM Drive	01R0837	N/A
DC Power Supply 2U 350W	01R0838	N/A
DC Power Supply Cage	01R0839	N/A
40 mm Fan Kit	01R0841	N/A
80 mm Fan Kit	01R0842	N/A
CPU Heat Sink Kit	01R0844	N/A
Publication and CD Kit	01R0845	N/A
2 Post Rack Mount Kit	01R0816	N/A
HDD 30G	06P5365	N/A

\*When ordering this FRU you are also required to order a CPU HeatSink FRU (01R0844).

# A POST Error Codes, Messages and FRU to Failure Information

---

The following tables define POST error codes and their associated messages. The BIOS will prompt the user to press a key in case of serious errors. The string “Error” precedes some error messages to highlight possible system malfunctions. The BIOS vendor specific error codes are not listed here since not all error codes are applicable to every platform. All POST errors and warnings are logged in the system event log unless it is full.

After the video adapter has been successfully initialized, the BIOS indicates the current testing phase during POST by writing a 2-digit hex code to I/O location 80h. If a Port-80h card (Postcard) is installed, it displays this 2-digit code on a pair of hex display LEDs.

**Table 15. Port-80h Code Definition**

Code	Meaning
CP	AMI check point (port-80) code

**Table 16. Boot Block POST Codes**

Checkpoint Code	Description
D0h	The NMI is disabled. Power-on delay is starting. Next, the initialization code checksum will be verified.
D1h	Initializing the DMA controller, performing the keyboard controller Basic Acceptance Test (BAT) test, starting memory refresh, and entering 4 GB flat mode next.
D3h	Starting memory sizing next.
D4h	Returning to real mode. Executing any OEM patches and setting the stack next.
D5h	Passing control to the uncompressed code in shadow RAM. The initialization code is copied to segment 0 and control will be transferred to segment 0.
D6h	Control is in segment 0. Next verifying the system BIOS checksum. If the system BIOS checksum is bad, go to checkpoint code E0h. Otherwise, going to checkpoint code D7h.
D7h	Passing control to the interface module next.
D8h	The main system BIOS runtime code will be decompressed next.
D9h	Passing control to the main system BIOS in shadow RAM next.
03h	The NMI is disabled. Next, checking for a soft reset or a power-on condition.
05h	The BIOS stack has been built. Next, disabling cache memory.
06h	Uncompressing the POST code next

**Table 17. POST Code - Port 80h Codes**

Post Code	Diagnostic LED Decoder				Description
	Note: G=Green, R=Red, A=Amber				
	MSB			LSB	
07h	Off	G	G	G	Uncompress various BIOS modules.
08h	G	Off	Off	Off	Verify password checksum.
08h	G	Off	Off	Off	Verify CMOS checksum.
07h	Off	G	G	G	Read microcode updates from BIOS ROM.
07h	Off	G	G	G	Initializing the processors. Set up processor registers. Select least featured processor as the BSP.
0Bh	G	Off	G	G	Hook before the keyboard BAT command is issued.
0Ch	G	G	Off	Off	Keyboard Controller Test: the keyboard controller input buffer is free. Next, issuing the BAT command to the keyboard controller.
0Eh	G	G	G	Off	Init after keyboard test: the keyboard controller BAT command result has been verified. Next, performing any necessary initialization after the keyboard controller BAT command test.
0Fh	G	G	G	G	Write Command Byte 8042: the initialization after the keyboard controller BAT command test is done. The keyboard command byte will be written next.
10h	Off	Off	Off	R	Keyboard Init: the keyboard controller command byte is written. Next, issuing the pin 23 and 24 blocking and unblocking commands.
10h	Off	Off	Off	R	Disable and initialize 8259.
11h	Off	Off	Off	A	Detect configuration mode, such as CMOS clear.
13h	Off	Off	G	A	Chipset initialization before CMOS initialization.
19h	G	Off	Off	A	Init System Timer: the 8254 timer test is over. Starting the memory refresh test next.
1Ah	G	Off	G	R	Check Refresh Toggle: the memory refresh line is toggling. Checking the 15 second on/off time next.
23h	Off	Off	A	G	Setup Interrupt Vectors: reading the 8042 input port and disabling the MEGAKEY Green PC feature next. Making the BIOS code segment writable and performing any necessary configuration before initializing the interrupt vectors.
24h	Off	G	R	Off	Before Vector: configuration is required before interrupt vector initialization has completed. Interrupt vector initialization is about to begin.
25h	Off	G	R	G	Init interrupt Vectors: interrupt vector initialization is done.
F2h	R	R	A	R	Initialize SMM handler. Initialize USB emulation.
F5h	R	A	R	A	Validate NVRAM areas. Restore from backup if corrupted.
12h	Off	Off	G	R	Load defaults in CMOS RAM if bad checksum or CMOS clear jumper is detected.
12h	Off	Off	G	R	Initializing APP CMOS RAM for appliance servers only.
12h	Off	Off	G	R	Check point after CMOS initialized.
27h	Off	G	A	G	Validate date and time in RTC.

continued

**Table 17. POST Code - Port 80h Codes (continued)**

Post Code	Diagnostic LED Decoder				Description
	Note: G=Green, R=Red, A=Amber				
	MSB			LSB	
F4h	R	A	R	R	Load micro code to all CPUs.
F6h	R	A	A	R	Scan SMBIOS GPNV areas.
15h	Off	G	Off	A	8254 timer test on channel 2.
15h	Off	G	Off	A	Enable 8042.
15h	Off	G	Off	A	Keyboard reset.
26h	Off	G	A	Off	Initialize LCD, if supported.
28h	G	Off	R	Off	Set Video Mode: initialization before setting the video mode is complete. Configuring the monochrome mode and color mode settings next.
29h	G	Off	R	G	Debugger hook.
2Ah	G	Off	A	Off	Init PCI devices and motherboard devices. Pass control to video BIOS Start serial console redirection.
2Bh	G	Off	A	G	Platform hook.
2Dh	G	G	R	G	Initialize AMI display manager module. Initialize support code for headless system if no video controller is detected.
2Dh	G	G	R	G	Scan flash for logos and Initialize logo data areas.
30h	Off	Off	R	R	Detect PS/2 mouse.
30h	Off	Off	R	R	Hook after c000 ROM control.
2Eh	R	R	A	Off	Set up video parameters in BIOS data area.
37h	Off	G	A	A	Activate ADM: the display mode is set. Displaying the power-on message next.
37h	Off	G	A	A	Initialize language module. Display splash logo.
37h	Off	G	A	A	Display Sign-On Message BIOS ID and processor information.
38h	G	Off	R	R	Detect USB mouse: initializing the bus input, and general devices next, if present.
34h	Off	G	R	R	Reset IDE controllers.
39h	G	Off	R	A	Displaying bus initialization error messages.
3Ah	G	Off	A	R	Display Setup Message the new cursor position has been read and saved. Displaying the hit setup message next.
40h	Off	R	Off	Off	Ensure timer keyboard interrupts are on.
4Bh	G	R	G	G	Memory Test: the amount of memory above 8 MB has been found and verified. Checking for a soft reset and clearing the memory below 8 MB for the soft reset next. If this is a power-on situation, going to checkpoint 4Eh next.
57h	Off	A	G	A	Chipset hook after memory size.
53h	Off	R	A	A	Display processor cache size.
54h	Off	A	Off	R	Disable parity and NMI reporting.

continued



**Table 17. POST Code - Port 80h Codes (continued)**

Post Code	Diagnostic LED Decoder				Description
	Note: G=Green, R=Red, A=Amber				
	MSB			LSB	
60h	Off	R	R	Off	Test 8237 DMA Controller the DMA page register test passed. Performing the DMA Controller 1 base register test next.
65h	Off	A	R	G	Init 8237 DMA Controller the DMA controller 2 base register test passed. Programming DMA controllers 1 and 2 next.
7Fh	G	A	A	A	Extended NMI Enable: extended NMI source enabling is in progress.
80h	R	Off	Off	Off	Enable Mouse and Keyboard: the keyboard test has started. Clearing the output buffer and checking for stuck keys. Issuing the keyboard reset command next.
81h	R	Off	Off	G	Keyboard Interface Test: a keyboard reset error or stuck key was found. Issuing the keyboard controller interface test command next.
82h	R	Off	G	Off	Check Stuck Key Enable Keyboard: the keyboard controller interface test completed. Writing the command byte and initializing the circular buffer next.
83h	R	Off	G	G	Disable Parity NMI the command byte was written and global data initialization has completed. Checking for a locked key next
84h	R	G	Off	Off	Verify RAM Size: checking for a memory size mismatch with CMOS RAM data next.
84h	R	G	Off	Off	Check ATA cable type presence of ATAPI devices.
84h	R	G	Off	Off	Display keyboard message.
16h	Off	G	G	R	Display IDE mass storage devices.
17h	Off	G	G	A	Display USB mass storage devices.
85h	R	G	Off	G	Report the first set of POST errors to error manager.
86h	R	G	G	Off	Boot Password Check: the password was checked. Performing any required programming before Setup next.
8Dh	A	G	Off	G	OEM Patch 9.
8Dh	A	G	Off	G	Set Printer RS-232 timeout
8Dh	A	G	Off	G	Init FDD Devices: resetting the hard disk controller next.
95h	R	G	Off	A	Lock out PS/2 keyboard/mouse if unattended start is enabled.
92h	R	Off	G	R	Option ROM scan.
98h	A	Off	Off	R	Init Boot Devices: the adapter ROM had control and has now returned control to BIOS POST Performing any required processing after the option ROM returned control.
9Bh	A	Off	G	A	Float Processor Initialize: performing any required initialization before the coprocessor test next.
9Eh	A	G	G	R	Enable Interrupts 0,1,2: checking the extended keyboard, keyboard ID, and NUM Lock key next. Issuing the keyboard ID command next.

continued

**Table 17. POST Code - Port 80h Codes (continued)**

Post Code	Diagnostic LED Decoder				Description
	Note: G=Green, R=Red, A=Amber				
	MSB			LSB	
A2h	R	Off	A	Off	Report second set of POST errors to error messenger.
86h	R	G	G	Off	Prepare And Run Setup: error manager displays and logs POST errors. Waits for user input for certain errors. Execute setup.
8Bh	A	Off	G	G	Set base expansion memory size.
8Ch	A	G	Off	Off	Adjust Setup: programming the Setup options next.
A5h	R	G	R	G	Set display mode.
A7h	R	G	A	G	OEM Patch 12.
A7h	R	G	A	G	Build SMBIOS table and MP tables.
A7h	R	G	A	G	Program hot key and timeout settings in keyboard controller.
A7h	R	G	A	G	Processor initialization before boot.
A7h	R	G	A	G	Copy required language strings to shadow RAM.
AAh	A	Off	A	Off	Clear video screen.
000h	Off	Off	Off	Off	One beep to indicate end of POST. No beep if silent boot is enabled.
000h	Off	Off	Off	Off	POST completed. Passing control to INT 19h boot loader next.

## POST Codes and Error Messages

The following table defines POST error codes and their associated messages. The BIOS prompts the user to press a key in case of a serious error. Some error messages are preceded by the string "Error" to highlight that the system might be malfunctioning. All POST errors and warnings are logged in the system event log unless it is full.

**Table 18. POST Codes and Error Messages**

Error Code	Error Message	Pause on Boot	FRU/Action
100	Timer Channel 2 Error	Yes	1. System Board
101	Master Interrupt Controller	Yes	1. System Board
102	Slave Interrupt Controller	Yes	1. System Board
103	CMOS Battery Failure	Yes	1. Battery
104	CMOS Options not Set	Yes	1. Run Configuration/ Setup 2. Battery
105	CMOS Checksum Failure	Yes	1. Run Configuration/ Setup 2. Battery
106	CMOS Display Error	Yes	1. Run Configuration/ Setup 2. Battery
107	Insert Key Pressed	Yes	1. Keyboard
108	Keyboard Locked Message	Yes	1. Keyboard
109	Keyboard Stuck Key	Yes	1. Keyboard
10A	Keyboard Interface Error	Yes	1. Keyboard
10B	System Memory Size Error	Yes	1. Run Configuration/ Setup 2. Check DIMM
10E	External Cache Failure	Yes	1. System Board
110	Floppy Controller Error	Yes	1. System Board
111	Floppy A: Error	Yes	1. Floppy 2. Floppy Cable
112	Floppy B: Error	Yes	1. Floppy 2. Floppy Cable
113	Hard disk 0 Error	Yes	1. Fixed Disk Drive 2. Fixed Disk Cables
114	Hard disk 1 Error	Yes	1. Fixed Disk Drive 2. Fixed Disk Cables
117	CD-ROM disk 0 Error	Yes	1. CD-ROM Drive 2. CD-ROM Cables
11B	Date/Time not set	Yes	1. Run Configuration/ Setup 2. Battery
11E	Cache memory bad	Yes	1. Processor
120	CMOS clear	Yes	1. Check CMOS Clear Jumper

continued

**Table 18. POST Codes and Error Messages (continued)**

<b>Error Code</b>	<b>Error Message</b>	<b>Pause on Boot</b>	<b>FRU/Action</b>
121	Password clear	Yes	1. Check Password clear Jumper
140	PCI Error	Yes	1. System Board 2. PCI card
141	PCI Memory Allocation Error	Yes	1. Run Configuration/ Setup 2. Check PCI Resources 3. Failing Adapter
142	PCI IO Allocation Error	Yes	1. Run Configuration/ Setup 2. Check PCI Resources 3. Failing Adapter
143	PCI IRQ Allocation Error	Yes	1. Run Configuration/ Setup 2. Check PCI Resources 3. Failing Adapter
144	Shadow of PCI ROM Failed	Yes	1. Run Configuration/ Setup 2. Check PCI Resources 3. Failing Adapter
145	PCI ROM not found	Yes	1. Run Configuration/ Setup 2. Check PCI Resources 3. Failing Adapter
146	Insufficient Memory to Shadow PCI ROM	Yes	1. Run Configuration/ Setup 2. Check PCI Resources 3. Failing Adapter

**Table 19. Extended POST Error Messages and Codes**

<b>Error Code</b>	<b>Error Message</b>	<b>Pause on Boot</b>	<b>FRU/Action</b>
8100	Processor 1 failed BIST	No	1. Processor - Retest Processor via Setup
8101	Processor 2 failed BIST	No	1. Processor - Retest Processor via Setup
8110	Processor 1 Internal error (IERR)	No	1. Processor - Retest Processor via Setup
8111	Processor 2 Internal error (IERR)	No	1. Processor - Retest Processor via Setup
8120	Processor 1 Thermal Trip error	No	1. Processor - Retest Processor via Setup 2. Ensure proper cooling
8121	Processor 2 Thermal Trip error	No	1. Processor - Retest Processor via Setup 2. Ensure proper cooling
8130	Processor 1 disabled	No	1. Processor - Retest Processor via Setup
8131	Processor 2 disabled	No	1. Processor - Retest Processor via Setup
8140	Processor 1 failed FRB-3 timer	No	1. Processor - Retest Processor via Setup
8141	Processor 2 failed FRB-3 timer	No	1. Processor - Retest Processor via Setup
8150	Processor 1 failed initialization on last boot.	No	1. Processor - Retest Processor via Setup
8151	Processor 2 failed initialization on last boot.	No	1. Processor - Retest Processor via Setup

continued

**Table 19. Extended POST Error Messages and Codes** (continued)

<b>Error Code</b>	<b>Error Message</b>	<b>Pause on Boot</b>	<b>FRU/Action</b>
8160	Processor 01: unable to apply BIOS update	Yes	1. Processor
8161	Processor 02: unable to apply BIOS update	Yes	1. Processor
8170	Processor P1 :L2 cache Failed	Yes	1. Processor
8171	Processor P2 :L2 cache Failed	Yes	1. Processor
8180	Bios does not support current stepping for Processor P1	Yes	1. Processor
8181	Bios does not support current stepping for Processor P2	Yes	1. Processor
8190	Watchdog Timer failed on last boot	No	1. Run Configuration/ Setup
8191	4:1 Core to bus ratio: Processor Cache disabled	Yes	1. Processor
8192	L2 Cache size mismatch	Yes	1. Processor
8193	CPUID, Processor Stepping are different	Yes	1. Processor
8194	CPUID, Processor Family are different	Yes	1. Processor
8195	Front Side Bus Speed mismatch. System Halted	Yes, Halt	1. Processor
8196	Processor Model are different	Yes	1. Processor
8197	CPU Speed mismatch	Yes	1. Processor
8300	Baseboard Management Controller failed to function	Yes	1. Check Firmware 2. System Board
8301	Front Panel Controller failed to Function	Yes	1. Font Panel
84F2	Server Management Interface Failed	Yes	1. Check Firmware 2. System Board
84F3	BMC in Update Mode	Yes	1. Check Firmware 2. System Board
84F4	Sensor Data Record Empty	Yes	1. Check Firmware 2. System Board
84FF	System Event Log Full	Yes	1. Check Configuration/Setup. 2. Clear Event Log

## POST Error Beep Codes

The following tables list POST error beep codes. Prior to system video initialization, The BIOS and BMC use these beep codes to inform users on error conditions

**Table 20. BMC Generated POST Beep Codes**

Code	Description	FRU/Action
1-5-1-1	FRB failure (processor failure)	1. Processor 2. System Board
1-5-2-1	Empty Processor	1. Processor
1-5-2-2	No Processor	1. Processor
1-5-4-2	Power fault: DC power unexpectedly lost (power control failures)	1. Power Supply 2. System Board
1-5-4-3	Chipset control failure	1. System Board
1-5-4-4	Power control failure	1. System Board

**Table 21. BIOS Generated POST Error Beep Codes**

Beeps	Error message	Description	FRU/Action
1	Refresh timer failure	The memory refresh circuitry on the motherboard is faulty.	1. System Board
2	Parity error	Parity cannot be reset.	1. Check DIMMs 2. System Board
3	Base memory failure	Base memory test failure.	1. Check DIMMs
4	System timer	System timer is not operational.	1. System Board
5	Processor failure	Processor failure detected.	1. Processor
6	Keyboard controller Gate A20 failure	The keyboard controller may be bad. The BIOS cannot switch to protected mode.	1. Keyboard 2. System Board
7	Processor exception interrupt error	The CPU generated an exception interrupt.	1. Processor 2. Sytem Board
8	Display memory read/write error	The system video adapter is either missing or its memory is faulty. This is not a fatal error.	1. Video Adapter 2. System Board
9	ROM checksum error	System BIOS ROM checksum error.	1. System Firmware 2. System Board
10	Shutdown register error	Shutdown CMOS register read/write error detected.	1. System Board
11	Invalid BIOS	General BIOS ROM error.	1. System Firmware 2. System Board

**Table 22. POST Memory Error 3-Beep Codes**

Beep Code	Debug port 80h error indicators	Diagnostic LED Decoder				Meanings	FRU/Action
		G=Green, R=Red, A=Amber					
		Hi			Low		
3	00h	Off	Off	Off	Off	No memory was found in the system.	1. Check DIMMs
3	01h	Off	Off	Off	G	Memory mixed type detected.	1. Check DIMMs
3	02h	Off	Off	G	Off	EDO is not supported.	1. Check DIMMs
3	03h	Off	Off	G	G	First row memory test failure.	1. Check DIMMs
3	04h	Off	G	Off	Off	Mismatched DIMMs in a row.	1. Check DIMMs
3	05h	Off	G	Off	G	Base memory test failure.	1. Check DIMMs
3	06h	Off	G	G	Off	Failure on decompressing post module.	1. Check DIMMs
3	07h-0Dh	Off G G G G G G	G Off Off Off G G	G Off Off G Off Off	G Off G Off G	Generic memory error.	1. Check DIMMs
3	0Eh	G	G	G	Off	SMBUS protocol error.	1. Check DIMMs 2. Check Firmware
3	0F-FFh	All other combinations				Generic memory error.	1. Check DIMMs

## PC Doctor Symptom to FRU

**Table 23. Diagnostic Related Syndromes**

No.	Short Name	Description	FRU
1	NULL	Undetected Error	
2	CPU/Coprocessor	Any subtest fails	Processor
3	Systemboard	Any subtest fails	Systemboard
4	Video Adapter	Any subtest fails	Adapter card, if present Else, systemboard
5	Serial Ports	Any subtest fails	Systemboard
6	Parallel Ports	Any subtest fails	Systemboard
7	Hard Drive	Any subtest fails	Hard Drive
8	Diskette Drive	Any subtest fails	Diskette Drive
9	Memory Tests	Any subtest fails	Memory DIMM
10	Intel Ethernet Test	Test fails	Systemboard
11	Zip Drive	Any subtest fails	Zip Drive
12	HiFD Drive	Any subtest fails	HiFD Drive
13	LS120/240 Drive	Any subtest fails	LS120/240 Drive
14	CD-ROM/DVD Drive	Any subtest fails	CD-ROM/DVD Drive
15	SCSI Controller	Test fails	Systemboard
16	RAID Controller	Test fails	ServeRAID® card





# B Equipment Log and Configuration Worksheet

---

## Equipment Log

Use the blank equipment log provided here to record information about your system. You will need some of this information when you run BIOS Setup.

Item	Manufacturer Name and Model Number	Serial Number	Date Installed
System			
System Baseboard			
Processor Speed and Cache			
Keyboard			
Mouse			
Floppy Drive			
CD-ROM Drive			
Hard Disk Drive (1)			
Hard Disk Drive (2)			
First Installed Power Supply			
Second Installed Power Supply			
PCI Slot (1)			
PCI Slot (2)			
PCI Slot (3)			
PCI Slot (4)			
PCI Slot (5)			
PCI Slot (6)			



# C Solving Problems

---

This section helps you identify and solve problems that might occur while you are using the system.

## Resetting the System

To do this:	Press:
Soft boot reset, which clears system memory and reloads the operating system.	<Ctrl+Alt+Del>
Clear system memory, restart POST, and reload the operating system.	Reset button
Cold boot reset. Turn the system power off and then on. This clears system memory, restarts POST, reloads the operating system, and halts power to all peripherals.	Power off/on

## Initial System Startup

Problems that occur at initial system startup are usually caused by incorrect installation or configuration. Hardware failure is a less frequent cause.

### Initial System Startup Checklist

- Are the power supplies turned on? Check the switches on the back of the chassis.
- Are all cables correctly connected and secured?
- Are the processors or processor termination board fully seated in their slots on the server board?
- Are all add-in PCI boards fully seated in their slots on the server board?
- Are all jumper settings on the server board correct?
- Are all jumper and switch settings on add-in boards and peripheral devices correct? To check these settings, refer to the manufacturer's documentation that comes with them. If applicable, ensure that there are no conflicts—for example, two add-in boards sharing the same interrupt.
- Are all DIMMs installed correctly?
- Are all peripheral devices installed correctly?
- If the system has a hard disk drive, is it properly formatted or configured?
- Are all device drivers properly installed?
- Are the configuration settings made in Setup correct?
- Is the operating system properly loaded? Refer to the operating system documentation.
- Did you press the system power on/off switch on the front panel to turn the server on (power on light should be lit)?
- Is DC power available?
- Are all integrated components from the tested components lists? Check the tested memory and chassis lists, as well as the supported hardware and operating system list on the IBM Customer Support website.

# Running New Application Software

Problems that occur when you run new application software are usually related to the software. Faulty equipment is much less likely, especially if other software runs correctly.

## Running New Application Software Checklist

- Does the system meet the minimum hardware requirements for the software? See the software documentation.
- Is the software an authorized copy? If not, get one; unauthorized copies often do not work.
- If you are running the software from a diskette, is it a good copy?
- If you are running the software from a CD-ROM disk, is the disk scratched or dirty?
- If you are running the software from a hard disk drive, is the software correctly installed? Were all necessary procedures followed and files installed?
- Are the correct device drivers installed?
- Is the software correctly configured for the system?
- Are you using the software correctly?
- If the problems persist, contact the software vendor's customer service representative.

## After the System Has Been Running Correctly

Problems that occur after the system hardware and software have been running correctly often indicate equipment failure. Many situations that are easy to correct, however, can also cause such problems.

## After the System Has Been Running Correctly Checklist

- If you are running the software from a diskette, try a new copy of the software.
- If you are running the software from a CD-ROM disk, try a different disk to see if the problem occurs on all disks.
- If you are running the software from a hard disk drive, try running it from a diskette. If the software runs correctly, there may be a problem with the copy on the hard disk drive. Reinstall the software on the hard disk, and try running it again. Make sure all necessary files are installed.
- If the problems are intermittent, there may be a loose cable, dirt in the keyboard (if keyboard input is incorrect), a marginal power supply, or other random component failures.
- If you suspect that a transient voltage spike, power outage, or brownout might have occurred, reload the software and try running it again. (Symptoms of voltage spikes include a flickering video display, unexpected system reboots, and the system not responding to user commands.)

### Note

**Random errors in data files:** If you are getting random errors in your data files, they may be getting corrupted by voltage spikes on your power line. If you are experiencing any of the above symptoms that might indicate voltage spikes on the power line, you may want to install a surge suppressor between the power outlet and the system power cord.

## More Problem Solving Procedures

This section provides a more detailed approach to identifying a problem and locating its source.

### Preparing the System for Diagnostic Testing

#### Note

**Turn off devices before disconnecting cables:** Before disconnecting any peripheral cables from the system; turn off the system and any external peripheral devices. Failure to do so can cause permanent damage to the system and/or the peripheral devices.

- Turn off the system and all external peripheral devices. Disconnect all of them from the system, except the keyboard and video monitor.
- Make sure the DC power is applied to the terminals on the system and that the system is properly grounded.
- Make sure your video display monitor and keyboard are correctly connected to the system. Turn on the video monitor. Set its brightness and contrast controls to at least two thirds of their maximum ranges (see the documentation supplied with your video display monitor).
- If the operating system normally loads from the hard disk drive, make sure there is no diskette in drive A. Otherwise, place a diskette containing the operating system files in drive A.
- Turn on the system. If the power LED does not light, see “Power Light Does Not Light” on page 115.

### Monitoring POST

Refer to Addendum A on page 98 for POST Error Codes, Messages and FRU to Failure Information.

### Verifying Proper Operation of Key System Lights

As POST determines the system configuration, it tests for the presence of each mass storage device installed in the system. As each device is checked, its activity light should turn on briefly. Check for the following:

Does the diskette drive activity light turn on briefly? If not, see “Diskette Drive Activity Light Does Not Light” on page 116.

If a second diskette drive is installed, does its activity light turn on briefly? If not, see “Diskette Drive Activity Light Does Not Light” on page 116.

### Confirming Loading of the Operating System

Once the system boots up, the operating system prompt appears on the screen. The prompt varies according to the operating system. If the operating system prompt does not appear, see “Initial System Startup” on page 112.

## Specific Problems and Corrective Actions

This section provides possible solutions for these specific problems:

- Power light does not light.
- There is no beep or an incorrect beep pattern.
- No characters appear on screen.
- Characters on the screen appear distorted or incorrect.
- System cooling fans do not rotate.
- Diskette drive activity light does not light.
- CD-ROM drive activity light does not light.
- There are problems with application software.
- The bootable CD-ROM is not detected.

Try the solutions in the order given. If you cannot correct the problem, contact your service representative or authorized dealer for help.

### Power Light Does Not Light

Check the following:

- Is the system operating normally? If so, the power LED is probably defective or the cable from the front panel to the server board is loose.
- Are there other problems with the system? If so, check the items listed under “System Cooling Fans Do Not Rotate Properly.”
- If all items are correct and problems persist, contact your service representative or authorized dealer for help.

### No Characters Appear on Screen

Check the following:

- Is the keyboard functioning? Check to see that the “Num Lock” light is functioning.
- Is the video monitor plugged in and turned on?
- Are the brightness and contrast controls on the video monitor properly adjusted?
- Are the video monitor switch settings correct?
- Is the video monitor signal cable properly installed?
- Is the onboard video controller enabled?

If you are using an add-in video controller board, do the following:

- Verify that the video controller board is fully seated in the server board connector.
- Reboot the system for changes to take effect.
- If there are still no characters on the screen after you reboot the system and POST emits a beep code, write down the beep code you hear. This information is useful for your service representative.
- If you do not receive a beep code and characters do not appear, the video display monitor or video controller may have failed. Contact your service representative or authorized dealer for help.

## Characters Are Distorted or Incorrect

Check the following:

- Are the brightness and contrast controls properly adjusted on the video monitor? See the manufacturer's documentation.
- Is the video monitor signal and power cable properly installed?
- If the problem persists, the video monitor may be faulty or it may be the incorrect type. Contact your service representative or authorized dealer for help.

## System Cooling Fans Do Not Rotate Properly

If the system cooling fans are not operating properly, system components could be damaged.

Check the following:

- Is DC Power applied to the power terminals on the back panel?
- Did you press the power button?
- Is the power on light lit?
- Have any of the fan motors stopped (use the server management subsystem to check the fan status)?
- Are the fan power connectors properly connected to the server board?
- Is the cable from the front panel board connected to the server board?
- Are the power supply cables properly connected to the server board?
- Are there any shorted wires caused by pinched cables?

If after double-checking the above list the system fans do not rotate properly contact your service representative or authorized dealer for help.

## Diskette Drive Activity Light Does Not Light

Check the following:

- Are the diskette drive's power and signal cables properly installed?
- Are all relevant switches and jumpers on the diskette drive set correctly?
- Is the diskette drive properly configured?
- Is the diskette drive activity light always on? If so, the signal cable may be plugged in incorrectly.
- If you are using the onboard diskette controller, use the Setup Utility to make sure that "Onboard Floppy" is set to "Enabled." If you are using an add-in diskette controller, make sure that "Onboard Floppy" is set to "Disabled."

If the problem persists, there may be a problem with the diskette drive, server board, or drive signal cable. Contact your service representative or authorized dealer for help.

## Hard Disk Drive Activity Light Does Not Light

The hard disk drive activity light is not connected to the xSeries 343 server board.



## CD-ROM Drive Activity Light Does Not Light

Check the following:

- Are the power and signal cables to the CD-ROM drive properly installed?
- Are all relevant switches and jumpers on the drive set correctly?
- Is the drive properly configured?
- Is the onboard IDE controller enabled?

## Cannot Connect to a Server

- Make sure you are using the drivers that are shipped on the system *Documentation and Resource CD* for the onboard network controller.
- Make sure the driver is loaded and the protocols are bound.
- Make sure the network cable is securely attached to the connector at the system back panel. If the cable is attached but the problem persists, try a different cable.
- Make sure the hub port is configured for the same duplex mode as the network controller.
- Check with your LAN administrator about the correct networking software that needs to be installed.
- If you are directly connecting two servers (no hub), you will need a crossover cable (see your hub documentation for more information on crossover cables).

Check the network controller LEDs that are visible through an opening at the system back panel.

## Problems with Network

**The server hangs when the drivers are loaded.**

Change the PCI BIOS interrupt settings. Try the “PCI Installation Tips” below.

**Diagnostics pass, but the connection fails.**

- Make sure the network cable is securely attached.
- Make sure you specify the correct frame type in your NET.CFG file.

**The Activity LED doesn't light.**

- The network activity light is not connected to the xSeries 343 server board.

**The controller stopped working when an add-in card was installed.**

- Make sure the cable is connected to the port from the onboard network controller.
- Make sure your PCI BIOS is current. Try the “PCI Installation Tips” below.
- Make sure the other adapter supports shared interrupts. Also, make sure your operating system supports shared interrupts; OS/2 does not.
- Try reseating the add-in card.

**The add-in card stopped working without apparent cause.**

- Try reseating the add-in card first; then try a different slot if necessary.
- The network driver files may be corrupt or deleted. Delete and then reinstall the drivers.
- Run the diagnostics.

## PCI Installation Tips

Some common PCI tips are listed here.

- Reserve interrupts (IRQs) and/or memory addresses specifically for ISA add-in cards. This prevents PCI add-in cards from trying to use the same settings ISA add-in cards are using. Use the SSU to keep track of ISA add-in card resources.
- Certain drivers may require interrupts that are not shared with other PCI drivers. The SSU can be used to adjust the interrupt numbers for PCI devices. For certain drivers, it may be necessary to alter settings so that interrupts are not shared.

## Problems with Application Software

If you have problems with application software, do the following:

- Verify that the software is properly configured for the system. See the software installation and operation documentation for instructions on setting up and using the software.
- Try a different copy of the software to see if the problem is with the copy you are using.
- Make sure all cables are installed correctly.
- Verify that the server board jumpers are set correctly. See Chapter 5.
- If other software runs correctly on the system, contact your vendor about the failing software.
- If the problem persists, contact the software vendor's customer service representative for help.

## Bootable CD-ROM Is Not Detected

Check the following:

Is the BIOS set to allow the CD-ROM to be the first bootable device?

## Problem Determination Tips

Due to the variety of hardware and software combinations that can be encountered, use the following information to assist you in problem determination. If possible, have this information available when requesting assistance from Service Support and Engineering functions.

- Machine type and model
- Processor or hard disk upgrades
- Failure symptom
  - Do diagnostics fail?
  - What, when, where, single, or multiple systems?
  - Is the failure repeatable?
  - Has this configuration ever worked?
  - If it has been working, what changes were made prior to it failing?
  - Is this the original reported failure?
- Reference/Diagnostics version
  - Type and version level
- Hardware configuration
  - Print (print screen) configuration currently in use
  - BIOS level
- Operating system software
  - Type and version level

### Note

To eliminate confusion, identical systems are considered identical only if they:

- Are the exact machine type and models
- Have the same BIOS level
- Have the same adapters/attachments in the same locations
- Have the same address jumpers/terminators/cabling
- Have the same software versions and levels
- Have the same Reference/Diagnostics Diskette (version)
- Have the same configuration options set in the system
- Have the same setup for the operation system control files

Comparing the configuration and software set-up between "working and non- working" systems will often lead to problem resolution.

## D Getting Information, Help, and Services

---

If you need help, service, or technical assistance or just want more information about IBM products, you will find a wide variety of sources available from IBM to assist you. This section contains information about where to go for additional information about IBM and IBM products, what to do if you experience a problem with your computer, and whom to call for service should it be necessary.

### Getting Information

Information about your IBM server product and preinstalled software, if any, is available in the documentation that comes with your server. That documentation includes printed books, online books, README files, and help files. In addition, information about IBM products is available on the World Wide Web.

On the World Wide Web, the IBM Web site has up-to-date information about IBM products and support. The address for the IBM Personal Computing home page is <http://www.ibm.com/pc/>.

You can find support information for your IBM products at <http://www.ibm.com/pc/support/>.

If you click **Profile** from the support page, you can create a customized support page that is specific to your hardware, complete with Frequently Asked Questions, Parts Information, Technical Hints and Tips, and Downloadable Files. In addition, you can choose to receive e-mail notifications whenever new information becomes available about your registered products.

You also can order publications through the IBM Publications Ordering System at <http://www.elink.ibm.com/public/applications/publications/cgibin/pbi.cgi>.

### Getting Help and Service

If you have a problem with your server product, you will find a wide variety of sources available to help you.

### Using the Documentation and Diagnostic Programs

Many problems can be solved without outside assistance. If you experience a problem with your server product, the first place to start is the troubleshooting information in your IBM documentation. If you suspect a software problem, see the documentation, including README files and online help, that comes with the operating system or application program.

Most IBM server products come with a set of diagnostic programs that you can use to help you identify hardware problems. See the troubleshooting information in your IBM documentation for instructions on using the diagnostic programs.

The troubleshooting information or the diagnostic programs might tell you that you need additional or updated device drivers or other software. IBM maintains pages on the World Wide Web where you can get the latest technical information and download device drivers and updates. To access these pages, go to <http://www.ibm.com/pc/support/> and follow the instructions.

## Software Service and Support

Customer telephone assistance with usage, configuration, and software defects for the xSeries servers, workstations and appliances is provided via IBM Operational Support Services - Support Line. For information about what products are supported by Support Line in your country, see <http://www.ibm.com/services/sl/products>.

For more information about Support Line and other IBM Services see <http://www.ibm.com/services> or see [www.ibm.com/planetwide/](http://www.ibm.com/planetwide/) for in country telephone numbers.

## Hardware Service and Support

Hardware services can be provided either by IBM Integrated Technology Services (see <http://www.ibm.com/planetwide/> for in country telephone numbers), or your reseller, if approved by IBM to provide warranty service.

In the U.S. and Canada, these services are available 24 hours a day, 7 days a week. In the U.K., these services are available Monday through Friday, from 9:00 a.m. to 6:00 p.m.

- **Problem determination** - Trained personnel are available to assist you with determining if you have a hardware problem and deciding what action is necessary to fix the problem.
- **IBM hardware repair** - If the problem is determined to be caused by IBM hardware under warranty, trained service personnel are available to provide the applicable level of service.
- **Engineering Change management** - Occasionally, there might be changes that are required after a product has been sold. IBM or your reseller, if authorized by IBM, will make selected Engineering Changes (ECs) available that apply to your hardware.

The following items are not covered:

- Replacement or use of non-IBM parts or nonwarranted IBM parts. All warranted parts contain a 7-character identification in the format IBM FRU XXXXXXXX.
- Identification of software problem sources.
- Configuration of BIOS as part of an installation or upgrade.
- Changes, modifications, or upgrades to device drivers.
- Installation and maintenance of network operating systems (NOS).
- Installation and maintenance of application programs.

Refer to your IBM Statement of Limited Warranty for a full explanation of IBM warranty terms. Be sure to retain your proof of purchase to obtain warranty service.

In the U.S. and Canada, these services are available 24 hours a day, 7 days a week. In the U.K., these services are available Monday through Friday, from 9:00 a.m. to 6:00 p.m.

**Note:** Response times vary; may exclude some holidays.

Please have the following information ready when you call:

- Machine type and model
- Serial numbers of your IBM hardware products
- Description of the problem
- Exact wording of any error messages
- Hardware and software configuration information

## International Warranty Service

If you travel with your server product or relocate it to a country where your server machine type is sold, your server product might be eligible for International Warranty Service, which automatically entitles you to obtain warranty service throughout the warranty period. Service will be performed by IBM or by IBM resellers who are authorized to perform warranty service.

Service methods and procedures vary by country, and some services might not be available in all countries. International Warranty Service is delivered through the method of service (such as depot, carry-in, or on-site service) that is provided in the servicing country. Service centers in certain countries might not be able to service all models of a particular machine type. In some countries, fees and restrictions might apply at the time of service.

To determine whether your server product is eligible for International Warranty Service and to view a list of the countries where service is available, go to <http://www.ibm.com/pc/support/>, and click **Warranty Lookup**. Eligible IBM server products are identified by their four-digit machine types. For more information about International Warranty Service, see Service Announcement 601-034 at <http://www.ibm.com/>. Click **Support & downloads**, click **Announcement letters**, and click **Announcements search**. In the **Search by letter number only** field, type 601- 034, and click **Search**.

## Purchasing Additional Services

During and after the warranty period, you can purchase additional services, such as support for IBM and non-IBM hardware, operating systems, and application programs; network setup and configuration; upgraded or extended hardware repair services; and custom installations. Service availability and service name might vary by country or region.

For more information about these services, contact your IBM marketing representative.



# E Safety Addendum

---

## Related Service Information

### Note

The service procedures are designed to help you isolate problems. They are written with the assumption that you have model-specific training on all computers, or that are familiar with the computers, functions, terminology, and service information provided in this manual.

## Safety Information

The following section contains the safety information that you need to be familiar with before servicing an IBM computer.

### General Safety

Follow these rules to ensure general safety:

- Observe good housekeeping in the area of the machines during and after maintenance.
- When lifting any heavy object:
  1. Ensure you can stand safely without slipping.
  2. Distribute the weight of the object equally between your feet.
  3. Use a slow lifting force. Never move suddenly or twist when you attempt to lift.
  4. Lift by standing or by pushing up with your leg muscles; this action removes the strain from the muscles in your back. *Do not attempt to lift any objects that weigh more than 16 kg (35 lb) or objects that you think are too heavy for you.*
- Do not perform any action that causes hazards to the customer, or that makes the equipment unsafe.
- Before you start the machine, ensure that other service representatives and the customer's personnel are not in a hazardous position.
- Place removed covers and other parts in a safe place, away from all personnel, while you are servicing the machine.
- Keep your tool case away from walk areas so that other people will not trip over it.
- Do not wear loose clothing that can be trapped in the moving parts of a machine. Ensure that your sleeves are fastened or rolled up above your elbows. If your hair is long, fasten it.
- Insert the ends of your necktie or scarf inside clothing or fasten it with a nonconductive clip, approximately 8 centimeters (3 inches) from the end.
- Do not wear jewelry, chains, metal-frame eyeglasses, or metal fasteners for your clothing.  
**Remember:** Metal objects are good electrical conductors.
- Wear safety glasses when you are: hammering, drilling soldering, cutting wire, attaching springs, using solvents, or working in any other conditions that might be hazardous to your eyes.
- After service, reinstall all safety shields, guards, labels, and ground wires. Replace any safety device that is worn or defective.



Reinstall all covers correctly before returning the machine to the customer.

## Electrical Safety



### CAUTION

Electrical current from power, telephone, and communication cables can be hazardous. To avoid personal injury or equipment damage, disconnect the attached power cords, telecommunication systems, networks, and modems before you open the server covers, unless instructed otherwise in the installation and configuration procedures.

Observe the following rules when working on electrical equipment.

### Important

Use only approved tools and test equipment. Some hand tools have handles covered with a soft material that does not insulate you when working with live electrical currents.

Many customers have, near their equipment, rubber floor mats that contain small conductive fibers to decrease electrostatic discharges. Do not use this type of mat to protect yourself from electrical shock.

- Find the room emergency power-off (EPO) switch, disconnecting switch, or electrical outlet. If an electrical accident occurs, you can then operate the switch or unplug the power cord quickly.
- Do not work alone under hazardous conditions or near equipment that has hazardous voltages.
- Disconnect all power before:
  - Performing a mechanical inspection
  - Working near power supplies
  - Removing or installing main units
- Before you start to work on the machine, unplug the power cord. If you cannot unplug it, ask the customer to power-off the wall box that supplies power to the machine and to lock the wall box in the off position.
- If you need to work on a machine that has exposed electrical circuits, observe the following precautions:
  - Ensure that another person, familiar with the power-off controls, is near you.

**Remember:** Another person must be there to switch off the power, if necessary.
  - Use only one hand when working with powered-on electrical equipment; keep the other hand in your pocket or behind your back.

**Remember:** There must be a complete circuit to cause electrical shock. By observing the above rule, you may prevent a current from passing through your body.
  - When using testers, set the controls correctly and use the approved probe leads and accessories for that tester.

- Stand on suitable rubber mats (obtained locally, if necessary) to insulate you from grounds such as metal floor strips and machine frames.

Observe the special safety precautions when you work with very high voltages; these instructions are in the safety sections of maintenance information. Use extreme care when measuring high voltages.

- Regularly inspect and maintain your electrical hand tools for safe operational condition.
- Do not use worn or broken tools and testers.
- *Never assume* that power has been disconnected from a circuit. First, *check* that it has been powered-off.
- Always look carefully for possible hazards in your work area. Examples of these hazards are moist floors, nongrounded power extension cables, power surges, and missing safety grounds.
- Do not touch live electrical circuits with the reflective surface of a plastic dental mirror. The surface is conductive; such touching can cause personal injury and machine damage.
- Do not service the following parts with the power on when they are removed from their normal operating places in a machine:
  - Power supply units
  - Pumps
  - Blowers and fans
  - Motor generatorsand similar units. (This practice ensures correct grounding of the units.)
- If an electrical accident occurs:
  - Use caution; do not become a victim yourself.
  - Switch off power.
  - Send another person to get medical aid.

## Safety Inspection Guide

The intent of this inspection guide is to assist you in identifying potentially unsafe conditions on these products. Each machine, as it was designed and built, had required safety items installed to protect users and service personnel from injury. This guide addresses only those items. However, good judgment should be used to identify potential safety hazards due to attachment of non-IBM features or options not covered by this inspection guide.

If any unsafe conditions are present, you must determine how serious the apparent hazard could be and whether you can continue without first correcting the problem.

Consider these conditions and the safety hazards they present:

- Electrical hazards, especially primary power (primary voltage on the frame can cause serious or fatal electrical shock).
- Explosive hazards, such as a damaged CRT face or bulging capacitor
- Mechanical hazards, such as loose or missing hardware

The guide consists of a series of steps presented in a checklist. Begin the checks with the power off, and the power cord disconnected.

**Checklist:**

1. Check exterior covers for damage (loose, broken, or sharp edges).
2. Power-off the computer. Disconnect the power cord.  
Check the power cord for:
  - a. A third-wire ground connector in good condition. Use a meter to measure third-wire ground continuity for 0.1 ohm or less between the external ground pin and frame ground.
  - b. The power cord should be the appropriate type as specified in the parts listings.
  - c. Insulation must not be frayed or worn.
3. Remove the cover.
4. Check for any obvious non-IBM alterations. Use good judgment as to the safety of any non-IBM alterations.
5. Check inside the unit for any obvious unsafe conditions, such as metal filings, contamination, water or other liquids, or signs of fire or smoke damage.
6. Check for worn, frayed, or pinched cables.
7. Check that the power-supply cover fasteners (screws or rivets) have not been removed or tampered with.

## Handling Electrostatic Discharge-sensitive Devices

Any computer part containing transistors or integrated circuits (ICs) should be considered sensitive to electrostatic discharge (ESD). ESD damage can occur when there is a difference in charge between objects. Protect against ESD damage by equalizing the charge so that the machine, the part, the work mat, and the person handling the part are all at the same charge.

### Notes

1. Use product-specific ESD procedures when they exceed the requirements noted here.
2. Make sure that the ESD protective devices you use have been certified (ISO 9000) as fully effective.

When handling ESD-sensitive parts:

- Keep the parts in protective packages until they are inserted into the product.
- Avoid contact with other people.
- Wear a grounded wrist strap against your skin to eliminate static on your body.
- Prevent the part from touching your clothing. Most clothing is insulative and retains a charge even when you are wearing a wrist strap.
- Use the black side of a grounded work mat to provide a static-free work surface. The mat is especially useful when handling ESD-sensitive devices.

- Select a grounding system, such as those listed below, to provide protection that meets the specific service requirement.

**Note**

The use of a grounding system is desirable but not required to protect against ESD damage.

- Attach the ESD ground clip to any frame ground, ground braid, or green-wire ground.
- Use an ESD common ground or reference point when working on a double- insulated or battery-operated system. You can use coax or connector-outside shells on these systems.
- Use the round ground-prong of the ac plug on ac-operated computers.

## Grounding Requirements

Electrical grounding of the computer is required for operator safety and correct system function. Proper grounding of the electrical outlet can be verified by a certified electrician.

## Safety Notices (multi-lingual translations)

The caution and danger safety notices in this section are provided in the following languages:

- English
- Brazilian/Portuguese
- Chinese
- French
- German
- Italian
- Korean
- Spanish

## Important

All caution and danger statements in this IBM documentation begin with a number. This number is used to cross reference an English caution or danger statement with translated versions of the caution or danger statement in this section.

For example, if a caution statement begins with a number 1, translations for that caution statement appear in this section under statement 1.

Be sure to read all caution and danger statements before performing any of the instructions.

### Statement 1



## DANGER

**Electrical current from power, telephone, and communication cables is hazardous.**

**To avoid a shock hazard:**

- **Do not connect or disconnect any cables or perform installation, maintenance, or reconfiguration of this product during an electrical storm.**
- **Connect all power cords to a properly wired and grounded electrical outlet.**
- **Connect to properly wired outlets any equipment that will be attached to this product.**
- **When possible, use one hand only to connect or disconnect signal cables.**
- **Never turn on any equipment when there is evidence of fire, water, or structural damage.**
- **Disconnect the attached power cords, telecommunications systems, networks, and modems before you open the device covers, unless instructed otherwise in the installation and configuration procedures.**
- **Connect and disconnect cables as described in the following table when installing, moving, or opening covers on this product or attached devices.**

#### **To Connect:**

1. Turn everything OFF.
2. First, attach all cables to devices.
3. Attach signal cables to connectors.
4. Attach power cords to outlet.
5. Turn device ON.

#### **To Disconnect:**

1. Turn everything OFF.
2. First, remove power cords from outlet.
3. Remove signal cables from connectors.
4. Remove all cables from devices.

### Statement 2



#### CAUTION

When replacing the lithium battery, use only IBM Part Number 33F8354 or an equivalent type battery recommended by the manufacturer. If your system has a module containing a lithium battery, replace it only with the same module type made by the same manufacturer. The battery contains lithium and can explode if not properly used, handled, or disposed of.

Do not:

- Throw or immerse into water
- Heat to more than 100 °C (212 °F)
- Repair or disassemble

Dispose of the battery as required by local ordinances or regulations.

### Statement 3



#### CAUTION

When laser products (such as CD-ROMs, DVD drives, fiber optic devices, or transmitters) are installed, note the following:

1. Do not remove the covers. Removing the covers of the laser product could result in exposure to hazardous laser radiation. There are no serviceable parts inside the device.
2. Use of controls or adjustments or performance of procedures other than those specified herein might result in hazardous radiation exposure.



#### CAUTION

Some laser products contain an embedded Class 3A or Class 3B laser diode. Note the following.

Laser radiation when open. Do not stare into the beam, do not view directly with optical instruments, and avoid direct exposure to the beam.

**Statement 4**

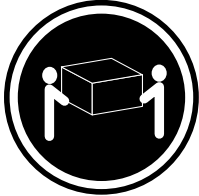

≥18 kg (39.7 lb)

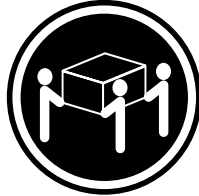

≥32 kg (70.5 lb)

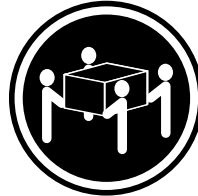

≥55 kg (121.2 lb)

**CAUTION**

Use safe practices when lifting.

**Statement 5**



**CAUTION**

The power control button on the device and the power switch on the power supply do not turn off the electrical current supplied to the device. The device also might have more than one power cord. To remove all electrical current from the device, ensure that all power cords are disconnected from the power source.

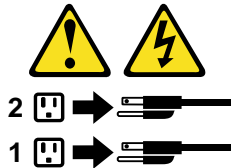

**Statement 10**



**CAUTION**

Do not place any object weighing more than 82 kg (180 lbs.) on top of rack-mounted devices.



>82 kg



## Importante

Todas as instruções de cuidado e perigo da IBM documentation começam com um número. Este número é utilizado para fazer referência cruzada de uma instrução de cuidado ou perigo no idioma inglês com as versões traduzidas das instruções de cuidado ou perigo encontradas nesta seção.

Por exemplo, se uma instrução de cuidado é iniciada com o número 1, as traduções para aquela instrução de cuidado aparecem nesta seção sob a instrução 1.

Certifique-se de ler todas as instruções de cuidado e perigo antes de executar qualquer operação.

### Instrução 1



### PERIGO

**A corrente elétrica proveniente de cabos de alimentação, de telefone e de comunicações é perigosa.**

**Para evitar risco de choque:**

- 1. Não conecte ou desconecte cabos e não realize instalação, manutenção ou reconfiguração deste produto durante uma tempestade com raios.**
- 2. Conecte todos os cabos de alimentação a tomadas elétricas corretamente instaladas e aterradas.**
- 3. Conecte todos os equipamentos ao qual esse produto será conectado a tomadas corretamente instaladas.**
- 4. Sempre que possível, utilize apenas uma das mãos para conectar ou desconectar cabos de sinal.**
- 5. Nunca ligue qualquer equipamento quando existir evidência de danos por fogo, água ou na estrutura.**
- 6. Desconecte cabos de alimentação, sistemas de telecomunicação, redes e modems antes de abrir as tampas dos dispositivos, a menos que especificado de maneira diferente nos procedimentos de instalação e configuração.**
- 7. Conecte e desconecte cabos conforme descrito na seguinte tabela, ao instalar ou movimentar este produto ou os dispositivos conectados, ou ao abrir suas tampas.**

<b>Para Conectar:</b>	<b>Para Desconectar:</b>
1. DESLIGUE Tudo.	1. DESLIGUE Tudo.
2. Primeiramente, conecte todos os cabos aos dispositivos.	2. Primeiramente, remova os cabos de alimentação das tomadas.
3. Conecte os cabos de sinal aos conectores.	3. Remova os cabos de sinal dos conectores.
4. Conecte os cabos de alimentação às tomadas.	4. Remova todos os cabos dos dispositivos.
5. LIGUE os dispositivos.	

## Instrução 2



### **CUIDADO**

Ao substituir a bateria de lítio, utilize apenas uma bateria IBM, Número de Peça 33F8354 ou uma bateria de tipo equivalente, recomendada pelo fabricante. Se o seu sistema possui um módulo com uma bateria de lítio, substitua-o apenas pelo mesmo tipo de módulo, do mesmo fabricante. A bateria contém lítio e pode explodir se não for utilizada, manuseada e descartada de maneira correta.

Não:

1. Jogue ou coloque na água
2. Aqueça a mais de 100°C (212°F)
3. Conserte nem desmonte

Para descartar a bateria, entre em contato com a área de atendimento a clientes IBM, pelo telefone (011) 889-8986, para obter informações sobre como enviar a bateria pelo correio para a IBM.

## Instrução 3



### **PRECAUCIÓN**

Quando produtos a laser (unidades de CD-ROM, unidades de DVD, dispositivos de fibra ótica, transmissores, etc.) estiverem instalados, observe o seguinte:

1. Não remova as tampas. A remoção das tampas de um produto a laser pode resultar em exposição prejudicial à radiação de laser. Nenhuma peça localizada no interior do dispositivo pode ser consertada.
2. A utilização de controles ou ajustes ou a execução de procedimentos diferentes dos especificados aqui pode resultar em exposição prejudicial à radiação.



### **PERIGO**

Alguns produtos a laser contêm um diodo laser da Classe 3A ou Classe 3B embutido. Observe o seguinte:

Radiação de laser quando aberto. Não olhe diretamente para o raio a olho nu ou com instrumentos óticos, e evite exposição direta ao raio.

#### Instrução 4

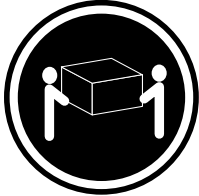

≥18 kg (39.7 lb)

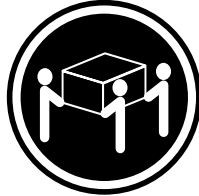

≥32 kg (70.5 lb)

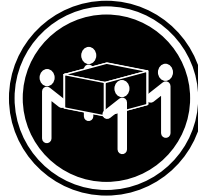

≥55 kg (121.2 lb)

#### CUIDADO

Ao levantar a máquina, faça-o com segurança.

#### Instrução 5



#### CUIDADO

Os botões Liga/Desliga localizados no dispositivo e na fonte de alimentação não desligam a corrente elétrica fornecida ao dispositivo. O dispositivo também pode ter mais de um cabo de alimentação. Para remover toda a corrente elétrica do dispositivo, assegure que todos os cabos de alimentação estejam desconectados da.

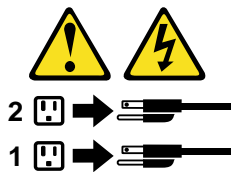

### Instrução 10



### CUIDADO

Não coloque nenhum objeto com peso superior a 82 kg (180 lbs.) sobre dispositivos montados em rack.

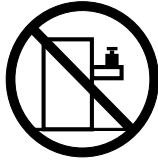

>82 kg

**重要：**

Server Library 中的所有提醒和危险条款前都有一个数字标识。该数字是用来交叉引用一个英文的提醒和危险条款及本部分中的与之对应的已翻译成其它文字的提醒和危险条款。

例如，如果一个提醒条款前的数字为 1，则本部分中相应的译文也带有标号 1。

在执行任何指示的操作之前，请确保您已经阅读了全部提醒和危险条款。

## 声明 2



### 警告:

更换锂电池时，只能使用 IBM 产品号 33F8354 或者是厂商推荐的等同类型的电池。

如果系统模块中含有锂电池，则只能使用同一厂商制造的同一类型的模块进行更换。电池中含有锂，如果使用、拿放或处理不当，可能会发生爆炸。

请勿对电池进行下列操作：  
扔入或浸入水中。  
加热超过 100 (212 F)  
进行修理或分解  
请按本地法规要求处理电池。

## 声明 3



### 警告:

安装激光产品（如 CD-ROM、DVD 驱动器、光纤设备或送话器）时，应注意以下事项：

不要拆除外盖。拆除激光产品的外盖可能会导致激光辐射的危险，本设备中没有用户可维修的部件。

非此处指定的其它控制、调整或与性能有关的操作都有可能导致激光辐射的危险。



### 危险

某些激光产品中包含内嵌的 3A 级或 3B 级激光二极管。请注意以下事项。

打开时会产生激光辐射。不要直视光束，不要使用光学仪器直接观看光束，避免直接暴露于光束之下。

#### 声明 4



≥18 kg (37 磅)



≥32 kg (70.5 磅)



≥55 kg (121.2 磅)

#### 警告:

抬起时请采用安全操作方法。

#### 声明 5



#### 警告:

使用设备上的电源控制按钮和电源上的开关都不能断开本设备上的电流。另外，本设备可能带有多条电源线。如要断开设备上的所有电流，请确保所有电源线均已与电源断开连接。

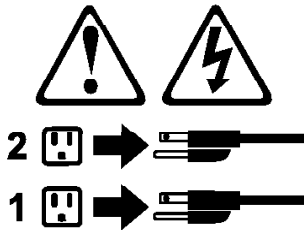

#### 声明 6



#### 警告:

如果在电源线连接设备的一端安装了固定松紧夹，则必须将电源线的另一端连接至使用方便的电源。

声明 7



**警告：**

如果设备带有外门，则在移动或抬起设备前应将其拆除或固定以避免造成人员伤害。外门支撑不了设备的重量。

声明 8



**警告：**

不要拆除电源外盖或贴有下列标签的任何部件。



贴有此标签的组件内部存在高电压、高电流的危险。这些组件中没有用户可维修的部件。如果怀疑其中的部件存在问题，应与服务技术人员联系。

声明 9



**警告：**

为避免人员伤害，拆除设备上的风扇前应拨下热插拔风扇电缆。

声明 10



**警告：**

机柜安装的设备上面不能放置重于 82kg（180 磅）的物品。



> 82 kg (180 磅)



## 声明 11



**警告：**

下面的标签表明附近有锋利的边、角或接头。



## 声明 12



**警告：**

下面的标签表明附近有高热表面。



重要資訊：

*Server Library* 中所有「注意」及「危險」的聲明均以數字開始。此一數字是用來作為交互參考之用，英文「注意」或「危險」聲明可在本節中找到相同內容的「注意」或「危險」聲明的譯文。

例如，有一「危險」聲明以數字 1 開始，則該「危險」聲明的譯文將出現在本節的「聲明」1 中。

執行任何指示之前，請詳讀所有「注意」及「危險」的聲明。

## 聲明 1



### 危險

電源、電話及通信電纜上所產生的電流均有危險性。

欲避免電擊危險：

- 在雷雨期間，請勿連接或切斷本產品上的任何電纜線，或安裝、維修及重新架構本產品。
- 請將電源線接至接線及接地正確的電源插座。
- 請將本產品隨附的設備連接至接線正確的插座。
- 儘可能使用單手來連接或切斷信號電纜線。
- 當設備有火燒或泡水的痕跡，或有結構性損害時，請勿開啓該設備的電源。
- 在安裝及架構之時，若非非常熟悉，在開啓裝置蓋子之前，請切斷電源線、電信系統、網路及數據機。
- 在安裝、移動本產品或附加裝置，或開啓其蓋子時，請依照下表中「連接」及「切斷」電纜線的步驟執行。

#### 連接：

1. 關閉所有開關。
2. 先將所有電纜線接上裝置。
3. 將信號電纜接上接頭。
4. 再將電源線接上電源插座。
5. 開啓裝置的電源。

#### 切斷：

1. 關閉所有開關。
2. 先自電源插座拔掉電源線。
3. 拔掉接頭上的所有信號電纜。
4. 再拔掉裝置上的所有電纜線。

## 聲明 2



### 注意：

更換鋰電池時，只可使用 IBM 零件編號 33F8354 的電池，或製造商建議之相當類型的電池。若系統中具有包含鋰電池的模組，在更換此模組時，請使用相同廠商製造的相同模組類型。如未正確使用、處理或丟棄含有鋰的電池時，可能會引發爆炸。

### 請勿將電池：

- 丟入或浸入水中
- 加熱超過 100 °C (212 °F)
- 修理或拆開

請遵照當地法令規章處理廢棄電池。

### 聲明 3



#### 注意：

安裝雷射產品 (如 CD-ROM、DVD 光碟機、光纖裝置或發射器) 時，請注意下列事項：

- 請勿移開蓋子。移開雷射產品的蓋子，您可能會暴露於危險的雷射輻射之下。裝置中沒有需要維修的組件。
- 不依此處所指示的控制、調整或處理步驟，您可能會暴露於危險的輻射之下。



#### 危險

有些雷射產品含有內嵌式 Class 3A 或 Class 3B 雷射二極體。請注意下列事項：

開啓時會產生雷射輻射。請勿凝視光束，不要使用光學儀器直接觀察，且應避免直接暴露在光束下。

## 聲明 4

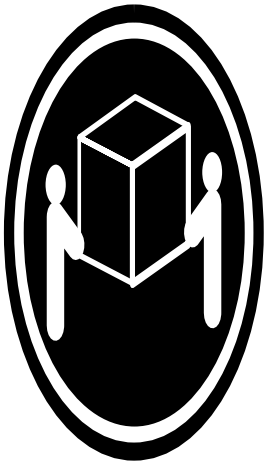

≥ 18 公斤 (37 磅)

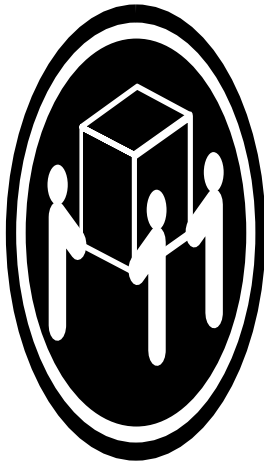

≥ 32 公斤 (70.5 磅)

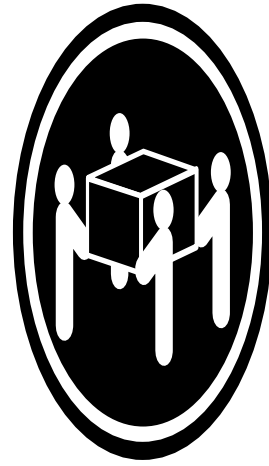

≥ 55 公斤 (121.2 磅)

注意：

抬起裝置時，請注意安全措施。

## 聲明 5



### 注意：

裝置上的電源控制按鈕及電源供應器上的電源開關均無法關閉裝置上的電流。  
本裝置可能有一條以上的電源線。如要移除裝置上的所有電流，請確認所有電源線已與電源分離。

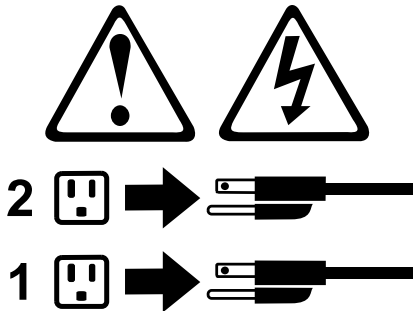

## 聲明 10



### 注意：

請勿將任何重量超過 82 公斤 (180 磅) 的物品置於已安裝機架的裝置上方。



> 82 公斤 (180 磅)

## Important

Toutes les consignes Attention et Danger indiquées dans la bibliothèque IBM documentation sont précédées d'un numéro. Ce dernier permet de mettre en correspondance la consigne en anglais avec ses versions traduites dans la présente section.

Par exemple, si une consigne de type Attention est précédée du chiffre 1, ses traductions sont également précédées du chiffre 1 dans la présente section.

Prenez connaissance de toutes les consignes de type Attention et Danger avant de procéder aux opérations décrites par les instructions.

### Notice n° 1



## DANGER

**Le courant électrique passant dans les câbles de communication, ou les cordons téléphoniques et d'alimentation peut être dangereux.**

**Pour éviter tout risque de choc électrique:**

- 1. Ne manipulez aucun câble et n'effectuez aucune opération d'installation, d'entretien ou de reconfiguration de ce produit au cours d'un orage.**
- 2. Branchez tous les cordons d'alimentation sur un socle de prise de courant correctement câblé et mis à la terre.**
- 3. Branchez sur des socles de prise de courant correctement câblés tout équipement connecté à ce produit.**
- 4. Lorsque cela est possible, n'utilisez qu'une seule main pour connecter ou déconnecter les câbles d'interface.**
- 5. Ne mettez jamais un équipement sous tension en cas d'incendie ou d'inondation, ou en présence de dommages matériels.**
- 6. Avant de retirer les carters de l'unité, mettez celle-ci hors tension et déconnectez ses cordons d'alimentation, ainsi que les câbles qui la relient aux réseaux, aux systèmes de télécommunication et aux modems (sauf instruction contraire mentionnée dans les procédures d'installation et de configuration).**
- 7. Lorsque vous installez ou que vous déplacez le présent produit ou des périphériques qui lui sont raccordés, reportez-vous aux instructions ci-dessous pour connecter et déconnecter les différents cordons.**

<b>Connexion</b>	<b>Déconnexion</b>
<ol style="list-style-type: none"><li>1. Mettez les unités hors tension.</li><li>2. Commencez par brancher tous les cordons sur les unités.</li><li>3. Branchez les câbles d'interface sur des connecteurs.</li><li>4. Branchez les cordons d'alimentation sur des prises.</li><li>5. Mettez les unités sous tension.</li></ol>	<ol style="list-style-type: none"><li>1. Mettez les unités hors tension.</li><li>2. Débranchez les cordons d'alimentation des prises.</li><li>3. Débranchez les câbles d'interface des connecteurs.</li><li>4. Débranchez tous les câbles des unités.</li></ol>



### Notice n° 2



#### ATTENTION

Remplacez la pile au lithium usagée par une pile de référence identique exclusivement - voir la référence IBM - ou par une pile équivalente recommandée par le fabricant. Si votre système est doté d'un module contenant une pile au lithium, vous devez le remplacer uniquement par un module identique, produit par le même fabricant. La pile contient du lithium et présente donc un risque d'explosion en cas de mauvaise manipulation ou utilisation.

1. Ne la jetez pas à l'eau.
2. Ne l'exposez pas à une température supérieure à 100 °C.
3. Ne cherchez pas à la réparer ou à la démonter.

Pour la mise au rebut, reportez-vous à la réglementation en vigueur.

### Notice n° 3



#### ATTENTION

Si des produits laser sont installés (tels que des unités de CD-ROM ou de DVD, des périphériques contenant des fibres optiques ou des émetteurs-récepteurs), prenez connaissance des informations suivantes:

1. N'ouvrez pas ces produits pour éviter une exposition directe au rayon laser. Vous ne pouvez effectuer aucune opération de maintenance à l'intérieur.
2. Pour éviter tout risque d'exposition au rayon laser, respectez les consignes de réglage et d'utilisation des commandes, ainsi que les procédures décrites dans le présent document.



#### CAUTION

Certains produits laser contiennent une diode laser de classe 3A ou 3B. Prenez connaissance des informations suivantes:

Rayonnement laser lorsque le carter est ouvert. évitez de regarder fixement le faisceau ou de l'observer à l'aide d'instruments optiques. évitez une exposition directe au rayon.

**Notice n° 4**

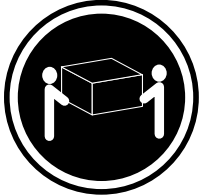

≥18 kg (39.7 lb)

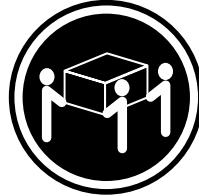

≥32 kg (70.5 lb)

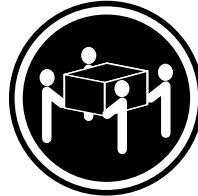

≥55 kg (121.2 lb)

**ATTENTION**

Faites-vous aider pour soulever ce produit.

**Notice n° 5**



**ATTENTION**

Le bouton de mise sous tension/hors tension de l'unité et l'interrupteur d'alimentation du bloc d'alimentation ne coupent pas l'arrivée de courant électrique à l'intérieur de la machine. Il se peut que votre unité dispose de plusieurs cordons d'alimentation. Pour isoler totalement l'unité du réseau électrique, débranchez tous les cordons d'alimentation des socles de prise de courant.

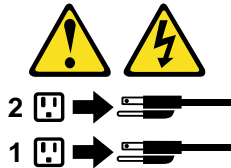

**Notice n° 10**



**ATTENTION**

Ne posez pas d'objet dont le poids dépasse 82 kg sur les unités montées en armoire.



>82 kg

## Wichtig

Alle Sicherheitshinweise in dieser IBM documentation beginnen mit einer Nummer. Diese Nummer verweist auf einen englischen Sicherheitshinweis mit den übersetzten Versionen dieses Hinweises in diesem Abschnitt.

Wenn z. B. ein Sicherheitshinweis mit der Nummer 1 beginnt, so erscheint die Übersetzung für diesen Sicherheitshinweis in diesem Abschnitt unter dem Hinweis 1.

Lesen Sie alle Sicherheitshinweise, bevor Sie eine Anweisung ausführen.

## Hinweis 1



## VORSICHT

**Elektrische Spannungen von Netz-, Telefon- und Datenübertragungsleitungen sind gefährlich.**

**Aus Sicherheitsgründen:**

- 1. Bei Gewitter an diesem Gerät keine Kabel anschließen oder lösen. Ferner keine Installations-, Wartungs- oder Rekonfigurationsarbeiten durchführen.**
- 2. Gerät nur an eine Schutzkontaktsteckdose mit ordnungsgemäß geerdetem Schutzkontakt anschließen.**
- 3. Alle angeschlossenen Geräte ebenfalls an Schutzkontaktsteckdosen mit ordnungsgemäß geerdetem Schutzkontakt anschließen.**
- 4. Signalkabel möglichst einhändig anschließen oder lösen.**
- 5. Keine Geräte einschalten, wenn die Gefahr einer Beschädigung durch Feuer, Wasser oder andere Einflüsse besteht.**
- 6. Die Verbindung zu den angeschlossenen Netzkabeln, Telekommunikationssystemen, Netzwerken und Modems ist vor dem Öffnen des Gehäuses zu unterbrechen. Es sei denn, dies ist in den zugehörigen Installations- und Konfigurationsprozeduren anders angegeben.**
- 7. Nur nach den nachfolgend aufgeführten Anweisungen arbeiten, die für Installation, Transport oder Öffnen von Gehäusen von Personal Computern oder angeschlossenen Einheiten gelten.**

### **Kabel anschließen:**

1. Alle Geräte ausschalten und Netzstecker ziehen.
2. Zuerst alle Kabel an Einheiten anschließen.
3. Signalkabel an Anschlußbuchsen anschließen.
4. Netzstecker an Steckdose anschließen.
5. Gerät einschalten.

### **Kabel lösen:**

1. Alle Geräte ausschalten.
2. Zuerst Netzstecker von Steckdose lösen.
3. Signalkabel von Anschlußbuchsen lösen.
4. Alle Kabel von Einheiten lösen.

## Hinweis 2



### ACHTUNG

Eine verbrauchte Batterie nur durch eine Batterie mit der IBM Teilenummer 33F8354 oder durch eine vom Hersteller empfohlene Batterie ersetzen. Wenn Ihr System ein Modul mit einer Lithium-Batterie enthält, ersetzen Sie es immer mit dem selben Modultyp vom selben Hersteller. Die Batterie enthält Lithium und kann bei unsachgemäßer Verwendung, Handhabung oder Entsorgung explodieren.

Die Batterie nicht:

1. mit Wasser in Berührung bringen.
2. über 100 C erhitzen.
3. reparieren oder zerlegen.

Die örtlichen Bestimmungen für die Entsorgung von Sondermüll beachten.

## Hinweis 3



### ACHTUNG

Wenn ein Laserprodukt (z. B. CD-ROM-Laufwerke, DVD-Laufwerke, Einheiten mit Glasfaserkabeln oder Transmitter) installiert ist, beachten Sie folgendes.

1. Das Entfernen der Abdeckungen des CD-ROM-Laufwerks kann zu gefährlicher Laserstrahlung führen. Es befinden sich keine Teile innerhalb des CD-ROM-Laufwerks, die vom Benutzer gewartet werden müssen. Die Verkleidung des CD-ROM-Laufwerks nicht öffnen.
2. Steuer- und Einstellelemente sowie Verfahren nur entsprechend den Anweisungen im vorliegenden Handbuch einsetzen. Andernfalls kann gefährliche Laserstrahlung auftreten.



### VORSICHT

Manche CD-ROM-Laufwerke enthalten eine eingebaute Laserdiode der Klasse 3A oder 3B. Die nachfolgend aufgeführten Punkte beachten.

Laserstrahlung bei geöffneter Tür. Niemals direkt in den Laserstrahl sehen, nicht direkt mit optischen Instrumenten betrachten und den Strahlungsbereich meiden.

#### Hinweis 4

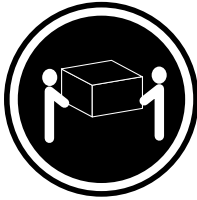

≥18 kg (39.7 lb)

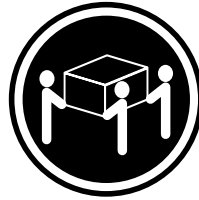

≥32 kg (70.5 lb)

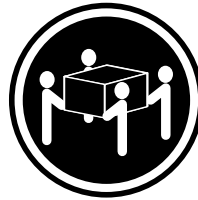

≥55 kg (121.2 lb)

#### ACHTUNG

Beim Anheben der Maschine die vorgeschriebenen Sicherheitsbestimmungen beachten.

#### Hinweis 5



#### ACHTUNG

Mit dem Betriebsspannungsschalter an der Vorderseite des Servers und dem Betriebsspannungsschalter am Netzteil wird die Stromversorgung für den Server nicht unterbrochen. Der Server könnte auch mehr als ein Netzkabel aufweisen. Um die gesamte Stromversorgung des Servers auszuschalten, muß sichergestellt werden, daß alle Netzkabel aus den Netzsteckdosen herausgezogen wurden.

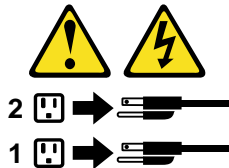

#### Hinweis 10



#### ACHTUNG

Keine Gegenstände, die mehr als 82 kg wiegen, auf Rack-Einheiten ablegen.



>82 kg

## Importante

Tutti gli avvisi di attenzione e di pericolo riportati nella pubblicazione IBM documentation iniziano con un numero. Questo numero viene utilizzato per confrontare avvisi di attenzione o di pericolo in inglese con le versioni tradotte riportate in questa sezione.

Ad esempio, se un avviso di attenzione inizia con il numero 1, la relativa versione tradotta è presente in questa sezione con la stessa numerazione.

Prima di eseguire una qualsiasi istruzione, accertarsi di leggere tutti gli avvisi di attenzione e di pericolo.

### Avviso 1



### PERICOLO

**La corrente elettrica circolante nei cavi di alimentazione, del telefono e di segnale è pericolosa.**

**Per evitare il pericolo di scosse elettriche:**

- 1. Non collegare o scollegare i cavi, non effettuare l'installazione, la manutenzione o la riconfigurazione di questo prodotto durante i temporali.**
- 2. Collegare tutti i cavi di alimentazione ad una presa elettrica correttamente cablata e munita di terra di sicurezza.**
- 3. Collegare qualsiasi apparecchiatura collegata a questo prodotto ad una presa elettrica correttamente cablata e munita di terra di sicurezza.**
- 4. Quando possibile, collegare o scollegare i cavi di segnale con una sola mano.**
- 5. Non accendere qualsiasi apparecchiatura in presenza di fuoco, acqua o se sono presenti danni all'apparecchiatura stessa.**
- 6. Scollegare i cavi di alimentazione, i sistemi di telecomunicazioni, le reti e i modem prima di aprire i coperchi delle unità, se non diversamente indicato nelle procedure di installazione e configurazione.**
- 7. Collegare e scollegare i cavi come descritto nella seguente tabella quando si effettuano l'installazione, la rimozione o l'apertura dei coperchi di questo prodotto o delle unità collegate.**

<b>Per collegare:</b>	<b>Per scollegare:</b>
1. SPEGNERE tutti i dispositivi.	1. SPEGNERE tutti i dispositivi.
2. Collegare prima tutti i cavi alle unità.	2. Rimuovere prima i cavi di alimentazione dalle prese elettriche.
3. Collegare i cavi di segnale ai connettori.	3. Rimuovere i cavi di segnale dai connettori.
4. Collegare i cavi di alimentazione alle prese elettriche.	4. Rimuovere tutti i cavi dalle unità.
5. ACCENDERE le unità.	

## Avviso 2



### ATTENZIONE

Quando si sostituisce la batteria al litio, utilizzare solo una batteria IBM con numero parte 33F8354 o batterie dello stesso tipo o di tipo equivalente consigliate dal produttore. Se il sistema di cui si dispone è provvisto di un modulo contenente una batteria al litio, sostituire tale batteria solo con un tipo di modulo uguale a quello fornito dal produttore. La batteria contiene litio e può esplodere se utilizzata, maneggiata o smaltita impropriamente.

Evitare di:

1. Gettarla o immergerla in acqua
2. Riscaldarla ad una temperatura superiore ai 100°C
3. Cercare di ripararla o smontarla

Smaltire secondo la normativa in vigore (D.Lgs 22 del 5/2/9) e successive disposizioni nazionali e locali.

## Avviso 3



### ATTENZIONE

Quando si installano prodotti laser come, ad esempio, le unità DVD, CD-ROM, a fibre ottiche o trasmettitori, prestare attenzione a quanto segue:

1. Non rimuovere i coperchi. L'apertura dei coperchi di prodotti laser può determinare l'esposizione a radiazioni laser pericolose. All'interno delle unità non vi sono parti su cui effettuare l'assistenza tecnica.
2. L'utilizzo di controlli, regolazioni o l'esecuzione di procedure non descritti nel presente manuale possono provocare l'esposizione a radiazioni pericolose.



### PERICOLO

Alcuni prodotti laser contengono all'interno un diodo laser di Classe 3A o Classe 3B. Prestare attenzione a quanto segue:

Aperto l'unità vengono emesse radiazioni laser. Non fissare il fascio, non guardarlo direttamente con strumenti ottici ed evitare l'esposizione diretta al fascio.

#### Avviso 4

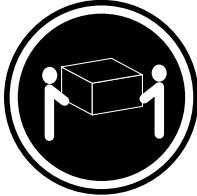

≥18 kg (39.7 lb)

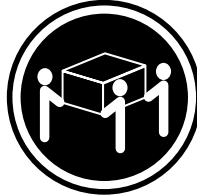

≥32 kg (70.5 lb)

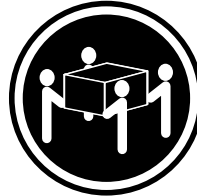

≥55 kg (121.2 lb)

#### ATTENZIONE

Durante il sollevamento della macchina seguire delle norme di sicurezza.

#### Avviso 5



#### ATTENZIONE

Il pulsante del controllo dell'alimentazione situato sull'unità e l'interruttore di alimentazione posto sull'alimentatore non disattiva la corrente elettrica fornita all'unità. L'unità potrebbe disporre di più di un cavo di alimentazione. Per disattivare la corrente elettrica dall'unità, accertarsi che tutti i cavi di alimentazione siano scollegati dalla sorgente di alimentazione.

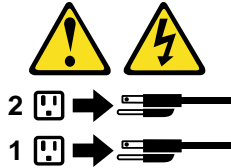

#### Avviso 10



#### ATTENZIONE

Non poggiare oggetti che pesano più di 82 kg sulla parte superiore delle unità montate in rack.



>82 kg



**중요:**

본 *Server Library*에 있는 모든 주의 및 위험 경고문은 번호로 시작합니다. 이 번호는 영문 주의 혹은 위험 경고문과 이 절에 나오는 번역된 버전의 주의 혹은 위험 경고문을 상호 참조하는 데 사용됩니다.

예를 들어, 주의 경고문이 번호 1로 시작하면, 번역된 해당 주의 경고문을 본 절의 경고문 1에서 찾아볼 수 있습니다.

모든 지시사항을 수행하기 전에 반드시 모든 주의 및 위험 경고문을 읽으십시오.

## 경고문 1



위험

전원, 전화 및 통신 케이블로부터 흘러 나오는 전류는 위험합니다.

전기 충격을 피하려면:

- 뇌우를 동반할 때는 케이블의 연결이나 철수, 이 제품의 설치, 유지보수 또는 재구성을 하지 마십시오.
- 모든 전원 코드를 적절히 배선 및 접지해야 합니다.
- 이 제품에 연결될 모든 장비를 적절하게 배선된 콘센트에 연결하십시오.
- 가능한한 신호 케이블을 한 손으로 연결하거나 끊으십시오.
- 화재, 수해 또는 구조상의 손상이 있을 경우 장비를 켜지 마십시오.
- 설치 및 구성 프로시저에 다른 설명이 없는 한, 장치 덮개를 열기 전에 연결된 전원 코드, 원거리 통신 시스템, 네트워크 및 모뎀을 끊어 주십시오.
- 제품 또는 접속된 장치를 설치, 이동 및 덮개를 열 때 다음 설명에 따라 케이블을 연결하거나 끊도록 하십시오.

연결하려면:

1. 모든 스위치를 끕니다.
2. 먼저 모든 케이블을 장치에 연결합니다.
3. 신호 케이블을 커넥터에 연결합니다.
4. 콘센트에 전원 코드를 연결합니다.
5. 장치 스위치를 켭니다.

연결을 끊으려면:

1. 모든 스위치를 끕니다.
2. 먼저 콘센트에서 전원 코드를 뽑습니다.
3. 신호 케이블을 커넥터에서 제거합니다.
4. 장치에서 모든 케이블을 제거합니다.

## 경고문 2



주의:

리튬 배터리를 교체할 때는 IBM 부품 번호 33F8354 또는 제조업체에서 권장하는 동등한 유형의 배터리를 사용하십시오. 시스템에 리튬 배터리를 갖고 있는 모듈이 있으면 동일한 제조업체에서 생산된 동일한 모듈 유형으로 교체하십시오. 배터리에 리튬이 있을 경우 제대로 사용, 처리 또는 처분하지 않으면 폭발할 수 있습니다.

다음은 주의하십시오.

- 던지거나 물에 담그지 않도록 하십시오.
- 100°C(212°F) 이상으로 가열하지 마십시오.
- 수리하거나 분해하지 마십시오.

지역 법령이나 규정의 요구에 따라 배터리를 처분하십시오.

### 경고문 3



#### 주의:

레이저 제품(CD-ROMs, DVD 드라이브, 광 장치 또는 트랜스미터 등과 같은)이 설치되어 있을 경우 다음을 유의하십시오.

- 덮개를 제거하지 마십시오. 레이저 제품의 덮개를 제거했을 경우 위험한 레이저 광선에 노출될 수 있습니다. 이 장치 안에는 서비스를 받을 수 있는 부품이 없습니다.
- 여기에서 지정하지 않은 방식의 제어, 조절 또는 실행으로 인해 위험한 레이저 광선에 노출될 수 있습니다.



#### 위험

일부 레이저 제품에는 클래스 3A 또는 클래스 3B 레이저 다이오드가 들어 있습니다. 다음을 주의하십시오.

열면 레이저 광선에 노출됩니다. 광선을 주시하거나 광학 기계를 직접 쳐다보지 않도록 하고 광선에 노출되지 않도록 하십시오.

## 경고문 4

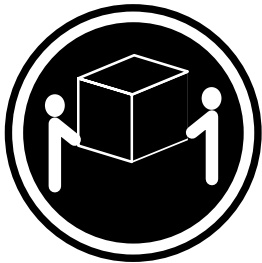

≥18 kg (37 lbs)

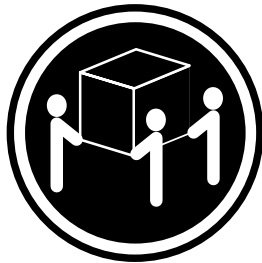

≥ 32 kg (70.5 lbs)

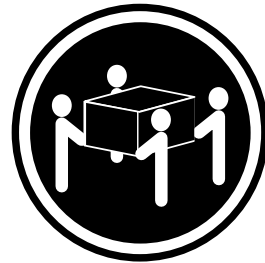

≥ 55 kg (121.2 lbs)

주의:

기계를 들 때는 안전하게 들어 올리십시오.

## 경고문 5



주의:

장치의 전원 제어 버튼 및 전원 공급기의 전원 스위치는 장치에 공급되는 전류를 차단하지 않습니다. 장치에 둘 이상의 전원 코드가 연결되어 있을 수도 있습니다. 장치에서 모든 전류를 차단하려면 모든 전원 코드가 전원으로부터 차단되어 있는지 확인하십시오.

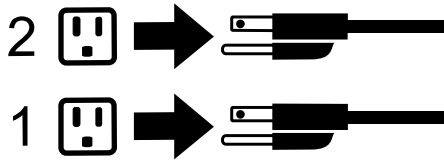
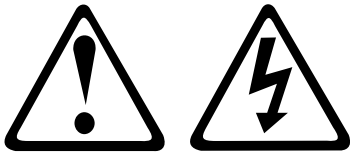

## 경고문 4

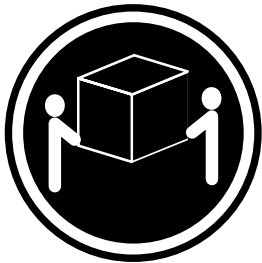

≥18 kg (37 lbs)

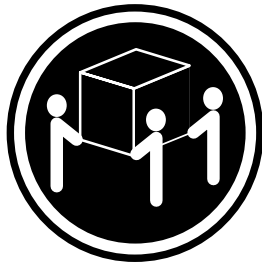

≥ 32 kg (70.5 lbs)

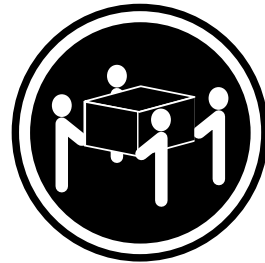

≥ 55 kg (121.2 lbs)

주의:

기계를 들 때는 안전하게 들어 올리십시오.

## Importante

Todas las declaraciones de precaución de esta IBM documentation empiezan con un número. Dicho número se emplea para establecer una referencia cruzada de una declaración de precaución o peligro en inglés con las versiones traducidas que de dichas declaraciones pueden encontrarse en esta sección.

Por ejemplo, si una declaración de peligro empieza con el número 1, las traducciones de esta declaración de precaución aparecen en esta sección bajo Declaración 1.

Lea atentamente todas las declaraciones de precaución y peligro antes de llevar a cabo cualquier operación.

### Declaración 1



### PELIGRO

**La corriente eléctrica de los cables telefónicos, de alimentación y de comunicaciones es perjudicial.**

**Para evitar una descarga eléctrica:**

- 1. No conecte ni desconecte ningún cable ni realice las operaciones de instalación, mantenimiento o reconfiguración de este producto durante una tormenta.**
- 2. Conecte cada cable de alimentación a una toma de alimentación eléctrica con conexión a tierra y cableado correctos.**
- 3. Conecte a tomas de alimentación con un cableado correcto cualquier equipo que vaya a estar conectado a este producto.**
- 4. Si es posible, utilice una sola mano cuando conecte o desconecte los cables de señal.**
- 5. No encienda nunca un equipo cuando haya riesgos de incendio, de inundación o de daños estructurales.**
- 6. Desconecte los cables de alimentación, sistemas de telecomunicaciones, redes y módems conectados antes de abrir las cubiertas del dispositivo a menos que se indique lo contrario en los procedimientos de instalación y configuración.**
- 7. Conecte y desconecte los cables tal como se describe en la tabla siguiente cuando desee realizar una operación de instalación, de traslado o de apertura de las cubiertas para este producto o para los dispositivos conectados.**

<b>Para la conexión</b>	<b>Para la desconexión</b>
<ol style="list-style-type: none"><li>1. APÁGUELO todo.</li><li>2. En primer lugar, conecte los cables a los dispositivos.</li><li>3. Conecte los cables de señal a los conectores.</li><li>4. Conecte cada cable de alimentación a la toma de alimentación.</li><li>5. ENCIENDA el dispositivo.</li></ol>	<ol style="list-style-type: none"><li>1. APÁGUELO todo.</li><li>2. En primer lugar, retire cada cable de alimentación de la toma de alimentación.</li><li>3. Retire los cables de señal de los conectores.</li><li>4. Retire los cables de los dispositivos.</li></ol>



## Declaración 2



### PRECAUCIÓN

Cuando desee sustituir la batería de litio, utilice únicamente el número de pieza 33F8354 de IBM o cualquier tipo de batería equivalente que recomiende el fabricante. Si el sistema tiene un módulo que contiene una batería de litio, sustitúyalo únicamente por el mismo tipo de módulo, que ha de estar creado por el mismo fabricante. La batería contiene litio y puede explotar si el usuario no la utiliza ni la maneja de forma adecuada o si no se desprende de la misma como corresponde.

No realice las acciones siguientes:

1. Arrojarla al agua o sumergirla
2. Calentarla a una temperatura que supere los 100°C (212°F)
3. Repararla o desmontarla

Despréndase de la batería siguiendo los requisitos que exija el reglamento o la legislación local.

## Declaración 3



### PRECAUCIÓN

Cuando instale productos láser (como, por ejemplo, CD-ROM, unidades DVD, dispositivos de fibra óptica o transmisores), tenga en cuenta las advertencias siguientes:

1. No retire las cubiertas. Si retira las cubiertas del producto láser, puede quedar expuesto a radiación láser perjudicial. Dentro del dispositivo no existe ninguna pieza que requiera mantenimiento.
2. El uso de controles o ajustes o la realización de procedimientos que no sean los que se han especificado aquí pueden dar como resultado una exposición perjudicial a las radiaciones.



### PELIGRO

Algunos productos láser contienen un diodo de láser incorporado de Clase 3A o de Clase 3B. Tenga en cuenta la advertencia siguiente.

Cuando se abre, hay radiación láser. No mire fijamente el rayo ni lleve a cabo ningún examen directamente con instrumentos ópticos; evite la exposición directa al rayo.

#### Declaración 4

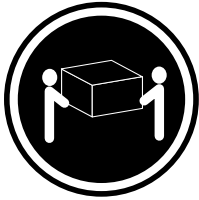

≥18 kg (39.7 lb)

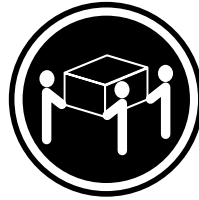

≥32 kg (70.5 lb)

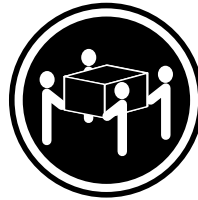

≥55 kg (121.2 lb)

#### PRECAUCIÓN

Tome medidas de seguridad al levantar el producto.

#### Declaración 5



#### PRECAUCIÓN

El botón de control de alimentación del dispositivo y el interruptor de alimentación de la fuente de alimentación no apagan la corriente eléctrica suministrada al dispositivo. Es posible también que el dispositivo tenga más de un cable de alimentación. Para eliminar la corriente eléctrica del dispositivo, asegúrese de desconectar todos los cables de alimentación de la fuente de alimentación.

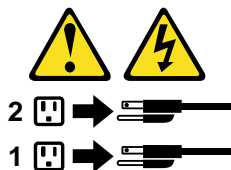

#### Declaración 10



#### PRECAUCIÓN

No coloque ningún objeto que pese más de 82 kg (180 libras) encima de los dispositivos montados en bastidor.



>82 kg

# F Product Notices

---

## Notices

This publication was developed for products and services offered in the U.S.A.

IBM may not offer the products, services, or features discussed in this document in other countries. Consult your local IBM representative for information on the products and services currently available in your area. Any reference to an IBM product, program, or service is not intended to state or imply that only that IBM product, program, or service may be used. Any functionally equivalent product, program, or service that does not infringe any IBM intellectual property right may be used instead. However, it is the user's responsibility to evaluate and verify the operation of any non-IBM product, program, or service.

IBM may have patents or pending patent applications covering subject matter described in this document. The furnishing of this document does not give you any license to these patents. You can send license inquiries, in writing, to:

*IBM Director of Licensing  
IBM Corporation  
North Castle Drive  
Armonk, NY 10504-1785  
U.S.A.*

INTERNATIONAL BUSINESS MACHINES CORPORATION PROVIDES THIS PUBLICATION "AS IS" WITHOUT WARRANTY OF ANY KIND, EITHER EXPRESS OR IMPLIED, INCLUDING, BUT NOT LIMITED TO, THE IMPLIED WARRANTIES OF NON-INFRINGEMENT, MERCHANTABILITY OR FITNESS FOR A PARTICULAR PURPOSE. Some jurisdictions do not allow disclaimer of express or implied warranties in certain transactions, therefore, this statement may not apply to you.

This information could include technical inaccuracies or typographical errors. Changes are periodically made to the information herein; these changes will be incorporated in new editions of the publication. IBM may make improvements and/or changes in the product(s) and/or the program(s) described in this publication at any time without notice.

Any references in this publication to non-IBM Web sites are provided for convenience only and do not in any manner serve as an endorsement of those Web sites. The materials at those Web sites are not part of the materials for this IBM product, and use of those Web sites is at your own risk.

IBM may use or distribute any of the information you supply in any way it believes appropriate without incurring any obligation to you.

## Trademarks

The following terms are trademarks of International Business Machines Corporation in the United States, other countries, or both:

e-business logo	OS/2	ServeRAID
HelpCenter	PS/2	xSeries
IBM	ServerProven	

Intel and Pentium are registered trademarks of Intel Corporation in the United States, other countries, or both.

Windows and Windows NT are trademarks of Microsoft Corporation in the United States, other countries, or both.

Linux is a registered trademark of Linus Torvalds.

Other company, product, or service names may be the trademarks or service marks of others.

## Important Notes

Processor speeds indicate the internal clock speed of the microprocessor; other factors also affect application performance.

CD-ROM drive speeds list the variable read rate. Actual speeds vary and are often less than the maximum possible.

When referring to processor storage, real and virtual storage, or channel volume, KB stands for approximately 1000 bytes, MB stands for approximately 1 000 000 bytes, and GB stands for approximately 1 000 000 000 bytes.

When referring to hard disk drive capacity or communications volume, MB stands for 1 000 000 bytes, and GB stands for 1 000 000 000 bytes. Total user-accessible capacity may vary depending on operating environments.

Maximum internal hard disk drive capacities assume the replacement of any standard hard disk drives and population of all hard disk drive bays with the largest currently supported drives available from IBM.

Maximum memory may require replacement of the standard memory with an optional memory module.

IBM makes no representation or warranties regarding non-IBM products and services that are ServerProven, including but not limited to the implied warranties of merchantability and fitness for a particular purpose. These products are offered and warranted solely by third parties.

IBM makes no representations or warranties with respect to non-IBM products. Support (if any) for the non-IBM products is provided by the third party, not IBM.

Some software may differ from its retail version (if available), and may not include user manuals or all program functionality.

# Index

---

## A

- Adaptec SCSI utility, 57
- Adapter Fault Tolerance, 16
- Adaptive Load Balancing, 16, 17
- add-in card
  - 3.3 Volt PCI, 78
  - 5 Volt PCI, 78
- administrative password, 19
  - limiting access to SCU, 21
- Advanced Menu, configuring in Setup, 37
- AFT, *See* Adapter Fault Tolerance
- alarms connector, 91
- ALB, *See* Adaptive Load Balancing

## B

- Back Panel Features, 13
- Baseboard Management Controller, *See also* BMC, 104
- battery
  - installing, 81
  - removing, 79
- BIOS, 46, 97, 102, 104, 105
  - changing the language, 47
  - recovering, 46
  - Upgrading, 44
- BIST, 103
- BMC, 104, 105
- Boot Device Priority menu, configuring, Setup, 42
- boot sequence
  - booting without keyboard, 21
  - setting in Setup, 21
- booting cold, 111
- Built-in Self Test
  - See also* BIST, 103
- Built-in Self Test, *See also* BIST, 103
- bus termination requirements, SCSI devices, 15

## C

- cables and connectors, 91
- Caution
  - installing chassis covers for cooling and airflow, 67
  - selecting correct processor, 72
- CD-ROM replacement, 85
- Chassis Feature Location, 10
- Checksum, 102
- Class A electronic emission notice, 29
- CMOS, 46, 102, 105
  - clear to reconfigure diskette drive, 34
- configuration
  - limiting access to system with administrative password, 21
- configuration jumpers, 94
- configuring system
  - SCU, 33
  - Setup, 33
- connector
  - alarms, 91
  - DC power, 92
  - serial port, 93
- controller
  - keyboard, 17
  - SCSI, 15
- Controller, 102
  - video, 15
- cooling, installing all covers for correct airflow, 67
- cooling and airflow, 68
- Core Component, 104

## D

- DC power connector, 92
- diagnostics, preparing system for testing, 113
- diskette
  - enabling/disabling floppy writes, 21
  - no booting in secure mode without password, 20
  - reconfiguring if cannot enter Setup, 34

## E

electronic emission Class A notice, 29  
Environmental Specifications, 9  
equipment log, 109  
Error, 102, 103, 105, 106  
Error Messages, 102  
Exit menu, configuring, Setup, 43

## F

fan replacement, 88  
Fast EtherChannel, 16, 17  
Fault Resilient Booting, *See also* FRB, 103, 105  
Fault Resilient Booting, *See* FRB, 103  
FCC Class A notice, 29  
Features, back panel, 13  
FEC, *See* Fast EtherChannel  
firmware update utility, 56  
floppy disk drive replacement, 85  
FRB, 103, 105  
FRB-3, *See also* Fault Resilient Booting, 103  
Front Panel, 104  
front panel board replacement, 87  
Front Panel Controller  
*See also* FPC, 104  
Front Side Bus, 104  
FRU/SDR load utility, 52  
when to run, 53  
FRUSDR load utility, 33

## H - J

hard disk drive replacement, 64  
hardware updating, 61  
Internal Chassis Layout, 70  
Interrupt Controller, 102  
jumpers, configuration, 94

## K - L

keyboard, compatibility, 17  
L2 cache controller, 104  
language, changing in BIOS, 47  
Layout, Internal Chassis, 70  
LED, 106

lithium backup battery  
installing, 81  
removing, 79  
log, utility, 109

## M

Memory, 15, 102, 103, 106  
memory removal and replacement, 71  
Message, 102  
mouse, inactivity timer, 17

## N

Network Teaming, 16  
notes, important, 166  
notices  
electronic emission, 29  
FCC, Class A, 29

## P

Parity Error, *See also* PERR, 105  
password, 19  
administrative, 19  
administrator, 19  
entering to unblank screen, 21  
user, 19  
using to reactivate keyboard/mouse, 21  
Password, 103  
POST, 46, 97, 105, 106  
POST Codes, 102  
Power Control, 105  
power on/off  
switch does not turn off power, 66  
power supply cage replacement, 90  
power supply replacement, 63  
Power-on Self-Test  
*See* POST, 46, 97, 105, 106  
*See* POST Codes, 102  
problems  
after running new application software, 112  
after system has been running correctly, 112  
application software, 117  
bootable CD-ROM not detected, 117  
cannot connect to network server, 116

problems (continued)

- CD-ROM drive activity light, 116
- confirm OS loading, 113
- diskette drive light, 115
- hard drive light, 115
- initial system startup, 111
- network, 116
- no characters on screen, 114
- PCI installation tips, 117
- power light, 114
- preparing system for diagnostic testing, 113
- random error in data files, 112
- screen characters incorrect, 115
- system cooling fans do not rotate, 115
- system lights, 113

processor, 72

- removing, 73, 76, 77
- selecting the correct processor, 72

Processor, 103, 104, 105

Processor Failure, 105

processor removal and installation, 72

## R

real time clock, running SCU to configure settings, 81

Recovery, 46

removal and installation

- processor, 72

removal and replacement

- memory, 71
- server board, 83

removing

- top cover, 68

replacement

- fans, 88

replacement

- 3.3 V and 5 V PCI add-in cards, 78
- floppy disk drive, 85
- front panel board, 87
- hard disk drive, 64
- power supply, 63
- power supply cage, 90

replacing, CD-ROM, 85

reset system, 111

## S

safety, guidelines, 66

SCSI

- bus termination requirements, 15

SCSI controller, 15

SCU

- administrative password limits access to, 21
- changing configuration, 33
- inactivity (lockout) timer, 17
- software locking feature, 19

secure mode, 20

- affects boot sequence, 21
- enter by setting passwords, 20
- no booting from diskette without password, 20

security

- boot sequence, 21
- enabling/disabling floppy writes, 21
- locking mouse, keyboard with timer, 21
- password, 21
- secure mode, 20
- secure mode, setting in SCU, 20
- software lock, SCU, 19
- unattended start, 21
- video blanking, 21

Security menu

- configuring, Setup, 39

Sensor Data Record, *See also* SDR, 104

serial port connector, 93

server, cooling and airflow, 68

server board removal and replacement, 83

Server Management, 104

Setup

- Advanced menu, 37
- Boot Device Priority menu, 42
- cannot enter, need to reconfigure diskette, 34
- changing configuration, 33
- Exit menu, 43
- Main menu, 36
- recording settings, 34
- security menu contents, 39

Shadow, 103

Shutdown, 105



## Signal

- Data Terminal Ready, 18
- DCD, 18
- DSR, 18
- Received Data, 18
- Request to Send, 18

## SMBUS, 106

## soft boot, 111

## Software and Utilities, configuration, Setup, 33

## specifications, environmental, 9

## SSU, *See* system setup utility

## Switches

- power on/off, 66
- DC power, 111
- reset, 111

## System Configuration Utility, *See* SCU

## System Event Log, *See also* SEL, 104

## system setup utility, 47

## System setup utility

- customizing, 49
- exiting, 52
- launching a task, 50
- location, 47
- running, locally, 47

## T

### timer

- keyboard or mouse inactive, 17
- lockout (inactivity), setting in SCU, 17

## tools and equipment, 61

## top cover removal, 68

## trademarks, 166

## U

## United States electronic emission Class A notice, 29

## United States FCC Class A notice, 29

## updating, hardware, 61

## upgrade Flash utility, 44

## Upgrading the BIOS, 44

## user password, 19

- limit access to using system, 21

## utilities

- Adaptec SCSI, 57
- BIOS Setup, 34
- firmware update, 56
- FRUSDR load, 33
- SCSI, 33
- SCU, 33
- Setup, 33

## Utilities, FRU/SDR load utility, 52

## utility, system setup, 47

## V - W

## video, blanking for security, 21

## Video controller, 15

## Warning

- components may be hot, 72
- power on/off switch, 66

## Watchdog Timer, 104

## write to diskette, disabling, 21





Part Number: 59P2178

Printed in the United States of America.

## Free Manuals Download Website

<http://myh66.com>

<http://usermanuals.us>

<http://www.somanuals.com>

<http://www.4manuals.cc>

<http://www.manual-lib.com>

<http://www.404manual.com>

<http://www.luxmanual.com>

<http://aubethermostatmanual.com>

Golf course search by state

<http://golfingnear.com>

Email search by domain

<http://emailbydomain.com>

Auto manuals search

<http://auto.somanuals.com>

TV manuals search

<http://tv.somanuals.com>