



# IBM **e**server xSeries 440 Planning and Installation Guide

Describes the technical details of  
the x440 models

Helps you prepare for and  
perform an installation

Covers key IBM Director  
management tools

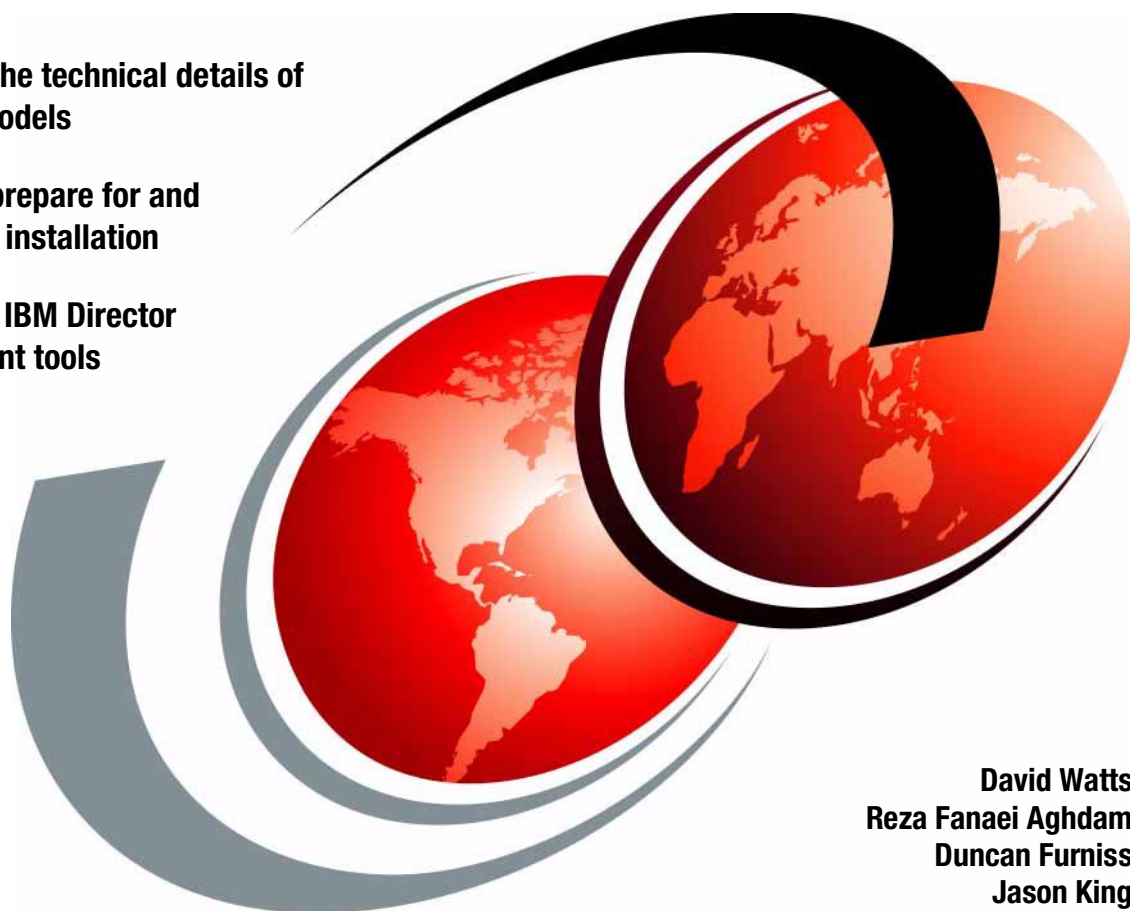

David Watts  
Reza Fanaei Aghdam  
Duncan Furniss  
Jason King





International Technical Support Organization

**IBM @server xSeries 440 Planning and Installation  
Guide**

October 2002

**Note:** Before using this information and the product it supports, read the information in “Notices” on page vii.

**First Edition (October 2002)**

This edition applies to the IBM @server xSeries 440, machine type 8687.

© Copyright International Business Machines Corporation 2002. All rights reserved.

Note to U.S. Government Users Restricted Rights -- Use, duplication or disclosure restricted by GSA ADP Schedule Contract with IBM Corp.

# Contents

<b>Notices</b> .....	vii
Trademarks .....	viii
<b>Preface</b> .....	ix
The team that wrote this redbook .....	ix
Become a published author .....	xii
Comments welcome .....	xii
<b>Chapter 1. Technical description</b> .....	1
1.1 The x440 product line .....	2
1.2 System partitioning .....	6
1.3 IBM XA-32 chipset .....	7
1.4 Processors .....	12
1.4.1 Intel Xeon Processor MP .....	13
1.4.2 Intel Xeon Processor DP .....	16
1.5 SMP Expansion Module .....	17
1.6 IBM XceL4 Server Accelerator Cache .....	19
1.7 System memory .....	19
1.8 PCI subsystem .....	23
1.9 Redundancy .....	24
1.10 Light Path Diagnostics .....	25
1.11 Remote Supervisor Adapter .....	27
1.12 Operating system support .....	28
1.13 IBM Director .....	30
<b>Chapter 2. Positioning</b> .....	35
2.1 xSeries 440 application solutions .....	36
2.1.1 Server consolidation .....	36
2.1.2 Enterprise applications .....	38
2.1.3 Infrastructure applications .....	40
2.1.4 Clustering .....	41
2.2 Why choose the x440 .....	43
2.2.1 IBM XA-32 chipset .....	43
2.2.2 Intel Xeon MP and DP processors .....	44
2.2.3 XceL4 Server Accelerator Cache .....	46
2.2.4 High-performance memory subsystem .....	46
2.2.5 Active PCI-X .....	47
2.2.6 XpandOnDemand scalability .....	47
2.2.7 System Partition Manager .....	48

2.3	The benefits of system partitioning . . . . .	49
2.4	Server consolidation . . . . .	51
2.4.1	Types of server consolidation . . . . .	51
2.4.2	Why consolidate servers . . . . .	57
2.4.3	Benefits from server consolidation . . . . .	57
<b>Chapter 3.</b>	<b>Planning</b> . . . . .	<b>63</b>
3.1	System hardware . . . . .	64
3.1.1	Processors . . . . .	64
3.1.2	Memory . . . . .	65
3.1.3	PCI slot configuration . . . . .	68
3.1.4	Broadcom Gigabit Ethernet controller . . . . .	72
3.2	Cabling and connectivity . . . . .	74
3.2.1	SMP Expansion Module connectivity . . . . .	74
3.2.2	Remote Supervisor Adapter connectivity . . . . .	77
3.2.3	Remote Expansion Enclosure . . . . .	78
3.2.4	Serial connections . . . . .	83
3.3	Storage considerations . . . . .	83
3.3.1	xSeries storage solutions . . . . .	84
3.3.2	Disk subsystem performance . . . . .	88
3.3.3	Tape backup . . . . .	89
3.4	Server partitioning and consolidation . . . . .	90
3.5	Operating system considerations . . . . .	90
3.5.1	Windows 2000 Datacenter Server . . . . .	92
3.5.2	Microsoft Windows NT 4.0 Enterprise Edition . . . . .	95
3.5.3	Microsoft Windows 2000 Server . . . . .	96
3.5.4	Microsoft Windows .NET Server . . . . .	97
3.5.5	Novell NetWare . . . . .	97
3.5.6	Red Hat/SuSE Linux . . . . .	97
3.5.7	VMware ESX Server . . . . .	98
3.6	Application considerations . . . . .	100
3.6.1	Scalability and performance considerations . . . . .	100
3.6.2	SMP and server types . . . . .	101
3.7	Rack installation . . . . .	102
3.8	Power considerations . . . . .	103
3.9	Solution Assurance Review . . . . .	104
<b>Chapter 4.</b>	<b>Installation</b> . . . . .	<b>107</b>
4.1	System BIOS settings . . . . .	108
4.1.1	Updating BIOS and firmware . . . . .	108
4.1.2	Enabling memory mirroring . . . . .	108
4.1.3	Enabling Hyper-Threading . . . . .	109
4.2	Device drivers . . . . .	111

4.3 Operating system installation .....	111
4.3.1 Microsoft Windows 2000 Server and Advanced Server .....	112
4.3.2 Red Hat Linux installation .....	119
4.3.3 NetWare installation .....	121
4.3.4 VMware ESX Server .....	128
4.4 Additional Information .....	128
<b>Chapter 5. Management</b> .....	<b>129</b>
5.1 Active PCI Manager .....	130
5.1.1 Using Active PCI Manager .....	132
5.1.2 Adding adapters to the system .....	136
5.1.3 Analyzing an existing configuration .....	144
5.2 System Partition Manager .....	150
5.3 Process Control .....	155
5.3.1 Process alias rules .....	156
5.3.2 Process execution rules .....	160
5.3.3 Group process execution rules .....	161
<b>Abbreviations and acronyms</b> .....	<b>173</b>
<b>Related publications</b> .....	<b>175</b>
IBM Redbooks .....	175
Referenced Web sites .....	175
How to get IBM Redbooks .....	178
IBM Redbooks collections .....	178
<b>Index</b> .....	<b>179</b>





# Notices

This information was developed for products and services offered in the U.S.A.

IBM may not offer the products, services, or features discussed in this document in other countries. Consult your local IBM representative for information on the products and services currently available in your area. Any reference to an IBM product, program, or service is not intended to state or imply that only that IBM product, program, or service may be used. Any functionally equivalent product, program, or service that does not infringe any IBM intellectual property right may be used instead. However, it is the user's responsibility to evaluate and verify the operation of any non-IBM product, program, or service.

IBM may have patents or pending patent applications covering subject matter described in this document. The furnishing of this document does not give you any license to these patents. You can send license inquiries, in writing, to:

*IBM Director of Licensing, IBM Corporation, North Castle Drive Armonk, NY 10504-1785 U.S.A.*

**The following paragraph does not apply to the United Kingdom or any other country where such provisions are inconsistent with local law:** INTERNATIONAL BUSINESS MACHINES CORPORATION PROVIDES THIS PUBLICATION "AS IS" WITHOUT WARRANTY OF ANY KIND, EITHER EXPRESS OR IMPLIED, INCLUDING, BUT NOT LIMITED TO, THE IMPLIED WARRANTIES OF NON-INFRINGEMENT, MERCHANTABILITY OR FITNESS FOR A PARTICULAR PURPOSE. Some states do not allow disclaimer of express or implied warranties in certain transactions, therefore, this statement may not apply to you.

This information could include technical inaccuracies or typographical errors. Changes are periodically made to the information herein; these changes will be incorporated in new editions of the publication. IBM may make improvements and/or changes in the product(s) and/or the program(s) described in this publication at any time without notice.

Any references in this information to non-IBM Web sites are provided for convenience only and do not in any manner serve as an endorsement of those Web sites. The materials at those Web sites are not part of the materials for this IBM product and use of those Web sites is at your own risk.

IBM may use or distribute any of the information you supply in any way it believes appropriate without incurring any obligation to you.

Information concerning non-IBM products was obtained from the suppliers of those products, their published announcements or other publicly available sources. IBM has not tested those products and cannot confirm the accuracy of performance, compatibility or any other claims related to non-IBM products. Questions on the capabilities of non-IBM products should be addressed to the suppliers of those products.

This information contains examples of data and reports used in daily business operations. To illustrate them as completely as possible, the examples include the names of individuals, companies, brands, and products. All of these names are fictitious and any similarity to the names and addresses used by an actual business enterprise is entirely coincidental.

## COPYRIGHT LICENSE:

This information contains sample application programs in source language, which illustrates programming techniques on various operating platforms. You may copy, modify, and distribute these sample programs in any form without payment to IBM, for the purposes of developing, using, marketing or distributing application programs conforming to the application programming interface for the operating platform for which the sample programs are written. These examples have not been thoroughly tested under all conditions. IBM, therefore, cannot guarantee or imply reliability, serviceability, or function of these programs. You may copy, modify, and distribute these sample programs in any form without payment to IBM for the purposes of developing, using, marketing, or distributing application programs conforming to IBM's application programming interfaces.

# Trademarks

The following terms are trademarks of the International Business Machines Corporation in the United States, other countries, or both:

Active Memory™	PowerPC®	Tivoli®
Active™ PCI-X	PowerPC 750™	TotalStorage™
Chipkill™	Predictive Failure Analysis®	Wake on LAN®
DB2®	pSeries™	WebSphere®
Electronic Service Agent™	Redbooks(logo)™ 	X-Architecture™
Enterprise Storage Server™	RETAIN®	XA-32™
ESCON®	S/390®	XceL4™
FlashCopy®	ServeRAID™	XpandOnDemand™
IBM®	ServerProven®	xSeries™
Informix®	SP™	zSeries™
iSeries™	SP1®	
Memory ProteXion™	SP2®	
Netfinity®	ThinkPad®	

The following terms are trademarks of International Business Machines Corporation and Lotus Development Corporation in the United States, other countries, or both:

Domino™	Lotus®	Notes®
---------	--------	--------

The following terms are trademarks of other companies:

ActionMedia, LANDesk, MMX, Pentium and ProShare are trademarks of Intel Corporation in the United States, other countries, or both.

Microsoft, Windows, Windows NT, and the Windows logo are trademarks of Microsoft Corporation in the United States, other countries, or both.

Java and all Java-based trademarks and logos are trademarks or registered trademarks of Sun Microsystems, Inc. in the United States, other countries, or both.

C-bus is a trademark of Corollary, Inc. in the United States, other countries, or both.

UNIX is a registered trademark of The Open Group in the United States and other countries.

SET, SET Secure Electronic Transaction, and the SET Logo are trademarks owned by SET Secure Electronic Transaction LLC.

Other company, product, and service names may be trademarks or service marks of others.

# Preface

The IBM @server xSeries 440 is IBM's flagship industry standard server and is the first full implementation of the 32-bit IBM XA-32 chipset, code named "Summit", as part of the Enterprise X-Architecture strategy. The x440 provides new levels of high availability and price performance, and offers scalability from two-way to 16-way SMP, from 2 GB to 128 GB of memory, and up to 24 PCI slots, all in one single system image.

This redbook is a comprehensive resource on the technical aspects of the server, and is divided into five key subject areas:

- ▶ Chapter 1, "Technical description" introduces the server and its subsystems and describes the key features and how they work.
- ▶ Chapter 2, "Positioning" examines the types of applications that would be used on a server such as the x440, including server consolidation, line-of-business application, and infrastructure applications. It reviews the features that make the x440 such a powerful system.
- ▶ Chapter 3, "Planning" describes the aspects of planning to purchase and planning to install the x440. It covers such topics as configuration, operating system specifics, scalability, and physical site planning.
- ▶ Chapter 4, "Installation" goes through the process of installing Windows 2000, Red Hat Linux, NetWare, and VMware ESX Server. It describes what BIOS and drivers updates are appropriate and when to install them.
- ▶ Chapter 5, "Management" describes how to use the key IBM Director extensions designed for the x440: System Partition Manager, Active PCI Manager, and Process Control.

A partner redbook is *Server Consolidation with the IBM @server xSeries 440 and VMware ESX Server*, SG24-6852.

## The team that wrote this redbook

This redbook was produced by a team of specialists from around the world working at the International Technical Support Organization, Raleigh Center.

**David Watts** is a Consulting IT Specialist at the International Technical Support Organization in Raleigh. He manages residencies and produces IBM Redbooks on hardware and software topics related to IBM xSeries systems and associated client platforms. He has authored over 20 redbooks; his most

recent books include *Integrating IBM Director with Enterprise Management Solutions* and *Implementing IBM Director Management Solutions*. He has a Bachelor of Engineering degree from the University of Queensland (Australia) and has worked for IBM for over 13 years. He is an IBM @server Certified Specialist for xSeries and an IBM Certified IT Specialist.

**Reza Fanaei Aghdam** is a Senior IT Specialist working in Zurich, Switzerland. He has 10 years of experience in support of computer, software and programming. He has a Bachelor of Computer Sciences degree from the Fachhochschule Konstanz and a Bachelor of Information Management from the University of Konstanz. His areas of expertise include xSeries servers, IBM Director, IBM FASTT solutions, and database programming. He is a Microsoft MCSE, Microsoft Certified Cluster Specialist, Novell MCNE, Citrix CCA, and an IBM @server Certified Expert for xSeries.

**Duncan Furniss** is an Advisory IT Specialist for IBM Canada, and is the senior xSeries product specialist for western Canada. He has 14 years of professional experience with Intel-based hardware, networking, and storage technologies, more than 11 of them at IBM. His areas of expertise include systems design and implementation, performance tuning, and systems management. He currently writes, consults, and presents on these and related topics regularly in the course of his work. He is an IBM @server Certified Specialist for xSeries. He was co-author of the redbook *High Availability without Clustering*.

**Jason King** is a Service Engineer working for W J Moncrieff in Perth, Western Australia. He has seven years of experience working with xSeries and Netfinity hardware. He is a Microsoft Certified Professional and an IBM @server Certified Specialist for xSeries. His areas of expertise include IBM xSeries servers, Windows NT 4.0, Windows 2000, and IBM Director.

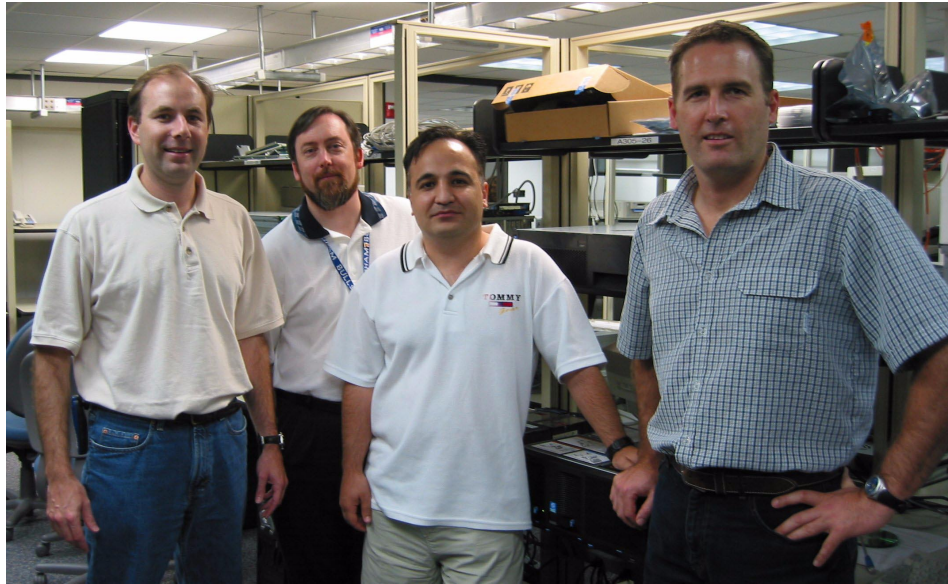

*The team (l-r): David, Duncan, Reza, Jason*

Thanks to the following people for their contributions to this project:

Alfredo Aldereguia, Lead Engineer, SS16 System Development, Raleigh  
Kenny Bain, EMEA Advanced Technical Support, Greenock  
Patrick de Broux, IT Consultant, ATS Product Introduction Centre, Hursley  
Donn Bullock, Global Brand Manager, Enterprise X-Architecture, Raleigh  
Alex Candelaria, Staff Engineer, Enterprise Support Group, Seattle  
Michael Cannon, xSeries Sales & Technical Education, Raleigh  
Mark Chapman, xSeries Marketing Communications, Raleigh  
Henry Chung, Technical Project Manager, Datacenter Offerings, Seattle  
Peter Escue, Americas Advanced Technical Support, Dallas  
Dottie Gardner, Technical Project Manager, Information Development, Raleigh  
Roger Hellman, xSeries Global Product Marketing Manager, Raleigh  
Ron Humphrey, Technical Project Manager, Active PCI Manager, Seattle  
Koichi Kii, Development Manager, Active PCI Manager, Seattle  
Grace Lennil, IBM Center for Microsoft Technologies, Seattle  
David A McIntosh, Technical Specialist, xSeries Techline, Greenock  
John McAbel, World Wide Cluster Offering Product Manager, Beaverton  
Gregg McKnight, Distinguished Engineer, xSeries Performance, Raleigh  
Robert Moon, Team Lead, xSeries Techline, Greenock  
Michael Parris, WW Technical Support Marketing, Raleigh  
Kiron Rakkar, Manager, WebSphere Beta Programs, Raleigh  
Paul Shaw, Active PCI Manager Development, Seattle  
Gary Turner, Technical Project Manager, System Partition Manager, Seattle

Damon West, Course Developer, xSeries Education, Raleigh

Thanks also to the team that wrote the redbook *Server Consolidation with the IBM @server xSeries 440 and VMware ESX Server*, SG24-6852: Steve Russell, Keith Olsen, Gabriel Sallah, and Chandrasekhara Seetharaman.

## Become a published author

Join us for a two- to six-week residency program! Help write an IBM Redbook dealing with specific products or solutions, while getting hands-on experience with leading-edge technologies. You'll team with IBM technical professionals, Business Partners and/or customers.

Your efforts will help increase product acceptance and customer satisfaction. As a bonus, you'll develop a network of contacts in IBM development labs, and increase your productivity and marketability.

Find out more about the residency program, browse the residency index, and apply online at:

[ibm.com/redbooks/residencies.html](http://ibm.com/redbooks/residencies.html)

## Comments welcome

Your comments are important to us!

We want our Redbooks to be as helpful as possible. Send us your comments about this or other Redbooks in one of the following ways:

- ▶ Use the online **Contact us** review redbook form found at:

[ibm.com/redbooks](http://ibm.com/redbooks)

- ▶ Send your comments in an Internet note to:

[redbook@us.ibm.com](mailto:redbook@us.ibm.com)

- ▶ Mail your comments to:

IBM Corporation, International Technical Support Organization  
Dept. HZ8 Building 662  
P.O. Box 12195  
Research Triangle Park, NC 27709-2195



## Technical description

The IBM @server xSeries 440 is the latest IBM top-of-the-range server and is the first full implementation of the 32-bit IBM XA-32 chipset, code named “Summit” as part of the Enterprise X-Architecture strategy. The x440 provides new levels of high availability and price performance, and offers scalability beyond a single server.

The following are the key features of the x440:

- ▶ Two-way Intel Xeon processor MP models, upgradable to four-way and eight-way
- ▶ Two-way Intel Xeon processor DP models, upgradable to four-way Xeon DP or four-way (and beyond) Xeon MP
- ▶ Ability to connect two x440s together to form a single eight-way (4+4), 12-way (4+8) or 16-way (8+8) SMP system image
- ▶ Physical system partitioning, controlled by IBM Director and the Remote Supervisor Adapter, to consolidate servers or set up high-speed clustering configurations
- ▶ 4U rack-dense design
- ▶ 32 MB XcelL4 Server Accelerator Cache providing an extra level of cache
- ▶ 2 GB or 4 GB RAM standard, up to 64 GB total using 2 GB ECC SDRAM DIMMs

- ▶ Memory enhancement such as memory mirroring, Chipkill, and Memory ProteXion
- ▶ Six Active PCI-X slots: two 64-bit 133 MHz, two 64-bit 100 MHz, two 64-bit 66 MHz
- ▶ Connectivity to an RXE-100 external PCI-X enclosure for an additional 12 PCI-X slots
- ▶ Integrated dual-channel Ultra160 SCSI controller
- ▶ Two hot-swap 1” drive bays
- ▶ Support for major storage subsystems, including Fibre Channel and ServeRAID
- ▶ Light Path Diagnostics and the Remote Supervisor Adapter for systems management
- ▶ Integrated 10/100/1000 Mbps Ethernet controller

The ability to connect multiple systems together and to partition them is the implementation of the concept of *XpandOnDemand*.

XpandOnDemand represents the first industry-standard implementation of true “pay-as-you-grow” servers. New levels of scalability are achieved using a building block design that allows more cost-effective scalability. These technologies, powered by the XA-32 chipset, will provide scalability from two-way up to 16-way systems using “scalable enterprise nodes”, the x440s being each of those nodes, and, optionally, one or more external remote I/O enclosures.

Each scalable enterprise node contains processors, memory, I/O support, storage and other devices and operates as an independent system. Each node may run a different operating system from the other nodes, or if desired multiple nodes can be assigned to one operating system image via system partitioning. Nodes are attached to one another through dedicated high-speed interconnections, called SMP Expansion Ports. This offers the flexibility to run several hardware nodes as either a single complex of nodes or as two or more smaller units to support multiple operating systems and/or clustered configurations. The nodes can even be rearranged later into other configurations, as needed.

## 1.1 The x440 product line

The models of the x440 are being made available throughout 2002. This is because the complexity associated with developing the new IBM XA-32 chipset, formerly known by its code name “Summit”, has meant additional development and testing being required for introducing the x440 above that required of other



products. Additional testing pertains directly to the complexity of multiple SMP configurations and the time commitment required for testing the ServerProven list against each of these configurations.

All of the capabilities of the x440, including 16-way SMP capability and remote I/O sharing, were announced in March 2002, but as a result of this additional configuration development and testing, the x440 configurations will be introduced in multiple phases during 2002 and 2003 as testing is completed.

**Important:** This document covers the products as of November 2002 in detail, and only introduces the likely features of the follow-on models.

The models available as of November 2002 are listed in Table 1-1.

*Table 1-1 Models available from November 2002*

<b>Model</b>	<b>Standard processors</b>	<b>Max SMP</b>	<b>L2 cache</b>	<b>L3 cache</b>	<b>Std memory</b>
8687-1RX	2x 1.4 GHz Intel Xeon MP	8-way	256 KB	512 KB	2 GB (4x 512 MB)
8687-2RX	2x 1.5 GHz Intel Xeon MP	8-way	256 KB	512 KB	2 GB (4x 512 MB)
8687-3RX	2x 1.6 GHz Intel Xeon MP	8-way	256 KB	1 MB	2 GB (4x 512 MB)
8687-4RX	2x 1.5 GHz Intel Xeon MP	8-way	256 KB	1 MB	2 GB (4x 512 MB)
8687-5RX	2x 1.9 GHz Intel Xeon MP	8-way	256 KB	1 MB	2 GB (4x 512 MB)
8687-6RX	4x 1.9 GHz Intel Xeon MP	8-way	256 KB	1 MB	4 GB (4x 1 GB)
8687-7RX	4x 2.0 GHz Intel Xeon MP	8-way	256 KB	2 MB	2 GB (4x 512 MB)
8687-3RY	2x 2.4 GHz Intel Xeon DP	4-way	512 KB	0	2 GB (4x 512 MB)
8687-4RY	4x 2.4 GHz Intel Xeon DP	4-way	512 KB	0	4 GB (8x 512 MB)

The x440 models that have Xeon MP processors installed currently only support processor configurations of two, four and eight processors. The x440 models that have Xeon DP processors only support processor configurations of two or four processors, but can be upgraded to eight Xeon MP processors if desired.

Figure 1-1 on page 4 shows the available single-node configurations and the CPU and memory options.

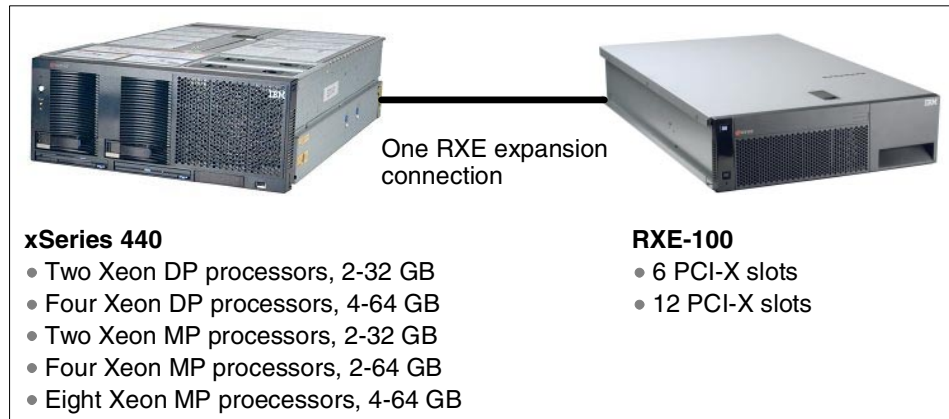

Figure 1-1 x440 configurations currently available

The attachment of a single RXE-100 Remote Expansion Enclosure is also supported, as shown in Figure 1-1. The RXE-100 has six PCI-X slots standard, upgradable to 12 PCI-X slots, giving the customer up to a total of 12 PCI-X or 18 PCI-X slots respectively.

In addition to the single-node configurations, three additional two-node configurations are possible:

- ▶ A single 16-way system comprised of two eight-way x440 nodes, as shown in Figure 1-2 on page 5. This will be available in November 2002.
- ▶ A single 12-way system comprised of an eight-way and a four-way x440, as shown in Figure 1-3 on page 5. This will be available in early 2003.
- ▶ A single eight-way system comprised of two four-way x440 nodes, as shown in Figure 1-3 on page 5. This will be available in early 2003.

Each of these configurations can optionally also have an RXE-100 attached (see Figure 1-2 on page 5 for an example).

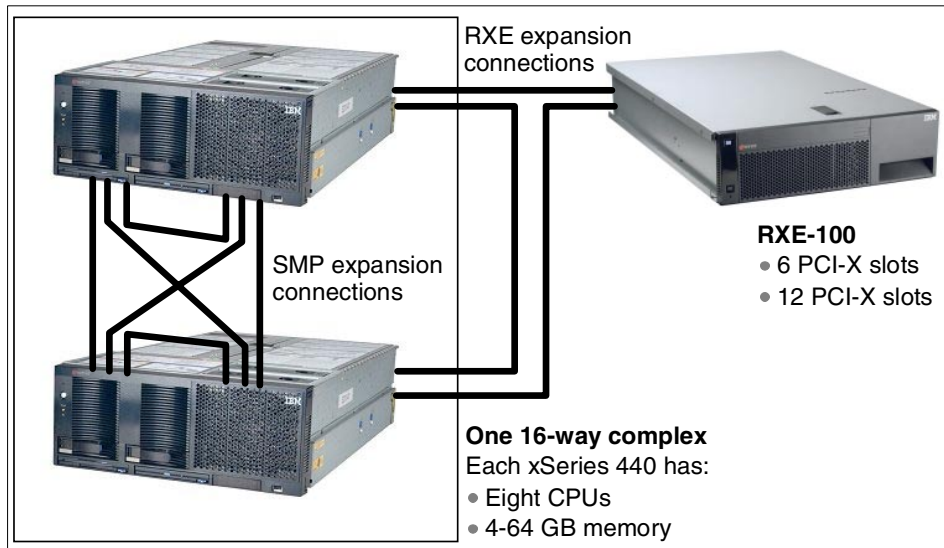

Figure 1-2 16-way server configuration using two eight-way x440 nodes

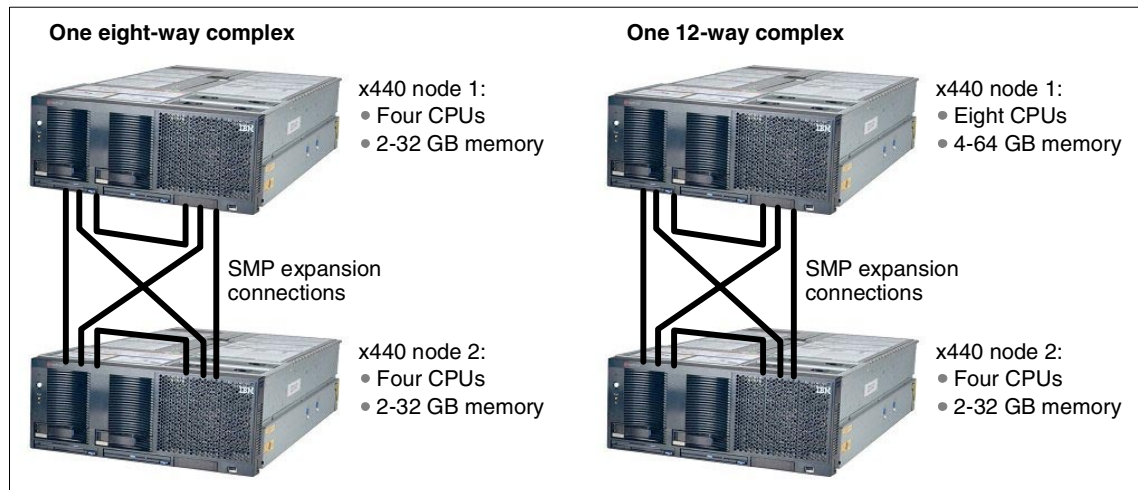

Figure 1-3 Eight-way and 12-way two-node configurations

## 1.2 System partitioning

Partitioning is the ability to divide a system to support multiple operating system images simultaneously. The benefits of system partitioning include:

- ▶ Hardware consolidation
- ▶ Software migration and coexistence
- ▶ Version control
- ▶ Development, testing and maintenance
- ▶ Workload isolation
- ▶ Resource optimization around a particular application and operating system combination
- ▶ Independent backup and recovery on a partition basis

There are two types of system partitioning: physical partitioning (hardware-based, but not yet available) and logical partitioning (software-based, enabled with VMware ESX Server):

- ▶ Logical partitioning

Using logical partitioning, administrators can partition a multinode complex at the individual processor level (with associated memory, I/O and other required resources) or even lower (that is, multiple partitions per processor) without shutting down and restarting the hardware and software.

VMware ESX Server V1.5 supports one to eight partitions per CPU, up to a maximum total of 64 partitions. For example, in an eight-way server, you can have between eight partitions and 64 partitions. In V1.5, a partition cannot span multiple CPUs, but a partition can be allocated a fraction of a CPU, down to 1/8th of a CPU.

ESX Server virtualizes the resources of the x440 and is the closest that Intel-based servers have come to date to the LPAR implementation of zSeries mainframes.

When workload demands change, you can reassign resources from one logical partition to another without having to shut down and restart the system. ESX Server does not, however, support hot-adding of hardware (such as disks and adapters).

For more information on ESX Server, see the redbook *Server Consolidation with the IBM @server xSeries 440 and VMware ESX Server*, SG24-6852 and 3.5.7, “VMware ESX Server” on page 98.

- ▶ Physical partitioning

This form of partitioning is available in 4Q 2002 with the release of System Partition Manager, a plug-in for IBM Director.

With physical partitioning, a single multinode server complex can simultaneously run multiple instances of one operating system in separate partitions, as well as multiple versions of an operating system or even different types of operating systems. The components of the server (for example memory, CPUs, and I/O) are physically divided, under the control of the server's firmware and IBM Director.

The server can have up to two nodes, each capable of running its own operating system and applications, all running simultaneously. A partition can also span nodes, even to the point of having all four nodes serving one operating system. Each node can be managed independently by IBM Director.

See 5.2, "System Partition Manager" on page 150 for details.

## 1.3 IBM XA-32 chipset

The IBM XA-32 chipset is the product name describing the chipset developed under the code name "Summit" and implemented on the IA-32 platform. A product of the IBM Microelectronics Division in Austin, Texas, the XA-32 chipset is fabricated using the latest in copper technology and is composed of the following components:

- ▶ Memory controllers — one memory controller, code named "Cyclone", per four-way located within the SMP Expansion Module
- ▶ Processor/cache controllers — one processor and cache controller, code named "Twister", per eight-way located within the SMP Expansion Module
- ▶ PCI bridges — two PCI bridges, code named "Winnipeg", per x440 located on the centerplane and the I/O board that control both the PCI-X and Remote I/O

Figure 1-4 on page 8 shows the various IBM XA-32 components in a four-way x440 configuration.

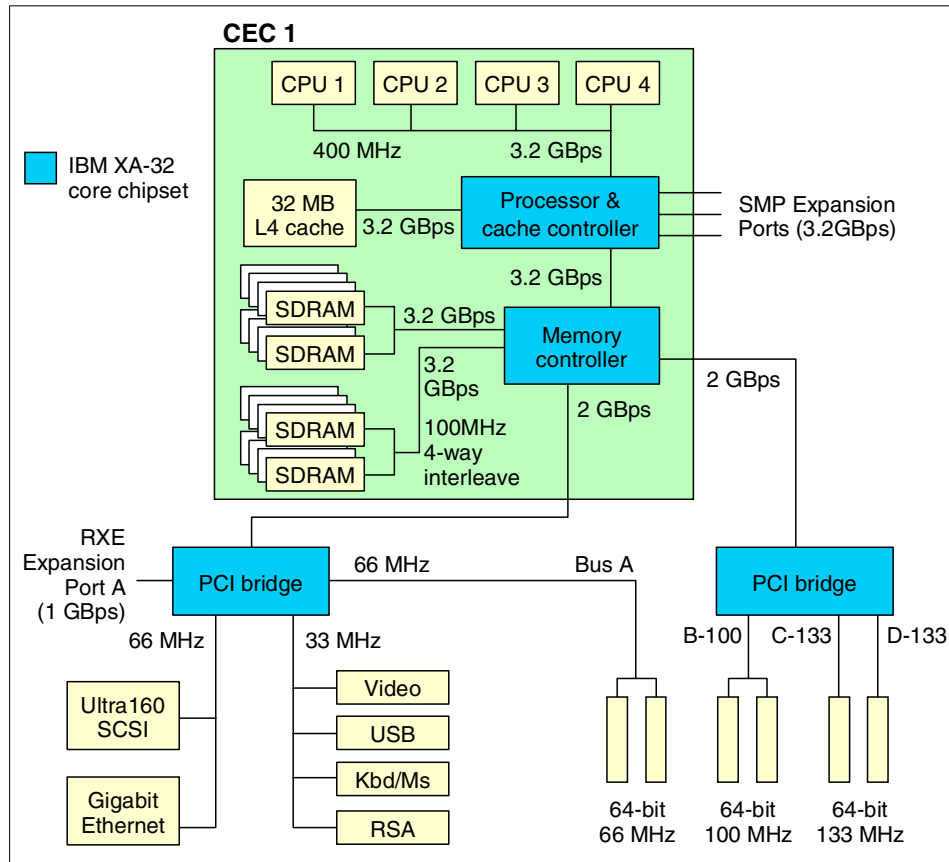

Figure 1-4 xSeries 440 system block diagram — one SMP Expansion Module

The component that contains the CPUs, processor/cache controller, memory controller, memory, and cache is called the SMP Expansion Module (or central electronics complex—CEC). The Xeon MP-based models of the x440 ship with one SMP Expansion Module with two or four CPUs and 2 GB or 4 GB of RAM. The Xeon DP-based models have either two CPUs in one SMP Expansion Module or four CPUs in two SMP Expansion Modules.

**Tip:** The terms *central electronics complex*, *CEC*, and *SMP Expansion Module* are used interchangeably in relation to the x440. We use SMP Expansion Module in this redbook.

The CPUs are connected together with a 100 MHz frontside bus, but supply data at an effective rate of 400 MHz using the “quad-pump” design of the Intel NetBurst architecture as described in 1.4.1, “Intel Xeon Processor MP” on page 13. To ensure the processors are optimally used, the x440 has a 32 MB Xcel4 Server Accelerator Cache, comprised of 200 MHz DDR memory. This L4 system cache services all CPUs in an SMP Expansion Module.

Memory used in the x440 is standard 133 MHz ECC SDRAM DIMMs; however, the 133 MHz DIMMs are run at 100 MHz (for parts availability reasons). With 2 GB DIMMs, up to 32 GB can be installed using all 16 DIMM sockets. The memory is four-way interleaved so that the memory subsystem can supply data fast enough to match the throughput of the CPUs. Four-way interleaving means that DIMMs must be installed in matched fours and in specific DIMM sockets (see 3.1.2, “Memory” on page 65).

The second SMP Expansion Module can be installed when more than four Xeon MP processors, or two Xeon DP processors, are required. This also enables the system to have up to 64 GB of RAM, using 2 GB DIMMs. The block diagram with two SMP Expansion Modules is shown in Figure 1-5 on page 10.

**Note:** When Xeon DP processors are used, only two CPUs can be installed in each SMP Expansion Module. The processors are installed in CPU positions 1 and 4. Positions 2 and 3 must hold air baffles to maintain proper air flow.

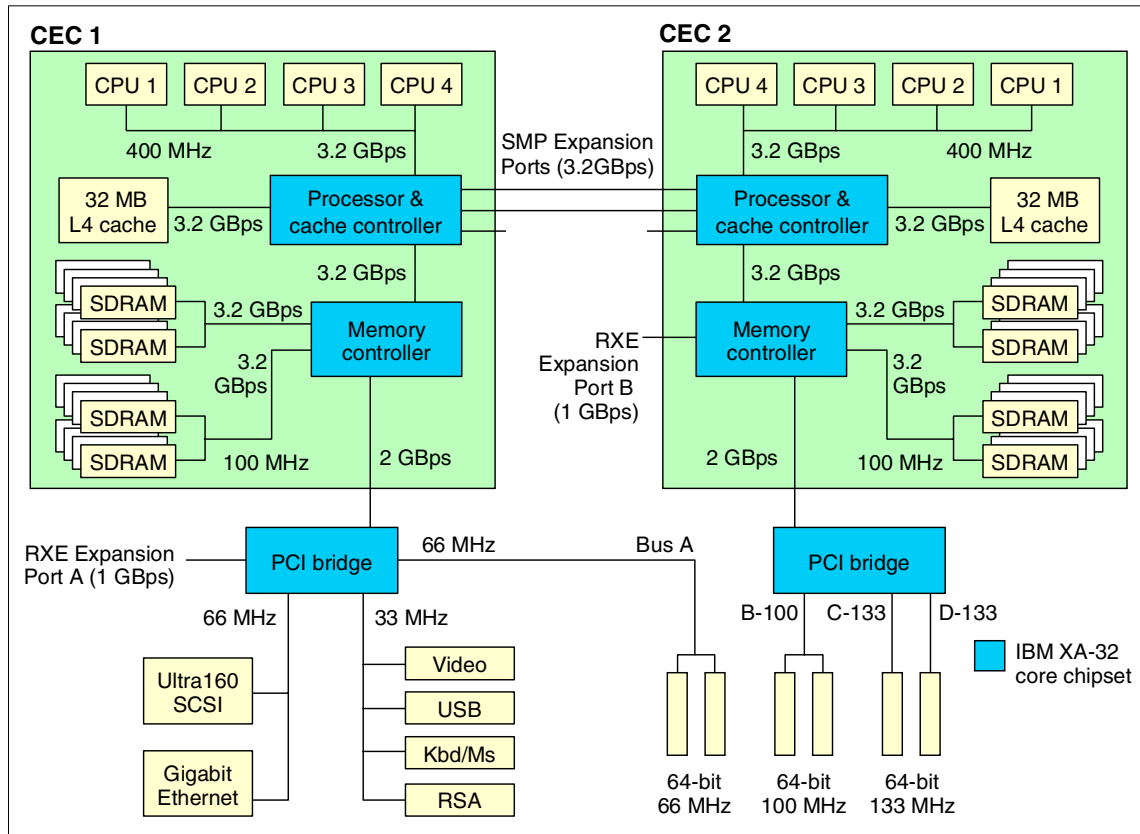

Figure 1-5 xSeries 440 system block diagram — two SMP Expansion Modules

When two SMP Expansion Modules are installed, they are connected together using two 3.2 GBps SMP Expansion Ports. The third scalability port is not used in this single-node eight-way configuration.

The two PCI bridges in the XA-32 chipset provide support for 33, 66, 100, and 133 MHz devices using four PCI-X buses (labeled A-D in Figure 1-5). This is discussed further in 1.8, “PCI subsystem” on page 23.

The PCI bridge also has a 1 GBps bi-directional Remote Expansion I/O port (RXE port) for connectivity to the RXE-100 enclosure. This port is labeled “RXE Expansion Port A” in both Figure 1-4 on page 8 (four-way) and Figure 1-5 (eight-way). The RXE-100 provides up to an additional 12 PCI-X slots. When the second SMP Expansion Module is installed to form an eight-way system (Figure 1-5), the second RXE port, labeled “RXE Expansion Port B”, connects to the memory controller of the second SMP Expansion Module.



As of November 2002, you can connect two x440 servers together to form one 16-way complex. The two x440 nodes are connected together using all three SMP Expansion Ports as shown in Figure 1-6.

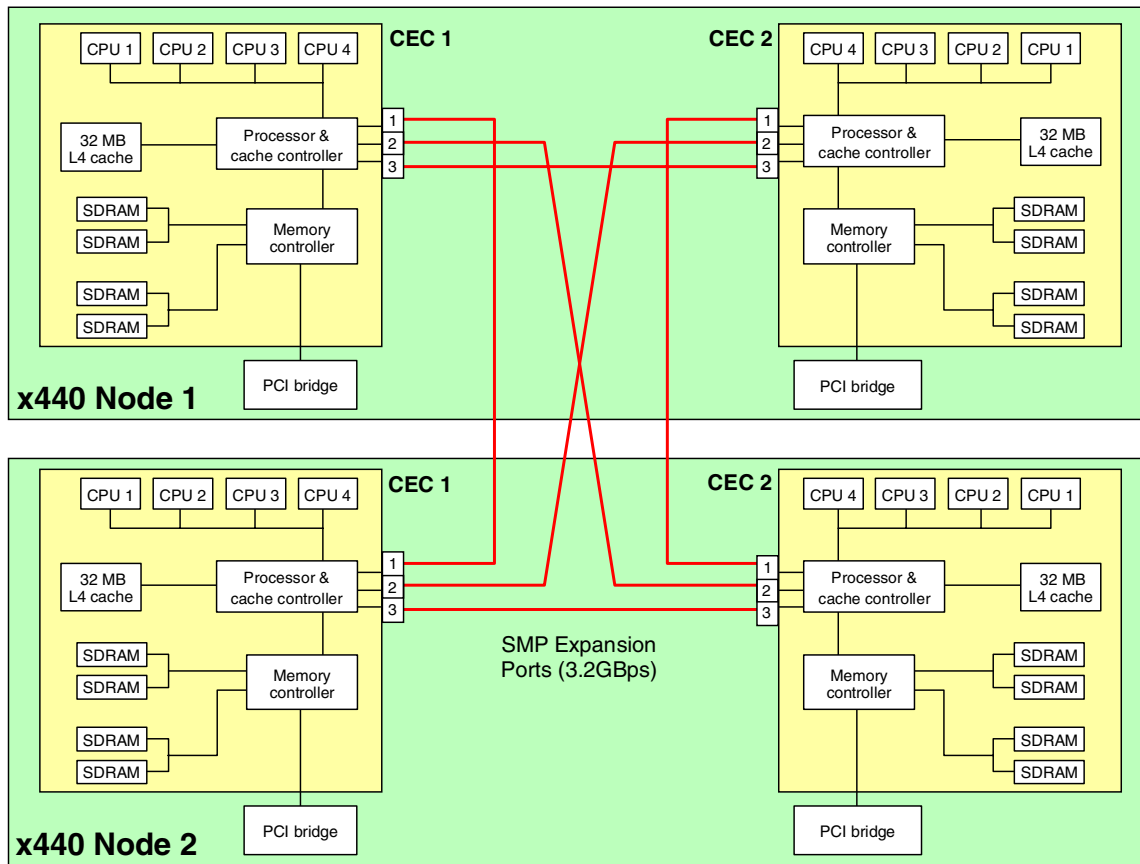

Figure 1-6 16-way configuration (four SMP Expansion Modules)

The rear panel of the x440, indicating the location of the SMP Expansion Ports and RXE Expansion Ports, is shown in Figure 1-7 on page 12.

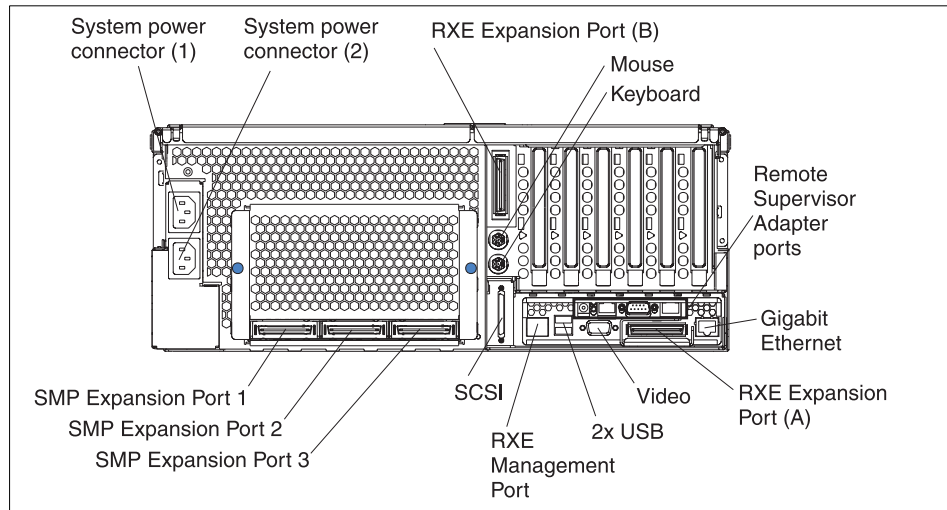

Figure 1-7 Rear panel of the xSeries 440 (one SMP Expansion Module installed)

## 1.4 Processors

The x440 models use one of the following processors:

- ▶ Xeon Processor MP (“Gallatin”)
- ▶ Xeon Processor MP (“Foster”)
- ▶ Xeon Processor DP (“Prestonia”)

The Xeon MP models of the x440 come with two or four processors installed in the standard SMP Expansion Module. Up to four processors are supported in the standard module and, with the addition of a second SMP Expansion Module, up to eight processors can be installed in an x440.

The x440 entry-level systems can be ordered with either two Xeon DP processors in a single SMP Expansion Module or with four Xeon DP processors in two SMP Expansion Modules. There is no further upgrade beyond four Xeon DP processors, other than replacing them with Xeon MP processors.

See 3.1.1, “Processors” on page 64 for further discussion about what you should consider before implementing an x440 solution.

## 1.4.1 Intel Xeon Processor MP

The Xeon Processor MP (code named “Foster” or “Gallatin”) returns to the ZIF socket design of the original Pentium processor, instead of the Slot 2 cartridge design of the Pentium III Xeon processors. This smaller form factor means that the x440 can have up to eight processors in a 4U node.

The Xeon MP processor has three levels of cache, all of which are on the processor die:

- ▶ Level 3 cache is equivalent to L2 cache on the Pentium III Xeon. Foster processors in the x440 models contain either 512 KB or 1 MB of L3 cache. Gallatin processors contain either 1 MB or 2 MB of L3 cache.
- ▶ Level 2 cache is equivalent to L1 cache on the Pentium III Xeon and is 256 KB in size. The L2 cache implements the Advanced Transfer Cache technology, which means L2-to-processor transfers occur across a 256-bit bus in only one clock cycle.
- ▶ A new level 1 cache, 12 KB in size, is “closest” to the processor and is used to store micro-operations (that is, decoded executable machine instructions) and serves those to the processor at rated speed. This additional level of cache saves decode time on cache hits. There is an additional 8 KB for data related to those instructions, for a total of 20KB.

The x440 also implements a Level 4 cache as described in 1.6, “IBM XceL4 Server Accelerator Cache” on page 19.

Intel has also introduced a number of features associated with its newly announced NetBurst micro-architecture. These are available in the x440, including:

- ▶ 400 MHz frontside bus

The Pentium III Xeon processor has a 100 MHz frontside bus that equates to a burst throughput of 800 MBps. With protocols such as TCP/IP, this has been shown to be a bottleneck in high-throughput situations. The Xeon Processor MP improves on this by using two 100 MHz clocks, out of phase with each other by 90° and using both edges of each clock to transmit data. This is shown in Figure 1-8.

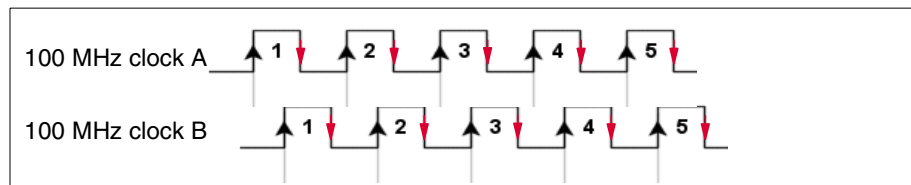

Figure 1-8 Quad-pumped frontside bus

This increases the performance of the frontside bus without the difficulty of high-speed clock signal integrity issues. The end result is an effective burst throughput of 3.2 GBps, which can have a substantial impact, especially on TCP/IP-based LAN traffic.

► Hyper-Threading

Hyper-Threading technology enables a single physical processor to execute two separate code streams (threads) concurrently. To the operating system, a processor with Hyper-Threading appears as two *logical* processors, each of which has its own architectural state - that is, its own data, segment, and control registers and its own advanced programmable interrupt controller (APIC).

For example, Figure 1-9 shows a 16-way x440 complex running Datacenter Server with Hyper-Threading enabled.

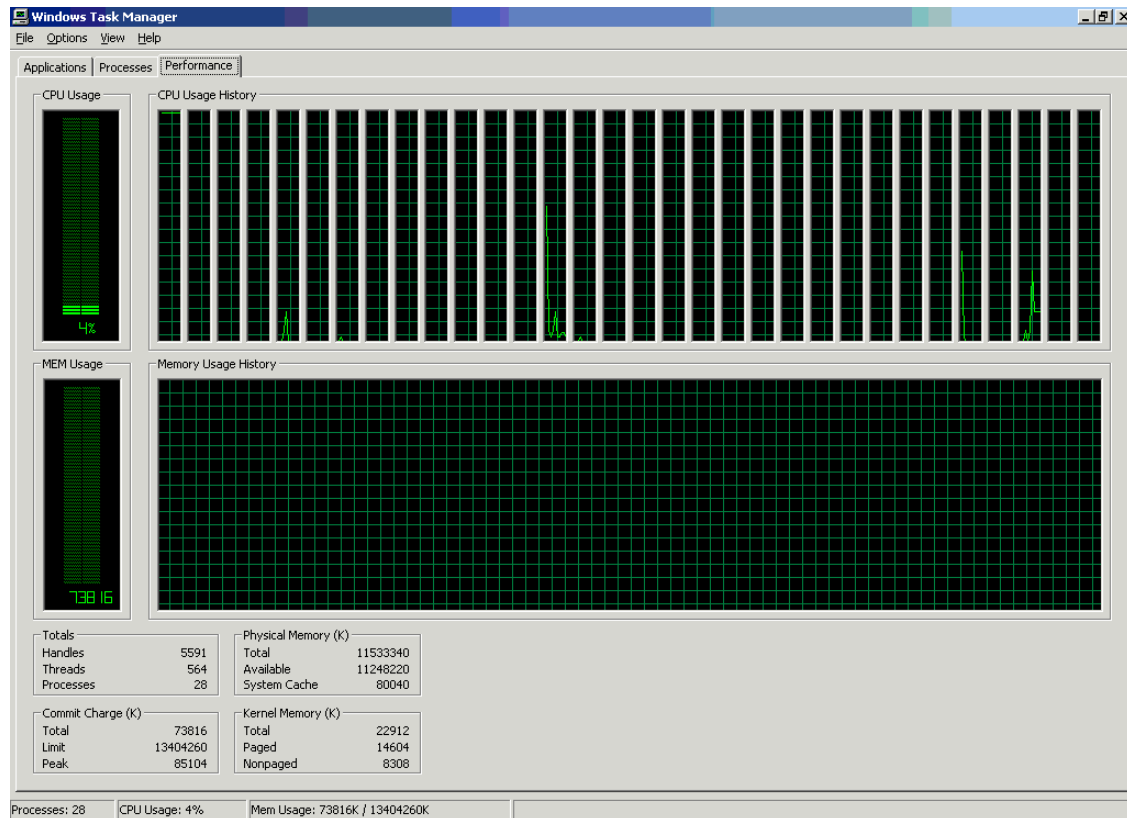

Figure 1-9 Datacenter sees 32 processors when Hyper-Threading is enabled on a 16-way configuration

Each logical processor can be individually halted, interrupted, or directed to execute a specified thread, independently from the other logical processor on the chip. Unlike a traditional two-way SMP configuration that uses two separate physical processors, the logical processors share the execution resources of the processor core, which include the execution engine, the caches, the system bus interface, and the firmware.

**Note:** Hyper-Threading is disabled by default on the x440. This is because of a known bug in Windows 2000 Advanced Server. If Hyper-Threading is enabled on an eight-way server, then the Windows 2000 Advanced Server will trap (blue screen) during installation. This problem does not affect other supported operating systems.

Hyper-Threading technology is designed to improve server performance by exploiting the multi-threading capability of operating systems, such as Windows .NET and Linux, and server applications, in such a way as to increase the use of the on-chip execution resources available on these processors.

Fewer or slower processors usually yield the best gains from Hyper-Threading because there is a greater likelihood that the software can spawn sufficient numbers of threads to keep both paths busy. The following performance gains are likely:

- Two physical processors: 15-25% performance gain
- Four physical processors: 1-13% gain
- Eight physical processors: 0-5% gain

Tests have found that software often limits SMP scalability, but customers should expect improved results as software matures. Best-case applications today are:

- Databases
- Java
- Web servers
- E-mail

**Note:** Microsoft licensing of the Windows Server operating systems is by number of processors (four-way for Server, eight-way for Advanced Server, 32-way for Datacenter Server). Therefore, the appearance of twice as many logical processors can potentially affect the installation of the operating system. See 1.12, “Operating system support” on page 28 for details.

For more information about Hyper-Threading, see:

<http://www.intel.com/technology/hyperthread/>

► Advanced Dynamic Execution

The Pentium III Xeon processor has a 10-stage pipeline. However, the large number of transistors in each pipeline stage means that the processor is limited to speeds under 1 GHz, due to latency in the pipeline.

The Xeon Processor MP has a 20-stage pipeline, which can hold up to 126 concurrent instructions in flight and up to 48 reads and 24 writes active in the pipeline. The lower complexity of each stage also means that future clock speed increases are possible.

It is important to note, however, that the longer pipeline means that it now takes more clock cycles to execute the same instruction when compared to the Pentium III Xeon.

Comparing the Xeon Processor MP with the Pentium III Xeon and current operating systems (Windows 2000, Linux with 2.4 kernel), good rules of thumb are:

- 1.5 GHz Xeon Processor MP/512 KB L3  $\approx$  5-20% faster than 900 MHz 2 MB L2 Xeon
- 1.6 GHz Xeon Processor MP/1 MB L3  $\approx$  15-35% faster than 900 MHz 2 MB L2 Xeon

The next generations of operating systems will likely improve performance of the MP processor as they take advantage of the NetBurst architecture. These include Windows .NET and the Linux 2.5/2.6 kernels.

For more information about the features of the Xeon Processor MP, go to:

<http://www.intel.com/design/xeon/xeonmp/prodbref>

## 1.4.2 Intel Xeon Processor DP

The Xeon DP is similar to the Xeon MP and is also based on the Intel NetBurst micro-architecture. The Xeon DP was designed by Intel to be suitable only in uniprocessor and two-way SMP processor systems. However, with the use of the IBM XA-32 chipset, the x440 can have up to four Xeon DP processors installed. The Xeon DP models of the x440 models use 2.4 GHz processors, part 37L3533.

The key differences between the processors are listed in Table 1-2.

Table 1-2 Differences between the Xeon DP and the Xeon MP

Feature	Xeon Processor DP	Xeon Processor MP
Maximum CPUs per SMP Expansion Module	Two	Four
Maximum CPUs per x440 node	Four	Eight

Feature	Xeon Processor DP	Xeon Processor MP
Supported in multi-node configurations	No	Yes
Core frequency (x440 models)	2.4 GHz	1.4, 1.5, 1.6, 1.9, or 2.0 GHz
Level 2 cache	512 KB	256 KB
Level 3 cache	None	512 KB, 1 MB or 2 MB

For more information about the features of the Xeon Processor DP, go to:

<http://www.intel.com/design/xeon/prodbref>

## 1.5 SMP Expansion Module

The SMP Expansion Module is the central electronics complex that contains the processors, memory, L4 system cache, and respective controllers for these components. The base x440 system includes one SMP Expansion Module. Each SMP Expansion Module contains slots for up to four Xeon MP processors (or two Xeon DP processors) and 16 DIMMs.

There are two SMP Expansion Module part numbers for x440 models:

- ▶ 32P8340 is used in Xeon MP models. It is “unpopulated”, which means it does not contain any processors or memory. Any of the support Xeon MP processors can be installed in it.
- ▶ 71P7919 is used in Xeon DP models. It contains two 2.4 GHz Xeon DP processors and VRMs, and is used to upgrade a two-way Xeon DP x440 to a four-way configuration.

71P7919 is also compatible with Xeon MP processors. If you wish to upgrade your Xeon DP-based x440 to use Xeon MP processors, you can simply replace the processors and VRMs with supported Xeon MP processors.

**Note:** Information about the SMP Expansion Modules to be used in Gallatin-based systems (or existing systems you wish to upgrade to Gallatin processors) was not available at the time of publication.

The SMP Expansion Module is installed from the top of the server and mounts to the side of the centerplane using two levers on the top, as shown in Figure 1-10 on page 18. These same levers are used to remove the top of the SMP Expansion Module when adding additional processors or memory.

**Tip:** Be careful when removing or installed the SMP Expansion Modules, because you may damage the center plane. See tip H176162 for details:

<http://www.pc.ibm.com/qtechinfo/MIGR-43675.html>

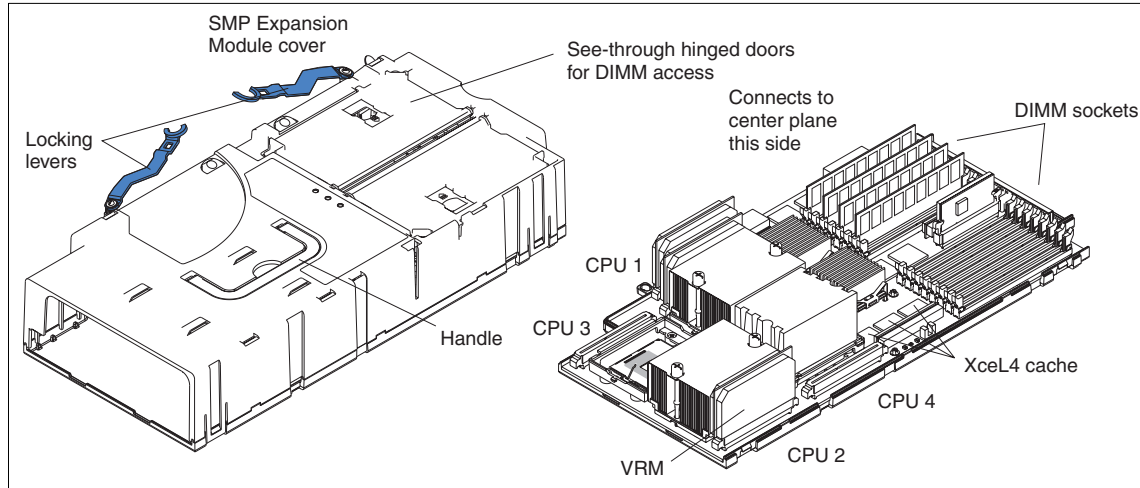

Figure 1-10 SMP Expansion Module

Each SMP Expansion Module also contains 16 DIMM slots to take the memory up to a maximum of 64 GB per node (using 2 GB DIMMs) and an additional 32 MB of Level 4 system cache for a maximum of 64 MB per node.

When two SMP Expansion Modules are installed, they are connected together using two 3.2 GBps SMP Expansion Ports (also known as scalability ports). Using two connections improves throughput beyond that of one connection and provides load balancing. The third scalability port is not used in this single-node eight-way configuration.

Each SMP Expansion Module is also equipped with the following LEDs for Light Path Diagnostics:

- ▶ Each DIMM
- ▶ Each CPU
- ▶ Each VRM
- ▶ SMP Expansion Module board



## 1.6 IBM XceL4 Server Accelerator Cache

Integrated into each SMP Expansion Module is 32 MB of high-speed Level 4 cache (see Figure 1-10). This XceL4 Server Accelerator Cache provides the necessary extra level of cache to alleviate the bottlenecks caused by memory latency across the scalability port.

Cache memory is two-way interleaved 200 MHz DDR memory and is faster than standard memory because it is directly connected to the memory controller and does not have additional latency associated with the large fan-out necessary to support the 16 DIMM slots.

Initial tests have shown the XceL4 cache has improved overall system performance up to 20% on various applications.

## 1.7 System memory

The Xeon MP models of the x440 have 2 GB or 4 GB of RAM standard, implemented as four PC133 ECC SDRAM DIMMs (four 512 MB or four 1 GB DIMMs). There are 16 DIMM sockets (two ports of eight) in each of the two SMP Expansion Modules for a total of 32 sockets. Using 2 GB DIMMs, this means that each x440 can have up to 64 GB RAM.

See 3.1.2, “Memory” on page 65 for further discussion of how memory is implemented in the x440 and what you should consider before an x440 installation.

There are a number of advanced features implemented in the x440 memory subsystem, collectively known as *Active Memory*:

- ▶ Memory ProteXion

Memory ProteXion, also known as “redundant bit steering”, is the technology behind using redundant bits in a data packet to provide backup in the event of a DIMM failure.

Currently, other industry-standard servers use 8 bits of the 72-bit data packets for ECC functions and the remaining 64 bits for data. However, because the x440 uses four-way interleaved memory, it needs only 6 bits to perform the same ECC functions, thus leaving 2 bits free (Figure 1-11 on page 20).

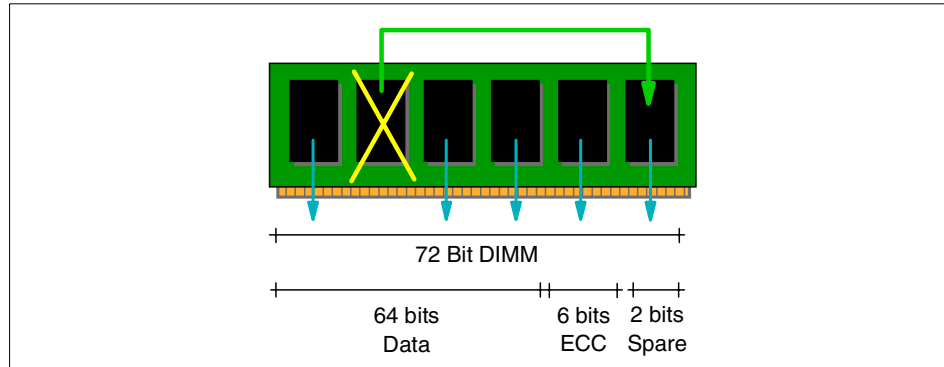

Figure 1-11 Memory ProteXion

In the event that a chip failure on the DIMM is detected by memory scrubbing, the memory controller can re-route data around that failed chip through the spare bits (similar to the hot-spare drive of RAID array). It can do this automatically without issuing a Predictive Failure Analysis (PFA) or Light Path Diagnostics alert to the administrator. After the second DIMM failure, PFA and Light Path Diagnostics alerts would occur on that DIMM as normal.

► Memory scrubbing

Memory scrubbing is an automatic daily test of all the system memory that detects and reports memory errors that might be developing before they cause a server outage.

Memory scrubbing and Memory ProteXion work in conjunction with each other, but they do not require memory mirroring (as described below) to be enabled to work properly.

When a bit error is detected, memory scrubbing determines if the error is recoverable or not. If it is recoverable, Memory ProteXion is enabled and the data that was stored in the damaged locations is rewritten to a new location. The error is then reported so that preventative maintenance can be performed. As long as there are enough good locations to allow the proper operation of the server, no further action is taken other than recording the error in the error logs.

If the error is not recoverable, then memory scrubbing sends an error message to the Light Path Diagnostics, which then turns on the proper lights and LEDs to guide you to the defective DIMM. If memory mirroring is enabled, then the mirrored copy of the data in the damaged DIMM is used until the system is powered down and the DIMM replaced.

► Memory mirroring

Memory mirroring is roughly equivalent to RAID-1 in disk arrays, in that memory is divided in two ports and one port is mirrored to the other half (see Figure 1-12). If 8 GB is installed, then the operating system sees 4 GB once memory mirroring is enabled (it is disabled in BIOS by default). All mirroring activities are handled by the hardware without any additional support required from the operating system.

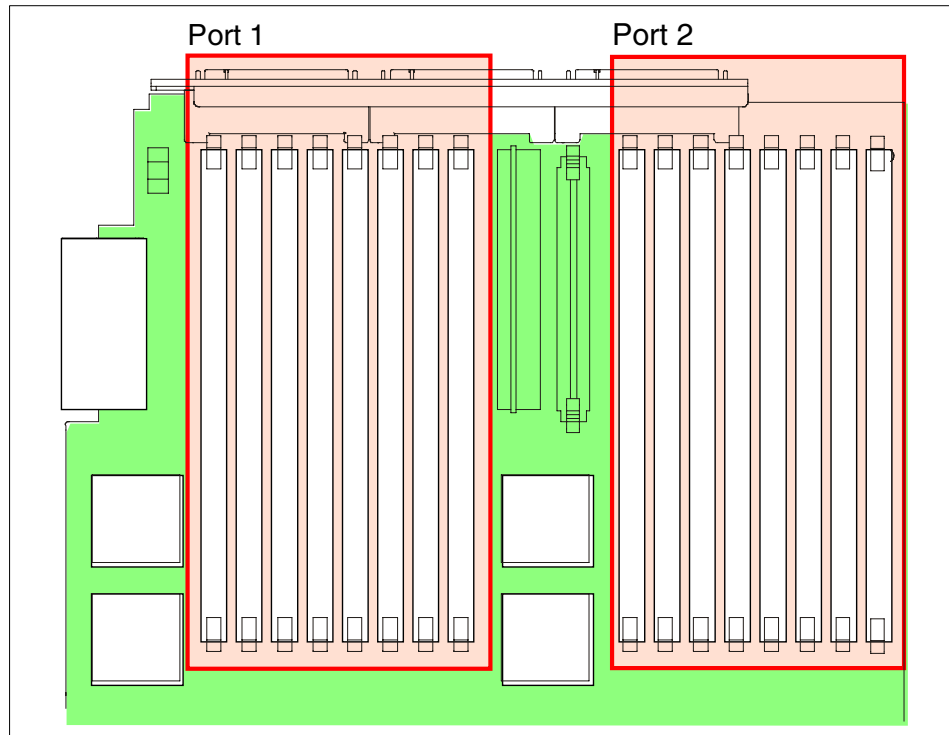

Figure 1-12 Memory DIMMs are divided into two ports

When memory mirroring is enabled (see 4.1.2, “Enabling memory mirroring” on page 108), the data that is written to memory is stored in two locations. One copy is kept in the port 1 DIMMs, while a second copy is kept in the port 2 DIMMs. During the execution of the read command, the data is read from the DIMM with the least amount of reported memory errors through memory scrubbing.

If memory scrubbing determines the DIMM is damaged beyond use, read and write operations are redirected to the partner DIMM in the other port. Memory scrubbing then reports the damaged DIMM and the Light Path Diagnostics display the error. If memory mirroring is enabled, then the mirrored copy of the

data in the damaged DIMM is used until the system is powered down and the DIMM replaced.

Certain restrictions exist with respect to placement and size of memory DIMMs when memory mirroring is enabled. These are discussed in “Memory mirroring” on page 67.

► **Chipkill memory**

Chipkill is integrated into the XA-32 chipset and does not require special Chipkill DIMMs. Chipkill corrects multiple single-bit errors to keep a DIMM from failing. When combining Chipkill with Memory ProteXion and Active Memory, the x440 provides very high reliability in the memory subsystem. Chipkill memory is approximately 100 times more effective than ECC technology, providing correction for up to four bits per DIMM (eight bits per memory controller), whether on a single chip or multiple chips.

If a memory chip error does occur, Chipkill is designed to automatically take the inoperative memory chip offline while the server keeps running. The memory controller provides memory protection similar in concept to disk array striping with parity, writing the memory bits across multiple memory chips on the DIMM. The controller is able to reconstruct the “missing” bit from the failed chip and continue working as usual.

Chipkill support is provided in the memory controller and implemented using standard ECC DIMMs, so it is transparent to the operating system.

In addition, to maintain the highest levels of system availability, if a memory error is detected during POST or memory configuration, the server can automatically disable the failing memory bank and continue operating with reduced memory capacity. You can manually re-enable the memory bank after the problem is corrected via the Setup menu in BIOS.

Memory mirroring, Chipkill, and Memory ProteXion provide multiple levels of redundancy to the memory subsystem. Combining Chipkill with Memory ProteXion enables up to two memory chip failures per memory port (8 DIMMs) on the x440. An eight-way x440 with its four memory ports could sustain up to eight memory chip failures. Memory mirroring provides additional protection with the ability to continue operations with memory module failures.

1. The first failure detected by the Chipkill algorithm on each port doesn't generate a Light Path Diagnostics error, since Memory ProteXion recovers from the problem automatically.
2. Each memory port could then sustain a second chip failure without shutting down.
3. Provided that memory mirroring is enabled, the third chip failure on that port would send the alert and take the DIMM offline, but keep the system running out of the redundant memory bank.

**Note:** The ability to hot-replace a failed DIMM or hot-add additional DIMMs are currently not supported.

## 1.8 PCI subsystem

As shown in Figure 1-4 on page 8, there are six PCI-X slots internal to the x440:

- ▶ Two 133 MHz slots, which accept 32 or 64-bit, 3.3 V, PCI or PCI-X adapters, from 33-133 MHz
- ▶ Two 100 MHz slots, which accept 32 or 64-bit, 3.3 V, PCI or PCI-X adapters, from 33-100 MHz
- ▶ Two 66 MHz slots, which accept 32 or 64-bit, 3.3 V, 33 or 66 MHz, PCI or PCI-X adapters

See 3.1.3, “PCI slot configuration” on page 68 for details on what adapters are supported and in what combinations.

The PCI subsystem also supplies these I/O devices:

- ▶ Two Wide Ultra 160 SCSI ports, one internal and one external (Adaptec AIC-7899 chipset)
- ▶ Gigabit Ethernet port (Broadcom 5700 chipset)

The x440 was the first xSeries server to offer a Gigabit Ethernet controller integrated standard in the system. The x440 includes a single-port Broadcom BCM5700 10/100/1000 Base-T MAC (Media Access Controller) on a PCI 64-bit 66 MHz bus.

The BCM5700 supports full and half-duplex performance at all speeds (10/100/1000 Mbps, auto-negotiated) and includes integrated on-chip memory for buffering data transmissions to ensure the highest network performance and dual onboard RISC processors for advanced packet parsing and backwards compatibility with today's 10/100 network. The Broadcom controller also includes software support for failover, layer-3 load balancing, and comprehensive diagnostics.

Category 5 or better Ethernet cabling is required with RJ-45 connectors. If you plan to implement a Gigabit Ethernet connection, ensure your network infrastructure is capable of the necessary throughput to match the server's I/O capacity.

- ▶ SVGA with 8 MB video memory (S3 Savage4 Pro chipset)
- ▶ Three USB ports (one on front panel, two on rear)
- ▶ Remote Supervisor Adapter (RS-485 ASM interconnect bus, 10/100 Ethernet and serial ports)

**Note:** There are no parallel or serial ports on the x440. For serial connections, use the USB to Serial Adapter, part number 10K3661, as described in 3.2.4, “Serial connections” on page 83.

With the addition of an RXE-100 Remote Expansion Enclosure, you can connect an additional six or 12 PCI-X adapters to the x440. See 3.2.3, “Remote Expansion Enclosure” on page 78 for details.

**Note:** Currently, only one RXE-100 can be connected to an x440 configuration. For configurations up to eight-way (that is, single chassis), connectivity is using one RXE Expansion Port and cable. The dual-chassis 16-way configuration uses two redundant RXE cables. This is described in detail in 3.2.3, “Remote Expansion Enclosure” on page 78.

## 1.9 Redundancy

The x440 has the following redundancy features to maintain high availability:

- ▶ Four hot-swap multi-speed fans

With four hot-swap redundant fans, the x440 has adequate cooling for each of its major component areas. There are two fans located at the front of the server that direct air through the SMP Expansion Modules. These fans are accessible from the top of the server without having to open the system panels. In the event of a fan failure, the other fan will speed up to continue to provide adequate cooling until the fan can be hot-swapped by the IT administrator.

The other two fans are located just behind the power supplies and provide cooling for the I/O devices. Similar to the SMP Expansion Module fans, these fans will speed up in the event that one should fail to compensate for the reduction in air flow. In general, failed fans should be replaced within 24 hours following failure.

**Important:** Due to airflow requirements, fans should not be removed for longer than two minutes. The fan compartments need to be fully populated even if the fan is defective. Therefore, remove a defective fan only when a new fan is available for immediate replacement.

- ▶ Two hot-swap power supplies with separate power cords.

**Note:** For large configurations, redundancy is achieved only when connected to a 220 V power supply. See 3.8, “Power considerations” on page 103 for details.

- ▶ Two hot-swap hard disk drive bays. An optional ServeRAID adapter can be configured to form a RAID-1 disk array for the operating system.
- ▶ The memory subsystem has a number of redundancy features, including memory mirroring, as described in 1.7, “System memory” on page 19.

The layout of the front panel of the x440, showing the location of the drive bays, power supplies and fans, is shown in Figure 1-13.

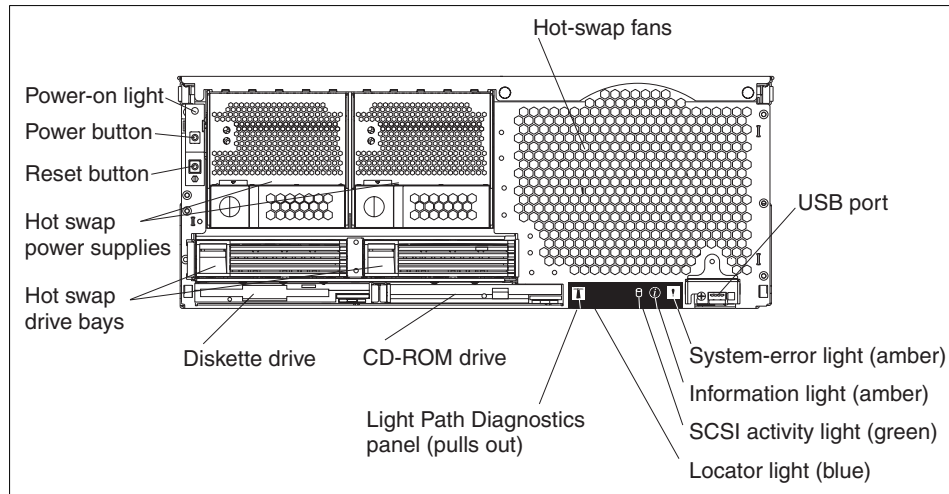

Figure 1-13 Front panel of the xSeries 440

## 1.10 Light Path Diagnostics

To limit the need to slide the server out of the rack to diagnose problems, a new Light Path Diagnostics panel has been added to the front of the x440. This panel can be ejected from the server to view all Light Path Diagnostics-monitored server subsystems. In the event that maintenance is then required, the customer can slide the server out from the rack and using the LEDs, find the failed or failing component.

As illustrated in Figure 1-14 on page 26, Light Path Diagnostics is able to monitor and report on the health of CPUs, main memory, hard disk drives, PCI-X and PCI slots, fans, power supplies, VRMs, and the internal system temperature.

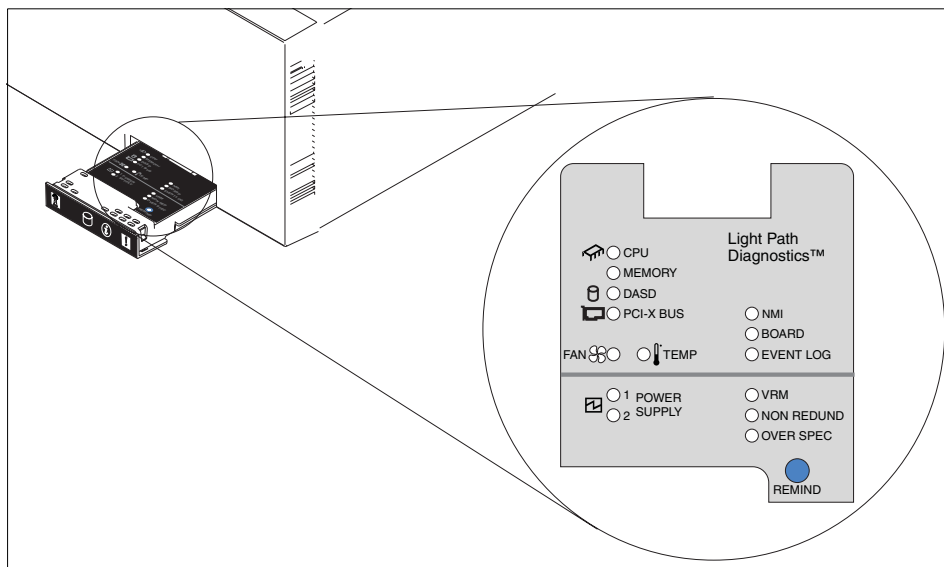

Figure 1-14 Light Path Diagnostics panel on the x440

The Light Path Diagnostics on the x440 has three levels:

1. Level 1 is the pop-out panel as shown in Figure 1-14.
2. For further investigation, there are Light Path Diagnostics LEDs visible through the top of the server. This requires the server to be slid out of the rack.
3. For the third level of diagnostics, LEDs on the planar indicates the component causing the error.

The pop-out panel (Figure 1-14) also has a Remind button. This places the front panel system-error LED into remind mode, which means it flashes briefly every 2 seconds. By pressing the button, you acknowledge the failure but indicate that you will not take immediate action. If a new failure occurs, the system-error LED will turn on again. The system-error LED remains in the Remind mode until one of the following situations occurs:

- ▶ All known problems are resolved
- ▶ The system is restarted
- ▶ A new problem occurs, at which time it then is illuminated continuously



## 1.11 Remote Supervisor Adapter

The x440 includes a Remote Supervisor Adapter (RSA), which is positioned horizontally in a dedicated PCI slot beneath the PCI-X adapter area of the system.

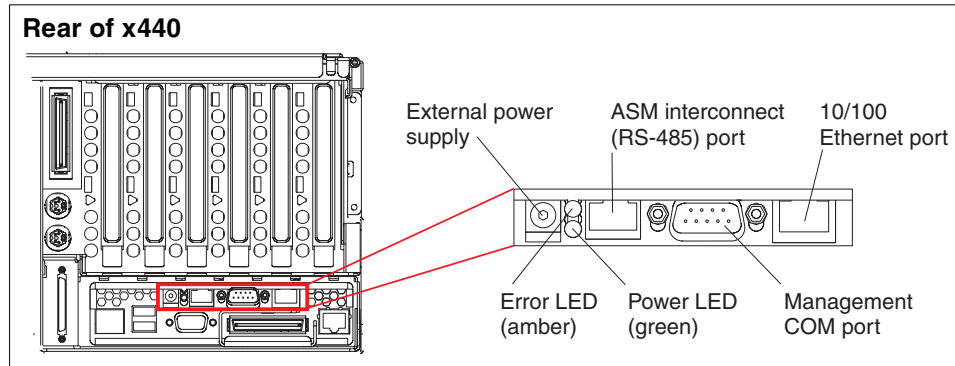

Figure 1-15 Remote Supervisor Adapter connectors

The Remote Supervisor Adapter offers the following capabilities:

- ▶ In-band and out-of-band remote server access and alerting through IBM Director
- ▶ Full Web browser support with no other software required
- ▶ Enhanced security features
- ▶ Graphics/text console redirection for remote control
- ▶ Windows NT and 2000 blue screen capture
- ▶ Dedicated 10/100 Ethernet access port
- ▶ ASM interconnect bus for connection to other service processors
- ▶ Serial dial in/out
- ▶ E-mail, pager and SNMP alerting
- ▶ Event log
- ▶ Predictive Failure Analysis on memory, power, hard drives, and CPUs
- ▶ Temperature and voltage monitoring with settable threshold
- ▶ Light Path Diagnostics
- ▶ Automatic Server Restart (ASR) for operating system and POST
- ▶ Wake on LAN
- ▶ Remote firmware update
- ▶ LAN access
- ▶ Alert forwarding

See the IBM Redbook *Implementing IBM Director Management Solutions*, SG24-6188 for more information on the Remote Supervisor Adapter.

In addition to these functions, the Remote Supervisor Adapter is an integral component of the two-node x440 configurations. With the two-node 16-way configuration, the adapters are used in the following way:

- ▶ The adapters in both systems are each assigned an IP address (on the same subnetwork)
- ▶ The adapters are connected via their Ethernet ports, either with a cross-over cable, or on a hub or switch, as shown in Figure 3-6 on page 76.
- ▶ One adapter is configured as the primary, and the other is configured as the secondary.
- ▶ Pressing the power button on either x440 will cause the adapters to power up both nodes.

## 1.12 Operating system support

In line with the overall message of providing application flexibility to meet the varying needs of our enterprise customers, the x440 is optimized for numerous operating system and application solutions. Table 1-3 on page 29 lists the supported operating systems for the x440. For the latest operating system support information, go to:

<http://www.pc.ibm.com/us/compat/nos/matrix.shtml>

See 3.5, “Operating system considerations” on page 90 for further information on operating system support on the x440.

**Note:** Windows 2000 Datacenter Server and VMware ESX Server are the only operating systems currently supported on the 16-way x440 fixed configuration.

In the column titled Hyper-Threading Support in Table 1-3 on page 29:

- ▶ **None** indicates the operating system does not recognize the logical processors that Hyper-Threading enables.
- ▶ **Yes** indicates that the operating system recognizes the logical processors and can execute threads on them but is not optimized for Hyper-Threading.
- ▶ **Optimized** indicates that the operating system recognizes the logical processors and the operating system code has been designed to fully take advantage of the technology.

Table 1-3 x440 operating system support

Description	Release	SMP support <sup>1</sup>	Hyper-Threading support
Windows 2000 Server	SP2/3	Supports up to four-way	Yes
Windows 2000 Advanced Server	SP2/3	Supports up to eight-way	Yes
Windows 2000 Datacenter Server	SP3	Supports up to 32-way <sup>2</sup>	Yes
Windows NT Enterprise Edition	4.0	Only supports four-way on the x440 Hot-plug PCI not supported	None
Windows .NET Server	1Q/03	Supports up to two-way	Optimized
Windows .NET Enterprise Server	1Q/03	Supports up to eight-way	Optimized
Windows .NET Datacenter Server	1Q/03	Supports up to 32-way <sup>2</sup>	Optimized
NetWare	6.0	Supports up to 32-way <sup>2, 3</sup>	Yes
Red Hat Linux Advanced Server	2.1	Supports up to eight-way <sup>4</sup>	Yes
SuSE Linux Enterprise	8.0	Supports up to eight-way <sup>4</sup>	Yes
VMware ESX Server	1.5	Supports up to 16-way Supports up to one processor per VM <sup>5</sup>	None

**Notes to Table 1-3:**

1. While operating systems may support eight-way or larger systems, scalability is a function of both the operating system and the application/workload. Few applications are designed to take advantage of larger SMP systems.
2. x440 configurations with 16 processors and Hyper-Threading enabled are seen as 32 processors under Windows 2000 Datacenter and Windows .NET. Licensing of processors in Windows 2000 is based on physical and logical processors combined, whereas Windows .NET licensing is based on physical processors.
3. NetWare notes:
  - NetWare 5.1 is currently not supported, but it should still install. See RETAIN tip H176163 for details on a known shutdown problem:  
<http://www.pc.ibm.com/qtechinfo/MIGR-43679.html>

- With NetWare 6.0, the server may show extreme CPU utilization values (for example, 13000%). This will be fixed with NetWare 6.0 Support Pack 2. See RETAIN tip H176060 at:  
<http://www.pc.ibm.com/qttechinfo/MIGR-43532.html>
  - Once supported, a multi-chassis configuration must be fully assembled before installing NetWare. Novell doesn't currently support adding chassis after NetWare is installed.
4. Ongoing work will improve both Linux and key application scalability. Currently, the general recommendation is to keep system size limited to eight-way and below, and 16 GB and below. Work on scalability beyond eight-way is in progress, and is likely to become available in early to mid-2003.
  5. VMware ESX Server 1.5 allows eight virtual machines per processor. However, a virtual machine (VM) can consist of no more than one processor. 16-way support will require Version 1.5.1.

## 1.13 IBM Director

IBM Director is designed to manage all platforms in the Intel environment and support a variety of operating systems.

IBM Director 3.1 supports IBM Enterprise X-Architecture capabilities, including Remote I/O via the IBM RXE-100 Remote Expansion Enclosure and the new Real Time Diagnostics feature of the x440. CIM-related enhancements include:

- ▶ CIM instrumentation for Linux
- ▶ Mass configuration of client CIM properties — Saves time by setting up and configuring multiple systems as a group, rather than having to configure each system individually
- ▶ Hardware instrumentation using CIM — Enables RAID and systems management hardware information and alerts to be passed up to higher-level management packages as part of the IBM Director upward integration modules (UIMs)

IBM Director 4.1 will support VMware ESX Server both at the VMware console level and at the guest operating system level.

IBM Director includes server extensions that help administrators configure, deploy, manage, and maintain your servers easily and effectively. IBM Director Extensions include the following:

- ▶ **System Partition Manager** — System Partition Manager provides a graphical interface for creating static hardware partitions. It allows an

administrator to configure a specific server (while it is offline) from a remote system, prior to starting the operating system.

See 5.2, “System Partition Manager” on page 150 for more information.

- ▶ **Active PCI Manager** — Active PCI Manager helps optimize I/O performance by matching the PCI-X bus and card characteristics and offering guidance on the best slots in which to install PCI and PCI-X adapters.

See 5.1, “Active PCI Manager” on page 130 for details.

- ▶ **Capacity Manager** — Capacity Manager monitors critical server resources such as processor utilization, disk capacity, memory usage and network traffic. Using advanced artificial intelligence, it identifies bottlenecks for an individual system, a group of systems, or a cluster, and recommends upgrades to prevent diminished performance or downtime. Capacity Manager can even identify latent bottlenecks and make recommendations for preventive action. For example, Capacity Manager can predict hard disk drive and memory shortages that might cause problems.

Because Capacity Manager features can help predict problems before they occur, the administrator can perform proactive planning and schedule service and upgrades before potential problems degrade performance.

Capacity Manager will be updated to support partitioning in the next release of IBM Director, planned for the second half of 2002.

- ▶ **Cluster Manager** — Cluster Manager allows an administrator to easily identify, configure, and manage clustered servers using one graphical tool. Administrators can be alerted via pager or e-mail about cluster events in hardware, the operating system, and Microsoft Cluster Service (MSCS). Alternatively, Cluster Manager can trigger recovery programs or others automatically.
- ▶ **Management Processor Assistant** — The Management Processor Assistant (MPA) task, previously named the Advanced System Management task, lets the administrator monitor critical subsystems as well as restart and troubleshoot servers, even if a server has suffered a fatal error or is powered off. This utility works in concert with the IBM family of systems management processors and adapters described previously. IBM Director 3.1 added management support for the RXE-100 Remote I/O unit.
- ▶ **Rack Manager** — Rack Manager offers a drag-and-drop interface for easily configuring and monitoring rack components using a realistic visual representation of the rack and its components. It also provides detailed health status information for the rack and its elements. IBM Director 3.1 added the ability to drag-and-drop objects between racks.
- ▶ **RAID Manager** — RAID Manager lets an administrator configure, monitor, and manage ServeRAID subsystems without taking the server offline. IBM Director 3.1 includes field replaceable unit (FRU) number reporting in alerts

for RAID components and hard disk drives. This reduces labor and service costs by providing replacement part information in the alert message so that the correct part can be obtained for the service call.

- ▶ **Software Rejuvenation** — In networked servers, software often exhibits an increasing failure rate over time, due to programming errors, data corruption, numerical error accumulation, etc. These errors can spawn threads or processes that are never terminated, or they can result in memory leaks or file systems that fill up over time. These effects constitute a phenomenon known as “software aging”, which can lead to unplanned server outages. Advanced IBM analytical techniques allow IBM Director Software Rejuvenation to monitor trends and predict system outages based on the experience of system outages on a given server. Alerts of this sort act as Predictive Failure Analysis for software, giving an administrator the opportunity to schedule servicing (rejuvenation) at a convenient time in advance of an actual failure and avoid costly downtime.

Software Rejuvenation can be scheduled to reset all or part of the software system with no need for operator intervention. When Software Rejuvenation reinitializes a server, the server’s software failure rate returns to its initial lower level because resources have been freed up and the cumulative effects of numerical errors have been removed.

When Software Rejuvenation is invoked within a clustered environment, cluster management failover services (such as Microsoft Cluster Services and Microsoft Datacenter Server) may be used to stop the offending subsystem and restart it on the same or another node in the cluster in a controlled manner. In a clustered environment, xSeries servers can be set to fail over to another server, then be reset by IBM Director without downtime.

IBM Director 3.1 includes a Trend Viewer feature to graphically monitor the software aging process and an “application culprit” list that identifies the applications most likely to be causing the aging.

- ▶ **System Availability** — System Availability accurately measures uptime/downtime for individual servers or groups of servers, and provides a variety of graphical views of this information. This enables users to track the improvements in their server availability in order to verify the benefits of the systems management processes and tools. IBM Director 3.1 includes the ability to distinguish between planned versus unplanned outages.
- ▶ **Electronic Service Agent** — Electronic Service Agent enables the Director server to contact IBM automatically in the event of a fault condition. Data gathered by IBM Director that is relevant to the fault is included in the message, in most cases allowing IBM service to respond to the condition without the need for additional details. Once IBM has been notified of the event, the course of action is the same as if a service call was placed manually. Electronic Service Agent support requires registering the systems

with IBM, including providing a contact name and phone number, and is available for systems covered under warranty or maintenance agreements. Electronic Service Agent currently requires the use of an analog phone line and modem. Access via VPN may be possible in future releases.

See the IBM Redbook *Implementing IBM Director Management Solutions*, SG24-6188 for details on IBM Director and its plug-ins.







# Positioning

In this chapter we discuss topics that help you understand how the x440 can be useful to your business and what is the best configuration to use. The topics covered are:

- ▶ xSeries 440 application solutions
- ▶ Why choose the x440
- ▶ The benefits of system partitioning
- ▶ Server consolidation

## 2.1 xSeries 440 application solutions

The x440 is an ideal platform for customers running mission-critical applications. There are a number of ways the x440 can be deployed in specific application solution environments. These include:

- ▶ Server consolidation
- ▶ Enterprise applications
- ▶ Infrastructure applications
- ▶ Clustering

### 2.1.1 Server consolidation

Server consolidation is a process of centralizing business computing workloads to reduce cost, complexity, network traffic, management overhead and, in general, to simplify the existing IT infrastructure and provide a foundation for new solution investment and implementation.

Server consolidation is discussed in detail in 2.4, “Server consolidation” on page 51.

Server consolidation solutions can be divided into two groups: those where no more than four-way SMP is needed, and those that will take advantage of more CPUs.

- ▶ Four-way configurations

The four-way configurations would most likely be good candidates for traditional messaging/collaboration environments such as Microsoft Exchange and Lotus Domino. These applications do not scale well beyond a four-way SMP configuration. It is an optimal platform for customers who intend to migrate from Exchange 5.5 to Exchange 2000 using new features of Exchange 2000 such as the support for more databases. Many customers have distributed Exchange and Lotus Domino sites, which is costly and difficult to manage. Here, the x440 can be a very attractive platform to consolidate distributed sites into a central site.

Many ISPs are running different Internet applications and mail systems on several servers. In most cases, they run applications on several servers to get better I/O. The four-way x440 server connected to an RXE-100 fulfills this requirement and ISPs can continue servicing the customers by consolidating to an x440 server.

Although many applications such as file, print, and terminal servers do not scale well beyond two processors, the four-way x440 can be a good platform on which to consolidate those distributed applications. For example, using

VMware many file and print servers that are distributed around the enterprise can be consolidated to a four-way x440 server, reducing the TCO.

Using logical partitioning with four-way configurations can produce a one-box cluster solution for small-to-medium-sized businesses (SMB) that need to protect their mission-critical applications and files. With this solution, SMB customers can reduce their total cost of ownership and save money.

In addition, a four-way x440 can be a good platform for light ERP solutions such as Navision.

► Eight-way and 16-way configurations:

The eight-way and 16-way x440 is ideal for customers who want to consolidate their enterprise applications (ERP, CRM, and SCM) or roll out new enterprise applications. These configurations offer computing power, high availability, and reliability, which are the main requirements when running enterprise applications. The goal is to help customers to control their expenses while establishing an environment that is easier to manage because of fewer nodes.

The eight-way and 16-way configurations are solid platforms to be used for consolidating database applications such as DB2, SQL Server, and Oracle. For instance, a single database that spans multiple servers can be consolidated to an eight-way x440 server or multiple databases on multiple server can be consolidated to a 16-way x440 complex.

Many customers have multiple databases distributed on multiple sites and they are planning to migrate to new database versions. This could be a very costly and time-intensive process. The migration process needs to be well planned and tested without any interruption of the business process. The eight-way or 16-way can be an optimal platform for these customers. For example, you can consolidate the distributed databases on multiple sites to a 16-way x440. Using logical partitioning on x440, you can build, test and deploy many virtual databases on one physical server.

The main reasons to consolidate database applications are:

- Migration from older database versions to new versions getting the advantages relating to availability, reliability and performance.
- Support for more databases. For instance, SQL Server 2000 can support up to 32,767 open databases.
- Reducing the management costs of distributed database sites by consolidating to an easy-to-manage central site.

In addition, using logical partitioning with eight-way and 16-way configurations can produce a powerful server solution that is capable of hosting multiple applications.

## 2.1.2 Enterprise applications

Because enterprise applications such as ERP, SCM, CRM and BI work with the most critical data of a business, x440 with its high-availability features is an ideal server for these applications.

### ► Enterprise Resource Planning

Enterprise Resource Planning (ERP) is an industry term for the broad set of activities supported by multi-module application software that helps a manufacturer or other business manage the important parts of its business, including product planning, parts purchasing, maintaining inventories, interacting with suppliers, providing customer service, and tracking orders. ERP can also include application modules for the finance and human resources aspects of a business. Typically, an ERP system uses or is integrated with a relational database system.

The key operation areas of the x440 for ERP applications are:

- As an application server and as a database server with two-way servers such as the x330 acting as Web servers.
- As an application server front-end to a pSeries or zSeries database server, due to the fact that ERP applications involve integration across heterogeneous environments.
- Using partitionable x440 servers to deploy ERP applications within a single large-scale server, which could be an attractive solution for SMB customers offering them new levels of manageability as it relates to their ERP implementation.

Key server attributes for ERP applications are availability, scalability, and performance. The x440, with its Enterprise X-Architecture technology such as XpandOnDemand capability, Active Memory, and XceL4 server accelerator cache, is a robust basis to build and implement successful ERP solutions.

Key ERP software vendors include SAP, Oracle, PeopleSoft, Microsoft, JD Edwards, Baan/Invensys, and Navision.

### ► Supply chain management

Supply chain management (SCM) is the oversight of materials, information, and finances as they move in a process from supplier to manufacturer to wholesaler to retailer to consumer. Supply chain management involves coordinating and integrating these flows both within and among companies.

The x440 is a preferred platform for SCM management applications. The x440 offers a range of leading technologies that will help to deliver the uptime required for business-critical applications at the lowest price/performance ratio. The x440 covers all high-availability features for customers looking for servers to power their SCM solutions. Also, the x440 can be considered as an

application server or in a heterogeneous environment as a front-end to a pSeries or zSeries database server.

Key SCM software vendors include i2 Technologies, SAP, International Business Systems (IBS), JD Edwards, and PeopleSoft.

▶ Customer relationship management

Customer relationship management (CRM) is an information-industry term for methodologies, software, and usually Internet capabilities that help an enterprise manage customer relationships in an organized way.

With the Intel Xeon Processor MP and the IBM XceL4 cache, the x440 provides a performance-based foundation upon which customers can build and deploy CRM solutions. The x440 will most likely be implemented as an application server and/or a database server. In addition, the x440's partitioning capabilities will help to build a partitioned CRM environment, allowing customers to maximize server utilization while simplifying overall management of the deployment.

Key CRM software vendors include: Siebel Systems, Baan/Invensys, Onyx, PeopleSoft, and SAP.

▶ Business Intelligence

Business intelligence (BI) is a broad category of applications and technologies for gathering, storing, analyzing, and providing access to data to help enterprise users make better business decisions. BI applications include the activities of decision-support systems, query and reporting, online analytical processing (OLAP), statistical analysis, forecasting, and data mining.

The recent move of BI solutions into smaller enterprises has led to the strong positioning of Windows on Intel processor-based servers within this market. The x440 brings scalability and performance to handle compute-intensive BI applications. The highlights of the x440 are its XceL4 cache, which will help speed up data-intensive BI applications that help companies to increase the productivity of their employees.

Key BI software vendors include SAS, Cognos, Business Objects, Hyperion, and Crystal Decisions.

## 2.1.3 Infrastructure applications

Some of the infrastructure applications are database, messaging/collaboration, and e-business applications. The x440 can be recommended for these three areas as follows:

▶ Database applications:

Four-way and eight-way configurations can be used as database servers, and application servers or combination database and application servers providing an extremely scalable platform with room to scale to additional nodes. These configurations require an external storage enclosure or SAN, depending on the size of the database, which is driven by the number of users.

The 16-way configuration can deliver a highly reliable and capable platform for customers who need to run multiple instances of databases that can scale beyond eight processors.

Key database software vendors include IBM (DB2), Microsoft (SQL Server), and Oracle.

▶ Messaging/collaboration:

The four-way x440 with its high-availability features is a good platform for messaging/collaboration applications. Even though there are some scalability limits for Microsoft Exchange 2000 (which does not scale well above four processors), the x440 can be seen as an ideal server for Exchange 2000 deployments.

Another possible operation area for the x440 in the messaging/collaboration arena is the utilization of partitioning, allowing customers to maximize server resources while improving overall manageability.

Key messaging/collaboration software vendors include Lotus (Domino) and Microsoft (Exchange).

▶ e-business:

e-business is the use of Internet technologies to improve and transform key business processes.

This includes Web-enabling core processes to strengthen customer service operations, streamlining supply chains and reaching existing and new customers. In order to achieve these goals, e-business requires a highly scalable, reliable, and secure server platform.

The x440 is a strong candidate for an application integration server that integrates the back-end data with the servers containing end-user or client programs. This involves data transformation, process flow, and other capabilities, thus allowing companies to integrate applications and other data

sources. These types of servers benefit from the processing power offered by the x440.

Key e-business software vendors include IBM (WebSphere) and BEA.

## 2.1.4 Clustering

A cluster is a group of independent computers, also known as nodes, that are linked together to provide highly available resources (such as file shares) for a network. Each node that is a member of the cluster has both its own individual disk storage and access to a common disk subsystem.

When one node in the cluster fails, the remaining node or nodes assume responsibility for the resources that the failed node was running. This allows the users to continue to access those resources while the failed node is out of operation.

In addition, x440 in conjunction with VMware offers clustering, which can be seen as another key solution for server consolidation. For example, a two-node IIS cluster and a two-node file server cluster can be consolidated into a single x440 server. This helps customers to save costs, facilitate cluster management, and improve cluster performance through high-speed SMP Expansion Ports.

The x440 with its high-availability features is an optimal platform to protect mission-critical applications. The x440 offers two types of clustering for server consolidation purposes:

- ▶ One-box cluster

This provides simple clustering to deal with software crashes or administrative errors. The cluster consists of multiple virtual machines (VMs) on a single physical machine. It supports shared disks without any shared SCSI hardware. It supports the heartbeat network without any extra network adapters.

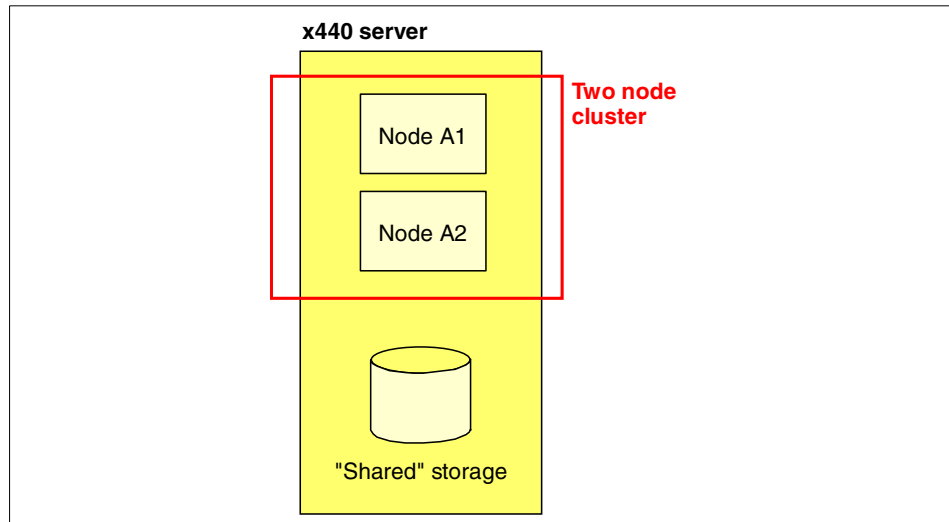

Figure 2-1 One-box cluster running VMware with virtual shared storage

Using VMware, this allows you to set up a one-box cluster, which provides the following benefits:

- Much lower cost than for duplicate systems required for traditional-based clustering
- Protects against all OS and application faults
- Reduces management tasks
- ▶ Cluster across multiple systems

This type of cluster also uses virtual machines. The virtual disks are stored on real shared disks, so all virtual machines can access them. Using this type of cluster, you can protect your mission-critical applications in a cost-effective way. For example, you can set up a cluster to protect your Web server applications and you can configure a second cluster to protect your file server.

You can consolidate four clusters of two machines each to two physical machines with four virtual machines each. This provides protection from both hardware and software failures.



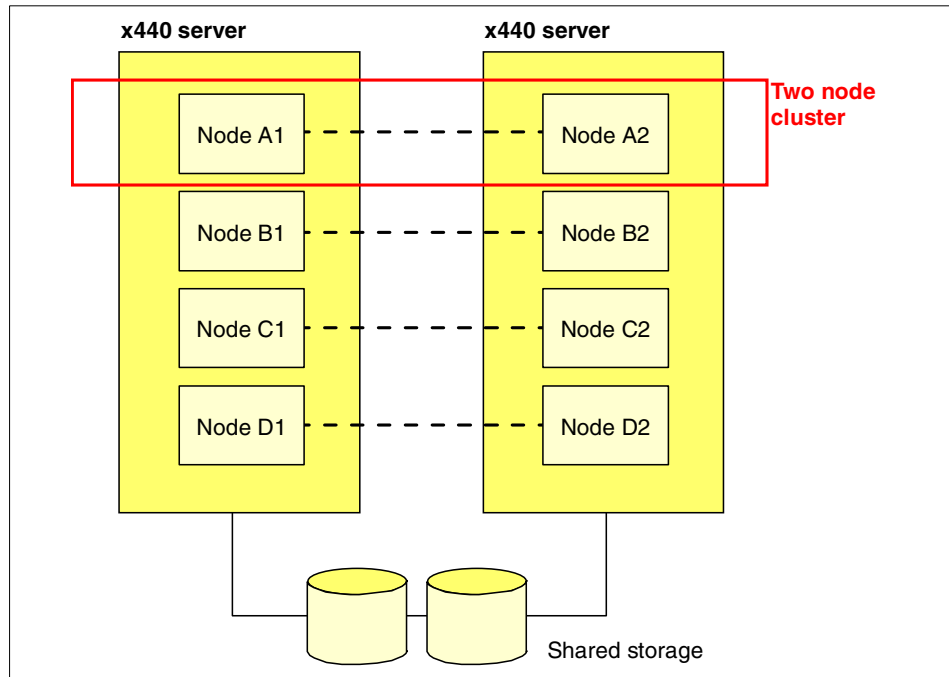

Figure 2-2 Four clusters on two x440s running VMware with shared storage

Dual-chassis eight-way configuration can be used as clustered database servers and/or application servers in an ERP/CRM/SCM environment, delivering high performance, high availability, and reliability, which are key requirements of enterprise applications. This configuration requires an external storage enclosure or SAN, depending on the size of the database, which is driven by the number of users.

## 2.2 Why choose the x440

There are some good reasons to choose the x440 as your mission-critical Intel platform. In this section we describe the major benefits of x440.

### 2.2.1 IBM XA-32 chipset

The IBM XA-32 chipset contains advanced core logic, which determines how the various parts of a system (microprocessors, system cache, main memory, I/O, etc.) interact.

This chipset is built on IBM's advanced copper 0.13-micron technology, which creates faster, lower power-consuming and heat-producing chips. So servers built with the chipsets will run faster, have lower power costs, and require less cooling, which increases reliability and reduces TCO.

The XA-32 has the following features:

- ▶ Support for up to 16-way SMP with Xeon MP processors and up to four-way SMP with Xeon DP processors.
- ▶ Support for scalability ports that lets you expand the x440 server from two-way, to four-way, to eight-way and by connecting two x440s together, to 16-way.
- ▶ 32-64 MB of a Level 4 cache (levels 1-3 are internal to the Xeon MP processors), using IBM XceL4 Server Accelerator Cache, to maximize performance, especially for eight-way and 16-way configurations.
- ▶ Two Remote I/O buses per node to connect an RXE-100 external PCI-X enclosure.
- ▶ Memory mirroring and up to 6.4 GBps memory bandwidth.
- ▶ Up to 16 GB of main memory per SMP Expansion Module using 1 GB DIMMs (and 32 GB of RAM with 2 GB DIMMs once they are available).
- ▶ Six PCI-X buses, two for integrated devices, four to internal PCI-X slots.

## 2.2.2 Intel Xeon MP and DP processors

Many of the x440 models use the Xeon Processor MP, Intel's latest microprocessor for high-end server. It has the following key features:

- ▶ 400 MHz front-side bus providing an effective burst throughput of 3.2GBps, compared to 800 MBps available to a 100 MHz bus. This provides high performance, especially with TCP/IP.
- ▶ Hyper-Threading creates two logical processors that share resources in one physical processor. A processor with Hyper-Threading can execute multiple threads, delivering a performance improvement in servers running software that has been optimized to use Hyper-Threading:
  - On a four-way x440, the benefit can be as much as 20%
  - On an eight-way, the benefit can be as much as 10%

Figure 2-3 on page 45 shows that two physical processors will outperform one processor with Hyper-Threading enabled.

Customers should expect improved results as applications are Hyper-Threading aware. Best-case applications today are databases, Java applications, Web servers, and e-mail.

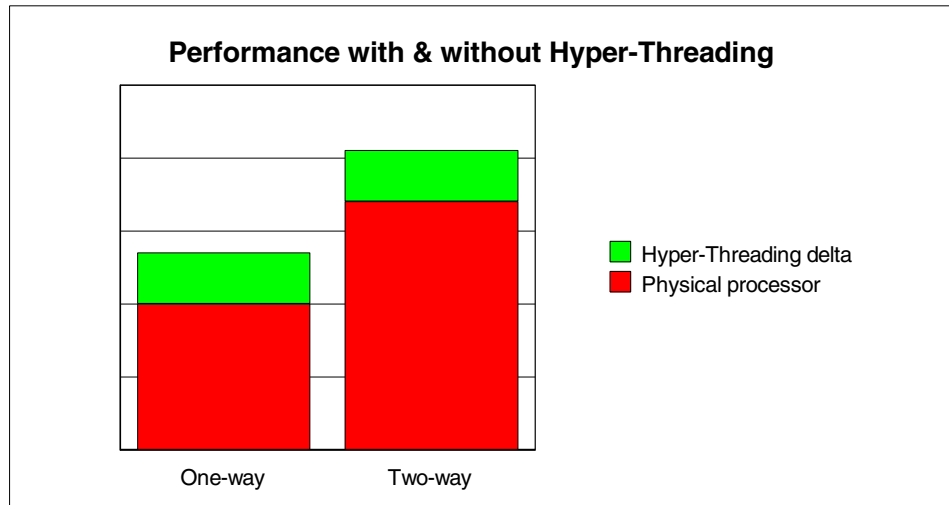

Figure 2-3 Comparing processor performance

- ▶ The three-level cache architecture of the Xeon MP processor delivers the following benefits compared to Xeon PIII processor:
  - Higher throughput: Peak bandwidth of 51.2 GBps compared to 28.8 GBps for Xeon PIII processor.
  - Improved average cache hit rates due to larger cache line sizes. Line size of 128-bytes compared to 32-bytes for the Xeon PIII processor.
- ▶ Advanced Dynamic Execution

The Pentium III Xeon processor has a 10-stage pipeline. However, the large number of transistors in each pipeline stage means that the processor is limited to speeds under 1 GHz due to latency in the pipeline.

The Xeon Processor MP has a 20-stage pipeline, which can hold up to 126 concurrent instructions in flight and up to 48 reads and 24 writes active in the pipeline. Faster raw execution results in higher transaction rates and faster response times for Web and database servers.

Intel reports that the Xeon MP processor supports 36% more users and can process 40% more orders in an e-business environment than supported and processed in the Pentium III Xeon processor.

The Xeon DP is similar to the Xeon MP and is also based on the Intel NetBurst micro-architecture. The Xeon DP was designed by Intel to only support two-way SMP. However, with the use of the IBM XA-32 chipset, the x440 can have up to four Xeon DP processors installed.

x440s with Xeon DP processors are a good platform for customers who are looking for better price/performance platforms but still maintain high levels of scalability that the x440 provides.

Lab tests using standard transaction processing benchmark conditions have shown that the comparative performance of the Xeon DP and Xeon MP x440s is approximately the following:

- ▶ Two-way 1.6 GHz Xeon MP (1 MB L3 cache) = 1.0
- ▶ Two-way 2.4 GHz Xeon DP (0 MB L3 cache) = 1.10
- ▶ Four-way 1.6 GHz Xeon MP (1 MB L3 cache) = 1.70
- ▶ Four-way 2.4 GHz Xeon DP (0 MB L3 cache) = 1.65

### 2.2.3 XceL4 Server Accelerator Cache

The XceL4 Server Accelerator Cache (L4 cache) is 32 MB of PC200-compliant DDR-SDRAM using a 64-bit 400 MHz bus with 3.2 Gbps throughput.

32MB of L4 high-performance high-speed ECC cache memory per four-way SMP Expansion Module speeds up your most complex applications by reducing memory latency and increasing memory bandwidth. The more high-speed cache memory there is, the more often the processor finds the data it needs and the less often it has to access main memory.

XceL4 server Accelerator cache provides the following benefits:

- ▶ XceL4 server Accelerator Cache delivers up to 20% more performance for transaction-intensive workloads.
- ▶ Minimizes processor and I/O memory contention delivering full PCI-X bandwidth to network and storage devices.
- ▶ Advanced Level 4 caching is designed to provide zero wait-state memory access, up to 3X performance increase over typical main memory fetches.

### 2.2.4 High-performance memory subsystem

The x440 memory subsystem provides multiple levels of redundancy, combining memory mirroring, Chipkill, Memory ProteXion, and memory scrubbing. Combining Chipkill with Memory ProteXion means that up to two failed memory chips (“chipkills”) per memory port on an x440 can be tolerated. A 16-way x440 with its eight memory ports could sustain up to 16 failed chips.

The first chipkill on each port would not even generate a Light Path error, because Memory ProteXion would provide the first layer of protection. Each memory port could then sustain a second chipkill without shutting down. Provided that Active Memory with memory mirroring is enabled, the third chipkill

on that port would send the alert and take down the DIMM, but keep the system running out of the redundant memory bank.

To maintain throughput to the processors, the x440 memory subsystem improves performance by the use of four-way interleaving. Interleaving improves memory performance because multiple 64-bit objects can be transferred into the memory controller in a single operation. This improves the memory performance by reducing the latency time.

For more information regarding an x440 memory subsystem, refer to 1.7, “System memory” on page 19.

## **2.2.5 Active PCI-X**

PCI-X is a new PCI bus specification and is now available on the xSeries 440. It was developed to satisfy the increased requirements of I/O adapters such as Gigabit Ethernet, Fibre Channel and Ultra 3 SCSI. PCI-X is fully compatible with standard PCI devices.

PCI-X provides a new generation of capabilities for the PCI bus, including more efficient data transfers, more adapters per bus segment, and faster bus speeds for server systems. PCI-X enhances the PCI standard by doubling the throughput capability and providing new adapter-performance options while maintaining compatibility with PCI adapters.

PCI-X allows all current 66 MHz PCI adapters, either 32-bit or 64-bit, to operate normally on the PCI-X bus. PCI-X adapters take advantage of the new 100 MHz and 133 MHz bus speeds, which allow a single 64-bit adapter to move as much as 1 GB of data per second.

Additionally, PCI-X supports twice as many 66 MHz/64-bit adapters in a single bus as PCI. Active PCI-X also increases total server availability by letting you add or replace Active PCI and Active PCI-X cards without having to shut down your xSeries servers.

## **2.2.6 XpandOnDemand scalability**

XpandOnDemand scalability represents an industry-standard implementation of true “pay as you grow” scalability. New levels of scalability are achieved with the Enterprise X-Architecture platform using enhanced, high-performance SMP building blocks that allow effective scalability beyond four-way SMP.

The modular scalability feature of XpandOnDemand offers the following benefits:

- ▶ Performance scalability through the SMP Expansion Module  
SMP Expansion Modules can be easily added at any time to increase the operational capacity of a node. By adding a second SMP Expansion Module, a system can take advantage of more processors, memory and Level 4 cache to increase overall system performance for managing more database users on a network or processing more transactions faster.
- ▶ Performance scalability through multi-node SMP  
Enterprise X-Architecture technology powers this industry-standard server building block. By linking two x440 nodes together, a customer can assemble a modular SMP system with increased performance.
- ▶ I/O scalability through the RXE-100 Remote Expansion Enclosure  
Adding additional PCI-X slots is achieved by connecting an RXE-100 Remote Expansion Enclosure to the server.

## 2.2.7 System Partition Manager

System Partition Manager is designed for easily managing multi-node configurations, allowing the customer to build complexes of four-way and eight-way nodes up to 16-way SMP, define and activate/deactivate partitions, and enable automatic re-partitioning of hardware under the control of Director Event Action plans.

The other feature of System Partition Manager is chassis failure recovery. If the operating system crashes in a multi-node partition due to a failure of one of the chassis, System Partition Manager can generate an alert event to IBM Director, notifying the administrator to manually reconfigure the partition or initiating additional events to automatically reconfigure the multi-node partition and thus restart the chassis in that partition.

For this to occur, the system administrator would have created IBM Director action plans to define what action SPM must take when a chassis fails. Customers must consider such things as boot device attachment, data storage attachment, and other topology issues when configuring the complex and creating the action plans.

System Partition Manager uses the network link to the onboard systems management processor or adapter to establish the relationships among nodes. These relationships are maintained in a persistent database and can be recalled and activated at any time using the graphical interface.

## 2.3 The benefits of system partitioning

System partitioning is virtualization of system resources, including processor, memory, I/O, and storage so that all concurrent users appear to have access to the system, although each user is actually segmented and protected from the actions of other users. If one virtual partition freezes up, it would not affect the others.

System partitioning offers the ability to divide a system so that it can simultaneously support multiple operating system images. Among the benefits of system partitioning are:

- ▶ Server hardware consolidation
- ▶ High availability
- ▶ Software migration and coexistence
- ▶ Version control
- ▶ Development
- ▶ Testing and maintenance
- ▶ Better protection from viruses and software crashes
- ▶ Workload isolation
- ▶ Independent backup and recovery on a partition basis

System resources, including processor, memory, I/O and storage are virtualized so that all concurrent programs appear to have complete access to the system. If one virtual partition were to lock up, it would not affect the others.

Here are just a few of the ways that system partitioning can help you to improve IT efficiency:

- ▶ Server hardware consolidation — Consolidate many underused, underpowered, and unnecessary servers into a few productive ones. Reduce the number of current servers and buy fewer servers in the future.
- ▶ Increased server utilization — Divide a processor into multiple partitions rather than wasting an entire processor on one low-throughput application.
- ▶ Simplified server management — Manage fewer servers centrally versus many of them individually in multiple locations. Have fewer servers, cables, operating systems, and applications to deal with.
- ▶ Low-cost clustering/failover — Create clusters of partitions among hardware nodes. Have several different servers fail over to multiple partitions in one server.
- ▶ Simplified application deployment — Once you have tested and qualified a specific hardware platform for use with a particular operating system and application combination, you can deploy software images on multiple partitions, rather than having to requalify the software on another hardware platform.

Two types of system partitioning are:

▶ Physical partitioning

With physical partitioning, a single server consisting of two nodes, such as the x440, can run multiple instances of an operating system in separate partitions. It can also run multiple versions of an operating system or even different types of operating systems.

This means that a server can continue to run an operating system in one node while you install and test another version of that operating system, or a different operating system entirely in another node on that server without having to take the entire server offline.

Physical partitioning includes two different types:

- Static partitioning, which can be implemented using IBM System Partition Manager, requires the nodes being adjusted to be taken offline. The remaining nodes in the server are unaffected and continue to operate normally. Static partitioning is performed on node or system boundaries. This means that a partition must have the hardware to function independently. Static partitioning also means that one node can't be subdivided into multiple partitions, but a partition can consist of multiple nodes.
- Dynamic partitioning has the same hardware boundaries as static partitioning, but it permits hardware reconfiguring while the partition's operating system is still running.

▶ Logical partitioning

Servers using VMware ESX Server will be able to reconfigure a system partitioned at the individual processor level, without shutting down and restarting the virtual server. When workload demands change, you can also reassign resources from one logical partition to another by restarting the server.

If you intend to consolidate servers, system partitioning offers many benefits:

- ▶ Multiple operating systems previously run on multiple servers could all be running simultaneously on one server in one location.
- ▶ System partitioning enables you to set up different cluster types. Clustering delivers high availability, because multiple servers can be connected together with one server backing up the other. In the event that one of the servers requires maintenance or service, the second server can support the users and workload while corrective action is performed and the offline server is brought back online.



- ▶ Using IBM technology such as memory mirroring, Chipkill Memory, Memory ProteXion and system partitioning, customers can implement high-availability cluster solutions.
- ▶ Scalable clusters provide customers with industry-leading scalability at a system level, as well as load balancing to maximize performance and the support received by users accessing the system.

## 2.4 Server consolidation

Server consolidation means combining the functions performed by many servers into a fewer number of servers to reduce cost, complexity, network traffic, and management overhead, and to increase the efficiency of systems management, security, and resource utilization.

Server consolidation is complex, and needs methodical approach because of the nature of the problem:

- ▶ Large numbers of servers are involved.
- ▶ Servers from different vendors, of different sizes, with different configurations.
- ▶ Software ranges from used and well-known to local and poorly understood.
- ▶ Business services being provided will vary greatly in volume and type.
- ▶ Consolidation may provide essential business functionality that must be protected from disruption.
- ▶ Consolidation must take place without delivering limits on an organization's future ability to adjust the size, scope, and direction of its business initiatives.

### 2.4.1 Types of server consolidation

One of the most important things to remember is that there are no “off-the-shelf” solutions for server consolidation. Every organization requires a unique solution that will match its unique infrastructure and business model.

There are four general types of server consolidation, offering a wide range of business value through varying degrees of solution complexity and investment.

There are four types of server consolidation:

- ▶ Centralization
- ▶ Physical consolidation
- ▶ Data integration
- ▶ Application integration

These are summarized in Table 2-1 and described in detail below.

Table 2-1 Server consolidation strategies

Type of Consolidation	Definition	Potential Benefit
Centralization	Relocate to fewer sites	Reduction in administration costs Increased reliability and availability Lower operation costs Improved security and management
Physical Consolidation	Replace with larger servers	Reduced hardware and software costs Improved processor utilization Reduced facilities costs (space, power, A/C) Lower operations costs Improved manageability
Data Integration	Combine data from multiple sources into a single repository	Reduced storage management costs Improved resource utilization Reduction in administration costs Improved backup/recovery capabilities Enhanced data access and integrity
Application Integration	Consolidation of multiple applications onto one server platform	Reduction in administration costs Increased reliability and availability Reduced facilities costs (space, power, A/C) Lower operation costs Scalability

► Centralization

Server consolidation means different things to different people. As shown in Figure 2-4, in its simplest form, servers are physically moved to a common location. Because this simplifies access for the IT staff, it helps reduce operations support costs, improve security, and ensure uniform systems management. This is an important predecessor to future consolidation activities.

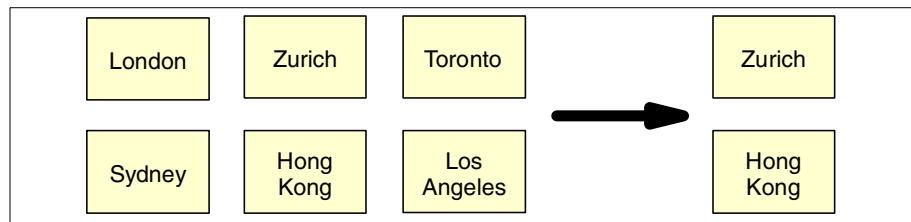

Figure 2-4 Centralization

Centralization involves relocating existing servers to fewer sites, for example, taking 20 servers scattered over three floors in your building and moving them

to a single server room, or moving 200 servers originally installed across 20 locations to three data centers.

– **Relocating existing servers to one or fewer IT sites**

Centralization, or data center consolidation, may be a first step for an organization after a merger. After a merger, the resulting entity does not want to attempt merging applications; however, they will collocate their systems as a first step.

For both servers and storage systems, two subcategories of centralization are defined:

- Virtual centralization, which is mainly made through the network
- Physical centralization, where hardware is physically moved to different locations

Centralization is often the initial step a company takes toward controlling costs through consolidation. It's also generally the first step taken toward rationalizing the architecture after a merger or acquisition.

By simply relocating existing servers to fewer numbers of IT sites, economies of scale of operation can provide simplified management and cost improvement.

– **Virtual centralization or remote management**

You can begin centralization in small steps. With virtual centralization or remote management, physically dispersed servers or storage systems are logically centralized and controlled through the network. Hardware remains physically distributed, but is brought under a common umbrella of systems management and network management tools. Operations costs can therefore be reduced, and system availability can be improved.

– **Physical centralization or server relocation**

Existing servers or storage systems are physically relocated to one or fewer IT sites. Because this simplifies access for the IT staff, it helps reduce operations support costs, improves security, and ensures uniform systems management. This is a step in the right direction, but the payback is relatively low. However, it is an important predecessor to future consolidation activities.

► **Physical consolidation**

Physical consolidation is the replacement or reduction of some number of smaller systems with fewer and more powerful systems. This consolidation does have advantages:

- It improves availability because there are fewer points of failure.
- It can reduce the cost and complexity of system communications.
- It simplifies operations.

With its Enterprise X-Architecture enabled features, the x440 server offers flexibility, availability, and scalability to handle customer requirements for consolidating distributed workloads onto a single powerful and highly available platform to achieve total cost of ownership (TCO) savings.

– **Reducing the number of servers by replacing many small servers with fewer large servers**

Physical consolidation may be implemented on a site, department, or enterprise basis. For example, many x220 file/print servers can be consolidated onto newer, much faster, more reliable x440 servers, or older servers with high hardware maintenance costs can be consolidated or replaced by newer, much faster, cheaper-to-maintain x440 servers.

– **Physical server consolidation**

The number of separate hardware platforms and operating system instances within a consolidation site may vary considerably by customer. Typically, some reduction in the number of distinct servers is accomplished when gathering distributed systems into a central installation or when a number of small servers are replaced with larger servers of the same platform. Based on the enterprise's platform, four physical server consolidation cases can be considered.

- Case 1: Small servers from one platform to server(s) on the same platform
- Case 2: Small servers from different platforms to servers on different platforms (platform source and target are the same)
- Case 3: Small servers from one platform to server(s) on a different platform
- Case 4: Small servers from different platforms to server(s) on a different platform (platforms' source and target are not the same)

Cases 1 and 2 are physical server consolidation, and there is no logical work to do. For cases 3 and 4, a platform migration has to be planned, and applications and data have to be ported from one platform to another. The objective of the physical server consolidation phase is not to share applications or data but to have an application that was running on one platform run on a new platform. Therefore, this operation has to be differentiated from application or data integration.

Physical consolidation can be divided into two subcategories, namely server consolidation and storage consolidation.

This can take place within the same architecture -- for example, several two-way servers replaced with one 16-way x440 server or many uniprocessor servers moving to several multiprocessor x440 servers.

With x440 capabilities such as system partitioning, you can migrate and consolidate workloads across systems for improvements in systems management and resource utilization.

This approach is typically appropriate for implementations of key packaged applications such as SAP, PeopleSoft, and Siebel, where minimal integration with other applications and data is required. LAN file/print servers using Windows 2000 or Novell NetWare solutions represent another opportunity area for consolidation activities and savings.

Storage consolidation is combining data from different sources (same or disparate types) into a single repository and format. This means that storage is viewed as an enterprise resource, where centralized disk space is used to supply the storage for the servers of the enterprise.

Additional benefits can be gained through data integration and application integration. While these are often more complex projects that require extensive analysis, planning and implementation, they can provide significant return-on-investment.

► Data integration

Data Integration involves physically combining data from different sources across the enterprise into a single repository and format. The result is that the merged data can reside on fewer servers and more centralized and consistent storage devices, greatly lowering the total costs.

When all corporate data resides on the same system, consolidation allows high levels of security and data integrity that are nearly impossible to achieve in a distributed environment. In addition, data sharing throughout the enterprise is vastly simplified.

The data can be file data such as Windows 2000, Novell, or Linux consolidated to a single network operating system. Also, multiple types of databases, such as DB2, Informix, Oracle, Sybase, etc., can be converged to fewer database architectures.

In many client/server infrastructures, centralizing LAN data can bring dramatic improvements in data transfer speed. New enhancements in communications hardware will expand the high-speed connectivity options to server platforms of all types.

There can be two kinds of data integration:

- Data integration from several servers and consolidated on a unique repository
- Data integration from several repositories in one server and consolidated on a unique repository

Depending on the type of application integration selected, data integration can be performed separately or together with application integration.

► Application integration

Application integration is the combining of multiple, similar applications, such as Web servers, onto one consolidated server.

Application integration is also the combining of different application workload types within a single server/system and migrating an application or data to a new platform in order to collocate the application and data.

It reduces administration, operation, and facilities costs and increases reliability and availability.

The main objective of application integration is to migrate applications from one or several locations to a single location. Based on the consolidation platform, this migration can take different forms:

- The migration may not bring any additional costs beyond that of relocating the application on a new server.
- The migration may imply that application programs have to be recompiled in order to run on the new platform.
- The migration may imply that application programs have to be redesigned and rewritten in order to run on the consolidation platform. As for physical server consolidation, application integration has several cases.
- Application integration is combining different application workload types within a single server or system.
- Distributed systems do not run identical applications and system software and have to be integrated into a consolidation server running a different operating system.

From another point of view, consolidation takes one of three basic approaches:

► Logical

Logical consolidation brings all server resources to the same level so that they can be viewed logically as a single unified environment.

In logical consolidation, actual systems are still distributed, while administrative procedures and processes are standardized company-wide. This kind of consolidation is relatively easy and safe to implement, but it carries the least potential for significant returns. Cost savings come from better asset management and opportunities to deploy high-quality, consistent administrative practices across the enterprise.

► Physical

Physical consolidation does pretty much what it says: systems are relocated to a single server site. The number of servers you have to manage remains the same, and cost savings come from better staff utilization, higher service

levels, simplified backups and restores, and better asset management and security.

- ▶ **Rational**

In combination, or rational, consolidation, the company's distributed applications and services are combined onto fewer servers. It is a considerably more complex undertaking, but the potential rewards are greater. Cost savings range from 25 to 75 percent here resulting from better asset utilization and elimination of unnecessary systems, reduced staffing, lower maintenance costs, and fewer operating environments to support.

## 2.4.2 Why consolidate servers

IT managers are feeling, pressure to reduce costs, maintain or improve service levels, and maintain or improve the availability of systems that become ever more critical to daily operations.

Users want new applications that are delayed or inadequate because of IT infrastructure. IT needs to provide a cost-effective and reliable service, which is made difficult by constantly changing applications.

Many organizations are realizing that, as the number of servers increases, the cost and operational complexity are also propagating. In many cases, there are concerns whether multiple distributed servers can provide the application availability, hours of service, responsiveness, and ability to grow with the requirements of the business. These characteristics are being increasingly demanded by business applications. To reduce these costs, many customers are attempting to consolidate their servers into a more manageable central location.

The main objectives of server consolidation are:

- ▶ Recentralizing servers
- ▶ Merging workloads onto a single large server
- ▶ Consolidate architecture
- ▶ Optimize the IT infrastructure

## 2.4.3 Benefits from server consolidation

The main benefits of server consolidation are:

- ▶ **Single point of control**

Rapidly growing firms, especially those growing through mergers and acquisitions, frequently felt that disparate distributed systems were so unwieldy to manage that they were losing control, which could constrain further corporate growth.

A single point of control allows enterprises to:

- Reduce or eliminate department operational costs
- Reduce some software licenses
- Reduce number of systems, disk storage costs
- Reduce maintenance charges
- Avoid multiple copies of the same application on distributed systems
- Reduce owner operational costs
- Offer better availability of service
- Improve systems management
- Have better version control management
- Have better software distribution
- Reduce risk and increase security

▶ **Giving users better services**

With a consolidated infrastructure, end users can count on round-the-clock service, seven days a week. The response time is much better than with an overly distributed environment, and the data is more easily accessible while being highly protected. The control procedures are simpler, while security becomes even higher. And information sharing is improved, giving end users increased data consistency. The availability of service is improved mainly due to a reduction in the time needed to communicate between clients and servers in a single location.

▶ **Regaining flexibility**

The standardization of procedures, releases, and servers also makes it easier to install new application software, for example, Internet and intranet, electronic commerce, and so on. In today's fast moving environment, computing resource consolidation enables a trouble-free upgrade of the information system and less costly adaptation to organization or environment changes. Enterprises can react more quickly to market changes, since storage is readily available and can easily be reallocated.

▶ **Avoid floor space constraints**

While a small server may be easily fit into a closet, as compute demands increase, enterprises find that suitable floor space is hard to find for proliferating small servers. The solution is a central site outfitted with appropriate power, cooling, access to communications links, and so on, and populated with more powerful systems, each giving more performance in the same footprint.

▶ **Reduction of the Total Cost of Ownership (TCO)**

There are several costs associated with server consolidation, including:

- Hardware costs — new servers and infrastructure, upgrades
- Software costs — fewer software licenses are required with fewer servers
- Disruption costs — migration, change management



► **Manageability and availability**

Server consolidation can help you improve manageability and availability of IT systems in the following ways:

- Enterprise management - Integrated operations allows for consistent management of all facilities and IT services.
- Consistent performance - Providing consistent response time at peak load periods is very important.
- Dependability - Commonly cited problems of distributed environments include frequency of outages and excessive requirements for manual intervention by the IT staff.

In addition, it provides the following benefits:

- It is easier to enforce consistent user policies in a consolidated environment.
- Fewer servers lead to a simpler network structure that is easier to manage.
- Reorganization following mergers or acquisitions is easier in a well-controlled environment.
- Consolidation encourages standardization of tools, processes, and technologies to provide a stable and consistent application platform.

Server consolidation can help you improve data access and protection in the following ways:

- Network technology - The growth of networking and network speeds is enabling the centralization of IT networks today and will continue and expand into the future.
- Fragmentation and duplication of data - This is a core issue in most organizations with large numbers of distributed servers.
- Physical security - Consolidation of servers in a central data center can restrict unwanted access and ensure a more secure environment.
- Integrity, local backup and recovery - Enterprises are concerned about the dangers of business disruption, customer lawsuits, and regulatory action in the event of severe data loss, and they need to implement effective disaster recovery procedures.

Server consolidation can help you leverage existing investments in the following ways:

- Expand existing servers - Add new capabilities to the existing installation rather than to deploy new dedicated servers.
- Optimization of capacity utilization - In order to manage performance and have a level of acceptable, consistent response times, enterprises typically

run at 50-60% utilization. Excess or underutilized capacity on one server cannot be shared with workloads of other servers in a distributed environment.

- Optimization of skilled resources - Under the distributed alternative, systems management responsibilities are often only part-time, extra-duty assignments such that a critical skill level is rarely achieved. Furthermore, since other departments may employ disparate architectures and applications, there is little opportunity to benefit from the experiences of others.

► **Scalability and workload growth**

Server consolidation can help you handle scalability and workload growth issues in the following ways:

- True scalability - Server consolidation provides the ability to deal with peak usage without crashing or seriously degrading performance. It also provides an upgrade path without degradation in response, excessively complex forms of database partitioning, or other problems.
- Granular upgrades - Server consolidation provides the ability to quickly grow the number of users, the number of applications, or the size of an application when needed, without major disruptions to the current production environment.

► **Service level**

Most companies spend their IT budget for services. They need services for hardware, software, and infrastructure maintenance. Server consolidation can help you to reduce the increasing service costs in the following ways:

- Delivery of a specified service level is costly if servers are uncontrolled.
- Management of servers as corporate assets is easier when they are centralized.
- Application deployment is quicker and easier when not spread over a large number of servers.
- Staff time freed from server maintenance tasks can be used for activities more directly related to business needs.

► **Business continuity**

Almost all enterprises need to run their business without interruption. Business interruption can be very costly and it influences the productivity of your business. Server consolidation can help you to run your business without interruption in the following ways:

- Consolidating IT resources can help you ensure that critical business information and processes are accessible and shared across the enterprise.

- Implementing critical new solutions that may enable a competitive edge is easier.

- ▶ **Reduced technical complexity**

Three-tier logical architectures tend, in practice, to become five-tier architectures (client, local server, central server, gateway, and enterprise server). Server consolidation can simplify technical complexities by eliminating the true number of tiers in a purported three-tier architecture by reducing or eliminating central servers and gateways.





# Planning

In this chapter we discuss topics you need to consider before you finalize the configuration of your x440 system and before you begin implementing the system. The topics covered are:

- ▶ System hardware
- ▶ Cabling and connectivity
- ▶ Storage considerations
- ▶ Server partitioning and consolidation
- ▶ Operating system considerations
- ▶ Application considerations
- ▶ Rack installation
- ▶ Power considerations
- ▶ Solution Assurance Review

## 3.1 System hardware

The x440 provides a scalable and flexible hardware platform. There are a number of important aspects of the system hardware to consider when planning your configuration. These are discussed in this section.

**Tip:** For the latest hints and tips on the x440, review the document *Hints, Tips, and Frequently Asked Questions for the xSeries 440 Quick Reference*, available from:

<http://www.pc.ibm.com/qtechinfo/MIGR-43876.html>

### 3.1.1 Processors

There are currently two processor types available with the x440 system:

- ▶ Xeon DP models can be ordered with either two Xeon DP processors in a single SMP Expansion Module or with four Xeon DP processors in two SMP Expansion Modules. There is no further upgrade beyond four Xeon DP processors, other than replacing them with Xeon MP processors.
- ▶ Xeon MP models come with two Xeon MP processors installed in the standard SMP Expansion Module. Up to four Xeon MP processors are supported in the standard SMP Expansion Module. Using the optional second SMP Expansion Module, part number 32P8340, up to eight processors can be installed in an x440.

Processors are available as options:

- ▶ Xeon Processor MP 2.0 GHz 2 MB L3 Cache, 59P5173 (“Gallatin”)
- ▶ Xeon Processor MP 1.9 GHz 1 MB L3 Cache, 59P5172 (“Gallatin”)
- ▶ Xeon Processor MP 1.5 GHz 1 MB L3 Cache, 59P5171 (“Gallatin”)
- ▶ Xeon Processor MP 1.6 GHz 1 MB L3 Cache, 32P8707 (“Foster”)
- ▶ Xeon Processor MP 1.5 GHz 512 KB L3 Cache, 32P8706 (“Foster”)
- ▶ Xeon Processor MP 1.4 GHz 512 KB L3 Cache, 32P8705 (“Foster”)
- ▶ Xeon Processor DP 2.4 GHz 512 KB L2 Cache, 37L3533 (“Prestonia”)

Key processor configuration rules:

- ▶ All CPUs used in a single-server (that is, two, four or eight-way) or multi-server (eight, 12 or 16-way) configuration must be the same type, speed, and L2/L3 cache size.

- ▶ For servers with Xeon MP processors:
  - Ensure you order sufficient processors to maintain a supported configuration of two, four, or eight CPUs. Other quantities of CPUs (3, 5, 6, or 7) are not supported.
  - The standard SMP Expansion Module must have four processors installed before the second one can be installed and used.
  - Use part number 32P8340 for the second SMP Expansion Module. This module is “unpopulated” (that is, it does not have any CPUs or memory installed in it).
  - The second SMP Expansion Module is supported only with four Xeon MP processors. Consequently, if you install the second one, the system must have eight CPUs after the installation.
  - All Xeon MP processors must be identical for 16-way configurations.
- ▶ For servers with Xeon DP processors:
  - Each SMP Expansion Module must have two processors installed and those processor must be installed in CPU sockets 1 and 4.
  - The standard SMP Expansion Module must have two Xeon DP processors installed before the second one can be installed and used.
  - Use part number 71P7919 for the second SMP Expansion Module. This part number includes two 2.4 GHz Xeon DP processors.
  - You can upgrade a Xeon DP model to have Xeon MP processors, but all Xeon DP CPUs must be removed. You cannot mix Xeon MP and Xeon DP processors in the same x440 system.

See 1.5, “SMP Expansion Module” on page 17 for more information on the SMP Expansion Modules.

### 3.1.2 Memory

The 16 sockets on each SMP Expansion Module are divided into two ports, and each port contains two banks:

- ▶ Port 1:
  - Bank 1 = DIMM connectors 1, 3, 5, 7
  - Bank 3 = DIMM connectors 2, 4, 6, 8
- ▶ Port 2:
  - Bank 2 = DIMM connectors 9, 11, 13, 15
  - Bank 4 = DIMM connectors 10, 12, 14, 16

Physically, the banks occupy alternating sockets, as shown in Figure 3-1 on page 66.

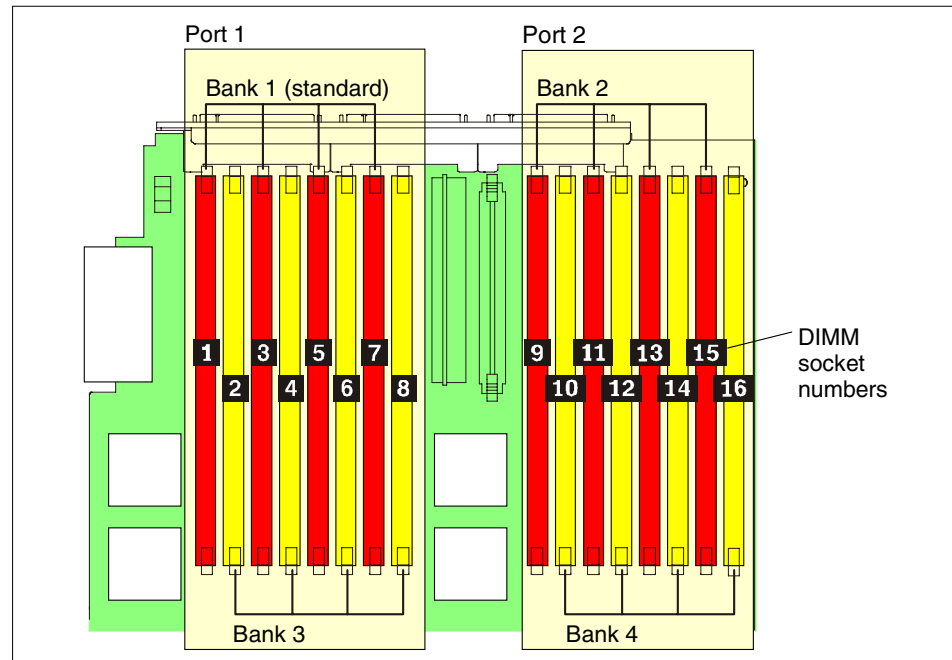

Figure 3-1 DIMMs sockets on the x440 SMP Expansion Module

Key memory configuration rules:

- ▶ Because the x440 uses four-way interleaving, memory DIMMs must be installed in banks (four DIMMs). Supported DIMMs are:
  - 512 MB DIMMs, part number 33L3324
  - 1 GB DIMMs, part number 31P8300
  - 2 GB DIMMs, part number 31P8840
- ▶ Memory DIMMs of different sizes can be used in the same SMP Expansion Module, but all four DIMMs in a bank must be the same size.
- ▶ If you want to install more than 32 GB of RAM, you must use two SMP Expansion Modules. This in turn means that a certain number of CPUs must also be installed. In Xeon MP-based systems, eight processors must be installed and in Xeon DP-based systems, four processors must be installed.
- ▶ Four 512 MB or four 1 MB DIMMs are standard in the Xeon MP models, and the Xeon DP models have eight 512 MB DIMMs standard (see Table 1-1 on page 3). If you wish to install more than 26 GB in the standard SMP Expansion Module, you will need to remove the 512 MB DIMMs and fully populate the module with 2 GB DIMMs.



## Memory mirroring

As discussed in 1.7, “System memory” on page 19, memory mirroring is supported by the x440 for increased fault tolerance and high levels of availability.

Key configuration rules relating to memory mirroring:

- ▶ Memory mirroring must be enabled in the BIOS (it is disabled by default). See 4.1.2, “Enabling memory mirroring” on page 108 for details.
- ▶ Enabling memory mirroring halves the amount of memory available to the operating system.
- ▶ Both ports in an SMP Expansion Module must have the same total amount of memory. Partial mirroring is not supported.
- ▶ When using memory mirroring, all of the DIMMs in an individual memory port (that is in both banks) must be the same size and clock speed (all memory must be 133 MHz DIMMs). DIMM sizes in one port can be different from DIMM sizes in the other port, but the total amount of memory in Port 1 must be equal to the total memory in Port 2.

**Important:** While memory mirroring is disabled, DIMMs in one bank may be a different size from DIMMs in the second bank of the same port. This configuration is not supported if memory mirroring is enabled.

- ▶ The ability to hot-replace a failed DIMM or hot-add additional DIMMs is currently not supported.
- ▶ SMP Expansion Modules are individually configured for memory mirroring in the BIOS. This means that as well as full memory mirroring, you can also enable memory mirroring only in one SMP Expansion Module. IBM recommends against this.
- ▶ Memory mirroring does not work across SMP Expansion Modules. You cannot set up four 512 MB DIMMs in the bottom SMP Expansion Module to be mirrored by four 512 MB DIMMs in the top SMP Expansion Module. Memory mirroring only operates across ports in the same SMP Expansion Module.

## Memory performance considerations

From a performance perspective, you should attempt to balance memory between SMP Expansion Modules. This is more important than maximizing memory bandwidth to a module. Make sure each SMP Expansion Module has the same amount of memory. Then, if possible, make sure each module has eight DIMMs installed. For performance reasons, consider the following:

- ▶ When installing eight DIMMs, install four in bank 1 (sockets 1, 3, 5, and 7) and four in bank 2 (sockets 9, 11, 13, and 15).

- ▶ When installing DIMMs, try to evenly divide the amount of RAM available between the two ports.

For example, if you have 12 DIMMs (eight 512 MB DIMMs and four 1 GB DIMMs for a total of 8 GB), install all eight 512 MB DIMMs (4 GB) in one port and the four 1 GB DIMMs (also 4 GB) in the other port. This will give you better performance than mixing four 512 MB DIMMs and four 1 GB DIMMs (6 GB total) in one port and four 512 MB DIMMs (2 GB) in the other port.

### **Additional memory considerations**

An x440 system with two SMP Expansion Modules installed currently supports a maximum of 64 GB of memory, using 2 GB DIMMs. To enable your operating system to address this amount of memory, there may be certain operating system configuration modifications required.

For example, to enable Windows 2000 Advanced Server and Datacenter Server to access physical memory over 4 GB, the /PAE switch is required in the boot.ini file. For detailed information on the /PAE switch and the /3GB switch, refer to Microsoft Knowledge Base Article Q283037 at:

<http://support.microsoft.com/default.aspx?scid=kb;en-us;Q283037>

### **3.1.3 PCI slot configuration**

As shown in Figure 3-2 on page 69, there are six PCI-X slots internal to the x440.

These six slots are implemented using four PCI buses, labeled A-D in Figure 3-2 on page 69:

- ▶ Bus A (slot 1 and slot 2): Two 64-bit 66 MHz slots
- ▶ Bus B (slot 3 and slot 4): Two 64-bit 100 MHz slots (133 MHz if only one slot is occupied)
- ▶ Bus C (slot 5): One 64-bit 133 MHz slot
- ▶ Bus D (slot 6): One 64-bit 133 MHz slot

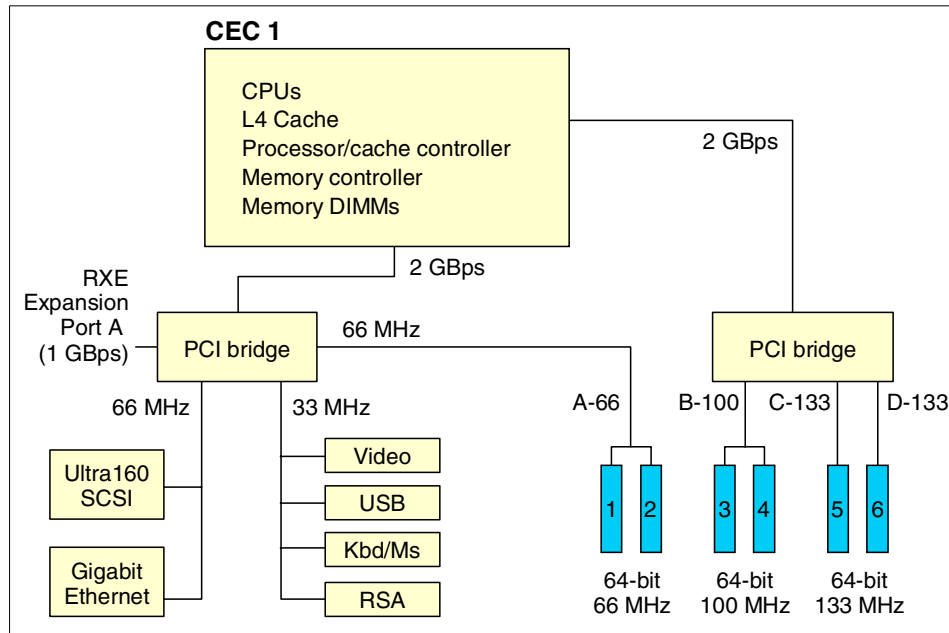

Figure 3-2 x440 block diagram showing the internal PCI-X slots

These slots can accept adapters rated at speeds ranging from 33 MHz to 133 MHz. When deciding which adapters to put in which slots, we recommend you use the Active PCI Manager wizard to help you determine the best slots to use. See 5.1, “Active PCI Manager” on page 130 for details.

You should also consider the following:

- ▶ Each adapter has a maximum rated speed and each bus also has a maximum rated speed.
- ▶ Installed adapters in a single bus will operate at the slowest of three speeds:
  - The rated speed of adapter 1
  - The rated speed of adapter 2 (if the bus the adapter is installed in has two slots)
  - The rated speed of the bus
- ▶ Bus B supports one adapter at up to 133 MHz or two adapters at up to 100 MHz.
- ▶ 32-bit adapters can be installed in any of the slots and will run in 32-bit mode. 32-bit and 64-bit adapters can coexist in 64-bit slots in the same bus. The 32-bit adapters will run in 32-bit mode, and the 64-bit adapters will run in 64-bit mode.

**Tip:** Take the time to understand these rules and to select the best slots for your adapters. Incorrect choices can result in a loss of PCI adapter performance.

As extreme configuration examples, you could configure either of the following:

- ▶ Six 33 MHz PCI adapters, all operating at 33 MHz.
- ▶ Six 133 MHz PCI-X adapters, with two operating at 133 MHz (buses C and D), two at 100 MHz (bus B) and two at 66 MHz (bus A).

**Important:** A PCI-X and a PCI adapter can be installed in slots on the same bus. However, those two adapters will both operate in PCI mode.

In addition, if you have a PCI-X adapter installed, you cannot hot-add a PCI adapter to the same bus. This is because with just the PCI-X adapter installed, the bus is running in PCI-X mode, and you cannot hot-add a PCI adapter into a bus that is in PCI-X mode.

Table 3-1 summarizes the supported adapter speeds. Take into account the speed reductions when there are two adapters installed in a bus, as described above.

*Table 3-1 Supported adapter speeds in each slot*

Slot	Bus	Width (bits)	Supported adapter speed (MHz)
1	A	32 or 64	33 or 66
2	A	32 or 64	33 or 66
3	B	32 or 64	33, 66, or 100 (133 as long as no adapter is in slot 4)
4	B	32 or 64	33, 66, or 100 (133 as long as no adapter is in slot 3)
5	C	32 or 64	33, 66, 100 or 133
6	D	32 or 64	33, 66, 100 or 133

The physical location of these slots in the server is shown in Figure 3-3 on page 71.

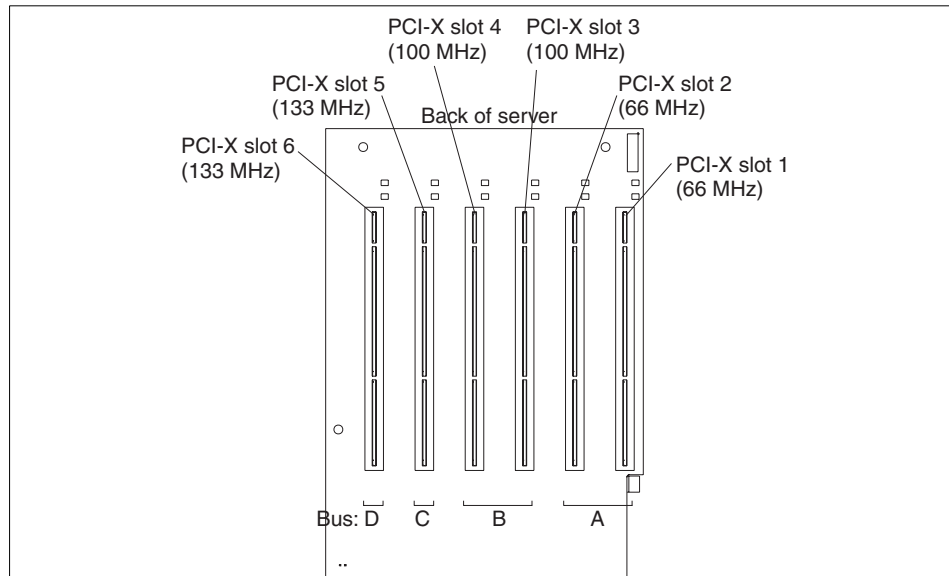

Figure 3-3 PCI-X slots in the x440

Other configuration information:

- ▶ The x440 server supports connection to the RXE-100.  
Refer to 3.2.3, “Remote Expansion Enclosure” on page 78 for more information.
- ▶ Video adapters are not supported.
- ▶ The PCI slots supports 3.3 V adapters only.

**Important:** 5 V adapters are not supported.

- ▶ The ServeRAID 4H adapter is not supported for internal drives because the adapter is too high to fit in the 4U server when a cable is attached to its internal connector.
- ▶ Do not install a ServeRAID card in slot 1. This is because there is little space between the top of the adapter and the cover when the covers are closed. This could damage the SCSI cable. See tip H176217 at <http://www.pc.ibm.com/qtechinfo/MIGR-43804.html> for details.
- ▶ The x440 comes with an additional pre-installed cable to enable the ServeRAID adapter to connect to the internal drives.

**Tip:** The pre-installed cable for the ServeRAID adapter is disconnected at *both* ends. To use it, disconnect the smaller SCSI cable from the hard drive backplane. Then connect the ServeRAID cable to the hard drive backplane and to the ServeRAID card itself.

- ▶ Some long adapters have extension handles or brackets installed. Before installing the adapter, you must remove the extension handle or bracket.
- ▶ The system scans PCI-X slots to assign system resources. The system attempts to start the first device found. The search order is:
  - a. CD-ROM
  - b. Disk drives
  - c. Integrated SCSI devices
  - d. x440 PCI-X slots (in the order 1, 2, 6, 5, 3, 4)
  - e. Integrated Ethernet controller

If an RXE-100 is attached, the order is:

- a. CD-ROM
- b. Disk drives
- c. Integrated SCSI devices
- d. x440 PCI-X slots (1, 2, 6, 5, 3, 4)
- e. RXE-100 slots (A5, A6, A3, A4, A1, A2, B6, B5, B3, B4, B1, B2)
- f. Integrated Ethernet controller

### Active PCI Manager

Active PCI Manager is an IBM Director extension that helps manage PCI and PCI-X adapters in supported xSeries servers. It includes an analyze function that will help you to plan and optimize the PCI and PCI-X adapter placement in the x440 and Remote Expansion Enclosure (RXE-100). For a detailed discussion on Active PCI Manager, refer to 5.1, “Active PCI Manager” on page 130.

## 3.1.4 Broadcom Gigabit Ethernet controller

The x440 is the first xSeries server to offer a Gigabit Ethernet controller integrated standard in the system. The x440 includes a single-port Broadcom BCM5700 10/100/1000 BASE-T MAC (Media Access Controller) on a PCI 64-bit 66 MHz bus. The BCM5700 supports full and half-duplex performance at all speeds (10/100/1000 Mbps, auto negotiated) and includes integrated on-chip memory for buffering data transmissions, and dual onboard RISC processors for advanced packet parsing and backwards compatibility with 10/100 devices. The Broadcom controller also includes software support for failover, layer-3 load balancing, and comprehensive diagnostics.

Category 5 or better Ethernet cabling is required with RJ-45 connectors. If you plan to implement a Gigabit Ethernet connection, ensure your network infrastructure is capable of the necessary throughput to match the server's I/O capacity.

You will need to provide Ethernet cables for the onboard 10/100/1000 Ethernet controller.

## Adapter teaming

The Broadcom controller is capable of participating in an adapter team for the purposes of failover, load balancing, and port trunking. The choice of adapters to team with the onboard controller depends on whether you have a copper-only network or a mixed copper/fiber network. Our recommendations are:

- ▶ If you have a copper Gigabit environment, use the Broadcom-based NetXtreme 1000T Ethernet adapter, part 31P6301. Alternatively, use the Intel PRO/1000 XT Server adapter, part 22P6801. Note that the 22P6801 is only supported in specific slots — see the following for details:

[http://www.pc.ibm.com/us/compat/x440/ibm\\_22P6801.html](http://www.pc.ibm.com/us/compat/x440/ibm_22P6801.html)

- ▶ If you have a mixed fiber/copper Gigabit server switch network, use the Broadcom-based 22P7801, NetXtreme 1000 SX Fiber Ethernet adapter.

You can also team the onboard Gigabit card with 10/100 cards such as 06P3601 and 22P4901, but this not a recommended configuration. You can also team with the older Gigabit fiber card, 06P3701.

Adapter teaming and failover works by using software additional to the adapter driver to provide the failover functionality.

When installing the on-board Broadcom controller in an adapter team with an Intel-based Gigabit controller, we recommend you install the Broadcom controller driver, then the Broadcom Advanced Server Program (BASP) software and finally the driver for the Intel-based controller. Only install a single adapter teaming package. Do not use the Intel advanced teaming software.

Detailed instructions for installing the individual driver and failover packages are available with the driver software.

For the latest network adapter drivers and software for the x440 server, go to the x440 driver matrix:

<http://www.pc.ibm.com/qtechinfo/MIGR-39747.html>

For details about compatibility, see the ServerProven LAN adapter page:

<http://www.pc.ibm.com/us/compat/lan/matrix.html>

## 3.2 Cabling and connectivity

There are a number of unique factors to consider when cabling the x440 server:

- ▶ SMP Expansion Module connectivity
- ▶ Remote Supervisor Adapter connectivity
- ▶ RXE-100 connectivity
- ▶ Serial connectivity

We discuss each of these in this section.

The rear panel of the x440 showing the locations of cable connectors is shown in Figure 3-4. For port locations on the Remote Supervisor Adapter, refer to Figure 3-7 on page 77.

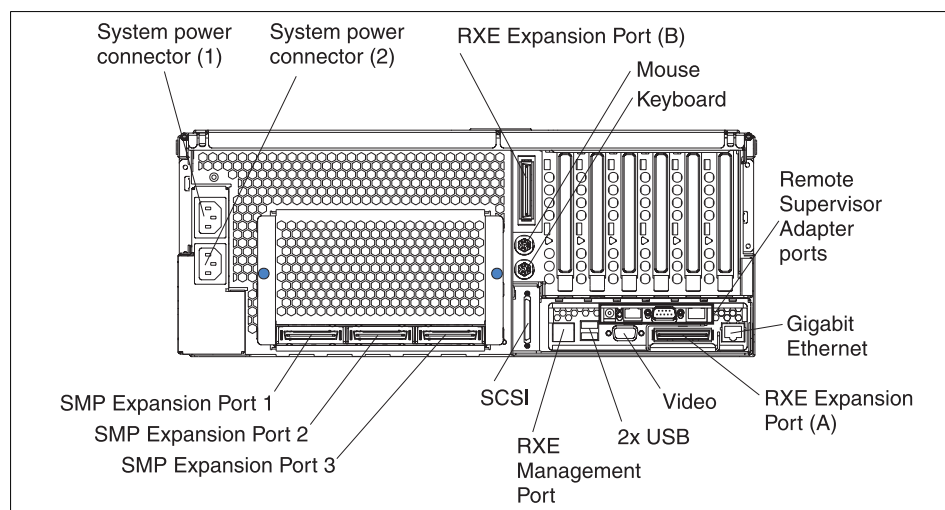

Figure 3-4 Rear Panel of the x440 (single SMP enclosure installed)

### 3.2.1 SMP Expansion Module connectivity

As standard the x440 ships with a single SMP enclosure installed. When the CPU slots in the first enclosure are fully populated, the second SMP Expansion Module can be added. For detailed instructions on installing the second SMP Expansion Module, refer to Chapter 2, “Installing Options”, in the *IBM @server xSeries 440 Installation Guide*, which is available from:

<http://www.pc.ibm.com/qtechinfo/MIGR-42328.html>



When a second SMP Expansion Module is installed in the x440, an additional three SMP Expansion Ports are made available on the rear of the chassis, giving a total of six. The SMP Expansion Module option includes two cables that are used to connect the modules together, as shown in Figure 3-5.

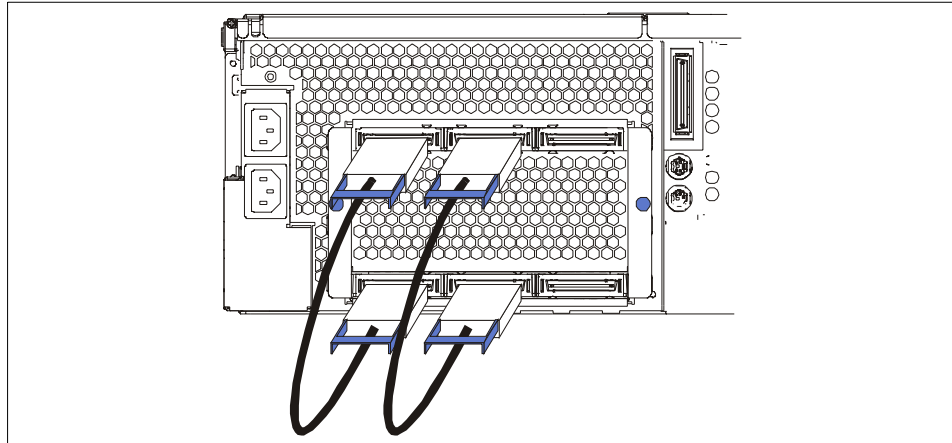

*Figure 3-5 SMP Expansion Ports with two SMP Expansion Modules installed*

**Note:** The two 10-inch scalability cables used to connect the two SMP Expansion Modules in a single x440 are included with the SMP Expansion module.

With single-x440 configurations, these ports are used to connect the two internal SMP Expansion Modules together. Only four ports are used (two cables). The other two ports are not connected.

When connecting two x440 nodes together to form a 16-way configuration, these ports are cabled together as shown in Figure 3-6 on page 76.

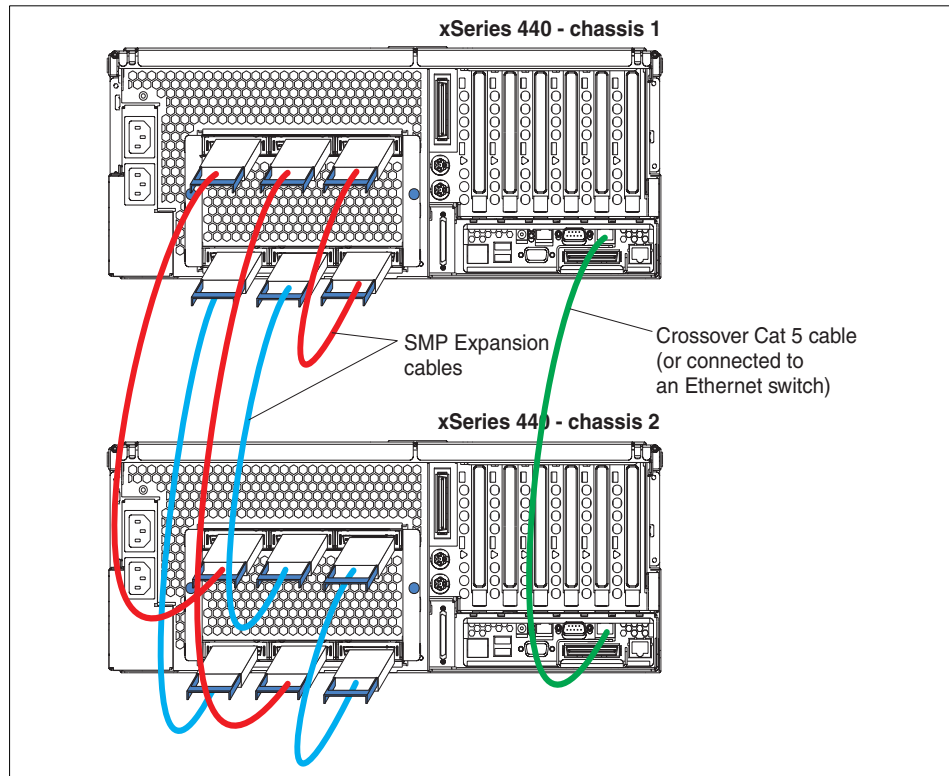

Figure 3-6 Connecting the two x440s together in a 16-way configuration

The two x440s are connected through the scalability port on each SMP Expansion Module and require the installation of four 3.5 m Remote I/O cables (part number 31P6102) to complete the configuration.

**Tip:** These four additional cables are the same as the ones used to connect the RXE-100 Remote Expansion Enclosure.

Key points relating to SMP Expansion Module cabling:

- ▶ The SMP Expansion Module ports cannot currently be used as high-speed interconnects for clustering purposes.
- ▶ The connections do not offer redundancy. If a connection is lost, the server will shut down or restart depending on your system's configuration.

- ▶ In 16-way configurations, the Ethernet port on the Remote Supervisor Adapter in one system is connected to the Ethernet port of the adapter in the other system. This connection is used during system startup and shutdown.

We recommend either of the following connections:

- Connecting the two using a crossover cable, as shown in Figure 3-6 on page 76.
- Connecting the two over an isolated LAN segment using a switch or hub. Connecting over a LAN segment will enable you to maintain Ethernet connectivity directly to the Remote Supervisor Adapter for out-of-band management.

**Tip:** We recommend that you assign static IP addresses to the Remote Supervisor Adapters on both servers.

### 3.2.2 Remote Supervisor Adapter connectivity

The x440 features an integrated Remote Supervisor Adapter (RSA). For detailed information on functionality and configuration of the RSA refer to section 9.5 “Remote Supervisor Adapter” in the redbook *Implementing IBM Director Management Solutions*, SG24-6188. This document talks about the Remote Supervisor Adapter as a separate adapter; however the functionality and location of ports is consistent with the integrated version of the RSA in the x440.

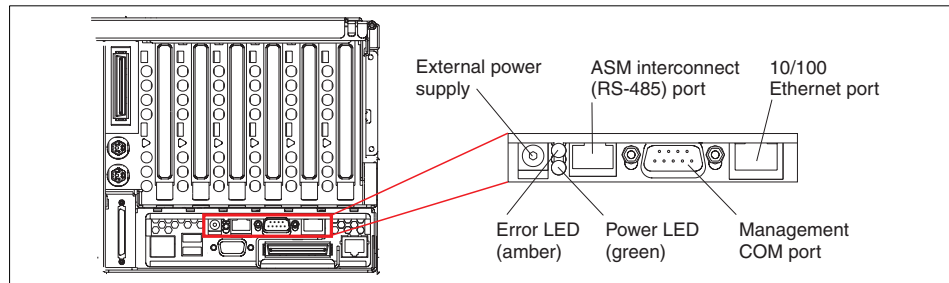

Figure 3-7 Remote Supervisor Adapter Connectors

The following RSA connections need to be considered when cabling the x440 (see Figure 3-7):

- ▶ External power supply connector. This connector allows the RSA to be connected to its own independent power source. This external power supply is not included with the x440 and will need to be ordered as an option (order a ThinkPad 56W AC Adapter with a suitable power cord for your country/region).

If this power supply is not used, the RSA will draw power from the server as long as the server is connected to a functioning power source.

- ▶ 9-pin Serial port, which supports systems management functions through null modem or modem connections.
- ▶ Ethernet port, which provides system management functions over the LAN.

As described in 3.2.1, “SMP Expansion Module connectivity” on page 74, in two-chassis configurations (such as the 16-way), the Ethernet ports of the two servers must be connected together either using a crossover cable or via a 100 Mbps Ethernet switch. The use of a switch is recommended if you also wish to perform out-of-band management activities.

- ▶ Advanced Systems Management (ASM) RS-485 Interconnect port to facilitate advanced systems management connections to other servers.

For detailed instructions on cabling ASM interconnect networks, refer to section 9.11 “ASM Interconnect” in the redbook *Integrating IBM Director with Enterprise Management Solutions*, SG24-5388.

**Note:** The x440 does not include the necessary dongle to connect the Remote Supervisor Adapter to an ASM interconnect bus using the RS-485 port on the adapter. Consequently, you will need the Advanced System Management Interconnect Cable Kit (part number 03K9309) for connection to an ASM interconnect network.

### 3.2.3 Remote Expansion Enclosure

The RXE-100 can be connected to the x440 to provide an additional six or 12 PCI-X slots to the server. Currently, only one RXE-100 is supported per x440 server or per 16-way two-node configuration.

The RXE-100 has six 133 MHz 64-bit PCI-X slots as standard and can accept adapters with speeds ranging from 33 MHz to 133 MHz. With the optional six-slot expansion kit (part number 31P5998) installed, the RXE-100 has 12 slots. Each set of six adapter slots is divided into three buses of two slots each, as shown in Figure 3-8 on page 79.

**Note:** When connecting the RXE-100 to a single x440 configuration, the RXE-100 can have six or 12 PCI-X slots. When connecting the RXE-100 to a 16-way two-node configuration, the RXE-100 must have 12 slots.

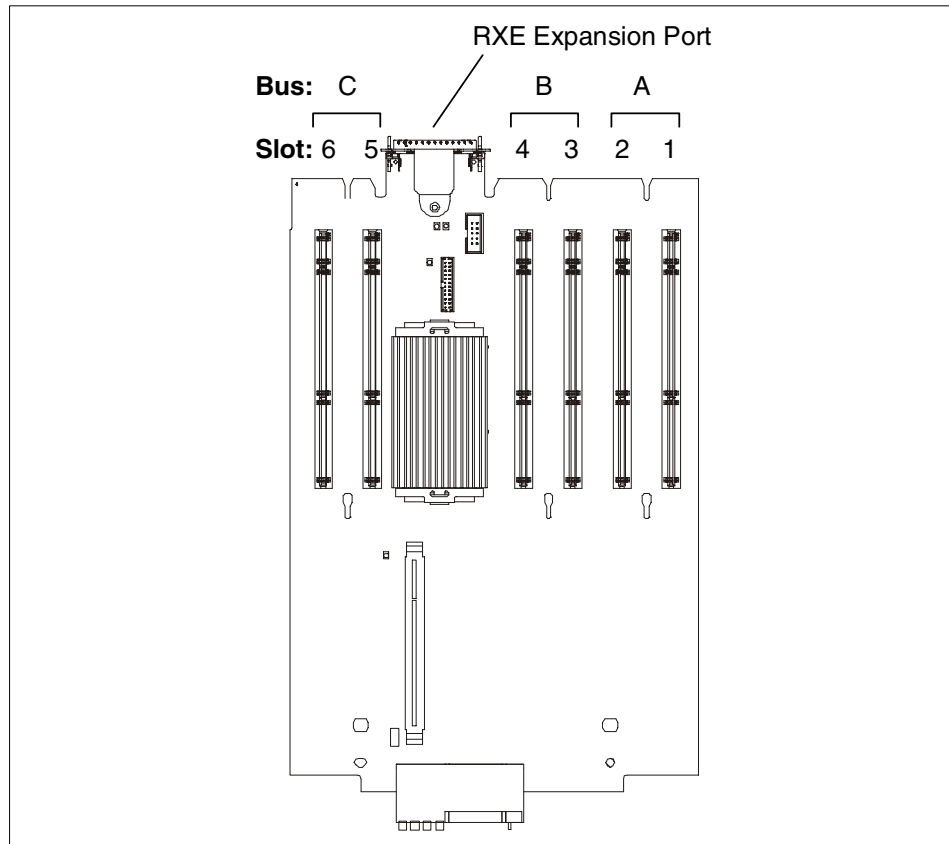

Figure 3-8 RXE-100 PCI-X expansion board (6 slots)

For each of the three buses (A, B, C), one of the following can be installed:

- ▶ One 64-bit 3.3 V PCI-X 133 MHz adapter (in the odd-numbered slot), running at up to 133 MHz
- ▶ Two 64-bit 3.3 V PCI-X 133 MHz adapters running at up to 100 MHz
- ▶ Two 64-bit 3.3 V PCI or PCI-X, 33 or 66 MHz adapters

**Note:** The PCI slots supports 3.3 V adapters only. 5 V adapters are not supported.

Like the x440, these slots can accept adapters rated at speeds ranging from 33 MHz to 133 MHz. When deciding which adapters to put in which slots, consider the following:

- ▶ Each adapter has a maximum rated speed and each bus also has a maximum rated speed.

- ▶ Installed adapters will operate at the slowest of three speeds:
  - The rated speed of adapter 1 in the bus
  - The rated speed of adapter 2 in the bus
  - The rated speed of the bus
- ▶ 32-bit adapters can be installed in any of the slots and will run in 32-bit mode. 32-bit and 64-bit adapters can coexist in 64-bit slots in the same bus. The 32-bit adapters will run in 32-bit mode, and the 64-bit adapters will run in 64-bit mode.
- ▶ When installing a 133 MHz PCI-X adapter, it must be installed in the first or odd-numbered slot in the bus (that is in slots 1, 3 or 5).
- ▶ Like the x440, a PCI-X and a PCI adapter can be installed in slots on the same bus in the RXE-100. However, these two adapters will both operate in PCI mode.

In addition, if you have a PCI-X adapter installed, you cannot hot-add a PCI adapter to the same bus. This is because with just the PCI-X adapter installed, the bus is running in PCI-X mode, and you cannot hot-add a PCI adapter into a bus that is in PCI-X mode.

- ▶ With Windows NT 4.0 Enterprise Edition, certain token-ring adapters do not work in some slots in the RXE-100. See RETAIN tip H175383 for more information:

<http://www.pc.ibm.com/qtechinfo/MIGR-42139.html>

## Connecting the RXE-100

There are two types of cables used to connect the RXE-100 to the x440:

- ▶ Remote I/O cable, for data

This cable connects from the x440 RXE Expansion Port A to the RXE-100 as shown in Figure 3-9 on page 81. Two lengths are available:

- 3.5 m Remote I/O cable kit (part number 31P6102)
- 8 m Remote I/O cable kit (part number 31P6103)

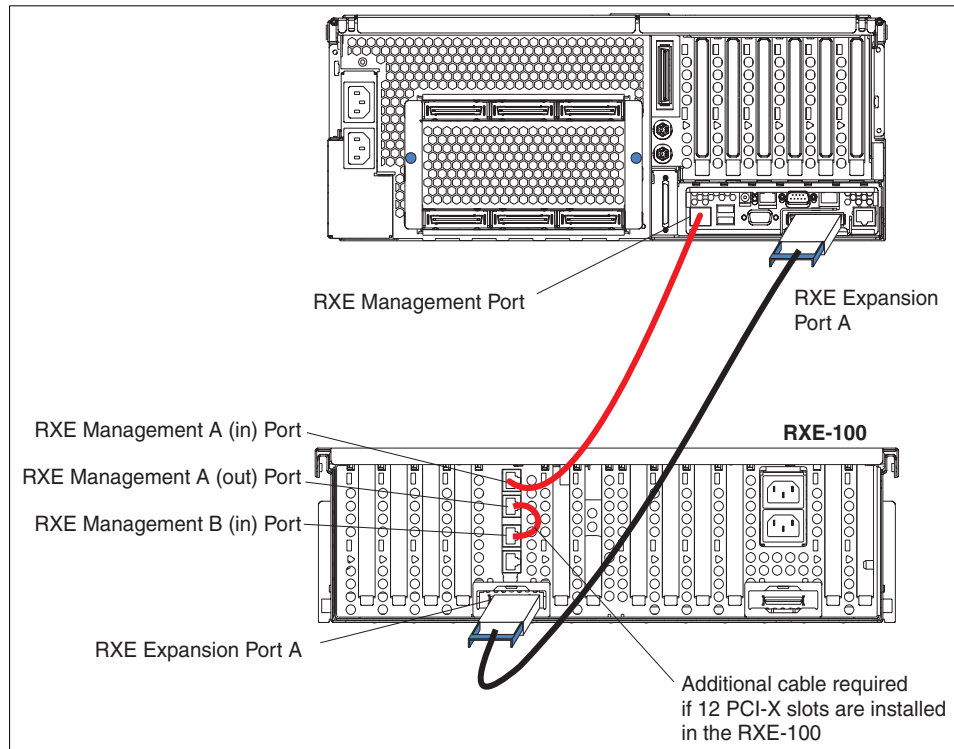

Figure 3-9 Connecting the RXE-100 to the x440

With single-node configurations (that is only one x440 node in a two, four or eight-way configuration), only one RXE-100 can be connected using one Remote I/O cable as shown in Figure 3-9. In this configuration, all 12 slots in the RXE-100 are available to the system. The use of two cables (for example, for redundancy or performance) is currently not supported.

The RXE-100 ships with a 3.5 m Remote I/O cable to connect the unit to the x440. This cable is long enough when the devices are in the same rack as each other. For installation in an adjacent rack, use the optional 8 m Remote I/O cable kit.

In the 16-way configuration (that is two x440 nodes), only one RXE-100 can be connected as shown in Figure 3-10 on page 82. Three Remote I/O cables are used — two to connect the x440s to the RXE-100 and one to connect the two x440s together.

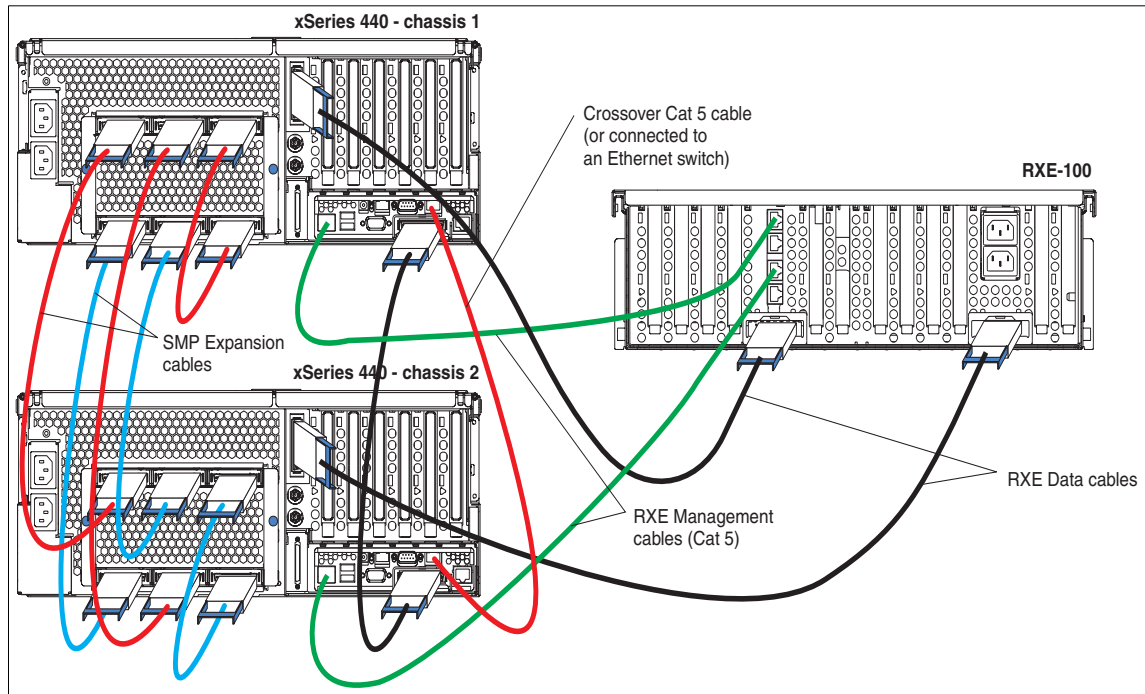

Figure 3-10 Connecting an RXE-100 to a 16-way x440 configuration

All 12 slots in the RXE-100 are available to the operating system, with six slots being accessed over each cable. If one cable connection fails, all 12 slots are accessed over the surviving cable connection. It is not currently supported to have each x440 node of a 16-way configuration connected to a separate RXE-100.

One 3.5 m Remote I/O cable ships with the RXE-100. The other two must be ordered separately. Use either the 3.5 m or the 8 m Remote I/O cable.

- ▶ Interconnect management cable, for remote I/O management

The RXE-100 also includes a 3.5 m interconnect management cable (an Ethernet cable), which in single-node configurations is used to connect the RXE Management Port on the x440 to the RXE Management A (In) Port on the RXE-100, as shown in Figure 3-9 on page 81.

Two lengths are available:

- 3.5 m interconnect management cable kit (part number 31P6087)
- 8 m interconnect management cable kit (part number 31P6088)



If the RXE-100 has the second set of six PCI slots installed, use the short interconnect management cable (supplied with the PCI slot option kit) to connect Management A (out) Port to Management B (in) Port (see Figure 3-9 on page 81).

**Important:** In the publication *IBM RXE-100 Remote Expansion Enclosure Installation Guide*, the section entitled “Attaching the enclosure to an xSeries 440 server” does not include instructions to connect the ports Management A (out) and Management B (in) on the RXE-100. Our testing in the lab indicates that this additional cable is necessary.

The 8 m interconnect management cable is suitable for inter-rack configurations.

For 16-way configurations, the management ports must be connected as shown in Figure 3-10 on page 82. An additional cable will need to be ordered.

**Important:** Power to the RXE-100 is controlled by the x440, via the interconnect management cable and under the control of the Remote Supervisor Adapter.

### 3.2.4 Serial connections

The x440 does not have an external serial port. If a serial port is required (for example, for UPS remote management), then a USB-to-serial adapter is required, such as the Belkin USB to Serial Adapter (part number 10K3661).

**Restriction:** IBM USB Serial/Parallel Adapter (part number 22P5298) is not supported in the x440.

It is also possible to configure the serial port on the Remote Supervisor Adapter to be sharable between the alerting functions of the adapter and the operating system. However, we recommend that you use a separate serial port.

## 3.3 Storage considerations

When you are planning the storage configuration to accompany the x440, there are important performance and sizing issues that need to be considered.

The two internal hot-swap 1” drive bays will typically be used for operating system installation. We recommended these drives be configured as a two-drive RAID-1 array to provide a higher degree of system availability. Drives up to

15,000 RPM and the converged tray design are supported. To configure RAID-1, a ServeRAID adapter is required. The ServeRAID-4Mx and ServeRAID-4Lx can be used for connection to the hot-swap backplane of the internal drive bays.

**Important:** The ServeRAID-4H is supported in the x440 when used for external storage enclosure connectivity only, because the adapter is too high for the 4U chassis when the internal SCSI connector is in use.

**Note:** The x440 has two cables pre-installed for use with the internal drive bays, but one is not connected. The shorter cable is initially connected from the onboard SCSI to the drive backplane. When you install a ServeRAID adapter for use with the internal drive bays, you will need to disconnect this cable and connect *both ends* of the longer cable. See “Cabling a ServeRAID adapter” in Chapter 2 of the *IBM @server xSeries 440 Installation Guide* for details.

Typically the x440 will be attached to an external disk enclosure for data storage requirements. Some of the supported IBM storage options include:

- ▶ SCSI RAID adapters and storage enclosures
- ▶ Fibre Channel adapters and Storage Area Networks (SANs)
- ▶ Network Attached Storage (NAS)
- ▶ SCSI over IP (iSCSI)
- ▶ IBM Enterprise Storage Server (ESS)
- ▶ ESCON connectivity to a zSeries server

### 3.3.1 xSeries storage solutions

This section discusses some of the available xSeries storage solutions and related technologies, as well as tape backup and performance considerations.

#### ServeRAID with external storage enclosures

The current ServeRAID-4 family of adapters includes the ServeRAID 4H, 4Mx and 4Lx. These 64-bit, Active PCI controllers include advanced features such as Logical Drive Migration, nine RAID levels including RAID 1E, 1E0 and 5E, as well as adapter and cluster failover.

- ▶ ServeRAID-4H features four Ultra160 SCSI channels, 128 MB of removable battery-backed ECC cache memory, and an IBM PowerPC 750 processor onboard. Up to 56 Ultra160 and Ultra2 SCSI devices are supported. (Using 73.4 GB hard disk drives produces 4.11 TB capacity per adapter.)
- ▶ ServeRAID-4Mx features two Ultra160 SCSI channels, 64 MB of battery-backed ECC cache memory, and an Intel i80303 processor. Up to 28 Ultra160 and Ultra2 SCSI devices are supported.

- ▶ ServeRAID-4Lx features one Ultra160 SCSI channel, 32 MB of ECC cache memory, and an Intel i80303 processor. Up to 14 Ultra160 and Ultra2 SCSI devices are supported.

Each ServeRAID adapter supports up to 14 drives (and 160 MB per second throughput) per channel (for an aggregate of up to 56 drives and 640 MBps for the 4-channel ServeRAID-4H adapter, for example). Multiple adapters can be installed as needs and available slots dictate.

- ▶ The EXP300 storage expansion unit has a maximum 1 TB of disk storage (14 73.4 GB drives) in a 3U package, allowing up to 14 expansion units to be used in a standard 42U rack (meaning that a full rack of EXP300 units can hold an amazing 14 TB). The EXP300 provides Predictive Failure Analysis (PFA) on key components, including hot-swap fans, hard drives and redundant power supplies. The EXP300 is optimized for Ultra160 SCSI, with a sustained data transfer rate of 160 MBps.

For more information on IBM SCSI RAID storage solutions go to:

[http://ibm.com/pc/ww/eserver/xseries/scsi\\_raid.html](http://ibm.com/pc/ww/eserver/xseries/scsi_raid.html)

## **IBM Fibre Array Storage Technology**

The IBM Fibre Array Storage Technology (FAStT) family of Fibre Channel storage solutions is designed for high-availability, high-capacity requirements. FAStT solutions can support transfers over distances up to 10 km (6.2 miles) at rates of up to 200 MBps.

The FAStT Storage Server is a RAID controller device that contains Fibre Channel (FC) interfaces to connect the host systems and the disk drive enclosures. The Storage Server provides high system availability through the use of hot-swappable and redundant components. We briefly discuss the following three products:

- ▶ The IBM TotalStorage FAStT200 Storage Server
- ▶ The IBM TotalStorage FAStT500 Storage Server
- ▶ The IBM TotalStorage FAStT700 Storage Server

## **The IBM TotalStorage FAStT200 Storage Server**

The FAStT200 Storage Server is a 3U rack-mountable Fibre Channel RAID controller and disk drive enclosure. It targets the entry and midrange segment of the FC storage market. A typical use of the FAStT200 would be in a two-node cluster environment with up to 30 Fibre Channel disk drives attached to the Storage Server.

Two models are available:

- ▶ The FAStT200 Storage Server, with a single RAID controller.

- ▶ The FAStT200 High Availability (HA) Storage Server, which contains two RAID controllers and can therefore provide higher availability.

Both models feature hot-swap and redundant power supplies and fans and you can install up to 10 slim-line or half-high FC disk drives. If you need to connect more than 10 disks, you can use the EXP500 FC storage expansion enclosures.

Each EXP500 can accommodate 10 additional disk drives, and up to five EXP500s are supported on the FAStT200. This means that the maximum supported number of disk drives is 60.

The use of hot-swappable and redundant components provides high availability for the FAStT200 Storage Server. A fan or a power supply failure will not cause downtime and such faults can be fixed while the system remains operational. The same is true for a disk drive failure if fault-tolerant RAID levels are used. With two RAID controller units and proper cabling, a RAID controller or path failure will not cause loss of access to data.

Each RAID controller has one host and one drive FC connection. The FAStT200 HA model can use the two host and drive connections to provide redundant connection to the host adapters and to EXP500 enclosures. Each RAID controller unit also contains 128 MB of battery-backup cache.

**Tip:** The FAStT200 ships with IBM FAStT Storage Manager 7.10. This version is not supported on the x440. See the following for details:

<http://www.pc.ibm.com/qtechinfo/MIGR-41745.html>

Download the latest version from <http://www.pc.ibm.com/support>.

## The IBM TotalStorage FAStT500 Storage Server

The FAStT500 Storage Server is a 4U rack-mountable Fibre Channel RAID controller device. It provides the levels of performance, availability, and expandability needed to satisfy high-end storage requirements. You would typically use the FAStT500 Storage Server in advanced cluster environments and possibly with heterogeneous operating systems running on the host systems. Another application would be where multiple servers are being consolidated onto one or more x440 systems and there is a requirement to centralize storage for these systems.

The FAStT500 Storage Server features two RAID controller units, redundant power supplies, and fans. All these components are hot-swappable, which ensures excellent system availability. You use the EXP500 external storage expansion enclosures to install the FC disk drives and you can connect up to 22 EXP500 enclosures to the FAStT500. This means a total of up to 220 disk drives.

The enclosures can be connected in a fully redundant manner, which provides a very high level of availability. On the host side FC connections, you can use up to four mini-hubs.

This allows you to establish up to eight host connections without needing an external hub or a switch. For performance and availability, each RAID controller unit contains 256 MB of battery-backed cache and this amount can be further expanded.

### **The IBM TotalStorage FAStT700 Storage Server**

The FAStT700 Storage Server is the newest addition to the FAStT range of products. As with the FAStT 500 Storage Server, you would typically implement the FAStT 700 Storage Server in high-end cluster and server consolidation environments and where multiple servers are being consolidated onto a smaller number of x440 systems.

It is the same physical size as the FAStT500 with new higher performance controllers. These new controllers are 2 Gbps and connect via mini-hubs to the new FAStT FC-2 Host Bus Adapter (HBA) and the new 2109 F16 Fibre Channel switch to give full 2 Gbps fabric.

Like the FAStT500 it attaches to up to 220 FC disks via 22 EXP500 expansion units or up to 224 FC disks via 16 EXP700 expansion units to provide scalability for easy growth (18 GB up to 16 TB using 73 GB drives). To avoid single points of failure, it also features dual hot-swappable RAID controllers, dual redundant FC disk loops, write cache mirroring, redundant hot-swappable power supplies, fans, and dual AC line cords.

Using the new FAStT Storage Manager Version 8.21, it supports FlashCopy, Dynamic Volume Expansion and Remote Mirroring with controller-based support for up to 64 storage partitions. RAID levels 0, 1, 3, 5, and 10 are supported and for performance it includes a total of 2 GB battery-backed cache (1 GB per controller).

**Note:** The FAStT700 is currently the only certified storage solution for the x440 in the 16-way and Microsoft clustered configurations. To check the Microsoft Hardware Compatibility List (HCL) for updates to certified solutions, refer to <http://www.microsoft.com/hcl>.

Additional information on the entire range of FAStT storage solutions can be found at:

<http://www.storage.ibm.com/hardsoft/disk/fastt/index.html>

## Enterprise Storage Server (ESS)

ESS provides integrated caching and RAID support for the attached disk devices. ESS can be configured in a variety of ways to provide scalability in capacity and performance. One ESS can support in excess of 28 TB and can utilize 2 Gbps Fibre Channel connectivity.

Redundancy within ESS provides continuous availability. It is packaged in one or more enclosures, each with dual line cords and redundant power. The redundant power system allows ESS to continue normal operation when one of the line cords is deactivated.

ESS provides an image of a set of logical disk devices to attached servers. The logical devices are configured to emulate disk device types that are compatible with the attached servers. The logical devices access a logical volume that is implemented using multiple disk drives. This allows ESS to connect to all IBM servers, from zSeries to iSeries, pSeries and xSeries, directly or through a SAN, thus helping the x440 fit into a heterogeneous environment containing a variety of server architectures. ESS offers several choices of host I/O interface attachment methods, including SCSI and Fibre Channel for xSeries.

For more information on the ESS go to:

<http://www.storage.ibm.com/hardsoft/products/ess/index.html>

### 3.3.2 Disk subsystem performance

Because of the processing capacity of the x440, a poorly designed storage subsystem could become a bottleneck, seriously impacting overall system performance. You should implement a disk subsystem that is able to efficiently process the potentially massive number of disk I/O requests generated by the processor subsystem.

Assuming that you will be implementing a RAID storage configuration, the rule of thumb is that more physical disks will improve the throughput of your disk subsystem and consequently overall system performance. In almost all applications, adding disks to your RAID configuration will continue to improve performance until another system component becomes a bottleneck. A storage solution with too few physical disks will become a bottleneck for the entire system.

You will need to carefully analyze your storage capacity requirements, your application requirements, and your host requirements before you finalize your storage solution.

A detailed discussion on performance tuning disk subsystems in xSeries servers is available in the redbook *Tuning IBM eServer xSeries Servers for Performance*, SG24-5287.

### 3.3.3 Tape backup

As with your disk subsystem, you need to carefully analyze backup requirements before a tape solution is selected. Considerations when selecting a backup solution should include:

- ▶ Currently implemented backup solutions  
If you are consolidating a number of servers onto a single x440 solution, for example, you may want to take the opportunity to move from differing and distributed tape technologies (such as DDS and DLT) and consolidate those into a single, high-performance, automated solution. An example is the IBM Ultrium Autoloader.
- ▶ Current and projected capacity requirements  
Select a solution that has the ability to scale as capacity requirements increase.
- ▶ Performance requirements  
You need to consider the backup window available, as well as the amount of data being backed up when determining what your backup performance requirements will be. It is also important to consider the need for quick access to data committed to tape when selecting a solution.
- ▶ Connection requirements  
Will the tape solution be connected to an existing SAN fabric and if so, will this require additional fabric hardware?
- ▶ Hardware and software compatibility  
If you implement a new tape solution, you need to ensure that current backup and management software is still suitable. Disaster recovery procedures may also need to be revised.

IBM offers a full range of high-performance, high-capacity and automated tape solutions for xSeries servers. For detailed information on these products, go to:

<http://ibm.com/pc/ww/eserver/xseries/tape.html>

**Note:** The x440 and RXE-100 support 3.3 Volt PCI adapters only. Make sure any SCSI adapters you use to connect your tape subsystem are 3.3 V or dual voltage adapters.

The following redbooks discuss IBM tape solutions in greater detail:

- ▶ *Netfinity Tape Solutions*, SG24-5218
- ▶ *The IBM LTO Ultrium Tape Libraries Guide*, SG24-5946

## 3.4 Server partitioning and consolidation

The concepts of server partitioning and consolidation are discussed in detail in Chapter 2, “Positioning” on page 35.

Implementing a server consolidation solution using VMware and the x440 introduces a number of important and unique issues that you need to consider during the planning phase of your project.

In particular the x440 configuration needs to be carefully sized to meet the resource requirements of the VMware operating system, the guest operating systems, and the applications being deployed.

A detailed discussion on planning, sizing, and implementing VMware solutions on the x440 can be found in the redbook *Server Consolidation with the IBM @server xSeries 440 and VMware ESX Server*, SG24-6852.

## 3.5 Operating system considerations

In line with the overall message of providing application flexibility to meet the varying needs of our enterprise customers, the x440 is optimized for numerous operating system and application solutions. For the latest operating system support information, go to:

<http://www.pc.ibm.com/us/compat/nos/matrix.shtml>

As described in 1.4.1, “Intel Xeon Processor MP” on page 13 Hyper-Threading technology allows a single physical processor to appear to the operating system and applications as two logical processors. The logical processors share the core processing engine of the physical processor but are able to execute code streams concurrently.

Operating systems must be “Hyper-Threading aware” before they can “see” the additional processors. When they are, they will “see” twice as many CPUs as there really are (see Figure 4-8 on page 118 for an example).

Simply enabling Hyper-Threading may not guarantee improved overall system performance, however. In order to benefit from enabling Hyper-Threading, the operating system and server applications need to be capable of detecting the



additional logical processors and spawning multiple threads, which can exploit the additional processing power.

As well as considering whether the operating system you are installing supports Hyper-Threading, there may be licensing implications to consider before enabling Hyper-Threading technology.

For a more detailed discussion on Hyper-Threading technology, refer to:

[http://www.intel.com/eBusiness/products/server/processor/xeon/wp020901\\_sum.htm](http://www.intel.com/eBusiness/products/server/processor/xeon/wp020901_sum.htm)

Table 3-2 lists the supported operating systems for the x440 and the level of support for Hyper-Threading technology provided by the operating system.

In the column titled Hyper-Threading Support:

- ▶ **None** indicates the operating system does not recognize the logical processors that Hyper-Threading enables.
- ▶ **Yes** indicates that the operating system recognizes the logical processors and can execute threads on them but is not optimized for Hyper-Threading.
- ▶ **Optimized** indicates that the operating system recognizes the logical processors and the operating system code has been designed to fully take advantage of the technology.

*Table 3-2 x440 operating system support*

Description	Release	SMP support <sup>1</sup>	Hyper-Threading support
Windows 2000 Server	SP2/3	Supports up to four-way	Yes
Windows 2000 Advanced Server	SP2/3	Supports up to eight-way	Yes
Windows 2000 Datacenter Server	SP3	Supports up to 32-way <sup>2</sup>	Yes
Windows NT Enterprise Edition	4.0	Only supports four-way on the x440 Hot-plug PCI not supported	None
Windows .NET Server	1Q/03	Supports up to two-way	Optimized
Windows .NET Enterprise Server	1Q/03	Supports up to eight-way	Optimized
Windows .NET Datacenter Server	1Q/03	Supports up to 32-way <sup>2</sup>	Optimized
NetWare	6.0	Supports up to 32-way <sup>2, 3</sup>	Yes
Red Hat Linux Advanced Server	2.1	Supports up to eight-way <sup>4</sup>	Yes
SuSE Linux Enterprise	8.0	Supports up to eight-way <sup>4</sup>	Yes

Description	Release	SMP support <sup>1</sup>	Hyper-Threading support
VMware ESX Server	1.5	Supports up to 16-way Supports up to one processor per VM <sup>5</sup>	None

**Notes to Table 3-2:**

1. While operating systems may support eight-way or larger systems, scalability is a function of both the operating system and the application/workload. Few applications are designed to take advantage of larger SMP systems.
2. x440 configurations with 16 processors and Hyper-Threading enabled are seen as 32 processors under Windows 2000 Datacenter and Windows .NET. Licensing of processors in Windows 2000 is based on physical and logical processors combined, whereas Windows .NET licensing is based on physical processors.
3. NetWare notes:
  - NetWare 5.1 is currently not supported, but it should still install. See RETAIN tip H176163 for details on a known shutdown problem:  
<http://www.pc.ibm.com/qtechinfo/MIGR-43679.html>
  - With NetWare 6.0, the server may show extreme CPU utilization values (for example, 13000%). This will be fixed with NetWare 6.0 Support Pack 2. See RETAIN tip H176060 at:  
<http://www.pc.ibm.com/qtechinfo/MIGR-43532.html>
  - Once supported a multi-chassis configuration must be fully assembled before installing NetWare. Novell doesn't currently support adding chassis after NetWare is installed.
4. Ongoing work will improve both Linux and key application scalability. Currently, the general recommendation is to keep system size limited to eight-way and below, and 16 GB and below. Work on scalability beyond eight-way is in progress, and is likely to become available in early to mid-2003.
5. VMware ESX Server 1.5 allows eight virtual machines per processor. However, a virtual machine (VM) can consist of no more than one processor. 16-way support will require Version 1.5.1.

### 3.5.1 Windows 2000 Datacenter Server

Windows 2000 Datacenter Server is a highly scalable network operating system designed for mission-critical enterprise-wide applications. High-volume online

transaction processing, large-scale data warehousing, and scientific simulations are some of the applications that Datacenter is optimized for.

Datacenter Server features include:

- ▶ Support for 32 processors
- ▶ Supports up to 32 GB of memory
- ▶ Four node cluster support
- ▶ Supports Network Load Balancing (NLB) with a maximum 32 nodes
- ▶ Supports WinSock Direct high-speed inter-process communications

Datacenter Server will initially be supported on four-way and eight-way x440 configurations in one, two, three, and four cluster node configurations and on a 16-way configuration in a one cluster node configuration.

The IBM Datacenter Solution includes Microsoft-certified hardware, the Windows Datacenter Server operating system, and a set of standard and optional services, the latest of these being a Software Update Subscription, to provide updates designed to keep the Datacenter Solution at the latest levels.

The subscription for an eight-way configuration is 4816-ABX, and for 16-way, 4816-ADX.

The Software Update Subscription provides periodic updates to the Windows 2000 Datacenter operating system, which you license for a period of one year. This subscription also includes IBM updates to firmware and device drivers certified by Microsoft for use with the Datacenter solution. IBM builds, tests, and provides the complete certified package of these components.

The complete Datacenter Solution Program can be found at:

<http://www.pc.ibm.com/ww/eserver/xseries/windows/datacenter.html>

### **Datacenter eight-way configuration**

Two installation options are currently available for Datacenter Server on the x440.

- ▶ Option 1: Factory installation. Table 3-3 shows the available x440 eight-way Datacenter models.

Table 3-3 Factory configurable eight-way Datacenter Server models

Model	Standard processors	Max SMP	L2 cache	L3 cache	Std memory
8687-1AX	2x 1.4 GHz Intel Xeon MP	8-way	256 KB	512 KB	0 GB(*)
8687-2AX	2x 1.5 GHz Intel Xeon MP	8-way	256 KB	512 KB	0 GB(*)
8687-3AX	2x 1.6 GHz Intel Xeon MP	8-way	256 KB	1 MB	0 GB(*)
(*) Memory/storage and options for Datacenter models will be included as defined by customer requirements through the Special Bid process.					

**Note:** All AX models are to be ordered via an IBM Special Bid process, and all Datacenter solutions require an IBM Solutions Assurance Review, to ensure compliance with the Datacenter certified solution.

► Option 2: Software-only preload kit.

This CD-ROM kit allows a customer to install Datacenter Server on an existing x440 configuration that is already certified for use with Datacenter Server.

The eight-way preload kit, 4816-1BX, contains:

- Windows 2000 Datacenter Server
- License entitlement for up to eight processors
- Device drivers and firmware updates, which have been tested to support the Datacenter solution on certified xSeries 440 configurations
- System documentation and recovery CD-ROMs

Customers should also purchase the annual Software Update Subscription for eight-way Datacenter Server, 4816-ABX.

### Datacenter 16-way configuration

The 16-way configurations are comprised of two eight-way Datacenter Server systems as described in Table 3-3 on page 94.

**Note:** The x440 16-way fixed configuration for Datacenter Server will initially only be supported in a stand-alone configuration, not in a cluster. Check for updates to the Microsoft Hardware Compatibility List (HCL) at:

<http://www.microsoft.com/hcl/default.asp>

Datacenter 16-way fixed configurations can be achieved in two ways:

► New Datacenter configuration

Customers can purchase the complete solution directly from IBM through the Special Bid program, or through the EXAct Business Partner program.

When using the Special Bid program, IBM will perform an expert Solutions Assurance Review. If the solution is obtained through a Business Partner, they will perform this review.

► Datacenter Upgrade Path

Upgrades to x440 16-way fixed configuration Datacenter can be accomplished in two ways:

- Option 1: Customers who already have a Windows 2000 Advanced Server on an 8687-1RX, 2RX, 3RX, can upgrade to Datacenter by doing the following:
  - Upgrade the system to meet Datacenter HCL
  - Add a second RX model (also meeting Datacenter HCL criteria) or AX model
  - Add the 1-16 processor License Kit, model number 4816-1DU
  - Add the Software Update Subscription, model number: 4816-ADX
  - Add RAM so the total memory is 8 GB (4 GB in each system)
- Option 2: Customers who already own an eight-way Datacenter configuration (Table 3-3 on page 94) can upgrade to 16-way by doing the following:
  - Add second RX (also meeting Datacenter HCL criteria) or AX model
  - Add the 9-16 processor License Kit, model number 4816-12U
  - Add the Software Update Subscription, model number: 4816-ADX
  - Add RAM so the total memory is 8 GB (4 GB in each system)

**Notes:**

- All processors must be identical for 16-way configurations.
- A minimum of 8 GB of RAM must be installed in each x440.

All x440 16-way Datacenter Server configurations also require a Support Line contract or maintenance agreement.

### 3.5.2 Microsoft Windows NT 4.0 Enterprise Edition

Hyper-Threading is not supported by Windows NT 4.0 EE, which has not been enhanced to exploit Intel's ACPI. This operating system is therefore unable to recognize logical processors, which are simply ignored. The eight logical

processors in an x440 are viewed exactly the same as eight processors in an x370.

There are no plans from Microsoft to patch Windows NT 4.0 Enterprise Edition to support Hyper-Threading technology.

A custom Hardware Abstraction Layer (HAL) must be installed during the operating system installation and is available from IBM. The HAL is required to support the Active PCI-X slots in the server and the RXE-100. Download it from:

<http://www.pc.ibm.com/qtechinfo/MIGR-42067.html>

### 3.5.3 Microsoft Windows 2000 Server

The members of the Windows 2000 server family support Hyper-Threading, but they have not been optimized for it. They use a custom Hardware Abstraction Layer (HAL), which is based on Service Pack 2. This HAL should be installed during the operating system installation. It is available from IBM at:

<http://www.pc.ibm.com/qtechinfo/MIGR-42325.html>

Refer to “Installing the x440 Windows 2000 custom HAL” on page 112 for detailed instructions on installing the HAL.

From a licensing point of view, logical processors as provided by Hyper-Threading are counted against the Windows licensing limit. Windows will first count physical processors and, if the license permits more processors, then logical processors will be counted. For example, in a four-way x440, Windows 2000 Server will count four physical processors, then stop, because Server is limited to four processors. In the same x440, Advanced Server will count eight processors (four physical and four logical) because the license permits up to eight processors.

**Eight-way systems:** If the server has eight CPUs installed, then you must ensure Hyper-Threading is disabled in BIOS before installing Windows 2000 Advanced Server. You can re-enable Hyper-Threading after Service Pack 2 or later is installed. If you do not disable Hyper-Threading during installation, a blue screen trap will occur.

Windows 2000 Advanced Server supports a maximum of eight CPUs, so there is no performance benefit to be gained from enabling Hyper-Threading on an eight-way Advanced Server system.

### 3.5.4 Microsoft Windows .NET Server

Microsoft is adding “NUMA enhanced” CPU-affinity code and Hyper-Threading optimization to maximize the performance of XpandOnDemand NUMA-based servers such as the x440.

Windows .NET Server operating systems will understand the concept of physical processors versus logical processors. In the case of Windows .NET Server, only physical processors will count against the license limit. Although a Windows .NET Standard Server (limited to two processors) running on a two-way system with Hyper-Threading enabled will recognize and utilize the processing capabilities of four logical processors, only two physical processors will be counted for licensing purposes.

### 3.5.5 Novell NetWare

IBM is working with Novell's NetWare technology team (NetWare V6.0 and Modesto 32/64-bit) and its one Net strategy to take full advantage of the capabilities of IBM Enterprise X-Architecture technology. Novell will support high scalability (32 processors x 32 nodes per cluster), large memory (64 GB), Active PCI-X hot swap/hot-add, the Xeon Processor MP (including Hyper-Threading and xAPIC), non-uniform memory addressing (NUMA), Remote I/O, and system partitioning (static and dynamic) in all forms. Support for many of these technologies exists today, with others to be added in future support packs or operating system updates.

Refer to 4.3.3, “NetWare installation” on page 121 for more detailed information on installing NetWare on the x440.

**Important:** Once supported multi-node configurations must be assembled before installing NetWare. Novell doesn't currently support adding chassis after NetWare is installed.

### 3.5.6 Red Hat/SuSE Linux

Red Hat Linux Advanced Server 2.1 and SuSE Linux Professional 8.0 are architected to exploit the capabilities of the x440 server, including the support for Hyper-Threading technology. The most recent version of the Linux 2.4.x kernel scales effectively to four-way and eight-way, although results vary depending on the workload and the scalability of the application.

The xSeries development team, the IBM Linux Technology Center, and other parts of IBM are working with the Linux community, Red Hat, SuSE, and other Linux alliance partners to develop advanced Enterprise X-Architecture features in upcoming releases of Linux. These features will include memory optimization, additional hot-swap/hot-add capabilities, dynamic partitioning, and additional scalability improvements.

Refer to 4.3.2, “Red Hat Linux installation” on page 119 for more detailed information on installing Linux on the x440.

### 3.5.7 VMware ESX Server

VMware ESX Server is virtual machine software for consolidating and partitioning servers. It is a cost-effective, highly scalable virtual machine platform with advanced resource management capabilities. VMware ESX Server is used to minimize the total cost of ownership (TCO) of server infrastructure by maximizing server manageability, flexibility, and efficiency across the enterprise.

There are three 16-way ESX Server models currently (or soon to be) available:

*Table 3-4 New models for the 16-way fixed configurations running VMware ESX Server*

Model	Standard processors	L2 cache	L3 cache	Std memory
8687-4RX	16 x 1.4 GHz Intel Xeon MP	256 KB	512 KB	8 GB(*)
8687-5RX	16 x 1.5 GHz Intel Xeon MP	256 KB	512 KB	8 GB(*)
8687-6RX	16 x 1.6 GHz Intel Xeon MP	256 KB	1 MB	8 GB(*)
(*) Extra memory/storage and options will be included as defined by customer requirements through the Special Bid process.				

These models also have a ServeRAID-4Mx adapter installed as standard.

ESX Server works by letting you transform physical computers into a pool of logical computing resources. Physical servers are partitioned into secure virtual servers. Operating systems and applications are isolated in these multiple virtual servers that reside on a single piece of hardware. These resources can then be distributed to any operating system or application as needed.

ESX Server provides dynamic logical partitioning. It runs directly on the hardware to partition and isolate server resources, using advanced resource management controls to let you remotely manage, automate, and standardize these server resources.



Dynamic logical partitioning involves:

- ▶ Partitioning server resources

The ESX Server acts as the host operating system, provides dynamic logical partitions to hold other operating systems, and virtualizes most system resources, including processors, memory, network capacity, and disk controllers.

- ▶ Isolating server resources

With ESX Server, each hosted operating system thinks it owns the entire computer, yet it sees only the resources that the administrator (through ESX Server) assigns to it. As shown in Figure 3-11 on page 99, ESX Server resides between the hardware and the various operating systems and applications. Partitions can be administered remotely, even down to the BIOS level, just as individual servers are.

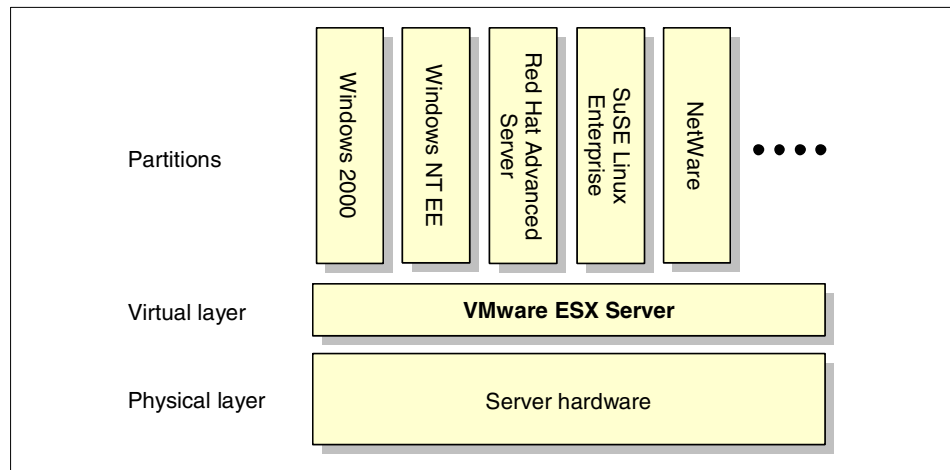

Figure 3-11 ESX Server resides between the server hardware and server resources

- ▶ Managing server resources

The ESX Server's advanced resource management controls allow you to guarantee service levels. CPU capacity can be allotted on a time-share basis. Memory can be assigned dynamically based on partition workloads and defined minimums. If the allocated amount is insufficient in one partition, ESX Server can temporarily borrow memory from one partition and lend it to another, and then restore it to the original partition when needed. Network sharing is determined by token allocation or consumption based on the average or maximum bandwidth requirements for a partition.

Currently ESX Server does not support Hyper-Threading technology. For support information including supported servers, see:

<http://www.pc.ibm.com/ww/eserver/xseries/vmware.html>

For more information on VMware, refer to the redbook *Server Consolidation with the IBM @server xSeries 440 and VMware ESX Server*, SG24-6852.

## 3.6 Application considerations

As well as operating systems, there are enterprise applications currently available that are licensed on a per-processor basis. You should be aware that enabling Hyper-Threading or adding physical processors on systems running these applications may have licensing implications for your organization. This will need to be considered in the planning phase of your deployment and, if required, additional licenses purchased prior to enabling Hyper-Threading.

Microsoft has stated that current server products licensed on a per-processor basis will require one license per physical processor. For example, on a two-way system with Hyper-Threading enabled and running Microsoft SQL Server, a two-processor license is required, even though the application may process threads on four logical processors.

Performance benefits versus licensing costs may be a consideration before enabling Hyper-Threading or adding processors and may require testing to confirm that there will be a substantial benefit to application performance. In most applications there will be a performance gain as processors are added; however, this gain does not generally remain linear with the continued addition of processors. The performance improvements seen will depend largely on application scalability, which is discussed in more detail in the next section.

### 3.6.1 Scalability and performance considerations

Adding processors improves server performance because software instruction execution can be shared among the additional processors. However, this requires software to detect the additional CPUs and generates additional work in the form of threads or processes, which execute on the additional processors. This does not happen automatically. The operating system provides a platform that enables the capability of multiprocessing, but it is up to the application to generate the additional threads and processes to execute on all processors. This is referred to as *application scalability*.

Having faster machines in the server hardware space means more parallelism (more processors, larger memory, larger disk arrays, additional PCI buses, and so on). The obvious case of software that does not scale is DOS. Run DOS on a server with eight CPUs, 16 GB of memory, equipped with 250 15K RPM disks in RAID arrays, and you get the same performance as if you have one CPU, one disk, and 640 KB of memory. Obviously, the server isn't slow. The problem is that the software (in this case DOS) does not scale.

Software scalability is a complex subject, one most people don't consider until it is too late. Often people purchase new high-performance SMP servers expecting huge performance gains with old applications, only to learn the bottleneck is in the server application. In this case there is little they can do to efficiently utilize the new SMP server until the application is modified.

A scalable application makes use of greater amounts of memory, generates scalable I/O requests as the number of disks in a disk array increases, and will utilize multiple LAN adapters when a single LAN adapter limits bandwidth. In addition, a scalable application has to detect the number of installed processors and spawn additional threads as the number of processors increases to keep all processors busy.

Hyper-Threading increases the number of logical processors and demands that the software spawn additional threads to run at maximum efficiency. However, most applications don't yet do this. This is why Hyper-Threading performs well with two-way and four-way SMP systems, because many applications already generate sufficient threads to keep four physical/logical CPUs busy. But at eight-way and 16-way, the applications have to do even more than they do today to efficiently utilize Hyper-Threading. All of these things must be engineered into the server application and operating system. In general, the only applications that scale past four-way are database applications.

### **3.6.2 SMP and server types**

SMP has a direct relationship to the type of application server being used. If the server is used as a file server, adding a processor to a file server does not significantly improve performance, whereas it can result in a very high performance gain for an application server.

As you can see from Figure 3-12, a file/print server benefits only marginally from the addition of a second processor and can actually degrade performance when the third and fourth processors are added. However, with a database or application server, the addition of one to three processors makes a marked improvement in processing power.

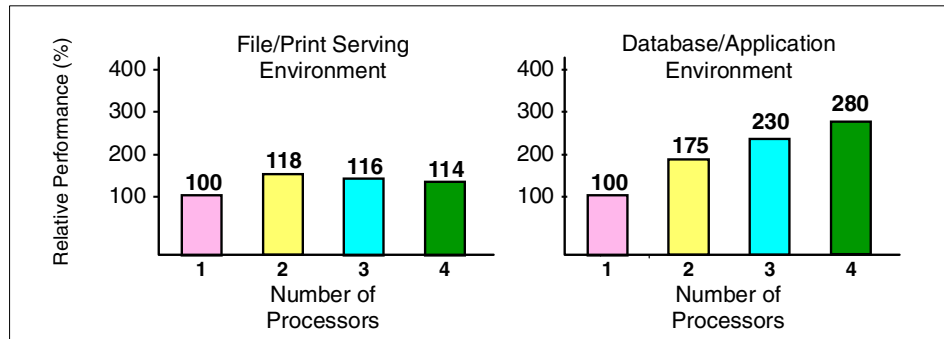

Figure 3-12 Effect of adding processors under file/print and application environments

SMP will not provide a linear improvement in processing power as additional processors are added. You might achieve a 70-90% performance increase from the second processor, but each additional processor after the second will provide a diminishing return on investment as other system bottlenecks come into play.

For more information regarding multiprocessor systems and performance tuning xSeries servers, refer to the redbook *Tuning IBM @server xSeries Servers for Performance*, SG24-5287.

For performances results of four-way and eight-way x440s running SAP and TPC-C benchmarks, see:

<http://www.pc.ibm.com/ww/eserver/xseries/benchmarks/series.html>

## 3.7 Rack installation

The x440 is 4U in height and is intended for use as a rack-drawer server. Due to power distribution considerations, it is recommended that no more than eight 4U x440 chassis be installed in a single 42U rack, leaving 10U available for RXE-100 Remote I/O enclosures, disk or tape storage, or other devices.

The x440 is 27.5" deep, and is designed to be installed in a 19-inch rack cabinet designed for 28" deep devices, such as the NetBAY42 ER, NetBAY42 SR, or NetBAY25 SR. Although the x440 system is rack optimized, it may be converted into a tower by installing it in a NetBAY11 SR Standard Rack Cabinet. The NetBAY11 rack supports shipment of fully configured xSeries 440 and other rack-optimized xSeries servers.

Installation considerations include the following:

- ▶ The system is not designed to run vertically, and therefore must always be run in a horizontal position.

- ▶ For thermal considerations, the x440 must be installed with perforated doors on both front and back. Do not install the x440 in a rack with a glass front door.
- ▶ Although installation is supported in non-enterprise racks, it is not recommended, since cable management then becomes an issue.
- ▶ The maximum weight of the system, depending on your configuration, is 50 kg (110 lb.). Therefore, this system requires two people to install it in a rack.

If you use a non-IBM rack, the cabinet must meet the EIA-310-D standards with a depth of at least 28 inches. Also, adequate space (approximately two inches for the front bezel and one inch for air flow) must be maintained from the slide assembly to the front door of the rack cabinet to allow sufficient space for the door to close and provide adequate air flow.

Make sure all the cables attached to the x440 are long enough to permit the server to be slid out of the rack. This would include the normal cables such as power, network, and fiber cables, but also includes the Remote I/O cable for connecting to the RXE-100 and the SMP expansion cables for connecting to another x440. See “Remote Expansion Enclosure” on page 78 for RXE-100 cabling information.

Since the x440 is rack optimized, the IBM xSeries rack configurator should be used to ensure correct placement. The configurator can be downloaded from:

- ▶ For EMEA: <http://www.pc.ibm.com/europe/configurators/>
- ▶ For USA:  
<http://www.pc.ibm.com/us/eserver/xseries/library/configtools.html>
- ▶ For other countries or regions:
  - a. Go to <http://www.ibm.com>
  - b. Click **Select a country**
  - c. Select your country
  - d. Click **Products and Services**
  - e. Click **Intel-based servers**
  - f. Click **Tools**
  - g. Scroll down to find the Rack Configurator section

## 3.8 Power considerations

The x440 ships with two redundant, hot-swappable power supplies that produce 1050 W each at 220 V, or 550 W each at 110 V. When the x440 is populated with more than two processors, memory, and adapters, the power supplies may not be redundant if they are connected to a 110 V power source.

Therefore, IBM recommends that the x440 be connected to a 220 V power source to ensure power supply redundancy for large configurations.

**Tip:** If power is not redundant, the Nonredundant LED will be lit in the Light Path Diagnostic panel (see Figure 1-14 on page 26).

Two system power-cord connectors are available on the back of the x440, one for each of the power supplies. Connect each of these power connectors to separate power circuits to ensure availability if one circuit should fail.

The x440 ships with two 2.8 m/9 ft. IEC 320-C13 to IEC 320-C14 power cables for intra-rack power distribution. Models shipped in the US also include two 2.8 m/9 ft. IEC 320-C13 to NEMA 6-15P power cords for attachment to high-voltage power sources.

## 3.9 Solution Assurance Review

Some level of Solution Assurance Review (SAR) should be performed for all IBM solutions. The level of SAR (self, peer, or expert) should match the complexity of the solution. For example, simpler solutions may need only a self review. However, a combination of the customer environment risk combined with the complexity of the solution may require that an expert level SAR take place, facilitated by a Quality Assurance practitioner and supported by a team of technical experts.

**Note:** The EXAct Business Partners themselves may be required to perform the Solutions Assurance Review.

If a solution contains four or more Enterprise X-Architecture servers (currently x360 and x440), then an expert SAR is mandatory.

For further information on what is required, refer to the above Solution Assurance Web sites. EMEA and Americas information is available. Procedures for Asia Pacific countries are currently in development.

### Trigger Tool

The SAR Trigger Tool provides a recommendation on the level of quality/Solution Assurance that will be required. It is available from one of the URLs above.

The three levels are:

- ▶ Expert
  - For technically challenging, high-risk solutions

- Process dictates expert personnel's participation
- Formal, rigorous
- ▶ Peer
  - For low-to-medium-risk solutions
  - Informal, inexpensive
- ▶ Self
  - For low-risk solutions
  - Informal, inexpensive

### **eSAR — Electronic Solution Assurance Review**

There is also an eSAR tool available to help you establish whether you require an expert review. This is available from:

- ▶ For IBM employees: <http://w3.ibm.com/support/assure>, then click **eSAR**
- ▶ For Business Partners: <http://www.ibm.com/support/assure/esar>







# Installation

In this chapter we describe procedures specific to the installation of Windows 2000, Linux, Novell NetWare and VMware operating systems on the x440 platform. Topics covered include:

- ▶ System BIOS settings
- ▶ Device drivers
- ▶ Operating system installation
- ▶ Additional Information

Prior to commencing installation, you need to download the latest firmware and drivers. These are all available from the x440 driver matrix at:

<http://www.pc.ibm.com/qtechinfo/MIGR-39747.html>

## 4.1 System BIOS settings

This section describes system BIOS settings that you may need to configure prior to installing an operating system.

### 4.1.1 Updating BIOS and firmware

We recommend you check the BIOS and firmware levels on the items listed below and update to the most current revision, as part of your installation procedure for the x440:

- ▶ System BIOS
- ▶ Remote Supervisor Adapter firmware and BIOS
- ▶ Onboard diagnostics
- ▶ Additional devices if installed, such as ServeRAID adapters and FASTT Fibre Channel host adapters.

The latest BIOS and firmware code can be found at:

<http://www.pc.ibm.com/qtechinfo/MIGR-39747.html>

Follow the installation instructions provided with each package.

### 4.1.2 Enabling memory mirroring

Memory mirroring (part of IBM's Active Memory technology) provides an additional level of fault tolerance to the memory subsystem. For detailed information and guidelines on memory mirroring, see 3.1.2, "Memory" on page 65.

To enable memory mirroring on the x440, perform the following steps:

1. Press F1 when prompted during system startup to enter the System Configuration Utility.
2. From the main menu select **Advanced Setup -> Memory Settings -> Memory Mirroring Settings**. Figure 4-1 on page 109 appears.

If you have two SMP Expansion Modules installed, you will see two options:

- CEC 1, which corresponds to the bottom SMP Expansion Module
- CEC 2, which corresponds to the top SMP Expansion Module

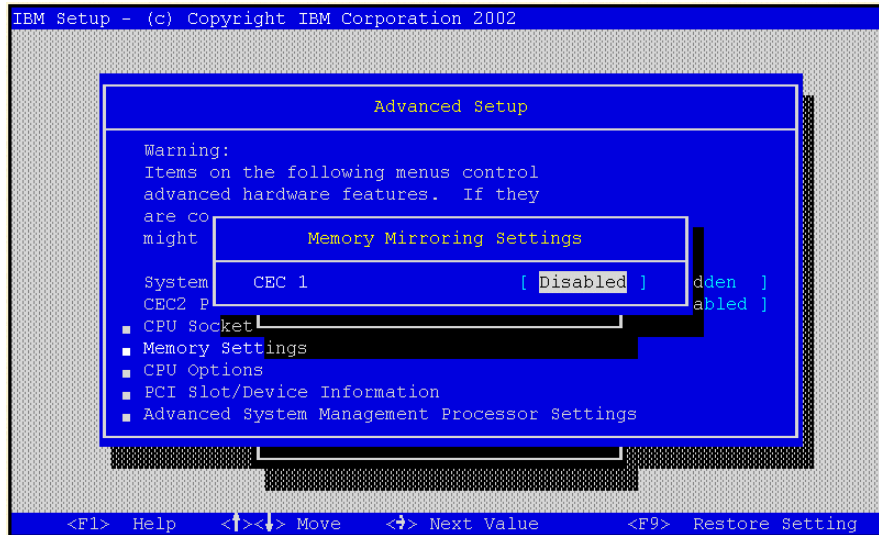

Figure 4-1 Enabling memory mirroring

3. Select the SMP Expansion Module you want memory mirroring enabled on and press the right arrow key to change the value to Enabled.

**Tip:** In a server with two SMP Expansion Modules installed, it is possible to enable memory mirroring in only one SMP Expansion Module; however, we do not recommend this configuration.

4. Exit the System Configuration Utility and save any changes.
5. Once memory mirroring is enabled, you will see the following message during POST:

Active Memory(tm) Mirroring enabled on CEC1

### 4.1.3 Enabling Hyper-Threading

Hyper-Threading technology allows a single processor to execute two separate instruction threads concurrently, effectively operating as two separate logical processors. The installed operating system sees these logical processors as two separate physical processors. This is demonstrated in Figure 4-8 on page 118.

There are a number of important factors to consider before enabling Hyper-Threading. These considerations are discussed in detail in 3.5, "Operating system considerations" on page 90. It is important to fully understand the

configuration rules, performance issues and potential licensing implications related to Hyper-Threading before you proceed.

**Eight-way systems:** Hyper-Threading is disabled by default on the x440. This is because of a known bug in Windows 2000 Advanced Server. If Hyper-Threading is enabled on an eight-way server, then the Windows 2000 Advanced Server will trap (blue screen) during installation. This problem does not affect other supported operating systems. You can enable Hyper-Threading on an eight-way Advanced Server system after Service Pack 2 or later has been installed.

Windows 2000 Advanced Server supports a maximum eight processors. There is no performance benefit to be gained from enabling Hyper-Threading on an eight-way Advanced Server system.

To enable Hyper-Threading on the x440, do the following:

1. Press F1 during system startup to enter the System Configuration Utility.
2. From the main menu, select **Advanced Setup -> CPU Options**. Figure 4-2 appears.

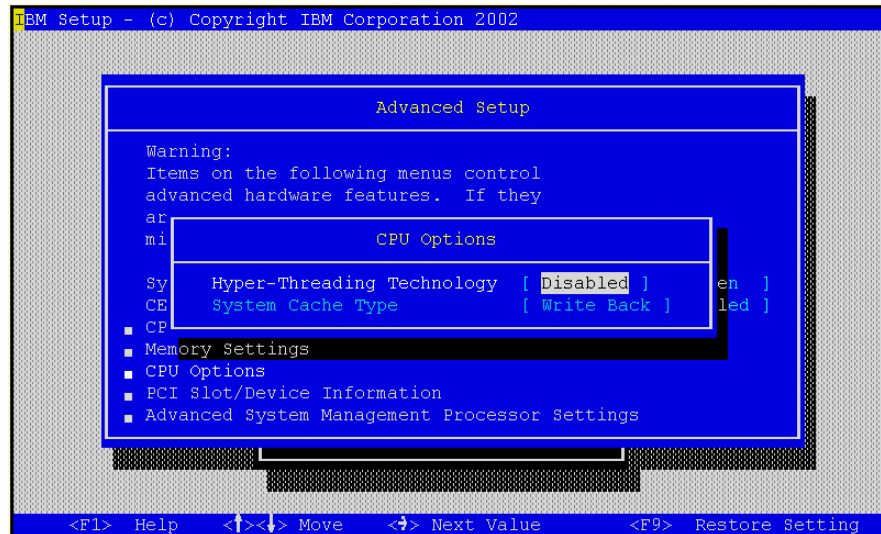

Figure 4-2 Enabling Hyper-Threading

3. Change the Hyper-Threading Technology setting to Enabled.
4. Exit the System Configuration Utility saving changes.

**Important:** The procedures and menu items described above may change as BIOS levels are revised.

## 4.2 Device drivers

Specific device drivers are available for the x440 that may not be included with the base operating system.

Drivers that you should obtain separately from the operating system include:

- ▶ Broadcom Ethernet controller
- ▶ Active PCI-X controller
- ▶ Remote Supervisor Adapter management processor
- ▶ S3 Savage4 LT video controllers
- ▶ ServeRAID

The required drivers as well as the latest versions of BIOS, service processor firmware, and diagnostics firmware are available from:

<http://www.pc.ibm.com/qtechinfo/MIGR-4JTS2T.html>

If you are implementing Microsoft Cluster Service (MSCS) check the Microsoft Cluster Service Hardware Compatibility List (HCL) to confirm that hardware, drivers and firmware have been Microsoft Certified. The HCL can be found at:

<http://www.microsoft.com/hcl/default.asp>

## 4.3 Operating system installation

This topic will discuss the installation of the following operating systems on the x440 hardware platform:

- ▶ Windows 2000 Server and Advanced Server
- ▶ Red Hat Linux
- ▶ Novell NetWare

In the following discussions we assume that disk subsystems, such as RAID arrays, for both operating system installations and data storage have been configured.

### 4.3.1 Microsoft Windows 2000 Server and Advanced Server

**Eight-way systems:** If the server has eight CPUs installed, then you must ensure Hyper-Threading is disabled in BIOS before installing Windows 2000 Advanced Server. You can re-enable Hyper-Threading after Service Pack 2 or later is installed. If you do not disable Hyper-Threading during installation, a blue screen trap will occur.

Windows 2000 Advanced Server supports a maximum eight processors. There is no performance benefit to be gained from enabling Hyper-Threading on an eight-way Advanced Server system.

Before commencing the installation of Windows 2000 Server or Advanced Server, ensure that BIOS and firmware levels have been updated to the latest levels. Refer to “Updating BIOS and firmware” on page 108.

Refer to 4.2, “Device drivers” on page 111 for information on device drivers required for the installation of Windows 2000 Server and Advanced Server.

If you are connecting an RXE-100 enclosure to the system, complete the operating system installation before connecting the RXE-100. For more information on connecting the RXE-100, refer back to “3.2.3, “Remote Expansion Enclosure” on page 78”.

#### **Installing the x440 Windows 2000 custom HAL**

When installing Microsoft Windows 2000 Server, Advanced Server or Datacenter Server on the x440 server, a customized Hardware Abstraction Layer package is required. The customized HAL enables Windows 2000 to operate with the extended CPU and PCI configurations that are possible in the x440 system.

The custom HAL for Windows 2000 Server and Advanced Server can be downloaded from:

<http://www.pc.ibm.com/qttechinfo/MIGR-42325.html>

When the file has been downloaded, run the executable and extract the files to a formatted diskette. The HAL for Windows 2000 Datacenter Server is supplied on the CD-ROMs.

To install Windows 2000, do the following:

1. Power on the x440 with bootable Windows 2000 Server or Advanced Server CD in the CD-ROM drive.
2. When prompted, press any key to boot from the CD.

3. When you see the following message, immediately press F5:  
Setup is inspecting your computer's hardware configuration...  
If you plan to install the operating system on disks attached to a ServeRAID controller, press F6 at this point so that you will be prompted to install the ServeRAID driver as well.
4. When you are prompted to select the Computer Type, as shown in Figure 4-3, select **Other** and press Enter.

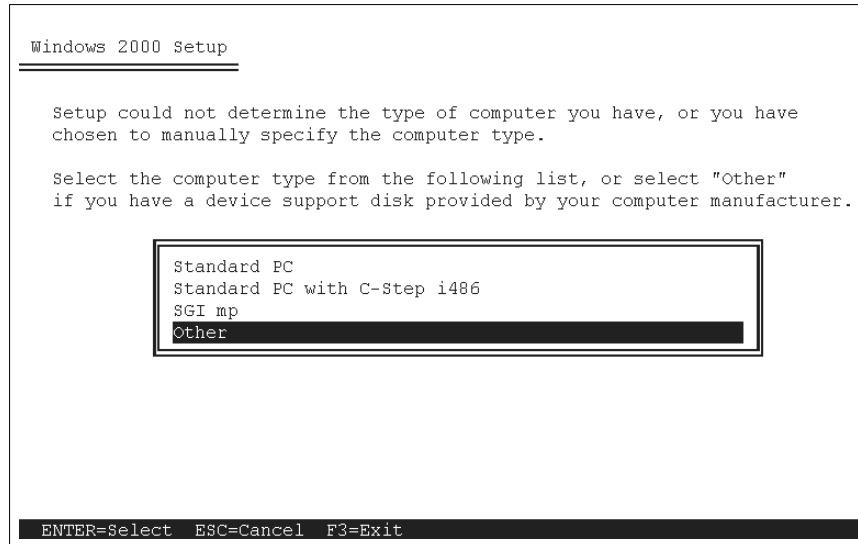

Figure 4-3 Installing IBM custom HAL

5. Insert the xSeries 440 Windows 2000 HAL Support Disk (the one you downloaded and created) into the diskette drive and press Enter.
6. Select **eServer xSeries 440 (Windows 2000 HAL)**, as shown in Figure 4-4 on page 114 and press Enter. The necessary files will be copied from the diskette.

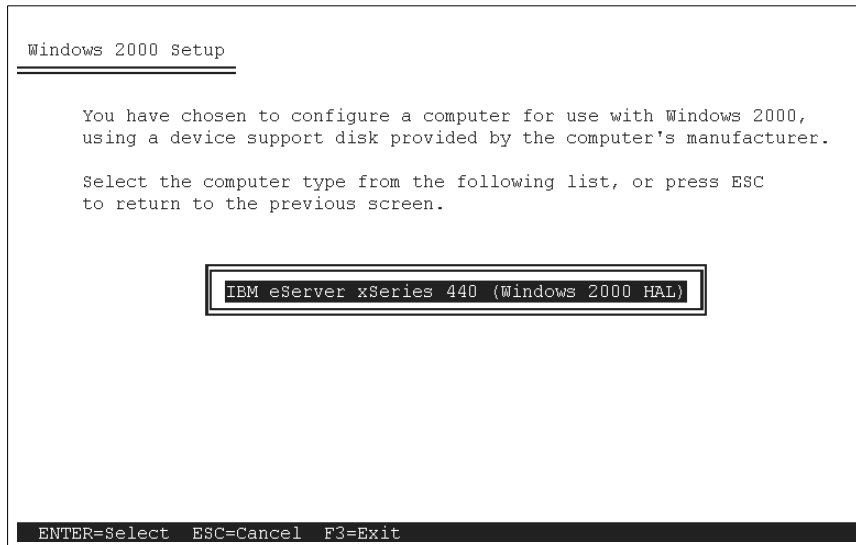

Figure 4-4 Selecting computer type from custom HAL disk

7. If you pressed F6 to add mass storage device drivers, such as for a ServeRAID controller, you will now be prompted to insert the driver disk.
8. Continue the Windows 2000 installation and configuration as normal. You will be prompted to insert the Windows 2000 HAL Support Disk (and the ServeRAID driver disk if required) a second time during the text mode portion of setup.

## Installing the Windows 2000 Service Pack

Once the Windows 2000 installation is complete, install the latest Windows 2000 service pack.

During the installation, you should select **No** when prompted to replace the HAL.DLL file, as shown in Figure 4-5 on page 115.



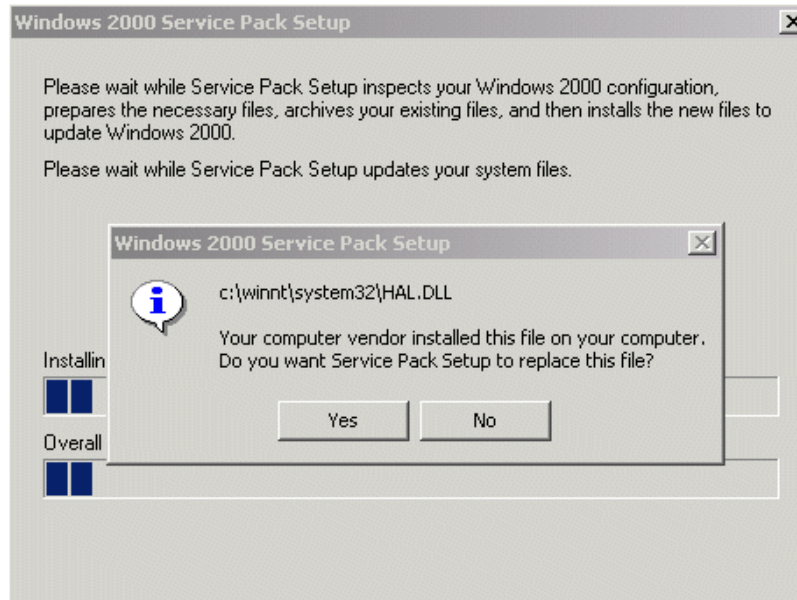

Figure 4-5 Windows 2000 Server Service Pack 2 installation

## Installing additional drivers

After Windows 2000 is installed, Device Manager will report a number of unknown devices, as shown in Figure 4-6 on page 116. These unknown devices correspond to specific components as shown in Figure 4-6 on page 116:

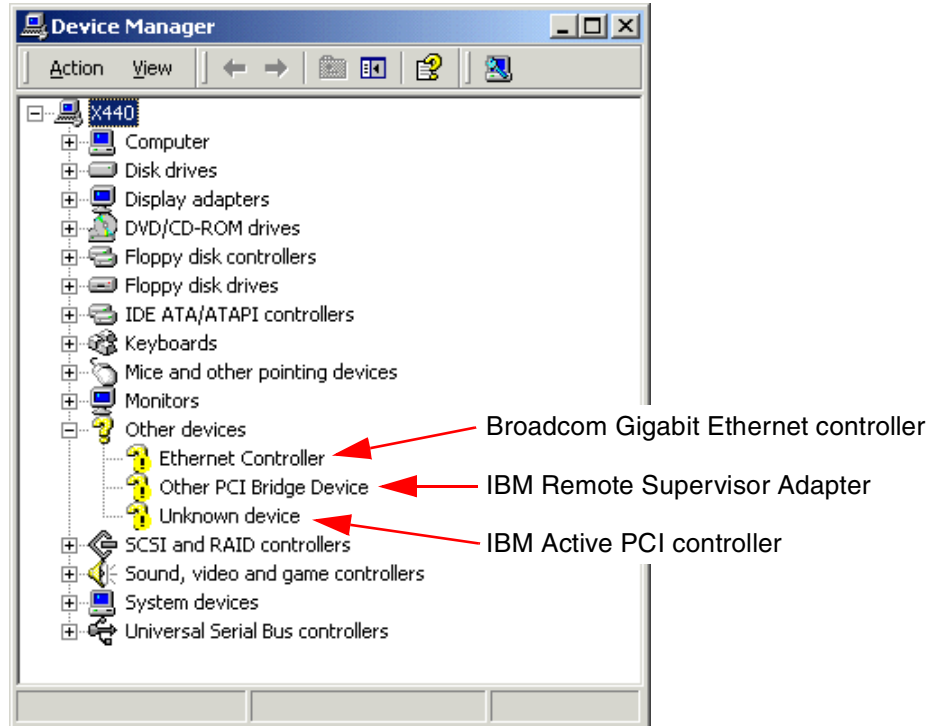

Figure 4-6 Device Manager post Windows 2000 Server installation.

When the Windows 2000 Server installation has completed, you should perform the updates listed below. The order of these updates is not critical, but we recommend that you install the latest Windows 2000 Server Service Pack prior to installing the device drivers.

1. Install or update the ServeRAID adapter driver.

**Important:** ServeRAID device drivers should be at the same level as the installed ServeRAID firmware and BIOS.

2. Install the driver for the onboard Broadcom NetXtreme Gigabit Ethernet adapter.

To perform this update open Device Manager, right-click **Ethernet Controller** under Other devices, select **Properties**, select the **Drivers** tab then click the **Update Driver** button. Follow the steps in the Upgrade Device Driver wizard, using the downloaded driver files extracted to a floppy disk.

3. Install the driver for the Remote Supervisor Adapter.
4. Install the Active PCI device driver.
5. Update the S3 Savage4 LT video controller driver.
6. If you have other devices installed, such as FASTT Fiber Channel adapters, update or add the drivers for these.

Follow the installation instructions supplied with each individual driver package.

Figure 4-7 shows Device Manager after the Active PCI, RSA and Broadcom Gigabit Ethernet drivers have been installed.

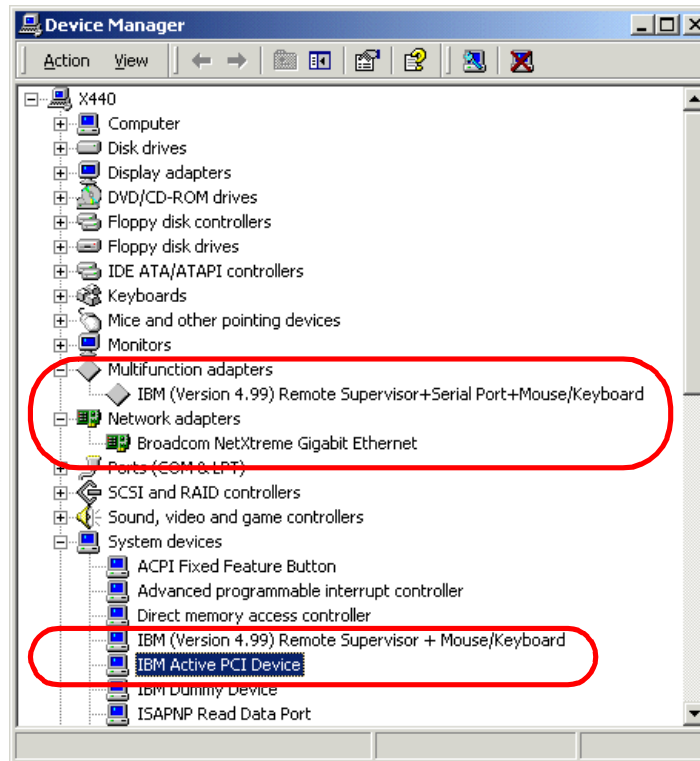

Figure 4-7 Windows 2000 Device Manager after device driver updates

## Enabling Hyper-Threading on a Windows 2000 system

For instructions on enabling Hyper-Threading in BIOS refer to 4.1.3, “Enabling Hyper-Threading” on page 109. Refer to 3.5, “Operating system considerations” on page 90 for a discussion of the performance and planning issues related to Hyper-Threading technology.

Once you enable Hyper-Threading, the Performance tab in Task Manager will show twice the number of CPUs installed as there are physical processors. Figure 4-8 shows the windows before and after enabling Hyper-Threading on a two-way x440.

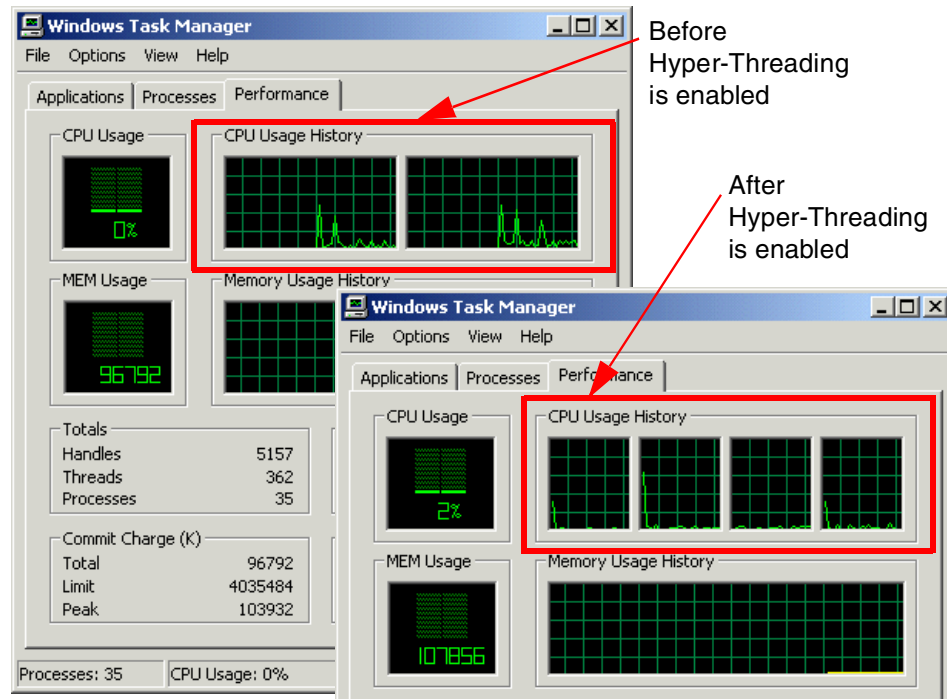

Figure 4-8 Before and after enabling Hyper-Threading on a two-way x440

## Attaching the RXE-100 Remote Expansion Enclosure

Once Windows 2000 is installed, if you haven't done so already, you can attach the RXE-100. Follow these steps:

1. Once the installation of Windows 2000 Server or Windows 2000 Advanced Server is complete, shut down the operating system and power off the server.
2. Connect the RXE-100 to the x440 as described in "Connecting the RXE-100" on page 80.
3. If power is connected to the RXE-100, remove for 10 to 20 seconds
4. Re-apply power to the RXE-100.
5. Power on the server.

The enclosure will power on automatically as the server is started.

If the additional PCI slots are not visible, confirm that the custom HAL has been installed, as follows:

- a. Open Device Manager
- b. Expand the Computer entry
- c. Right-click **ACPI Multiprocessor Node** and select **Properties**
- d. Click the **Driver** tab

The Driver Provider is listed as IBM, as shown in Figure 4-9.

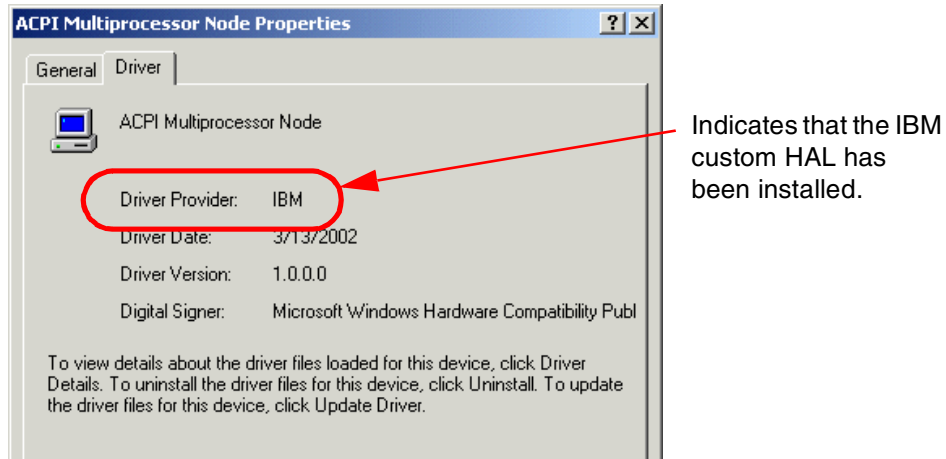

Figure 4-9 HAL.DLL driver file details

### 4.3.2 Red Hat Linux installation

In this section we discuss the installation of Red Hat Linux Advanced Server Version 2.1 on the x440 server.

Before installing Red Hat Linux, update firmware and BIOS levels as discussed in 4.1.1, “Updating BIOS and firmware” on page 108.

**Tip:** If you have an RXE-100, disconnect it before you begin. You should reconnect it after you finish the Red Hat installation.

1. Start the server and insert the Advanced Server CD 1. The Welcome screen appears.
2. Type **linux apic** at the shell prompt below the Welcome screen to load support for APIC.

3. Proceed with the installation as normal. Refer to documentation on the Red Hat Linux CD or the following PDF:

<https://www.redhat.com/docs/manuals/advserver/RHLAS-2.1-Manual/pdf/rh1-ig-as-x86-en-21.pdf>

When you have completed the installation, do the following to install the kernel source for the summit (IBM XA-32 chipset) kernel:

1. Log in as root
2. Insert the Red Hat Linux Advanced Server Version 2.1 CD 1 and mount the CD (if it is not auto-mounted) with the following command:

```
mount /mnt/cdrom
```

3. Install the summit kernel RPM with the following command:

```
rpm -ivh /mnt/cdrom/RedHat/RPMS/kernel-summit-2.4.9-e.3.i686.rpm
```

**Note:** If you experience a system hang when booting the default Advanced Server kernel to install the summit kernel, reset the server, press F1 to enter the Setup Utility and select **Load Default Settings**. Exit from the Setup Utility, saving changes.

If you are compiling updated drivers on the summit kernel, you must install the kernel source and apply the summit kernel patch prior to compiling the driver, as follows:

**Note:** If you have previously updated the summit kernel from Red Hat Network (RHN), follow these steps, substituting the appropriate kernel version where necessary. For example, 2.4.9-e.3 would be changed to 2.4.9-e.8 for the 2.4.9-e.8 summit kernel.

1. When installing the kernel, do one of the following:
  - If you later wish to add additional features and support to the kernel by recompiling it, install the kernel-source RPM from either the Advanced Server CD 2 or from the Red Hat Network site (<http://rhn.redhat.com>) if you have previously updated the kernel, by running:

```
rpm -ivh kernel-source-2.4.9-e.3.rpm
```

- If you don't need to recompile the kernel, install the kernel SRPM from either the Advanced Server CD 4 or from the Red Hat Network site (<http://rhn.redhat.com>) if you have previously updated the kernel, by running:

```
rpm -ivh kernel-2.4.9-e.3.src.rpm
```

2. Run the following commands to update additional patches to the summit kernel:

```
cd /usr/src/linux-2.4.9-e.3
patch -p1 </usr/src/redhat/SOURCES/linux-2.4.9-summit.patch
```
3. Copy new kernel config (kernel-2.4.9-i686-summit.config) to .config:

```
cp -f configs/kernel-2.4.9-i686-summit.config .config
```
4. Edit the makefile to change the EXTRAVERSION field from custom to summit.
5. Run **make clean**.
6. Run **make menuconfig**. Exit menuconfig, saving the new kernel configuration when prompted.
7. Run **make dep**.
8. Proceed with compiling the kernel.
9. Connect to the Red Hat network to update your Red Hat Advanced Server with the latest patches.

### Hyper-Threading support under Linux

Hyper-Threading support is part of the summit kernel. Once the kernel has been installed and compiled, and you enable Hyper-Threading support in the BIOS, Red Hat Linux Advanced Server will recognize all your physical and virtual CPUs.

### RXE-100 support under Linux

Once the summit kernel is installed and configured, you have access to your RXE-100 and adapters added to the external enclosure.

**Note:** Attach your RXE-100 to x440 server after the installation of Red Hat Linux Advanced Server. Also currently only the first six PCI slots are supported under Red Hat Linux.

## 4.3.3 NetWare installation

In this section we describe what should be considered when installing NetWare 6 on an x440.

Before installing NetWare on x440, ensure that the BIOS and firmware levels have been updated to the latest level. See 4.1.1, “Updating BIOS and firmware” on page 108 for details.

Known problems with NetWare are:

- ▶ NetWare 5.1 is currently not supported, but it should still install. See RETAIN tip H176163 for details on a known shutdown problem:  
<http://www.pc.ibm.com/qtechinfo/MIGR-43679.html>
- ▶ With NetWare 6.0, the server may show extreme CPU utilization values (for example, 13000%). This will be fixed with NetWare 6.0 Support Pack 2. See RETAIN tip H176060 at:  
<http://www.pc.ibm.com/qtechinfo/MIGR-43532.html>

The overall process is as follows:

1. Install NetWare and the Gigabit Ethernet driver
2. Apply the latest NetWare Support Pack
3. Install additional drivers
4. Add support for the RXE100
5. Enable Hyper-Threading

You will need the following device drivers:

- ▶ Broadcom Gigabit Ethernet, from  
<http://www.pc.ibm.com/qtechinfo/MIGR-43369.html>
- ▶ Remote Supervisor Adapter, from  
<http://www.pc.ibm.com/qtechinfo/MIGR-42317.html>
- ▶ IBM Active PCI driver, from  
<http://www.pc.ibm.com/qtechinfo/MIGR-42423.html>
- ▶ A new NetWare Bus Interface driver, NBI.NLM, from  
<http://support.novell.com/filefinder/> (search for NBIUP1.EXE)

To install NetWare 6 on x440, do the following:

1. Disconnect the RXE-100 if you have one attached. You should reconnect it after the Support Pack is installed and before the NBI driver is installed.
2. Power on the x440 with bootable NetWare 6 CD in the CD-ROM drive.
3. Follow the NetWare installer screen instructions up to the device driver screen, shown in Figure 4-10 on page 123. The NetWare installer cannot detect the Broadcom Gigabit controller.



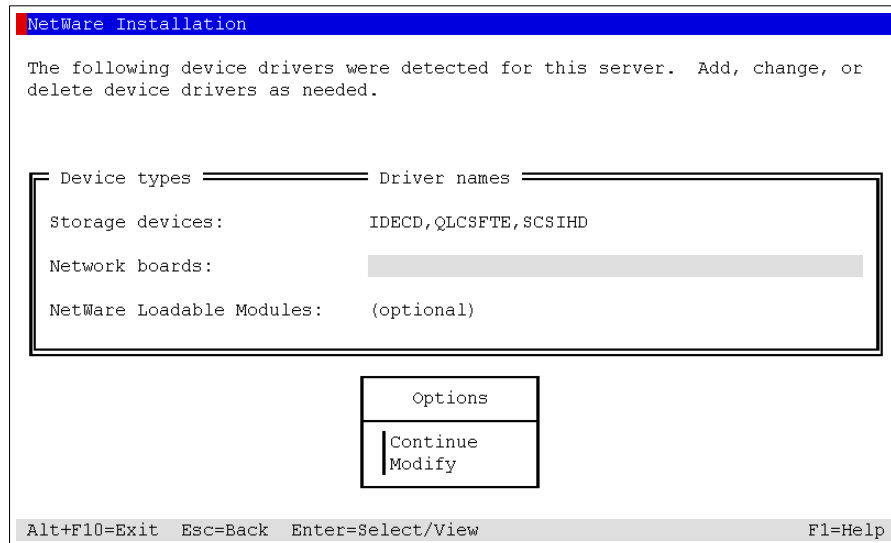

Figure 4-10 Network board installation instruction

To install the network driver, follow the instructions:

- Select **Modify** and press Enter.
- Press Insert to add the driver.
- Follow the instruction until the driver is installed and is loaded in the NetWare installer screen.

At this point, you will be returned to the list of detected device drivers, which should now include the network card, as shown in Figure 4-11 on page 124.

**Note:** NetWare 6 installer automatically detects and installs the ServeRAID controller driver. You should, however, upgrade the driver once installation is complete.

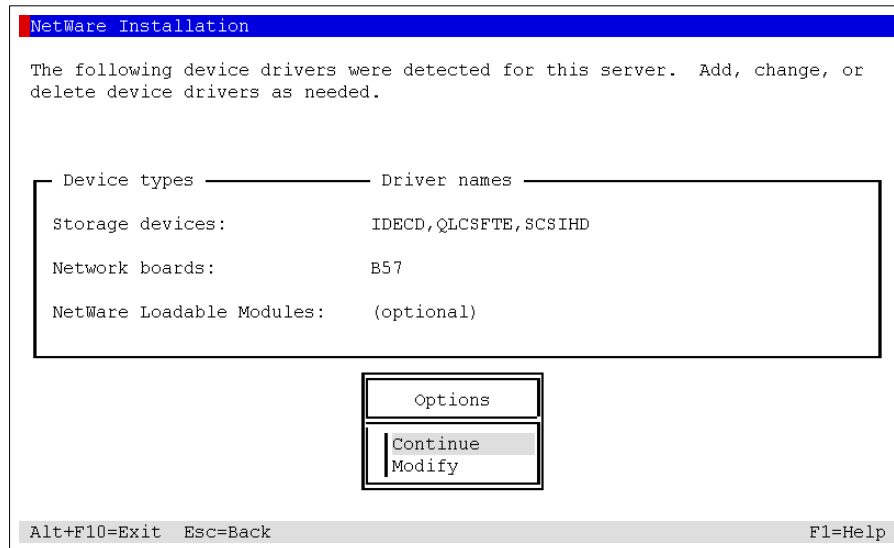

Figure 4-11 Shows the loaded Broadcom Gigabit driver

4. Select **Continue** and continue the NetWare installation as per usual.

Once the NetWare installation is complete, install the latest service pack. This can be done using the NWCONFIG utility.

### Installing additional drivers

When the NetWare 6 and Support Pack installation has completed, you should perform the updates listed below. The order of these updates is not critical, but we recommend that you install the latest Support Pack prior to installing the device drivers.

- ▶ Update the ServeRAID adapter driver.
- ▶ Install the driver for Remote Supervisor Adapter (run SETUP.NLM, follow the instructions, and restart NetWare).
- ▶ Install driver for PCI hot-plug controller, as described below.

### Installing the IBM PCI hot-plug controller driver

1. Ensure that NetWare Support Pack 1 is installed, since it is required before the driver can be installed.
2. Download the PCI hot-plug driver from the link listed at the beginning of this section.
3. Copy the PCI hot-plug driver (IBMXSBD.NLM) to hard drive (C:\)

4. Start NetWare server and go to the NetWare Console.

Type `LOAD C:\IBMXSBD.NLM`

Wait until a message indicates that IBMXSBD is ready for operation.

**Tip:** Add the IBMXSBD to AUTOEXEC.NCF to run it each time NetWare starts.

5. Restart the server.
6. To verify the installation, load the Novell Configuration Manager, NCMCON.NLM. This will show the available hot-plug PCI slots, their current status, and any adapters that are currently in the hot-plug PCI slots, as shown in Figure 4-12.

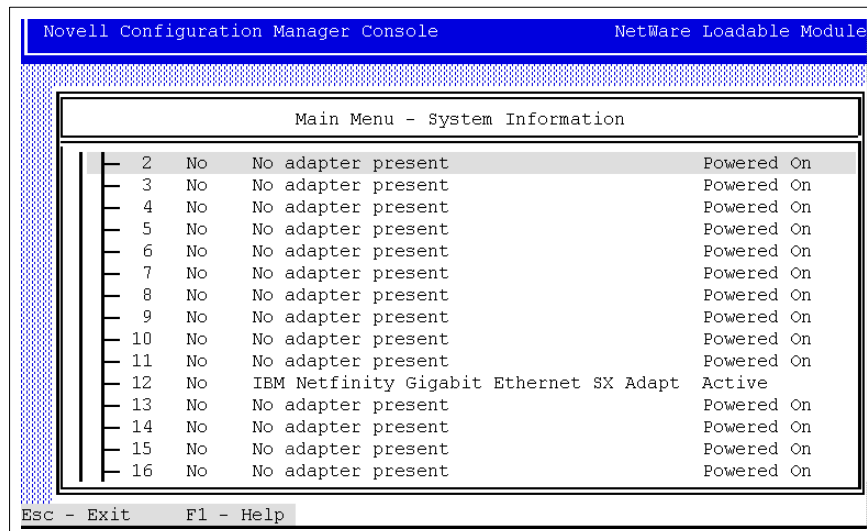

Figure 4-12 Verifies that PCI hot-plug installation was successful

Highlighting a slot and pressing Enter shows the details for that slot. Figure 4-13 on page 126 shows the details for slot 12.

If NCMCON.NLM does not show any slots with “Yes” in the Hot Plug field, the IBMXSBD.NLM module is not loaded. To fix the problem, exit NCMCON, load IBMXSBD at the system console, and reload NCMCON.

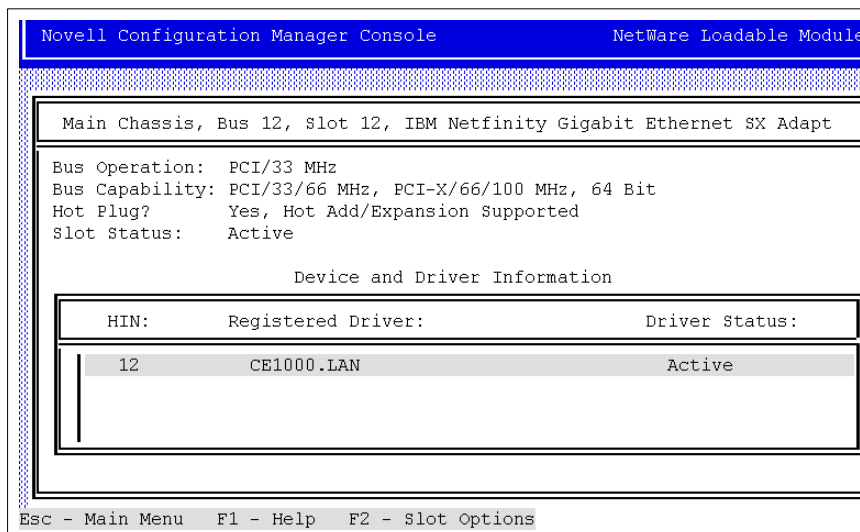

Figure 4-13 Shows that hot-plug is enabled

**Tip:** You can debug the driver by powering down the machine, rebooting, and entering:

```
LOAD C:\IBMXSBD.NLM -DBGALL > C:\IBMXSBD.TXT
```

## Adding support for the RXE-100

To add support for RXE-100, a new NBI.NLM file must be obtained by going to <http://support.novell.com/filefinder/> and searching for NBIUP1.EXE. This file contains a new NetWare Bus Interface driver, NBI.NLM. The new driver adds support for the x440 when the RXE-100 is installed.

### Before you begin:

- ▶ Attach the RXE-100 (do this after the NetWare installation).
- ▶ The NetWare Support Pack *must* be installed before installing the new NBI.NLM. Otherwise, installing the support pack will overwrite the new NBI.NLM

Perform the following operation:

1. Bring the server down to a DOS prompt.
2. Go to C:\NWSERVER directory and rename the NBI.NLM to NBI.OLD if it exists.

3. There are two NBI.NLM files and one NBIUP1.TXT file in NBIUP1.EXE (one for NW5.1 in the nw51 directory and one for NW6.0 in the nw6 directory). Copy the new NBI.NLM associated with NetWare 6 into the C:\NWSERVER directory.
4. Restart the server
5. To verify that the installation was successful, load NCMCON.NLM. If this shows more than six PCI slots, the installation was successful.

**Note:** Reapplying the NetWare Support Pack overwrites the new NBI.NLM. If this happens, repeat the above steps.

## Enabling Hyper-Threading

Although NetWare 6 supports 32 processors, the Hyper-Threading is not enabled by default. To enable Hyper-Threading, follow the installation instructions described in this section.

1. Enable Hyper-Threading in BIOS. Refer to 4.1.3, “Enabling Hyper-Threading” on page 109 for how to enable Hyper-Threading.
2. Install NetWare 6 Support Pack 1.
3. Replace the current PSM that does not support Hyper-Threading with ACPIDRV.PSM, which does.

This can be done in one of two ways depending on your current level of NetWare 6 deployment.

– Method 1:

For a current installation of NetWare 6, apply NW6SP1 if not done previously. Copy ACPIDRV.PSM from the DRIVERS directory in the NetWare Startup directory on the DOS partition into the NetWare Startup directory.

Edit STARTUP.NCF to load ACPIDRV.PSM instead of the current .PSM (typically MPS14.PSM) and reset the server.

– Method 2:

For a clean installation, the ideal approach would be to obtain a NetWare 6 Overlay CD (available on the Novell Support Product Updates area for NetWare 6), which incorporates NW6SP1.

During the install, using the NetWare 6 Overlay CD, Hyper-Threading support is already available. Modification of the .PSM that will be used is all that is needed. This is done when the install presents the device drivers (Platform Support Module, Hot-Plug Support Module and Storage Adapters) that will be installed. Choose to modify the PSM selection,

delete the default .PSM (usually MPS14.PSM) and insert the ACPIDRV.PSM (the selections will display when the Insert key is pressed).

This will enable Hyper-Threading from the start for this particular installation. If an Overlay CD cannot be obtained, perform the previously outlined method for enabling Hyper-Threading on an existing installation.

4. Restart server.

**Tip:** You can display the number of processor with the DISPLAY PROCESSOR command on the system console to ensure that Hyper-Threading is enabled.

### 4.3.4 VMware ESX Server

For VMware ESX Server installation instructions, see the redbook *Server Consolidation with the IBM @server xSeries 440 and VMware ESX Server*, SG24-6852.

## 4.4 Additional Information

For additional information on the installation of the x440, refer to the following product publications posted on the Web:

- ▶ *IBM @server xSeries 440 Installation Guide*
- ▶ *IBM @server xSeries 440 Option Installation Guide*
- ▶ *IBM @server xSeries 440 User's Guide*
- ▶ *IBM @server xSeries 440 Troubleshooting Guide*
- ▶ *IBM @server xSeries 440 Hardware Maintenance Manual*
- ▶ *IBM Remote Expansion Enclosure Installation Guide*

These product publications can be downloaded in PDF format from:

<http://www.pc.ibm.com/support>



# Management

IBM Director is the systems management software provided with the IBM @server xSeries servers. This chapter covers the three plug-ins to IBM Director unique to IBM that are of particular relevance to the x440:

- ▶ 5.1, “Active PCI Manager” on page 130

Active PCI Manager guides you when installing new PCI adapters and can analyze an existing PCI configuration and suggest changes to improve performance. Works with x440 internal slots and RXE-100 slots.

- ▶ 5.2, “System Partition Manager” on page 150

System Partition Manager is used to physically partition an x440 complex (for example a 16-way) so that each partition behaves as an independent server.

- ▶ 5.3, “Process Control” on page 155

Process Control can help improve performance both for the server overall and for application users in general. Application vendors have no incentive to impose restrictions on their software. One application may have its priority set unnecessarily high, to the detriment of all other applications, or two applications may each try to use all available memory, causing contention. These types of ill-behaved applications make it virtually impossible to run many applications concurrently on a conventional server. By preventing resource-intensive applications from dominating server resources, IBM provides the means for application consolidation.

## 5.1 Active PCI Manager

Active PCI Manager is used to plan the addition of PCI and PCI-X adapters to the x440 and RXE-100 expansion enclosures, to best use the bus architecture of the systems. It can also analyze existing adapter arrangements to determine if the configuration is optimal, and if not, suggest alternative configurations. If required, it then graphically assists with changing the adapter placement.

**Note:** In this chapter, the images are taken from a pre-release version of IBM Director 3.1 service pack 1 (Version 3.1.1).



Figure 5-1 Active PCI Manager revision

Active PCI Manager 3.1.1 will be a plug-in for IBM Director 3.1.1, just as the current version, 1.1 is a plug-in for IBM Director 3.1. It will be available for download from:

<http://www.pc.ibm.com/support>

Like other IBM Director plug-ins, there are three components:

- ▶ Agent component, installed on the x440
- ▶ Server component, installed on the IBM Director Server
- ▶ Console component, installed on each IBM Director console

**Note:** All Active PCI Manager functions are performed from the IBM Director console.

The agent has the following prerequisites:

- ▶ Windows 2000 Server or Advanced Server with Service Pack 2



- ▶ IBM Active PCI Software Version 5.0.2.0 or later. This software contains the following components:
  - IBM Active PCI filter driver
  - IBM Active PCI alert driver
  - IBM Active PCI alert service

IBM Active PCI Software and the user's guide are available from:

<http://www.pc.ibm.com/qtechinfo/MIGR-4J2QE.html>

Once installed, Active PCI Manager appears as a task in the Director console, as shown in Figure 5-2.

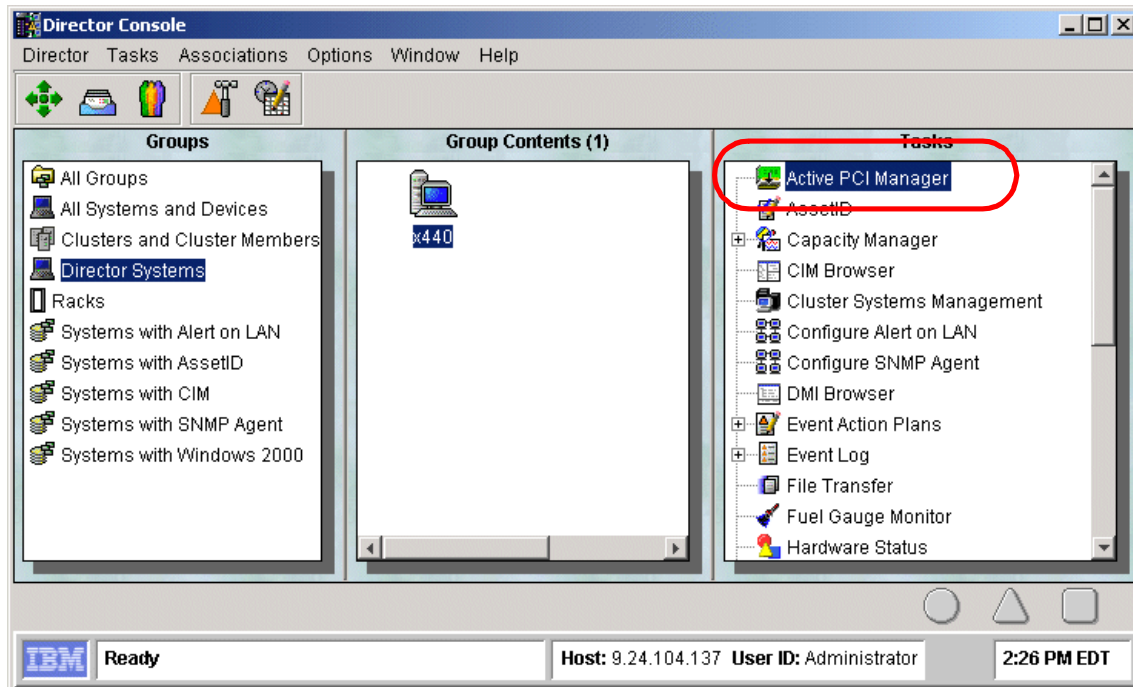

Figure 5-2 Active PCI Manager task on IBM Director main console

Active PCI Manager is activated by dragging the icon from the Task frame and dropping it on the icon of the system in the Group Contents frame. Alternatively, Active PCI Manager is activated by right-clicking the system in the group contents frame, and selecting Active PCI Manager from the list.

## 5.1.1 Using Active PCI Manager

The Active PCI Manager interface is shown in Figure 5-3. The details of your system configuration are available in three ways by clicking the appropriate tab:

- ▶ Slot view, Figure 5-3
- ▶ Tree view, Figure 5-5 on page 135
- ▶ Table view, Figure 5-6 on page 136

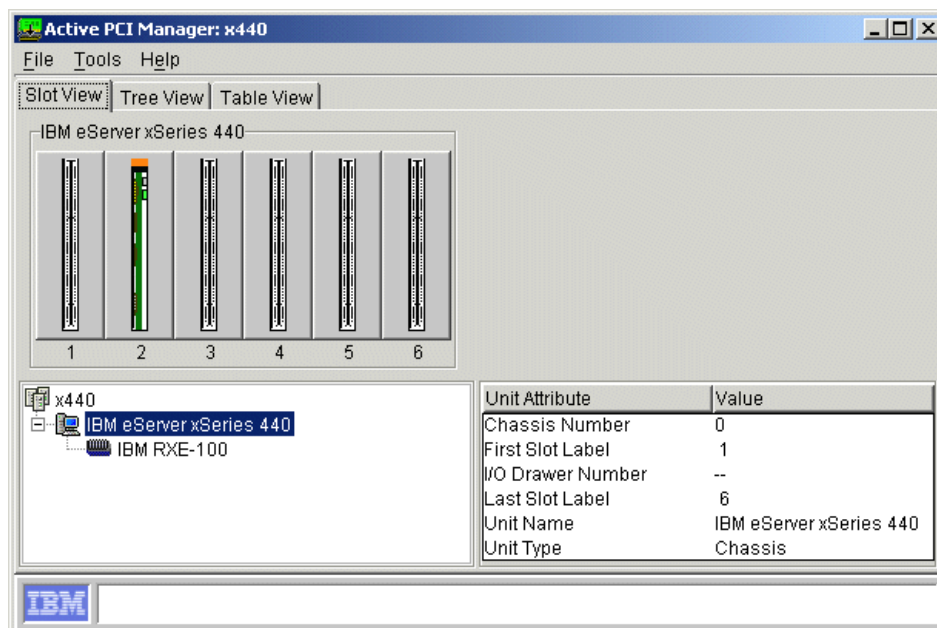



Figure 5-3 x440 slot view

In the slot view, we see a graphical representation of our ServeRAID adapter in slot 2 of the x440 and the other slots empty. The orange bar above the adapter  indicates that the adapter present in that slot is hot-swappable.

The tree pane in this view (lower left) shows there is an RXE-100 attached to the server. By selecting the RXE-100, the graphical view changes to show the six or 12 slots in that enclosure.

The details pane in this view (lower right) includes information about the currently selected item in the tree pane or the currently selected slot. In Figure 5-3, the server is selected and the details pane shows information about the system and its slots, including:

- ▶ Chassis Number: The x440 is assigned chassis number 0. In multi-chassis x440 configurations, each chassis will be identified by a unique number.

- ▶ First Slot Label, Last Slot Label: The first and last slot labels in the server are identified. When the RXE-100 is selected, the slot labels are A1 through A6 and B1 through B6. The labels correspond to the names of the slots as printed on the chassis.
- ▶ I/O Drawer: This value is only relevant when an RXE-100 is selected. The number is unique and the first drawer will be number 0.
- ▶ Unit Name, Unit Type: The unit name is IBM eServer xSeries 440 and the unit type is Chassis. When you select the RXE-100, the unit name is IBM RXE-100 and the unit type is I/O Drawer.

Selecting a slot results in the details of that slot appearing in the bottom right pane, as shown in Figure 5-4.

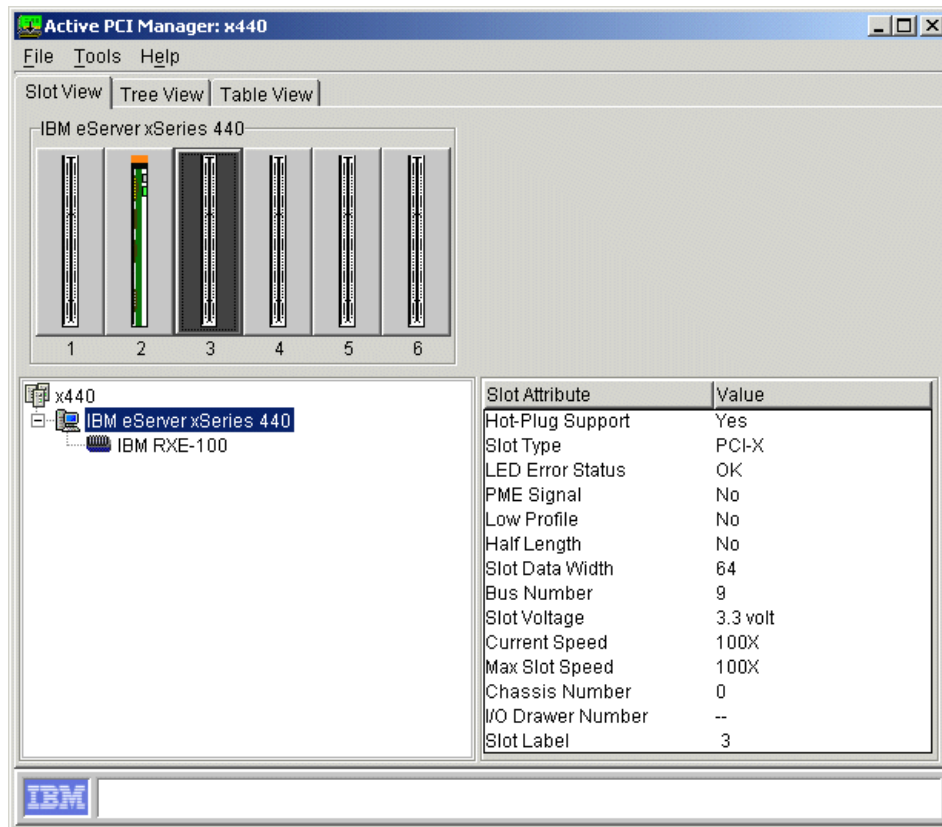

Figure 5-4 Slot 3 details

For information about the attributes, consult the online help. However, some explanation is warranted here:

- ▶ **Current Speed, Max Slot Speed:** As described in 1.8, “PCI subsystem” on page 23, the adapters installed in this slot and other slots in the same bus dictate the speed that the slot will run at. Consequently, the current speed of the slot may not be the maximum possible speed. The “X” in the Current Speed value indicates the slot is running in PCI-X mode (as opposed to running in PCI mode).

Some RXE-100 slots may indicate “NS” for the slot speed (see Figure 5-6 on page 136 for an example). NS stands for “not set”. These are even-numbered slots when the odd-numbered slot in the pair is running at 133 MHz. This is because if both slots in a pair are used, the maximum speed of both slots is 100 MHz.

- ▶ **PME Signal:** PME (power management events) is a hardware signal that some PCI slots can supply. Most PCI cards do not implement PME and the x440 and RXE-100 slots do not support PME.
- ▶ **Bus Number:** a system-assigned number for each bus. Useful for identifying slots that are on the same bus, but the bus number does not correlate to the slot numbers.
- ▶ **Low Profile:** The slot *only* supports cards that have a half-height end plate. See the PCI Special Interest Group specifications of low-profile PCI adapters at [http://www.pcisig.com/data/specifications/lowp\\_ecn.pdf](http://www.pcisig.com/data/specifications/lowp_ecn.pdf).
- ▶ **LED Status:** Table 5-1 shows the possible LED status messages and their meanings:

Table 5-1 LED status messages

Message	Meaning	Recommended Action
OK (no error)	None of the other conditions exist.	None
Hot eject successful	Adapter removal completed without error.	None
Bus speed mismatch	A second adapter was hot-added but its rated speed does not match the current speed of the bus. The new adapter is held inoperative.	Either: <ul style="list-style-type: none"> <li>▶ Move one of the adapters to an empty bus, or a bus with an adapter of the same speed.</li> <li>▶ Reboot the server and the bus will slow down so that both adapters can operate.</li> </ul>
Power fault on card in slot	Adapter has short-circuit or other problem preventing normal operation.	Remove the adapter and have it repaired or replaced.

Message	Meaning	Recommended Action
Surprise removal occurred	Operating system activity to slot was not stopped before power to adapter was removed.	This should be avoided. Use the Unplug or Eject Hardware wizard to disable the adapter before removing it.
Slot disabled at current speed	A second 133 MHz adapter was hot-added to a two-slot bus that already had a 133 MHz adapter installed. The new adapter is held inoperative.	Restart the server. The bus will run at 100 MHz and both adapters will be operative.
Too many adapters on bus	Two PCI-X 133 MHz adapters in a slot pair.	Move one of the adapters to an empty bus.
Bus connection error	System has detected a hardware fault.	Remove the adapter. If this does not correct the condition, have system serviced.

The tree view, shown in Figure 5-5, lets you look at all of the slots in the system at once, in a Explorer-like tree view.

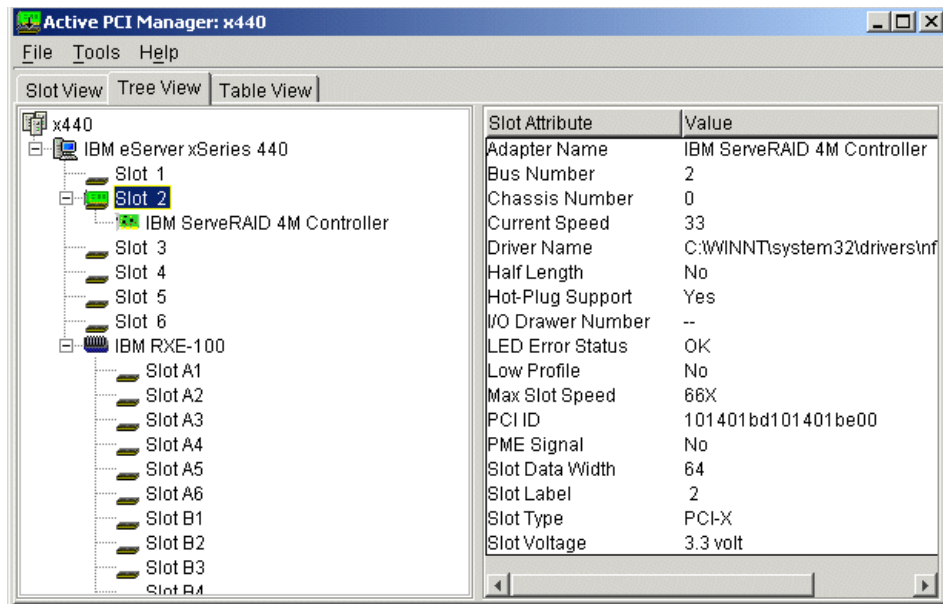

Figure 5-5 x440 and RXE-100 tree view

In Figure 5-5, the x440 slot 2 is selected and the attributes of the slot and the adapter installed in it are shown on the right. For information about the attributes, see the discussion following Figure 5-4 on page 133 and the online help.

The table view, Figure 5-6, provides a summary of all of the slot and adapter information in one frame.

The screenshot shows a window titled "Active PCI Manager: x440" with a menu bar (File, Tools, Help) and three tabs: Slot View, Tree View, and Table View. The Table View is active, displaying a table with the following columns: I/O Drawer, Slot Label, Slot Speed, Slot Max Speed, Slot Type, Hot-Plug Slot, and Adapter. The table contains 24 rows of data, including slots 1-6, A1-A6, and B1-B6.

I/O Drawer	Slot Label	Slot Speed	Slot Max Speed	Slot Type	Hot-Plug Slot	Adapter
--	1	33	66X	PCI-X	Yes	--
--	2	33	66X	PCI-X	Yes	IBM ServeRAID 4M Controller
--	3	100X	100X	PCI-X	Yes	--
--	4	100X	100X	PCI-X	Yes	--
--	5	133X	133X	PCI-X	Yes	--
--	6	133X	133X	PCI-X	Yes	--
0	A1	133X	133X	PCI-X	Yes	--
0	A2	NS	100X	PCI-X	Yes	--
0	A3	133X	133X	PCI-X	Yes	--
0	A4	NS	100X	PCI-X	Yes	--
0	A5	133X	133X	PCI-X	Yes	--
0	A6	NS	100X	PCI-X	Yes	--
0	B1	133X	133X	PCI-X	Yes	--
0	B2	NS	100X	PCI-X	Yes	--
0	B3	133X	133X	PCI-X	Yes	--
0	B4	NS	100X	PCI-X	Yes	--
0	B5	133X	133X	PCI-X	Yes	--
0	B6	NS	100X	PCI-X	Yes	--

Figure 5-6 x440 and RXE-100 table view

Not visible to the left of the information shown is a column that shows the chassis that the slots are associated with. The columns in this view are similar to the attributes in the tree view and slot view.

## 5.1.2 Adding adapters to the system

The process of adding an adapter to an x440 using Active PCI Manager is straightforward. As an example, let's add two adapters to our system:

- ▶ IBM Gigabit Ethernet SX Adapter
- ▶ QLogic QLA2300 PCI Fibre Channel Adapter

Our configuration has a ServeRAID adapter installed in slot 2 of the x440 and an RXE-100 attached. The operating system is installed on the ServeRAID attached disks.

**Note:** The x440 and RXE-100 only support 3.3 V PCI and PCI-X adapter. 5 V adapters are not supported.

The processing of adding an adapter depends on whether the adapter is on the list of known adapters or whether you have to specify the adapter's characteristics.

## Adding a known adapter

The process to add a known adapter, such as the IBM Gigabit Ethernet SX Adapter, is as follows:

1. Select **Tools -> Add Card Wizard**. You are presented with Figure 5-7.

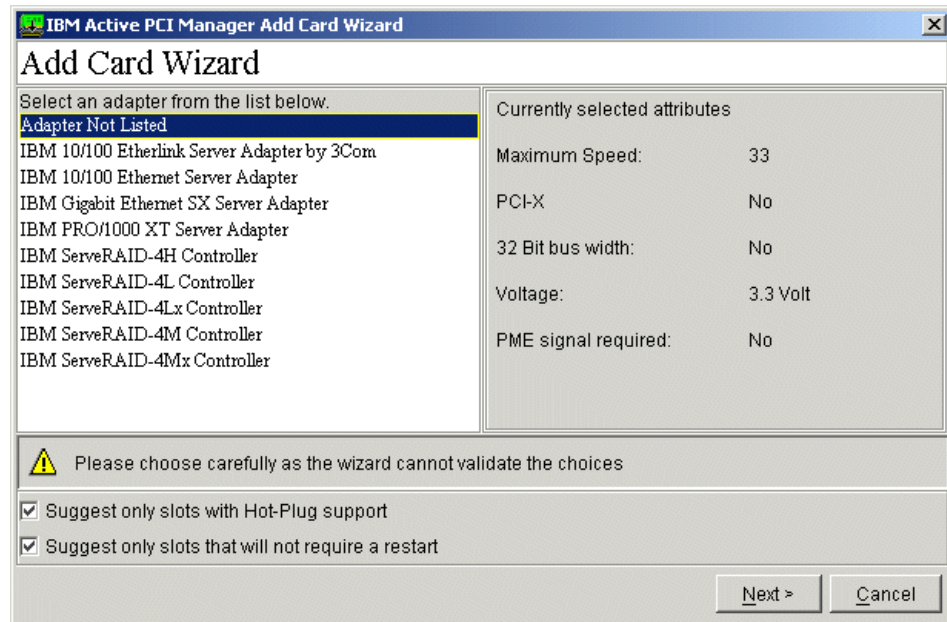

Figure 5-7 Add Card Wizard

The bottom two check boxes are selected, indicating the following default settings:

- Active PCI Manager will suggest only slots with hot-plug support (all of the slots in the x440 and RXE-100 support hot-plug).
- Slots that will not require a server restart.

The Add Card Wizard, when finding the best slot in which to place the new adapter, may find a slot that needs to reset the bus in order for it to work.

An example would be a 133 MHz PCI-X adapter being added to a bus that already has a 133 MHz PCI-X adapter installed. Since the hardware only supports two adapters in the one bus running at most at 100 MHz, the bus

must be reset to run at the lower speed. Restarting the bus requires that the operating system be rebooted.

With this checkbox unchecked, the wizard may suggest the adapter be added to a 133 MHz bus if it is the best slot, and will ask the user to restart the system. With the box checked, the wizard will not suggest the slot on a 133 MHz bus even though it is the best slot, but will try to find a slot that does not require a server restart.

By limiting the wizard this way, it may fail to find a slot. If it does find a slot, the adapter will not require the system to be restarted, but the adapter may not be running at the best speed or in the best mode.

2. To add the IBM Gigabit Ethernet SX Adapter, select it from the list. The characteristics of the adapter are listed on the right side, as shown in Figure 5-8.

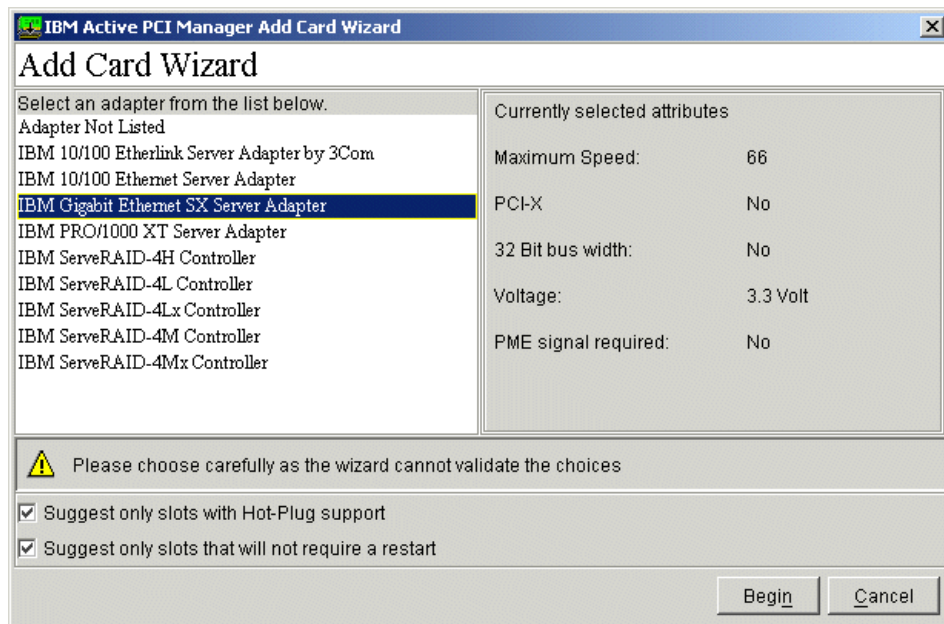

Figure 5-8 Selecting the IBM Gigabit Ethernet SX Adapter

3. To insert the adapter, click **Begin**. Active PCI Manager analyzes the available slots to find the one that provides the best performance for this adapter. While this is running, the following message is displayed:

Please wait while the system is being analyzed. This may take several minutes.



- Upon completion of the analysis, Active PCI Manager recommends the best slot to insert the adapter (if one is available with the right criteria), as shown in Figure 5-9 on page 139. In our case it was slot 3 in the x440.

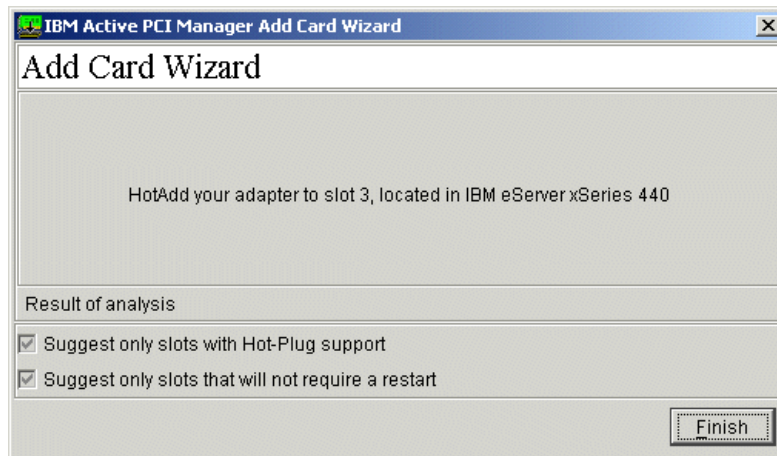

Figure 5-9 Hot Add adapter to slot 3

- Click **Finish** to close the wizard.
- From the slot view, select the slot that the Add Card Wizard recommended, then right-click the slot and click **Blink Slot**, as shown in Figure 5-10.

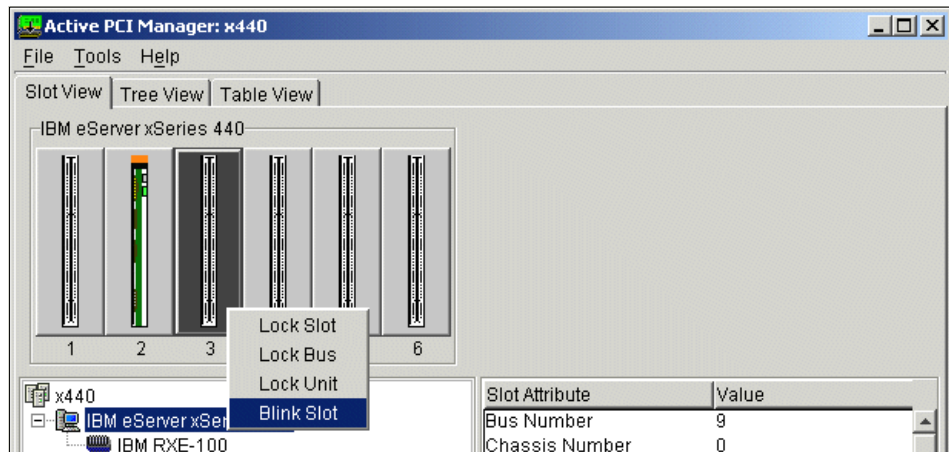

Figure 5-10 Blink Slot

**Lock options:** There are lock options for a slot (see Figure 5-10). These will lock a slot, all of the slots on the bus that a slot is a member of, or the unit (the physical chassis or I/O expansion enclosure that a slot is a member of).

Locking slots excludes them from being processed by:

- ▶ Add Card Wizard
- ▶ Performance optimizer, described in 5.1.3, “Analyzing an existing configuration” on page 144.

**Note:** The table view does not provide access to the lock function.

The LED on the slot itself will blink as does the graphic of the slot, as shown in Figure 5-11.

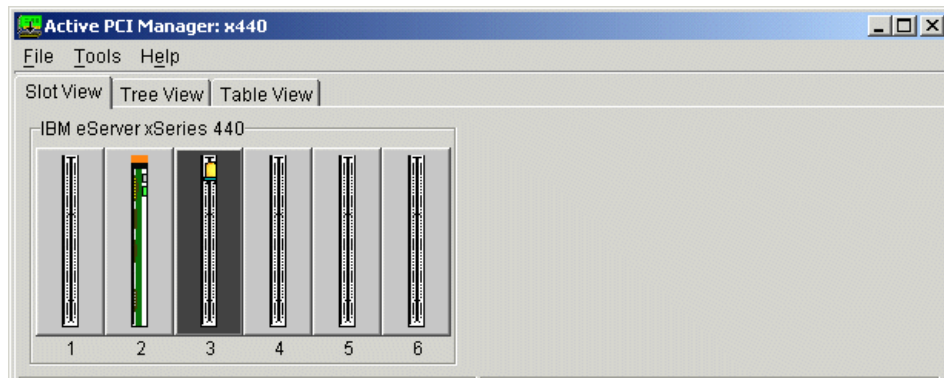

Figure 5-11 Slot 3 with the LED on

7. To hot add the adapter into the slot, open the cover on the x440 or RXE-100. Push the orange tab above the adapter slot in the direction of the arrow, toward the rear of the x440 or RXE-100, and swing the black adapter retaining arm so that it is vertical. This will allow us to remove the blank filler plate and add the adapter.
8. Once the adapter is installed, return the black adapter retaining arm to the closed position. The orange tab will click back into place, locking the adapter retaining arm down.

**Important:** Be sure to close all adapter retaining tabs before closing the cover on the x440 or RXE-100, or the cover will not close properly and forcing it will likely break the adapter retaining arm.

9. After the adapter has been added, the slot view window is dynamically updated, as seen in Figure 5-12.

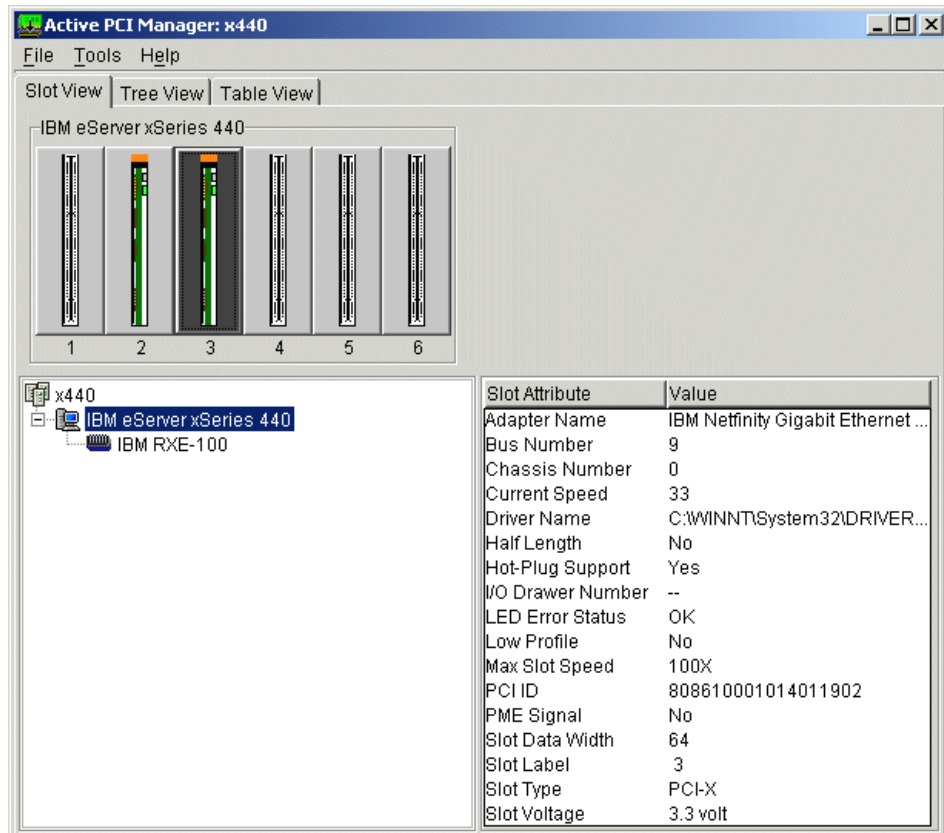

Figure 5-12 IBM Gigabit Ethernet Adapter installed in slot 3

## Adding an unlisted adapter

To add an adapter whose characteristics are not known to the wizard, such as the QLogic QLA23xx PCI Fibre Channel Adapter, do the following:

1. Select **Tools -> Add Card Wizard**. Leave the default selection, **Adapter Not Listed**, highlighted, and click **Next**. Figure 5-13 on page 142 is displayed.

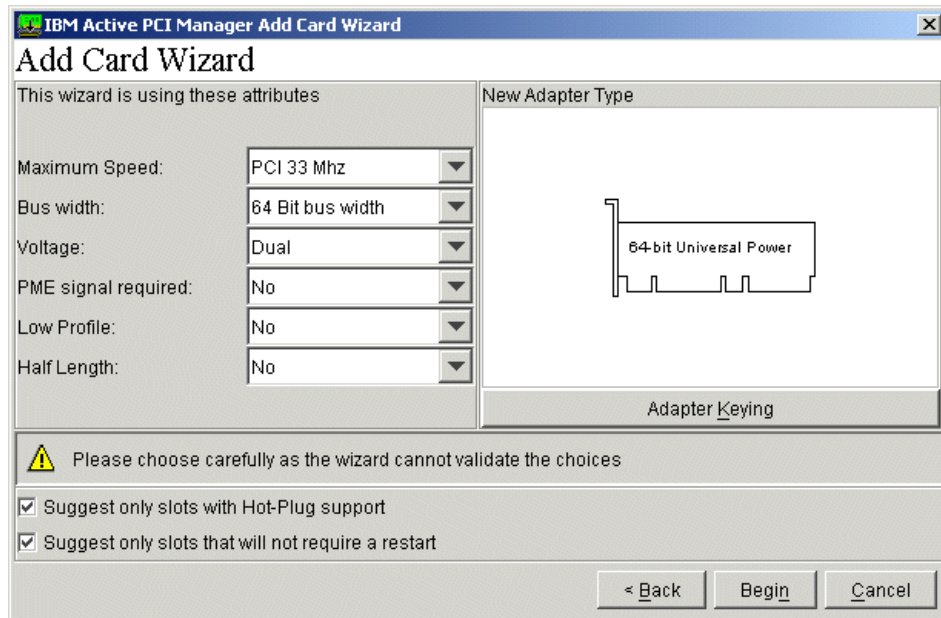

Figure 5-13 Adapter identification screen

There are two ways of specifying the characteristics of an unknown adapter:

- Manually select the attributes from the pull-down menus in the left pane in Figure 5-13.
- Click the **Adapter Keying** button to cycle through drawings of adapters in the right pane in Figure 5-13, and select the appropriate adapter from the shape and location of the PCI connector.

The shape of the PCI connector indicates the voltage support (3.3 V or 5 V or both) and the bus width (64-bit or 32-bit), as shown in Figure 5-14.

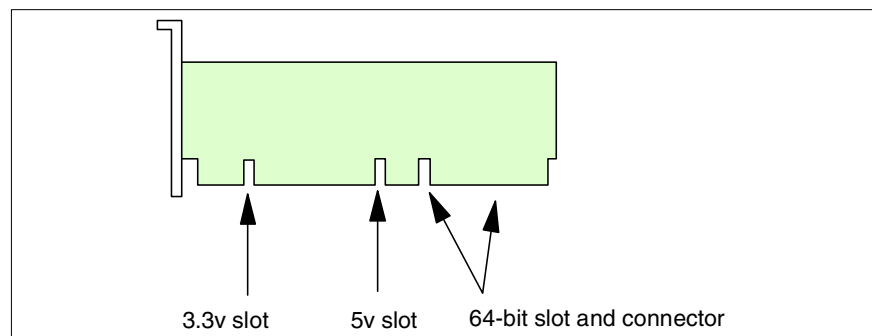

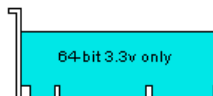
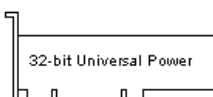
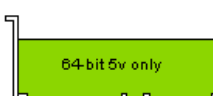



Figure 5-14 The meaning of the slots in the PCI connector

Table 5-2 shows you the possible choices when you click **Adapter Keying**. As you click the button, both the graphic and the bus width and voltage pull-down menu entries change.

**Note:** Clicking the **Adapter Keying** button only changes the bus width and voltage pull-down menus. The other fields (maximum speed, PME, low profile, and half length) must be set manually.

Table 5-2 Adapter attributes and associated graphics

Attributes	Graphic
Bus width: 64-bit Voltage: dual (3.3 V and 5 V)	 A schematic diagram of a PCI-X adapter connector. The text "64-bit Universal Power" is centered within the connector's outline.
Bus width: 64-bit Voltage: 3.3 V	 A schematic diagram of a PCI-X adapter connector. The text "64-bit 3.3v only" is centered within the connector's outline.
Bus width: 32-bit Voltage: Dual (3.3 V and 5 V)	 A schematic diagram of a PCI-X adapter connector. The text "32-bit Universal Power" is centered within the connector's outline.
Bus width: 64-bit Voltage: 5 V <b>Note:</b> 5 V adapters are not support in the x440 and RXE-100	 A schematic diagram of a PCI-X adapter connector. The text "64-bit 5v only" is centered within the connector's outline.
Bus width: 32-bit Voltage: 5 V <b>Note:</b> 5 V adapters are not support in the x440 and RXE-100	 A schematic diagram of a PCI-X adapter connector. The text "32-bit 5v only" is centered within the connector's outline.

2. Review the documentation that is included with the adapter to determine its characteristics. In our case, they are:
  - PCI-X 66 MHz
  - 64 bit
  - Dual voltage
  - No PME signal
  - Full height (that is, not low profile)
  - Half length

3. Enter the remaining values into the pull-down menus. We enter our parameters and the following message is displayed:  
HotAdd your adapter to slot 5, location in the IBM eServer xSeries 440
4. Blink the slot as described in step 6 on page 139.
5. Hot add the adapter as described in steps 7 and 8 on page 140.
6. Active PCI Manager updates its display to reflect the addition of the adapter, and we see the operating system recognize the addition of the adapter, as shown in Figure 5-15.

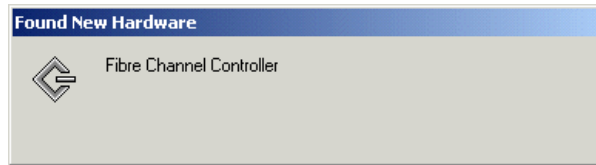

Figure 5-15 Windows finds new hardware

7. Supply the device driver for the adapter as per usual to complete the installation.

Active PCI Manager is not required to hot add an adapter, but the use of the blink slot tool will reduce the likelihood of error. The use of the Add Card Wizard can insure that the adapter slot selection will result in an optimal configuration, if used correctly.

### 5.1.3 Analyzing an existing configuration

Active PCI Manager can be used to analyze an existing configuration and assist with the optimization of that configuration, if required. We have intentionally re-arranged the adapters described in the previous section to illustrate this capability. Figure 5-16 on page 145 shows the configuration we are starting with.

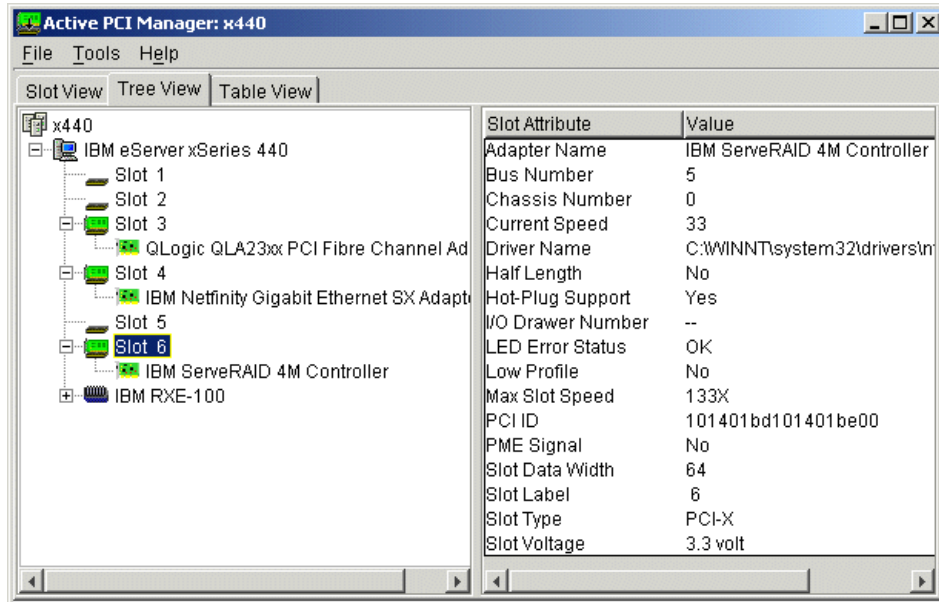

Figure 5-16 Incorrectly arranged adapters

To analyze the adapter configuration, click **Tools -> Analyze**. Once the analysis is complete, the Optimization Steps window appears, as shown in Figure 5-17 on page 146. It includes three sections:

- ▶ Observations — problems identified
- ▶ Suggested Adapter Arrangement — adapter layout after recommended changes are made
- ▶ Recommended Actions — recommended changes

In our case a performance problem was discovered.

**Note:** You will note that the optimizer reports that both slots 3 and 6 contain boot devices. These are *potential* boot devices, not necessarily actual boot devices.

IBM does not support booting from a Fibre Channel device. However, Active PCI Manager recognizes the QLogic adapter as a potential boot device. Active PCI Manager does not make recommendations that include moving bootable devices, since this may alter the order in which bootable devices are enumerated during startup, resulting in a system that will not boot from its intended boot device (or at all, if no other bootable devices exist).

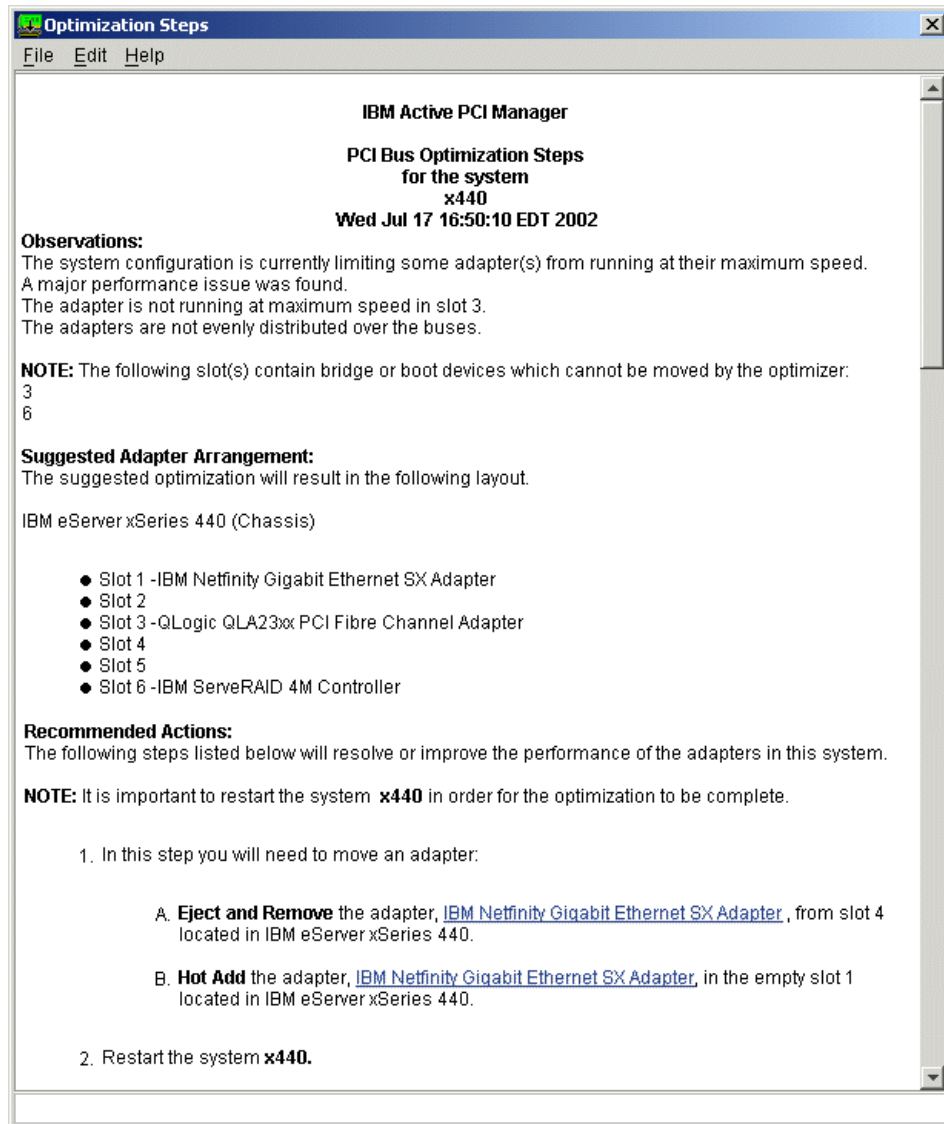

Figure 5-17 Performance analysis

In the Recommended Actions, follow the instructions to move adapters. In our example, the recommendation is to move an adapter from slot 4 to slot 1. The steps we followed are as follows:

1. Click the link on the line **Eject and Remove** the adapter. Figure 5-18 on page 147 appears indicating with an arrow the adapter to remove.



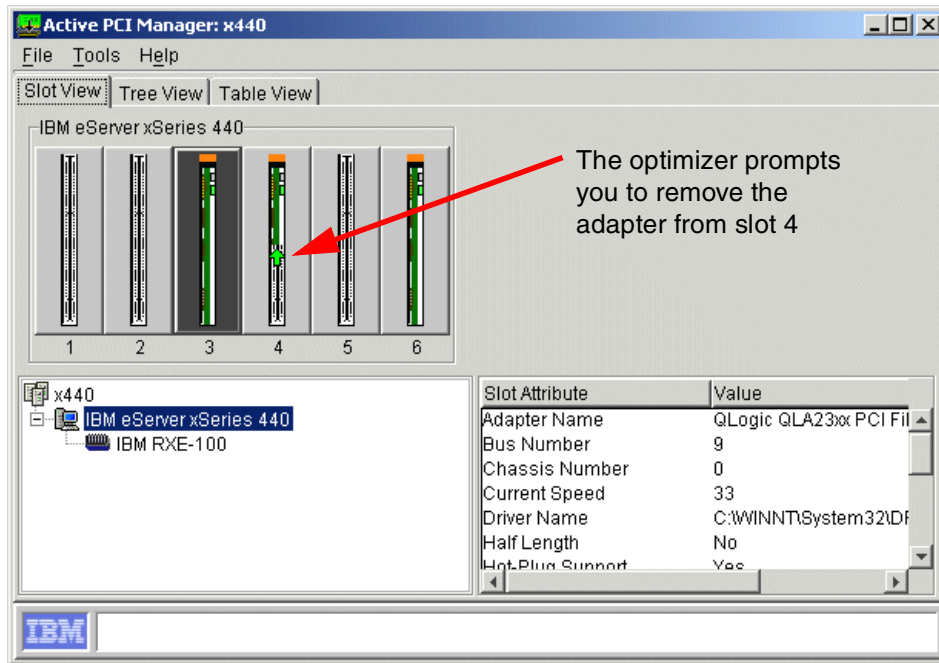



Figure 5-18 Removing an adapter from slot 4

**Tip:** The two links in Figure 5-17 merely show you which slot to insert the adapter into or remove the adapter from.

2. Stop the adapter in the operating system. Double-click the  icon in the system tray. Figure 5-19 on page 148 appears.

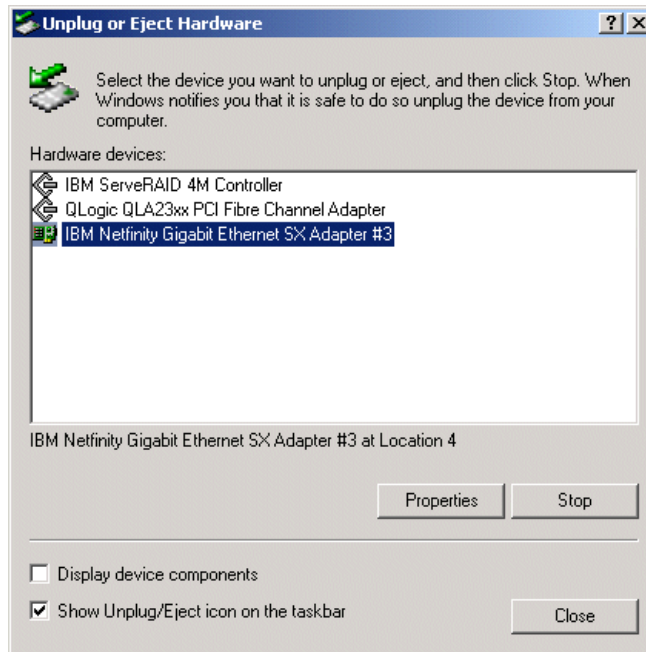



Figure 5-19 Stop adapter use by the operating system

3. Select the adapter you want to stop and click **Stop**.
4. Confirm that you want to stop the device by clicking **OK**.
5. Once the operating system confirms the adapter has been stopped, use the Slot Blink action (see step 6 on page 139) to indicate which adapter to remove.
6. Remove the adapter.
7. Active PCI Manager then shows the adapter has been removed, as shown in Figure 5-20 on page 149, by adding an  to the bottom of the graphic and changing the LED error status to “Hot eject successful”.

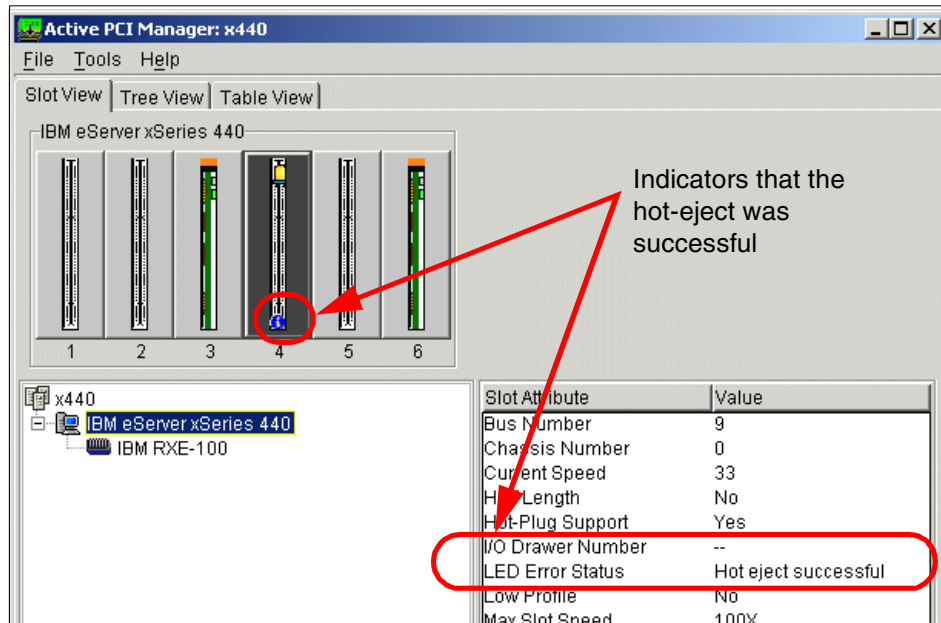

Figure 5-20 Hot eject successful

- Close the adapter retainer on slot 4. The slot is then reported as empty, as shown in Figure 5-21.

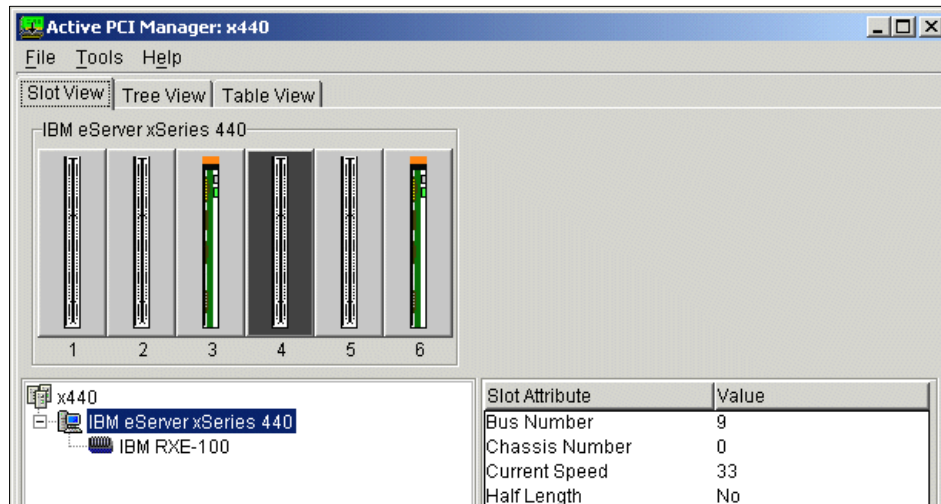

Figure 5-21 Slot 4 is empty

9. Back at the Optimization Steps window, shown in Figure 5-17 on page 146, click the link to hot add the adapter.
10. The slot view appears with an arrow showing you which slot to insert the adapter into, as shown in Figure 5-22.

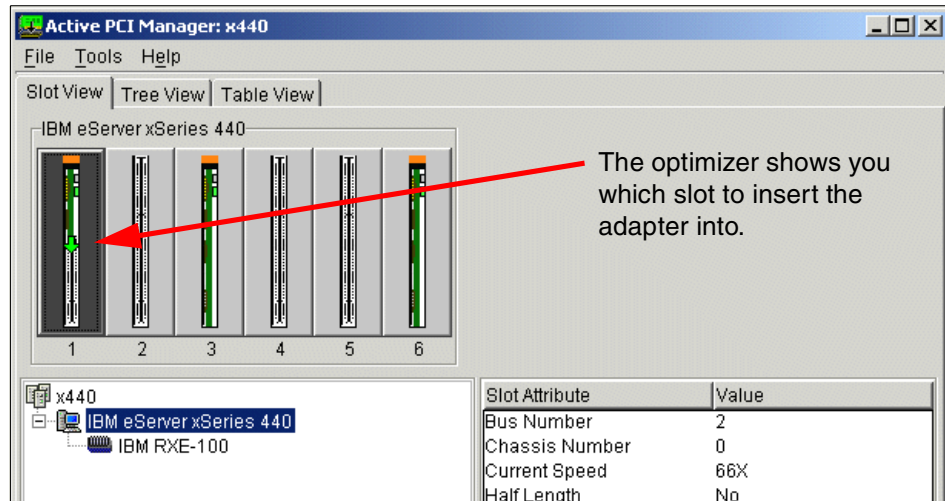

Figure 5-22 Hot Add

11. Insert the adapter and close the latches.
12. Once all the recommended actions are complete, restart the server and re-run the optimizer to confirm that there are no performance issues.

By using Active PCI Manager, we are assured that our I/O subsystem is configured for optimal performance. We can use Active PCI manager to assist us in configuring our system, or to reconfigure our system after it has been set up.

## 5.2 System Partition Manager

System Partition Manager is a tool that will let you partition multi-chassis x440 complexes into independent operating environments. For example, if you have a 16-way complex, comprised of two eight-way x440s, you can use System Partition Manager to split the 16-way into two eight-ways. The advantages of using this tool over simply uncabing the 16-way are that it doesn't require any

hardware changes and that resources such as PCI slots in an RXE-100 can be shared between the two partitions.

System Partition Manager is an IBM Director plug-in utility that IBM will be releasing with IBM Director 4.1. The agent component will initially be supported on the following operating systems:

- ▶ Windows 2000
- ▶ Windows .NET
- ▶ Red Hat Linux Advanced Server 2.1
- ▶ VMware ESX Server



Components will also be installed on the IBM Director server and all IBM Director consoles.

System Partition Manager uses the following terms:

- ▶ Node — Functionally equivalent to an x440. Also referred to by Active PCI Manager as a chassis.
- ▶ Remote I/O Enclosure — An RXE-100 for example.
- ▶ Partition — A node or group of nodes configured as a single server, with their attached Remote I/O Enclosures (if present). The smallest partition is a single x440 server.
- ▶ Complex — A group of up to four nodes and their attached Remote Expansion Enclosures. A complex can be subdivided into partitions, or can be one big partition.

Table 5-3 shows examples of partitions.

*Table 5-3 Examples of valid partitions using System Partition Manager*

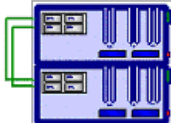
Partitioning options	Diagram
One x440 with two or four processors. This configuration can only be used as one system and cannot be split into smaller partitions.	
One x440 with eight processors. This configuration can only be used as one system and cannot be split into smaller partitions.	
Two x440s with eight processors. This configuration can be partitioned in one of two ways: <ul style="list-style-type: none"> <li>▶ One partition of eight processors</li> <li>▶ Two partitions each with four processors</li> </ul>	

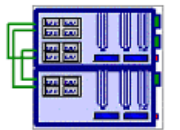
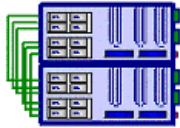
Partitioning options	Diagram
<p>Two x440s, one with eight processors, one with four processors. This configuration can be partitioned in one of two ways:</p> <ul style="list-style-type: none"> <li>▶ One partition of 12 processors</li> <li>▶ Two partitions, one with four and one with eight processors</li> </ul>	
<p>Two x440s with 16 processors. This configuration can be partitioned in one of two ways:</p> <ul style="list-style-type: none"> <li>▶ One partition of eight processors</li> <li>▶ Two partitions each with eight processors</li> </ul>	

Connecting one RXE-100 with 12 slots to two different nodes, referred to as *twin-tailing*, is supported (see Figure 3-10 on page 82).

Although not supported on the x440, the maximum configuration that System Partition Manager supports is four nodes with four processors each and four expansion enclosures. The expansion enclosures are connected, one to each node or twin-tailed between two. This makes possible a partition of 16 processors, 256 GB of memory, and 72 PCI-X adapter slots.

Each partition that System Partition Manager creates will be very similar to the stand-alone servers we use today. Once they are defined, they can:

- ▶ Be powered on and off individually
- ▶ Be capable of supporting one instance of an operating system, or in the case of VMware, one host operating system
- ▶ Have a single, contiguous memory space and access to all associated adapters

The following is a list of characteristics that are in the initial release of System Partition Manager:

- ▶ The IBM Director administrator specifies which nodes (chassis) and Remote I/O Enclosures are members of a complex, and assigns a name to the complex.
- ▶ System Partition Manager is used to define the partitions. A partition of two or more nodes will have one designated as the primary node.
- ▶ The CD-ROM and diskette drives are active on the primary node. The other nodes have their CD-ROM and diskette drives disabled. The other nodes can operate in “headless” mode, which means the server operates without a console (keyboard, video, mouse) attached.

- ▶ System Partition Manager-specific events can be used to generate alerts using IBM Director event action plans. Actions will also include the ability to modify the configuration of complexes, restart partitions, and other activities.

Figure 5-23 shows the IBM Director console with the managed objects introduced by System Partition Manager.

**Note:** Figure 5-23 also shows some Tivoli-specific icons that are not normally found in an IBM Director console. They can be ignored for the purposes of introducing System Partition Manager.

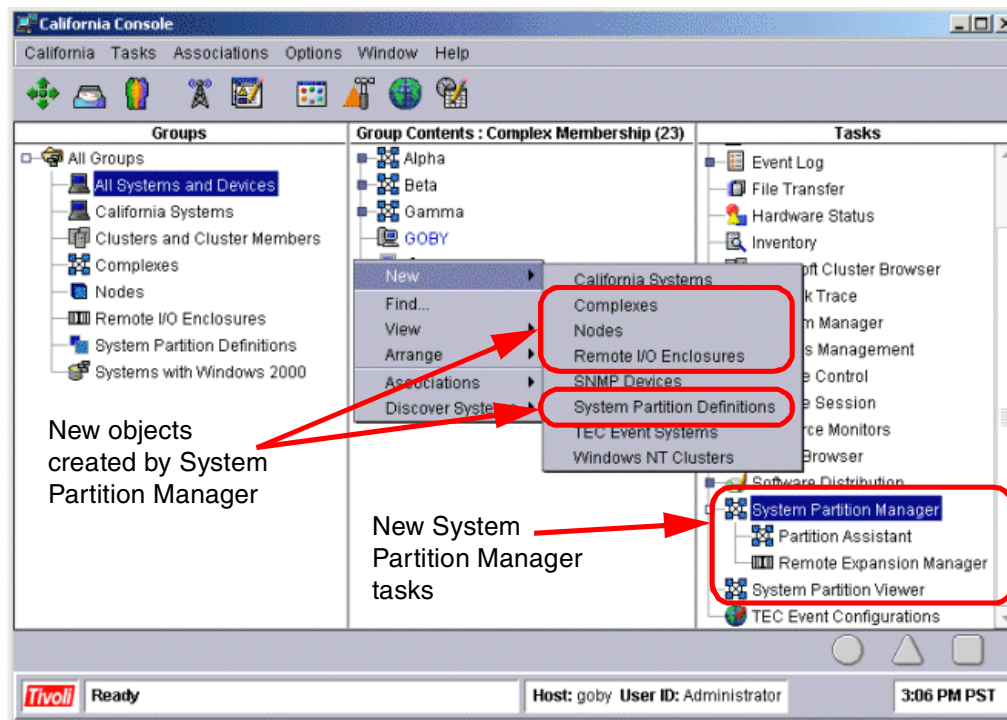

Figure 5-23 System Partition Manager in IBM Director

Figure 5-24 on page 154 shows Partition Assistant, the tool used to define and manage partitions.

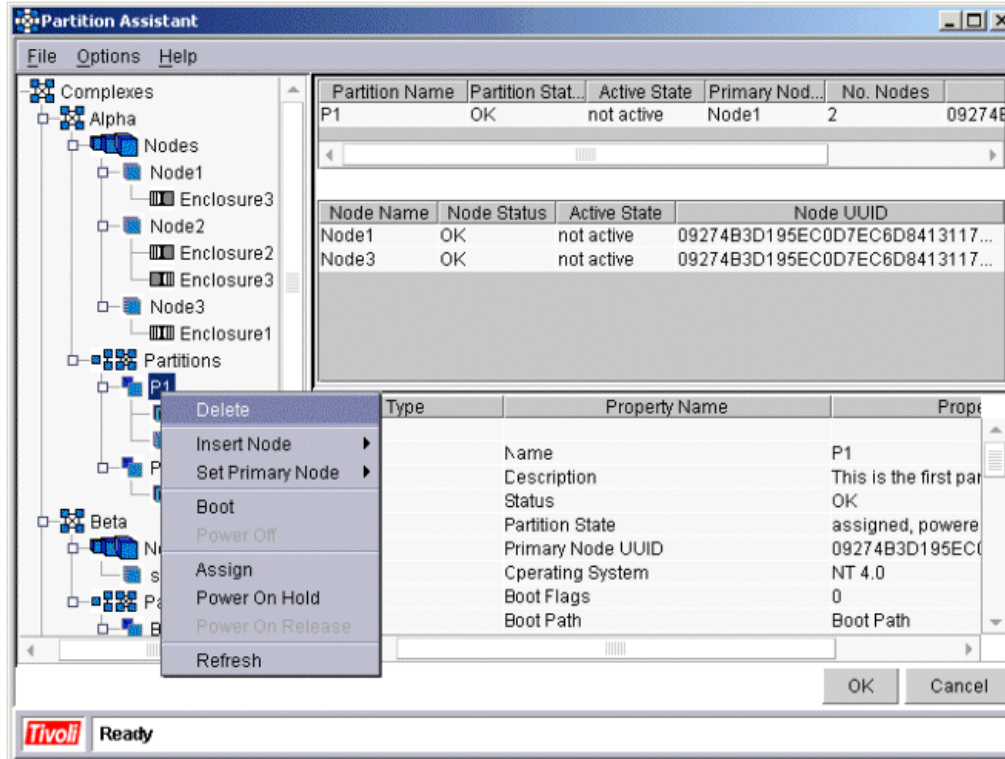

Figure 5-24 Partition Assistant

The tree frame in Figure 5-24 shows the different nodes and external enclosures configured. The icons next to the external enclosure names indicate how they are allocated:

- ▶ indicates that the first (left or A) six PCI slots in the enclosure have been allocated to this node.
- ▶ indicates that the second (right or B) six PCI slots in the enclosure have been allocated to this node.
- ▶ indicates that all 12 PCI slots in the enclosure have been allocated to this node.

In Figure 5-24, Enclosure 3 is connected to both Node 1 and Node 2. The A slots are allocated to Node 1 and the B slots are allocated to Node 2.

Right-clicking a partition in Partition Assistant brings up a menu with the following options:

- ▶ **Delete** — Deletes a partition.



- ▶ **Insert Node** — Associates a node with a partition.
- ▶ **Set Primary Node** — Determines which node will be the primary node.
- ▶ **Boot** — Boots the partition.
- ▶ **Power Off** — Powers off the partition.
- ▶ **Assign** — Writes the partition configuration to the nodes in a partition. Inserting a node and setting a Primary Node do not actually take place until these attributes are assigned to a partition.
- ▶ **Power on Hold** — Powers on all nodes and enclosures in a partition, but does not boot the partition.
- ▶ **Power on Release** — Boots a partition that has previously been powered on but has not booted as a result of the Power on Hold action.
- ▶ **Refresh** — Forces an update of the display of a partition in the Partition Assistant window.

## 5.3 Process Control

Process Control is software for organizing and managing processes and system resources on systems running Windows 2000. Process Control was developed by IBM and built into Windows 2000 Datacenter Server. For xSeries customers, Process Control is also available for use on:

- ▶ Windows 2000 Server
- ▶ Windows 2000 Advanced Server

The Process Control software and user's guide and is available for download from:

<http://www.pc.ibm.com/qtechinfo/MIGR-40610.html>

Process Control provides the following capabilities:

- ▶ Manage two or more processes as a group
- ▶ Server consolidation by the use of CPU affinity and memory constraints
- ▶ Secure servers from unauthorized applications or processes
- ▶ Resource utilization reporting and billing support

Process Control is designed to complement Windows 2000 Task Manager and System Monitor, but not replace them. Configuring Process Control requires administrator privileges on the server.

To uniquely identify processes, they are assigned aliases. This is achieved by creating process alias rules. Once assigned aliases, processes can be arranged into groups and rules applied equally to all members of the group.

The three main types of rules in Process Control are shown in Figure 5-25. They are:

- ▶ Process alias rules
- ▶ Process execution rules
- ▶ Process group execution rules

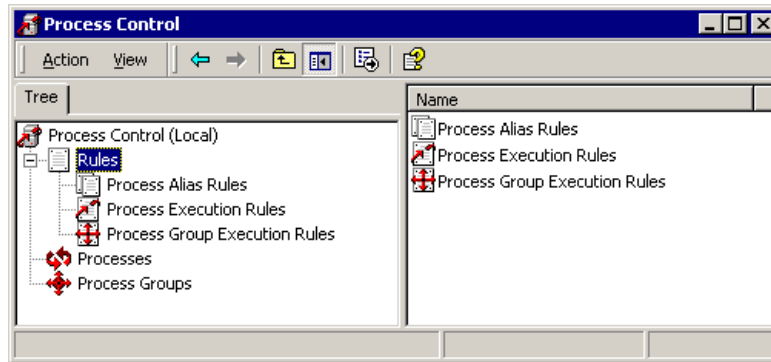

Figure 5-25 Process Control rule types

### 5.3.1 Process alias rules

Windows 2000 uses the process ID associated with each process image name to identify a process (see Figure 5-26). Process IDs change with each invocation of a process and may be reused by the system. However, the use of image name and process IDs can cause identification problems in applications such as Task Manager when multiple processes have the same image name.

The screenshot shows the 'Windows Task Manager' window with the 'Processes' tab selected. The following table represents the data shown in the process list:

Image Name	PID	CPU	CPU Time	Mem Usage
System Idle Process	0	99	59:16:17	36 K
System	8	00	0:00:28	232 K
smss.exe	196	00	0:00:00	596 K
WINLOGON.EXE	220	00	0:00:02	7,484 K
csrss.exe	224	00	0:00:05	1,076 K
services.exe	276	00	0:02:49	6,064 K
LSASS.EXE	288	00	0:00:02	5,628 K
termstrv.exe	400	00	0:00:01	3,760 K
svchost.exe	512	00	0:00:00	3,880 K
spoolsv.exe	540	00	0:00:04	4,560 K
msdtc.exe	572	00	0:00:00	5,380 K
svchost.exe	740	00	0:00:03	5,764 K
ibmhpasv.exe	752	00	0:00:00	1,064 K
ibmbspvc.exe	772	00	0:00:00	804 K
ibmsprem.exe	792	00	0:00:00	1,024 K

Figure 5-26 Task Manager, showing image names and process IDs

It is, however, possible to differentiate two or more processes with the same image name by creating a process alias rule, if they are executed from different directories. Aliases are defined via the use of alias rules.

Creating a process alias rule in Process Control consists of two steps:

1. Identifying a process or group of processes
2. Giving the process or group of processes an alias name

To create a process alias rule, highlight the default process alias rule, and select **Action -> Insert Rule** as shown in Figure 5-27.

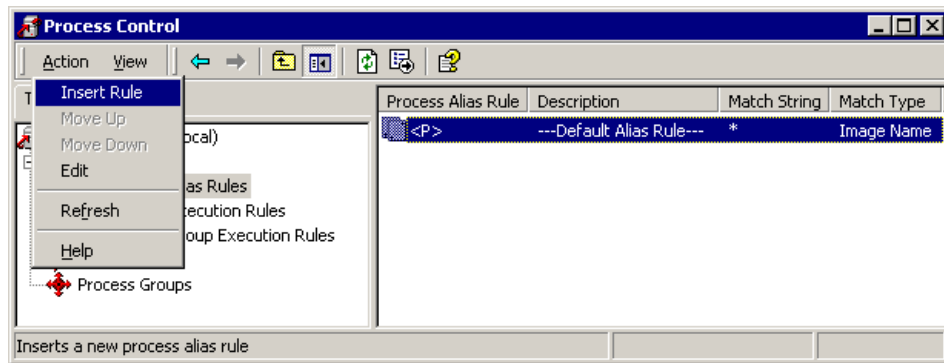

Figure 5-27 Creating a process alias rule

Figure 5-28 on page 158 shows how the process alias is assigned to any process originating in the IBM HTTP Server directory.

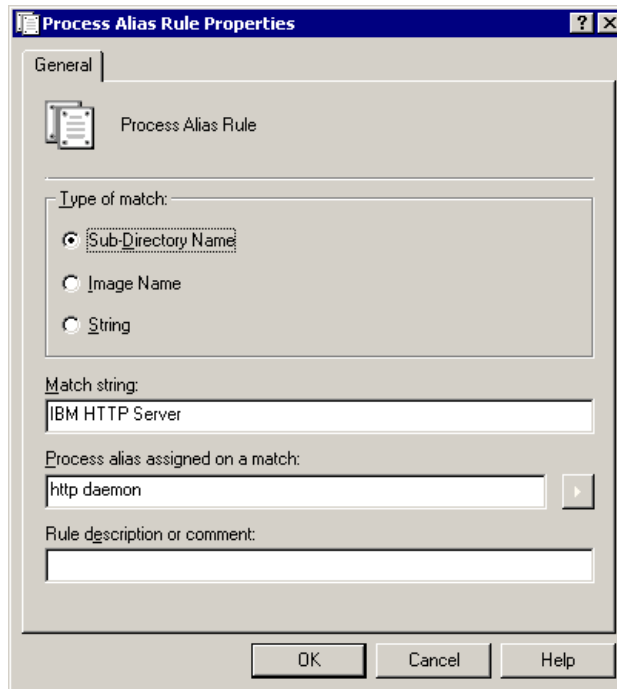

Figure 5-28 Assigning a process alias

Process Control identifies one or many processes based on one of the three following character-matching techniques. Select the method you want to use.

- ▶ Subdirectory name identifies processes based on a directory match.
- ▶ Image name identifies processes based on the process image name.
- ▶ String name identifies processes based on image names, directory matches, or a combination of an image name and a directory.

Wildcards and environment variables can be used in match strings (\*) for all remaining characters and (?) for any character in this position.

**Tip:** Process aliases can consist of any characters except backslash (\), comma (,), or double quotation mark (").

Similarly, we create a process alias rule for all of the processes that are generated from software in the GuildFTPd directory, as shown in Figure 5-29 on page 159.

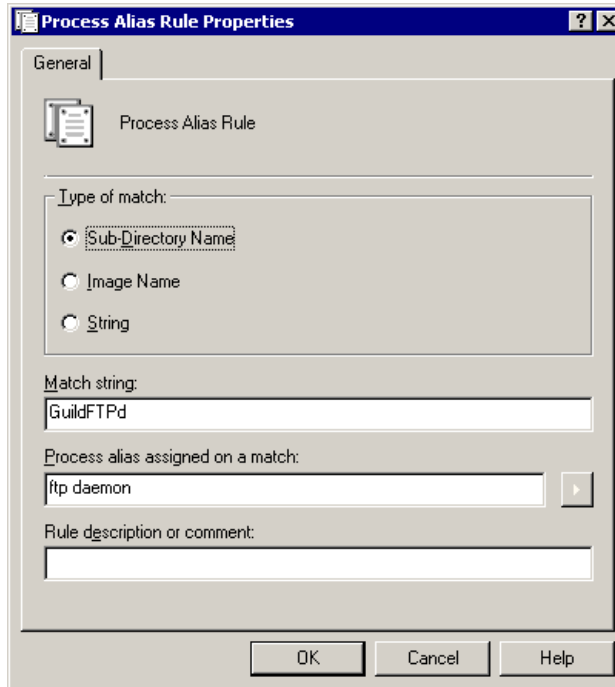

Figure 5-29 Assigning an alias to all processes from the GuildFTPd directory

Once the two alias rules have been created, they are listed as shown in Figure 5-30.

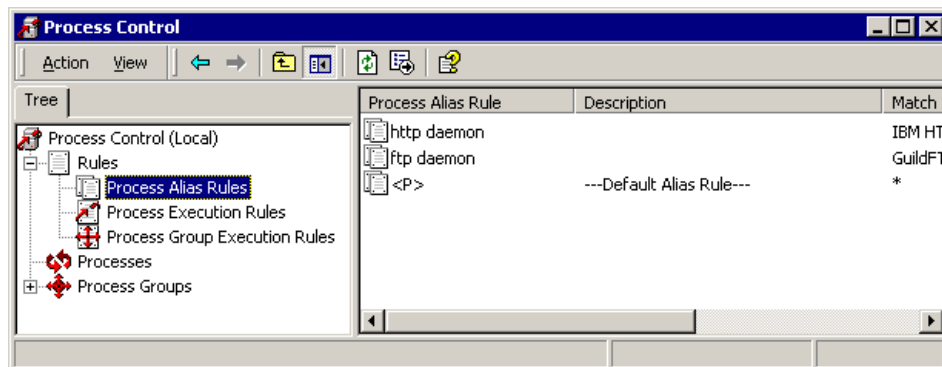

Figure 5-30 List of process alias rules

## 5.3.2 Process execution rules

Now that the processes have been identified by aliases through the use of process alias rules, the next step is to define process execution rules. First identify the process, using the aliases you assigned in the previous step, as shown in Figure 5-31.

**Create Process Execution Rule** ? X

**Process Alias**  
Select the Alias that this rule applies to

Indicate the process alias that this execution rule applies to. The alias name is assigned by one of the process alias rules.

A process alias name may contain any characters except comma, \, or " and is up to 63 characters long. Leading or trailing spaces are not allowed.

Process alias:

Description or comment:

< Back   Next >   Cancel

Figure 5-31 Identify the alias for process execution rule

Click **Next**, and Figure 5-32 on page 161 appears with the option of creating a process group.

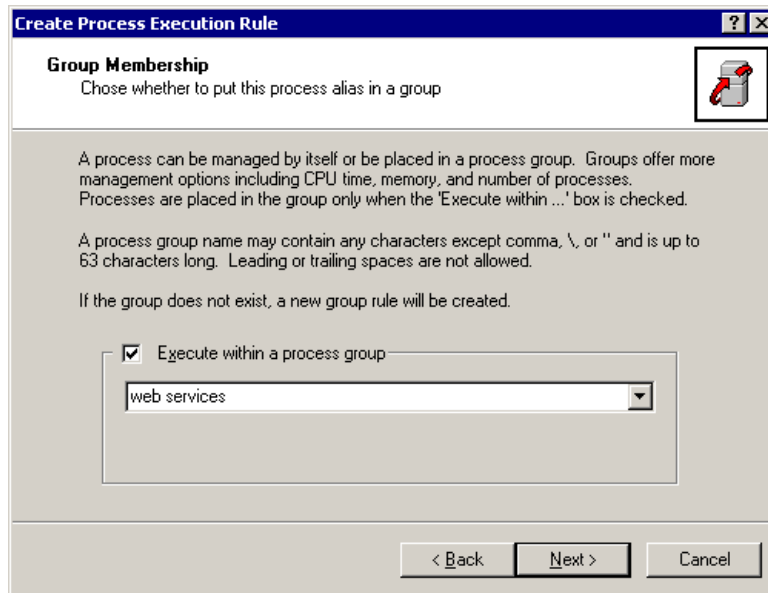

Figure 5-32 Creating a group process alias

We recommend creating a process group, even for one process. Here we are naming a new process group *web services* by typing in its name. You can add processes to an existing group by selecting it from the pull-down menu. Click **Next**.

If you check the box **Execute within a process group**, the fields in the next three windows are all greyed out. This is because you change these settings via group rules, as described in the next section.

### 5.3.3 Group process execution rules

Group process execution rules allow you to control the behavior of a group of processes. We recommend you use groups to aid in process management. To set the rules, right-click the process group and click **Properties**, as shown in Figure 5-33 on page 162.

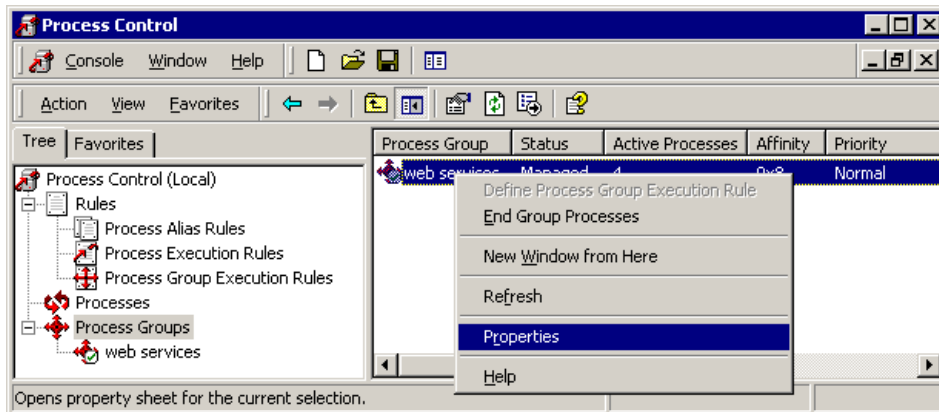

Figure 5-33 Selecting the process group properties

The Properties window for the group appears (Figure 5-34).

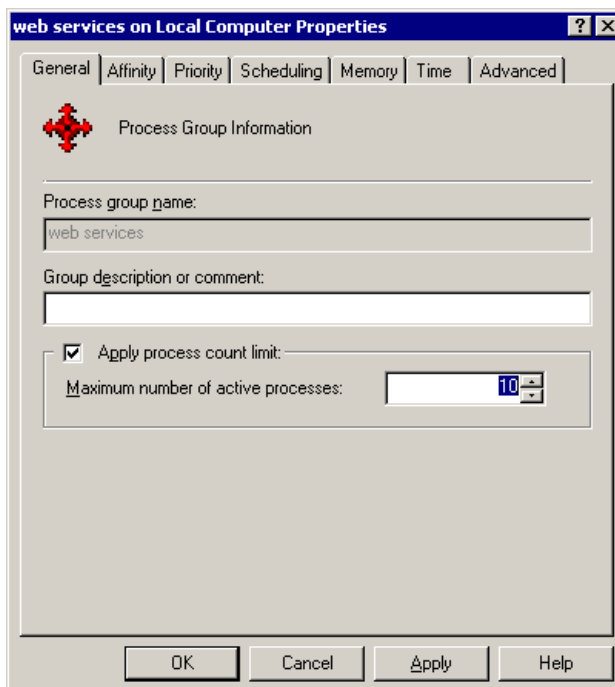

Figure 5-34 Process group general properties

From the General tab, we are able to see the process count limit. Here we have set it to 10. This means that no more than 10 processes can be started from our



group of Web services. This will prevent the overuse of these services and therefore any impact to other processes running on this server. The next tab is the Affinity tab, shown in Figure 5-35.

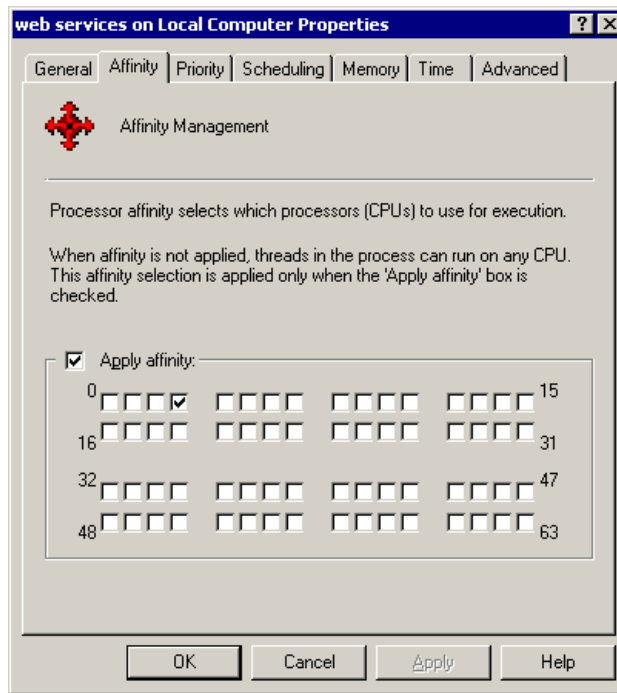

Figure 5-35 Processor affinity

Assigning processor affinity means that the processes in the group execute only on the specified processor(s). In our example, all of our Web services execute on processor 3 (the fourth processor, since they are numbered starting with 0). The ability to determine which processor(s) that different groups of processes execute on is a variation of physical partitioning (PPAR).

The next tab is the Priority tab, as shown in Figure 5-36 on page 164.

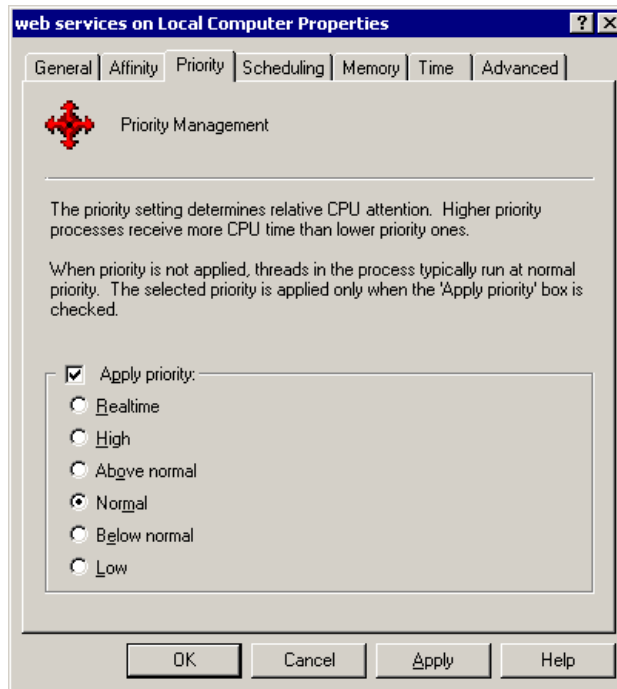

Figure 5-36 Process group priority

Group process priority has the effect of assigning the same process priority to every process in the group. This overrides the priority setting assigned by the application vendor, and ensures that every process in the group is granted equal priority. This prevents any process in the group from consuming a disproportionately large or small number of CPU cycles, in relation to other processes granted the same priority.

**Attention:** Realtime priority (the highest priority class) should be used with great care. It is possible to create a process or process group that does not relinquish control of the CPU(s) long enough for Windows 2000 to perform other important work.

If realtime priority is to be used, you should be sure that the process or group using it cannot consume all the CPUs simultaneously and that other important tasks can run on CPUs that are not potentially blocked by the realtime tasks.

To determine what priority processes have natively run the process, open Task Manager, select the **Processes** tab, select **View -> Select Columns**, and select **Base Priority** as shown in Figure 5-37 on page 165.

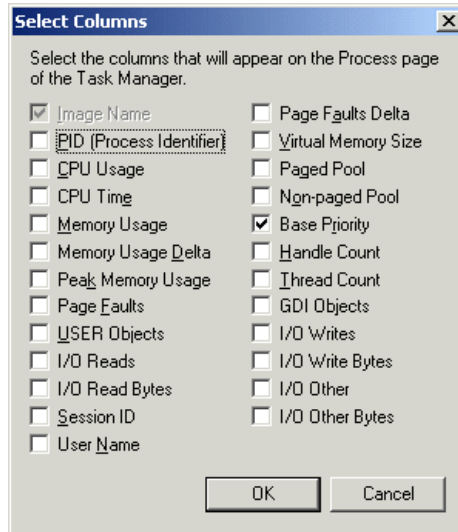

Figure 5-37 Configuring Task Manager to show base priority

In all likelihood, the processes you are interested in have a base priority of Normal, like most of the ones shown in Figure 5-38.

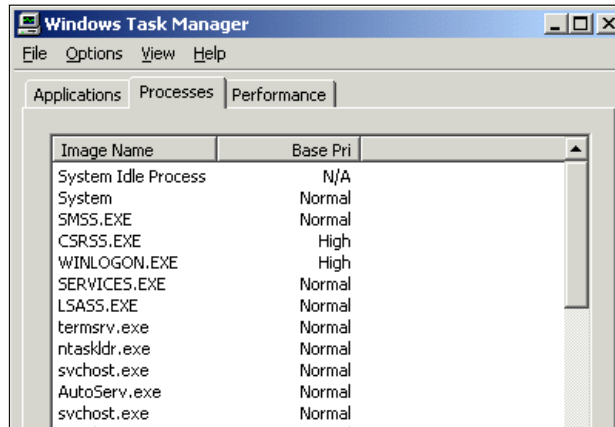

Figure 5-38 Priorities of running processes

Process group priority is rather a coarse setting. Much finer control can be achieved by setting the scheduling class, which is the next tab in the Properties window, as shown in Figure 5-39 on page 166.

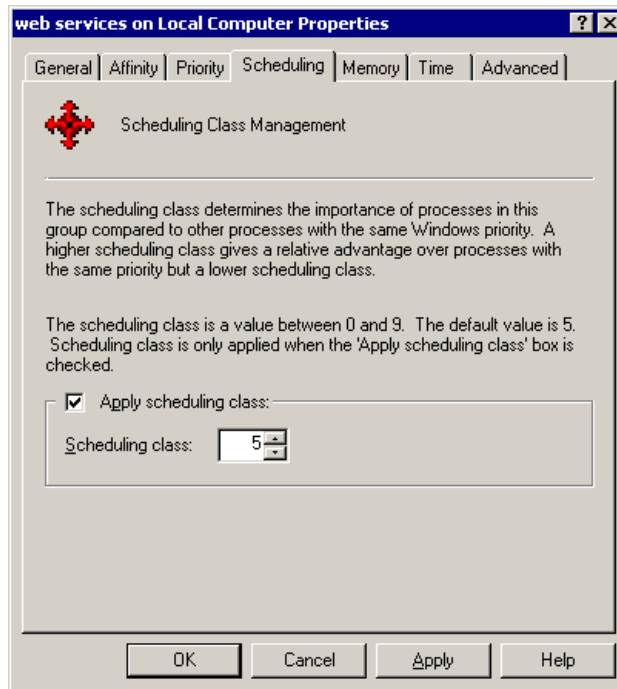

Figure 5-39 Process scheduling class

The process scheduling class determines how much CPU time processes with the same priority are allocated. The next tab in the Properties window is the Memory tab, as shown in Figure 5-40 on page 167.

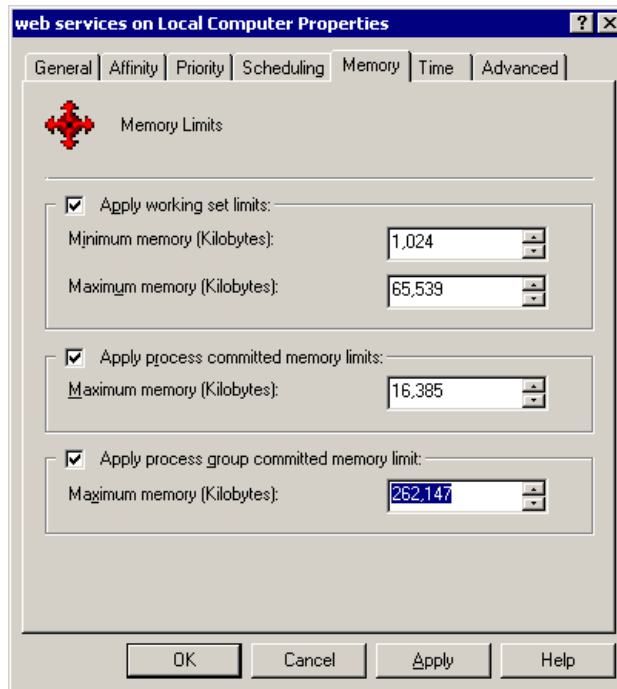

Figure 5-40 Memory limits for processes in groups

This tab lets you set three parameters, which are configured in increments of 1,024 KB:

- ▶ The first one configures working set limits (minimum and maximum). The working set is the physical memory allocated to the process group. If the process group's memory requirement exceeds the maximum size of the working set, the balance will be satisfied by paging to disk, even if there is available memory on the system.
- ▶ The second field defines an upper limit for the memory, physical and virtual, each process can use.
- ▶ The third field sets the total amount of memory that can be used by the entire group of processes.

These settings collectively can prevent any single process or the process group from depriving the rest of the system of needed memory resources, either physical memory or pagefile space.

The next tab on the Properties window, the Time tab, is relevant to batch processes. It is shown in Figure 5-41 on page 168.

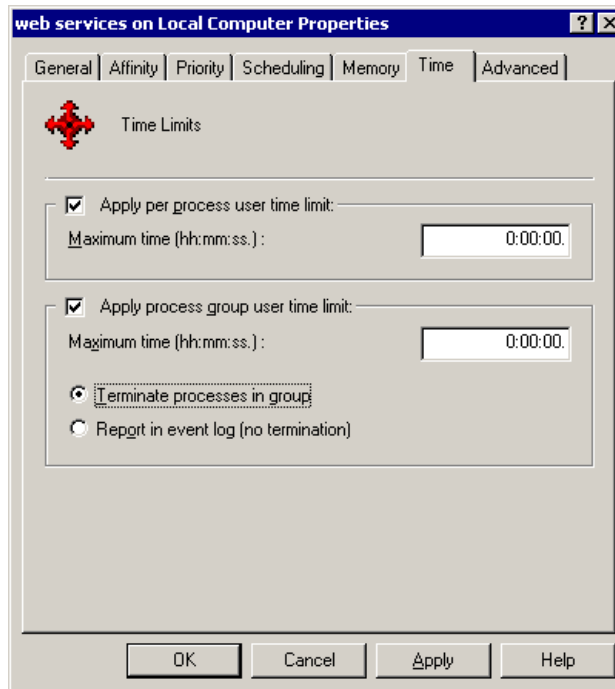

Figure 5-41 Per process and group time limits

There are two options: the first is to limit the amount of time a process is allowed to run, and the second is the amount of time the entire group can use.

This is not elapsed time, but the time the processes actually spend executing on the server. If these limits are exceeded, Process Control can be configured to either terminate the processes or allow them to continue but generate an event in the event log.

**Note:** Process Control does not attempt to shut down a process gracefully. It terminates a process immediately. This may cause data corruption or other undesired results with some applications.

IBM Director can be configured to execute an event action plan based on any entry in to the Windows event log from Process Control. To do this, create a Simple Event Filter and select **ProcCon** as the event type (in the Event Type tab, Figure 5-42 on page 169, uncheck **Any**, and expand **Windows NT Event Log -> System -> ProcCon**).

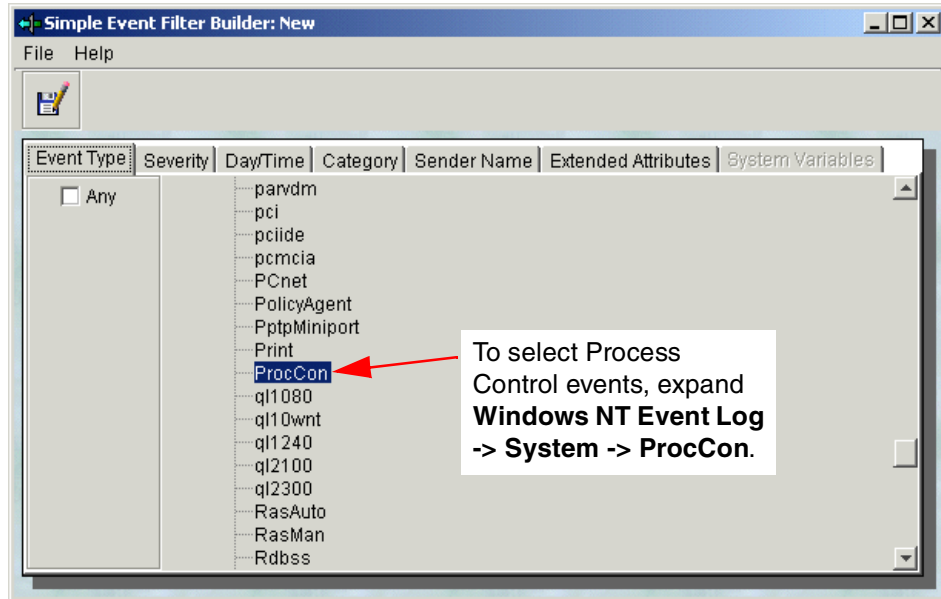

Figure 5-42 Selecting Process Control as the event type in IBM Director

Further details about creating event action plans in IBM Director can be found in several sources, such as the redbook *Implementing IBM Director Management Solutions*, SG24-6188.

The last tab in the Process Control Properties window is the Advanced tab, as shown in Figure 5-43 on page 170.

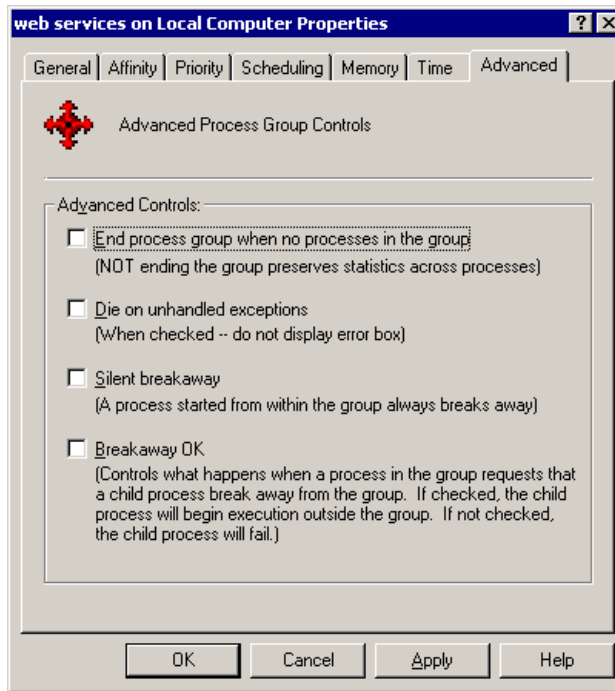

Figure 5-43 Process Control advanced controls

The options in this tab are as follows:

- ▶ End process group when no processes in the group

This is useful to reset the counters for batch processes that are time limited. Deselecting this option allows for accumulating usage statistics for billing purposes. This can be accomplished using the Elapsed Time counter in the Performance tool, as shown in Figure 5-44 on page 171.



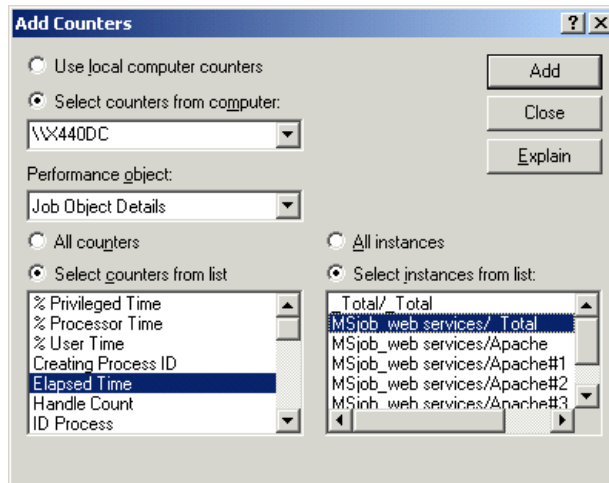

Figure 5-44 Performance monitor counter

- ▶ Die on unhandled exceptions

This option suppresses any windows that may pop up as a result of a process failing, which hopefully facilitates the full completion of the process and the release of committed resources after a process fails.

This should be used on systems that have other management mechanisms in place to alert an administrator that a process has terminated abnormally.

- ▶ Silent breakaway

This causes any process started by the executing process group to execute outside of the process group. This implies that the newly created process will not be subject to the Process Control rules of the parent process. It is, however, now a candidate for Process Control, according to the master list of Process Control rules, and will be subject to the rules on the next management sweep.

By default, Process Control checks once a minute for processes that fit the rules. This parameter is called Process Scan Interval, and is configured from the Process Control Properties window (right-click **Process Control (Local)** in Figure 5-25 on page 156 and click **Properties** then click the **Service** tab).

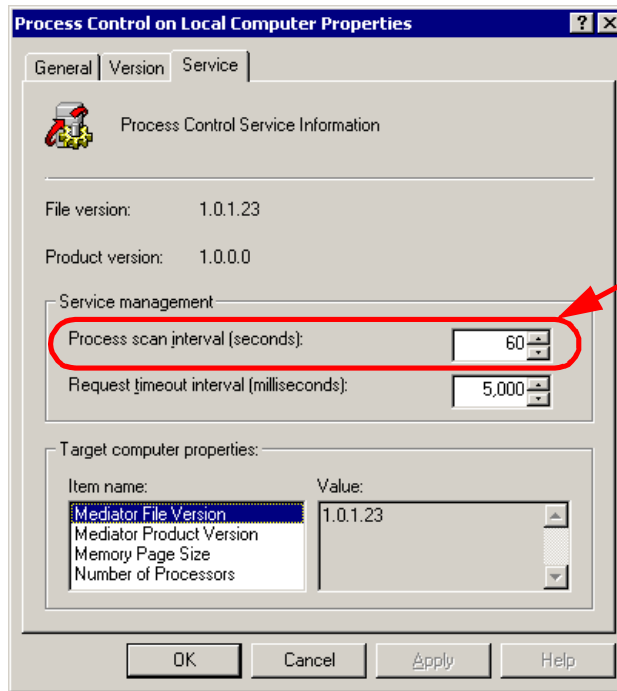

Specify here how often you want Process Control to check for new processes and apply the process alias rules.

Figure 5-45 Process Control scan interval

The other configurable entry, Request timeout interval, is used to determine how long the service will wait for commands from a remote server. If the timeout value is exceeded, control will pass back to the local console.

► Breakaway OK

This parameter is to allow a child process to break away from the process group. If this box is not checked, a child process that tries to break away from the group will not be permitted to execute. This will prevent processes from creating other processes that are not managed under the group's rules.

This may prevent the spread of Trojan horse viruses that enter a system attached to other processes and then attempt to run as services, or under another user's credentials.

Process Control enables a very strict security method. It is possible to grant execution privileges only to specific subdirectories. Make sure these rules are moved to the top of the list of execution rules, because the rules are parsed in top-down order. Then create a rule for subdirectory names that match \* and apply a process count of 0. This will prevent all processes that are initiated from any other subdirectories from executing.

# Abbreviations and acronyms

<b>AC</b>	alternating current	<b>GB</b>	gigabyte
<b>ACPI</b>	advanced control and power interface	<b>GBps</b>	gigabytes per second
<b>APIC</b>	advanced programmable interrupt controller	<b>Gbps</b>	gigabits per second
<b>ASM</b>	Advanced System Management	<b>HA</b>	high availability
<b>ASR</b>	Automatic Server Restart	<b>HAL</b>	Hardware Abstraction Layer
<b>ATS</b>	Advanced Technical Support	<b>HBA</b>	host bus adapter
<b>BASP</b>	Broadcom Advanced Server Program	<b>HCL</b>	hardware compatibility list
<b>BI</b>	business intelligence	<b>HTTP</b>	Hypertext Transmission Protocol
<b>BIOS</b>	basic input/output system	<b>I/O</b>	input/output
<b>CCA</b>	Citrix Certified Administrator	<b>IBM</b>	International Business Machines Corporation
<b>CD-ROM</b>	compact disk read only memory	<b>IBS</b>	International Business Systems
<b>CEC</b>	central electronic complex	<b>ID</b>	identification
<b>CIM</b>	Common Information Model	<b>IEC</b>	International Engineering Consortium
<b>CPU</b>	central processing unit	<b>IIS</b>	Internet Information Services
<b>CRM</b>	customer relationship management	<b>IP</b>	Internet Protocol
<b>DDR</b>	double data rate	<b>ISP</b>	Internet service provider
<b>DDS</b>	Digital Data Storage	<b>IT</b>	information technology
<b>DIMM</b>	dual inline memory module	<b>KB</b>	kilobyte
<b>DLT</b>	Digital Linear Tape	<b>LAN</b>	local area network
<b>DOS</b>	disk operating system	<b>LED</b>	light emitting diode
<b>DP</b>	dual processor	<b>LPAR</b>	logical partition
<b>ECC</b>	error checking and correcting	<b>LTO</b>	Linear Tape Open
<b>EE</b>	Enterprise Edition	<b>MAC</b>	media access control
<b>EMEA</b>	Europe, Middle East, Africa	<b>MB</b>	megabyte
<b>ER</b>	enterprise rack	<b>MCNE</b>	Master Certified Novell Engineer
<b>ERP</b>	enterprise resource planning	<b>MCSE</b>	Microsoft Certified Systems Engineer
<b>ESCON</b>	enterprise systems connection	<b>MP</b>	multiprocessor
<b>ESS</b>	Enterprise Storage Server	<b>MPA</b>	Management Processor Assistant
<b>FC</b>	Fibre Channel	<b>MSCS</b>	Microsoft Cluster Service
<b>FRU</b>	field replaceable unit	<b>NAS</b>	Network Attached Storage
<b>GA</b>	general availability	<b>NBI</b>	NetWare Bus Interface

<b>NC</b>	North Carolina	<b>SRPM</b>	Source Red Hat Package Manager
<b>NEMA</b>	National Electrical Manufacturers Association	<b>SUS</b>	Software Update Subscription
<b>NLB</b>	Network Load Balancing	<b>SVGA</b>	super video graphics array
<b>NS</b>	not set	<b>TB</b>	terabyte
<b>NUMA</b>	non-uniform memory access	<b>TCO</b>	total cost of ownership
<b>OLAP</b>	online analytical processing	<b>TCP/IP</b>	Transmission Control Protocol/Internet Protocol
<b>OS</b>	operating system	<b>TPC-C</b>	Transaction Processing Council-C
<b>PAE</b>	physical address extension	<b>UPS</b>	uninterruptable power supply
<b>PCI</b>	peripheral component interconnect	<b>URL</b>	universal resource locator
<b>PFA</b>	Predictive Failure Analysis	<b>USA</b>	United States of America
<b>PME</b>	power management events	<b>USB</b>	universal serial bus
<b>POST</b>	power-on self test	<b>VM</b>	virtual machine
<b>PPAR</b>	physical partitioning	<b>VPN</b>	virtual private network
<b>PSM</b>	platform support module	<b>VRM</b>	voltage regulator module
<b>RAID</b>	redundant array of independent disks	<b>WW</b>	worldwide
<b>RAM</b>	random access memory	<b>ZIF</b>	zero insertion force
<b>RETAIN</b>	remote technical assistance information network		
<b>RISC</b>	reduced instruction set computing		
<b>ROM</b>	read only memory		
<b>RPM</b>	revolutions per minute Red Hat Package Manager		
<b>RSA</b>	Remote Supervisor Adapter		
<b>SAN</b>	storage area network		
<b>SAR</b>	Solution Assurance Review		
<b>SCM</b>	supply chain management		
<b>SCSI</b>	small computer system interface		
<b>SDRAM</b>	static dynamic random access memory		
<b>SMB</b>	small-to-medium-sized businesses		
<b>SMP</b>	symmetric multiprocessing		
<b>SNMP</b>	Simple Network Management Protocol		
<b>SPM</b>	System Partition Manager		
<b>SQL</b>	structured query language		
<b>SR</b>	standard rack		

# Related publications

The publications listed in this section are considered particularly suitable for a more detailed discussion of the topics covered in this redbook.

## IBM Redbooks

For information on ordering these publications, see “How to get IBM Redbooks” on page 178.

- ▶ *Netfinity Tape Solutions*, SG24-5218
- ▶ *Tuning IBM @server xSeries Servers for Performance*, SG24-5287
- ▶ *Integrating IBM Director with Enterprise Management Solutions*, SG24-5388
- ▶ *S/390 Server Consolidation - A Guide for IT Managers*, SG24-5600
- ▶ *The IBM LTO Ultrium Tape Libraries Guide*, SG24-5946
- ▶ *Implementing IBM Director Management Solutions*, SG24-6188
- ▶ *Server Consolidation with the IBM @server xSeries 440 and VMware ESX Server*, SG24-6852

## Referenced Web sites

These Web sites are also relevant as further information sources:

### IBM sites

- ▶ <http://www.pc.ibm.com/support>  
Main support site for xSeries
- ▶ <http://www.pc.ibm.com/qtechinfo/MIGR-39747.html>  
x440 device driver matrix
- ▶ <http://www.pc.ibm.com/qtechinfo/MIGR-40610.html>  
*Process Control User Guide*
- ▶ <http://www.pc.ibm.com/qtechinfo/MIGR-42067.html>  
x440 HAL for Windows NT 4.0
- ▶ <http://www.pc.ibm.com/qtechinfo/MIGR-42317.html>  
x440 Advanced System Management driver

- ▶ <http://www.pc.ibm.com/qtechinfo/MIGR-42328.html>  
IBM @server xSeries 440 Installation Guide in PDF format
- ▶ <http://www.pc.ibm.com/qtechinfo/MIGR-42423.html>  
x440 hot-plug driver for NetWare
- ▶ <http://www.pc.ibm.com/qtechinfo/MIGR-43369.html>  
Broadcom Ethernet driver for NetWare
- ▶ <http://www.pc.ibm.com/qtechinfo/MIGR-43532.html>  
CPU utilization fix for NetWare
- ▶ <http://www.pc.ibm.com/qtechinfo/MIGR-43675.html>  
Tip about avoiding damaging the centerplane when removing an SMP Expansion Module
- ▶ <http://www.pc.ibm.com/qtechinfo/MIGR-43679.html>  
Tip about NetWare 5.1 automatically rebooting after a shutdown
- ▶ <http://www.pc.ibm.com/qtechinfo/MIGR-43876.html>  
Document *Hints, Tips, and Frequently Asked Questions for the xSeries 440 Quick Reference*.
- ▶ <http://www.pc.ibm.com/qtechinfo/MIGR-4J2QEQ.html>  
ActivePCI Software package
- ▶ <http://www.pc.ibm.com/us/compat/nos/matrix.shtml>  
ServerProven page for information about operating system compatibility
- ▶ <http://www.pc.ibm.com/us/compat/lan/matrix.html>  
ServerProven page for information about LAN adapter compatibility
- ▶ <http://www.storage.ibm.com/hardsoft/disk/fastt/index.html>  
Information on the Fibre Array Storage Technology (FASTT) family of products
- ▶ [http://ibm.com/pc/ww/eserver/xseries/scsi\\_raid.html](http://ibm.com/pc/ww/eserver/xseries/scsi_raid.html)  
Information on SCSI products from IBM
- ▶ <http://ibm.com/pc/ww/eserver/xseries/tape.html>  
Information on tape products from IBM
- ▶ <http://w3.ibm.com/support/assure>  
Solution Assurance (accessible by IBM employees only)
- ▶ <http://www.ibm.com/support/assure/esar>  
eSAR (electronic Solution Assurance Review)
- ▶ <http://www.pc.ibm.com/europe/configurators>  
Configuration tools for EMEA and Asia-Pacific countries
- ▶ <http://www.pc.ibm.com/us/eserver/xseries/library/configtools.html>  
Configuration tools for the US
- ▶ <http://www.pc.ibm.com/ww/eserver/xseries/benchmarks/series.html>  
Benchmark results for xSeries systems

- ▶ <http://www.pc.ibm.com/ww/eserver/xseries/vmware.html>  
Information about VMware on xSeries
- ▶ <http://www.pc.ibm.com/ww/eserver/xseries/windows/datacenter.html>  
Information about the Datacenter Server offerings from IBM

### **Intel sites**

- ▶ <http://www.intel.com/design/xeon/prodbref>  
Information on the Xeon DP processor
- ▶ <http://www.intel.com/design/xeon/xeonmp/prodbref>  
Information on the Xeon MP processor
- ▶ [http://www.intel.com/eBusiness/products/server/processor/xeon/wp020901\\_sum.htm](http://www.intel.com/eBusiness/products/server/processor/xeon/wp020901_sum.htm)  
Whitepaper: *Intel Xeon Processor Family for Servers with Hyper-Threading Technology*
- ▶ <http://www.intel.com/technology/hyperthread>  
Information on Hyper-Threading

### **Microsoft sites**

- ▶ <http://support.microsoft.com/default.aspx?scid=kb;en-us;Q283037>  
Use of the PAE switch to enable more than 4 GB of RAM

### **Novell sites**

- ▶ <http://support.novell.com>  
Main Novell support site
- ▶ <http://support.novell.com/filefinder>  
Search for software updates

### **Red Hat sites**

- ▶ <http://rhn.redhat.com>  
Red Hat Network
- ▶ <https://www.redhat.com/docs/manuals/advserver/RHLAS-2.1-Manual/pdf/rhl-ig-as-x86-en-21.pdf>  
*Red Hat Linux Advanced Server Installation Guide*

### **PCI Special Interest Group sites**

- ▶ [http://www.pcisig.com/data/specifications/lowp\\_ecn.pdf](http://www.pcisig.com/data/specifications/lowp_ecn.pdf)  
Specifications of low-profile PCI adapters

## How to get IBM Redbooks

You can order hardcopy Redbooks, as well as view, download, or search for Redbooks at the following Web site:

[ibm.com/redbooks](http://ibm.com/redbooks)

You can also download additional materials (code samples or diskette/CD-ROM images) from that site.

## IBM Redbooks collections

Redbooks are also available on CD-ROMs. Click the CD-ROMs button on the Redbooks Web site for information about all the CD-ROMs offered, as well as updates and formats.



# Index

## Numerics

03K9309, ASM Interconnect Cable Kit 78  
10K3661, Belkin USB to Serial Adapter 83  
20-stage pipeline 16  
220 V power 103  
22P5298, IBM USB Serial/Parallel Adapter 83  
22P6801, NetXtreme 1000 T Ethernet adapter 73  
22P7801, NetXtreme 1000 SX Fiber Ethernet 73  
31P5998, RXE-100 6-slot Expansion Kit 78  
31P6087, 3.5 m management cable kit 82  
31P6088, 8 m management cable kit 82  
31P6102, 3.5 m Remote I/O cable kit 76, 80  
31P6103, 8 m Remote I/O cable kit 80  
31P6301, NetXtreme 1000T Ethernet adapter 73  
31P8300, 1 GB DIMM 66  
31P8840, 2 GB DIMM 66  
32-bit PCI adapters 69  
32P8340, SMP Expansion Module 17, 64–65  
32P8705, 1.4 GHz Xeon Processor MP 64  
32P8706, 1.5 GHz Xeon Processor MP 64  
32P8707, 1.6 GHz Xeon Processor MP 64  
33L3324, 512 MB DIMM 66  
37L3533, 2.4 GHz Xeon Processor DP 16, 64  
4816-12U, 9-16-way license kit 95  
4816-1BX, Datacenter eight-way preload kit 94  
4816-1DU, 1-16-way license kit 95  
4816-ABX, Datacenter eight-way subscription 93  
4816-ADX, Datacenter 16-way subscription 93  
59P5171, 1.5 GHz Xeon Processor MP 64  
59P5172, 1.9 GHz Xeon Processor MP 64  
59P5173, 2.0 GHz Xeon Processor MP 64  
71P7919, SMP Expansion Module 17, 65  
8687-1AX 94  
8687-1RX 3  
8687-2AX 94  
8687-2RX 3  
8687-3AX 94  
8687-3RX 3  
8687-3RY 3  
8687-4RX 3, 98  
8687-4RY 3  
8687-5RX 3, 98  
8687-6RX 3, 98

8687-7RX 3

## A

Active Memory 19  
    mirroring 21, 108  
Active PCI driver  
    NetWare 122, 124  
    Windows 2000 116  
Active PCI Manager 130–150  
    adapter keying 142  
    Add Card Wizard 137  
    adding adapters 136  
    analysis of existing adapters 144  
    Blink Slot command 139  
    boot devices 145  
    bus number 134  
    chassis number 132  
    configuration optimization 144  
    current speed 134  
    download 130  
    first slot label 133  
    inserting adapters 136  
    keying 142  
    LED status 134  
    lock options 140  
    low profile 134  
    max slot speed 134  
    optimization 144  
    performance analysis 146  
    PME signal 134  
    slot view 132  
    starting 131  
    stopping the adapter 148  
    table view 136  
    tree view 135  
    unit name 133  
    unlisted adapters 141  
    user's guide 131  
    using 132  
    wizard 137  
Active PCI-X 47  
    adapter speeds 70  
    adapter teaming 73

- Advanced Dynamic Execution 16, 45
- affinity 163
- air flow, rack 103
- application integration 51
- application scalability 100
- availability 59

## **B**

- Baan 38–39
- backup solutions 89
- BI 39
- BIOS
  - Hyper-Threading 109
  - memory mirroring 67, 108
  - updates 108
- block diagrams 9
- Broadcom 23
  - adapter teaming 73
- Broadcom driver
  - NetWare 122
  - Windows 2000 116
- Broadcom Gigabit Ethernet controller 23, 72
- business intelligence 39
- Business Objects 39

## **C**

- cabling 103
  - cable management in racks 103
  - Ethernet 23, 73
  - internal SCSI cables 71
  - RXE-100 80
- cache 13, 19, 45
- Capacity Manager 31
- CEC 8, 17
- centralization 51
- Chipkill memory 22, 46
- CIM instrumentation 30
- Cluster Manager 31
- clustering 41, 49
  - virtual clusters 42
  - VMware 41
- Cognos 39
- collaboration 40
- Computer Type 113
- configuration rules
  - See rules
- configuration tools
  - rack configurator 103

- consolidation 36, 49
- CPU affinity 163
- CPU utilization, NetWare 122
- CPUs 12, 64
- CRM 39
- Crystal Decisions 39
- custom HAL 112, 114, 119
- customer relationship management 39
- cyclone chip 7

## **D**

- data integration 51
- database applications 37, 40
- Datacenter Server 92, 94–95
  - eight-way preload kit 94
  - features 93
  - models 94
  - Software Update Subscription 93
- DB2 37, 40
- DDR memory 19
- device drivers 111
- diagnostics 108
- DIMMs 19
  - layout 65
  - maximum 18
  - standard memory 9
- Domino 36
- doors on racks 103
- drive bays 2, 25, 83
- dynamic partitioning 50

## **E**

- Electronic Service Agent 32
- enabling 108
- enterprise applications 37
- enterprise node 2
- Enterprise Storage Server 88
- Enterprise X-Architecture 1
- ERP 38
- eSAR 105
- Ethernet, Gigabit 2, 23, 72
  - adapter teaming 73
- Event Log
  - Process Control 168
- Exchange 36, 40

## F

- fans 24–25
- fault tolerance 67
- features 1, 43
- Fibre Channel storage options 85
- Foster 12–13, 64
- front panel 25
- frontside bus 9, 13

## G

- Gallatin 12–13, 64
  - SMP Expansion Module support 17
- Gigabit Ethernet 23, 72

## H

- HAL 112
- Hardware Compatibility List 111
- hardware configuration 12
- hardware partitioning 7
- HCL 111
- hot-plug PCI
  - See Active PCI
- hot-swap fans 24
- Hyperion 39
- Hyper-Threading 101
  - disabled 15, 110
  - enabling 109
  - Linux 121
  - NetWare 127
  - operating system support 90
  - optimized 91
  - positioning 44
  - technology 14
  - Windows 2000 117

## I

- IBM Director 30, 129
  - Active PCI Manager 130
  - event actions plans 168
  - System Partition Manager 150
- IBM XA-32 chipset 7, 43
- installation 102, 107–128
  - Hyper-Threading 109
  - Linux 119
  - memory mirroring 108
  - NetWare 121
  - VMware ESX Server 128

- Windows 2000 Server 112
- Intel PRO/1000 XT 73
- Intel Xeon Processor DP 16–17
  - positioning 45
- Intel Xeon Processor MP 13–16
  - positioning 44
- interleaving 9
- Invensys 38

## J

- JD Edwards 38

## L

- LEDs, Light Path Diagnostics 26
- Level 3 cache 13
- Level 4 cache 19
- licensing 100
- Light Path Diagnostics 25
  - SMP Expansion Module 18
- Linux
  - compiling drivers 120
  - Hyper-Threading 121
  - installation 119
  - RXE-100 support 121
  - summit kernel 120
- logical partitioning 6, 50
- logical processors 14

## M

- management 129
- Management Processor Assistant 31
- memory 19, 65
  - Active Memory 19
  - Chipkill memory 22
  - disabling during POST 22
  - memory mirroring 21, 67, 108
  - Memory ProteXion 19, 46
  - memory scrubbing 20, 46
  - performance 67
  - ports 65
  - standard DIMMs 3
- messaging 40
- Microsoft Cluster Service 111
- migration 37
- models 2–3
  - Datacenter eight-way 93
  - VMware ESX Server 98

## N

- Navision 38
- NBI.NLM 122
- NetBAY racks 102
- NetBurst architecture 9
- NetWare 29, 91, 97, 121–128
  - Active PCI driver 122, 124
  - Broadcom driver 122
  - Bus Interface driver 122
  - Hyper-Threading support 127
  - Remote Supervisor Adapter 122
  - RXE-100 support 126
- NetXtreme 73
- node 2
- Novell NetWare
  - See NetWare

## O

- OLAP 39
- one Net (NetWare) 97
- one-box clustering 41
- online analytical processing 39
- Onyx 39
- operating systems 28, 90
  - device drivers 111
    - Linux 97, 119
    - NetWare 97, 121
    - VMware ESX Server 98, 128
    - Windows .NET 97
    - Windows 2000 96, 112
    - Windows NT 4.0 EE 95
- Oracle 37–38, 40

## P

- parallel ports 24
- partial mirroring 67
- partitioning 6
  - benefits 49
- PCI bridges 10
- PCI scan order 72
- PCI slots 23
  - RXE-100 78
  - ServeRAID 4H 71
- PCI-X 47
  - See also RXE-100
- PCI-X and PCI coexistence 70
- PCI-X slots in the x440 68
- PeopleSoft 38–39

- performance
  - application scalability 100
  - disk subsystem 88
  - memory configuration 67
- physical consolidation 51
- physical partitioning 7
- pipeline 16
- planning 63–105
- ports 65
- positioning 35–61
- power redundancy 103
- power supplies 24–25
- Prestonia 12, 64
- ProcCon 168
- Process Control 155–172
  - advanced options 170
  - affinity 163
  - alias rules 156
  - breakaway 171–172
  - check for new processes 171
  - CPU affinity 163
  - creating a rule 157
  - download 155
  - ending a task 168
  - event action plans 168
  - execute within a process group 161
  - execution rules 160–161
  - group process execution rules 161
  - group properties 162
  - image name 157
  - logging 168
  - memory limits 167
  - new processes 171
  - priority 164
  - process alias rules 156
  - process execution rules 160
  - process group 161
  - process ID 156
  - processor affinity 163
  - scheduling class 166
  - silent breakaway 171
  - Task Manager 157
  - time to run 168
  - unhandled exceptions 171
  - wildcard characters in image names 158
- processor affinity 163
- processors 12, 64
- product line 2
- product publications 128

publications 128

## Q

quad-pump design 9

## R

rack configurator 103  
rack installation 102  
Rack Manager 31  
RAID 84  
RAID Manager 31  
rear panel 11  
Red Hat Linux 29, 91, 97  
    *See also* Linux  
Redbooks Web site 178  
    Contact us xii  
redundancy 24  
    power 103  
Remote Expansion I/O port 10  
Remote I/O cable 103  
Remote Supervisor Adapter  
    16-way configurations 28  
    connectivity 77  
    driver  
        NetWare 122  
        Windows 2000 116  
    features 27  
    firmware 108  
RS-485 23  
rules  
    memory 66  
    memory mirroring 67  
    PCI slots 69  
    processors 64  
    RXE-100 79  
RXE Expansion Port 10  
RXE-100 78  
    cabling 80  
    Linux support 121  
    NetWare 126  
    slots 79  
    Windows 2000 Server installation 112

## S

S3 driver 117  
SAP R/3 38–39  
SAS 39

scalability ports 18  
scan order, PCI 72  
SCM 38  
scrubbing, memory 20, 46  
SCSI internal cabling 71  
SCSI ports 23  
SDRAM 9, 19  
serial port, not in x440 83  
serial ports 24  
server consolidation 36, 49, 51–61  
    application integration 56  
    availability 59  
    benefits 57  
    business continuity 60  
    centralization 52  
    data integration 55  
    flexibility 58  
    logical consolidation 56  
    physical consolidation 53  
    rational consolidation 57  
    service level agreements 60  
    single point of control 58  
    TCO 58  
    types 51  
    why consolidate? 57  
ServeRAID 84  
    driver  
        NetWare 124  
        Windows 2000 114, 116  
    ServeRAID 4H support 71  
shark 88  
Siebel 39  
single box clustering 41  
SMP expansion cable 103  
SMP Expansion Module 17, 65  
    16-way configuration 75  
    connectivity 75  
    LEDs 18  
    memory 65  
    part numbers 17  
    processors 65  
SMP Expansion Ports 10, 18  
software installation 107–128  
    Linux 119  
    NetWare 121  
    Windows 2000 112  
software partitioning 6  
Software Rejuvenation 32  
Software Update Subscription 93

- Solution Assurance Review (SAR) 104
- SQL Server 37, 40
- standard memory 3
- static partitioning 50
- storage options 83
- Summit chipset 7
- supply chain management 38
- support
  - memory configurations 66
  - operating systems 28, 90
- SuSE 29, 91, 97
- System Availability 32
- system management 129
- System Partition Manager 150–155
  - CD-ROM drive 152
  - complex 151
  - diskette drive 152
  - headless mode 152
  - IBM Director tasks 153
  - maximum configuration 152
  - node 151
  - operating system support 151
  - partition 151
  - Partition Assistant 153
  - partition options 151
  - positioning 48
  - twin-tailing 152
- system partitioning 6, 49
  - benefits 50

## T

- tape backup 89
- Task Manager 14, 118
- TCO 58
- teaming 73
- TotalStorage solutions 85
- Trigger Tool 104
- twin-tailing 152
- twister chip 7

## U

- Ultra 160 SCSI ports 23
- USB ports 23
- USB to serial adapter 83

## V

- vertical position not supported 102

- video controller 23
- video PCI adapters 71
- virtual clustering 42
- VMware ESX Server 6, 29, 92, 98, 128
  - clustering 41
  - models 98

## W

- WebSphere 41
- weight 103
- Windows .NET 29, 91, 97
- Windows 2000
  - Advanced Server Hyper-Threading bug 15, 110
  - Hyper-Threading, affect of 15
  - ServeRAID driver 114
  - support 29, 91
- Windows 2000 Datacenter Server 92–95
  - See also* Datacenter Server
- Windows 2000 Server 96
  - Broadcom driver 116
  - Computer Type 113
  - custom HAL 112, 114, 119
  - Device Manager 116
  - Hyper-Threading 117
  - installation 112
  - RXE-100 112, 118
  - ServeRAID driver 116
  - Service Pack 114
- Windows NT 4.0 EE 95
- winnipeg chip 7

## X

- XA-32 chipset 7
- X-Architecture 1
- XceL4 Server Accelerator Cache 19
  - positioning 46
- Xeon Processor DP 16–17
  - positioning 45
- Xeon Processor MP 13–16, 64
  - compare with Pentium III 16
  - phase 1 models 3, 94, 98
  - positioning 44
- XpandOnDemand 2, 47

## Z

- ZIF socket 13



# IBM <sup>®</sup>SERVER xSeries 440 Planning and Installation Guide

(0.2" spine)  
0.17" x 0.473"  
90 x 249 pages









# IBM <sup>™</sup>@server xSeries 440 Planning and Installation Guide



**Redbooks**

**Describes the technical details of the x440 models**

**Helps you prepare for and perform an installation**

**Covers key IBM Director management tools**

The IBM <sup>™</sup>@server xSeries 440 is IBM's flagship industry standard server and is the first full implementation of the 32-bit IBM XA-32 chipset, code named "Summit", as part of the Enterprise X-Architecture strategy. The x440 provides new levels of high availability and price performance, and offers scalability from two-way to 16-way SMP, from 2 GB to 128 GB of memory, and up to 24 PCI slots, all in one single system image.

This IBM Redbook is a comprehensive resource on the technical aspects of the server, and is divided into five key subject areas:

- ▶ Chapter 1, "Technical description" introduces the server and describes the key features and how they work.
- ▶ Chapter 2, "Positioning" examines the types of applications that would be used on the x440.
- ▶ Chapter 3, "Planning" describes the aspects of planning to purchase and planning to install the x440.
- ▶ Chapter 4, "Installation" goes through the process of installing key operating systems.
- ▶ Chapter 5, "Management" describes how to use the key IBM Director extensions designed for the x440.

A partner redbook is *Server Consolidation with the IBM <sup>™</sup>@server xSeries 440 and VMware ESX Server*, SG24-6852.

## **INTERNATIONAL TECHNICAL SUPPORT ORGANIZATION**

### **BUILDING TECHNICAL INFORMATION BASED ON PRACTICAL EXPERIENCE**

IBM Redbooks are developed by the IBM International Technical Support Organization. Experts from IBM, Customers and Partners from around the world create timely technical information based on realistic scenarios. Specific recommendations are provided to help you implement IT solutions more effectively in your environment.

**For more information:  
[ibm.com/redbooks](http://ibm.com/redbooks)**

## Free Manuals Download Website

<http://myh66.com>

<http://usermanuals.us>

<http://www.somanuals.com>

<http://www.4manuals.cc>

<http://www.manual-lib.com>

<http://www.404manual.com>

<http://www.luxmanual.com>

<http://aubethermostatmanual.com>

Golf course search by state

<http://golfingnear.com>

Email search by domain

<http://emailbydomain.com>

Auto manuals search

<http://auto.somanuals.com>

TV manuals search

<http://tv.somanuals.com>