

# Infoprint Server for iSeries V5

OUTPUT

Printing Systems  
The output of e-business™

Session 47AE - 410168

Mira Shnier

Senior IT Specialist, Printing Systems Division, IBM Canada Ltd.

mshnier@ca.ibm.com

# iSeries Output Architecture

OUTPUT

Printing Systems  
The output of e-business™

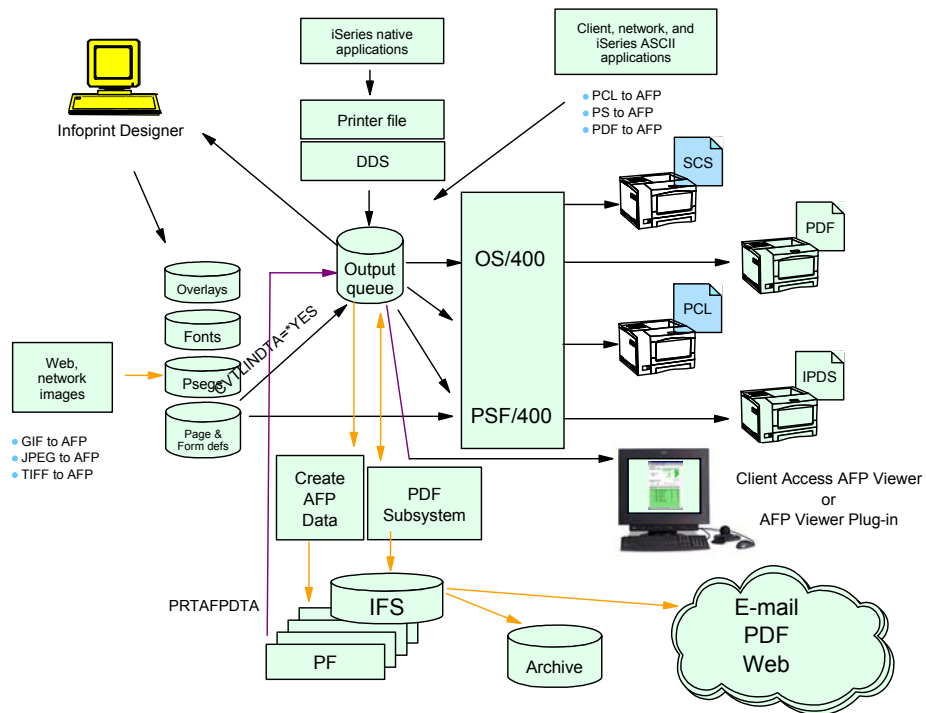



# Enabling "e-output"



- E-business is changing the face of business communications
  - ◆ Traditional information methodology has been "print and distribute"
  - ◆ Networks, Internet, and electronic documents are transforming this methodology
  - ◆ Electronic documents mean:
    - ▶ Tie to pre-printed form is broken
    - ▶ Flexibility in content
    - ▶ Flexibility in delivery
  - ◆ Networks and Internet drives e-business process re-engineering
    - ▶ Printing, if required, must take place later in the flow
    - ▶ Electronic documents and reports can flow as the process requires
- The output of e-business - "E-output"
  - ◆ Ability to create fully electronic pages of information and deliver them to the desired destination in the desired format



## iSeries Print Version 5

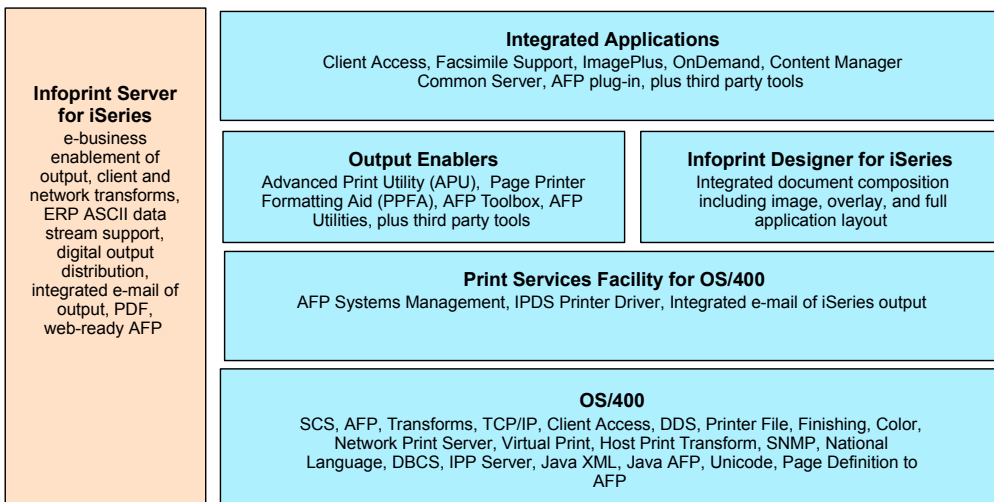

## Infoprint Server for iSeries

### Focus of Infoprint Server

- Electronic Distribution of output
- iSeries management of network print

### iSeries support for PDF

- Transform services for any iSeries standard output (AFP, IPDS, SCS, even OV/400)
- PDF output to e-mail, IFS, or PDF printer
- High-function PDF Server
- Segmentation - "Electronic Burst and Bind"

### Integrated e-mail of output

- PDF output can be automatically e-mailed
- Multiple e-mails based on segmentation
- Exits for customization

### iSeries as a network print server

- PCL, Postscript, and PDF to AFP
- Postscript and PDF transform is IBM-Adobe full-function Level 3

### Portable, web-ready AFP

- Add external resources to AFP data for portability and browser view
- Add indexing for navigation and report segmentation

### Image transforms

- GIF, TIFF, and JPEG transforms to IOCA
- Windows-based



business



## Using Infoprint Server



- Learning by example
  - Scenarios illustrating a business needs
  - How Infoprint Server can help
  - How it works
  - What you need to do to make it happen



## 1. Publish to the Web



- Scenario - monthly reports sent out to departments in hard copy
- Customer would prefer these went on the company Intranet (or Internet)



OUTPUT

Printing Systems  
The output of e-business™

## Publish to the Web - solution

1. An OS/400 application creates the data and puts it on the spool.
2. Use the IPDS to PDF conversion function to store the data in the iSeries IFS.
3. Access the data from a web application or using Client Access.



Printing Systems  
The output of e-business™



# Architecture: PDF Web publishing

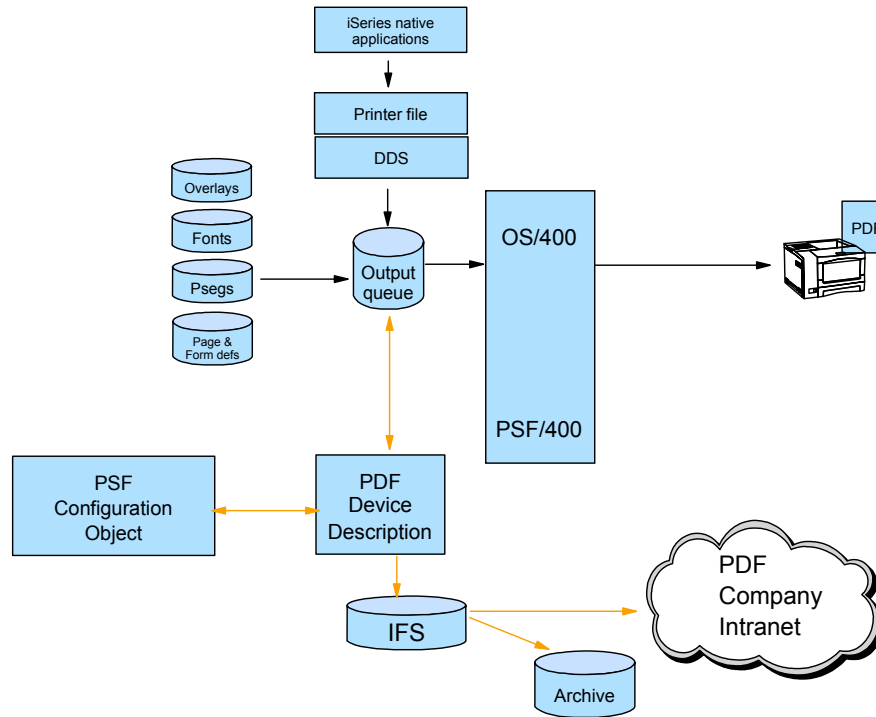

# PDF subsystem setup

- Device Description:
  - Virtual \*IPDS/AFP printer on \*LAN
  - Loopback address (127.0.0.1)
  - Unique Port number
  - USRDFNOBJ Points to PSF Configuration object
- PSF Configuration object
  - Select PDFGEN(\*MAIL/\*STMF/\*SPLF)
  - **Single** or Multiple
  - Destination: Outq, **IFS directory**, or e-mail
  - E-mail mapping program
  - Default SENDER
  - Data queue
  - PDF device type (Recommend: \*IP40300)
  - Paper size
  - Include PDF fonts Y/N

## Using iSeries Navigator to create a PSF Config. Object

The same object can be build using the CRTPSFCFG or CHGPSFCFG commands.

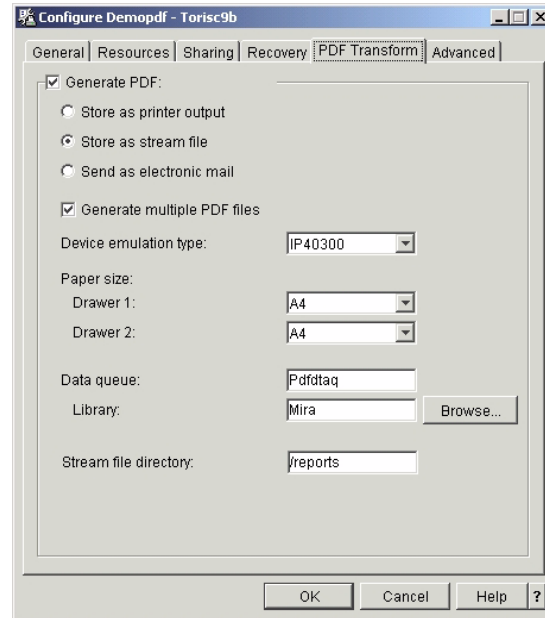

## PDF Output

- PDF transform enables:
  - Re-engineering of output distribution
  - Soft copy repositories for "demand pull" information dissemination
  - Printing directly to PDF-capable printers
  - Integrate with custom e-mail applications
- PDF files in ASCII, full text format
  - Full text output
    - SBCS raster and outline fonts
    - DBCS raster fonts
- Output PDF to:
  - Dynamic e-mail
  - **Integrated File System**
  - **Output queue**

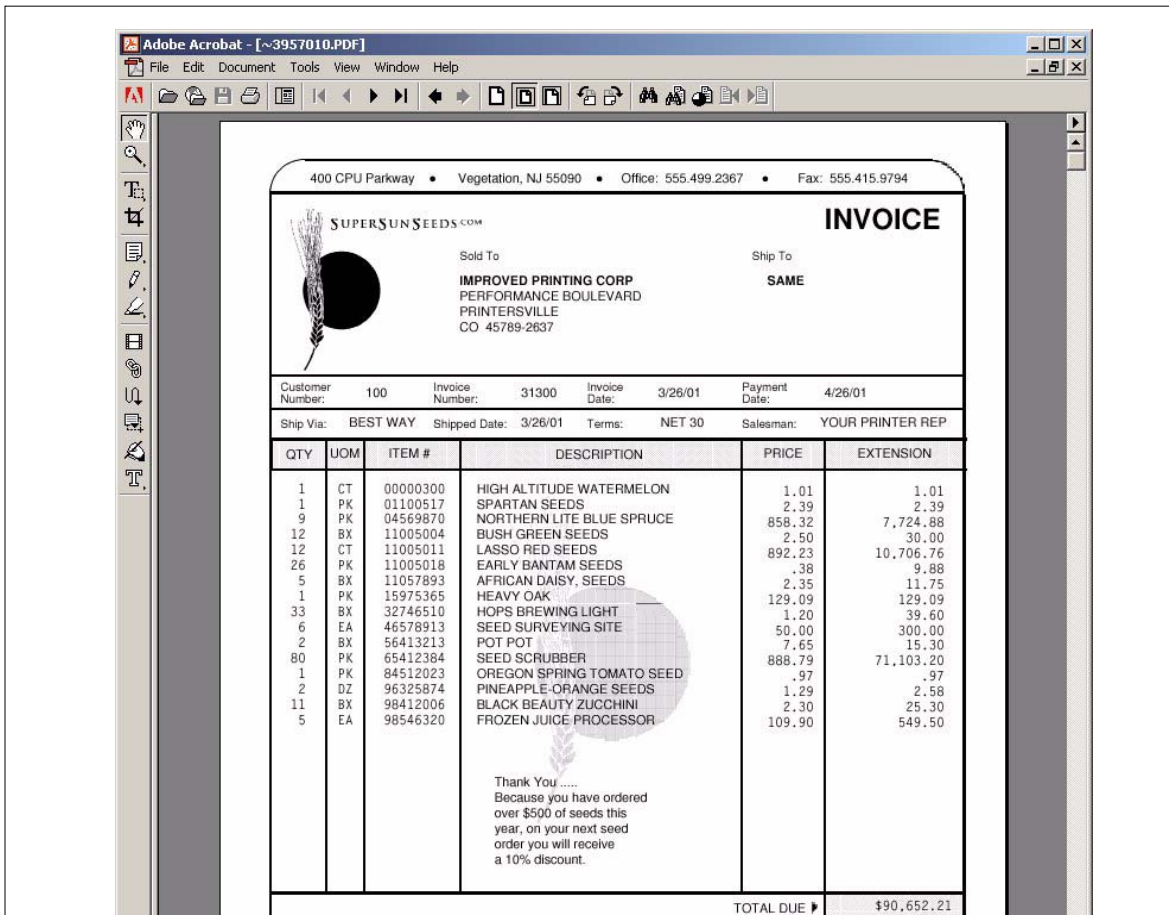



# Target Directory and File Name



If you specify a Root File System directory name, the file will be stored as:

`/PDF-directory-name/job-name/job-user-name+  
/job-number_file-number_spoiled-file-name_date_sequence-number.PDF`

In this example the target was specified as '/reports'

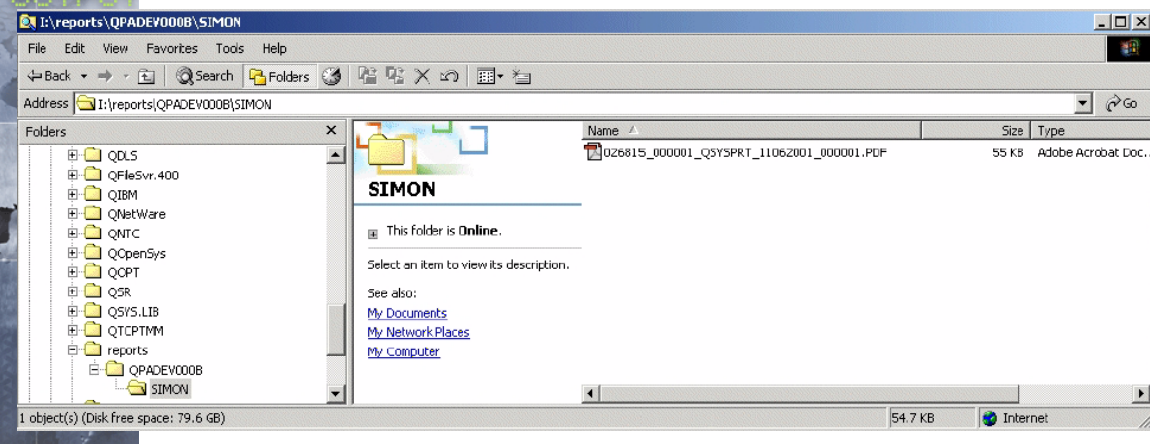





# iSeries Access for WEB PDF support

- Use 5722-XH2

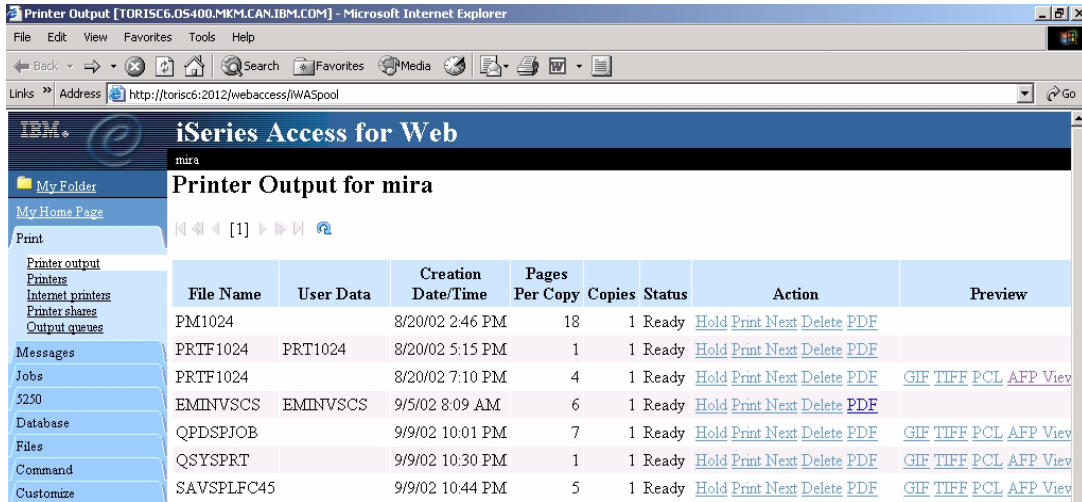

File Name	User Data	Creation Date/Time	Pages Per Copy	Copies	Status	Action	Preview
PM1024		8/20/02 2:46 PM	18	1	Ready	<a href="#">Hold</a> <a href="#">Print</a> <a href="#">Next</a> <a href="#">Delete</a> <a href="#">PDF</a>	
PRTF1024	PRT1024	8/20/02 5:15 PM	1	1	Ready	<a href="#">Hold</a> <a href="#">Print</a> <a href="#">Next</a> <a href="#">Delete</a> <a href="#">PDF</a>	
PRTF1024		8/20/02 7:10 PM	4	1	Ready	<a href="#">Hold</a> <a href="#">Print</a> <a href="#">Next</a> <a href="#">Delete</a> <a href="#">PDF</a>	<a href="#">GIF</a> <a href="#">TIFF</a> <a href="#">PCL</a> <a href="#">AFP</a> <a href="#">View</a>
EMINVSCS	EMINVSCS	9/5/02 8:09 AM	6	1	Ready	<a href="#">Hold</a> <a href="#">Print</a> <a href="#">Next</a> <a href="#">Delete</a> <a href="#">PDF</a>	
QPDSJOB		9/9/02 10:01 PM	7	1	Ready	<a href="#">Hold</a> <a href="#">Print</a> <a href="#">Next</a> <a href="#">Delete</a> <a href="#">PDF</a>	<a href="#">GIF</a> <a href="#">TIFF</a> <a href="#">PCL</a> <a href="#">AFP</a> <a href="#">View</a>
QSYSPRT		9/9/02 10:30 PM	1	1	Ready	<a href="#">Hold</a> <a href="#">Print</a> <a href="#">Next</a> <a href="#">Delete</a> <a href="#">PDF</a>	<a href="#">GIF</a> <a href="#">TIFF</a> <a href="#">PCL</a> <a href="#">AFP</a> <a href="#">View</a>
SAVSPLFC45		9/9/02 10:44 PM	5	1	Ready	<a href="#">Hold</a> <a href="#">Print</a> <a href="#">Next</a> <a href="#">Delete</a> <a href="#">PDF</a>	<a href="#">GIF</a> <a href="#">TIFF</a> <a href="#">PCL</a> <a href="#">AFP</a> <a href="#">View</a>

# iSeries Access for WEB - view PDF

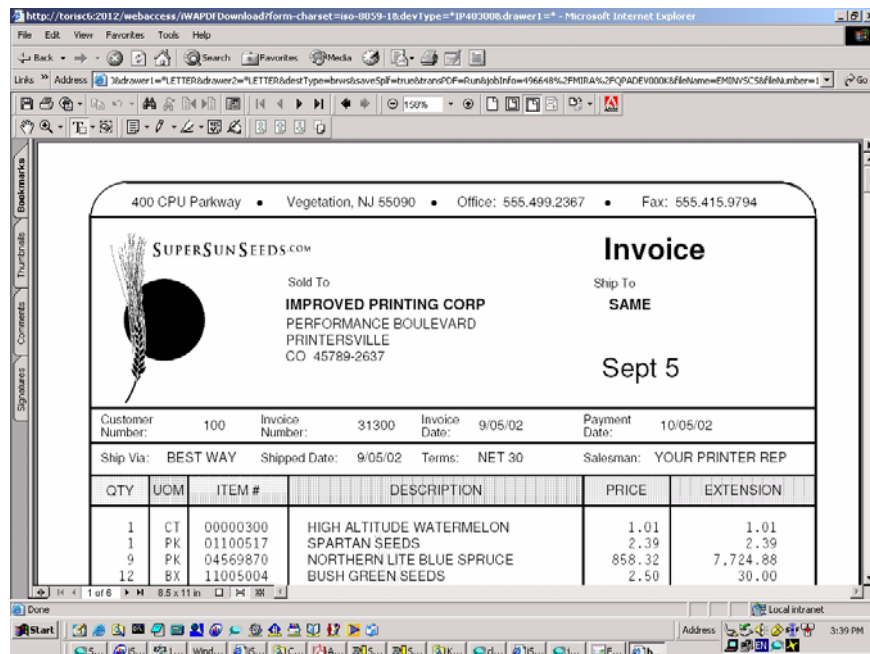

400 CPU Parkway • Vegetation, NJ 55090 • Office: 555.499.2367 • Fax: 555.415.9794

**SUPER SUN SEEDS.COM**

Sold To  
**IMPROVED PRINTING CORP**  
PERFORMANCE BOULEVARD  
PRINTERSVILLE  
CO 45789-2637

Ship To  
**SAME**

**Sept 5**

Customer Number:	100	Invoice Number:	31300	Invoice Date:	9/05/02	Payment Date:	10/05/02
Ship Via:	BEST WAY	Shipped Date:	9/05/02	Terms:	NET 30	Salesman:	YOUR PRINTER REP

QTY	UOM	ITEM #	DESCRIPTION	PRICE	EXTENSION
1	CT	00000300	HIGH ALTITUDE WATERMELON	1.01	1.01
1	PK	01100517	SPARTAN SEEDS	2.39	2.39
9	PK	04569870	NORTHERN LITE BLUE SPRUCE	858.32	7,724.88
12	BX	11005004	BUSH GREEN SEEDS	2.50	30.00



## 2. Electronic Report Distribution

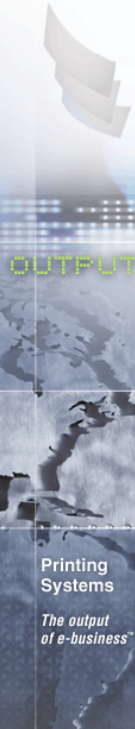

- Scenario - monthly sales reports are printed, manually separated and mailed to regional office managers
- Customer would like to automatically distribute and send the relevant reports to specific managers



Printing Systems  
The output of e-business™



### Electronic Report Distribution - solution

1. Use DDS keywords to insert Group tags in \*AFPDS spooled file.
2. Original spooled file converted to multiple PDF files
3. User exit program converts department name to e-mail address.
4. Each PDF file sent to appropriate regional office as e-mail attachment
  - V5R1 uses SNDDST
  - V5R2 you can use SNDDST or any SMTP server.

(Other methods of segmenting and addressing the file will be discussed later.)

# Architecture: E-mail

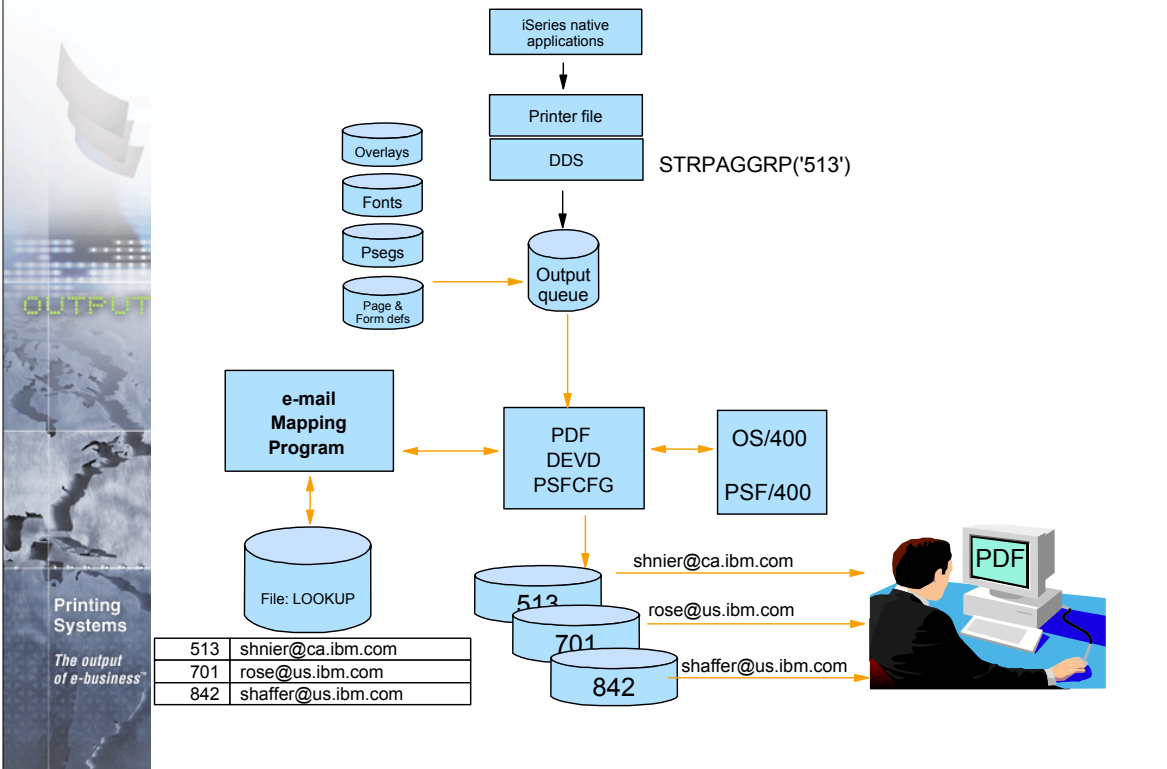

# E-mail address

- Different ways to set e-mail address:
- Depends on single vs. multiple & application
  - Single distribution:
    - USRDFNDDTA('MAILTAG(mshnier@ca.ibm.com)')
    - USRDTA('Dept842')
  - Multiple distribution:
    - group records to define separation points and e-mail tag
      - DDS - use STRPAGGRP/ENDPAGGRP keyword
      - CRTAFPDDTA to insert index records

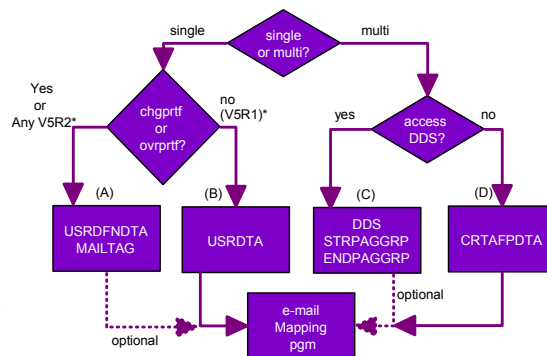

\* On V5R2 you can change USRDFNDDTA with CHGSPLFA after spooled file is created.

## E-mail with exit program

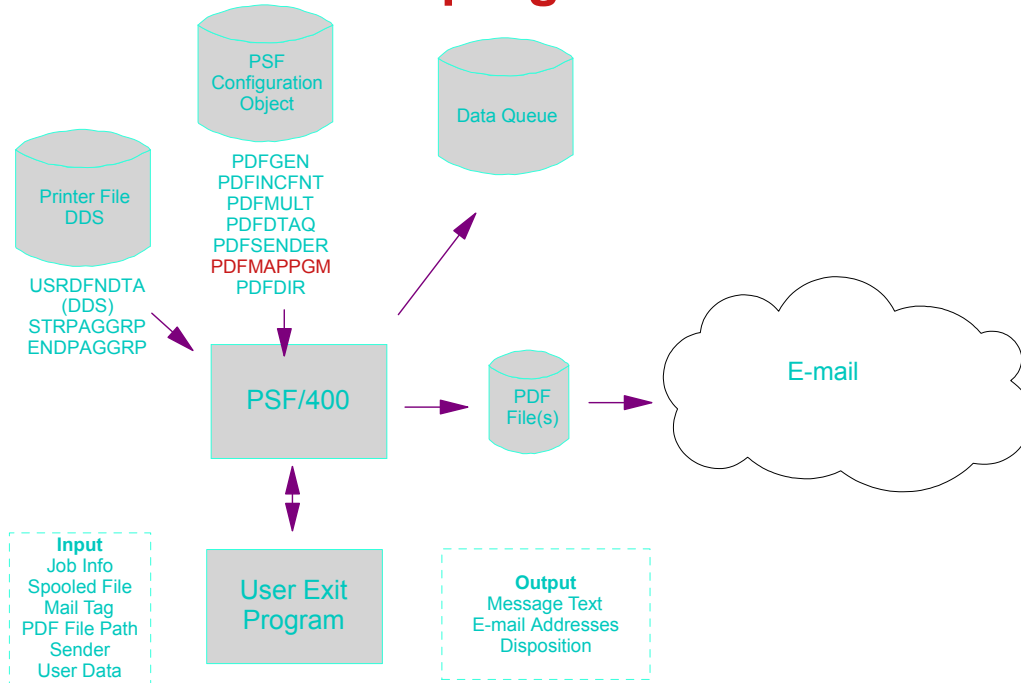

## Use exit program

- if information provided is not a valid e-mail address
  - i.e. convert "Dept842" to "wshaffer@us.ibm.com"
- build a 255 byte message (V5R1)
- imbed additional text or HTML files (V5R2)
- add additional attachments (V5R2)
- change subject line (V5R2)
- decide not to e-mail a file
- some error checking and logging
- make copy of PDF file to IFS
- change security of IFS file (Default is \*PUBLIC gets \*Exclude)
- assign a meaningful name for IFS file

OUTPUT



## Sample e-mail received (V5R1)

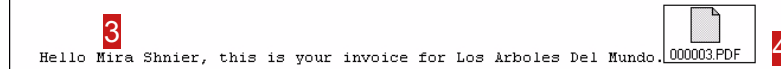
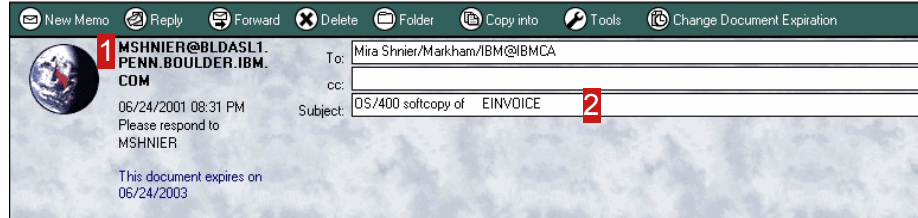

**1**MSHNIER was the user on BLDASL1 who was the "SENDER"

**2**Subject line info comes from PQT4133 in message file QPQMSGF.

- you may "unofficially" modify the first 22 characters

**3**Up to 255 characters of text message may be customized using mapping program.

- (default message is, "Mail was sent by OS/400 process. Please do not reply to this address." Also stored in PQT4133.)

**4**This was the 3rd segment of a file processed as "multiple"

OUTPUT

Printing Systems  
The output of e-business™



## V5R2 enhancements



- Use any SMTP mail server (instead of SNDDST on V5R1)
- Greater flexibility in document content
  - imbed extra text or HTML file
  - add other attachments
  - customize subject line
- **Greater flexibility in addressing**
  - **ReplyTo e-mail address**
  - **:CC and :BCC addresses**
- Index records in spooled file become PDF bookmarks
- iSeries Access for Windows - GUI interface to generate ad-hoc PDF and/or e-mail

OUTPUT

Printing Systems  
The output of e-business™



# Ad-hoc PDF - iSeries Access V5R2



## New Operations Navigator options

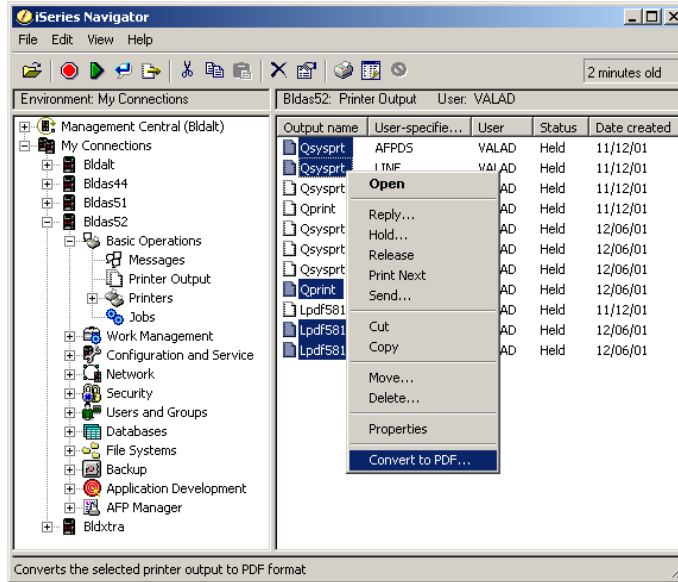

# E-mail

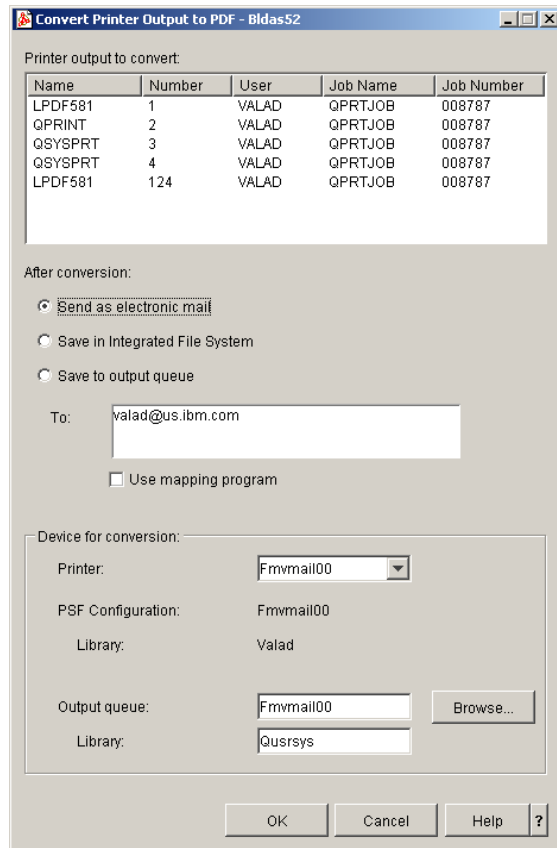



# File size considerations



- By default PDF includes Adobe fonts
- Files may be large if many fonts used
- V5R1 - Use PSFDFNOPT with PDFINCFNT(\*NO) in your PSFCFG (PTF si03186 required)
- V5R2 use PDFINCFNT(\*NO) parameter

File Description	no. of pages	size of PDF	After PTF
Short JOBLOG	2	58 KB	
Medium JOBLOG	19	94 KB	
Long JOBLOG	217	493 KB	
Single Invoice	1	752 KB	52 KB
Multiple Invoices	6	761 KB	59 KB

OUTPUT

Printing Systems  
The output of e-business™



# Improve quality with Outline Fonts



Adobe Acrobat - [~6080862.PDF]

File Edit Document Tools View Window Help

Display Device Description  
5722SS1 V5R1M0 010525

Device description .....: DEVD  
Option .....: OPTION  
Category of device .....:

Device class .....: DEVCLS  
Device type .....: TYPE  
Device model .....: MODEL  
LAN attachment .....: LANATT

Adobe Acrobat - [~4998841.PDF]

File Edit Document Tools View Window Help

Display Device Description  
5722SS1 V5R1M0 010525 BLDA

Device description .....: DEVD PDF  
Option .....: OPTION \*ALL  
Category of device .....: \*PRT

Device class .....: DEVCLS \*LAN  
Device type .....: TYPE \*IPDS  
Device model .....: MODEL 0  
LAN attachment .....: LANATTACH \*IP

- iSeries Raster fonts produces Type-3 pdf fonts
- Note: The difference is only evident when viewing the pdf. Printing both versions produces the same quality results.
- iSeries Outline fonts produces Type-1 pdf fonts
- Use USEOUTLFNT(\*YES) on your PSFCFG to force outline fonts to be used

OUTPUT

Printing Systems  
The output of e-business™



## 3. Print enterprise output on IPDS printers



Scenario:

- Customer uses an ERP output which generates data in PCL format
- They need the speed, power and throughput of their high-speed iSeries system printer - plus the IPDS error recovery

OUTPUT



Printing Systems  
The output of e-business™



Printing Systems  
The output of e-business™



## Print enterprise output on IPDS printers - solution

1. From a Windows workstation, a user submits the document for printing on an IPDS printer using a printer shared though NetServer
2. The document is put on the OS/400 spool and then directed to Transform Manager
3. Transform manager uses the PCL transform to transform the data to AFP
4. The transform sends the AFP data to PSF/400
5. PSF submits the data for printing



## Architecture: Print Serving

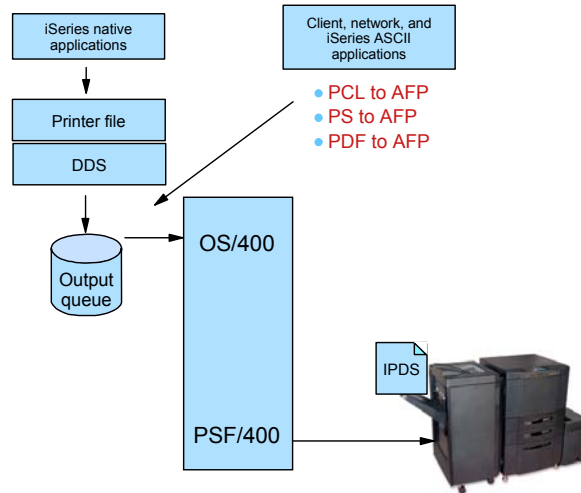

OUTPUT

Printing Systems  
The output of e-business™

## Postscript, PCL, PDF to AFP

- Transforms are integrated into OS/400 architecture
- Provides generic iSeries print support for ERP applications
- Workstation access through LPD, NetServer
- IPP
- Adobe transform for PDF and Postscript to AFP
  - Level 3 full support
  - Developed jointly by IBM and Adobe
  - Equivalent transform on iSeries, xSeries, pSeries, and zSeries
- PCL transform to AFP
  - PCL 5e
- Runs in PASE environment

OUTPUT

Printing Systems  
The output of e-business™



## PCL/PS/PDF to AFP setup



- Transformations based on:
  - PCL vs. (PostScript/PDF)
  - edge-to-edge vs. 1/6" non-print border
- Transformation configuration file specifies how many of each combination: minimum & maximum
- Printer device description includes
  - AFP(\*YES)
  - IMGCFG(\*IMGCnn), where nn is based on print density, edge-to-edge(y/n), image compression
- STRTFMMGR / ENDTRMMGR

OUTPUT

Printing Systems  
The output of e-business™



## 4. Integrate web and network images into iSeries applications



- Scenario - A manufacturer has an engineering drawing application on Windows NT that creates drawings in JPEG format. The manufacturer wants to be able to print the same drawing on a work order, but the work order is a line of business (LOB) document produced by the iSeries.



OUTPUT

Printing Systems  
The output of e-business™

## Integrate web and network images into iSeries applications - solution

- 1. The user sends the image file to the Windows-based JPEG transform to create an AFP image file.
- 2. Next, the user could use the AFP Manager component of Operations Navigator to create the page segment and store it in the iSeries. Alternatively, the user could use a network drive mapped to an iSeries to put the AFP output file in a shared folder, then use OS/400 commands to create it as a page segment on the iSeries.

## Image Transforms

- Windows transforms for GIF, TIFF, and JPEG image files
  - Transform to iSeries image format (page segment)
  - Can be run dynamically via STRPCCMD (Start PC Command)

OUTPUT

# Architecture: Web image

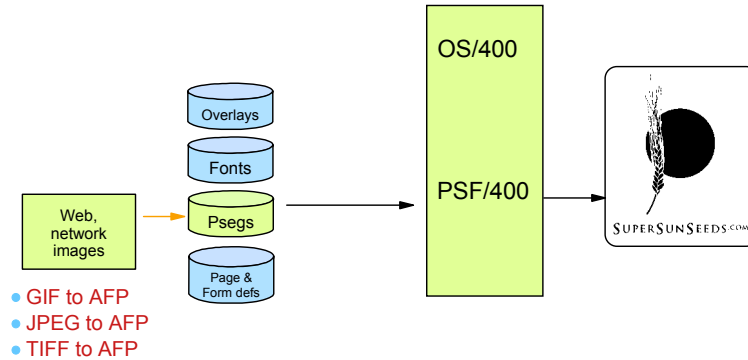

# 5. Indexed data for fast navigation



- Scenario - A phone company creates customer statements using the external formatting capabilities on the iSeries (page definitions and form definitions) together with AFP. This company wants its customer service representatives to be able to view the statements in the same format that the customer receives them.
- The company also wants the customer service representatives to be able to quickly locate a customer's statement for the appropriate month based on the customer's name, phone number, or area code.



## Indexed data for fast navigation - solution

- 1. An application creates the data and puts it on the OS/400 spool.
- 2. The **CRTAFPDTA** command generates the document as an **AFP stream file**, puts the indexing information in an **index object stream file**, gathers all of the needed resources into a **resource stream file**, then concatenates them into a **merged stream file**.
- 3. Users can now view the indexed file on their workstation, send the file for use on another system, or archive the file.

## Architecture: Portable AFP

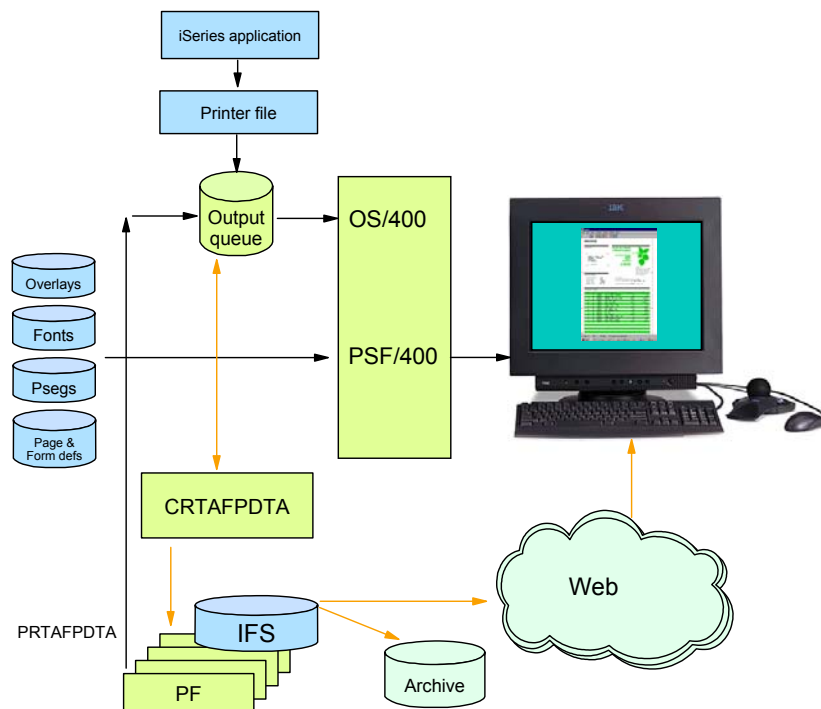



# CRTAFPDTA and CVTLINDTA similarities



- Convert \*LINE data to \*AFPDS (MO:DCA)
  - Use with AFP Viewer
  - Print to non-IPDS printers using HPT
  - Processes the "rules" from Page Definition to create resolved output

OUTPUT

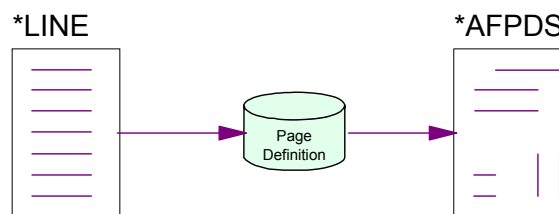

Printing Systems  
The output of e-business™



Printing Systems  
The output of e-business™



# CRTAFPDTA vs. CVTLINDTA differences

CRTAFPDTA	CVTLINDTA
Command with many parameters	Printer file parameter (*YES/*NO)
Input is existing *LINE Spooled file	Input comes directly from application program
Output is Stream file in AFPDS format	Output is *AFPDS spooled file
Part of Infoprint Server Licensed Pgm. (\$)	Free with OS/400
Allows for Indexing and Resource capture	No indexing or resource capture
Portable AFP - print or view anywhere	Print only from same iSeries (PSF or HPT). View with CA Express Ops Nav.

# What else would you use if for?



- Create an index document
  - AFP Viewer - quick access to selected pages
  - PDF generation - index to segment large file and add addressing information for e-mail or generate PDF bookmarks
  - Archive & Retrieve selected groups of pages
- Create a resource group
  - Portable AFP
    - Other iSeries or other platforms
  - Fidelity forever for Archive / Retrieve
    - even if external resources change over time
  - When sending print to an outsourcer
  - AFP Viewer on Web
- Concatenate the AFP, Index and Resource file into one Merged file



## Overview of CRTAFPDTA

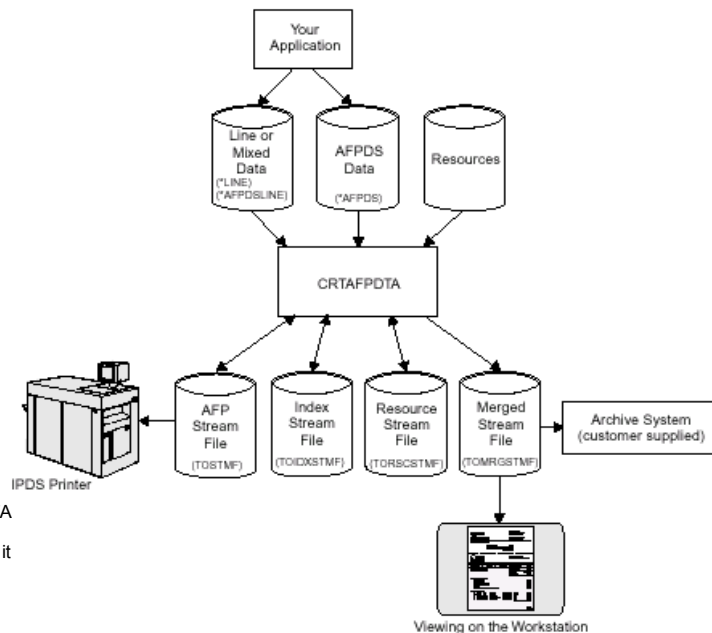

\* The output from CRTAFPDTA must be re-spooled with PRTAFPDTA in order to send it to an iSeries managed printer.



## Scenarios and Server Components

Application	Infoprint Server Component
Publish iSeries-AS/400 output	PDF transform (alternative is Create AFP Data - CRTAFPDTA)
Electronic report distribution	PDF transform, integrated e-mail
Print directly to PDF printers	PDF transform (output to queue)
Electronic burst and bind	PDF transform, segmentation support
ERP print driver	Postscript, PDF, and PCL transforms
iSeries as an enterprise print server	Postscript, PDF, and PCL transforms
Electronic output distribution	CRTAFPDTA, AFP to AFP+, AFP browser plug-in
Print line data to PCL printers, view line data formatted output	CRTAFPDTA OS/400
Index AFP for navigation	CRTAFPDTA
Integrate web/network image into iSeries applications	Image transforms



## iSeries Transforms

	SCS	LINE	AFP	PCL	PS	PDF	Web AFP
SCS	-	Y	Y	HPT	N	IPS	IPS
LINE	Y	-	OS400 V5R1	HPT V5R1	N	IPS	IPS
AFP	-	-	-	HPT	N	IPS	IPS
PCL	-	-	IPS	-	-	-	-
PS	-	-	IPS	-	-	-	-
PDF	-	-	IPS	-	-	-	-
Web AFP	-	-	-	-	-	IPS	-

### What's New

- PCL to AFP
- PS to AFP
- PDF to AFP
- IPDS to PDF
- AFP to AFP Plus
- Line Data to AFP
- GIFF to AFP\*
- JPEG to AFP\*
- TIFF to AFP\*

- Image: TIFF, GIF, JPEG to AFPDS image (IPS)
- SAP to AFP (PrintSuite)
- JDE AFP (OneWorld Xe)

\* Invoked from Windows



# Infoprint Server Architecture

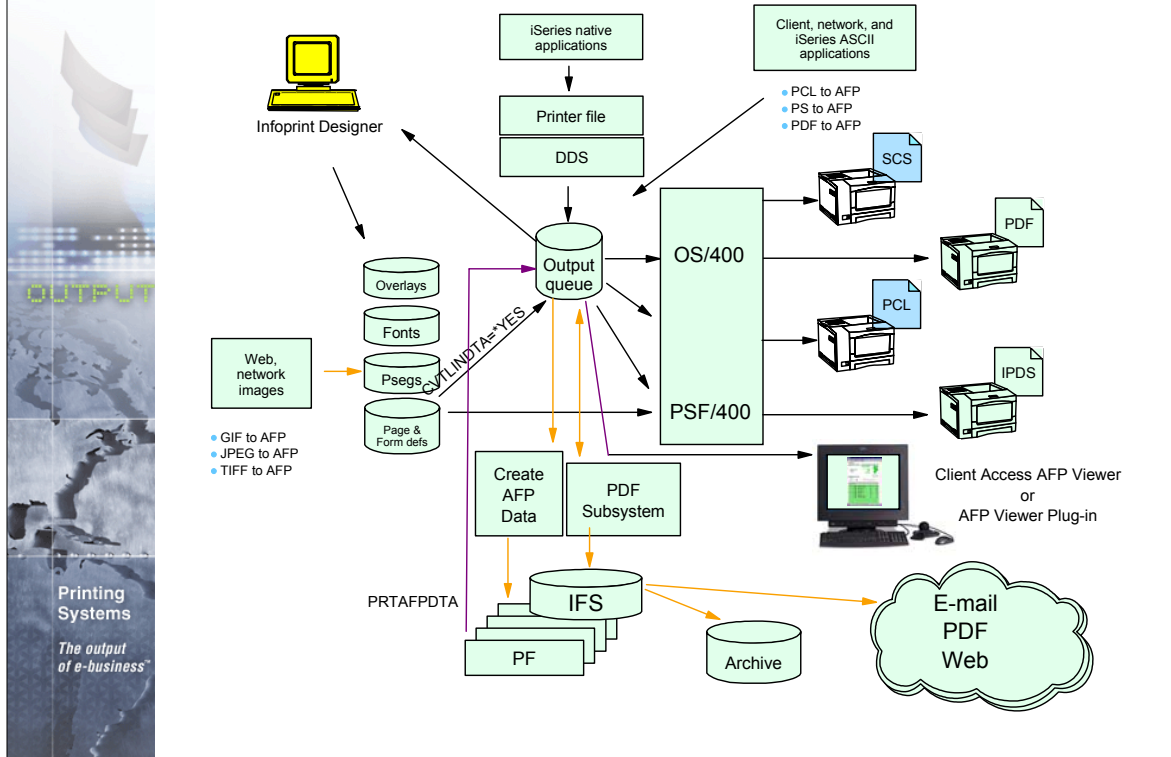

## Infoprint Server: Summary

- Powerful tools to enable "e-output"
- Deliver electronic output to desired destination in the desired format





## Other Print and E-output Sessions



Session Title	Session Number ID	Day/Time
<b>V5 Printing and E-output Overview</b>	409061 42AE	Wed @ 9:30AM
<b>iSeries Output Flow and Architecture</b>	250343 43AE	Wed @ 11:00AM
<b>iSeries Output Application Development</b>	410162 45AE	Wed @ 2:00PM
<b>Infoprint Designer for iSeries</b>	404243 46AE	Wed @ 3:30PM
<b>Infoprint Server for iSeries</b>	410168 47AE	Wed @ 5:00PM
<b>LAB: Infoprint Designer for iSeries</b>	250033 51LC	Thurs @ 8:00AM
<b>V5 Printing and E-output Overview</b>	409061 53IB	Thurs @ 11:00AM
<b>LAB: Infoprint Server for iSeries</b>	410159 54LD	Thurs @ 12:30PM
<b>iSeries Network Printing</b>	403767 56AM	Thurs @ 3:30PM
<b>Color Applications</b>	430038 57AM	Thurs @ 5:00PM

OUTPUT

Printing Systems  
The output of e-business™



## Additional Information



- IBM Printing Systems - [www.printers.ibm.com/series](http://www.printers.ibm.com/series)
- AS/400 - [www.iSeries.ibm.com](http://www.iSeries.ibm.com)
- AS/400 Service and Knowledge Base- [www.as400service.ibm.com](http://www.as400service.ibm.com)
- Online books - [www.as400bks.rochester.ibm.com](http://www.as400bks.rochester.ibm.com)
- Redbooks - [www.redbooks.ibm.com](http://www.redbooks.ibm.com)
- 
- AS/400 Guide to AFP and PSF (S544-5319)
- IBM AS/400 Printing II (GG24-3704)
- IBM AS/400 Printing III (GG24-4028)
- IBM AS/400 Printing IV (GG24-4389)
- IBM AS/400 Printing V (SG24-2160)
- IBM AS/400 Printing VI (SG24-6250)
- AS/400 System API Reference (SC41-5801)
- AS/400 Printer Device Programming (SC41-5713)
- AS/400 Workstation Customization Programming (SC41-3605)
- Infoprint Server Planning (G544-5774), User's Guide (G544-5775)
- Infoprint Designer Getting Started (G544-5773)

OUTPUT

Printing Systems  
The output of e-business™



## Glossary



- **AFP** - Advanced Function Presentation
- **AFCCU** - Advanced Function Common Control Unit
- **AFPDS** - Advanced Function Printing Data Stream
- **API** - Application Program Interface
- **ASCII** - American National Standard Code for Information Exchange
- **BGU** - Business Graphics Utility
- **BMP** - OS/2 and Windows Bitmap
- **BRMS** - Backup Recovery Management System
- **COR** - Computer Output Reduction
- **DJDE** - Dynamic Job Datastream Entry (Xerox)
- **DSS** - Device Support Systems (AIX IpM)
- **EBCDIC** - Extended Binary Coded Decimal Interchange Code
- **Form Def** - Form definition - OS/400 object used to position and format data, text and images on an output page
- **GDF** - Graphical Display File
- **GIF** - Graphics Interchange Format
- **HPT** - Host Print Transform
- **IOCA** - Image Object Content Architecture
- **IPDS** - Intelligent Printer Data Stream
- **IPxxxx** - IBM's Infoprint printers

OUTPUT

Printing  
Systems  
*The output  
of e-business™*



## Glossary - Continued



- **IPM** - Infoprint Manager - AIX, NT and 2000
- **IPP** - Internet Print Protocol
- **LCDS** - Line Conditioned Data Stream (Xerox)
- **LPR/LPD** - Line Printer Requestor/Line Printer Daemon
- **MO:DCA** - Mixed Object: Data Content Architecture
- **MTU** - Maximum Transmission Unit (Internet protocols)
- **Page Def** - Page Definition - OS/400 object used to describe the printed page - Created using PPFA or other tools
- **PPFA** - Page Printer Formatting Aid - A language to define output

OUTPUT

Printing  
Systems  
*The output  
of e-business™*

## Free Manuals Download Website

<http://myh66.com>

<http://usermanuals.us>

<http://www.somanuals.com>

<http://www.4manuals.cc>

<http://www.manual-lib.com>

<http://www.404manual.com>

<http://www.luxmanual.com>

<http://aubethermostatmanual.com>

Golf course search by state

<http://golfingnear.com>

Email search by domain

<http://emailbydomain.com>

Auto manuals search

<http://auto.somanuals.com>

TV manuals search

<http://tv.somanuals.com>