

# 3M

# mobile projector



operator's  
guide



# Contents

Intended Use Statement .....	4
Safety Information .....	4
Safety Labels .....	7
Package Contents .....	8
Parts .....	9
Getting Started .....	10
Making Connections.....	14
Basic Operating Instructions .....	18
Cleaning the Projector .....	22
Troubleshooting .....	23
Specifications .....	25
Limited Warranty.....	27

## Intended Use Statement

The 3M Mobile Projector MP225 is designed to operate with the 3M specified battery and 3M power adapter in normal office or home environments.

- 0°–35°C (32°–95°F)
- 10–80% RH (without condensation)
- 0–1829 m (0–6000 feet) above sea level

The ambient operating environment should be free of airborne smoke, grease, oil and other contaminants that can affect the operation or performance of the projector.

Use of this product in adverse conditions will void the product warranty.

## Safety Information

Please read, understand, and follow all safety information contained in these instructions prior to the use of this projector. Retain these instructions for future reference.

Explanation of Signal Word Consequences	
<b>⚠ Warning:</b>	Indicates a potentially hazardous situation, which, if not avoided, could result in death or serious injury and/or property damage.
<b>⚠ Caution:</b>	Indicates a potentially hazardous situation, which, if not avoided, may result in minor or moderate injury and/or property damage.
<b>⚠ Warning:</b>	Hazardous voltage

**⚠ Warning****To reduce the risk associated with hazardous voltage:**

- Do not modify this product in any way. Use only 3M approved replacement components.
- Do not attempt to service this projector other than battery replacement. There are no user-serviceable parts other than the battery. Service to be performed only by a 3M authorized service provider using 3M approved system components.
- Do not use the wall power supply in a wet environment.
- Do not use with a damaged wall power supply. Replace damaged part prior to use.

**To reduce the risk associated with fire and explosion:**

- Do not immerse the projector or battery in any liquid or allow either to get wet.
- Use only 3M approved power supply and lithium ion battery provided.
- Do not disassemble or short circuit the battery.
- Do not dispose of the battery by incineration or fire.
- Do not operate this projector in any environment above 35°C (95°F).
- Do not expose the projector or battery to direct sunlight in a closed space such as a vehicle.
- Do not carry the battery in pockets, purses or handbags where it may contact metal objects.
- Do not place battery in contact with metal objects.
- Do not expose or store battery in direct sunlight or excessive heat (>60°C [140°F]), or in moist or caustic environments.

**To reduce the risks associated with driver distraction:**

- Do not use this projector in a moving motor vehicle.

**To reduce the risks associated with choking:**

- Keep AV adapters and other small parts away from young children.

**⚠ Warning****To reduce the risk associated with fire and explosion, battery leakage or overheating:**

- Do not immerse the battery in water or allow it to get wet.
- Do not reverse the positive(+) and negative(-) terminals.
- Do not connect the battery directly to a wall outlet. Use only the 3M specified wall charger or automobile charger.
- Do not strike, throw or subject the battery to physical shock.
- Do not pierce the battery or break it open.
- Keep batteries out of the reach of children.
- Do not recharge the battery near a heat source or in extremely hot conditions.
- Do not use the battery if it gives off an odor, generates heat, or becomes discolored or deformed.
- Keep away from exposed flames if the battery leaks or emits an odor.
- Flush the eyes with water and seek medical attention if the battery leaks and battery fluid gets in the eyes.

**⚠ Caution****To reduce the risks associated with hearing loss:**

- Be sure to read earphone manufacturer's instructions with respect to volume level.
- User is responsible to set a safe volume level.

**To reduce the risk associated with environmental contamination:**

- Dispose of all system components in accordance with applicable government regulations.

**To reduce the risks associated with LED bright light:**

- Do not stare directly into the projector lens.

**To reduce the risks associated with tripping and falling:**

- Position the charging cord and data cables so that they are not a tripping hazard.

**SAVE THESE INSTRUCTIONS**

# Safety Labels

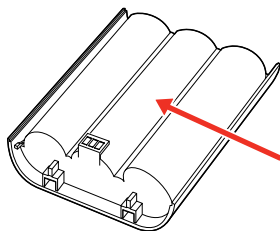

## LITHIUM ION BATTERY

Model No. LIN370-002

23Wh (10.95V 2100mAh)

P/N 78-6972-0058-8

### ⚠ Warning

- Use a specified charger.
- Do not throw the battery into fire or heat.
- Do not short-circuit the battery terminals.
- Do not disassemble the battery.

### Charging Specification

Standard Charge 12.3V/1.1A

Cut Off Voltage 9V

Max Charge 12.3V/2.1A

### LED Light Output

CLASS 1 LED PRODUCT	IEC60825-1 :1993+A1 :1997+A2:2001	Maximum Radiant Power: 1.693 mW
------------------------	--------------------------------------	------------------------------------

# Package Contents

- 1 3M Mobile Projector MP225
- 2 Rechargeable Battery
- 3 Outlet Adapters (4)
- 4 Power Adapter
- 5 Product Warranty and Safety Guide
- 6 Quick Start Guide
- 7 AV Cable for Apple® Devices

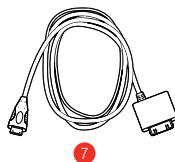
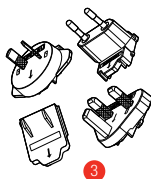
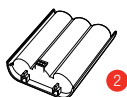
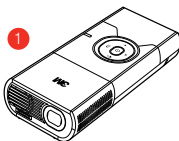



# Parts

- 1 Power Button
- 2 Mute Button
- 3 Volume Down Button
- 4 Volume Up Button
- 5 Battery Status Button
- 6 Status Indicator
- 7 Focus Wheel
- 8 Lens
- 9 Speaker
- 10 Flip Stand
- 11 Tripod Socket
- 12 Battery
- 13 Battery Latch
- 14 Earphone jack
- 15 VGA-A/V Input
- 16 DC Power Input

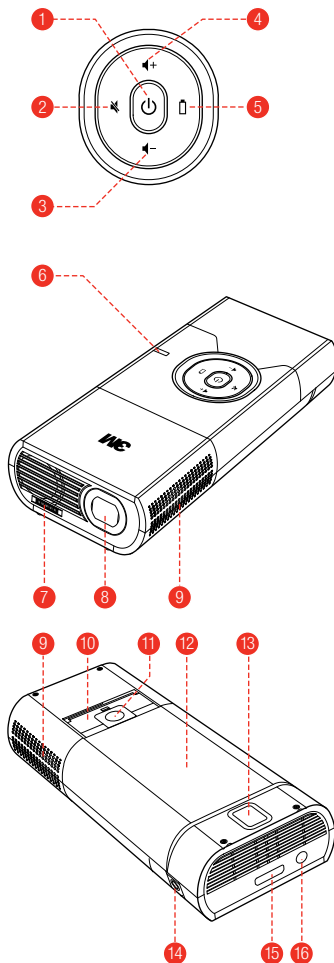

# Getting Started

## Removing the Protective Film

When the projector is shipped, there is a protective film between the battery and the battery contacts on the projector. Remove the protective film by removing the battery and the protective film, discard the film and finally install the battery.

## Install Battery

The 3M Mobile Projector MP225 comes with a rechargeable battery. **The battery should be fully charged before using the projector with the battery.**

To install the battery: point the contacts on the battery toward the contacts on the projector, insert the end farthest from the battery latch first, then push down until the battery clicks into place.

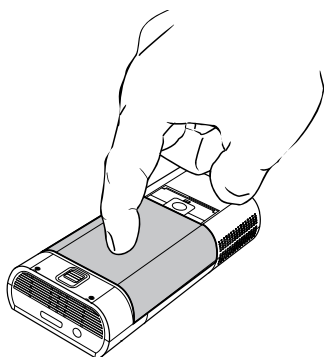
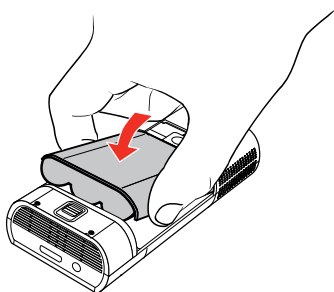

## Remove Battery

To remove the battery: slide the battery latch away from the battery and then lift the battery out, starting at the end closest to the latch.

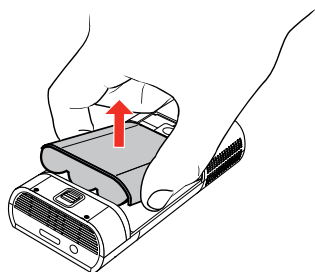
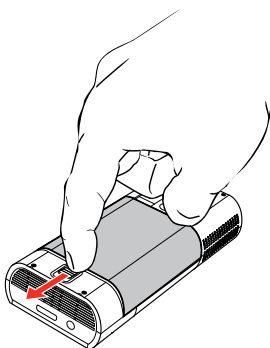

**Important Note:** Use only the 3M specified battery: 78-6972-0058-8.

## Power Adapter

The power adapter is used to charge the battery or power the projector. There are four outlet adapters to give you the flexibility to power the 3M MP225 projector in most countries.

### Installing an Outlet Adapter onto the Power Adapter

- 1 Select the outlet adapter that will plug into your wall outlet.
- 2 Align the outlet adapter to the power adapter and slide the outlet adapter into place.

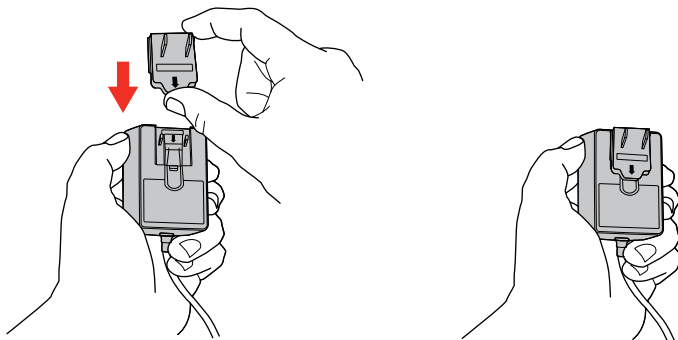

### Replacing the Outlet Adapter

- 1 Push the button on the outlet adapter.
- 2 Slide the outlet adapter up.
- 3 Remove the outlet adapter.
- 4 Replace with the new outlet adapter.

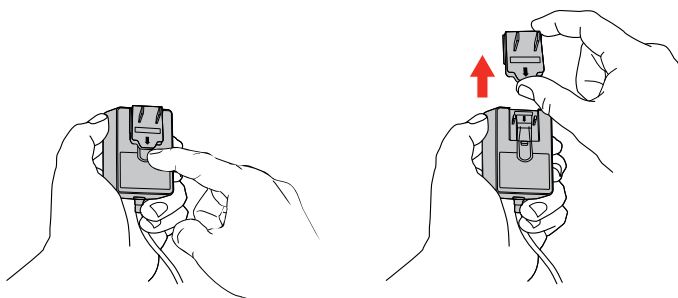

## Charge the Battery

The rechargeable battery gives you up to two hours of battery life. When the battery needs to be charged, the status indicator will flash red. The battery should be fully charged before using the projector.

Charge the battery by connecting the power adapter to the projector.

- 1 Turn the projector power off.
- 2 Connect the power adapter to the projector's DC input.
- 3 Connect the other end of the power adapter into the electrical outlet.
- 4 The status indicator will change to amber while the battery is charging.
- 5 Allow three hours to fully charge the battery. When charging is complete, the status indicator will turn off.

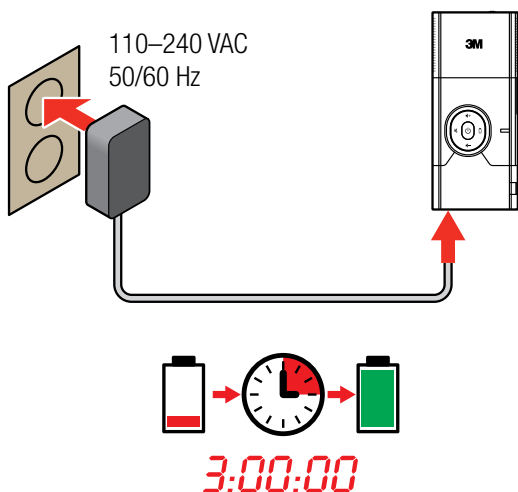

*Note: The battery status will not appear when the power adapter is connected to the projector. The power adapter icon will appear instead.*

**Battery Charging Notes:**

- If the projector power is off, allow three hours for the battery to fully recharge. If the projector power is on, the battery will take longer to charge.
- The battery has a lifespan and ages every time it is fully charged and discharged. The battery will gradually lose charge capacity as it ages. Therefore, as the battery ages the battery life will decrease.

**Battery Maintenance Tips:**

- Remove the battery when the projector will not be used for one week or longer.
- Charge and discharge the battery by turning on the projector at least once a month.
- When storing the battery for more than a month, store it at 50% charge. The battery is at 50% charge when the battery icon has three bars.
- Do not store a fully discharged battery because it may lose the ability to be recharged.
- Do not store a fully charged battery because it may lose the ability to be recharged to full power.

## Making Connections

The 3M Mobile Projector MP225 will display informational icons depending on the input device and signal being detected. The 3M MP225 was designed to operate with the 3M VGA and AV cables only.

### Connecting to Apple® Devices

Use the supplied AV cable to input video from an Apple device into the VGA-AV input on the projector.

Compatible Devices: The New iPad (3rd Gen.)/iPad 2/iPad 1, iPhone 4S/iPhone 4/iPhone 3GS/iPhone 3G, iPhone, iPod Touch 4G/3G/2G, iPod Classic, iPod Nano 5G/4G/3G

### Instructions

- 1 Connect the AV Cable to the projector's VGA-AV input.
- 2 Connect the 30 pin connector to your Apple Device.

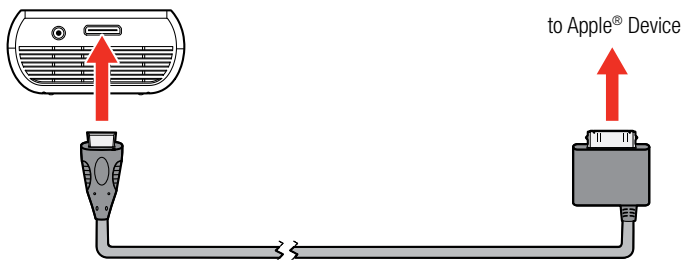

## Connecting to a Composite Video Device (Optional Accessory)

Use the AV cable to input video from camcorders, digital cameras, DVD players and digital media players into the VGA-AV input on the projector.

- 1 Connect the AV cable to the projector's VGA-AV input.
- 2 Connect the other end of the AV cable to the video device's audio and video outputs.

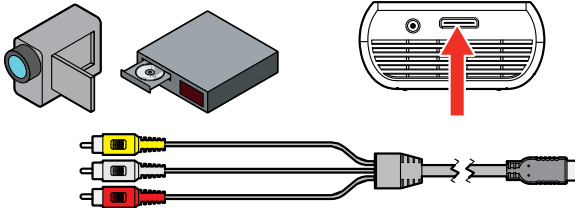

*Tip: Some video devices do not have the standard audio and video connections and may require an AV cable specified by the manufacturer. The AV cable allows you to connect your video device to your TV monitor or your projector and may be purchased from the video device manufacturer. Once you have the AV cable, use the cable adapters to connect the video device cable and the projector cable.*

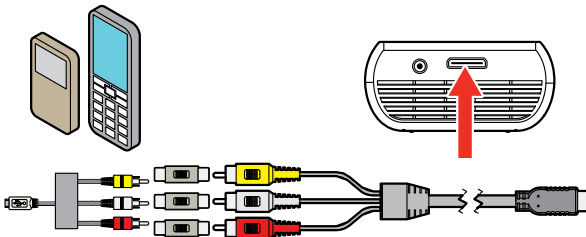

## Connecting to a Component Video Device (Optional Accessory)

For component video input, you must purchase the optional 3M MP225 Component AV Cable [3M part number 78-6972-0032-3]. This cable sends a higher quality video signal for the best possible image.

- 1 Connect the component AV cable to the projector's VGA-AV input.
- 2 Connect the other end of the AV cable to the video device's audio and video outputs.

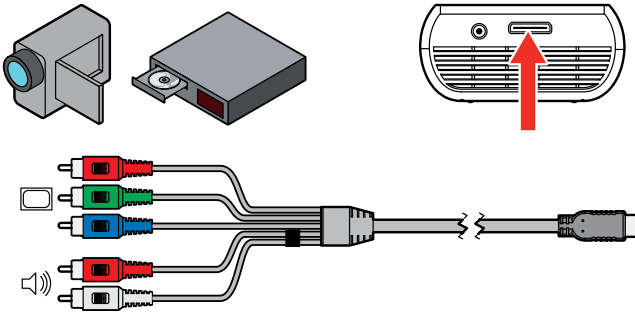

**Important Note:** There are two red connectors on the Component AV cable. One is for the right audio channel and the other is for the Pr component video signal. Be careful to connect the red audio to red audio and red video to red video. If these connectors are switched, the projected image will appear green and an abnormal noise will come from the right speaker.

**Tip:** Some video devices do not have the standard audio and video connections and may require an AV cable specified by the manufacturer. The AV cable allows you to connect your video device to your TV monitor or your projector and may be purchased from the video device manufacturer. Once you have the AV cable, use the cable adapters to connect the video device cable and the projector cable.

Some video devices, by default, will not output a video signal. The video device's manual should provide instructions on how to change the video output setting.

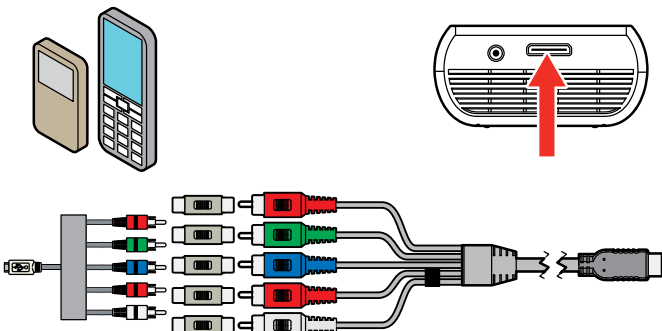



## Connecting to a Computer (Optional Accessory)

Use the VGA-audio cable to connect the projector to desktop computers, laptop computers, ultra-portable computers and some personal digital assistants (PDAs). The projector supports VGA, SVGA, XGA, and WXGA resolutions. For best results, set the computer's resolution to SVGA (800x600).

- 1 Connect the VGA cable to the 3M Mobile Projector MP225.
- 2 Connect the VGA cable to the computer's video and audio outputs.
- 3 Set the computer resolution to one of the supported resolutions.

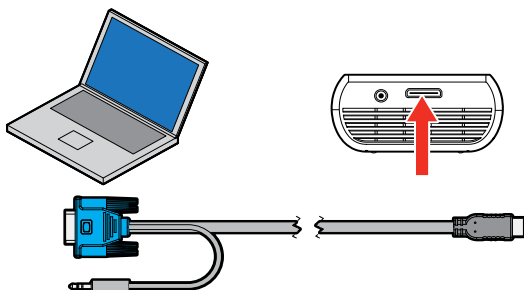

Description	Resolution (width x height)	Refresh Rate
VGA	640 x 480	60 Hz
SVGA	800 x 600	60 Hz
XGA	1024 x 768	60 Hz
WXGA	1280 x 768	60 Hz
	1280 x 960	60Hz
	1440 x 900	60Hz
MAC	640 x 480	67Hz
	832 x 624	75Hz
	1152 x 870	75Hz

# Basic Operating Instructions

## Powering On

Press and hold the power button for three seconds. Release the power button when the projector begins to project an image and the status indicator turns green.

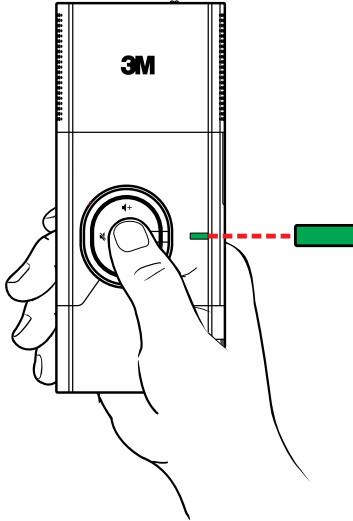

00:00:03

*Tip: The video output on some devices is turned off by default. Please refer to the device's documentation for details on enabling the video output.*

## Powering Off

Press and hold the power button for three seconds. Release the power button when the projected image is gone. The projector is off when the status indicator is off or solid amber. When the status indicator is solid amber, the battery is charging.









## Status Indicator Light

The status indicator light provides information about the projector's state.

Status Indicator Light	Meaning
Flashes green three times	A new power source is connected to the projector and the projector is ready to be powered on.
Blank	Projector is off. If the power adapter is connected to the projector, and the battery is installed, the battery has finished charging.
Flashes green	The projector is starting up.
Solid green	The projector is on.
Solid amber	The projector is off and charging the battery.
Flashes amber	The projector has overheated and needs to cool.
Flashes red twice and pauses then repeats	The projector cannot charge the battery.
Flashes Red	The projector cannot turn on because the battery needs to be charged.

## On Screen Icons

The projector will display a video icon when it is connected to a video cable or a video source.

Icon	Description/ Meaning
	The projector detects the audio/video cable.
	The projector detects an NTSC video input signal.
	The projector detects a PAL video input signal.
	The projector detects the component audio/video cable.
 RGB 480i 60Hz	The projector detects the video input signal and displays the video source's resolution and refresh rate below the component icon.
	The projector detects the VGA-audio cable.
 800x600 60Hz	The projector detects computer input signal and displays the input resolution and refresh rate
	The projector does not support the video signal.
	The projector is measuring and synchronizing to video input signal.

## Adjusting Image Size

The 3M MP225 Projector can project a diagonal image of 10 to 80 inches (254–2032 mm). Refer to the chart for associated dimensions.

Image Size Diagonal	Width	Height	Distance
10 in (25.4 cm)	8 in (20.3 cm)	6 in (15.2 cm)	12 in (30.5 cm)
14 in (35.56 cm)	11 1/4 in (28.4 cm)	8 3/8 in (21.3 cm)	16 3/4 in (42.7 cm)
20 in (50.8 cm)	16 in (40.6 cm)	12 in (30.5 cm)	24 in (61 cm)
26 in (66.04 cm)	20 3/4 in (52.8 cm)	15 5/8 in (39.6 cm)	31 2/8 in (79.2 cm)
32 in (81.28 cm)	25 5/8 in (65 cm)	19 1/4 in (48.8 cm)	38 3/8 in (97.5 cm)
38 in (96.52 cm)	30 3/8 in (77.2 cm)	22 3/4 in (57.9 cm)	45 5/8 in (115.8 cm)
44 in (111.76 cm)	35 1/4 in (89.4 cm)	26 3/8 in (67.1 cm)	53 in (134.1 cm)
50 in (127 cm)	40 in (101.6 cm)	30 in (76.2 cm)	60 in (152.4 cm)
60 in (152.4 cm)	48 in (121.9 cm)	36 in (91.4 cm)	72 in (182.9 cm)
70 in (177.8 cm)	56 in (142.2 cm)	42 in (106.7 cm)	84 in (213.4 cm)
80 in (203.2 cm)	64 in (162.6 cm)	48 in (121.9 cm)	96 in (243.8 cm)

*Important Note: As you increase the size of the projected image, you will need to decrease (darken) the ambient room lighting.*

## Adjusting the Focus

Turn the focus wheel to sharpen the image.

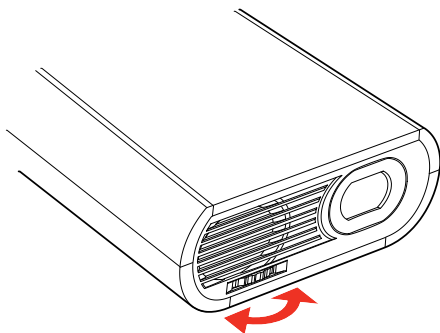

## Adjusting the Volume

Press the Volume Up or Volume Down button to adjust the sound. A volume bar will appear on the screen to help you set the volume level.

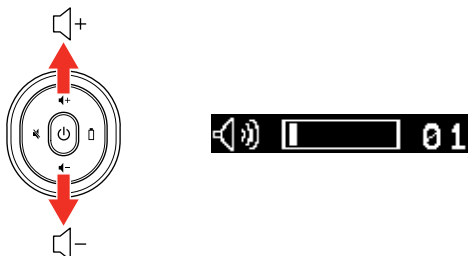

## Muting the Volume

Press the MUTE button to mute the volume. An icon will appear on the screen to indicate the current setting. To restore the volume, press the MUTE button again. If you press the Volume Up or Volume Down button while the volume is muted, the volume will also be restored, but from an initial volume level of zero.

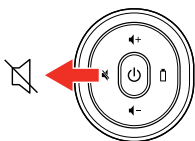

## Checking the Battery Level

To check the battery, press the Battery Status button. A battery bar will appear on the screen indicating the amount of charge currently in the battery.



## Attaching the Tripod (Optional Accessory)

The table-top tripod (optional accessory) mounts to the bottom of the projector.

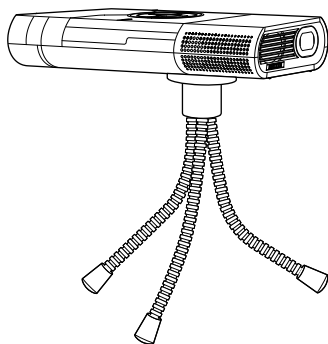

*Tip: The 3M MP225 Projector will attach to most camera tripods.*

## Cleaning the Projector

- 1 Turn off the projector and disconnect power and other cables.
- 2 Use a soft cloth, such as the 3M™ High Performance Cleaning Cloth, to wipe off dust. If the dust is difficult to remove, dampen the cloth with clean water and then wipe the projector clean. Then use a clean cloth to dry the projector.

*Important Note: Do not use cleaning chemicals or solvents to clean the projector. Cleaning chemicals and solvents may cause the plastic parts to discolor.*

# Troubleshooting

## **The projector will not turn on.**

- The battery is not properly installed, or the power adapter is not connected to the projector and a working wall outlet. Test the electrical outlet by plugging another electrical device (like a radio) into the wall outlet to confirm that the wall outlet works.
- Attempt to remove and replace the battery.
- Hold down the power button until the projector powers up.

## **The status indicator is flashing red when the power button is held down.**

- The battery needs to be charged or reinstalled. See “Charge the Battery” on page 12.

## **The image is not visible or is very dim.**

- The 3M MP225 Projector is a battery-operated device and requires controlled lighting conditions. The image may appear very dim in brightly lit rooms.
- Make sure the status indicator is green. This indicates that the projector is powered on and projecting an image.
- Project the image onto a flat, white surface.
- Decrease the light on the surface where the image is being projected.
- Decrease the size of the image.
- When there is nothing connected to the projector, it will project the startup screen.

## **The projector is displaying a question mark.**

- The projector does not support the video or computer input signal. Switch to a signal that the projector supports. See “Supported Computer Signals” on page 26.

## **A computer is connected to the projector but the projector will not display the computer's image.**

- Plug the VGA-audio cable into the projector and the icon in the upper-left corner of the image will display the “VGA-Audio cable” icon. See “On Screen Icons” on page 19.

## **The projector is making a noise.**

- The projector has a small fan for cooling the LED light source. The fan turns on and off automatically based on the projector's internal temperature. The fan will turn on more often in warm environments or at high altitudes.
- The speakers make noise when the volume is set to high and nothing is connected to the projector audio inputs. This is typical. Reduce the projector's volume setting to zero.
- The speakers may make noise when the component AV cable is not correctly connected to the video device. There are two red connectors on the component AV cable. One is for the right audio channel and the other is for the Pr component video signal. If these connectors are switched, the projected image will appear green and an abnormal noise will come from the right speaker.

**My video device is connected to the projector but the projector will not display the video.**

- Unplug the AV cable from the projector and the splash screen will display.
- Plug the AV cable into the projector and the icon in the upper-left corner of the image will display the “AV cable” icon. See “On Screen Icons” on page 19.
- The video output on some devices is turned off by default. Please refer to the device’s documentation for details on enabling the video output.



# Specifications

## Projector

Description	Specification	
Imager	Technology	LCOS
	Size	9.4 mm (0.37")
	Resolution	SVGA 800 x 600 Pixels
	Aspect Ratio	4:3
Projection Distance	8.4 in. – 50.4 in. (213–1280 mm)	
Image Size	10 in. – 60 in. Diagonal (254–1524 mm)	
Throw Ratio (Diagonal: Distance)	1:0.84	
Lens Offset	1:1 (none)	
Inputs	DC-in, AV-in (inc. VGA and component)	
Compatible Resolutions	VGA, SVGA, XGA, WXGA, 1280 x 960 @ 60Hz, 1440 x 900 @ 60Hz, MAC 640 x 480 @ 67Hz, 832 x 624 @ 75Hz, 1152 x 870 @ 75Hz	
Vertical Scan Rate	50 Hz / 60 Hz, MAC - 67 Hz / 75 Hz	
Horizontal Scan Rate	31.5 kHz – 49.68kHz	
Video Compatibility	NTSC, PAL	
Video Resolutions	480i, 480p, 576i, 576p, PAL, NTSC, H.264, SD (480i/576i), HD (720p/1080i)	
Dimensions	5.91 x 2.56 x 1.20 in. (150 x 65 x 30.5 mm)	
Weight	≤ 11.46 oz (≤ 325 g)	
Tripod Socket	¼" - 20	
Operating Conditions	Temperature Range	32 – 95°F (0-35°C)
	Humidity Range	10–80% RH without condensation
	Altitude Range	Sea Level to 1,829 m (6000')

**LIN370-002 Rechargeable Lithium-Ion Battery**

Description	Specification
Type (LIN370-002)	Rechargeable Lithium-Ion Battery
Rated Capacity	10.95 V 2100 mAh, 23 Wh
Dimensions	81.5 x 64 x 23 mm

*Important Note: Do not throw battery into trash. Please dispose of it according to federal, state, or local laws.*

**Supported Computer Signals**

Description	Resolution (width x height)	Refresh Rate
VGA	640 x 480	60 Hz
SVGA	800 x 600	60 Hz
XGA	1024 x 768	60 Hz
WXGA	1280 x 768	60 Hz
	1280 x 960	60Hz
	1440 x 900	60Hz
MAC	640 x 480	67Hz
	832 x 624	75Hz
	1152 x 870	75Hz

**Replacement Parts / Accessories**

Description	3M Part Number	
Power Adapter with US, EU, UK, AUS plugs	78-6972-0063-8	
Lithium-Ion Battery	78-6972-0058-8	
AV Video Cable	78-6972-0031-5	Optional
VGA Cable	78-6972-0062-0	Optional
Component AV cable	78-6972-0032-3	Optional
3M Adapter Cable for Apple®	78-6972-0064-6	

## Limited Warranty

*This warranty applies to the continental US only. The warranty terms, conditions, remedy and limitation may vary in other countries. Contact your local 3M Company for warranty information.*

- The 3M™ Mobile Projector MP225 (the “3M product”) is warranted to be free from defects in material or manufacture for a period of 1 year from the date of purchase.
- All other accessories included with the 3M product are warranted to be free from defects in material or manufacture for a period of 1 year from the date of purchase.
- Optional product accessories that are not sold as part of the 3M product are subject to individual warranties.

THE WARRANTIES STATED ABOVE ARE EXCLUSIVE AND ARE MADE IN PLACE OF ANY AND ALL WARRANTIES, EXPRESS OR IMPLIED WARRANTIES OR CONDITIONS, INCLUDING ANY IMPLIED WARRANTY OF MERCHANTABILITY OR FITNESS FOR A PARTICULAR PURPOSE, OR ANY INDUSTRY PRACTICE OR CUSTOM OR TRADE USAGE.

In the event the 3M product fails to conform to the above stated warranties within the applicable warranty period, your exclusive remedy shall be, at 3M's option, to replace or repair the 3M product or to refund the purchase price of the 3M product. All replaced parts or products become property of 3M. If the product is repaired, 3M will repair the defective part(s) with a new or used part(s). If the 3M product is replaced, 3M will replace the 3M product with the same or equivalent model and with a new or refurbished 3M product. In the case of an approved warranty claim, the replacement 3M product will carry only the remaining term of the original 3M product's warranty period as stated above. For warranty service, you must provide proof of the date of the original purchase else the manufacturing code date will be used to establish the start date of the warranty. The following are exclusions to the above listed warranty:

- a. This warranty does not cover 3M product that is modified or damaged through improper storage, misuse, abuse, accident, vandalism, improper installation, neglect, improper shipping, damage caused by acts of war, disasters such as fire, flood, and lightning, improper electrical current, software problems, interaction with non-3M products, or service other than by an 3M Authorized Service Provider, neglect or mishandling by any person. Normal wear and tear is not covered under warranty.
- b. 3M product is designed to operate in the typical indoor environment. This warranty does not cover 3M product used outside of the following circumstances:
  - 100V–240V AC, 50/60 Hz
  - 0°–35°C (32°–95°F)
  - 10–80% RH (without condensation)
  - 0–1829 m (0–6000 feet) above sea level

- c. The air intake and exhaust vent must be clear of obstructions. Inadequate air ventilation will cause the 3M product to malfunction or will cause damage to the 3M product which will void the warranty.
- d. This warranty does not cover any additional costs including, but not limited to, those associated with removal, cleaning or installation of the 3M product, adjustments, (mechanical or electronic) made to the 3M product.
- e. This warranty covers only normal use of the product. 24-hour-per-day or other excessive continual use causes strain and is not considered normal use.
- f. This warranty does not cover consumables (e.g., batteries).
- g. This warranty is not transferable.
- h. 3M is not responsible for warranty service should the 3M label or logo or the rating label or serial number be removed unless otherwise stated in writing for the purposes of private labeling for partnership requirements.
- i. This warranty does not cover postage, insurance, or shipping costs incurred in presenting your 3M product for warranty service. Said costs are the customer's responsibility. If a claimed defect cannot be identified or reproduced in service, the customer may be held responsible for cost incurred. Should your warranty upgrade include a "change out" service and the claimed defect cannot be identified or reproduced by the technician, the customer will be responsible for call out costs.

**FAILURE TO FOLLOW THE INSTRUCTIONS CONTAINED IN THE APPROPRIATE 3M PRODUCT MANUAL OR TO USE THE 3M PRODUCT IN ACCORDANCE WITH 3M'S INTENDED USE STATEMENT, WILL VOID ALL WARRANTIES AND LIMITED REMEDIES.**

EXCEPT AS SPECIFICALLY STATED IN THE APPLICABLE 3M PRODUCT MANUAL, 3M SHALL NOT BE LIABLE FOR ANY INDIRECT, INCIDENTAL, SPECIAL OR CONSEQUENTIAL DAMAGES (INCLUDING, BUT NOT LIMITED TO, LOSS OF PROFITS, REVENUE OR BUSINESS) RESULTING FROM, OR IN ANY WAY RELATED TO PERFORMANCE, USE OR INABILITY TO USE ANY OF THE 3M PRODUCT. This limitation applies regardless of the legal theory upon which damages are sought.

For warranty support, please call or write your local 3M office or a 3M Authorized Service Provider to obtain an RMA # (Return Material Authorization number) before returning the product. If you are inside the Continental United States of America, please contact 3M Customer Service at 1-866-631-1656 or email [meetings@mmm.com](mailto:meetings@mmm.com).

**What 3M Will Do To Correct Problems:**

- If your 3M product requires service, 3M will ask you to bring or send the 3M product, securely packaged in its original container or equivalent, along with proof of the date of original purchase, to your 3M Service Dealer or 3M Service Center.
- 3M will, at its option, repair or replace the defective unit without charge for parts or labor. Return of the 3M product will be at 3M's expense.
- When warranty service involves the exchange of the 3M product or of a part, the item replaced becomes 3M property.

- The exchanged 3M product or part may be new or previously refurbished to the 3M standard of quality, and at 3M's option, the replacement may be another model of like kind and quality.
- 3M's liability for replacement of the warranted 3M product or part will not exceed the original retail selling price of the 3M product. Exchange or replacement products or parts assume the remaining warranty period of the product covered by this limited warranty.

## FCC STATEMENT - CLASS B

This equipment generates, uses and can radiate radio frequency energy, and if not installed and used in accordance with the instruction manual may cause interference to radio communications. It has been tested and found to comply with the limits for a Class "B" computing device pursuant to Subpart B of Part 15 of the FCC Rules, which are designed to provide reasonable protection against such interference when operated in a residential installation. However, there is no guarantee that interference will not occur in a particular installation. If this equipment does cause harmful interference to radio or television reception, which can be determined by turning the equipment off and on, the user is encouraged to try to correct the interference by one or more of the following measures:

- Reorient or relocate the receiving antenna.
- Increase the separation between the equipment and receiver.
- Connect the equipment into an outlet on a circuit different from that to which the receiver is connected.
- Consult the dealer or an experienced radio/TV technician for help.

**NOTICE:** This Class B digital apparatus complies with Canadian ICES-003.  
Cet appareil numérique de la classe B est conforme à la norme NMB-003 du Canada.

**INSTRUCTIONS TO USERS:** This equipment complies with the requirements of FCC equipment provided that the following conditions are met. If the cables include a EMI ferrite core, attach the ferrite core end of the cable to the projector. Use the cables which are included with the projector or specified.

**Note:** Changes or modifications not expressly approved by the party responsible for compliance could void the user's authority to operate the equipment.

### CE Statement

**ElectroMagnetic Compatibility Statement:** Meets 2004/108/EC Directive

**Low Voltage Directive:** Meets 2006-95-EC Directive.

## WEEE Statement

The following information is only for EU-members States:

The mark shown to the right is in compliance with Waste Electrical and Electronic Equipment Directive 2002/96/EC (WEEE). The mark indicates the requirement NOT to dispose the equipment as unsorted municipal waste, but use the return and collection systems according to local law.

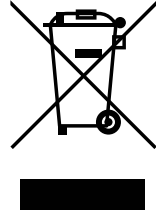

## RoHS Statement

3M Mobile Interactive Solutions can provide RoHS certification for products meeting the RoHS directive.<sup>1</sup>

European (EU) Restriction of Hazardous Substances (RoHS) Directive, 2002/95/EC,

<sup>1</sup>RoHS compliant means that the product or part does not contain any of the substances in excess of the following maximum concentration values in any homogeneous material, unless the substance is in an application that is exempt under RoHS, as amended:(a) 0.1% (by weight) for lead, mercury, hexavalent chromium, polybrominated biphenyls or polybrominated diphenyl ethers; or (b) 0.01% (by weight) for cadmium. This information represents 3M's knowledge and belief, which may be based on information provided by third party suppliers to 3M.

## Patents

This product includes a component covered by U.S. Patent Nos. 7,071,908 and 7,667,678, Hong Kong Patent No. HK1088976, Australia Patent No. 2004241602, United Kingdom Patent No. 2417360 and other U.S. and international patents pending, owned by Syndiant Inc.



3M is a trademark of 3M Company.



**Mobile Interactive Solutions**  
**3M Austin Center**

6801 River Place Blvd.  
Austin, TX 78726-9000  
866-631-1656  
[www.3MPocketProjector.com](http://www.3MPocketProjector.com)  
[meetings@mmm.com](mailto:meetings@mmm.com)

© 3M 2012. All Rights Reserved.  
78-6971-1627-1



## Free Manuals Download Website

<http://myh66.com>

<http://usermanuals.us>

<http://www.somanuals.com>

<http://www.4manuals.cc>

<http://www.manual-lib.com>

<http://www.404manual.com>

<http://www.luxmanual.com>

<http://aubethermostatmanual.com>

Golf course search by state

<http://golfingnear.com>

Email search by domain

<http://emailbydomain.com>

Auto manuals search

<http://auto.somanuals.com>

TV manuals search

<http://tv.somanuals.com>