

# 3M

## MP8790CN Multimedia Projector

### Operator's Guide

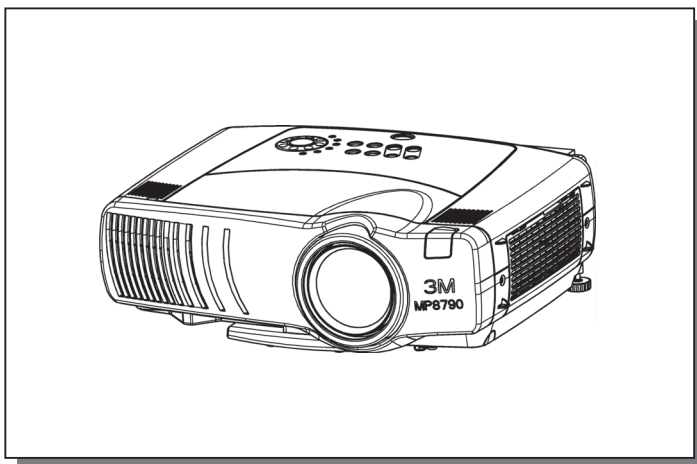

# MP8790CN Multimedia Projector Operator's Guide

Thank you for purchasing this projector.



**WARNING** • Please read the "Product Safety Guide" and this "Operator's Guide" thoroughly to ensure correct usage through understanding.

After reading, store this instruction manual in a safe place for future reference.

**NOTE** • The information in this manual is subject to change without notice.

- The manufacturer assumes no responsibility for any errors that may appear in this manual
- The reproduction, transmission or use of this document or contents is not permitted without express written authority.

## TRADEMARK ACKNOWLEDGEMENT :

- PS/2, VGA and XGA are registered trademarks of the International Business Machines Corporation.
- Apple, Mac and ADB are registered trademarks of Apple Computer, Inc.
- VESA and SVGA are trademarks of the Video Electronics Standard Association.
- Windows is a registered trademark of Microsoft Corporation.
- All other trademarks are the property of their respective owners.

## CONTENTS

	Page		Page
<b>PROJECTOR FEATURES .....</b>	<b>2</b>	<b>ADJUSTING SCREEN WITH</b>	
<b>PREPARATIONS .....</b>	<b>2</b>	<b>ONE-TOUCH.....</b>	<b>23</b>
<b>PART NAMES .....</b>	<b>4</b>	<b>SELECTING THE ASPECT</b>	
<b>SETTING UP THE PROJECTOR .....</b>	<b>6</b>	<b>RATIO.....</b>	<b>24</b>
<b>CONNECTING YOUR DEVICES.....</b>	<b>8</b>	<b>TEMPORARILY BLANKING</b>	
<b>USING THE REMOTE CONTROL... </b>	<b>13</b>	<b>THE SCREEN.....</b>	<b>24</b>
<b>TURNING ON THE POWER .....</b>	<b>15</b>	<b>DISPLAYING CHILD WINDOW</b>	
<b>TURNING OFF THE POWER .....</b>	<b>17</b>	<b>(P. IN. P: Picture in Picture) .....</b>	<b>24</b>
<b>ADJUSTING THE VOLUME .....</b>	<b>18</b>	<b>USING THE MENU FUNCTIONS.....</b>	<b>25</b>
<b>TEMPORARILY MUTING</b>		<b>MULTIFUNCTIONAL SETTINGS.....</b>	<b>26</b>
<b>THE SOUND.....</b>	<b>18</b>	<b>OPERATING THE PC SCREEN .....</b>	<b>32</b>
<b>ADJUSTING THE POSITION.....</b>	<b>19</b>	<b>THE LAMP .....</b>	<b>33</b>
<b>USING THE AUTOMATIC</b>		<b>THE AIR FILTER.....</b>	<b>35</b>
<b>ADJUSTMENT FEATURE .....</b>	<b>20</b>	<b>OTHER CARE.....</b>	<b>37</b>
<b>CORRECTING KEYSTONE</b>		<b>WHAT TO DO WHEN YOU THINK</b>	
<b>DISTORTIONS .....</b>	<b>21</b>	<b>A MACHINE DEFECT HAS OCCURRED... </b>	<b>38</b>
<b>USING THE MAGNIFY</b>		<b>SPECIFICATIONS.....</b>	<b>41</b>
<b>FEATURE.....</b>	<b>22</b>	<b>ACCESSORIES .....</b>	<b>42</b>
<b>FREEZING THE SCREEN .....</b>	<b>22</b>		

## PROJECTOR FEATURES

This liquid crystal projector is used to project various computer signals as well as NTSC / PAL / SECAM video signals onto a screen. Little space is required for installation and large images can easily be realized.

### ● **Ultra High Brightness**

Crisp, ultra-bright presentations is achieved by using a UHB (ultra high brightness) lamp and a highly efficient optical system

### ● **Partial Magnification Function**

Interesting parts of images can be magnified for closer viewing

### ● **One Touch Function**

Just press the ONE TOUCH button to automatically retrieve input signals, calibrate images, and correct keystone distortion

### ● **Whisper Mode Equipped**

Special mode is available for reducing projector noise to achieve quieter operation

## PREPARATIONS

**Your projector should come with the items shown below. Check to make sure that all the items are included. Contact your dealer if anything is missing.**

**NOTE** • Keep the original packing material for future reshipment.

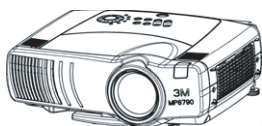

**Projector**  
(with Lens Cap)

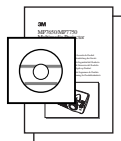

**Operator's Guide**  
**Product Safety Guide**  
**Warranty**  
**Quick Start Guide**



**Power cord**  
(US, UK, Europe)

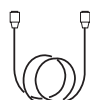

**S-Video Cable**

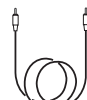

**Stereo Mini-Cable**

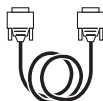

**RGB cable**

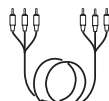

**Video/Audio cable**  
(with white lead)

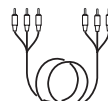

**Component Video cable**  
(with green lead)



**USB mouse cable**



**Two AA batteries**  
(for the remote control)



**RS-232C adapter**



**Remote control**



**WARNING** Precautions to observe in regards to the power cord: Please use extra caution when connecting the projector's power cord as incorrect or faulty connections may result in FIRE AND/OR ELECTRICAL SHOCK. Please adhere to the following safety guidelines to insure safe operation of the projector:

- Only plug the power cord into outlets rated for use with the power cord's specified voltage range.
- Only use the power cord that came with the projector.
- NEVER ATTEMPT TO DEFEAT THE GROUND CONNECTION OF THE THREE-PRONGED PLUG!
- Make sure that you firmly connect the power cord to the projector and wall outlet.

## 1 Connect your devices to the projector

8 ~ 12

Connect your computer, VCR and/or other devices you will be using to the projector.

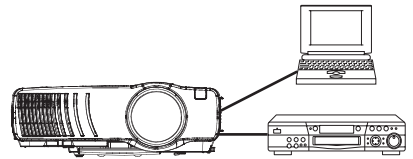

## 2 Insert the batteries into the remote control

13

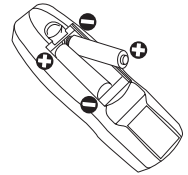

## 3 Connect the power cord

- (1) Connect the connector of the electrical power cord to the AC inlet of the main unit.
- (2) Firmly plug the power cord's plug into the outlet

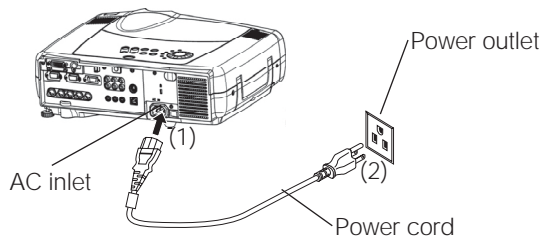

# PART NAMES

# THE PROJECTOR

 Indicates the corresponding reference page

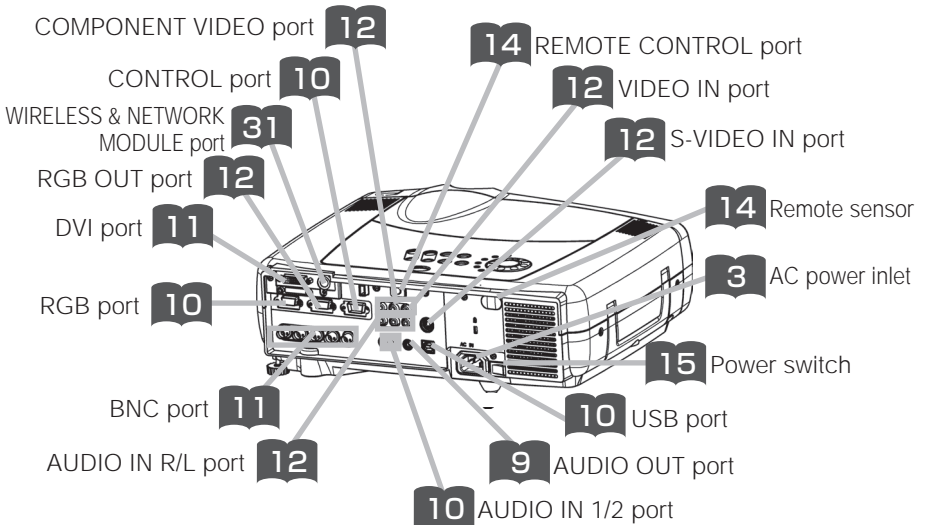
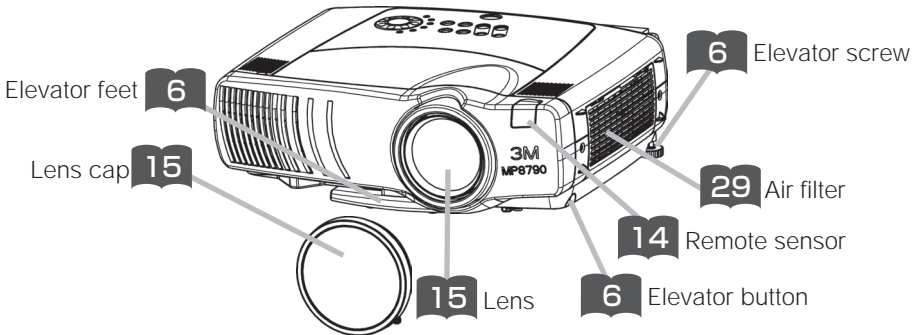
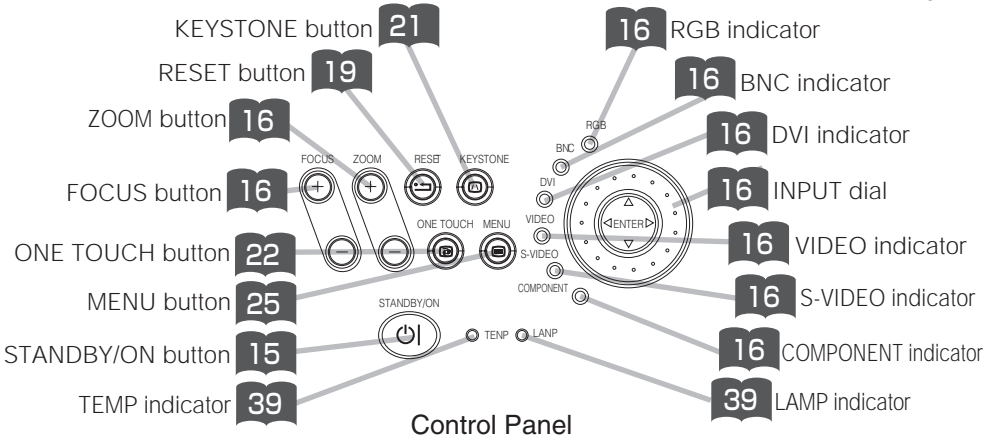

# THE REMOTE CONTROL

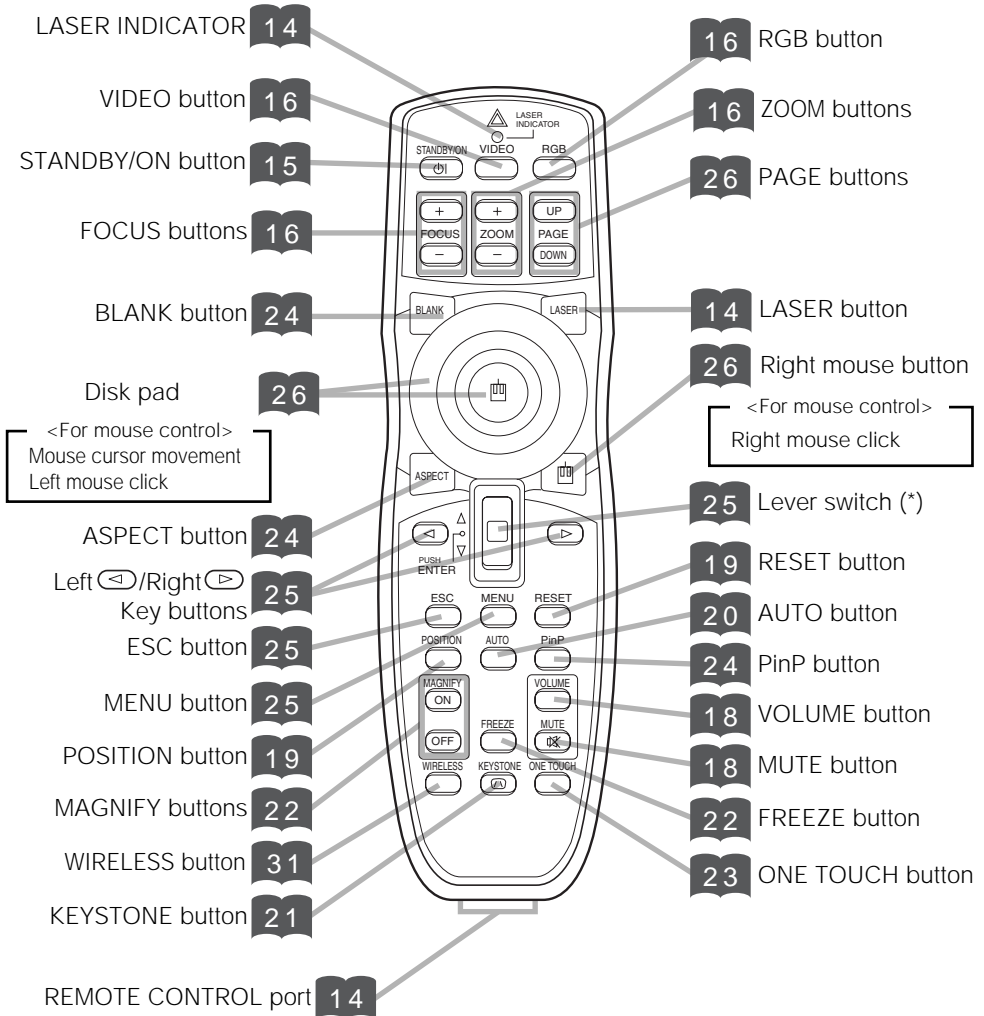

## \* Using the lever switch

- Flip toward disk pad : Up (▲) key
- Flip toward MENU button: Down (▼) key
- Press in center : ENTER button

# SETTING UP THE PROJECTOR

**CAUTION** • Install the projector in a suitable environment according to instructions of the "Product Safety Guide" and "Operator's Guide".

- If you press the elevator buttons without holding the projector, the projector might crash down, overturn, smash your fingers and possibly result in malfunction. To prevent damaging the projector and injuring yourself, ALWAYS HOLD THE PROJECTOR whenever using the elevator buttons to adjust the elevator feet.

## Adjusting the Projector's Elevator Feet

If the surface on which the projector is placed, or the screen is tilted, use the elevator feet and elevator screw to adjust the projection angle of the main unit. The adjustment range of the elevator feet is 0 to 9 degrees.

### 1 Press and hold in the elevator buttons

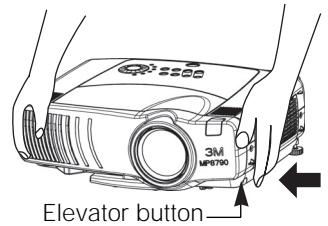

### 2 Raise or lower the projector to the desired height and then release the elevator buttons

When you release the elevator buttons, the elevator feet will lock into position.

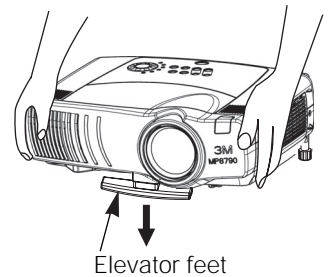

### 3 Turn the elevator screw to fine tune.

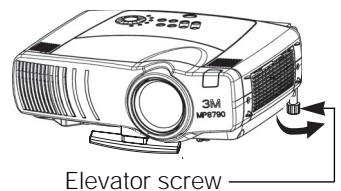

# Adjusting the Screen Size and Projection Distance

Refer to the illustrations and tables below to determine the screen size and projection distance.

- The values shown in the table are calculated for a full size screen  
 a: Distance from the projector to the screen ( $\pm 10\%$ )  
 b: Distance from the lens center to the bottom of the screen ( $\pm 10\%$ )  
 c: Distance from the lens center to the top of the screen ( $\pm 10\%$ )

The screen

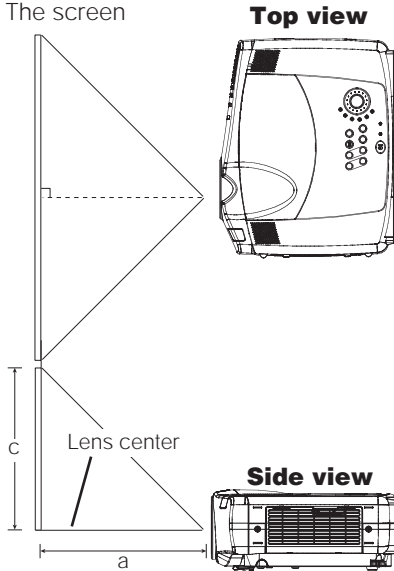

If 4:3 aspect ratio

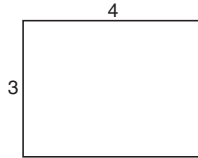

Screen Size [inch (m)]	a [inch (m)]		b [inch (cm)]	c [inch (cm)]
	Min.	Max.		
30 (0.8)	34 (0.9)	52 (1.3)	0 (0)	18 (46)
40 (1.0)	46 (1.2)	71 (1.8)	0 (0)	24 (61)
50 (1.3)	58 (1.5)	89 (2.3)	0 (0)	30 (76)
60 (1.5)	71 (1.8)	107 (2.7)	0 (0)	36 (91)
70 (1.8)	83 (2.1)	126 (3.2)	0 (0)	42 (107)
80 (2.0)	95 (2.4)	144 (3.7)	0 (0)	48 (122)
90 (2.3)	108 (2.7)	162 (4.1)	0 (0)	54 (137)
100 (2.5)	120 (3.0)	181 (4.6)	0 (0)	60 (152)
120 (3.0)	144 (3.7)	217 (5.5)	0 (0)	72 (183)
150 (3.8)	181 (4.6)	272 (6.9)	0 (0)	90 (229)
200 (5.0)	243 (6.2)	364 (9.2)	0 (0)	120 (305)
250 (6.3)	304 (7.7)	455 (11.6)	0 (0)	150 (381)
300 (7.5)	366 (9.3)	547 (13.9)	0 (0)	180 (457)

The screen

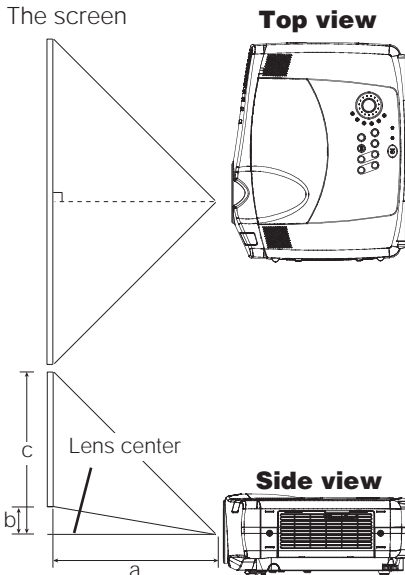

If 16:9 aspect ratio

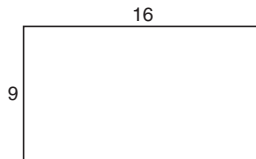

Screen Size [inch (m)]	a [inch (m)]		b [inch (cm)]	c [inch (cm)]
	Min.	Max.		
30 (0.8)	37 (0.9)	57 (1.4)	2 (6.2)	17 (44)
40 (1.0)	50 (1.3)	77 (2.0)	13 (32)	27 (70)
50 (1.3)	64 (1.6)	97 (2.5)	16 (41)	31 (78)
60 (1.5)	77 (2.0)	117 (3.0)	19 (49)	34 (86)
70 (1.8)	90 (2.3)	137 (3.5)	22 (57)	37 (94)
80 (2.0)	104 (2.6)	157 (4.0)	26 (65)	40 (102)
90 (2.3)	117 (3.0)	177 (4.5)	29 (73)	43 (110)
100 (2.5)	131 (3.3)	197 (5.0)	32 (81)	47 (118)
120 (3.0)	157 (4.0)	237 (6.0)	38 (97)	53 (134)
150 (3.8)	198 (5.0)	296 (7.5)	48 (121)	63 (159)
200 (5.0)	265 (6.7)	396 (10.1)	64 (162)	78 (199)
250 (6.3)	332 (8.4)	496 (12.6)	80 (202)	94 (240)
300 (7.5)	399 (10.1)	596 (15.1)	96 (243)	110 (280)



## CONNECTING YOUR DEVICES

### **Devices You Can Connect to the Projector (Refer to this section for planning your device configuration to use for your presentation.)**



**CAUTION** • Incorrect connecting could result in fire or electrical shock. Please read the "Product Safety Guide" and this "Operator's guide".

#### **ATTENTION** Precautions to observe when connecting other devices to the projector

- Whenever attempting to connect other devices to the projector, please thoroughly read the manual of each device to be connected.
- **TURN OFF ALL DEVICES** prior to connecting them to the projector. Attempting to connect a live device to the projector may generate extremely loud noises or other abnormalities that may result in malfunction and/or damage to the device and/or projector. Refer to the "Technical" for the pin assignment of connectors and RS-232C communication data.
- Make sure that you connect devices to the correct port. Incorrect connection may result in malfunction and/or damage to the device and/or projector.
- Some cables may have to be used with core set. Use the accessory cable or a designated-type cable for the connection. For cables that have a core only at one end, connect the core to the projector.
- Secure the screws on the connectors and tighten.



Indicates the  
corresponding  
reference page

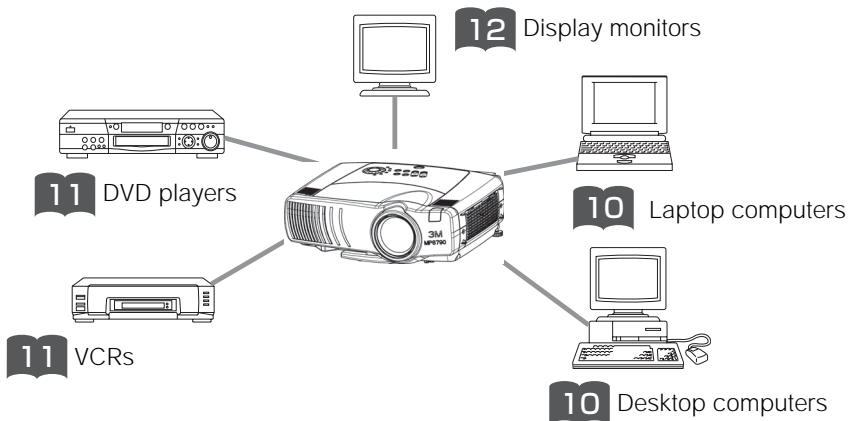

## Ports and Cables

Refer to the table below to find out which projector port and cable to use for connecting a given device. Use this table for determining which cables to prepare.

Function	Projector Port	Connection Cables
Analog RGB input	RGB	RGB cable (With D-sub 15-pin shrink jack and inch thread screws)
	BNC(R/C <sub>R</sub> /P <sub>R</sub> )(G/Y)(B/C <sub>B</sub> /P <sub>B</sub> )(H)(V) • When BNC (RGB) is selected (*)	BNC cable
Analog output	RGB OUT	RGB cable (With D-sub 15-pin shrink jack and inch thread screws)
DVI input	DVI	DVI cable
Audio input from computer	AUDIO IN 1 • Linked to RGB or DVI port input	Audio/video cable (Stereo mini)
	AUDIO IN 2 • Linked to BNC (RGB) port input (*)	
USB mouse control	USB	USB cable
PS/2 mouse control	CONTROL	PS/2 mouse cable
ADB mouse control		ADB mouse cable
Serial mouse control		Serial mouse cable
RS-232C communications		RS-232C adapter + RS-232C cable
S video input	S-VIDEO IN	S-video cable (mini DIN 4-pin jack)
Video input	VIDEO IN	Audio/video cable
Component video input	COMPONENT(C <sub>R</sub> /P <sub>R</sub> )(C <sub>B</sub> /P <sub>B</sub> )(Y)	Component video cable
	BNC(R/C <sub>R</sub> /P <sub>R</sub> )(G/Y)(B/C <sub>B</sub> /P <sub>B</sub> ) • When BNC (COMPONENT) is selected (*)	
Audio input from video equipment	AUDIO IN R,L	Audio/video cable or audio cable (RCA jack)
Audio output	AUDIO OUT	Audio cable (Stereo mini)
Wired remote control signal input	REMOTE CONTROL	Audio cable (Stereo mini)

\* Before using the BNC port, change RGB input to component video input on the BNC menu item of the INPUT menu.

### **NOTE** About Plug-and-Play Capability

- This projector is compatible with VESA DDC 1/2B. Plug-and-Play can be achieved by connecting this projector to computers that are VESA DDC (display data channel) compatible. Please take advantage of this function by connecting the accessory RGB cable to the RGB port (DDC 1/2B compatible). Plug-and-Play may not work properly if any other type of connection is attempted.
- Plug-and-Play is a system composed of the computer, its operating system and peripheral equipment (i.e. display devices).
- Please use the standard drivers as this projector is a Plug-and-Play monitor.

# CONNECTING YOUR DEVICES (continued)

## Connecting to a Computer

**ATTENTION** Whenever attempting to connect a laptop computer to the projector, be sure to activate the laptop's RGB external image output (set the laptop to CRT display or to simultaneous LCD and CRT display). For details on how this is done, please refer to the instruction manual of the corresponding laptop computer.

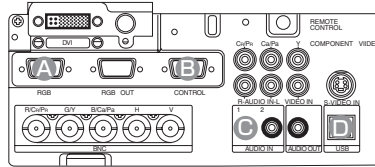
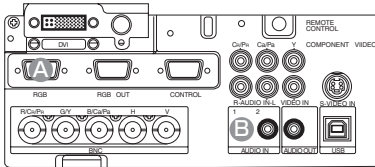

USB cable  
If connecting to a USB port equipped computer



**Laptop computer**



**Desktop computer**

### NOTE

- Some computers may have multiple display screen modes. Use of some of these modes will not be possible with this projector.
- For some RGB input modes, the optional Mac adapter is necessary.

# Connecting to a Computer (continued)

## BNC Input

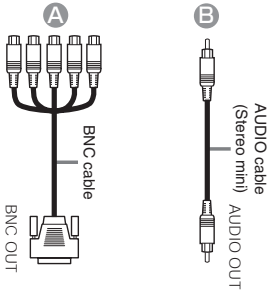
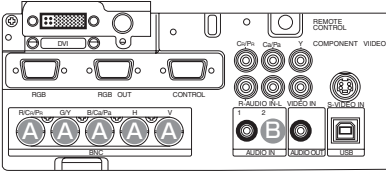

## DVI Input

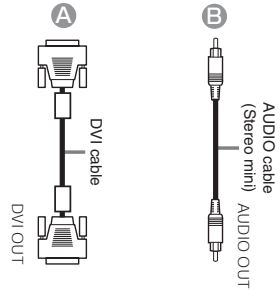
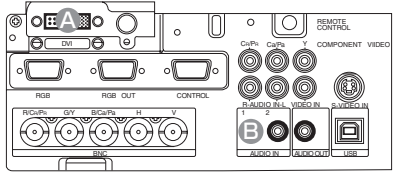

# CONNECTING YOUR DEVICES (continued)

## Connecting to a DVD Player

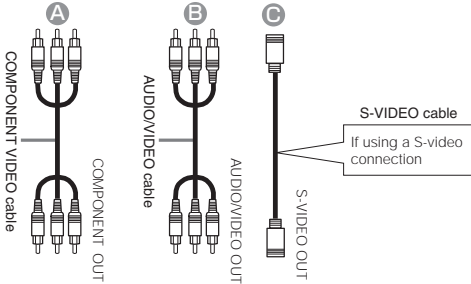
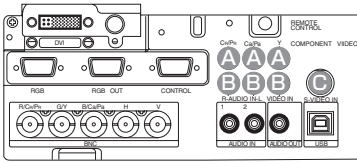

## Connecting to a VCR

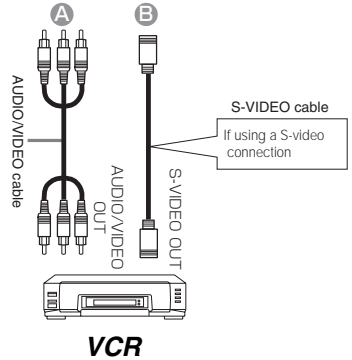
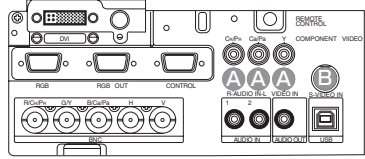

## Connecting to a Display Monitor

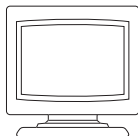
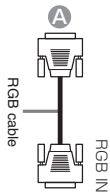
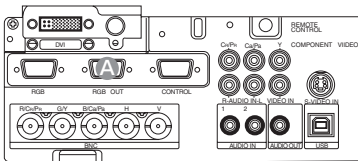

# USING THE REMOTE CONTROL

## Putting batteries into the remote control unit



### **CAUTION** Precautions to observe in regards to the batteries

Always handle the batteries with care and use them only as directed. Improper use may result in battery cracking or leakage, which could result in fire, injury and/or pollution of the surrounding environment.

- Keep the battery away from children and pets.
- Be sure to use only the batteries specified for use with the remote control. Do not mix new batteries with used ones.
- When inserting batteries, verify that the plus and minus terminals are aligned correctly (as indicated in the remote control).
- When you dispose the battery, you should obey the law in the relative area or country.

### **1 Remove the battery cover**

Slide back and remove the battery cover in the direction of the arrow.

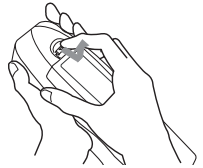

### **2 Insert the batteries**

Align and insert the two AA batteries (that came with the projector) according to their plus and minus terminals (as indicated in the remote control).

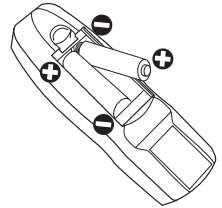

### **3 Close the battery cover**

Replace the battery cover in the direction of the arrow and snap it back into place.

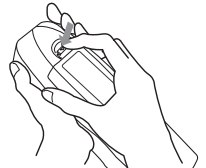

# USING THE REMOTE CONTROL (continued)

## Operating the remote control

- WARNING** • The laser pointer of the remote control transmitter is used in place of a finger or rod. Never look directly into the laser beam outlet or point the laser beam at other people. The laser beam can cause vision problems.
- CAUTION** • Use of controls or adjustments or performance of procedures other than those specified herein may result in hazardous radiation exposure.

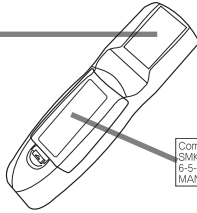

Complies with 21 CFR 1040.10 and 1040.11.  
SHIKI CORPORATION  
6-5-5 Togoshi Shinagawa-ku, Tokyo, JAPAN 142-8511  
MANUFACTURED June 2002 PLACE OF MANUFACTURER : A

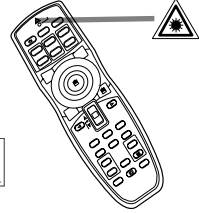

- The remote control works with both the projector's front and rear remote sensors.
- The range of the remote sensor on the front is 3 meters with a 60-degree range (30 degrees to the left and right of the remote sensor), and back is 3 meters with a 40-degree range.
- Since the remote control uses infrared light to send signals to the projector (Class 1 LED), be sure to use the remote control in an area free from obstacles that could block the remote control's output signal to the projector.
- The wired remote control:

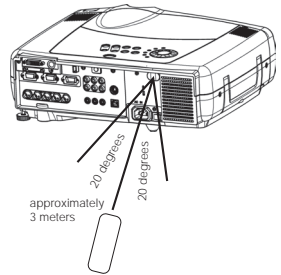
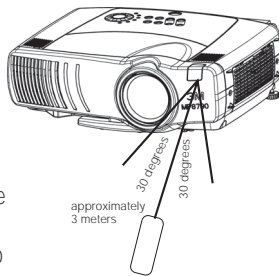

You can use the remote control as a wired remote control, by connecting the REMOTE CONTROL ports of the main unit and remote control via an audio cable (3.5 dia. stereo mini cable with plugs).

### ATTENTION Precautions to observe when using the remote control

- Do not disassemble the remote control.
- Do not drop or otherwise expose the remote control to physical impact.
- Do not get the remote control wet or place it on wet objects. Doing so may result in malfunction.
- Do not place the remote control near the projector's lens, fan, or vents.
- Remove the batteries from the remote control and store them in a safe place if you won't be using the remote control for an extended period.
- Replace the batteries whenever the remote control starts to malfunction.
- When strong light, such as direct sunlight or light from an extremely close range (such as from an inverter fluorescent lamp), hits the projector's remote sensor, the remote control may cease to function. Adjust the direction of the projector to keep light from directly hitting the projector's remote sensor.

# TURNING ON THE POWER

## Precautions

Connect all devices to be used to the projector prior to turning on the power.



**WARNING** When the power is ON, a strong light is emitted. Do not look into the lens.

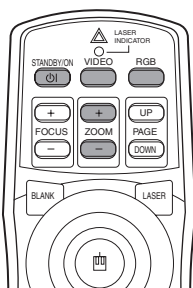

**Control panel**

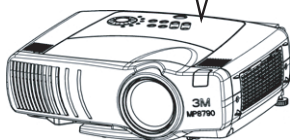
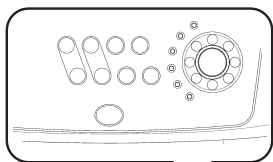

**NOTE** Turn the power on/off in right order.

- Power on the projector before the computer or video tape recorder.
- Power off the projector after the computer or video tape recorder.

- 1 Make sure that the power cord is firmly and correctly connected to the projector and outlet**



- 2 Turn on the projector's power**

Set the power switch to [ | ] (ON). The STANDBY/ON indicator will light to solid orange.

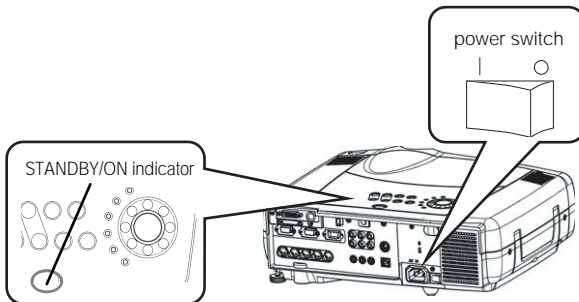

- 3 Press the STANDBY/ON button (control panel or remote control)**

- The projector begins warming up and the STANDBY/ON indicator blinks green.
- The STANDBY/ON indicator stops blinking and lights to solid green once the projector's power is completely on.



- 4 Remove the lens cap**

The picture is projected.

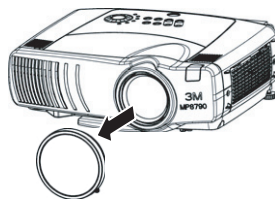



# TURNING ON THE POWER (continued)

## Selecting an Input Signal

5

### Using the remote control

#### If selecting RGB input Press the RGB button

Press this button to toggle between the devices connected to RGB IN 1 and 2. As illustrated below, each time you press the RGB button, the projector switches between RGB IN 1 and 2. Select the signal you wish to project.

- When BNC (RGB) is selected:

RGB → BNC(RGB) → DVI



- When BNC (COMPONENT) is selected:

RGB ↔ DVI

#### If selecting video input Press the VIDEO button

Press this button to toggle between the devices connected to VIDEO IN, S-VIDEO IN and COMPONENT VIDEO. As illustrated below, each time you press the VIDEO button, the projector switches between VIDEO IN, S-VIDEO IN and COMPONENT VIDEO. Select the signal you wish to project.



- When BNC (RGB) is selected:

VIDEO IN → S-VIDEO IN → COMPONENT VIDEO



- When BNC (COMPONENT) is selected:

VIDEO IN → S-VIDEO IN → COMPONENT VIDEO



### Using the projector's control panel

#### Turn the INPUT dial

Turning the dial cycles through the inputs as shown below. Select the terminal to which the signal you want to project is input.



- When BNC (RGB) is selected:

RGB ↔ BNC(RGB) ↔ DVI  
↕  
COMPONENT VIDEO ↔ S-VIDEO ↔ VIDEO

- When BNC (COMPONENT) is selected:

RGB ↔ BNC(COMPONENT) ↔ DVI  
↕  
COMPONENT VIDEO ↔ S-VIDEO ↔ VIDEO

#### NOTE

Turn the INPUT dial and set it at the click point, otherwise input signal selection may be incorrect.

6

### Use the ZOOM (+) / (-) buttons to adjust the screen size



(Control panel)



(Remote control)

7

### Use the FOCUS (+) / (-) buttons to adjust the focus



(Control panel)



(Remote control)

# TURNING OFF THE POWER

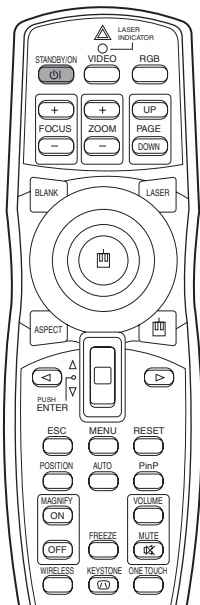

Control panel

## 1 Press the **STANDBY/ON** button (control panel or remote control)

The message "Power off?" will appear on the screen for approximately 5 seconds.



## 2 Press the **STANDBY/ON** button again (control panel or remote control)

Press the STANDBY/ON button again while the "Power off?" message is visible. The projector lamp goes off and starts cooling down. While cooling, the STANDBY/ON indicator flashes orange. When in this state, pressing the STANDBY/ON button has no effect.

When lamp cooling is complete, the STANDBY/ON indicator stops flashing, and turning solid orange.



## 3 Check that the **STANDBY/ON** indicator stops blinking and lights to solid orange. Switch the power switch to **[O] (OFF)**.

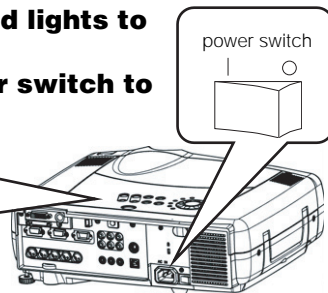
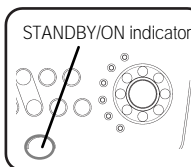
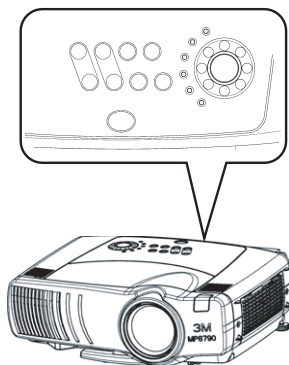

### NOTE

- Except in cases of emergency, do not turn off the power switch while the STANDBY/ON indicator is solid or flashing green. Doing so could shorten the lamp lifetime.

## 4 Confirm that the **STANDBY/ON** indicator has gone off and then attach the lens cap.

When the projector has completed powering down, the STANDBY/ON indicator will go off.

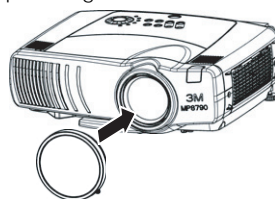

# ADJUSTING THE VOLUME

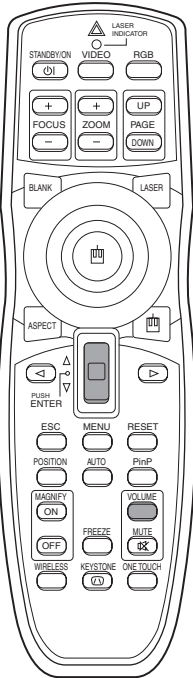

## 1 Press the **VOLUME** button

As illustrated on the right, a dialog will appear on the screen to aid you in adjusting the volume.

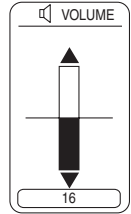

## 2 Use the lever switch / to adjust the volume

Press the VOLUME button again to close the dialog and complete this operation. (Even if you don't do anything, the dialog will automatically disappear after a few seconds.)

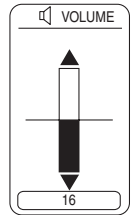
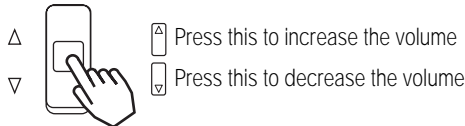

# TEMPORARILY MUTING THE SOUND

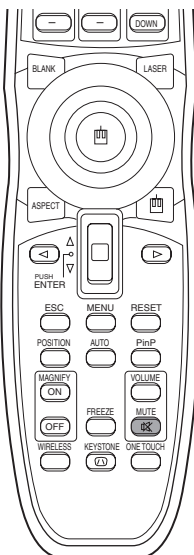

## 1 Press the **MUTE** button

As illustrated on the right, a dialog will appear on the screen indicating that you have muted the sound. Press the VOLUME button to close the dialog. (Even if you don't do anything, the dialog will automatically disappear after a few seconds.)

Press the MUTE button again to restore the sound.

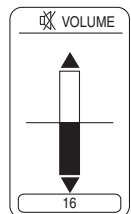

# ADJUSTING THE POSITION

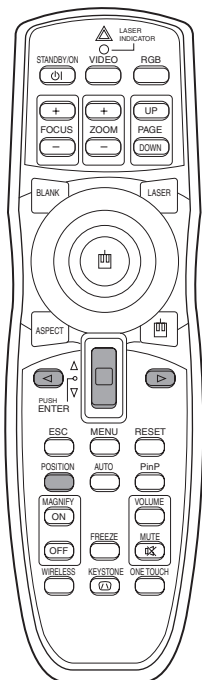

## 1 Press the **POSITION** button

As illustrated on the right, a dialog will appear on the screen to aid you in adjusting the position.



## 2 Use the **←**, **→**, **↑**, **↓** buttons to adjust the position

When you want to initialize the position, press the **RESET** button during adjustment.

Press the **POSITION** button again to close the dialog and complete this operation. (Even if you don't do anything, the dialog will automatically disappear after a few seconds.)

This function is only available for RGB/BNC (RGB) input.

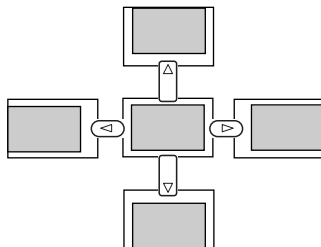
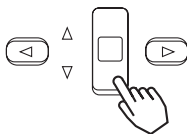

# USING THE AUTOMATIC ADJUSTMENT FEATURE

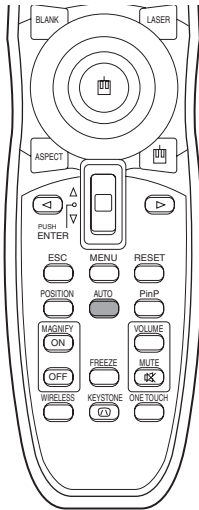

## 1 Press the **AUTO** button



### **Automatic Adjustment for RGB Input**

Horizontal position (H. POSIT), vertical position (V. POSIT), clock phase (H. PHASE) and horizontal size (H. SIZE) are automatically adjusted.

Make sure that the application window is set to its maximum size prior to attempting to use this feature. Dark pictures may still be incorrectly adjusted. Use a bright screen when adjusting.

### **Automatic Adjustment for Video Input**

The signal type best suited for the respective input signal is selected automatically.

This feature is available only if VIDEO is set to AUTO in the INPUT menu.

#### **NOTE**

The automatic adjustment operation requires approximately 10 seconds. Also, please note that it may not function correctly with some input signals.

# CORRECTING KEYSTONE DISTORTIONS

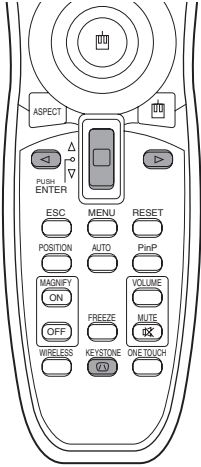

## 1 Press the **KEYSTONE** button

As illustrated on the right, a dialog will appear on the screen to aid you in correcting the distortion.

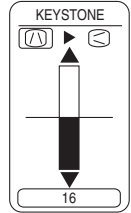

## 2 Use the **◀, ▶** buttons to select the direction of distortion to correct (▲/◀)

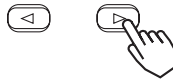

## 3 Use the lever switch ▲ / ▼ to correct distortion

Press the KEystone button again to close the dialog and complete this operation. (Even if you don't do anything, the dialog will automatically disappear after a few seconds.)

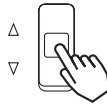

### NOTE

- This function may not work well with some types of input signals.
- The adjustable range for correcting keystone distortions will vary with the type of input signal.

# USING THE MAGNIFY FEATURE

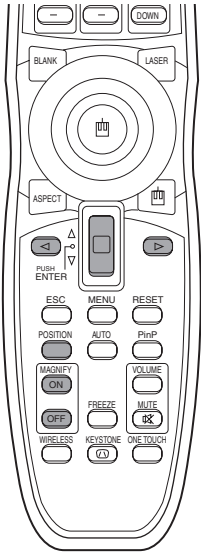





## 1 Press the **MAGNIFY (ON)** button

The projector enters MAGNIFY mode.



## 2

Press the **POSITION** button, then use the lever switch  / ,  /  to select the area to zoom. Press the **POSITION** button again to finalize the zoom area.

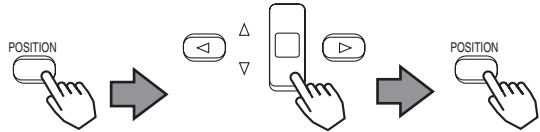

## 3

Use the lever switch  /  to adjust the zoom level

Press the MAGNIFY (OFF) button to exit MAGNIFY mode and restore the screen to normal. (The projector will also automatically exit MAGNIFY mode if there is a change in the input signal's state.)

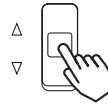

### NOTE

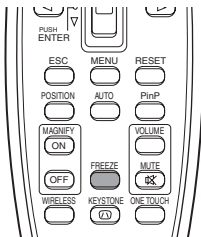

The projector will automatically exit from MAGNIFY mode if either the INPUT SELECT, AUTO, ASPECT or VIDEO feature is used, or, if there is a change in the input signal's state.

# FREEZING THE SCREEN



## 1

Press the **FREEZE** button

The  icon appears and the screen will freeze at the current image. Press the FREEZE button again and the  appears as the projector exits FREEZE mode.



### NOTE

- The projector will automatically exit from FREEZE mode if either the POSITION, VOLUME, MUTE, AUTO, BLANK ON/OFF or MENU ON/OFF feature is used, or, if there is a change in the input signal's state.
- If the projector continues projecting the same image for a long time (i.e. you forget to exit FREEZE mode), the image might possibly remain as an afterimage. Do not leave the projector in FREEZE mode for too long.

# ADJUSTING SCREEN WITH ONE-TOUCH

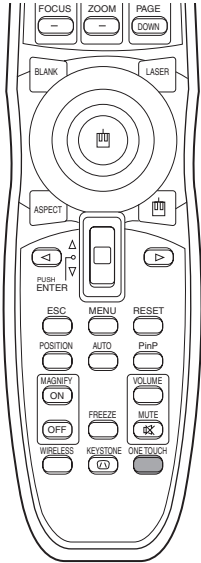

## 1

### Press the **ONE TOUCH** button

You can activate the following functions just by pressing the ONE TOUCH button:



- (1) **Signal search:** Cycle through input signals, displaying the images of retrieved signals. If no signal is found, returns to the signal that was selected before the search was begun.

- When BNC (RGB) is selected:

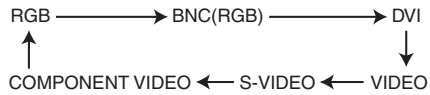

- When BNC (COMPONENT) is selected:

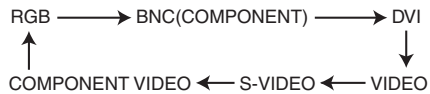

- (2) **Automatic adjustment:** In RGB mode, automatically adjust the picture position and size; for VIDEO input, automatically select the signal mode. ( 20 )
- (3) **Automatic keystone distortion correction:** This is only performed if ONE TOUCH of the AUTO menu is set to TURN ON. When performed, the unit automatically corrects vertical keystone distortion due to the (forward/backward) setup angle of the main unit. ( 29 )

## NOTES

- May not function properly with some input signals.
- This function takes about 10 seconds to display an image.



## SELECTING THE ASPECT RATIO

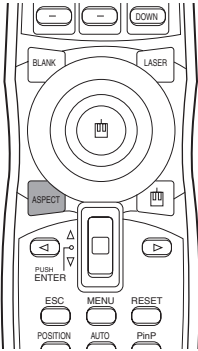

- Press the ASPECT button**  
 RGB, DVI, COMPONENT VIDEO  
 (HDTV signals : 1125i (1035i/1080i), 750p)  
 4:3 ↔ 16:9  
 VIDEO IN, S-VIDEO IN, COMPONENT VIDEO  
 (Non-HDTV signals : 525i, 525p, 625i)  
 4:3 → 16:9 → SMALL



## TEMPORARILY BLANKING THE SCREEN

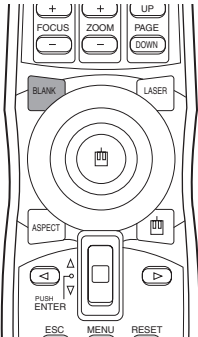

- Press the BLANK button**  
 The input signal screen is shut off, and a blank screen appears. You can set the blank screen using the menu (from the SCREEN menu, select BLANK). Press the BLANK button again to remove the blank screen, and return to the input signal screen.



## DISPLAYING CHILD WINDOW (P. IN. P: Picture in Picture)

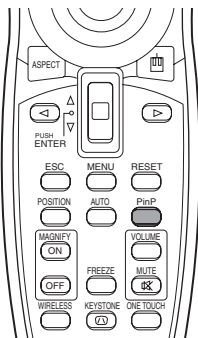

- Press the P. in P. Button**  
 You can display the video input in a child window while displaying RGB, BNC, or DVI input.

Display child window (small) → Display child window (large) → No display

You can select the video input to display in the child window, and the position of the child window, from the INPUT menu. ( 28 )

# USING THE MENU FUNCTIONS

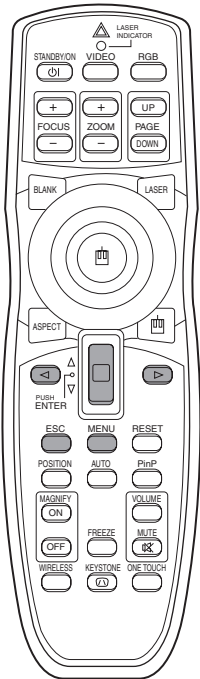

## 1 Press the MENU button

The menu display appears on the screen. The projector has the following menus: MAIN, PICTURE-1, PICTURE-2, INPUT, AUTO, SCREEN, and OPTION, WIRELESS. When you select a menu name using the lever switch / , the current settings of items that can be manipulated from that menu are displayed.



## 2 Use the lever switch / to select a menu, then press the or ENTER button

The display of the selected menu appears.  
[ex. Adjusting SHARPNESS]

Use the lever switch / to select PICTURE-1, then press the or ENTER button.

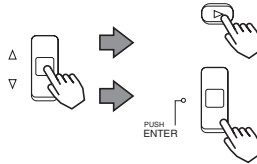

MENU	
MAIN	COLOR BAL R -1
	COLOR BAL B +1
PICTURE-1	SHARPNESS -1
PICTURE-2	COLOR +1
INPUT	TINT -1
AUTO	
SCREEN	
OPTION	
WIRELESS	
SELECT	

## 3 Use the lever switch / to select SHARPNESS, then press the or ENTER button

The operation display of the selected item appears. To adjust a numerical value, press the or ENTER button again to switch to the single menu (small display showing only the operation display area).

[ex. Adjusting SHARPNESS]

Use the lever switch / to select SHARPNESS, then press the or ENTER button.

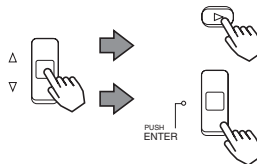

MENU	
MAIN	COLOR BAL R
	COLOR BAL B
PICTURE-1	COLOR BAL B
PICTURE-2	SHARPNESS
INPUT	COLOR
AUTO	TINT
SCREEN	
OPTION	
WIRELESS	
SELECT	

### NOTE

- For details about menu operations, see "MULTI FUNCTIONAL SETTINGS" ( 26 ).

## 4 Use the lever switch / to adjust the level

Press the MENU button to hide the menu and finish your operation. Alternatively, press the or ESC button to return to the previous display.

[ex. Adjusting SHARPNESS]

Use the lever switch / to adjust the sharpness.



# MULTIFUNCTIONAL SETTINGS

This device has 8 separate menus: **MAIN, PICTURE-1, PICTURE-2, INPUT, AUTO, SCREEN, OPTION, WIRELESS**. Each of these menus is operated using the same methods. The basic operations of these menus are as follows.

**Menu screen display** : Press the "MENU" button.

**Menu selection** : Use the lever switch  $\uparrow/\downarrow$  to select a menu name, then press the  $\rightarrow$  or ENTER button.

**Item selection** : Use the lever switch  $\uparrow/\downarrow$  to select an item, then press the  $\rightarrow$  or ENTER button.

**Return menu to last previous screen**: Press the  $\leftarrow$  button or the ESC button.

**Execution of settings and/or adjustments**: Perform the operation using the lever switch  $\uparrow/\downarrow$ .

(For further details, read the explanation for each separate menu.)

**Initialization of settings and/or adjustments**: During operation, press the RESET button.  
(Functions that are executed at the same time as a selection, including H PHASE, LANGUAGE selection, and ADJUST, will not be reset.)

**End menu operations**: Press the MENU button, or do not perform any operation for several seconds.

## MAIN Menu

With the MAIN menu, the seven items shown in the Table below can be performed.

Perform each operation in accordance with the instructions in the Table.

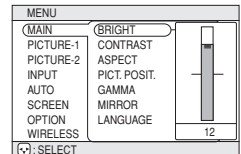

Example : MAIN Menu (BRIGHT)

## MAIN Menu

Item	Description
<b>BRIGHT</b>	<b>Adjust Brightness:</b> Light $\uparrow$ $\leftrightarrow$ $\downarrow$ Dark
<b>CONTRAST</b>	<b>Adjust Contrast:</b> Strong $\uparrow$ $\leftrightarrow$ $\downarrow$ Weak
<b>ASPECT</b>	<b>Select Aspect Ratio:</b> At RGB Input or Hi-Vision 1125i(1035i/1080i)/750p of COMPONENT VIDEO Input: 4:3 $\uparrow$ $\leftrightarrow$ $\downarrow$ 16:9 At VIDEO Input, S-VIDEO Input or 525i/525p/625i of COMPONENT VIDEO Input: 4:3 $\uparrow$ $\leftrightarrow$ $\downarrow$ 16:9 $\uparrow$ $\leftrightarrow$ $\downarrow$ SMALL • The SMALL picture may not be displayed correctly with certain input signals.
<b>PICT.POSIT.</b>	<b>Select Picture Position (for 16:9/SMALL Picture):</b> TOP $\uparrow$ $\leftrightarrow$ $\downarrow$ CENTER $\uparrow$ $\leftrightarrow$ $\downarrow$ BOTTOM
<b>GAMMA</b>	<b>Select Gamma Mode:</b> NORMAL $\uparrow$ $\leftrightarrow$ $\downarrow$ CINEMA $\uparrow$ $\leftrightarrow$ $\downarrow$ DYNAMIC
<b>MIRROR</b>	<b>Select Mirror Status:</b> NORMAL $\uparrow$ $\leftrightarrow$ $\downarrow$ H:INVERT $\uparrow$ $\leftrightarrow$ $\downarrow$ V:INVERT $\uparrow$ $\leftrightarrow$ $\downarrow$ H&V:INVERT
<b>LANGUAGE</b>	<b>Select Menu Language:</b> ENGLISH $\uparrow$ $\leftrightarrow$ $\downarrow$ FRANÇAIS $\uparrow$ $\leftrightarrow$ $\downarrow$ DEUTSCH $\uparrow$ $\leftrightarrow$ $\downarrow$ ESPAÑOL $\uparrow$ $\leftrightarrow$ $\downarrow$ ITALIANO $\uparrow$ $\leftrightarrow$ $\downarrow$ NORSK $\uparrow$ $\leftrightarrow$ $\downarrow$ NEDERLANDS $\uparrow$ $\leftrightarrow$ $\downarrow$ 日本語 $\uparrow$ $\leftrightarrow$ $\downarrow$ POTUGUÊS $\uparrow$ $\leftrightarrow$ $\downarrow$ 中文 $\uparrow$ $\leftrightarrow$ $\downarrow$ 한글

## PICTURE-1 Menu

With the PICTURE-1 menu, the five items shown in the Table below can be performed.  
Perform each operation in accordance with the instructions in the Table.

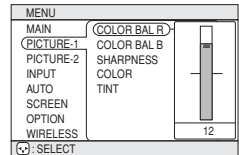

Example : PICTURE1 Menu (COLOR BAL R)

### PICTURE-1 Menu

Item	Description
<b>COLOR BAL R</b>	<b>Adjust Red Color Balance:</b> Dark  ⇌  Light
<b>COLOR BAL B</b>	<b>Adjust Blue Color Balance:</b> Dark  ⇌  Light
<b>SHARPNESS</b>	<b>Adjust Sharpness (for VIDEO/S-VIDEO):</b> Clear  ⇌  Soft
<b>COLOR</b>	<b>Adjust COLOR (for VIDEO/S-VIDEO/COMPONENT VIDEO):</b> Dark  ⇌  Light
<b>TINT</b>	<b>Adjust Tint (for VIDEO/S-VIDEO):</b> Green  ⇌  Red

## PICTURE-2 Menu

With the PICTURE-2 menu, the five items shown in the Table below can be performed.  
Perform each operation in accordance with the instructions in the Table.

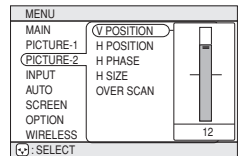

Example : PICTURE2 Menu (V POSITION)

### PICTURE-2 Menu

Item	Description
<b>V POSITION</b>	<b>Adjust Vertical Position (for RGB):</b> Up  ⇌  Down
<b>H POSITION</b>	<b>Adjust Horizontal Position (for RGB):</b> Left  ⇌  Right
<b>H PHASE</b>	<b>Adjust Horizontal Phase (for RGB/COMPONENT VIDEO):</b> Right  ⇌  Left • Adjust to eliminate flicker.
<b>H SIZE</b>	<b>Adjust Horizontal Size (for RGB):</b> Large  ⇌  Small • If the horizontal size adjustment is excessive, the image may not be displayed correctly. In such a case, initialize H SIZE with the RESET button.
<b>OVER SCAN</b>	<b>Select Over-scan Ratio (for VIDEO/S-VIDEO/COMPONENT VIDEO):</b> LARGE  ⇌  MIDDLE  ⇌  SMALL • If you select LARGE, you may note streaking on the top and bottom of the screen, or flicker. If this is irritating, we suggest you select SMALL.

# MULTIFUNCTIONAL SETTINGS (continued)

## INPUT Menu

The three Input menu items listed in the table below can be manipulated. For RGB input, the reception signal's horizontal and vertical frequency is displayed on the initial menu screen. Use the table below as a guide for operation.

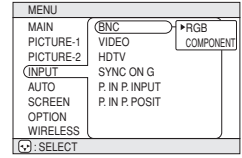

Example : INPUT Menu (BNC)

## INPUT Menu

Item	Description
<b>BNC</b>	<p><b>BNC Pin (R/C<sub>R</sub>/P<sub>R</sub>, G/Y, B/C<sub>B</sub>/P<sub>B</sub>, H, V) function selection:</b>            BNC (RGB)  ⇌  BNC (COMPONENT)</p> <p> (R)  (G)  (B)  (H)  (V)       (C<sub>R</sub>/P<sub>R</sub>)  (Y)  (C<sub>B</sub>/P<sub>B</sub>)  (-)  (-)</p> <p>(Pins for RGB)                      (Pins for COMPONENT)</p> <p>Selecting BNC (RGB) allows the 5 RGB2 pins (R/C<sub>R</sub>/P<sub>R</sub>, G/Y, B/C<sub>B</sub>/P<sub>B</sub>, H, V) to be used as RGB signal BNC input as-is.</p> <p>Selecting BNC (COMPONENT) allows the 3 leftmost RGB2 pins (R/C<sub>R</sub>/P<sub>R</sub>, G/Y, B/C<sub>B</sub>/P<sub>B</sub>) to be used as the COMPONENT VIDEO input C<sub>R</sub>/P<sub>R</sub>, Y, and C<sub>B</sub>/P<sub>B</sub> pins.</p>
<b>VIDEO</b>	<p><b>Select Mode of Signal Type (for VIDEO/S-VIDEO):</b>            AUTO  ⇌  NTSC  ⇌  PAL  ⇌  SECAM  ⇌  NTSC4.43  ⇌  M-PAL  ⇌  N-PAL</p> <p>When AUTO is selected, the video/ S-video input function under ADJUST ( <b>29</b> ) are enabled, and is executed simultaneously so that the optimum signal mode is selected from among the modes listed above.</p> <p>Use this function if the image becomes unstable with VIDEO/S-VIDEO. (e.g. The image becomes irregular, or lacks color.)</p> <ul style="list-style-type: none"> <li>• AUTO mode may not function correctly with a PAL60 signal and certain other signals.</li> <li>• The AUTO mode operation requires approximately 10 seconds.</li> <li>• For COMPONENT VIDEO, the signal type is identified automatically even if this function is inactive. For a HDTV signal, refer to the item HDTV below.</li> </ul>
<b>HDTV</b>	<p><b>Select HDTV Signal Mode:</b> 1080i  ⇌  1035i</p> <ul style="list-style-type: none"> <li>• If the selected HDTV mode is incompatible with the input signal, the picture may be distorted.</li> </ul>
<b>SYNC ON G</b>	<p><b>On/Off SYNC ON G Mode:</b> TURN ON  ⇌  TURN OFF</p> <p>Selecting TURN ON turns on the SYNC ON G mode. The SYNC ON G mode allows reception of SYNC on G.</p> <ul style="list-style-type: none"> <li>• In the SYNC ON G mode, the picture may be distorted with certain input signals. In such a case, remove the signal connector so that no signal is received and turn SYNC ON G off, and then reconnect the signal.</li> </ul>
<b>P. IN P. INPUT</b>	<p><b>P. IN P. screen (*) input signal selection:</b> VIDEO  ⇌  S-VIDEO</p> <p>Selects the signal displayed on the P. IN P. subscreen.</p>
<b>P. IN P. POSIT</b>	<p><b>P. IN P. screen (*) display position selection:</b></p> <p>  ⇌   ⇌   ⇌  </p> <p>Selects the position at which the P. IN P. subscreen is displayed.</p>

(\*) The P. IN P. (picture-in-picture) function displays the video signal image in a subscreen (P. IN P. screen) on top of the screen on which the RGB signal image is being displayed. (See "Displaying Child Window" **24** .)

## AUTO Menu

With the AUTO menu, the four items shown in the Table below can be performed.

Please perform each operation in accordance with the instructions in the Table.

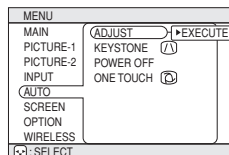

Example : AUTO Menu (ADJUST)

## AUTO Menu

Item	Description
<b>ADJUST</b>	<p><b>Auto Adjust (for RGB):</b> Automatically adjusts H POSITION, V POSITION, H PHASE, and H SIZE. Use this function with the maximum window size.</p> <p><b>Auto Adjust (for VIDEO/S-VIDEO):</b> This function automatically selects the appropriate signal mode depending on input signals. This is only performed if AUTO is selected on the VIDEO menu item (28) of the INPUT menu.</p> <ul style="list-style-type: none"> <li>• This function may not be available with a PAL60 signal and certain other signals.</li> <li>• The AUTO mode operation requires approximately 10 seconds.</li> <li>• For COMPONENT VIDEO, the signal type is identified automatically even if this function is inactive. For more information on HDTV signals, see HDTV. (28)</li> </ul>
<b>KEYSTONE (A)</b>	<p><b>Automatic keystone distortion correction:</b></p> <p>You can automatically correct vertical keystone distortion corresponding to the angle (forward/backward tilt) at which the unit is set up.</p> <ul style="list-style-type: none"> <li>• If the projection screen is inclined, or if the projector is angled downwards, it may not be possible to make the correct adjustment when V: INVERT or H&amp;V: INVERT is selected under the MIRROR item of the MAIN menu.</li> <li>• When the zoom adjustment is set to the TELE side, automatic correction may be excessive. The automatic correction function should be used with zoom set to WIDE whenever possible.</li> </ul>
<b>POWER OFF</b>	<p><b>Adjust POWER OFF Time:</b></p> <p>Long (MAX. 99 min.) [ ] ⇔ [ ] Short (Min. 1 min.) [ ] ⇔ [ ] (DISABLE: 0 min.)</p> <p>If the time set here passes without valid signal input (there is no signal input, or signal input is out of specifications), the standby mode is set (see "TURNING ON THE POWER" 15 ). This function is inactive when DISABLE (0 min.) is selected.</p>
<b>ONE TOUCH (B)</b>	<p><b>Enabling/disabling the KEYSTONE (A) function using the ONE TOUCH (B) button:</b></p> <p>TURN ON [ ] ⇔ [ ] TURN OFF</p> <p>Pressing the ONE TOUCH button will automatically retrieve pictures and automatically adjust the screen (see "ADJUSTING SCREEN WITH ONE-TOUCH" 23 ), and you can also set the function to execute KEYSTONE (A) (see above in this table) simultaneously when pressed. KEYSTONE will be executed if TURN ON is selected.</p>

# MULTIFUNCTIONAL SETTINGS (continued)

## SCREEN Menu

With the SCREEN menu, the five items shown in the Table below can be performed. Please perform each operation in accordance with the instructions in the Table.

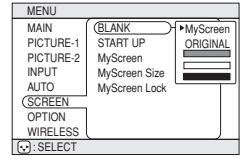

Example : SCREEN Menu (BLANK)

## SCREEN Menu

Item	Description
<b>BLANK</b>	<p><b>Selection of BLANK Screen:</b>            MyScreen  ⇔  ORIGINAL  ⇔   ⇔   .  ⇔   .  ⇔   .</p> <p>The BLANK Screen may be voluntarily selected. The BLANK Screen is displayed when the screen has been erased (i.e., made to vanish) by manipulating the BLANK button (please refer to the "Temporarily Blanking the Screen" section).</p> <p><b>MyScreen:</b> Using the MyScreen category (see this Table, below), one can register a desired screen (or screens). At the time of factory shipment, this is set as a non-patterned (plain) blue color screen.</p> <p><b>ORIGINAL:</b> Existing standard screens. Please make confirmation using the actual screen(s).</p> <p><b>Option screens:</b> Various colored non-patterned (plain) screens displayed within the Menus.</p> <ul style="list-style-type: none"> <li>The MyScreen and the ORIGINAL Screen will each change to a non-patterned (plain) black color screen several minutes after being displayed.</li> </ul>
<b>START UP</b>	<p><b>Selection of START UP Screen:</b> MyScreen  ⇔  ORIGINAL  ⇔  TURN OFF</p> <p>The START UP Screen may be voluntarily selected. The START UP Screen is displayed when no signal has been inputted, or when spec signals are being inputted.</p> <p><b>MyScreen:</b> Using the MyScreen category (see this Table, below), one can register a desired screen (or screens). At the time of factory shipment, this is set as a non-patterned (plain) blue color screen.</p> <p><b>ORIGINAL:</b> Existing standard screens. Please make confirmation using the actual screen(s).</p> <p><b>TURN OFF:</b> A non-patterned (plain) blue color screen.</p> <ul style="list-style-type: none"> <li>The MyScreen and ORIGINAL screens will switch to the BLANK screen (see above in this table) a few minutes after being displayed. If the BLANK screen is the MyScreen or ORIGINAL screen, it will turn immediately to a solid black screen.</li> </ul>
<b>MyScreen</b>	<p><b>Registration of MyScreen:</b>            When this item is executed, the MyScreen Menu for registration of MyScreen for the BLANK Screen and the START UP Screen is displayed. When operations are performed in accordance with this Menu, one can "cut" and register desired screens from among the received images within the display.</p> <ol style="list-style-type: none"> <li>After the "Do you start capturing this picture?" message has been displayed, pressing the ESC (or RESET) button interrupts execution of the MyScreen. When the ENTER button is pressed, the picture becomes static (no longer moves), and a frame for picture cutting, as well as the message that follows below, appear. Please press the button when the screen you want to register is currently being displayed.</li> <li>When the "Move the capture area as you want." message has been displayed, pressing the ESC (or RESET) button will eliminate the static state of the picture, and operations can be performed again from operation 1.            The frame can be moved using the , , ,  buttons. After designating the screen you want to register, pressing the ENTER button will initiate screen registration. The registration process takes approximately 1 minute to complete.</li> <li>When the registration has been completed, the screen of the registered MyScreen, plus the message, "MyScreen registration is finished," will be displayed for several seconds, after which the operation is terminated.</li> </ol>
<b>MyScreen Size</b>	<b>Selection of MyScreen display size:</b> x1  ⇔  FULL
<b>MyScreen Lock</b>	<p><b>Invalidation of MyScreen registration function:</b> TURN ON  ⇔  TURN OFF</p> <p>When TURN ON is selected, the MyScreen category (see this Table, above) cannot be executed: in this way, one can prohibit rewrites ("writeovers") of the MyScreen.</p>

## OPTION Menu

With the OPTION menu, the five items shown in the Table below can be performed.

Please perform each operation in accordance with the instructions in the Table.

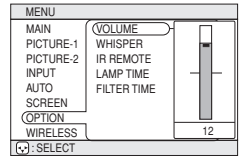

Example : OPTION Menu (VOLUME)

## OPTION Menu

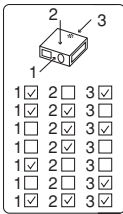
Item	Description
<b>VOLUME</b>	<b>Adjust Volume:</b> High <input type="checkbox"/> ↔ <input type="checkbox"/> Low
<b>WHISPER</b>	<b>Select WHISPER Mode:</b> NORMAL <input type="checkbox"/> ↔ <input type="checkbox"/> WHISPER When WHISPER is selected the WHISPER mode is activated. In the WHISPER mode, acoustic noise and screen brightness are reduced.
<b>IR REMOTE</b>	<b>Selecting the remote control receiver:</b> The unit has 3 remote control receivers, as shown in the figure to the right (1, 2, and 3). You can select which of them to activate ("v" in the figure), and which to disable. <ul style="list-style-type: none"> <li>The ambient lighting and other factors may prevent the remote control operation from functioning properly. If this happens, use this function to disable receivers being impacted by unneeded light.</li> </ul> 
<b>LAMP TIME</b>	<b>Refer to LAMP TIME:</b> When set, this function displays the total time the projector lamp has been used since new. <b>Reset LAMP TIME [Use this function only when the lamp has been replaced!]:</b> Depress the RESET button for at least 3 seconds while lamp time is being displayed. The reset menu will then appear. After you replace the lamp with a new lamp, select RESET on the menu with the <input type="checkbox"/> button. <ul style="list-style-type: none"> <li>Do not reset the lamp time unless you have replaced the lamp. And, always reset the lamp time when replacing the lamp. The message functions will not operate properly if the lamp time is not reset correctly.</li> <li>Before replacing the lamp, carefully read the descriptions headed "THE LAMP".</li> </ul>
<b>FILTER TIME</b>	<b>Refer to FILTER TIME:</b> This function displays the total time the air-filter has been used since new. <b>Reset FILTER TIME [Use this function only when the filter is cleaned or replaced!]:</b> Depress the RESET button for at least 3 seconds while lamp time is being displayed. The reset menu will then appear. After you replace the filter, select RESET on the menu with the <input type="checkbox"/> button. RESET <input type="checkbox"/> ↔ <input type="checkbox"/> CANCEL <ul style="list-style-type: none"> <li>Do not reset the filter time unless you have cleaned or replaced the filter. And, always reset the filter time when cleaning or replacing the filter. The message functions will not operate properly if the filter time is not reset correctly.</li> <li>Before cleaning or replacing the filter, carefully read the descriptions headed "THE AIR FILTER".</li> </ul>

## WIRELESS Menu

The WIRELESS menu is only enabled if the wireless function is enabled. Using the wireless function requires a Wireless & Network Module Terminal (sold separately). See the Wireless & Network Module Terminal user's manual for more information about the WIRELESS menu. Contact your local dealer for more information about the wireless function and Wireless & Network Module Terminal.



# OPERATING THE PC SCREEN

You can use the remote control as a simplified mouse or keyboard.

**CAUTION** Caution: Mistaken use of the mouse/keyboard control could damage your equipment.

- Only connect to a PC.
- Before connecting, read the manuals of the device you will connect.
- Do not unplug the connector cables while the computer is operating.

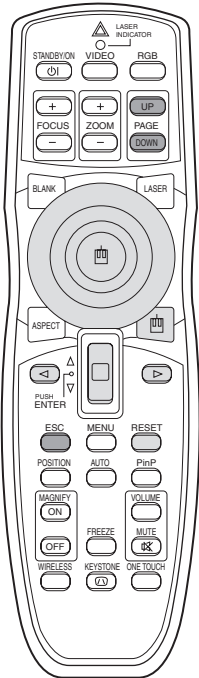

## PS/2, ADB, Serial Mouse Control

1. Turn off the projector and PC power, and connect the projector's CONTROL terminal to the computer via the mouse cable.
2. If a USB cable is connected, disconnect it. If a USB cable is connected, the USB control function is given priority, and mouse control from the CONTROL terminal will not function.
3. Turn on the projector power, then the computer.

The functions in the table below can be controlled. If you have difficulty with control, restart the computer (either from the software or by pressing the restart button).

Available Functions	Remote Control Operation
Move Pointer	Move using  on the disk pad
Left click with mouse	Press the center  of the disk pad
Right click with mouse	Press the right mouse button

## USB Mouse/Keyboard Control

1. Connect the projector's USB terminal to a PC using a USB cable. The functions in the table below can be controlled.

Available Functions	Remote Control Operation
Move Pointer	Move using  on the disk pad
Left click with mouse	Press the center  of the disk pad
Right click with mouse	Press the right mouse button
Press the keyboard's     keys	Press
Press the keyboard's ENTER key	Press the ENTER button
Press keyboard's PAGE UP key	Press PAGE UP button
Press keyboard's PAGE DOWN key	Press PAGE DOWN button
Press keyboard's ESC key	Press ESC button

## NOTES

- It may not be possible to control notebook PCs, and other computers with built-in pointing devices (e.g. track balls), using this remote control. In this case, before connecting go into BIOS (system setup) and select external mouse, and disable the pointing devices. In addition, the mouse may not function if the computer does not have the needed utility program. See your computer's hardware manual for details.
- The USB control can be used with Windows 95 OSR 2.1 or higher. It may not be possible to use the remote control, depending on the computer's configurations and mouse drivers.
- The USB control can only be used for the functions listed above. You cannot do things like press two buttons at once (for instance, pressing two buttons at the same time to move the mouse pointer diagonally).
- This function is not available while the lamp is warming up (the POWER indicator flashes green), while adjusting the volume and display, correcting for trapezoidal distortion, zooming in on the screen, using the BLANK function, or displaying the menu screen.

# THE LAMP



HIGH VOLTAGE  
HIGH TEMPERATURE  
HIGH PRESSURE

To replace the lamp, check the model number of the replacement lamp (sold separately) and contact your local dealer.

Replacement lamp model number: 78-6969-9601-2

If the projector is mounted on the ceiling, or if the lamp has broken, ask your dealer to replace the lamp. Lamp replacement is hazardous and should not be attempted by the user.

Before replacing the lamp, make sure the power switch is off and the power cable is not plugged in, then wait at least 45 minutes for the lamp to cool sufficiently. Handling the lamp while hot can cause burns, as well as damaging the lamp.

**⚠ WARNING** The LCD projector uses a glass lamp bulb. It is a mercury lamp with high internal pressure. High-pressure mercury lamps can break with a loud bang, or burn out, if jolted or scratched, or through wear over time. Each lamp has a different lifetime, and some may burst or burn out soon after you start using them. In addition, when the bulb bursts, it is possible for shards of glass to fly into the lamp housing, and for gas containing mercury to escape from the projector's vent holes.

- Do not open the lamp cover while the projector is suspended from above. This is dangerous, since if the lamp's bulb has broken, the shards will fall out when the cover is opened. In addition, working in high places is dangerous, so ask your local dealer to have the lamp replaced even if the bulb is not broken.
- Handle with care: jolting or scratching could cause the lamp bulb to burst during use.
- If the replace lamp indicator (see "Related Messages" (38) and "Regarding the indicator Lamps" (39)) comes on, replace the lamp as soon as possible. Using the lamp for long periods of time, or past the replacement date, could cause it to burst. Do not use old (used) lamps; this is a cause of breakage.
- If the lamp breaks soon after the first time it is used, it is possible that there are electrical problems elsewhere besides the lamp. If this happens, contact your local dealer or a service representative.
- If the lamp should break (it will make a loud bang when it does), ventilate the room well, and make sure not to breathe the gas that comes out of the projector vents, or get it in your eyes or mouth.
- If the lamp should break (it will make a loud bang when it does), unplug the power cord from the outlet, and make sure to request a replacement lamp from your local dealer. Note that shards of glass could damage the projector's internals, or cause injury during handling, so please do not try to clean the projector or replace the lamp yourself.
- Obey local ordinances when disposing of used lamps. In most cases, it is possible to dispose of used bulbs in the same manner as used glass bottles, but in some cases, bulbs are sorted separately.
- Do not use the projector with the lamp cover removed.

## THE LAMP (continued)

### Replacing the lamp

All projector lamps will wear out eventually. If used for long periods of time, the image could become darkened, and the color contrast could be impacted as well. We recommend that you replace your lamps early. If the LAMP indicator turns red, or a message prompts you to replace the lamp when you power up the projector, the lamp needs to be replaced. (See "Related Messages" ( 38 ) and "Regarding the Indicator Lamps" ( 39 ) for details.)

- 1 Turn off the projector, and unplug the power cord. Allow the lamp bulb to cool for at least 45 minutes, and prepare a new lamp.

- 2 After making sure that the projector has cooled adequately, slide the knob of a lamp cover lock as shown in the figure. Then, one side of the lamp cover is raised. Pull up the lamp cover and remove it, as shown in the figure.

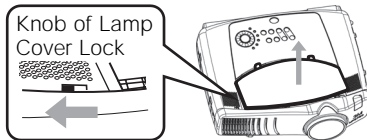

- 3 Unscrew the 3 screws, and slowly pull out the lamp by the handle.
  - Be careful not to touch the inside of the lamp case.

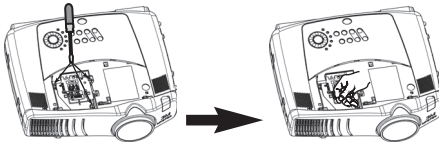

- 4 Insert the new lamp, and tighten the 3 screws firmly to lock it in place.

- 5 Interlocking the 2 tabs of the lamp cover to the projector, put the lamp cover on the projector. Then push the point of the lamp cover to fix it, as shown in the figure. Make sure that the lamp cover doesn't come up.

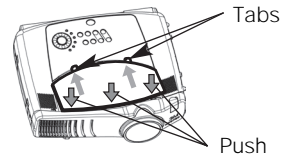

- 6 Turn on the projector power, and reset the lamp timer.
  - To reset the lamp timer, from the OPTION menu, select the LAMP TIME. ( 31 )

**ATTENTION** • Make sure that the screws are screwed in firmly. Loose screws could result in damage or injury.

- Do not use with lamp cover removed.
- Do not reset the lamp timer without replacing the lamp. Reset the lamp timer always when replacing the lamp. The message functions will not operate properly if the lamp timer is not reset correctly.
- When the lamp has been replaced after the message of "CHANGE THE LAMP .....THE POWER WILL TURN OFF AFTER 0 hr." is displayed, or the LAMP indicator is red, complete the following operation within 10 minutes of switching power on.

**NOTE** • The LAMP indicator is also red when the lamp unit reaches high temperature. Before replacing the lamp, switch power off, wait approximately 20 minutes, and switch power on again. If the LAMP indicator is still red, replace the lamp.

## THE AIR FILTER

### ***Caring for the air filter***

The air filter should be cleaned about every 100 hours. If the LAMP indicator and TEMP indicator blink red simultaneously, or a message prompts you to clean the air filter when you turn on the unit, the filter needs to be cleaned. (See "Related Messages" ( [38](#) ) and "Regarding the Indicator Lamps" ( [39](#) ) for details.)

1 Turn off the projector, and unplug the power cord

2 Apply a vacuum cleaner to the top of the air filter cover to clean the air filter

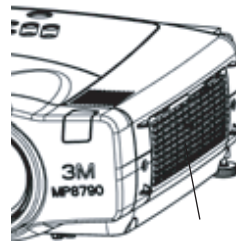

Filter Cover

3 Turn on the projector, and use the menu to reset the filter timer

- To reset the air filter timer, from the OPTION menu, select FILTER TIME.

## THE AIR FILTER (continued)

### ***Replacing the air filter***

If the soiling will not come off the air filter, or it becomes damaged, then it needs to be replaced. Please contact your local dealer, after confirming the model of your separately sold replacement air filter.

1 Turn off the projector, and unplug the power cord. Prepare a new air filter (one specified for your projector)

2 Remove the air filter cover and air filter

3 Insert the new filter, and replace the filter cover

4 Turn on the projector power, and using the menu, reset the filter timer

- To reset the lamp timer, from the OPTION menu, select FILTER TIME.

**ATTENTION** • Make sure to turn off the power and unplug the power cord before caring for the unit. Please carefully read "Safety Instructions", in order to care for your projector correctly.

- Do not use with air filter cover removed.
- If the air filter becomes clogged by dust or the like, internal temperature rises and could cause malfunction. The power is automatically turned off in order to prevent the unit from overheating internally.

## OTHER CARE

### **Caring for the inside of the projector :**

In order to ensure the safe use of your projector, please have it cleaned and inspected by your local dealer about once every 2 years. Never try to care for the inside of the unit yourself. Doing so is dangerous.

### **Caring for the lens :**

Lightly wipe the lens with a commercially available lens-cleaning wipe. Do not touch the lens directly with your hand.

### **Caring for the cabinet and remote control transmitter :**

Wipe lightly with gauze or a soft cloth. If soiling is severe, dip a soft cloth in water or a neutral cleanser diluted in water, and wipe lightly after wringing well. Then, wipe lightly with a soft, dry cloth.

**ATTENTION** • Make sure to turn off the power and unplug the power cord before caring for the unit. Please carefully read "Safety Instructions" in this manual, in order to care for your projector correctly.

- Do not use cleaners or chemicals other than those listed above, including benzene and paint thinner.
- Do not use aerosols or sprays.
- Do not polish or wipe with hard objects.

# WHAT TO DO WHEN YOU THINK A MACHINE DEFECT HAS OCCURRED

## Related Messages

When the unit's power is ON, messages such as those shown below may be displayed. When any such message is displayed on the screen, please respond as described below.

Message	Description
<b>CHANGE THE LAMP AFTER REPLACING LAMP, RESET THE LAMP TIMER.</b> (Note 1)	Lamp usage time is approaching 2,000 hours. (Note 2) Preparation of a new lamp, and an early lamp change, is recommended. After you have changed the lamp, please be sure to reset the lamp timer.
<b>CHANGE THE LAMP AFTER REPLACING LAMP, RESET THE LAMP TIMER. THE POWER WILL TURN OFF AFTER * * hr.</b> (Note 1)	Lamp usage time is approaching 2,000 hours. A lamp change within * * hours is recommended. (Note 2) When lamp usage reaches 2,000 hours, the power will automatically be turned OFF. Please change the lamp by referring to "THE LAMP" ( 33 ). After you have changed the lamp, please be sure to reset the lamp timer.
<b>CHANGE THE LAMP AFTER REPLACING LAMP, RESET THE LAMP TIMER. THE POWER WILL TURN OFF AFTER 0 hr.</b>	As lamp use has reached 2,000 hours, the power will soon be automatically turned OFF. (Note 2) Please immediately turn the power OFF, and follow the instructions in the "THE LAMP" ( 33 ). After you have changed the lamp, please be sure to reset the lamp timer. ( 31 )
<b>CLEAN THE AIR FILTER AFTER CLEANING AIR FILTER, RESET THE FILTER TIMER.</b>	A note of precaution when cleaning the air filter. After cleaning the filter, operate FILTER TIME of the OPTION Menu ( 31 ), and perform reset of the filter timer.
<b>NO INPUT IS DETECTED ON * * *</b>	There is no input signal. Please confirm the signal input connection, and the status of the signal source.
<b>SYNC IS OUT OF RANGE</b> ON *** <input type="text" value="fH"/> *****kHz <input type="text" value="fV"/> *****Hz	The horizontal or vertical wavelength of the inputted signal is outside of the response parameters of this unit. Please confirm the specs for this unit or the signal source specs.
<b>CHECK THE AIR FLOW</b>	The internal portion temperature is rising. Please turn the power OFF, and allow the unit to cool down for approximately 20 minutes. After having confirmed the following items, then please resent the power to ON. <ul style="list-style-type: none"> <li>• Is there blockage of the air passage aperture?</li> <li>• Is the air filter dirty?</li> <li>• Does the peripheral temperature exceed 35°C?</li> </ul>

### NOTES

Note 1: Although this message will be automatically disappeared after around 3 minutes, it will be reappeared every time the power is turned ON.

Note 2: Lamps have a finite product life. Lamps are characterized by the fact that, after long hours of usage, a lamp will no longer light up, or the lamp will break or burst, etc. This unit is equipped with an automatic shut-down function, such that the power will automatically be turned OFF when lamp usage time has reached 2,000 hours. Please be aware, however, that among lamp types, there are major differences in product lifetimes; a lamp may thus fail to light even prior to the functioning of the automatic shut-down function of this unit.

## Regarding the Indicator Lamps

Lighting and flashing of the POWER indicator, the LAMP indicator, and the TEMP indicator have the meanings as described in the Table below. Please respond in accordance with the instructions within the Table.

POWER indicator	LAMP indicator	TEMP indicator	Description
The orange lamp is lighted	Turned OFF (Not lighted)	Turned OFF (Not lighted)	The STANDBY mode is set
Flashing of the green lamp	Turned OFF	Turned OFF	The unit is warming up. Please wait.
The green lamp is lighted	Turned OFF	Turned OFF	The unit is in an ON state. Ordinary operations may be performed.
Flashing of the orange lamp	Turned OFF	Turned OFF	The unit is cooling down. Please wait.
Blinking of the red lamp	-	-	The unit is cooling down. Please wait. A certain error has been detected. Wait until the POWER indicator lamp has finished flashing, and then perform the proper response measure using the item descriptions below as reference.
The red lamp is lighted, or blinks	The red lamp is lighted	Turned OFF	The lamp does not light. There is a possibility that the interior portion has become heated. Turn the power OFF and wait approximately 20 minutes. After the main unit has cooled down, please confirm whether or not there is blockage of the air passage aperture, whether or not the filter is dirty, and/or whether or not the peripheral temperature exceeds 35°C, etc. After performing any needed maintenance, turn the power ON again; if the same display is displayed, then please change the lamp.
The red lamp is lighted, or blinks	Blinking of the red lamp	Turned OFF	Either there is no lamp and/or lamp cover, or either of these has not been properly fixed (attached). Turn the power OFF and wait approximately 45 minutes. After the main unit has sufficiently cooled down, please make confirmation of the attachment state of the lamp and lamp cover. After performing any needed maintenance, turn the power ON again; if the same display is displayed, then please contact a sales store or a service company.
The red lamp is lighted, or blinks	Turned OFF	Blinking of the red lamp	The cooling fan is not operating. Turn the power OFF and wait approximately 20 minutes. After the main unit has cooled down, please make confirmation that no foreign matter has become caught in the fan, etc. After performing any needed maintenance, turn the power ON again; if the same display is displayed, then please contact a sales store or a service company.
The red lamp is lighted, or blinks	Turned OFF	The red lamp is lighted	There is a possibility that the interior portion has become heated. Turn the power OFF and wait approximately 20 minutes. After the main unit has cooled down, please confirm whether or not there is blockage of the air passage aperture, whether or not the filter is dirty, and/or whether or not the peripheral temperature exceeds 35°C, etc. After performing any needed maintenance, turn the power ON again; if the same display is displayed, then please contact a sales store or a service company.
The green lamp is lighted	Alternative blinking with the red lamp		There is a possibility that the interior portion has become overcooled. Please use the unit within the usage temperature parameters (0°C to 35°C). After performing any needed maintenance, turn the power ON again; if the same display is displayed, then please contact a sales store or a service company.
The green lamp is lighted	Simultaneous blinking with the red lamp		This is a notification that it is time to clean the filter. After cleaning the filter, operate the FILTER TIME portion of the OPTION Menu, and perform reset of the FILTER TIME.

### NOTE

When the interior portion has become overheated, for safety purposes, the power source is automatically turned OFF, and the indicator lamps may also be turned OFF. Press the "○" (power OFF) side of the main power switch, and wait for approximately 20 minutes. Please then use the unit only after having first confirmed that the unit has sufficiently cooled down.



## WHAT TO DO WHEN YOU THINK A MACHINE DEFECT HAS OCCURRED (continued)

### Phenomena That May Easily Be Mistaken for Machine Defects

Before requesting repair, check in accordance with the following chart.

If the situation cannot be corrected, then contact your dealer.

Phenomenon	Cases not involving a machine defect	Items to be confirmed	Reference Page(s)
Power does not come ON	The main power source is not ON.	Turn on the main power.	3, 15
	The electrical power cord is not plugged in.	Correctly connect the power cord.	
	The main power source has been interrupted during operation, such as by a power outage (blackout), etc.	Be sure to press the "O" (power OFF) side of the main power switch, and leave this OFF for approximately 20 minutes. After the unit has sufficiently cooled down, turn ON the power source.	15
No sound or pictures are outputted	The input changeover settings are mismatched.	Select the input signal, and correct the settings.	16
	No signal is being inputted.	Correctly connect the connection cord.	8-12
Pictures are displayed, but no sounds are heard	The electrical wiring to this unit is not correctly connected.	Correctly connect the connection cord.	8-12
	The volume setting has been set at (or adjusted to) an extremely low level.	Adjust the VOLUME setting to a higher level.	18
	The MUTE mode is the current setting.	Press the MUTE button to release (change) the MUTE mode setting.	18
Sounds are heard, but no pictures are displayed	The electrical wiring to this unit is not correctly connected.	Correctly connect the connection cord.	8-12
	The brightness setting has been set at (or adjusted to) an extremely low level.	Adjust the BRIGHT setting to a brighter level.	26
	The lens cap has not been removed.	Remove the lens cap.	15
Colors have a faded-out appearance Color tone is poor	Color depth setting or color tone setting	Perform picture adjustments by changing the COLOR BAL R, the COLOR BAL B, and/or the TINT settings, etc.	27
Pictures appear dark	The brightness setting and/or contrast setting has not been properly adjusted.	Perform picture adjustments by changing the BRIGHT and/or CONTRAST settings, etc.	26
	The WHISPER mode is the current setting.	Change (by releasing) from the WHISPER mode.	31
	Lamp is approaching the end of its product lifetime.	Exchange the old lamp with a new lamp.	33, 34
Pictures appear blurry	Either the FOCUS setting or the H PHASE is not properly adjusted.	Adjust the FOCUS and H PHASE settings.	16, 27
Input signal changes with no-operation.	INPUT dial is set between the click points.	Turn the INPUT dial and set it at the click point.	16

#### NOTE

Although bright spots or dark spots may appear on the screen, this is a unique characteristic of liquid crystal displays, and such do not constitute or imply a machine defect.

# SPECIFICATIONS

**NOTE** • This specifications are subject to change without notice.

Item		Specification
Product name		Liquid crystal projector
Liquid crystal panel	Panel size	2.5 cm (0.99 type)
	Drive system	TFT active matrix
	Pixels	786,432 pixels (1024 horizontal x 768 vertical)
Lens		Zoom lens F=1.7 ~ 2.4 f=30.5 ~ 45.8 mm
Lamp		275 W UHB
Speaker		1.0W+1.0W (Stereo)
Power supply		AC100 ~ 120V, 4.7A / AC220 ~ 240V, 2.0A
Power consumption		430W
Temperature range		0 ~ 35°C (Operating)
Size		380 (W) x 120 (H) x 303 (D) mm (Not including protruding parts)
Weight (mass)		5.8 kg
Ports	<p><b>RGB Input Ports</b>            RGB .....1            BNC (when RGB selected)            – (R.G.B.H.V) .....1            DVI .....1</p> <p><b>VIDEO Input Ports</b>            VIDEO IN .....1            S-VIDEO IN .....1            COMPONENT VIDEO            – (Cr/Pr, Cb/Pb, Y) .....1            BNC            (when COMPONENT selected)            – (Cr/Pr, Y, Cb/Pb) .....1</p>	<p><b>AUDIO Ports</b>            AUDIO IN 1 .....1            AUDIO IN 2 .....1            AUDIO IN (R, L) .....1</p> <p><b>RGB Output Port</b>            RGB OUT .....1</p> <p><b>AUDIO Output Port</b>            AUDIO OUT .....1</p> <p><b>CONTROL Ports</b>            CONTROL .....1            USB .....1</p> <p><b>Other Ports</b>            WIRELESS &amp; NETWORK MODULE....1            REMOTE CONTROL .....1</p>

## Dimension Diagram

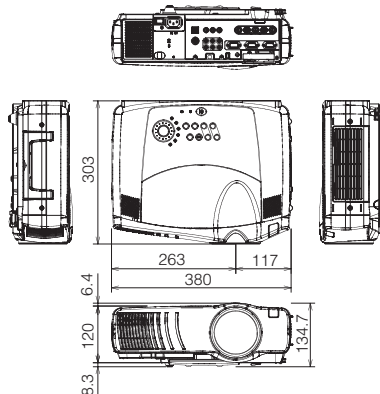

Unit : mm

## ACCESSORIES

Accessories .....	Part Number
UHB Lamp, 275W .....	78-6969-9601-2
Air Filter Assy .....	78-8118-9103-1
Power Cord (US) .....	78-8118-8102-4
Power Cord (UK) .....	78-8118-8101-6
Power Cord (Europe) .....	78-8118-8103-2
VGA Cable .....	78-8118-8708-8
RCA Video/Audio Cable .....	78-8118-3234-0
RCA Component Cable .....	78-8118-8843-3
S-Video Cable .....	78-8118-3238-1
Stereo Mini-Cable.....	78-8118-8846-6
USB cable .....	78-8118-9057-9
RS-232C Adapter .....	78-8118-9114-8
Remote Control .....	78-8118-9115-5
Not Included with Basic Packet .....	Part Number
Ceiling Mount .....	78-6969-9607-9
Adjustable Height Suspension .....	78-6969-9564-2
Shipping Case .....	78-6969-8925-6
Carrying Case.....	78-6969-8926-4
Wireless Module.....	78-6969-9600-4
Mouse Cable (PS/2) .....	78-8118-8105-7
Mouse Cable (Serial) .....	78-8118-8107-3
Mouse Cable (ADB) .....	78-8118-8106-5
Mac Adapter .....	78-8118-3308-2

### How to Order

Please order these parts through your dealer, or contact 3M Customer Service at the following number:

In U.S. or Canada : **1-800-328-1371**

In other locations, contact your local 3M sales office.

#### **Intended Use**

Before operating this machine, please read this entire manual thoroughly. The 3MTM Multimedia Projectors are designed, built, and tested for use indoors, using 3M lamps, 3M ceiling mount hardware, and nominal local voltages.

The use of other replacement lamps, outdoor operation, or different voltages has not been tested and could damage the projector peripheral equipment and/or create a potentially unsafe operating condition.

3M Multimedia projectors and Wall Display Systems are designed to operate in a normal office environment.

- 16° to 29°C (60° to 85° F)
- 10- 80 %RH (without condensation)
- 0- 1828 m (0-6000 feet) above sea level

The ambient operating environment should be free of airborne smoke, grease, oil and other contaminants that can affect the operation or performance of the projector.

Use of this product in adverse conditions will void the product warranty.

Let us help you make the most of your next presentation. We offer everything from presentation supplies to tips for better meetings. And we're the only transparency manufacturer that offers a recycling program for your used transparencies. For late-breaking news, handy reference and free product samples, call us toll-free in the continental United States and Canada, 24 hours a day, or visit our Internet Website.

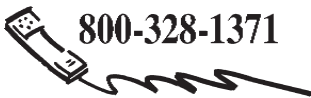

<http://www.3m.com/meetings>  
e-mail: [meetings@mmm.com](mailto:meetings@mmm.com)

#### **3M Austin Center**

Building A145-5N-01  
6801 River Place Blvd.  
Austin, TX 78726-9000

#### **3M Canada**

P.O. Box 5757  
London, Ontario  
N6A 4T1

#### **3M Mexico, S.A. de C.V.**

Apartado Postal 14-139  
Mexico, D.F. 07000  
Mexico

#### **3M Europe**

Boulevard de l'Oise  
95006 Cerge Pontoise Cedex  
France

Litho in Japan  
© 3M 2002

78-6970-9157-3 Rev. A

DN00351 (QR55141\_OG\_ENG)

## Free Manuals Download Website

<http://myh66.com>

<http://usermanuals.us>

<http://www.somanuals.com>

<http://www.4manuals.cc>

<http://www.manual-lib.com>

<http://www.404manual.com>

<http://www.luxmanual.com>

<http://aubethermostatmanual.com>

Golf course search by state

<http://golfingnear.com>

Email search by domain

<http://emailbydomain.com>

Auto manuals search

<http://auto.somanuals.com>

TV manuals search

<http://tv.somanuals.com>