



8e6® Enterprise Reporter

QUICK START GUIDE



Model: ER

HL-022-002, HL-002-002, SL-002-002

Release: 4.1.20 / Updated: 09.19.08

8E6 ENTERPRISE REPORTER QUICK START GUIDE

© 2008 8e6 Technologies. All rights reserved.

This document may not, in whole or in part, be copied, photocopied, reproduced, translated, or reduced to any electronic medium or machine readable form without prior written consent from 8e6 Technologies.

Every effort has been made to ensure the accuracy of this document. However, 8e6 Technologies makes no warranties with respect to this documentation and disclaims any implied warranties of merchantability and fitness for a particular purpose. 8e6 Technologies shall not be liable for any error or for incidental or consequential damages in connection with the furnishing, performance, or use of this manual or the examples herein. The information in this documentation is subject to change without notice.

The ER products have been tested and found to comply with the limits for a Class A digital device, pursuant to part 15 of the FCC Rules. These limits are designed to provide reasonable protection against harmful interference when the equipment is operated in a commercial environment. This equipment generates, uses, and can radiate radio frequency energy and, if not installed and used in accordance with the instruction manual, may cause harmful interference to radio communications. Operation of this equipment in a residential area is likely to cause harmful interference in which case the user will be required to correct the interference at his own expense.

Trademarks

Other product names mentioned in this manual may be trademarks or registered trademarks of their respective companies and are the sole property of their respective manufacturers.

Part# ERul-QSG-080919

CONTENTS

ER ENTERPRISE REPORTER INTRODUCTION.....	1
About this Document	2
Conventions Used in this Document.....	2
SERVICE INFORMATION	3
PRELIMINARY SETUP PROCEDURES	4
Unpack the Unit from the Carton	4
Select a Site for the Server	5
Rack Mount the Server.....	6
Check the Power Supply.....	15
General Safety Information.....	16
INSTALL THE SERVER	19
Step 1: Setup Procedures.....	19
Step 1A: Quick Start Setup Procedures	20
Step 1B: Console Setup Procedures	28
Step 1C: LCD Panel Setup Procedures	37
Step 2: Change User Name and Password, Set Self-Monitoring	43
Step 3: R3000 Configuration	46
Step 4: Client Workstation Configuration	47
Step 5: Launch the ER Client	48
CONCLUSION	50
IMPORTANT INFORMATION ABOUT USING THE ER IN THE EVALUATION MODE	51
Administrator Console, Expiration Screen	51
ER Client, ER Server Statistics Window.....	52
LED INDICATORS AND BUTTONS.....	53
SL Unit.....	53
HL Unit	54
HL and SL Units.....	56

REGULATORY SPECIFICATIONS AND DISCLAIMERS..... 57
 Declaration of the Manufacturer or Importer 57

APPENDIX: SCSI CONNECTED STORAGE DEVICE..... 60
 Preliminary Setup Procedures 60
 Install the Unit..... 65
 Physical Components 67

INDEX 70

ER ENTERPRISE REPORTER INTRODUCTION

Thank you for choosing to evaluate the 8e6 Technologies ER Enterprise Reporter. The ER is designed to readily obtain information about end users' Internet activity via log files (text files containing Web access data) from a source device such as the 8e6 R3000 Enterprise Filter.

Both SL and HL server models include RAID technology for fault tolerance and high performance.

The ER is comprised of the ER server and client application. Once the ER server is configured and log files have populated the database, an administrator can use the ER client reporting application to virtually generate an unlimited number of queries and reports from data in the database. This data shows which end user is accessing which site, the duration of each site visit, and the frequency of these visits, and can help administrators identify Internet usage abusers, develop policies, and target sites to be filtered, in order to maximize bandwidth utilization and productivity. The client gives the administrator the ability to interrogate massive datasets through flexible drill-down technology, until the desired view is obtained, and then memorize and save the view to a user-defined report menu for repetitive, scheduled execution and distribution.

About this Document

This document is divided into the following sections:

- **Introduction** - This section is comprised of an overview of the ER product and how to use this document
- **Service Information** - This section provides 8e6 Technologies contact information
- **Preliminary Setup Procedures** - This section includes instructions on how to physically set up the ER in your network environment
- **Install the Server** - This section explains how to configure the ER for reporting
- **Conclusion** - This section indicates that the quick start steps have been completed
- **Evaluation Mode** - This section gives information on using the ER in the evaluation mode
- **LED Indicators and Buttons** - This section explains how to read LED indicators and use LED buttons for troubleshooting the unit
- **Regulatory Specifications and Disclaimers** - This section cites safety and emissions compliance information for the ER models referenced in this document
- **Appendix** - The appendix explains how to set up the optional NAS (SCSI Connected Storage Device or “SAN”) unit
- **Index** - An alphabetized list of some topics included in this document

Conventions Used in this Document

The following icons are used throughout this document to call attention to important information pertaining to handling, operation, and maintenance of the server; safety and preservation of the equipment, and personal safety:



NOTE: The “note” icon is followed by additional information to be considered.



WARNING: The “warning” icon is followed by information alerting you to a potential situation that may cause damage to property or equipment.



CAUTION: The “caution” icon is followed by information warning you that a situation has the potential to cause bodily harm or death.

SERVICE INFORMATION

The user should not attempt any maintenance or service on the unit beyond the procedures outlined in this document.

Any initial hardware setup problem that cannot be resolved at your internal organization should be referred to an 8e6 Technologies solutions engineer or technical support representative.

8e6 Corporate Headquarters (USA)

Local : 714.282.6111
Domestic US : 1.888.786.7999
International : +1.714.282.6111

8e6 Taiwan

Taipei Local : 2397-0300
Domestic Taiwan : 02-2397-0300
International : 886-2-2397-0300

Procedures

When calling 8e6 Technologies regarding a problem, please provide the representative the following information:

- Your contact information.
- Serial number or original order number.
- Description of the problem.
- Network environment in which the unit is used.
- State of the unit before the problem occurred.
- Frequency and repeatability of the problem.
- Can the product continue to operate with this problem?
- Can you identify anything that may have caused the problem?

PRELIMINARY SETUP PROCEDURES

Unpack the Unit from the Carton

Inspect the packaging container for evidence of mishandling during transit. If the packaging container is damaged, photograph it for reference.

Carefully unpack the unit from the carton and verify that all accessories are included. Save all packing materials in the event that the unit needs to be returned to 8e6 Technologies.

The carton should contain the following items:

- 1 Enterprise Reporter (ER)
- 1 Bezel to be installed on the front of the chassis
- 1 AC Power Cord, 2 AC Power Cords for HL servers
- Serial Port Cable
- 1 CAT-5E Crossover Cable
- Rack Mount Brackets (2)
- 1 End User License Agreement (EULA)
- 1 envelope containing a CD-ROM with PDFs of the ER user guides. The latest versions of our user guides can be obtained at <http://www.8e6.com/docs/er4server.pdf> (administrator), http://www.8e6.com/docs/er4_wclient.pdf (Web client).



NOTES: A coupler is included in the carton if a three-foot CAT-5E crossover cable is packaged with your unit instead of a 14-foot CAT-5E crossover cable. An additional five-foot CAT-5E crossover cable also is included in the carton if you have purchased the optional NAS (SCSI Connected Storage Device or “SAN”) unit. For HL and SL servers, 1 bezel to be installed on the front of the chassis also is included, as well as 1 spare parts kit. For HL servers, this kit contains a hard drive and power supply. For SL servers, this kit contains a hard drive.

Inspect the server and accessories for damage. If the contents appear damaged, file a damage claim with the carrier immediately.



WARNING: To avoid danger of suffocation, do not leave plastic bags used for packaging the server or any of its components in places where children or infants may play with them.

Select a Site for the Server

The server operates reliably within normal office environmental limits. Select a site that meets the following criteria:

- Clean and relatively free of excess dust.
- Well-ventilated and away from sources of heat, with the ventilating openings on the server kept free of obstructions.
- Away from sources of vibration or physical shock.
- Isolated from strong electromagnetic fields and noise caused by electrical devices such as elevators, copy machines, air conditioners, large fans, large electric motors, radio and TV transmitters, and high-frequency security devices.
- Access space provided so the server power cord can be unplugged from the power supply or the wall outlet—this is the only way to remove the AC power cord from the server.
- Clearance provided for cooling and airflow: Approximately 30 inches (76.2 cm) in the back and 25 inches (63.5 cm) in the front.
- Located near a properly earthed, grounded, power outlet.

Rack Mount the Server

Rack Setup Precautions

 **Warning:**

Before rack mounting the server, the physical environment should be set up to safely accommodate the server. Be sure that:

- The weight of all units in the rack is evenly distributed. Mounting of the equipment in the rack should be such that a hazardous condition is not achieved due to uneven mechanical loading.
- The rack will not tip over when the server is mounted, even when the unit is fully extended from the rack.
- For a single rack installation, stabilizers are attached to the rack.
- For multiple rack installations, racks are coupled together.
- Reliable earthing of rack-mounted equipment is maintained at all times. Particular attention should be given to supply connections other than direct connections to the branch circuit (e.g. use of power strips).
- A power cord will be long enough to fit into the server when properly mounted in the rack and will be able to supply power to the unit.
- The connection of the server to the power supply will not overload any circuits. Consideration should be given to the connection of the equipment to the supply circuit and the effect that overloading of the circuits might have on overcurrent protection and supply wiring. Appropriate consideration of equipment nameplate ratings should be used when addressing this concern.
- The server is only connected to a properly rated supply circuit. Reliable earthing (grounding) of rack-mounted equipment should be maintained.
- The air flow through the server's fan or vents is not restricted. Installation of the equipment in a rack should be such that the amount of air flow required for safe operation of the equipment is not compromised.
- The maximum operating ambient temperature does not exceed 104°F (40°C). If installed in a closed or multi-unit rack assembly, the operating ambient temperature of the rack environment may be greater than room ambient. Therefore, consideration should be given to installing the equipment in an environment compatible with the maximum ambient temperature (T_{ma}) specified by the manufacturer.

 **WARNING:** *Extend only one component at a time. Extending two or more components simultaneously may cause the rack to become unstable.*

Rack Mount Instructions for HL Servers

Rack Setup Suggestions

- Determine the placement of each component in the rack before you install the rails.
- Install the heaviest server components on the bottom of the rack first, and then work up.

Identify the Sections of the Rack Rails

You should have received two rack rail assemblies with the 8e6 server unit. Each of these assemblies consists of two sections: An inner fixed chassis rail that secures to the unit (A), and an outer fixed rack rail that secures directly to the rack itself (B). Two pairs of short brackets to be used on the front side of the outer rails are also included.

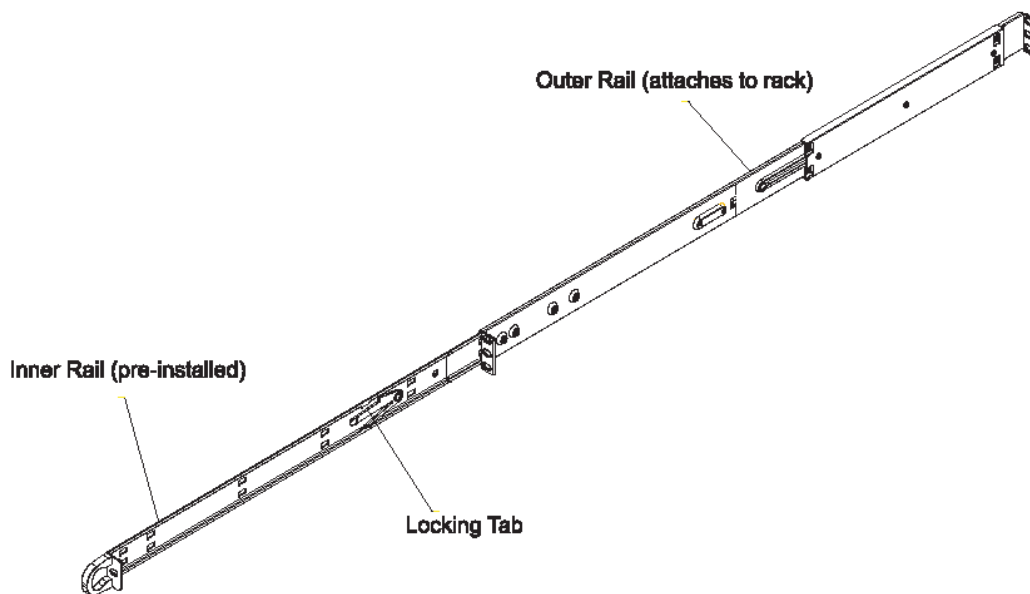

Install the Inner Rails

Both the left and right side inner rails have been pre-attached to the chassis. Proceed to the next step.

Install the Outer Rails

Begin by measuring the distance from the front rail to the rear rail of the rack. Attach a short bracket to the front side of the right outer rail and a long bracket to the rear side of the right outer rail. Adjust both the short and long brackets to the proper distance so that the rail can fit snugly into the rack. Secure the short bracket to the front side of the outer rail with two M4 screws and the long bracket to the rear side of the outer rail with three M4 screws. Repeat these steps for the left outer rail.

Locking Tabs: Both chassis rails have a locking tab, which serves two functions. The first is to lock the server into place when installed and pushed fully into the rack, which is its normal position. Secondly, these tabs also lock the server in place when fully extended from the rack. This prevents the server from coming completely out of the rack when you pull it out for servicing.

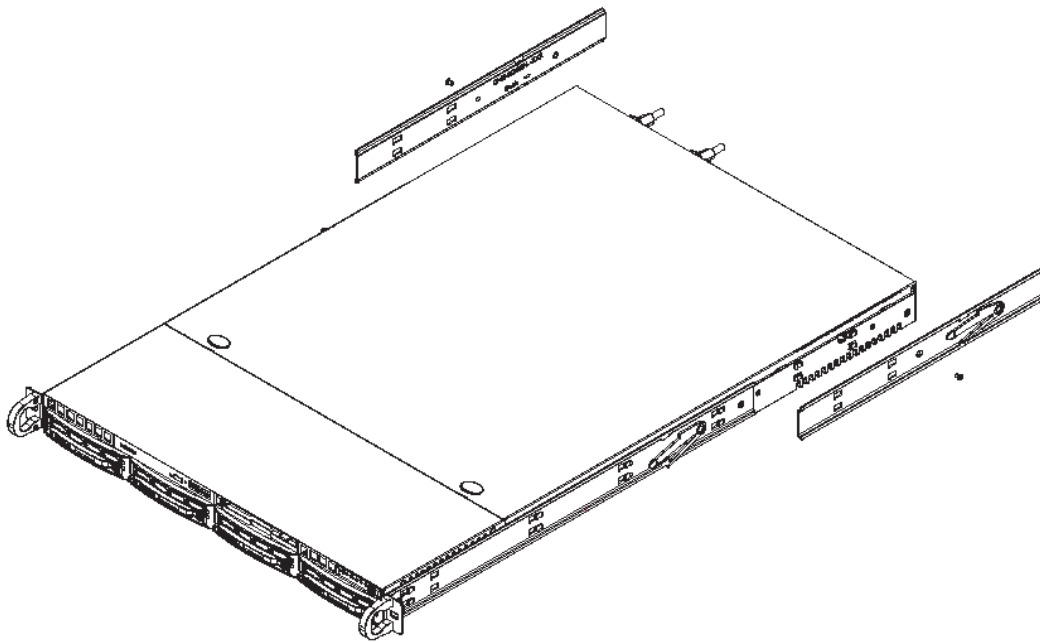

Install the Server into the Rack

You should now have rails attached to both the chassis and the rack unit. The next step is to install the server chassis into the rack. Do this by lining up the rear of the chassis rails with the front of the rack rails. Slide the chassis rails into the rack rails, keeping the pressure even on both sides (you may have to depress the locking tabs when inserting).

When the server has been pushed completely into the rack, you should hear the locking tabs “click.”

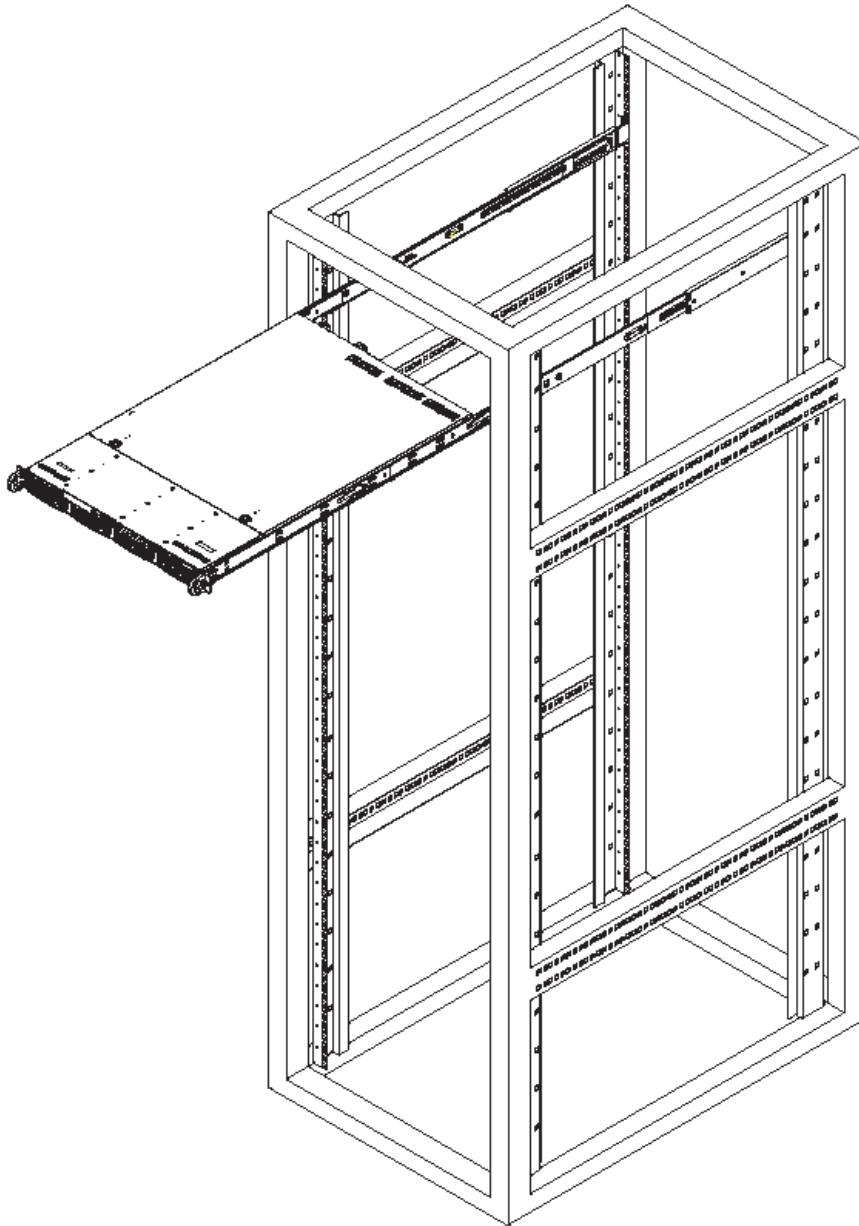

Install the Server into a Telco Rack

If you are installing the 8e6 server unit into a Telco type rack, use two L-shaped brackets on either side of the chassis (four total). First, determine how far forward the server will extend out the front of the rack. A larger chassis should be positioned to balance the weight between front and back. If a bezel is included on your server, remove it. Then attach the two front brackets to each side of the chassis, then the two rear brackets positioned with just enough space to accommodate the width of the telco rack. Finish by sliding the chassis into the rack and tightening the brackets to the rack.

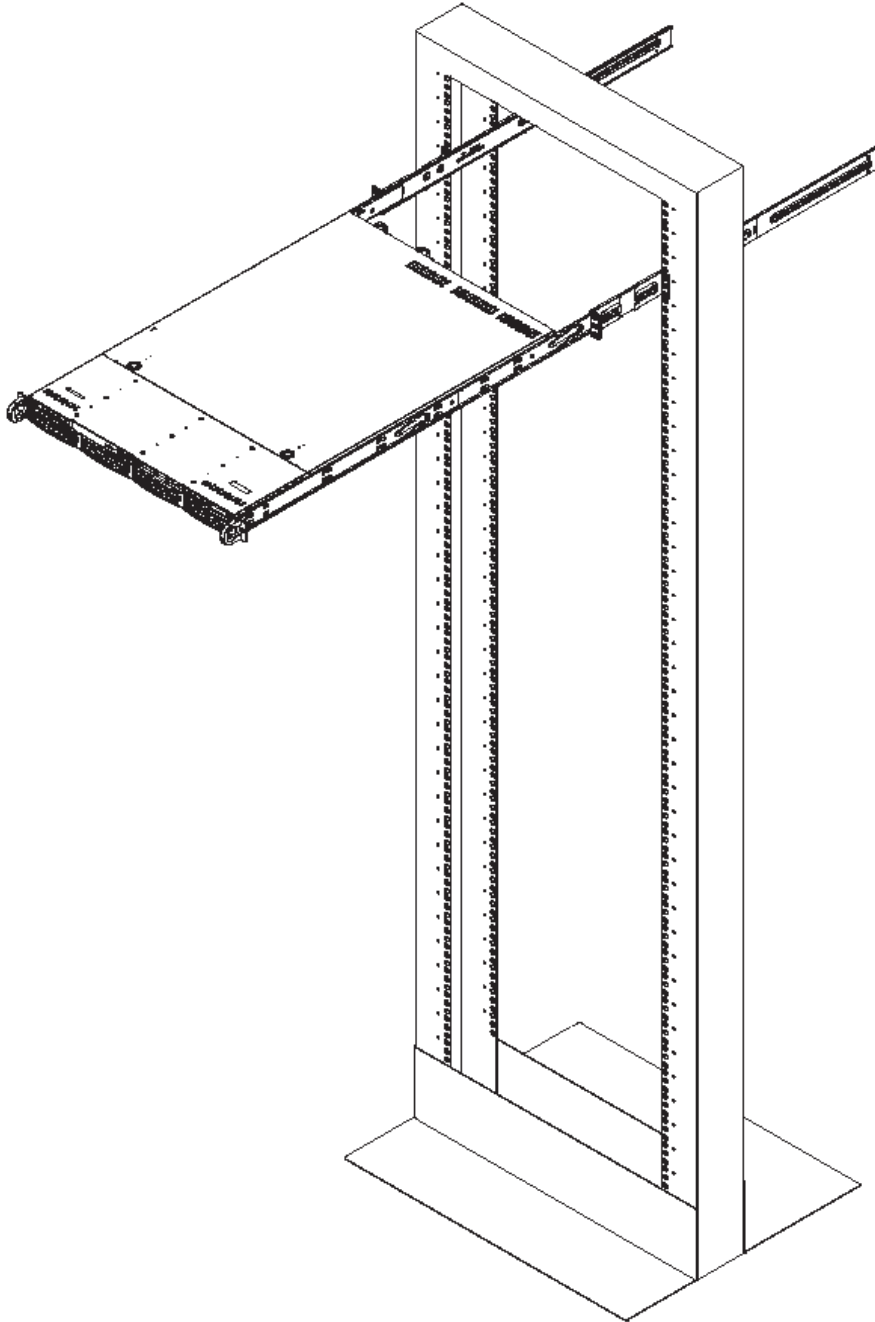

Rack Mount Instructions for SL Servers

Rack Setup Suggestions

- Determine the placement of each component in the rack before you install the rails.
- Install the heaviest server components on the bottom of the rack first, and then work up.

Install the Inner Slides

1. Locate the right inner slide, (the slide that will be used on the right side of chassis when facing the front panel of the chassis).
2. Align the four (4) square holes on the right inner slide against the hooks on the right side of the chassis as show below on the left.
3. Securely attach the slide to the chassis with two M4 flat head screws and repeat the steps 1-3 to install the left inner slide to the left side of the chassis.

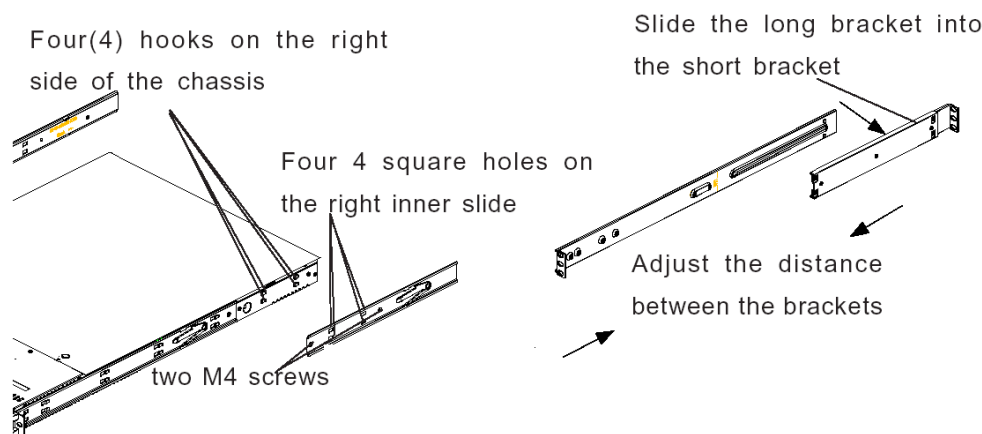

Install the Outer Slides

1. Measure the distance from the front rail of the rack to the rear rail of the rack.
2. Attach a short bracket to the rear side of the right outer slide, and a long bracket to the front side of the right outer slide as shown above on the right.
3. Adjust the short and long brackets to the proper distance so that the chassis can snugly fit into the rack.
4. Secure the slides to the cabinet with screws.
5. Repeat steps 1-4 for the left outer slide.

Install the Slide Assemblies to the Rack

1. After you have installed the short and long brackets to the outer slides, you are ready to install the whole slide assemblies (outer slides with short and long brackets attached) to the rack. (See the previous page.)
2. Use M5 screws and washers to secure the slide assemblies into the rack as shown below:

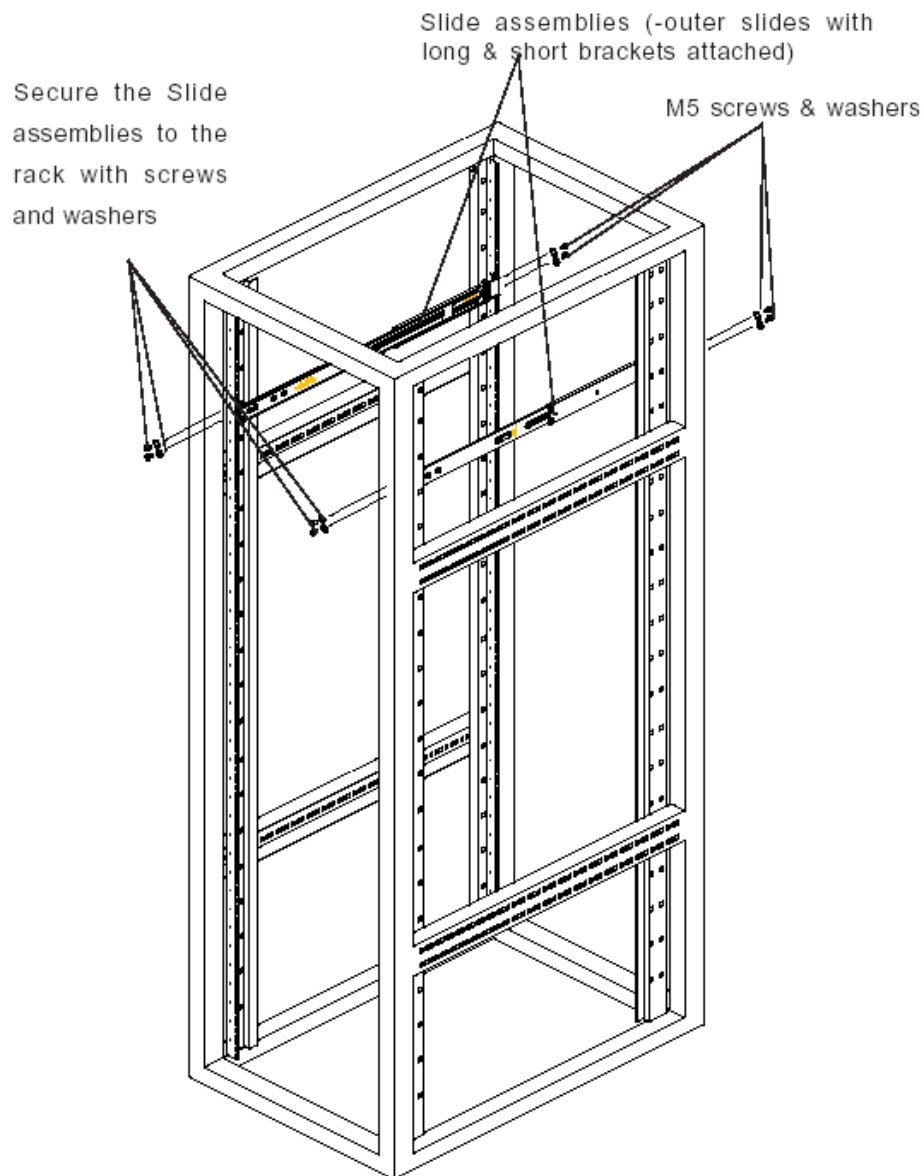

Install the Chassis into the Rack

1. Push the inner slides, which are attached to the chassis, into the grooves of the outer slide assemblies that are installed in the rack as shown below:

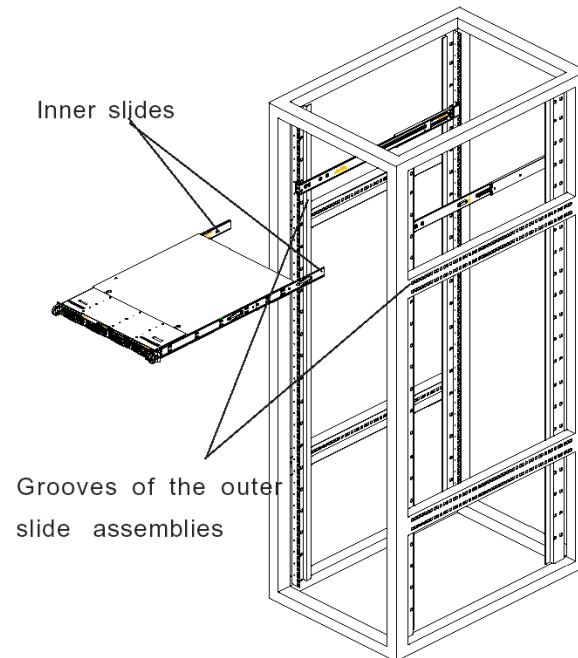

2. Push the chassis all the way to the back of the outer slide assemblies as shown below:

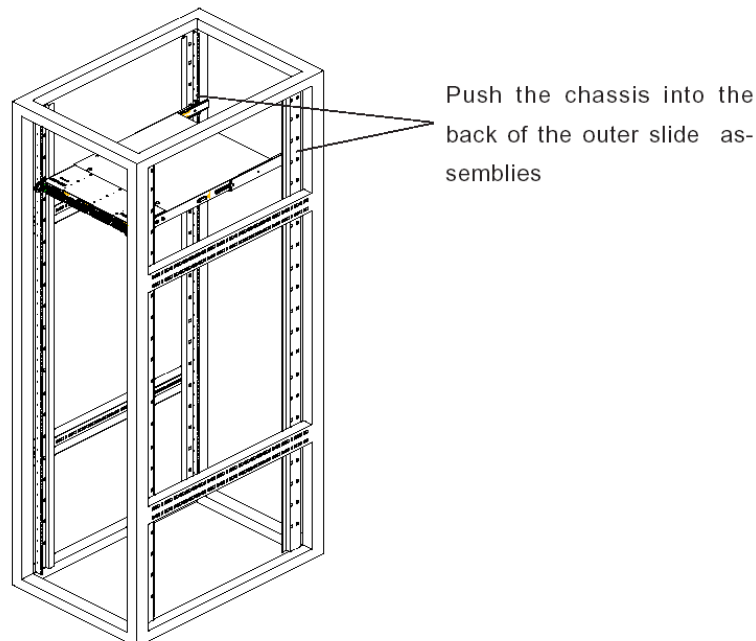

Install the SL or HL Server Bezel

After rack mounting an SL or HL server, the bezel should be installed on the front end of the chassis.

 **NOTE:** This portion of the installation process requires you to unpack the bezel. The bezel has been packaged separately from the unit to prevent damage during shipping.

- A. Hold the bezel upright and facing towards you (Fig. 1).



Fig. 1 - Front of bezel

- B. Note that each end of the bezel contains two raised bumps (Fig. 2).



Fig. 2 - Bumps on right end of bezel



Fig. 3 - Grooves in right U-shaped handle

- C. Align these bumps along the two parallel grooves inside each U-shaped aluminum chassis handle affixed to the front end of the chassis rail (Fig. 3).
- D. Push the bezel towards the front of the chassis, inserting the USB B-type plug on the back of the bezel (Fig. 4) into the USB port on the chassis.

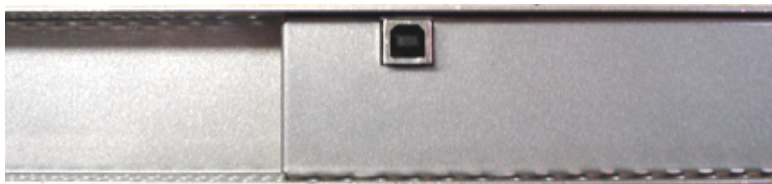

Fig. 4 - Section of back of bezel with USB B-type plug

Check the Power Supply

This server is equipped with a universal power supply that handles 100-240 V, 50/60 Hz. A standard power cord interface (IEC 950) facilitates power plugs that are suitable for most European, North American, and Pacific Rim countries.

Power Supply Precautions

 **Warning:**

- Use a regulating uninterruptible power supply (UPS) to protect the server from power surges, voltage spikes and to keep the server operating in case of a power failure.
- In geographic regions that are susceptible to electrical storms, 8e6 highly recommends plugging the AC power cord for the server into a surge suppressor.
- Use appropriately rated extension cords or power strips only.
- Allow power supply units to cool before touching them.

General Safety Information

Server Operation and Maintenance Precautions

 **Warning:**

Observe the following safety precautions during server operation and maintenance:

 **WARNING:** *If the server is used in a manner not specified by the manufacturer, the protection provided by the server may be impaired.*

 **WARNING:** *8e6 Technologies is not responsible for regulatory compliance of any server that has been modified. Altering the server's enclosure in any way other than the installation operations specified in this document may invalidate the server's safety certifications.*

 **CAUTION:** *Never pile books, papers, or other objects on the chassis, drop it, or subject it to pressure in any other way. The internal circuits can be damaged, and the battery may be crushed or punctured. Besides irreparable damage to the unit, the result could be dangerous heat and even fire.*

 **CAUTION:** *There are no user-serviceable components inside the chassis. The chassis should only be opened by qualified service personnel. Never disassemble, tamper with, or attempt to repair the server. Doing so may cause smoke, fire, electrical shock, serious physical injury, or death.*

 **WARNING:** *In HL servers, multiple sources of supply exist. Be sure to disconnect all sources before servicing.*

- Do not insert objects through openings in the chassis. Doing so could result in a short circuit that might cause a fire or an electrical shock.
- Do not operate the server in an explosive atmosphere, in the presence of flammable gases.
- To ensure proper cooling, always operate the server with its covers in place. Do not block any openings on the chassis. Do not place the server near a heater.
- Always exit the software application properly before turning off the server to ensure data integrity.

- Do not expose the server to rain or use near water. If liquids of any kind should leak into the chassis, power down the server, unplug it, and contact 8e6 Technologies technical support.
- Disconnect power from the server before cleaning the unit. Do not use liquid or aerosol cleaners.

AC Power Cord and Cable Precautions

Warning:

- The AC power cord for the server must be plugged into a grounded, power outlet.
- Do not modify or use a supplied AC power cord if it is not the exact type required in the region where the server will be installed and used. Replace the cord with the correct type.
- Route the AC power cord and cables away from moving parts and foot traffic.
- Do not allow anything to rest on the AC power cord and cables.
- Never use the server if the AC power cord has been damaged.
- Always unplug the AC power cord before removing the unit for servicing.

Electrical Safety Precautions

Warning:

Heed the following safety precautions to protect yourself from harm and the server from damage:

 **CAUTION:** *Dangerous voltages associated with the 100-240 V AC power supply are present inside the unit. To avoid injury or electrical shock, do not touch exposed connections or components while the power is on.*

- To prevent damage to the server, read the information in this document for selection of the proper input voltage.
- Do not wear rings or wristwatches when troubleshooting electrical circuits.
- To avoid fire hazard, use only the specified fuse(s) with the correct type number, voltage, and current ratings. Only qualified service personnel should replace fuses.
- Qualified service personnel should be properly grounded when servicing the unit.
- Qualified service personnel should perform a safety check after any service is performed.

Motherboard Battery Precautions

 **Caution:**

The battery on the motherboard should not be replaced without following instructions provided by the manufacturer. Only qualified service personnel should replace batteries.

The battery contains energy and, as with all batteries, a malfunction can cause heat, smoke, or fire, release toxic materials, or cause burns. Do not disassemble, puncture, drop, crush, bend, deform, submerge or modify the battery. Do not incinerate or expose to heat above 140°F (60°C).

There is a danger of explosion if the battery on the motherboard is installed upside down, which will reverse its polarities.

CAUTION: DANGER OF EXPLOSION IF BATTERY IS INCORRECTLY REPLACED. REPLACE ONLY WITH THE SAME OR EQUIVALENT TYPE RECOMMENDED BY THE MANUFACTURER. DISPOSE OF THE USED BATTERIES ACCORDING TO THE MANUFACTURER'S INSTRUCTIONS.

ATTENTION: IL Y A DANGER D'EXPLOSION S'IL Y A REMPLACEMENT INCORRECT DE LA BATTERIE, REMPLACER UNIQUEMENT AVEC UNE BATTERIE DU MÊME TYPE OU D'UN TYPE ÉQUIVALENT RECOMMANDÉ PAR LE CONSTRUCTEUR. METTRE AU REBUT LES BATTERIES USAGÉES CONFORMÈMENT AUX INSTRUCTIONS DU FABRICANT.

 **WARNING:** *Users in Member States should consult Article 20 of Directive 2006/66/EC of the European Parliament and of the Council before disposing the motherboard battery.*

INSTALL THE SERVER

Step 1: Setup Procedures

This step requires you to link the workstation to the ER. You have the option of using the text-based Quick Start setup procedures described in Step 1A, the Administrator console setup procedures described in Step 1B, or the LCD panel setup procedures described in Step 1C.

Quick Start Setup Requirements

The following hardware can be used for the Quick Start setup procedures:

- ER with AC power cord
- either one of two options:
 - PC monitor with AC power cord and keyboard, or
 - PC laptop computer with HyperTerminal and serial port cable (and USB DB9 serial adapter, if there is no serial port on your laptop)

Go to Step 1A to execute Quick Start Setup Procedures.

Administrator Console Setup Requirements

The following hardware is required for the Administrator console setup procedures:

- ER with AC power cord
- CAT-5E crossover cable
- PC laptop computer, or PC monitor with AC power cord and keyboard

Go to Step 1B to execute Console Setup Procedures.

LCD Panel Setup Requirements

The following hardware is required for LCD panel setup procedures:

- ER with AC power cord(s)
- Bezel with LCD panel mounted on chassis front

Go to Step 1C to execute LCD Panel Setup Procedures.

Step 1A: Quick Start Setup Procedures

Storage Device Setup (for Attached Storage Units)

If you have a NAS (SCSI Connected Storage Device or “SAN”) that will be used with the ER, you will need to connect it to the ER at this point. Refer to the Appendix at the end of this document for instructions on how to connect the SCSI Connected Storage Device.

Link the Workstation to the ER

Monitor and Keyboard Setup

- A. Connect the PC monitor and keyboard cables to the rear of the chassis.
- B. Turn on the PC monitor.
- C. Power on the ER by dropping down the face plate and pressing the large button at the right of the front panel (see Fig. 3 for an SL unit, and Fig. 4 for an HL unit).

Once the ER is powered up, proceed to the Login screen instructions.

Serial Console Setup

- A. Using the serial port cable (and USB DB9 serial adapter, if necessary), connect the laptop to the rear of the chassis (see Fig. 1 for an SL unit, and Fig. 2 for an HL unit).
- B. Power on the laptop.
- C. Power on the ER by dropping down the face plate and pressing the large button at the right of the front panel (see Fig. 3 for an SL unit, and Fig. 4 for an HL unit).



Fig. 1 - Portion of SL chassis rear

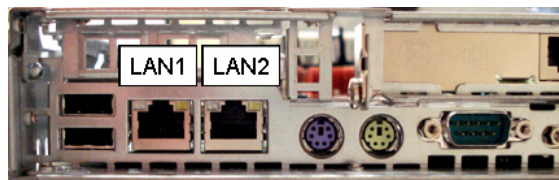

Fig. 2 - Portion of HL chassis rear

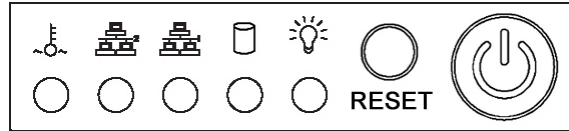

Fig. 3 - Diagram of SL chassis front panel, power button at far right

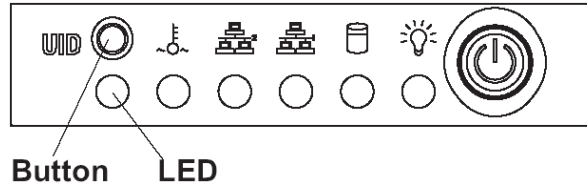

Fig. 4 - Diagram of HL chassis front panel, power button at far right

Once the ER is powered up, proceed to the instructions for HyperTerminal Setup Procedures.

HyperTerminal Setup Procedures

If using a serial console, follow these procedures to create a HyperTerminal session.

- A. Launch HyperTerminal by going to Start > Programs > Accessories > Communications > HyperTerminal:

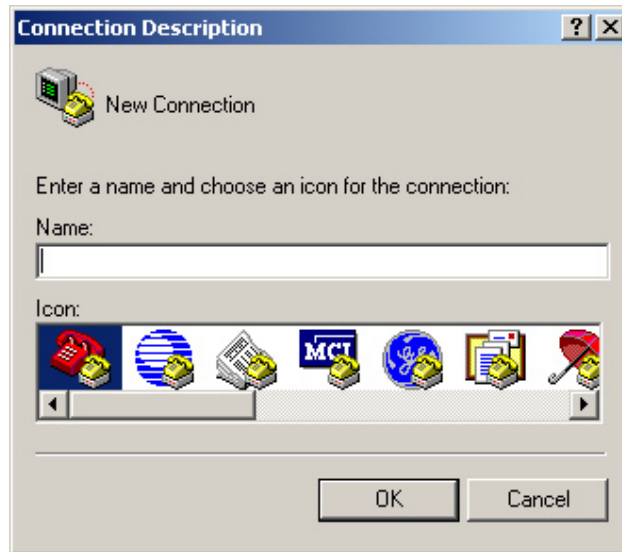

- B. In the Connection Description dialog box, enter any session **Name**, and then click **OK** to open the Connect To dialog box:



- C. At the **Connect using** field, select the COM port assigned to the serial port on the laptop (probably “COM1”), and then click **OK** to open the Properties dialog box, displaying the Port Settings tab:

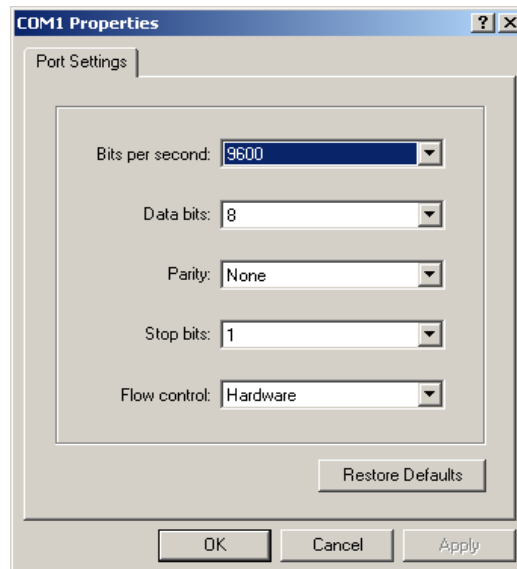

- D. Specify the following session settings:

- Bits per second: 9600
- Data bits: 8
- Parity: None
- Stop bits: 1
- Flow control: Hardware

- E. Click **OK** to connect to the HyperTerminal session:

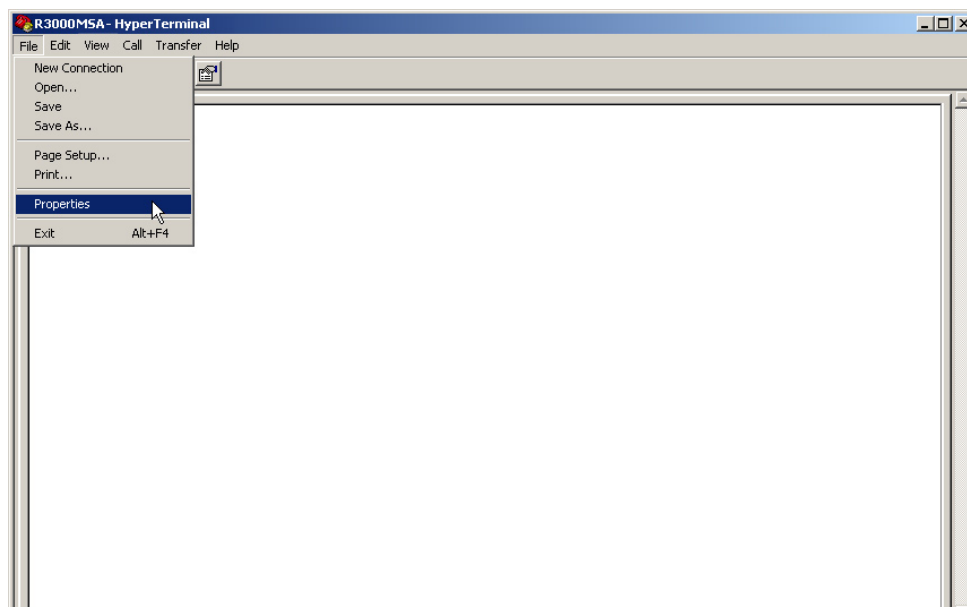

- F. In the HyperTerminal session window, go to File > Properties to open the Properties dialog box, displaying the Connect To and Settings tabs:

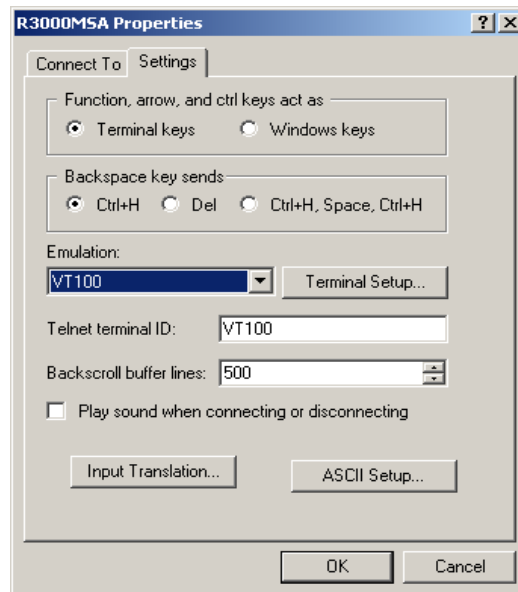

- G. Click the Settings tab, and at the **Emulation** menu select "VT100".
- H. Click **OK** to close the dialog box, and to go to the login screen.

 **NOTE:** If using a HyperTerminal session, the login screen will display with black text on a white background.

Login screen

The login screen displays after powering on the ER unit using a monitor and keyboard, or after creating a HyperTerminal session.



NOTE: If the screensaver currently displays on your screen, press the **Enter** key to display the login screen.

- A. At the **login** prompt, type in **menu**.
- B. Press the **Enter** key to display the Password prompt.
- C. At the **Password** prompt, type in the following: **#s3tup#r3k**
- D. Press **Enter** to display the Quick Start menu screen.

Quick Start menu screen

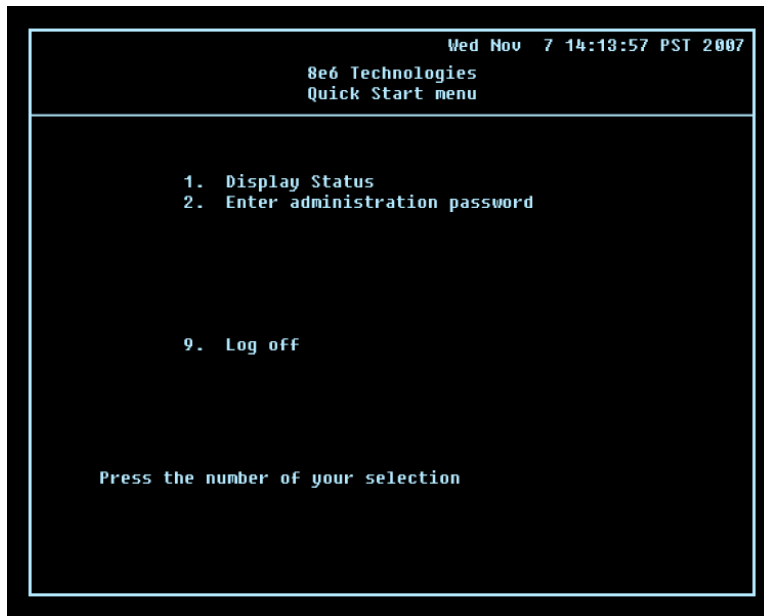

- A. At the **Press the number of your selection** prompt, press **2** to select the Quick Start setup process.
- B. At the login prompt, re-enter your password: **#s3tup#r3k**
- C. Press **Enter** to display the administration menu where you can begin using the Quick Start setup procedures.

Quick Start menu: administration menu

```

Wed Nov  7 14:15:03 PST 2007
8e6 Technologies
Quick Start menu

1. Display Status
2. Quick Start setup

3. Configure network interface LAN1

4. Configure default gateway
5. Configure DNS servers
6. Configure host name
7. Time Zone regional setting
A. Reset system to factory defaults
B. Reboot system
C. Change Quick Start password
D. Reset admin console account

X. Exit administration menu

Press the number of your selection

```

- A. At the **Press the number of your selection** prompt, press **2** to select the “Quick Start Setup” process.

The Quick Start menu takes you to the following configuration screens to make entries:

- Configure network interface LAN1
- Configure default gateway
- Configure DNS servers
- Configure host name
- Time Zone regional setting

 **NOTE:** See the *Network screens for Network Settings, and Regional Setting in Step 1B* for content included in the Quick Start setup screens.

- B. After making all entries using the Quick Start setup procedures, press **X** to return to the Quick Start menu screen. Or, to verify the status of the ER and review the entries you made using the Quick Start setup, press **1** to view the System Status screen.

 **NOTE:** Changing your password using option C, “Change Quick Start password”, will change the password for the console menu but not the ER console login screen. Option A, “Reset system to factory defaults”, should only be used by an 8e6 Technologies technical representative. Option D, “Reset admin console account”, should be used for resetting the administrator console username and password to the factory default ‘admin’/‘reporter’ and for unlocking all IP addresses currently locked.

System Status screen

```

Wed Nov  7 14:35:59 PST 2007
8e6 Technologies
System Status - updates every 10 seconds

lan1 IP = 200.10.101.76 Mask = 255.255.255.192   Active

Default gateway IP: 200.10.101.65
ER host name: ER4LOGO.com

DNS server IP address(es): 200.10.100.9 200.10.100.8
Regional timezone setting: US/Pacific

ER processing is normal
Version 4.1.20.5

Press any key to return to menu...

```

The System Status screen contains the following information:

- **Capturing Interface** specified in screen 3 (Configure network interface LAN1)
- **lan1 IP** address and netmask specified in screen 3, and current status (“Active” or “Inactive”)
- **Default gateway** IP address specified in screen 4 (Configure default gateway)
- **ER host name** specified in screen 6 (Configure host name)
- **DNS server IP address(es)** specified in screen 5 (Configure DNS servers)
- **Regional timezone setting** specified in screen 7 (Time Zone regional setting)
- Current status of the ER
- Current ER software **Version** installed



NOTE: Modifications can be made at any time by returning to the specific screen of the Quick Start procedures.

Log Off, Disconnect the Peripherals

- After completing the Quick Start setup procedures, return to the Quick Start menu screen and press **9** to log out.
- Disconnect the peripherals from the ER.

Step 1B: Console Setup Procedures

Preliminary Setup

Create a “setup workstation” using a Windows-based laptop or desktop machine with a network card and Internet Explorer 6.0 (or later). The setup workstation will be used for accessing the ER server on the network and configuring the unit.

Workstation Configurations

- A. From the desktop of the setup workstation, follow the procedures for your machine type:
 - **Windows XP** - go to Start > Control Panel. Open Network Connections. Right-click the link for LAN or High-Speed Internet and choose Properties.
 - **Windows 2000** - right-click the My Network Places icon and select Properties. Right-click the correct Local Area Connection and choose Properties.
 - **Windows NT** - right-click the Network Neighborhood icon and select Properties.
 - **Windows ME** - right-click the My Network Places icon and select Properties.
- B. Click on **Internet Protocol (TCP/IP)** to highlight it (Windows NT and ME users should select the Protocols or Configuration tab and choose **TCP/IP Protocol**).
- C. Click the **Properties** button.

 **WARNING:** Be sure to make note of the current network settings on the setup workstation as you will need to return them for further setup procedures.

- D. Choose the option **Use the following IP address** (Windows NT and ME users should choose the option **Specify an IP Address**).
- E. Type in the **IP address** of 1.2.3.3.
- F. Type in the **Subnet mask** (netmask) of 255.0.0.0 and click **OK**.
- G. Close the LAN connection properties box.

Storage Device Setup (for Attached Storage Units)

If you have a NAS (SCSI Connected Storage Device or “SAN”) that will be used with the ER, you will need to connect it to the ER at this point. Refer to the Appendix at the end of this document for instructions on how to connect the SCSI Connected Storage Device.

Link the Workstation to the ER

The procedures outlined in this sub-section require the use of the CAT-5E crossover cable.

- A. Plug one end of the CAT-5E crossover cable into the ER's **LAN 1** port.

 **NOTE:** When facing the rear of the chassis, the LAN 1 port is the port on the left.



Portion of SL chassis rear

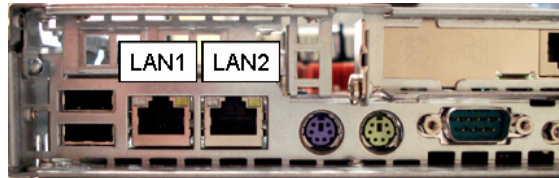

Portion of HL chassis rear

- B. Plug the other end of the CAT-5E crossover cable into the setup workstation's network card.

 **NOTE:** If a CAT-5E coupler was packaged with your unit, this coupler can be used if the crossover cable is not long enough for your setup. Plug one end of the CAT-5E crossover cable into the ER, and the other end into the coupler. Plug a standard CAT-5E cable into the other end of the coupler, and the free end of the standard CAT-5E cable into the setup workstation.

- C. Plug the ER into a power source with an appropriate rating.

 **WARNING:** It is strongly suggested you use an uninterruptible power supply.

- D. Power on the ER by lowering the bezel and pressing the large button at the right of the front panel (see diagrams below):

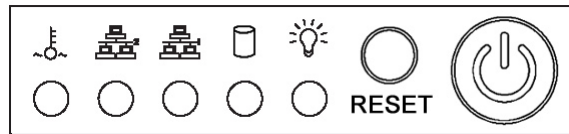
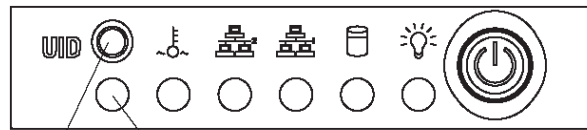

Diagram of SL chassis front panel, power button at far right



Button LED

Diagram of HL chassis front panel, power button at far right

⚠ WARNING: *The ER is an information database. If you experience a power interruption or power off the ER in any manner other than from the Web-based interface utility described in the sub-step Physically Connect the ER to the Network, you may lose data and/or damage the file system.*

The Boot Up Process

The boot-up process may take 5 - 10 minutes. When the drive light remains off for 30 seconds, the system is booted up. (See the LED Indicators and Buttons section for a description of front panel LED indicators and buttons.)

If you wish to verify that the unit has been booted up, you can perform the following test on your workstation:

1. Go to your taskbar and click Start > Run.
2. In the dialog box, type in **cmd** (type in **command** if using Windows ME).
3. Click **OK**.
4. In the cmd.exe window, type in **ping 1.2.3.4**
5. Press **Enter** on your keyboard.

If you receive a reply, the unit is up.

Network Setup

When the ER is fully booted, you can configure network settings. For this step, you will need your network administrator to provide you the host name, gateway address, and one unused IP addresses.

Access the Internet

- A. Launch Internet Explorer from the setup workstation.
- B. Type in **http://1.2.3.4:88** in the address field.
- C. Click **Go** to open the login screen of the Administrator console application:

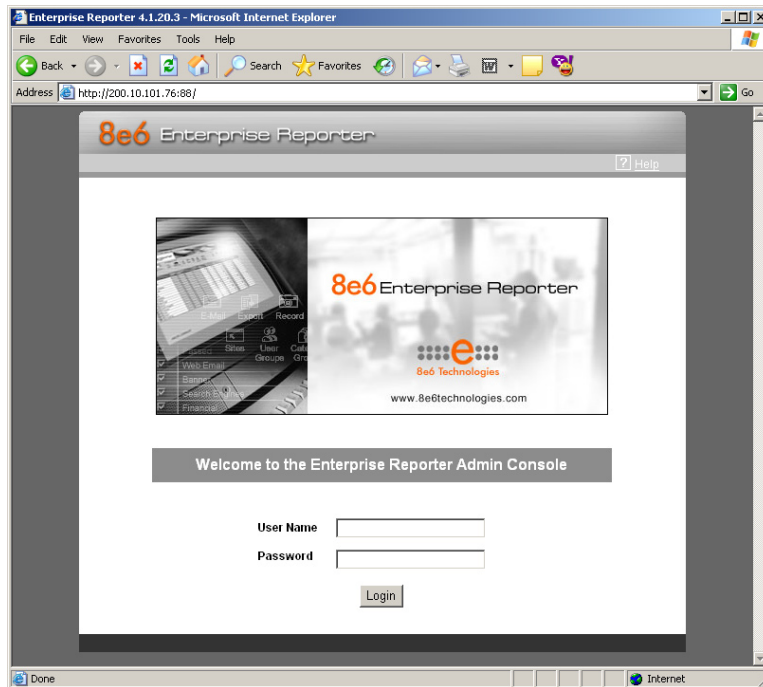

Log in to the Administrator Console

In the login screen, you need to enter the generic User Name and Password.

- A. In the **User name** field, type in **admin**.
- B. In the **Password** field, type in **reporter**.

C. Click **OK** to go to the main screen of the Administrator console:

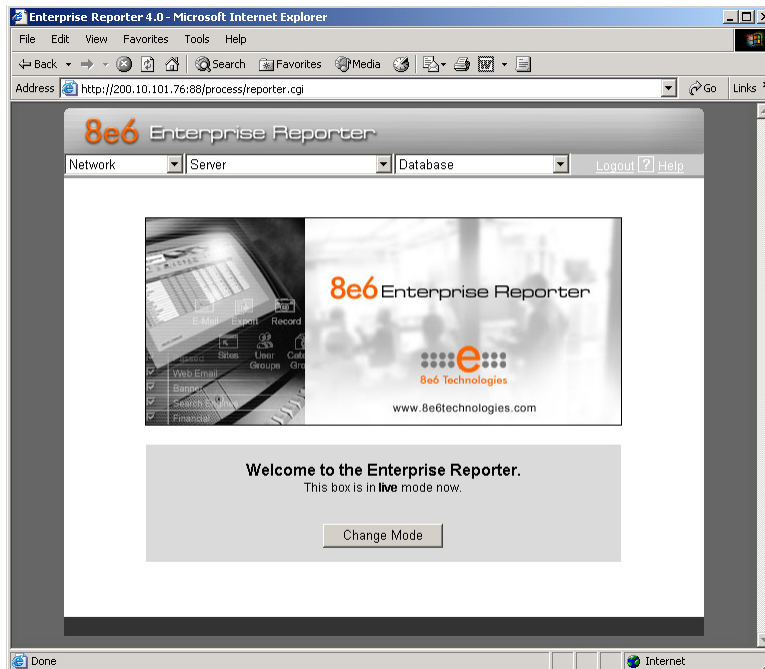

Network Settings

A. From the Network menu at the top left of the screen, choose **Network Setting** to display the Network Settings screen in which you enter LAN settings the ER will use on your network:

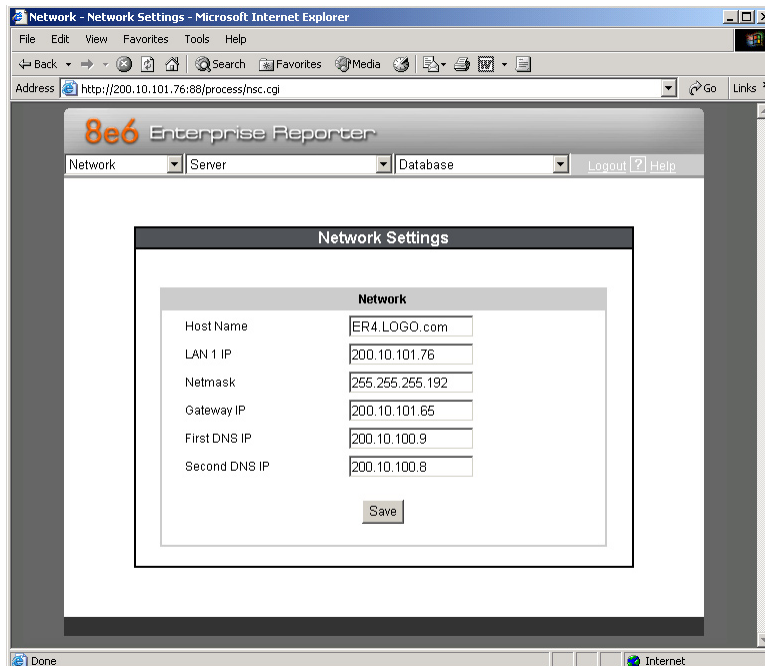

-
- B. Enter the **Host Name** that includes your domain name. For example: er.myserver.com. This must be a valid DNS entry.
 - C. Enter the **LAN 1 IP** address of the ER server. This IP address must be FTP-accessible via the Web access logging device, and via port 3306 from the client workstation that will run the reports.
 - D. Enter the **Netmask** (subnet) that will define the traffic designated for the LAN.
 - E. Enter the **Gateway IP** address for the default router or firewall that is the main gateway for the entire network segment.
 - F. Enter the **First DNS IP** address of the primary Domain Name System (name server). The server will use this IP address to identify IP addresses on the network.
 - G. Enter the **Second DNS IP** address of the fallback DNS.

 **WARNING:** *Be sure to make note of the IP addresses and host name you assigned to the ER. It is strongly suggested you document and save a copy of these entries since they are now the only way to communicate with the ER.*

- H. Click **Save**.

Regional Setting: Time Zone

- A. From the Network menu, choose **Regional Setting** to display the Regional Setting screen in which you specify the geographic region of the ER, select the language set to display in the console, and then select the Network Time Protocol (NTP) servers the ER will use for time synchronization with Internet clocks:

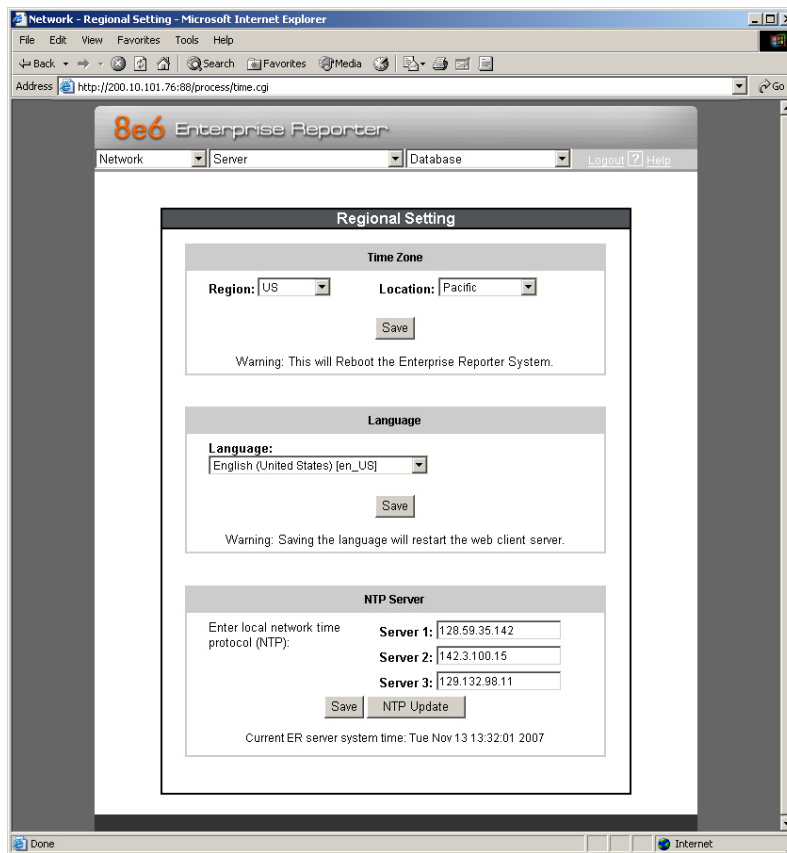

- B. At the **Region** pull-down menu, select your country from the available choices.
- C. At the **Location** pull-down menu, select the time zone for the specified region.
- D. Click **Save**.

Regional Setting: Language

- A. If necessary, select a language set from the **Language** pull-down menu to display that text in the console.
- B. Click **Save**.

Regional Setting: NTP Servers

- A. In the **Server 1** field on the Time Settings screen, enter the IP address of the primary NTP server you wish to use for clock settings on your server.
- B. In the **Server 2** field, enter the IP address of the secondary NTP server. The time from this server will be used by your server if the IP address for the primary server fails to be accessed by your server.
- C. In the **Server 3** field, enter the IP address of the tertiary NTP server. The time from this server will be used by your server if the IP addresses for the primary and secondary servers fail to be accessed by your server.
- D. Click **Save**.

Physically Connect the ER to the Network

Now that your ER network parameters are set, you can physically connect the unit to your network. This step requires a standard CAT-5E cable (*not* the CAT-5E crossover cable supplied with the ER).

 **NOTE:** *This section requires you to restart the ER. If you wish to relocate the ER before connecting it to the network, you must first shut down the server instead of restarting it. To shut down the ER, go to the Server menu, select Shut Down, and then choose Shutdown Hardware. Once the server is shut down, you must power on the ER and then log back into the Administrator console.*

WARNING:

- A. Restart the machine using the steps below. **Never** reset by using the power or reset buttons as this can corrupt the database and result in lost data.
 1. From the Server menu, select **Shut Down**.
 2. On the Shut Down screen, choose **Restart Hardware**.
 3. Click **Apply**.
 4. When the Warning screen displays, click **Restart**.
-

 **NOTE:** *From the time you click Restart Hardware, you have approximately 2 minutes to perform steps B through E while the ER goes through the Restart process.*

- B. Disconnect the crossover cable from the ER.
 - C. Plug one end of a standard CAT-5E cable into the ER's LAN 1 port.
 - D. Plug the other end of the standard CAT-5E cable into an open port on the network hub to which the Web-access logging device (R3000 or equivalent type of unit) is connected.
 - E. Wait until the Restart process has completed (indicated by the drive light staying off for 30 seconds. This process may take 5 - 10 minutes), then proceed to Step 2.
-

 **NOTE:** *To verify that the server is in the process of being restarted, you can try accessing another screen. If you cannot access another screen, the restart process is still in progress.*

Step 1C: LCD Panel Setup Procedures

The ER can be configured using the LCD panel on front of the chassis bezel. When the bezel is placed on the front of the chassis, with the USB plug inserted into the USB port, the default LCD screen displays.

To the right of the LCD screen, the keypad displays, consisting of the following keys: up arrow, down arrow, left arrow, right arrow, checkmark, and “X”.

Storage Device Setup (for Attached Storage Units)

If you have a NAS (SCSI Connected Storage Device or “SAN”) that will be used with the ER, you will need to connect it to the ER at this point. Refer to the Appendix at the end of this document for instructions on how to connect the SCSI Connected Storage Device.

LCD Menu

Press the “X” key to display the LCD Menu:



In the LCD panel, an arrow displays to the left of the currently selected menu item. Use the up or down arrow keys to navigate the menu. After making your menu selection, press the checkmark key to accept your selection.

 **NOTE:** On the LCD Menu, press “X” to toggle the display between the main menu and the following information: “Enterprise Reporter (software version number)” and “Database Status (Active, Inactive)”.

8e6 menu

When “8e6 >” is selected, the following menu items display on the screen:

- Current Patch Level
- IP / LAN1 >
- LAN 1 Link Status
- Gateway
- DNS 1 >
- DNS 2 >
- Host Name >
- Regional Setting (Time Zone, date, time)
- Reset Admin Console Password
- Reboot >
- Shutdown >



NOTE: *Navigation tips in the 8e6 menu:*

- Use the up / down arrow key to scroll up / down the menu
 - Press the checkmark key to choose the current selection
 - Press the “X” to go back to the previous screen
-

Make a selection from the menu, and press the checkmark key to go to that screen.

Current Patch Level

When the Current Patch Level option is selected, “Enterprise Reporter” and the version number of the currently installed build displays.

IP / LAN1

When the IP / LAN 1 option is selected, the IP / LAN 1 screen displays with the following menu items:

- Configure LAN 1 IP
 - Change LAN1 Netmask
- A. Choose **Configure LAN 1 IP** and press the checkmark key to go to the Configure LAN 1 IP screen.
 - B. Use the up / down keys to increase / decrease the current value, and the left / right arrow keys to navigate across the line.
 - C. Press the checkmark key to accept your entry and to return to the previous screen.
 - D. Choose **Change LAN1 Netmask** and press the checkmark key to go to the Change LAN1 Netmask screen.
 - E. Use the up / down keys to increase / decrease the current value, and the left / right arrow keys to navigate across the line.
 - F. Press the checkmark key to accept your entry and to return to the previous screen.
 - G. Press the “X” key to return to the 8e6 menu.

LAN 1 Link Status

When the LAN 1 Link Status option is selected, the LAN 1 Link Status screen displays with the following menu items:

- Change NIC Mode
 - Lan1 Status
-



NOTE: *For Lan1 Status, the current Lan1 status displays: “auto” or “Disconnected”—the latter displays if the NIC card is not connected to the network.*

-
- A. Choose **Change NIC Mode** and press the checkmark key to go to the Change NIC Mode screen with the following options:
- Modes
 - Note



NOTE: If “Note” is selected, and the right arrow key is pressed, the following message displays: “Remember to reboot the machine for these changes to take effect.”

- B. Choose **Modes**, and use the left / right arrow keys to view the available NIC mode selections.
- C. After making a selection, press the checkmark key to display the Save Changes? screen:
- Choose **Yes** to save your changes and to return to the 8e6 menu.
 - Choose **No** to return to the previous screen.

Gateway

When the Gateway option is selected, the Gateway screen displays with the Configure Gateway IP menu item.

- A. Choose **Configure Gateway IP** and press the checkmark key to go to the Configure Gateway IP screen.
- B. Use the up / down keys to increase / decrease the current value, and the left / right arrow keys to navigate across the line.
- C. Press the checkmark key to accept your entry and to return to the previous screen.
- D. Press the “X” key to return to the 8e6 menu.

DNS 1 and 2

When the DNS 1 (2) option is selected, the DNS 1 (2) screen displays with the Configure DNS IP 1 (2) menu item.

- A. Choose **Configure DNS IP 1 (2)** and press the checkmark key to go to the Configure DNS IP 1 (2) screen.
- B. Use the up / down keys to increase / decrease the current value, and the left / right arrow keys to navigate across the line.
- C. Press the checkmark key to accept your entry and to return to the previous screen.
- D. Press the “X” key to return to the 8e6 menu.

Host Name

When the Host Name option is selected, the Host Name screen displays with the Configure Hostname menu item.

- A. Choose **Configure Hostname** and press the checkmark key to go to the Configure Hostname screen.
- B. Use the arrow keys to navigate the menu. Press the right arrow key to view the alphabets in first uppercase and then lowercase, numbers from 0-9, and lastly the symbol characters.



NOTE: *Navigation tips:*

- *If the down arrow key is pressed first—instead of the right arrow key—the symbol characters display first.*
- *Press the “X” key to remove a character and move the cursor to the first position in the line.*

-
- C. Press the checkmark key to return to the previous screen.
 - D. Press the “X” key to return to the 8e6 menu.

Regional Setting (Time Zone, date, time)

When the Regional Setting (Time Zone, date, time) option is selected, the Regional Setting (Time Zone, date, time) screen displays with the Region menu item.

- A. Choose **Region**, and use the left / right arrow keys to view the available region selections.
- B. After making a selection, press the checkmark key to display the Choose a Location screen.
- C. Choose **Location**, and use the left / right arrow keys to view the available location selections.
- D. After making a selection, press the checkmark key to display the Save Changes? screen:
 - Choose **Yes** to save your changes and to return to the 8e6 menu.
 - Choose **No** to return to the previous screen.

Reset Admin Console Password

When the Reset Admin Console Password option is selected, the Reset Admin Console screen displays with a WARNING menu item.

A. Choose ***** WARNING ***** to display the message screen:

***** WARNING ***** The Admin console username/password will be reset to 'admin'/ 'reporter' and all locked IPs will be unlocked.

B. After reading the warning message, select one of two options on the screen:

- Choose **Yes, reset it now!** to reset the password and to return to the 8e6 menu.
- Choose **No, cancel reset** to return to the previous screen.

Reboot

When the Reboot option is selected, the Reboot screen displays with two menu items.

A. Choose one of two options:

- **Yes, reboot now!!!** - This selection reboots the ER.
- **No, cancel reboot** - This selection returns you to the previous screen.

B. Press the "X" key to return to the 8e6 menu.

Shutdown

When the Shutdown option is selected, the Shutdown screen displays with two menu items.

A. Choose one of two options:

- **Yes, shutdown now!!** - This selection shuts down the ER.
- **No, cancel shutdown** - This selection returns you to the previous screen.

B. Press the "X" key to return to the 8e6 menu.

LCD Options menu

When "**LCD Options >**" is selected, the following menu items display on the screen:

- Heartbeat
- Backlight
- LCD Controls >

Make a selection from the menu, and press the checkmark key to go to that screen.

Heartbeat

When the Heartbeat option is selected, the Heartbeat screen displays.

- A. Press the checkmark or right arrow key three times to view each of the three available options:
 - heartbeat feature enabled (checkbox populated with “x”)
 - heartbeat feature disabled (checkbox empty)
 - check for a heartbeat now (checkbox populated with checkmark, and blinking heartbeat symbol displayed in the line above)
- B. After making your selection, press the “X” key to return to the previous screen.

Backlight

When the Backlight option is selected, the Backlight screen displays.

- A. Press the checkmark or right arrow key three times to view each of the three available options:
 - backlight feature enabled (checkbox populated with “x” and backlight turns on)
 - backlight feature disabled (checkbox empty and backlight turns off)
 - display the backlight now (checkbox populated with checkmark, and backlight turns on)
- B. After making your selection, press the “X” key to return to the previous screen.

LCD Controls

When the LCD Controls option is selected, the LCD Controls screen displays with the following menu items: Contrast, On Brightness, Off Brightness.

- A. Choose one of the menu selections and press the checkmark key to go to that screen:
 - **Contrast** - In the Contrast screen, use the left / right arrow keys to decrease / increase the text and screen contrast.
 - **On Brightness** - In the On Brightness screen, use the left / right arrow keys to decrease / increase the brightness of a screen with a feature that is enabled.
 - **Off Brightness** - In the Off Brightness screen, use the left / right arrow keys to decrease / increase the brightness of a screen with a feature that is disabled.
- B. After making your selection, press the “X” key to return to the previous screen.

Step 2: Change User Name and Password, Set Self-Monitoring

Now that the ER is physically installed on your network and you have configured its network settings, you should be able to access the Administrator console.

Access the Internet

- A. Restore the setup workstation you used for the Network Setup to its original settings, and connect it to the network hub to create an “administrator workstation.” (You could also use another workstation already on the network that you want to designate as the administrator workstation.)
- B. Launch IE on the administrator workstation.
- C. In the address field, enter the LAN 1 IP address you assigned to the ER (Step 1A: Quick Start menu: administration menu; Step 1B: Network Setup: Network Settings, item “C”; or Step 1C: IP / LAN1). Be sure to include the port information :88 in the address field. For example, if the ER were assigned an IP address of 10.10.10.10, you would enter **http://10.10.10.10:88** in the browser’s address field.
- D. Click **Go**. You should be prompted to log into the Administrator console, giving the **User Name (*admin*)** and **Password (*reporter*)**:

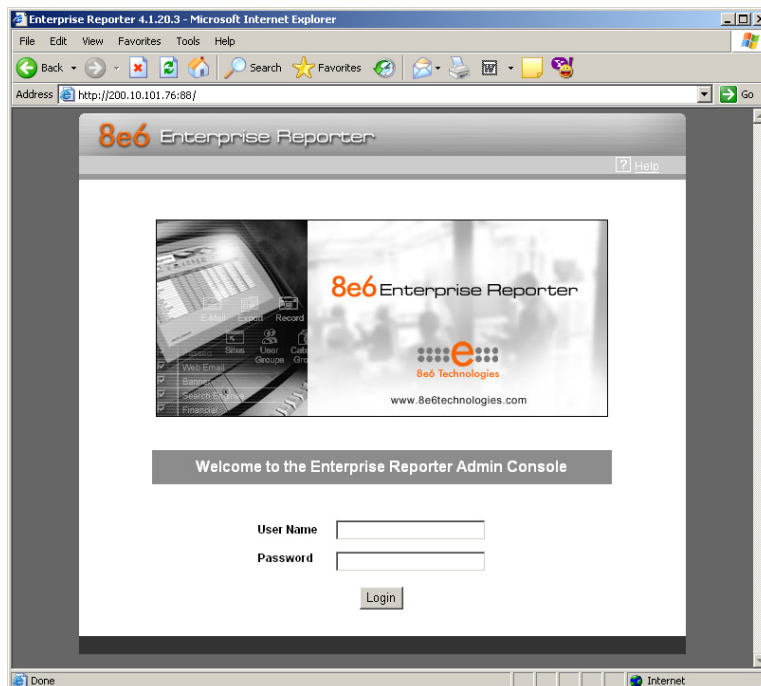

If you can access the main screen of the Administrator console, the ER setup is going as planned and you should proceed to changing your User Name and Password. If you cannot access the main screen, verify the following:

- The ER is powered on.
- Can the administrator workstation normally connect to the Internet?
- Is the administrator workstation able to ping the ER?
- Did you restart the ER after changing the network settings?
- If still unsuccessful, contact an 8e6 Technologies solutions engineer or technical support representative.

Change User Name and Password

- A. Set up a new administrator user name and password by clicking on the Network pull-down menu and choosing **Administrators** to display the Add/Edit/Delete Administrators screen:

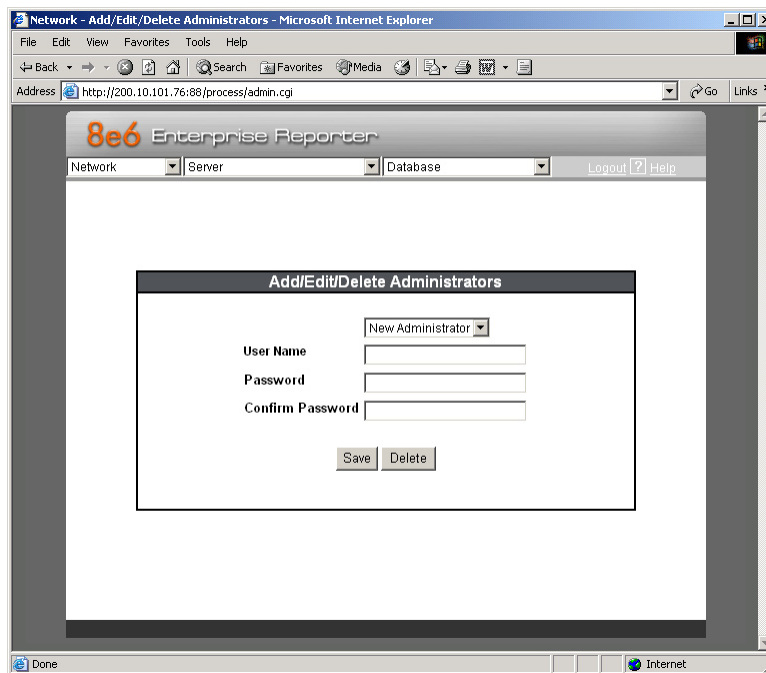

- B. Select **New Administrators** from the pull-down menu.
- C. Enter a **User Name** and **Password**.
- D. In the **Confirm Password** field, re-enter the password.
- E. Click **Save**.

Set Self-Monitoring

- A. From the Server pull-down menu, choose **Self-Monitoring** to display the Self Monitoring screen:

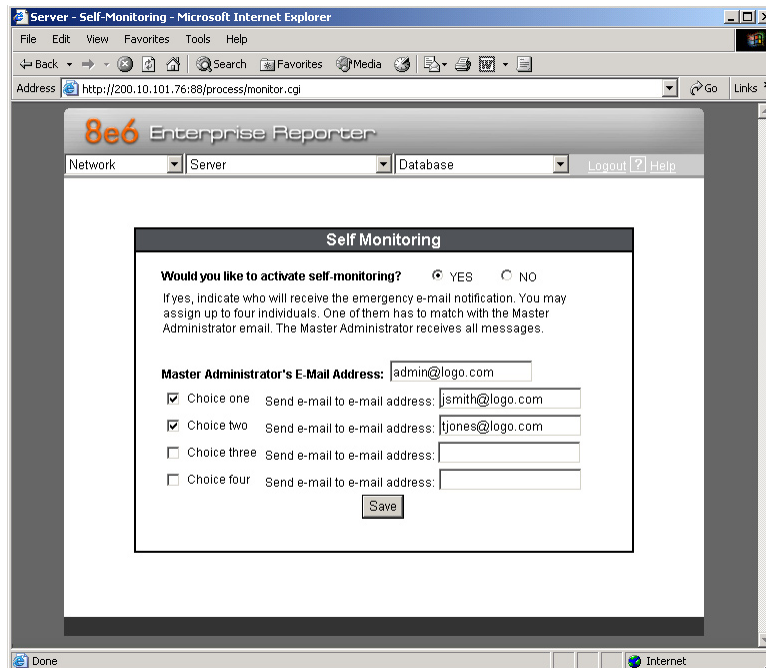

- B. Choose **YES** to activate monitoring.
- C. Enter the **Master Administrator's E-Mail Address**.
- D. Click **Choice one** and enter an e-mail address of an individual in your organization that you would like notified if the ER detects any problems when processing data. This can be the same e-mail address entered in the previous field. Enter up to four e-mail addresses.
- E. Click **Save**.

Step 3: R3000 Configuration

If you are using 8e6's R3000 for your Web-access logging device, this step can be performed any time during ER setup, but must be completed in order for the ER to receive logs from the R3000.

- A. Access the Administrator console of the R3000.
- B. Choose the **Reporting** button at the top of the screen to display the Reporting section of the Administrator console.
- C. From the navigation panel at the left of the screen, choose Report Configuration to display the Report Configuration window.
- D. Select **8e6 Enterprise Reporter**, and then click **Save**.
- E. On the 8e6 Enterprise Reporter tab, in the **Server** field, enter the LAN 1 IP address you assigned to your ER (Step 1A: Quick Start menu: administration menu; Step 1B, Network Setup: Network Settings, item "C"; or Step 1C, IP / LAN1).
- F. Click **Add** to include this IP address in the Remote Server list box. Your R3000 is now set to FTP its log files to your ER.



NOTE: *It is recommended you wait for 1 - 2 hours after the initial installation so sufficient data is available for viewing.*

You can see if log files have transferred by accessing the ER's Administrator console and choosing **Tools** from the Database pull-down menu to display the Tools screen. Choose the **File Watch Log** and click **View**. The transfer is working if you see an entry that includes the date, time, and IMPORTING: shadow.log.machine1. The transfer should occur every hour. Once you see an entry, reporting information will be available one hour after the timestamp of the import listing.

Step 4: Client Workstation Configuration

Once your ER is installed, you need to be sure the workstation that will run the client has the following minimum requirements:

- Pentium III class processor or greater
- 512 MB RAM minimum, 1 GB RAM recommended
- 1,024 x 768 display
- 2 GB free hard drive space
- Windows 2000 or XP, or Macintosh OS X operating system
- Internet Explorer Version 6.0 or later, Firefox 1.5, or Safari 2.0 Web browser
- Pop-up blocking software disabled, if installed
- High-speed connection to ER server

Go to the ER server and apply the latest software to the server, following the procedures documented in the Software Update screen sub-section of the ER Administrator User Guide. The CD-ROM supplied with the ER contains the ER Administrator User Guide, the latest version which can be downloaded from our Web site at: <http://www.8e6.com/docs/er4server.pdf>.



NOTE: The CD-ROM supplied with the ER contains the ER Web Client User Guide, the latest version which can be downloaded from our Web site at: http://www.8e6.com/docs/er4_wclient.pdf.

Step 5: Launch the ER Client

- A. Launch IE, enter **http://x.x.x.x:8080** or **https://x.x.x.x:8443** in the address window (in which “x.x.x.x” represents the IP address of the ER server), and then click **Go** to access the login window of the ER client.
- B. Enter your **Username** and **Password**, and then click **LOGIN** to access the main screen of the client:

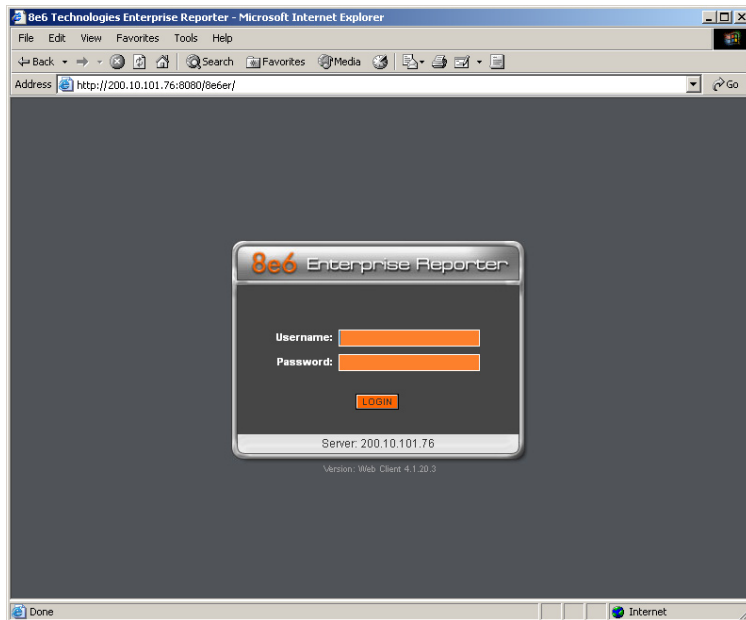

 **NOTE:** If you do not have your own Username and Password set up in the ER client, the default Username is **manager** and the default Password is **8e6ReportT**.

- C. In the navigation panel, select **Settings**, and then choose **User Permissions** from the menu:

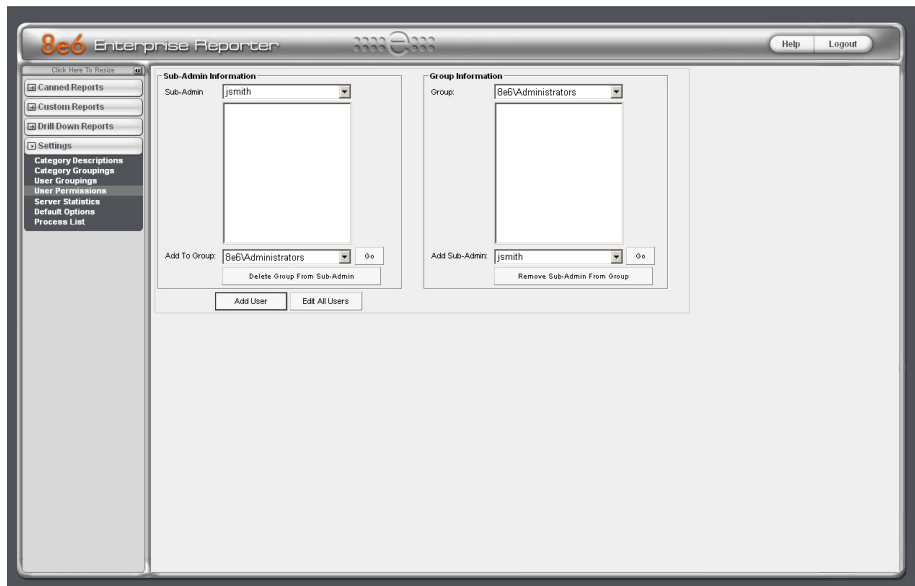

- D. Click **Add User** to open the Enter User Permissions dialog box:

- E. Enter the **Username**.
- F. Enter the **Password**, and **Confirm Password**.
- G. Select the **User Type** (“Admin” or “Sub-Admin”).
- H. Click **Save** to close the dialog box, and to add the username to the user list.
- I. Exit the client. You can now launch the client and enter the password you just set up.

 **NOTE:** For instructions on logging into the client after initial set up, refer to the *ER Web Client User Guide*.

CONCLUSION

Congratulations; you have completed the ER quick start procedures. Now that the ER server is set up on your network and the client can be accessed from your workstation, you will need to be sure the Web-access logging device you are using is sending log files to the ER database. Once the ER database is populated, the client can be used for generating reports.

Initially, you will only be able to report on IP addresses. To implement user names in ER reporting, please consult the ER Administrator User Guide.

Refer to the ER Web Client User Guide for information on generating reports.



NOTE: *If you cannot view reports, or if your specific environment is not covered in the ER Administrator User Guide, contact an 8e6 Technologies solutions engineer or technical support representative. Port 22 (SSH) and Port 3306 (SQL) must be open on your network to allow access by remote technical support.*

IMPORTANT INFORMATION ABOUT USING THE ER IN THE EVALUATION MODE

When evaluating the ER and using this product in the evaluation mode, the Expiration screen in the Administrator console and the ER Server Statistics window in the client will display and function differently than they do in the activated (standard) mode of the ER (described in the ER Administrator User Guide and ER Web Client User Guide).

Administrator Console, Expiration Screen

On the Expiration screen, the following message displays at the top of the screen: "Evaluation Mode – Max Data Storage 'X' Weeks" (in which 'X' represents the maximum number of weeks in the ER's data storage scope). In the evaluation mode, you will not be able to make adjustments to the data storage scope. Thus, the Save button is not included at the bottom of the screen. Evaluation Mode information is for viewing purposes only.

Expiration

Status as of 2007-11-13 13:04:40

EVALUATION MODE - MAX DATA STORAGE 24 WEEKS

Please click [here](#) to activate the box

Date scope for total data	2007-08-01 00:00:11 - 2007-11-13 12:59:59
Total number of week(s) stored	15 week(s)
Current live data (yearweekno/date scope)	200732 - 200745 2007-08-15 00:00:00 - 2007-11-13 12:59:59
Total number of live week(s)	13 week(s)
Current archive data (yearweekno/date scope)	200730 - 200732 2007-08-01 00:00:11 - 2007-08-14 23:59:59
Total number of archive week(s)	2 week(s)
Database disk space utilization (used database space/total database space)	13.79 % (5.78/41.94 Gbytes)
Target percentage of live data	90 %
Last 8 weeks hits/day average	130827
Estimated total week(s) of live data	24 week(s)
Estimated total week(s) of archive data	3 week(s)
Estimated number of week(s) until next expiration	0 week(s)

Change Settings

Hits/day	130827
Percentage of live data	90 %
<input type="button" value="Calculate"/>	
Estimated total week(s) of live data	<input type="text"/> week(s)
Estimated total week(s) of archive data	<input type="text"/> week(s)

ER Client, ER Server Statistics Window

In the ER Server Statistics window, the note “*Evaluation Mode Enabled” displays above the ER Activity frame. To the right of this note, the Info button displays. When this button is clicked, an alert box opens with the message: “Evaluation Mode – Max Data Storage ‘X’ Weeks” (in which ‘X’ represents the maximum number of weeks in the ER’s data storage scope). Click **OK** to close the alert box.

LED INDICATORS AND BUTTONS

SL Unit

Front LED Indicators and Buttons for Hardware Status Monitoring

LED indicators and buttons for hardware status monitoring display on the front panel, located on the right side of the SL and MSA chassis (see diagrams below).

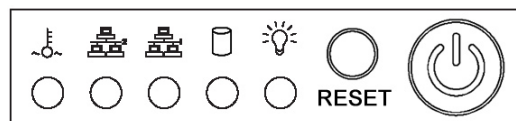

OH
NIC2
NIC1
HD
PWR

SL chassis control panel

LED Indicator Key

PWR = Power

HD = HDD Activity

NIC1 = LAN 1

NIC2 = LAN 2

OH = Overheat

LED indicators alert you to the status of a feature on the unit while buttons let you perform a function on the unit.

LED Indicator	Color	Condition	Description
Power	Green	On	System On
		Off	System Off
HDD	Amber	Blinking	HDD Activity
		Off	No HDD Activity
LAN 1 & LAN 2	Green	On	Link Connected
		Blinking	LAN Activity
		Off	Disconnected
Overheat	Red	On	System Overheated
		Off	System Normal

HL Unit

Front LED Indicators and Buttons for Hardware Status Monitoring

On an HL unit, the following control panel buttons, icons, and LED indicators for hardware status monitoring display on the right side of the front panel:

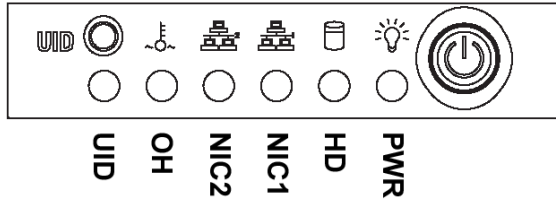

HL chassis control panel

LED Indicator Key

- PWR = Power
- HD = HDD Activity
- NIC1 = LAN 1
- NIC2 = LAN 2
- OH = Overheat
- UID = Unique IDentifier

The buttons and LED indicators for the depicted icons function as follows:

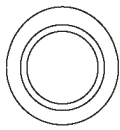

UID (button) – On an HL unit, when the UID button is pressed, a steady blue LED displays on both the front and rear of the chassis (see also Rear of Chassis). These indicators are used for easy location of the chassis in a large stack configuration. The LED remains on until the button is pressed a second time.



Overheat/Fan Fail (icon) – This LED is unlit unless the chassis is overheated. A flashing red LED indicates a fan failure. A steady red LED (on and not flashing) indicates an overheating condition, which may be caused by cables obstructing the airflow in the system or the ambient room temperature being too warm.



NIC2 (icon) – A flashing green LED indicates network activity on LAN2.



NIC1 (icon) – A flashing green LED indicates network activity on LAN1.



HDD (icon) – In addition to displaying in the control panel, this icon also displays on the front panel on each hard drive carrier. A green LED indicates hard drive activity. An unlit LED on a drive carrier may indicate a hard drive failure.



Power (icon) – The LED is unlit when the server is turned off. A steady green LED indicates power is being supplied to the unit's power supplies. (See also Rear of Chassis.) A steady amber LED—or an unlit LED—may indicate a disconnected or loose power supply cord.



Power (button) – When the power button is pressed, the main power to the server is turned on. When the power button is pressed again, the main power to the server is removed but standby power is still supplied to the server.

Rear LED Indicators for Hardware Status Monitoring

UID (LED indicator) – On the rear of the HL chassis, to the left of the power supplies, a steady blue UID LED indicator displays when the UID button on the control panel is pressed. This LED remains lit until the UID button is pressed again.

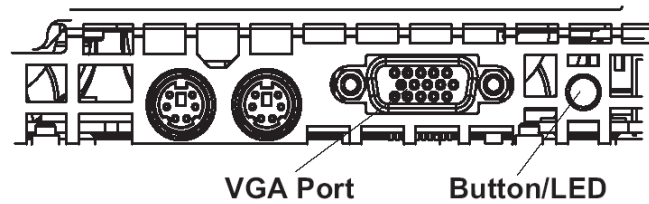

Power Supplies (LED indicators) – The power supplies are located at the right on the rear of the chassis. An LED indicator is located above each of the power plugs.

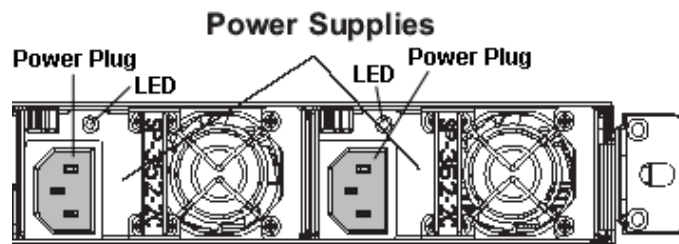

HL and SL Units

Front LED Indicators for Software and Hardware Status Monitoring

On an HL or SL unit, the following LED indicators for software and hardware status monitoring display on the left side of the front panel:

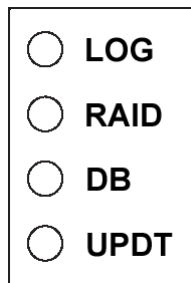

left side of the
front panel

LED Indicator Key

LOG = Log Download Status

RAID = Hard Drive Status

DB = Database Status

UPDT = Software Update Status

LED Indicator	Color	Condition	Description
LOG	Green	On	Downloading a log
		Off	No log download detected
RAID	Green	On	RAID mode enabled and running
		Off	RAID mode is inactive
		Red	On
DB	Green	On	Database is active
		Red	On
UPDT	Amber	On	Software update detected
		Off	No software update detected

REGULATORY SPECIFICATIONS AND DISCLAIMERS

Declaration of the Manufacturer or Importer

Safety Compliance

USA:	UL 60950-1 2nd ed. 2007
Europe:	Low Voltage Directive (LVD) 2006/95/EC to CB Scheme EN 60950: 2006
International:	UL/CB to IEC 60950-1:2006

Electromagnetic Compatibility (EMC)

USA:	FCC CFR 47 Part 15, Verified Class A Limit
Canada:	IC ICES-003 Class A Limit
Europe:	EMC Directive, 2004/108/EC & Low Voltage Directive (LVD) 2006/95/EC
Taiwan:	Bureau of Standards and Metrology Inspection (BSMI) CNS 13438: 2006

Federal Communications Commission (FCC) Class A Notice (USA)

This equipment has been tested and found to comply with the limits for a Class A digital device, pursuant to part 15 of the FCC Rules. These limits are designed to provide reasonable protection against harmful interference when the equipment is operated in a commercial environment. This equipment generates, uses, and can radiate radio frequency energy and, if not installed and used in accordance with the instruction manual, may cause harmful interference to radio communications. Operation of this equipment in a residential area is likely to cause harmful interference in which case the user will be required to correct the interference at his own expense.

FCC Declaration of Conformity

Models: HL-022-002, HL-002-002, SL-002-002

Electromagnetic Compatibility Class A Notice

Industry Canada Equipment Standard for Digital Equipment (ICES-003)

Cet appareil numérique de la classe A respecte toutes les exigences du Règlement sur le matériel brouilleur du Canada.

English translation of the notice above:

This Class A digital apparatus meets all requirements of the Canadian Interference-Causing Equipment Regulations.

Bureau of Standards Metrology and Inspection (BSMI) - Taiwan

BSMI EMC STATEMENT -- TAIWAN

This is a class A product. In a domestic environment this product may cause radio interference in which case the user may be required to take adequate measures.

警告使用者：

這是甲類的資訊產品，在居住的環境中使用時，可能會造成設頻干擾，在這種情況下，使用者會被要求採取某些適當的對策。

EC Declaration of Conformity

European Community Directives Requirement (CE)

Declaration of Conformity

Manufacturer's Name: 8e6 Technologies
 Manufacturer's Address: 828 W. Taft Avenue
 Orange, CA 92865

Application of Council Directive(s): Low Voltage • 2006/95/EC
 EMC • 2004/108/EC

Standard(s): Safety • EN60950: 2006
 EMC • EN55022: 2006
 • EN55024: 1998 +A2:2003
 • EN61000-3-2: 2000
 • EN61000-3-3: 2001

Product Name(s): Internet Appliance

Product Model Number(s): HL-022-002, HL-002-002, SL-002-002

Year in which conformity is declared: 2008

All hardware components supplied in this unit's shipping carton are certified by our vendors to be RoHS compliant.

I, the undersigned, hereby declare that the equipment specified above conforms to the above Directive(s) and Standard(s).

Location: Orange, CA, USA

Signature:



Date: January 21, 2008

Full Name: Gregory P. Smith

Position: Director of Engineering Operations

APPENDIX: SCSI CONNECTED STORAGE DEVICE

This appendix pertains to the installation of the optional NAS (SCSI Connected Storage Device or “SAN”) unit.

Preliminary Setup Procedures

Unpack the Unit from the Carton

Inspect the packaging container for evidence of mishandling during transit. If the packaging container is damaged, photograph it for reference.

Carefully unpack the unit from the carton and verify that all accessories are included. Save all packing materials in the event that the unit needs to be returned to 8e6 Technologies.

The carton should contain the following items:

- 1 Nexsan Technologies unit
- 1 Mounting Kit
- 1 Accessory Kit containing:
 - 2 AC Power Cords
 - 1 Ultra SCSI 160 cable

Other Required Installation Items

In addition to the contents of the Nexsan carton, you will need the following items to install the storage device:

- 1 Standard CAT-5E cable
- 1 CAT-5E crossover cable (from the ER server carton)

Inspect the unit and accessories for damage. If the contents appear damaged, file a damage claim with the carrier immediately.



NOTE: Refer to the ER safety precautions. In addition to being applicable to the ER, this information also applies to this storage device unit.

Rack Mount the Server

Rack Mount Components

The following items are needed to install rails for rack mounting:

- 1 x Slide Kit and Mounting Hardware
- 1 pair Accuride Slide Rails

Rack Setup Precautions

Warning:

Before rack mounting the unit, the physical environment should be set up to safely accommodate the unit. Be sure that:

- The weight of all units in the rack is evenly distributed. Hazardous conditions may be created by an uneven weight distribution.
- The rack will not tip over when the unit is mounted, even when the unit is fully extended from the rack.
- For a single rack installation, stabilizers are attached to the rack.
- For multiple rack installations, racks are coupled together.
- The rack is grounded and will maintain a reliable ground at all times.
- A power cord will be long enough to fit into the unit when properly mounted in the rack and will be able to supply power to the unit.
- The connection of the unit to the power supply will not overload any circuits.
- The unit is only connected to a properly rated supply circuit. Reliable earthing (grounding) of rack-mounted equipment should be maintained.
- The air flow through the unit's fan or vents is not restricted.
- The maximum operating ambient temperature does not exceed 104°F (40°C).



NOTE: Always make sure the rack is stable before extending a component from the rack.



WARNING: Extend only one component at a time. Extending two or more components simultaneously may cause the rack to become unstable.

Step 1

Remove inner slide rail as shown. Press down on latch to release.

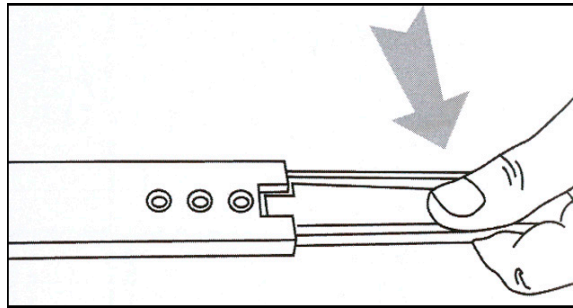
**Step 2**

Attach inner slide rail to chassis using 3 screws as shown.

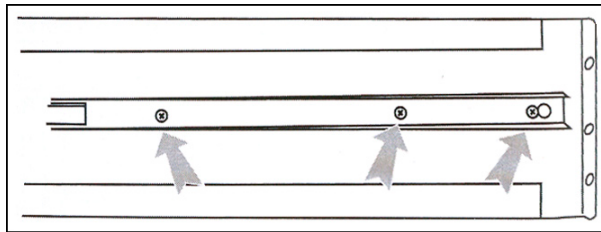

 **NOTE:** When attaching the extended brackets, attach them loosely at first. Adjust the length to fit the cabinet, and then tighten.

Step 3

Attach left and right rear (long) extended brackets to the outer rail using 2 screws, 2 washers, and 2 nuts for each bracket.

 **NOTE:** Make sure the flange is on the bottom edge.

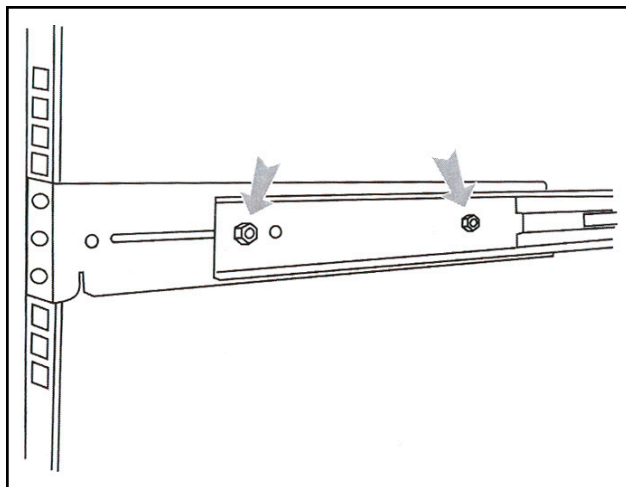

Step 4

Attach left and right front (short) extended brackets to the outer rail using 2 screws, 2 washers, and 2 nuts for each bracket.

 **NOTE:** Make sure the flange is on the bottom edge.

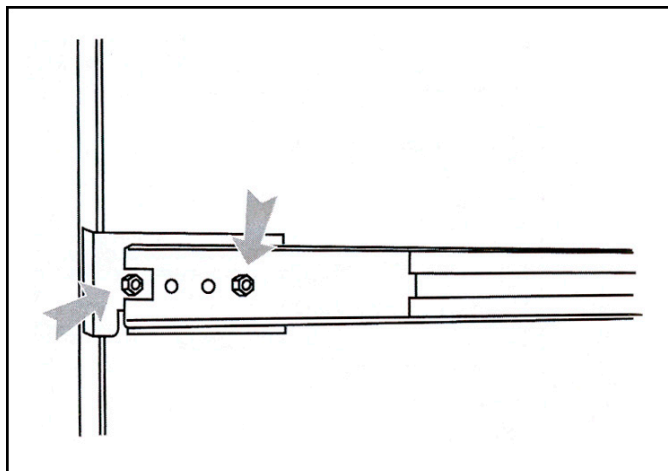

Step 5

Attach outer rail to chassis using 4 screws and cage nuts per rail, 2 at each end.

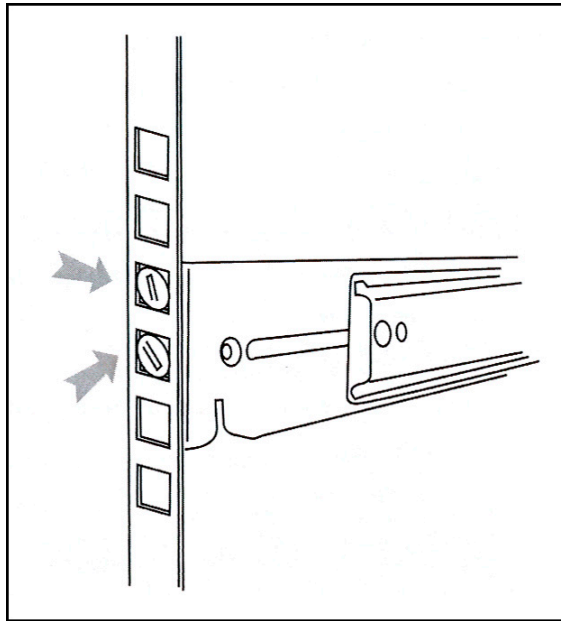

Step 6

Slide chassis into outer rail carefully, making sure the chassis is level with the slide.

 **NOTE:** *It's easier if the drives and power supplies are removed first before sliding the chassis into the outer rail.*

Install the Unit

Link the ER Unit with the SCSI Connected Device

This step is a continuation from the Storage Device Setup (for Attached Storage Units) portion of Step 1A or 1B in the ER section. The procedures outlined in this step require the use of the CAT-5E crossover cable and the Ultra SCSI 160 cable.

- A. Plug the SCSI cable into the upper right slot on the back of the ER unit (see Figure 1, Item A).
- B. Plug one end of the CAT-5E crossover cable into the ER unit's LAN 2 port—the port on the right (see Figure 1, Item B).



Figure 1: Back of the ER unit

- C. Plug the other end of the SCSI cable into the storage device's upper **left** disk "0" (zero) channel (see Figure 2, Item A).

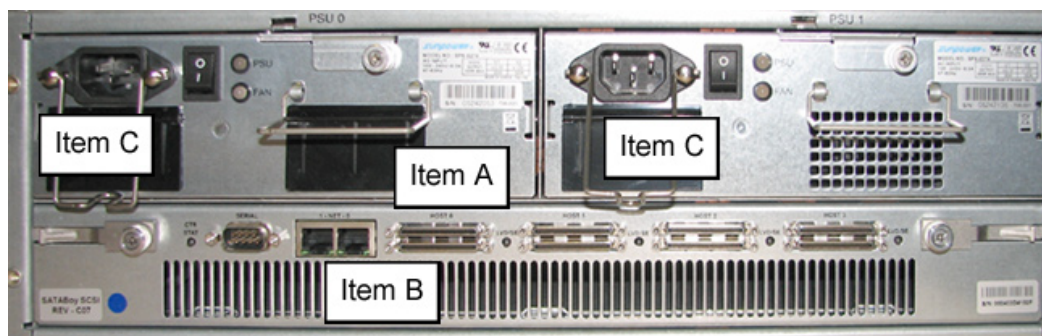

Figure 2 - Back of the Nexsan SATABoy

- D. Plug the other end of the CAT-5E crossover cable into the storage device's port "0" (zero) on the right (see Figure 2, Item B).
- E. Plug the storage device's AC power cords into the back of the unit (see Figure 2, Item C).
- F. Plug the loose ends of the AC power cords into a power source with an appropriate rating. It is strongly suggested you use an uninterruptible power supply.

⚠ WARNING: Be sure **all** drives are installed in the storage device unit before powering on the unit. Be sure the ER unit is **not** powered on.

- G. Turn on the power switches at the back of the storage device, which are positioned to the right of the power cord connectors. The boot-up process may take up to 5 minutes. When the unit is booted up, the three vertical LED lights at the left of the front panel will be lit up (see Figure 3).

Once all LED lights are lit, the ER can be powered on.



Figure 3: LED display

Shut Down, Restart Procedures

Follow the procedures in this section if you need to shut down or restart the storage device.

Shut Down the Storage Device Unit

If you need to shut down the storage device, always follow these steps:

- A. Power off the ER unit first. (Refer to the Physically Connect the ER to the Network sub-step in Step 1B of the ER section for shut down procedures.)
- B. Power off the storage device next by turning off both switches in the back of the unit.

Restart the Storage Device Unit

The storage device must be restarted after a power failure. In this instance, the storage device may already be turned on, but needs to be booted up again.

⚠ WARNING: You must **always** power on the storage device **before** powering on the ER unit. Since the storage device is an information database, if you experience a power interruption or if you power off the storage device without going through the standard shut down procedures, you may lose data and/or damage the file system.

To restart the storage device, press the power button on the front panel. The boot-up process may take up to 5 minutes.

Physical Components

Rack Mount Option

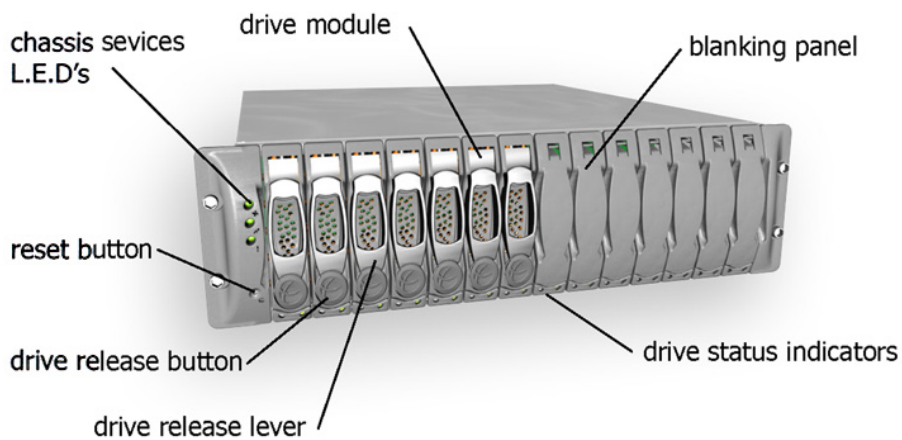

Pedestal Option

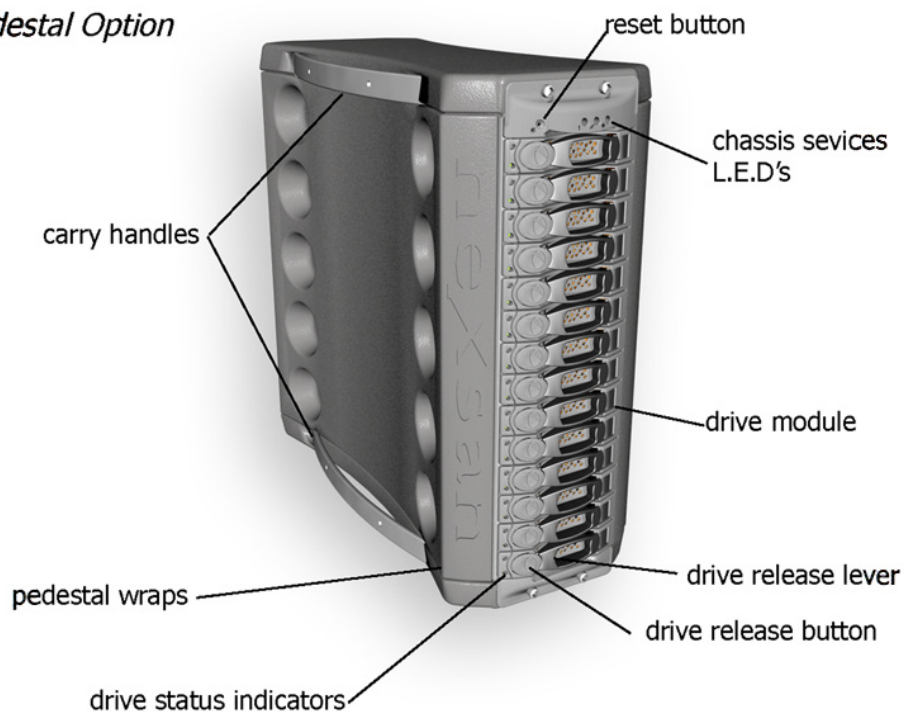

LED Display

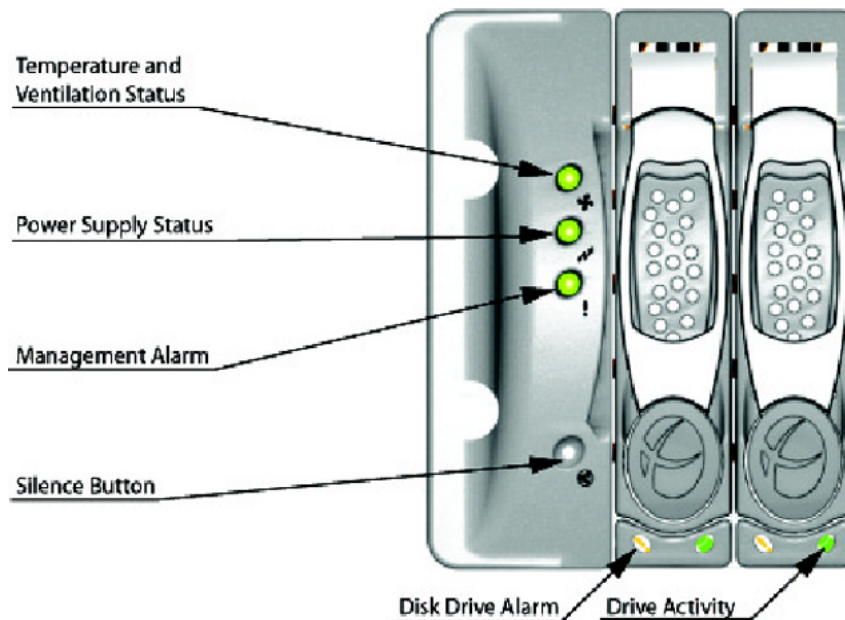

Temperature and Ventilation Status

When the LED is green, the blowers are operating at an acceptable RPM, and the internal temperature sensors are within acceptable limits.

The LED alternates green and red to indicate a predicted failure of one blower or an alarmingly rapid increase in temperature.

If the LED is red, a blower has failed or the unit is too hot, and an audible alarm will sound.

Power Supply Status

The LED is green if both power supplies are functional.

The LED is red if either power supply has failed, and an audible alarm will sound. In this scenario, an authorized service personnel should examine the LEDs on each power supply module to determine which has failed.

⚠ WARNING: *Inadvertently removing the functional, surviving power supply will result in system failure and possible data loss.*

Management Alarm

A green LED indicates nominal status.

A red LED indicates RAID controller or non-PSU/Blower enclosure errors.

Silence Button

Insert a thin object to temporarily silence the audible alarm. This button also is used for confirming creation in the RAID configuration mode.

Disc Drive Alarm

The LED is illuminated yellow if a drive is suspected to be bad.

Disk Drive Activity

The LED is illuminated green when an installed drive is in a “ready” state. During activity, the LED will flicker.

INDEX

B

Boot Up 30
BSMI 57, 58

C

Change Quick Start password 26
Change User Name and Password 44
crossover cable 4, 19, 29, 36, 60, 65

E

EMC 57, 59
ER Client 48
ER Server Statistics 52
Evaluation Mode 2, 51, 52
Expiration 51

F

FCC 57

H

HL 1, 4, 7, 14, 16, 20, 21, 29, 30, 54, 55, 56, 57, 59
HyperTerminal Setup 21, 22

I

ICES-003 57, 58
Install Bezel 14

L

LCD Panel 19, 37
Login screen 25
Log in to the Administrator Console 31, 43
LVD 57

N

NAS 2, 4, 20, 28, 37, 60

O

Overheat 53, 54

P

Physically Connect the ER to the Network 30, 36, 66
Power Supply Precautions 15

Q

Quick Start menu 25

R

R3000 1, 36, 46
Rack Setup Precautions 6
RAID 1, 56, 69
reboot 37, 41
Reset admin console account 26
Reset Admin Console Password 41
Reset system to factory defaults 26
RoHS compliant 59

S

SCSI 2, 4, 20, 28, 37, 60, 65
serial port cable 4, 19, 20
shut down 36, 37, 41
SL 1, 4, 11, 14, 20, 21, 29, 30, 53, 56, 57, 59
spare parts kit 4

U

UID 54
UL 57

8e6 Corporate Headquarters (USA):
828 West Taft Avenue Orange, CA 92865-4232 • Tel: 714.282.6111 or 888.786.7999
Fax: 714.282.6116 (Sales/Technical Support) • 714.282.6117 (General Office)

Satellite Office:
8e6 Taiwan: 7 Fl., No. 1, Sec. 2, Ren-Ai Rd., Taipei 10055, Taiwan, R.O.C.
Tel: 886-2-2397-0300 • Fax: 886-2-2397-0306

Free Manuals Download Website

<http://myh66.com>

<http://usermanuals.us>

<http://www.somanuals.com>

<http://www.4manuals.cc>

<http://www.manual-lib.com>

<http://www.404manual.com>

<http://www.luxmanual.com>

<http://aubethermostatmanual.com>

Golf course search by state

<http://golfingnear.com>

Email search by domain

<http://emailbydomain.com>

Auto manuals search

<http://auto.somanuals.com>

TV manuals search

<http://tv.somanuals.com>