

# 6725ip Phone Quick Reference Card

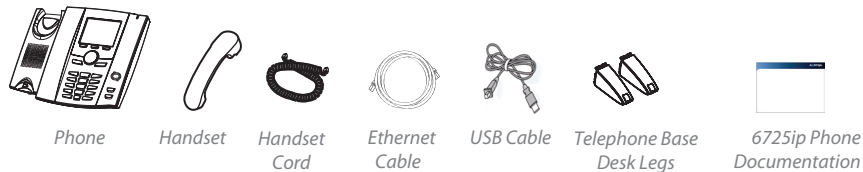

## Parts List



## Front Panel

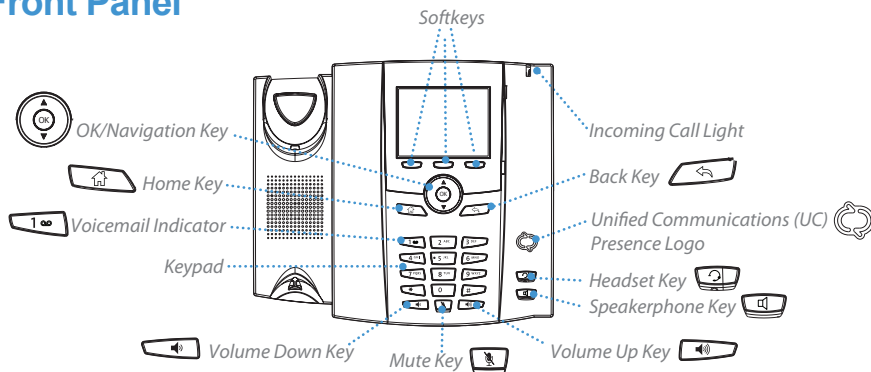

## Back Panel

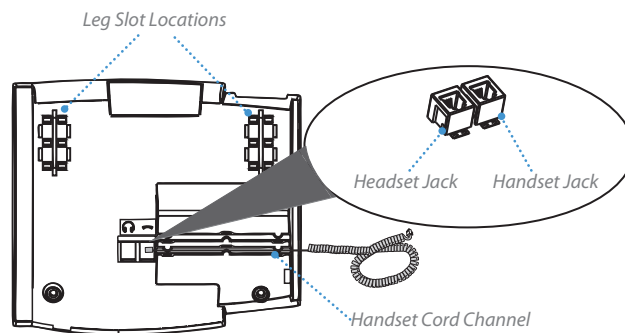

## Phone Requirements

- Microsoft® Lync™ Server 2010
- LAN - 10/100/1000BaseT Ethernet, category 5/5E/6 straight through cabling
- Power source - IEEE 802.3af Power-over-Ethernet source or the Aastra 48V Power Adapter (Optional Accessory)

## Setting up your phone

### To connect the handset to the phone:

1. Connect one end of the handset cord (B) to the handset (A) and the other end of the handset cord (B) to the handset jack on the back of the phone (C).
2. Guide the cord through the channel on the back of the phone to the outer edge (as shown in the "Back Panel" illustration).

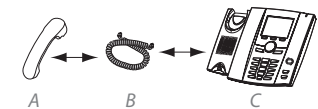

### To connect the legs to the phone:

A total of four different viewing angles allows you to personalize your viewing preference.

1. Attach each leg by inserting the tabs on the leg into the slots on the bottom of the phone. There are three pair of leg slots on each corner of the phone (D).
2. For a higher viewing angle, use the second and third slots from the top.
3. For a lower viewing angle, use the first and second slots from the top.
4. Push the stand towards the phone until it snaps into place.

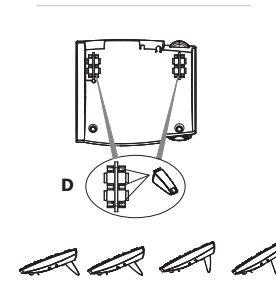

### To connect to the network:

1. Connect one end of the RJ-45 Ethernet cable (supplied) into the port marked "LAN" on the base phone.
2. Connect the other end of the Ethernet cable into your network source jack.

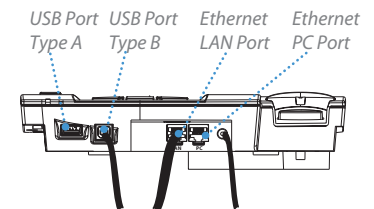

### For Ethernet networks that DO NOT supply Power-over-Ethernet to the phone:

1. Connect an Aastra 48V power adapter (optional accessory) to the power port on the base phone and plug the other end into a wall power outlet.

**48V Power Port**  
(connection not required if power provided over Ethernet connection)

## (Optional) Connect the phone via USB to your computer

### To connect the phone to your computer:

1. Connect the USB Type B connector on the USB cable (supplied) to the Type B port on the base phone (see illustration above).
2. Connect the USB Type A connector on the USB cable to a USB port on your computer.

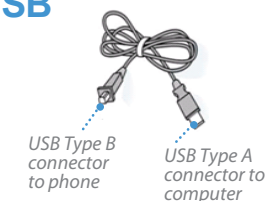

## Free Manuals Download Website

<http://myh66.com>

<http://usermanuals.us>

<http://www.somanuals.com>

<http://www.4manuals.cc>

<http://www.manual-lib.com>

<http://www.404manual.com>

<http://www.luxmanual.com>

<http://aubethermostatmanual.com>

Golf course search by state

<http://golfingnear.com>

Email search by domain

<http://emailbydomain.com>

Auto manuals search

<http://auto.somanuals.com>

TV manuals search

<http://tv.somanuals.com>