



THIS MANUAL IS AVAILABLE FOR FREE
COMPLIMENTS OF

BUYMEBUYME.COM

**TO ORDER THIS PRODUCT, PLEASE CALL TOLL-FREE
1-877-992-8963 OR VISIT WWW.BUYMEBUYME.COM**

8417 Installation and User Guide

AVSTRA

Table of Contents

Key Descriptions	2	Memory keys	16
Basic Installation	4	Saving numbers and names in memory keys	16
Connecting the handset cord	4	Saving from the display into memory keys	16
Connecting the line cord when Lines 1 and 2 are on the same line cord.	4	Labeling the memory keys	17
Connecting the line cords when Line 1 and Line 2 are on separate line cords	5	Making calls from memory keys	17
Connecting the power adaptor	5	Editing memory keys	17
Checking your telephone	6	Deleting memory keys	18
Connecting an optional modem or fax	6	Saving features in memory keys	18
Desk Mounting	7	Using feature keys	18
Optional Wall Mounting	7	Saving a feature and light in memory keys	19
Basic Features	8	Using FeatureLight keys	19
Making a call	8	Advanced Features	20
Answering a call	8	Adding a timer key	20
Putting a call on hold	8	Using the Call Timer	20
Switching between two lines	9	Deleting a timer key	20
Making a Conference call	9	Selecting the dial pad mode	21
Making a Handsfree call	9	Selecting the answer mode	21
Putting a call on mute	10	Extension in use	21
Using the Redial List	10	Display messages and lights	22
Telephone Setup	11	Knowing when you have a message	22
Changing the display language	11	Viewing multiple display and light messages	22
Setting the date and time	11	Learning about the lights	22
Turning the ringer ON and OFF	12	Set indicator light messages	22
Setting the ring tone and ringer volume	12	Line and Handsfree indicator light messages	22
Controlling the ringer volume	12	General display messages	23
Controlling the receiver volume	12	Helpful Hints	24
Controlling the speaker volume	12	Index	
Changing the prime line	13		
Directory	13		
Saving numbers and names to the Directory	13		
Entering Names	14		
Finding items in the Directory	14		
Making a call from the Directory	14		
Editing in the Directory	15		
Deleting items from the Directory	15		

Key Descriptions

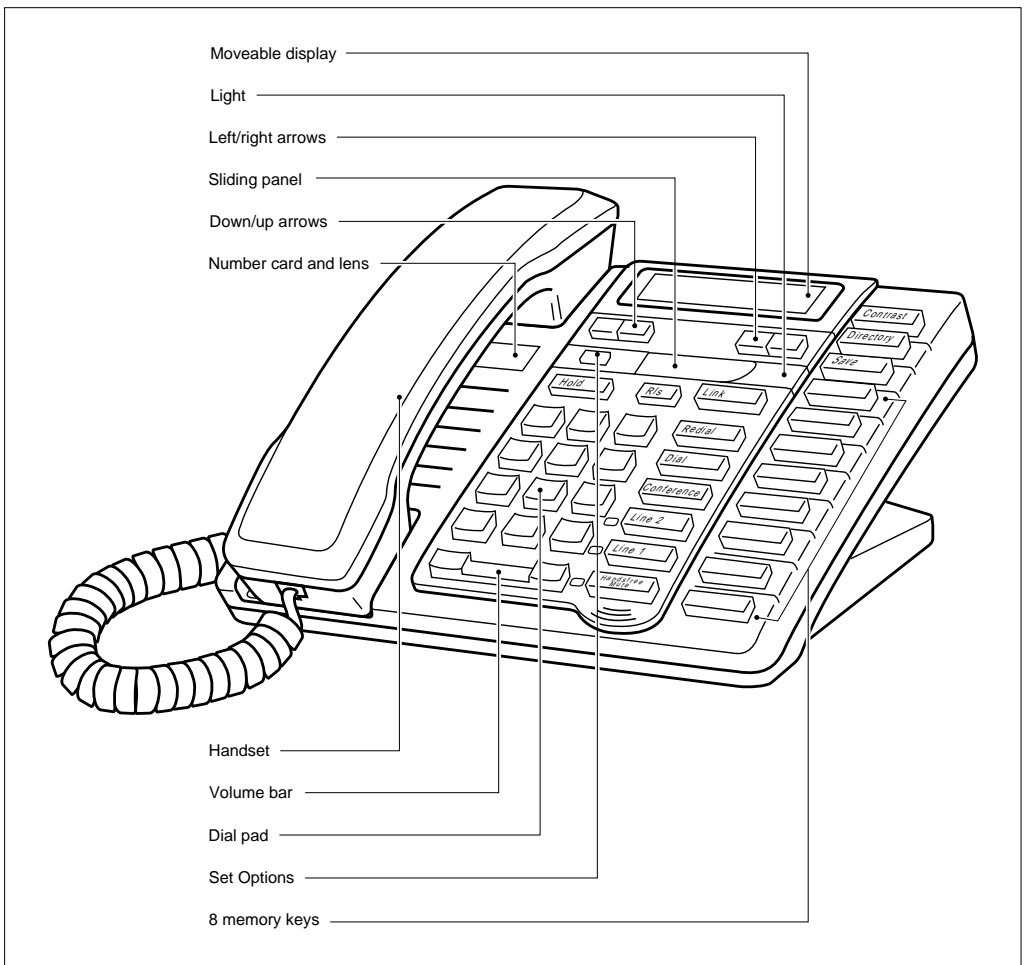

Contrast

Cycles through eight settings to adjust the display contrast.

Directory

Allows you to store and access up to 100 numbers and names.

Save

Stores numbers and names in the Directory and in memory keys.

↓ ↑

Allows you to move up and down any list such as the Set Options, Directory or the Redial List.

←

Allows you to backspace and erase when predialing and when adding or changing numbers and names in the Directory or in memory keys.



Adds a space when entering names in the Directory or in memory keys. Allows you to view status messages on the display.



The unlabeled Set Options key is hidden under the sliding panel. This key gives you access to seven options to customize your telephone. The table below lists the page numbers where these options are described.

Options	page
1. Change display language	11
2. Set the time and date	11
3. Select the ring tone	12
4. Add a timer key	20
5. Select the dial pad mode	21
6. Set prime line	13
7. Change answer mode	21



Puts the call on hold.



Always hangs up a call. Also allows you leave any list such as the Set Options List, Redial List or the Directory.



Allows you to access network features such as Call Waiting. Link is also referred to as Flash.



Allows you to access a list of the last five numbers you dialed.



Selects your prime line and dials any displayed number. Activates Handsfree if you haven't lifted the handset.



Joins the calls on the two line keys together.



Selects Line 1 or Line 2 and activates Handsfree if you have not picked up the handset. Dials any number on the display.



Activates the speaker and microphone so you can listen and talk without lifting the handset.



Allows you to erase memory keys and delete items in the Directory.



Allows you to adjust the receiver, speaker, and ringer volume.



Memory keys store numbers, names, and features.

Basic Installation

This section contains the information you need to install your 8417 telephone.

Connecting the handset cord

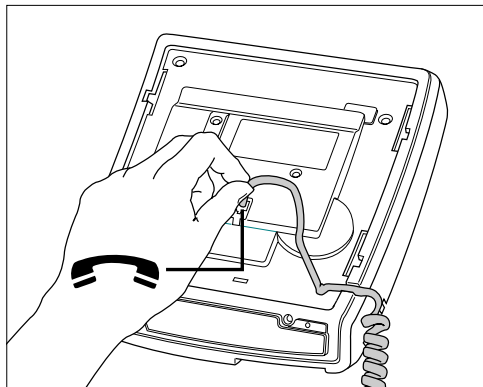

Attach the handset cord  .

Attach one end of the handset cord to the handset and the other end to the handset jack.

Connecting the line cord when Lines 1 and 2 are on the same line cord.

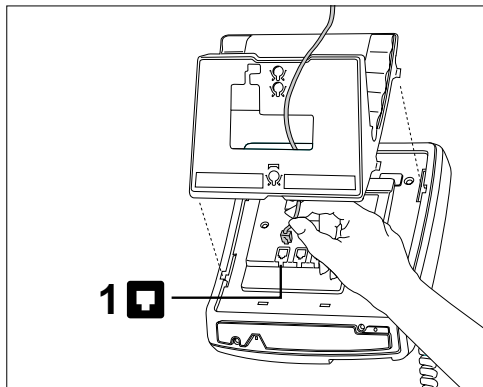

Attach the line cord in jack number 1, as shown by 1  .

Attach one end of the line cord to jack number 1 and the other end of the line cord to the wall jack. To determine whether both lines are on the same line cord, plug in the power adaptor (see **Connecting the power adaptor** on the next page) and read the display. The display may prompt you to select a language. Select your language choice. If Lines 1 and 2 are on the same line cord, the time and date is shown. **Check line cord** appears on the first line of the display and **Line 2 →** appears on the second line of the display if Lines 1 and 2 are on separate line cords.

Connecting the line cords when Line 1 and Line 2 are on separate line cords

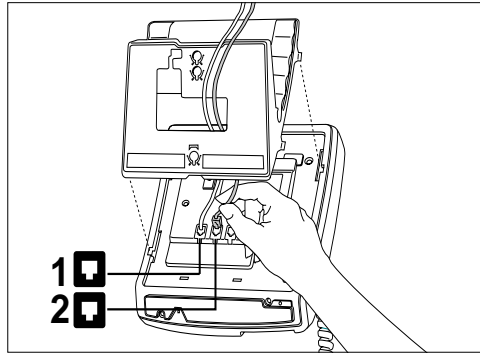

Attach line cord in jack 1 as shown by 1 .

Attach the second line cord in jack 2 as shown by 2 .

Attach one end of the line cord to jack number 1 and the other end to the wall jack. Attach the second line cord to jack number 2 and the other end to the wall jack. Both line cords are supplied with the telephone.

Note: If you want Line 1 and Line 2 on the same line cord, contact your telephone company or Telecom manager.

Connecting the power adaptor

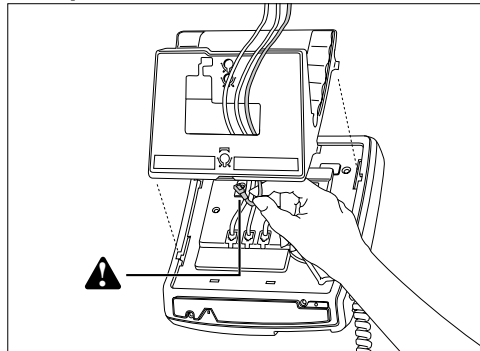

Attach the power adaptor cord .

Attach the power adaptor to the base of the telephone, where the warning symbol is marked. Then connect the power adaptor into the closest electrical outlet.



To avoid potential electrical shock hazard to personnel or damage to the telephone, use **only** the manufacturer supplied equipment and installation procedures (specifically the AC adaptor and four wire line cord). Substitution of non approved equipment will void the Aastra Telecom warranty.

For more information about installation and safety concerns, call 1-800-574-1611.

Checking your telephone

When you first plug in your 8417, you may see a message asking you to make a language selection. Follow the directions on the display to select one of the languages.

Your telephone also runs a test to ensure that the line cords are connected properly. If the test fails, the display identifies which line is not connected. Make sure that all connections are fastened securely.

Connecting an optional modem or fax

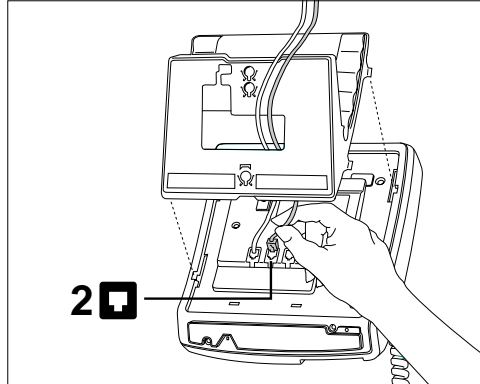

For your fax machine, answering machine or modem; attach the line cord in jack number 2 as shown by 2 .

Attach one end of the line cord to jack number 2 and the other end of the line cord to the peripheral.

Desk Mounting

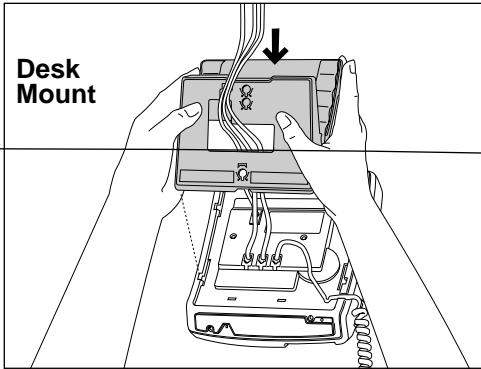

Lower the stand into the slots on the base of the telephone, as shown in the desk mount illustration above. Slide the stand back until it clicks into the locked position. The excess line cord fits into the stand of the telephone.

Optional Wall Mounting

Lower the stand into the slots on the base of the telephone, as shown in the wall mount illustration above. Slide the stand back until it clicks into the locked position. The excess line cord fits into the stand of the telephone.

Note: The Load number (LN) is 14 and the Ringer Equivalence Number (REN) is 1.4B for the 8417 telephone. Please see the base of your telephone or the Regulations sheet for more regulatory and safety information.

†We recommend that you use a wall mounting plate, which your telephone company or Telecom manager can install.

Basic Features

Making a call

With the 8417 you can make a regular call or predial a telephone number. Predialing allows you to check the number before it is dialed out. Follow the procedures below to make a regular or predialed call.

To make a regular call:

1. Lift the handset or press either or .
2. Enter the number using the dial pad.

To make a predialed call:

1. Enter the number using the dial pad.
2. Lift the handset or press either , or .

When you use , or lift the handset rather than using a line key to make a call, the prime line is automatically selected. The default prime line is Line 1. If you want to change the line selected to Line 2, see **Changing the prime line** on page 13.

Answering a call

To answer a call:

1. Lift the handset or press or the key for the line you want to answer.

If you lift the handset or press when both lines are ringing, the line that was ringing first is automatically answered. To change which line is answered first, see **Selecting the answer mode** on page 21 or **Changing the prime line** on page 13.

Putting a call on hold

To put a call on hold and take a call off hold:

1. Make or answer a call.
2. Press . The display shows that the call is on hold on line x and the line indicator light flashes.
Note: You won't lose the call if you hang up the handset, but you cannot retrieve the call by lifting the handset again or by pressing again.
3. To retrieve the call, press .

Note: If you do not retrieve the call after 15 minutes, the call is automatically dropped.

Switching between two lines

To put a call on hold and make or answer a second call:

1. Make or answer a call on one line.
2. To make or answer a second call on the other line, press the second line key. This automatically puts the original line on hold.
3. To hold one line automatically and speak on the other, press the line keys alternately.
4. To end a call which is not on hold, press **[R/S]** or hang up.

Making a Conference call

To join two calls in a Conference:

1. To make or answer a second call while on a call, press the other line key. Your first call is automatically held.
2. If you're making a call on the second line, dial the number using the dial pad, **[Redial]** or **[Directory]**, or a memory key.
3. Once you have callers on both lines, press **[Conference]**.

Note: You can speak privately with each caller by pressing their line key. This automatically puts the other caller on hold. You can re-establish the conference by pressing **[Conference]**.

Making a Handsfree call

You can dial without using the handset or you can make a regular call and then talk without using the handset.

To dial without picking up the handset:

1. Press **[Handsfree Mute]**.
2. Enter the number using the dial pad.
3. When the call is over, press **[R/S]**.

To switch to a Handsfree call:

1. Press **[Handsfree Mute]**.
2. Enter the number using the dial pad.
3. When the call is answered, press **[Handsfree Mute]** and hang up the handset.

Putting a call on mute

You can turn OFF the microphone so that the caller can't hear you but you can still hear the caller. This only works when you are on a handsfree call.

To mute a call:

1. Press .
2. Without lifting the handset, make a call.
3. To turn off the microphone, press again. You can hear your caller but your caller cannot hear you. The light beside flashes.
4. To speak to your caller, press again. Each time you press , you switch between handsfree and mute.
5. When the call is over, press .

Using the Redial List

If you do not remember a number you just dialed, you can find it in the Redial List. The Redial key shows you a list of the last five numbers you called. Once you lift the handset, pressing automatically dials the last number.

To make a call from the Redial List:

1. Press . The display shows the last number you dialed.
2. Find the number you wish to call by pressing .
3. When the number is displayed, lift the handset or press either , , or .

Telephone Setup

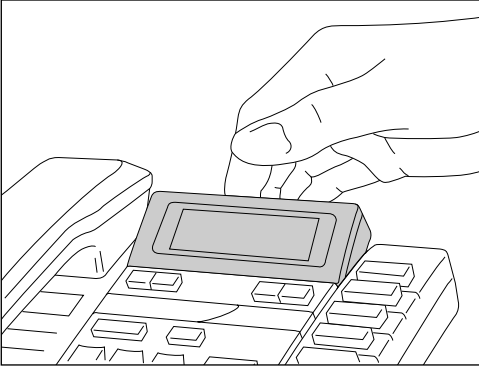

Place your 8417 on a table or hang it on a wall. Then adjust the display.







Move the sliding panel over to the right to reveal the Set Options key.

Changing the display language

For changing business requirements, you may wish to change the language of your display messages.





To change the display language:

1. Press the Set Options key.
2. Press   once or press  to go directly to the item.
3. Press  to select the language.

Setting the date and time







You can set the date and time manually. You may have to reset the date and time after a power failure, for Daylight Savings Time and for leap years.

To set the date and time:







1. Press the Set Options key.
2. Press   twice or press  to go directly to the item.
3. Press  and follow the instructions on the display.

Turning the ringer ON and OFF

To turn the ringer ON:

1. Press the right side of   .
2. Press .
3. Press the right side of   . Continue pressing the right hand side until you reach the desired ring volume.
4. Press .

To turn the ringer OFF:







1. Press the left side of   .
2. Press .
3. Press the left side of   . Continue pressing the left hand side until the ringer is off.
4. Press .
Ringer is OFF and the line affected appear on the display.

Note: Do not lift the handset while you are turning the ringer ON or OFF.

Setting the ring tone and ringer volume



You can choose one of four different ring tones and set the ringer volume for each line.

To set the ring tone and volume:



1. Make sure that the ringer is turned ON.
2. Press the Set Options key.
3. Press   three times or press  to got directly to the item.
4. Press  and follow the instructions on the display.
When picking the ring tone, press    to adjust the volume.
5. Press to end only when you are satisfied with ring tone and ringer volume.

Note: The steps above set the ring tone and volume for one line only. You must repeat these steps to set the ring tone and volume for the other line.



Controlling the ringer volume

While the telephone is ringing, you can press the left or right side of the volume bar    for soft or loud ringer volume.



Controlling the receiver volume

While you are on the telephone, you can press the left or right side of the volume bar    for soft or loud receiver volume.

Controlling the speaker volume

While you are listening through the speaker, you can press the left or right side of the volume bar    for soft or loud speaker volume.

Changing the prime line

The prime line is the line that is automatically selected when you lift the handset or press  or . The default setting for prime line is Line 1. You can select either line as your prime line.

Entering Names

To program a name, find the dial pad key that has the first character of the name. Keep watching the display as you press the key until that character appears on the display. Press a different dial pad key for the next character. If the next character is on the same key, press to move to the next space. To switch between upper and lower case letters, press Hold .

For example: To enter the name **Ruth** press these keys:

Hold .

If you wish to change a digit or letter after you have entered it, press to erase it.

1 , - ' & . () 1

2 A B C 2

3 D E F 3

4 G H I 4

5 J K L 5

6 M N O 6

7 P Q R S 7

8 T U V 8

9 W X Y Z 9

* #

0 0

Finding items in the Directory

To find items in the Directory:

1. To see the Directory List heading, press Directory .
 2. To see the listings that start with a particular letter, press the appropriate dial pad key. Then to see the other listings under that letter, press . (For example: takes you to the first "J" listing, then takes you to the next "J" listing. takes you to the first "K" listing.) Use the letter chart shown above.
OR, to move down and up the list, press . If you want to scroll steadily, press and hold .
 3. To leave the Directory at any time, press Directory or Rls .
- Note:** If you're on a call while you're viewing the Directory, pressing Rls also drops the call.

Making a call from the Directory

To make a call from the Directory:

1. Press Directory .
2. Press or use the dial pad to find the item you want to dial out.
3. Lift the handset or press either Handfree Mute , Dial , or Line x .
4. To end the call, press Rls or hang up.

Editing in the Directory

To edit a number and/or name in the Directory:

1. Press .
2. Press to find the item you want to edit.
3. To begin editing, press
4. If you do not want to change the number, go to step 5. To backspace and erase digits, press . To add digits, use the dial pad.
5. Press .
6. If you do not want to change the name, go to step 7. To change or add to the name, use and the dial pad. (See **Entering Names** on page 14.)
Note: If you edit the wrong item or want to quit without saving changes, press or .
7. Press .

Deleting items from the Directory

To delete individual items:

1. Press .
2. Press to find the item you want to delete.
3. Press twice. You are still in the Directory.
4. Press or to leave the Directory at any time.

To delete all items:

1. Press then press twice.

Memory keys

Saving numbers and names in memory keys

You can save the numbers and names of your customers, business associates, or anyone you call frequently in 8417's eight memory keys. You can store more numbers and names in the Directory. See the **Directory** section for more information.

To save a number and name:

1. Press .
2. Press the memory key where you want to save the number.
3. Enter the number using the dial pad. You can enter a maximum of 24 digits.
Note: If you require a pause (for example, between a telephone number and an access code), press where you want the pause.
4. Press .
5. To skip the name, go to step 6. To enter a name, use the dial pad.
(See **Entering Names** on page 14.)
6. Press .
7. Label the memory key. (See the diagram on page 17.)

Saving from the display into memory keys

To save from the display:

1. Ensure that a number is on the display. (For example, make a call using the dial pad, or use the Redial List.)
2. Press .
3. Press the desired memory key. If the name was displayed with the number, both are now saved in the memory key and you're finished.
4. If no name is displayed, you are prompted to enter one. If you don't want a name, go to step 5. To enter a name, use the dial pad. (See **Entering Names** on page 14.)
5. Press .
6. Label the memory key. (See the diagram on page 17.)

keys

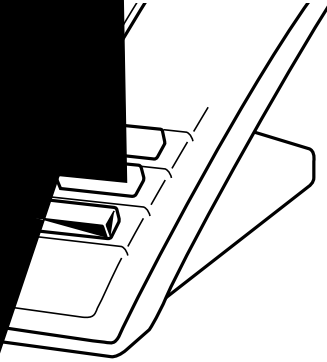

Labeling the memory keys, label them with the supplied blank labels and key

Calls from memory keys

To dial from a memory key:

Lift the handset or press either or .

Press the memory key with the number you want to dial out.

To predial from a memory key:

1. Press the memory key with the number you want to dial out.

2. Lift the handset or press either , , or .

Editing memory keys

To edit a memory key:

1. To see its contents, press the memory key.
2. Press .
3. If you don't want to change the number, go to step 4. To backspace and erase digits, press . To add digits, use the dial pad.
4. Press .
5. If you don't want to change the name, go to step 6. To add letters, use the dial pad. (See **Entering Names** on page 14.) To erase letters, press .
6. Press .

Note: The Live dial pad option must be turned OFF to edit memory keys.

† Keep key caps and the sliding panel away from small children. These small parts may come off the telephone if it is dropped.

Deleting memory keys

To delete a memory key:

1. To see its contents, press the memory key.
2. To erase, press **#** twice.

Note: The Live dial pad option must be turned OFF to edit memory keys.

Saving features in memory keys

For easy access, you can save the feature codes of telephone company services in your memory keys. This works well with network features such as Call Forwarding, Call Screen, and Call Return. Some features require an ON and OFF code in two separate keys, while other features are stored on only one key. The following procedures show you how to save both an ON and OFF code.

To save a feature ON code:

1. Press **Save**.
2. Press the memory key where you want to save the number.
3. Enter the telephone company feature code for turning the feature ON.[†]
4. Read the display to confirm the number.
5. Press **Save**.
6. Enter the feature name using the dial pad. (See **Entering Names** on page 14.)
7. Press **Save**.
8. Label the memory key. (See the diagram on page 17.)

To save a feature OFF code:

1. Press **Save**.
2. Press the memory key where you want to save the number.
3. Enter the telephone company feature code for turning the feature OFF.[†]
4. Read the display to confirm the number.
5. Press **Save**.
6. Enter the feature name using the dial pad. (See **Entering Names** on page 14.)
7. Press **Save**.
8. Label the memory key. (See the diagram on page 17.)

[†]**Note:** Contact your telephone company or Telecom manager for the appropriate feature codes.

Using feature keys

When a memory key is programmed with a feature code, you can use the memory key to activate or deactivate the feature.

To turn a feature ON or OFF:

1. Press the memory key where you stored the desired feature. The display shows the feature name and code.
2. Lift the handset or press either **Handsfree Mode**, **Dial**, or **Line x**.
The feature code is dialed out, which turns the feature ON or OFF.

Note: The active feature applies only to the line you selected or to the prime line if you did not press a line key. For example, if you want to forward all incoming calls, you must turn the feature ON for each line.

Saving a feature and light in memory keys

You can make the set indicator light come ON when you turn a feature ON and go OFF when you turn that same feature OFF. You can only do this with one feature. This works well with any service that has separate ON and OFF codes such as Call Forwarding.

For example, you may want the light to remind you that you have turned Call Forwarding ON. To do this, use one key to turn the indicator light ON when you activate the feature. Use the second key to turn the indicator light OFF when you deactivate that same feature. The following procedure shows you how to program a FeatureLight ON and OFF key.

To save a FeatureLight ON key:

1. Press . Do NOT select a memory key yet.
2. To program the light ON, press .
3. Press the desired memory key.
4. Enter the telephone company feature code for turning the feature ON.[†]
5. Read the display to confirm the number.
6. Press .
7. Label the memory key.
(See the diagram on page 17.)

To save a FeatureLight OFF key:

1. Press . Do NOT select a memory key yet.
2. To program the light OFF, press .
3. Press the desired memory key.
4. Enter the telephone company feature code for turning the feature OFF.[†]
5. Read the display to confirm the number.
6. Press .
7. Label the memory key.
(See the diagram on page 17.)

[†]**Note:** Contact your telephone company or Telecom manager for the appropriate feature codes.

Using FeatureLight keys

To turn a feature and light ON or OFF:

1. Press the memory key where you stored the FeatureLight.
The display shows **FeatureLight ON** or **FeatureLight OFF**.
2. Lift the handset or press either , , or .
The feature and light turn ON or OFF. (When the feature and light are ON and you're not using the telephone, the display shows Feature ON and the line that it applies to as a reminder.)

Advanced Features

Adding a timer key

You can program any of the memory keys to be a timer key.

To add a timer key:

1. Press the Set Options key.
2. Press four times, or press to go directly to the item.
3. Press to add a Timer key.
4. Press a memory key.
5. Press .
6. Label the timer key. (See the diagram on page 17.)

Using the Call Timer

You can program a memory key to time the length of a call. The timer starts and stops timing each call automatically. There is a separate timer for each line.

To show the timer on the display:

1. Make or answer a call. The timer starts running automatically.
2. Once on the call, press the timer key.
The display shows the running time of the call.
3. To return to the call information display, press the timer key again.
4. When the call is over, hang up the handset or press . The timer stops counting.

Note: To show the elapsed time of the most recent call (or last call) on each line when you're not on a call, press the timer key.

Deleting a timer key

To delete a timer key

1. Press the timer key.
2. Press twice.

Selecting the dial pad mode

When you select the dial pad mode, you are turning the Live dial pad option on or off. With Live dial pad ON, the telephone automatically dials out and turns on Handsfree as soon as you press a dial pad key or a memory key. When Live dial pad is OFF, the telephone is in regular or predial mode. This means after you dial the telephone number you must lift the handset or press either , , or before the telephone number is dialed.

To select the dial pad mode:

1. Press the Set Options key.
2. Press five times or press to go directly to the item.
3. Press to change the dial pad mode from Live dial pad OFF to ON or ON to OFF.

Selecting the answer mode

When you select the answer mode, you are choosing which line the telephone answers when you lift the handset or press .

Select **Answer Prime** (factory setting), if you want the telephone to automatically answer the prime line when you lift the handset or press .

Select **Answer longest**, if you want the telephone to automatically answer the line that began ringing first when you lift the handset or press .

To select the answer mode:

1. Press the Set Options key.
2. Press seven times or press to go directly to the item.
3. Press and follow the instructions on the display.

Extension in use

When you lift the handset or press , the 8417 telephone automatically selects the prime line. If your prime line is Line 2 and the peripheral device (e.g. fax machine) is using that line, the line is not selected and the message **Extension in use** appears on the first line of the display and **Select line key** appears on the second line of the display. If you press , you access Line 1 and can make a call. If you press , you will access Line 2 and may interrupt the call to the peripheral.

Display messages and lights

Knowing when you have a message

The 8417's set indicator light lets you know that your voice mail system has a message for you. The set indicator light flashes slowly and the display shows

Message Waiting or Message Waiting
Line x Line 1 Line 2

after your voice mail has received a call. Contact your local telephone company to find out how you can subscribe to message waiting services.

Viewing multiple display and light messages

When you aren't using the telephone, there are up to four messages that can be active at any time: date and time, **Feature ON**, **Message Waiting**, and **Ringer is OFF**. You can view the other messages by pressing . Each time you press , the display shows the next active message and its associated light. You can leave any one of the active messages on the display. However, the message that is currently on the display may change if another event, such as you receive a new message, occurs.

Learning about the lights

The set indicator light also alerts you when another extension is on the same line you're using, the telephone rings, or a feature is ON or the ringer is OFF. There are also indicator lights beside the line keys and to show you the status of the lines and of Handsfree and Mute.







Set indicator light messages

Feature	Light
Extension in use	Set indicator light is ON.
Feature ON	Set indicator light is ON.
Message Waiting	Set indicator light flashes slowly.
Visual Ringing	Set indicator light flashes very quickly.

Line and Handsfree indicator light messages

Feature	Light
Call is ringing on a line	Line indicator light flashes very quickly.
Call is on hold	Line indicator light flashes quickly.
Call is on Handsfree	Handsfree/Mute indicator light and line indicator light are ON.
Line is in use	Line indicator light is ON.
Microphone is muted	Handsfree/Mute indicator light flashes quickly.

General display messages

Message	What it means
Check line cord	If there is no dial tone, make sure the line cord and handset cord are attached securely.
Directory empty Use SAVE to add	The Directory remains empty until you add numbers and names to it.
Directory full No changes made	The Directory has a 100 entry limit. If you want to add an item, delete an item you no longer use.
Extension in use	An extension telephone is using the same line that you want to use. Select the other line instead. Or, someone is trying to use the same line on an extension telephone.
Feature ON	The FeatureLight ON key has been pressed and the code dialed out. To turn OFF the feature and the light, press the FeatureLight OFF key and lift the handset or press either  ,  , or  .
Key is locked	The memory key is factory-programmed and cannot be erased or reprogrammed. Program a different memory key.
Make calls first or Make second call	You must make two calls before you press  .
Message Waiting Line x	Your voice mail service has received a call for you. To subscribe to voice mail service contact your telephone company.
Press Conference	Both calls of a Conference are on hold. Press  to re-establish the Conference.
Press line key	This appears when the call you want is on hold. You must press  to retrieve the held call.
Ringer is OFF Line x	The ringer volume is turned OFF for that line. Without lifting the handset, press the volume bar.
...xxxxxxxxxxxxxxxx	The telephone number is longer than the display. The display shows ... and the last 15 digits of the number.

Helpful Hints

The display is in the alternate language.

You can change to the other language by pressing the Set Options key, then pressing **[1]** twice.

The cursor doesn't move when saving in the Directory.

The number or name is too long. Numbers can be no longer than 24 digits and names can be no longer than 16 characters.

You cannot save a Directory number into a memory key.

You cannot save Directory items into memory keys. Once you are in the Directory, can only add an item to the Directory.

There is no information on the display and the ringer volume is low.

Make sure the power adaptor is plugged in a working electrical outlet.

You cannot hear a caller or be heard.

Make sure the handset cord is inserted securely into the jack and make sure the receiver volume is high enough.

You answer the telephone and only hear dial tone.

The call is on your non-prime line; press the line key with the flashing light to answer the call. If this happens often, change your answer mode to Longest or change your prime line.

The power is out and the display is blank.

8417 still operates as a regular telephone during a power failure. You can dial using the dial pad and you can receive calls, but the other keys and the display do not operate until the power is restored. Only Line 1 works in this situation.

The display works but you can't hear dial tone.

Your telephone lines may be wired differently from the telephone jack. To have a service person correct the wiring, contact your local telephone company or Telecom manager.

The telephone wobbles.

Check that the handset cord is placed in the channel between the stand and the telephone. See the illustration on page 4.)

You cannot program a memory key.

Some of the memory keys may be factory-programmed. These keys are locked and cannot be erased or reprogrammed.

Index

A

- Answer mode 21
 - answer longest 21
 - answer prime 21
 - selecting 21

C

- Calls 8
 - answering 8
 - conferencing 9
 - holding 8
 - making 8
 - muting 10
 - redial list 10
 - switching between lines 9
- Conference call 9
 - making 9

D

- Date and time 11
 - setting 11
- Desk mounting 7
- Dial pad mode 21
 - selecting 21
- Directory 13
 - deleting all items 15
 - deleting items 15
 - editing 15
 - entering names 14
 - finding items 14
 - making a call 14
 - saving numbers and names 13
- Display language 11
 - changing 11
- Display messages 23
 - general 23

F

- FeatureLight keys
 - saving FeatureLight OFF 19
 - saving FeatureLight ON 19
 - using 19

H

- Handsfree 9
 - making a call 9
- Helpful Hints 24
- Hold
 - automatic 9
 - putting a call on hold 8
 - taking a call off hold 8

I

- Installation 4
 - connecting cords 4
 - connecting lines 4
 - desk mounting 7
 - wall mounting 7

L

- Language
 - see Display language 11
- Live dial pad
 - see dial pad mode 21

M

- Memory keys 16
 - cannot program 24
 - deleting 18
 - editing 17
 - labeling 17
 - predialing from 17
 - saving a feature and light 19
 - saving features 18
 - saving from the display 16
 - saving numbers and names 16
 - using 17
- Mute 10

P

- Prime line 13
 - changing 13

R

- Redial list 10
 - making a call 10
 - using 10
- Ring tone 12
 - setting 12

T

- Timer key 20
 - adding 20
 - deleting 20
 - using 20
- Troubleshooting
 - see Helpful Hints 24

V

- Volume 12
 - receiver 12
 - ringer 12
 - speaker 12
 - turning the ringer off 12
 - turning the ringer on 12

W

- Wall mounting 7

General inquiries

If you have read the guide and you still have questions, call 1-800-574-1611 in Canada and the USA. In other areas, contact your telephone company.

Free Manuals Download Website

<http://myh66.com>

<http://usermanuals.us>

<http://www.somanuals.com>

<http://www.4manuals.cc>

<http://www.manual-lib.com>

<http://www.404manual.com>

<http://www.luxmanual.com>

<http://aubethermostatmanual.com>

Golf course search by state

<http://golfingnear.com>

Email search by domain

<http://emailbydomain.com>

Auto manuals search

<http://auto.somanuals.com>

TV manuals search

<http://tv.somanuals.com>