



ACCUSPLIT, Inc.
 3090 Independence Drive, Suite 148
 Livermore, CA 94551 USA
 800-935-1996 • 925-290-1900 • FAX 925-290-1930
www.ACCUSPLIT.com • support@ACCUSPLIT.com

Eat Right! Walk More! Live Well!
The ACCUSPLIT Lifestyle

970-086
 Nov 07

ACCUSPLIT. EAGLE

AE140XL PEDOMETER



Operating Instructions

Functions

- Step counter.
- Distance in mi or km.

For complete Function Specifications, go to page 24.

2

Key Features

- Built around the Japanese-made JW200 PedometerEngine™ Step Sensor, the current gold standard for accuracy.
- Extra Large Digits.
- The ACCUSPLIT exclusive case makes this the slimmest available pedometer built around the JW200 Step Sensor.
- Chromed, Spring Steel clip resists breakage.
- Case includes two leash slots, for attaching safety leash on either side. Made from tough polycarbonate plastic.
- Step filter, can be set from 0-5 steps to further increase accuracy.

3

HOW TO OPEN YOUR PEDOMETER

See diagrams at right.

The cover must be closed for the pedometer to work.

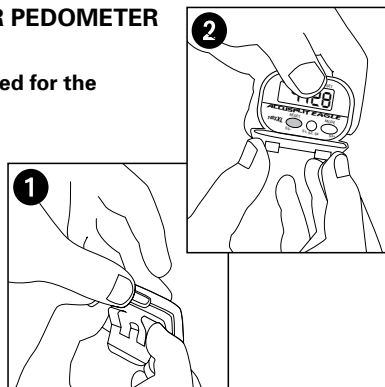

4

USE IT NOW!

Your pedometer is preset with standardized settings that allow you to use it now! You can customize the settings later. Skip to pages 13-16 to use it now!

SETTING UP YOUR PEDOMETER

It's a good idea to set up your pedometer before first using it. To record your distance accurately, you will need to set your stride length.

See page 9 when you are ready to set up your unit.

5

Getting Acquainted

- Press the MODE button to cycle through the display modes (Steps and distance.) See page 16 and Specifications for details.
- The RESET button sets your counts back to zero. See page 17 for details.

MODES

- STEP: STEP mode shows step count.
- DIST: DISTANCE mode shows distance traveled (mi/km).

6

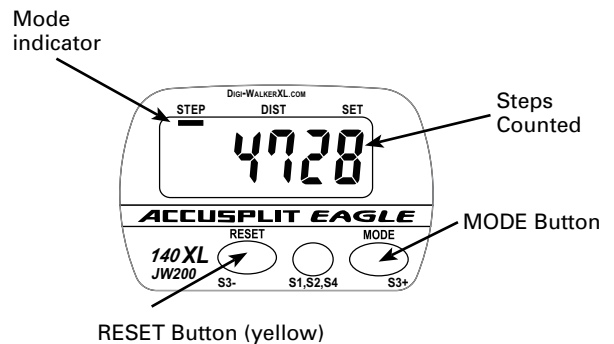

7

SETTING PROCEDURE

ACCUSPLIT products use a common setting procedure known as "S1- S2-S3-S4." Here's how it works:

Press S1 for 2 seconds: Enter the SET mode

Press S2: Change the field to be set

Press S3: Change the field value

Press S4 for 2 seconds: Exit the SET mode

You can enter and exit Set mode from any of the regular display screens.

8

Entering set mode

Press and hold the S1 (MEMORY) button for 2 seconds. The display will start to flash, showing that you've entered SET mode.

Setting Stride Length

1. You will see the mode indicator bar underneath DIST and the "in" indicator come on. The display will show a flashing number, which is your Stride Length set point (in inches).
2. Press the S3 + (MODE) button to increase the Stride Length (in increments of ¼ inch), and press the S3- (RESET) button to decrease the Stride Length. Hold the buttons down to change values quickly.

9

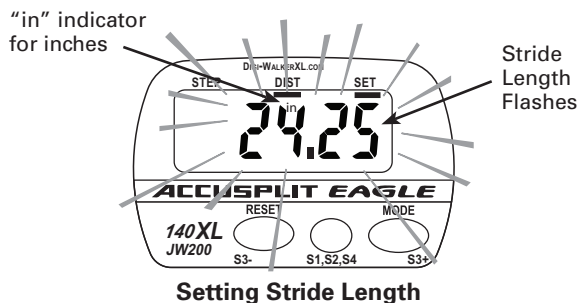

Setting Stride Length

10

Finding Your Stride Length: Your stride length is the length of one of your steps, measured from "toe to toe." To measure, walk 10 steps with your normal stride and measure the TOTAL DISTANCE from the toe of your starting step to the toe of your 10th step (see diagram below). Divide the TOTAL DISTANCE by 10, and multiply the decimal portion by 12 to find your stride length in feet and inches. Example: You walk 23 feet and 6½ inches in 10 steps. Convert to feet only = 23.542 feet (6½ ÷ 12 = 0.542). Divide by ten to get the stride length in feet = 2.354 feet. Now, convert back to feet and inches to get your stride length = 2 feet 4.25 inches (0.354 × 12 = 4.25).



11

Exiting Set Mode

Press and hold the S4 button for 2 seconds. The unit will exit setting mode – no values will be flashing anymore.

Note: The unit will save any changes and exit set mode after 30 seconds unattended.

12

WEARING YOUR PEDOMETER

Gently slide the pedometer onto your belt or the top edge of your pants or skirt. It should fit snugly and level, above one knee. The strong steel clip makes it easy.

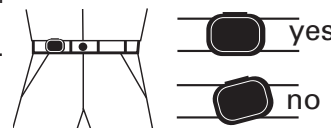

Note: The pedometer should be as vertical as possible. Walkers with larger stomachs may find it helpful to wear the pedometer farther back on the body, toward one hip.

The cover must be closed for the pedometer to work.

13

To avoid losing or dropping your pedometer, use the included leash and clip to fasten the pedometer securely to your clothing.

Attaching the Leash

1. Attach the pedometer to the leash by looping the thin side of the leash through one of the leash slots on the sides of the pedometer case, near the bottom of the unit.
2. Put the pedometer onto your clothing as discussed above.
3. Attach the alligator clip to a belt loop or the top edge of the pants or skirt.

Note: You can also use a safety pin to fasten the leash to your clothing, loop the leash through your belt or belt loop, or use a badge holder.

14

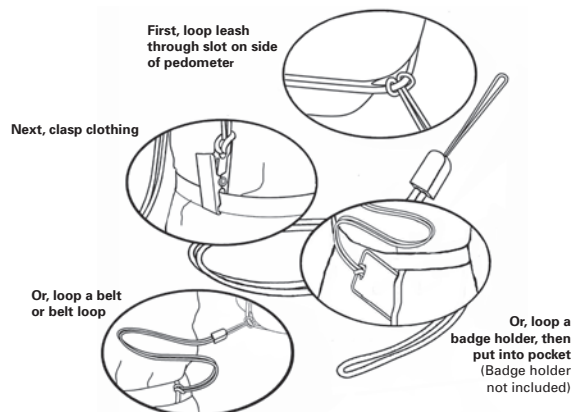

15

VIEWING YOUR RESULTS

Once you put on your pedometer with the cover closed, it will automatically begin to record your steps, activity time, and distance. Repeatedly press the MODE button to cycle through the pedometer modes:

STEPS → DISTANCE → STEPS

Distance is counted automatically whenever steps are being counted.

- DISTANCE is simply stride length x steps.

Note: For extra accuracy, the default Step Filter Setting is 1. See page 19 to learn more.

16

RESETTING YOUR PEDOMETER

Most people prefer to reset counts daily. To reset your counts: From STEP or DISTANCE mode, press and hold the yellow RESET button for at least 2 seconds. You'll see the values all go back to zero.

17

OTHER SETTINGS

The Step Filter and Unit of Measurement settings are accessed through a special "deep set" mode.

To enter this mode, press and hold the S1 button for 4 seconds. The screen will display a single digit. From within Deep Set mode, press the S2 button to cycle back and forth between the Step Filter set point and Choice of Unit System.

18

CHANGING STEP FILTER SETTING

While the JW200 PedometerEngine™ Step Sensor is extremely accurate, some people like to have the ability to filter out false steps. Therefore, the unit has a variable setting step filter, to allow fine-tuning to your specific preferences. You can set the value to any value from 0 – 5 steps. For example, if the filter is set to "3", the unit will wait to start counting steps until more than three steps have been taken in less than five seconds.

Press S3+ (MODE) or S3- (RESET) to change the Step Filter Setting.

19

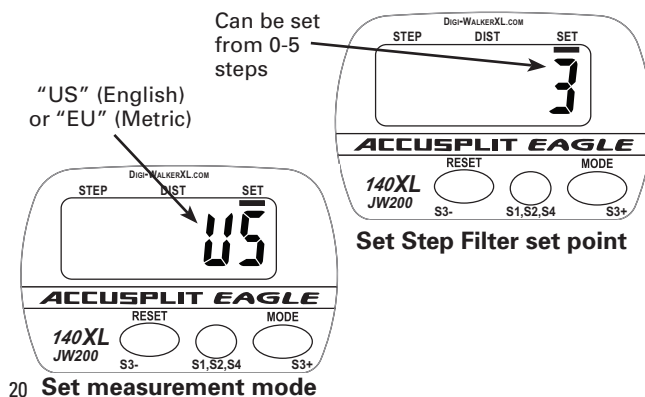

20

CHANGING UNITS (English vs. Metric)

The Pedometer can display either in English units (in, mi, and lb - this is the default), or in Metric units (cm, km, and kg). From within Deep Set mode (see pg. 18), press the S2 button to cycle back and forth between setting the Step Filter set point and Choice of Unit System. The unit will show either "US" or "EU" (for European Union) depending on the unit system chosen. If you change units after using the pedometer, the unit will convert all of your data into the new unit system when you exit Deep Set model. You can check to see which system of units you are using by seeing which measurement units are displayed on the Stride and Weight setting screens.

Press S3+ (MODE) or S3- (RESET) to change the Measurement Mode. Press and hold S4 for 2 seconds to exit Deep Set Mode.

Note: The unit will save any changes and exit set mode after 30 seconds unattended.

21

REPLACING THE BATTERY AND MASTER RESET

When the display starts to dim or goes blank, it is time to replace the battery.

If the display is not uniformly dim or blank, and appears to display "erroneous data", do a Master Reset by pressing all 3 buttons simultaneously for 3 seconds and then release. The display should go blank, then turn all segments on, then display 0 steps in Step Mode.

Note: All the settings will return to their default setting values. If you need to change the battery, the settings will also revert to default settings.

22

To replace the battery:

1. Insert a coin into the slot on the bottom of the case, and twist to loosen the faceplate. Remove faceplate and set aside.
2. Locate the battery holder as seen on sketch. Pull out the old battery, and push a new LR-44 battery into the holder, with positive terminal (+) facing up.
3. Snap faceplate back into place, hooking the bottom two tabs first, then closing by pressing together at the top two tabs.

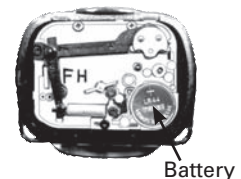

23

SPECIFICATIONS, FEATURES, and FUNCTIONS

Description of Functions

- Counts Steps up to 99,999 then rollover.
- Counts distance traveled during step activity, up to 999.99 mi or km, then rollover. Automatically counts whenever step activity is occurring.
- Adjustable stride length for greater distance accuracy (default setting is 21 in/53 cm, but can be set from 12-72 in (30-180 cm), in 0.25 in / 1 cm increments.
- Adjustable Step Filter (default setting is 1 step, but can be set from 0-5 steps) to increase step count accuracy.
- Switchable between English and Metric units, without losing data (default setting is English units).

REGISTER NOW Please return your AE140XL Registration to the Repair Center address in the warranty, and we will let you know about future products.	Email (preferred) User _____
---	------------------------------

NO-PROOF-OF-PURCHASE LIMITED WARRANTY
 Free service for first year of ownership;
 \$12 fee for service thereafter. See label inside unit for date.
 See www.ACCUSPLIT.com/support for details

INDEX

Battery, replacing	22-23	Step Filter Setting, change	18-19
Current day's results, viewing	16	Stride Length, setting	8-12
Setting Mode, exiting	12	Unit of measure, changing	18-21
Open your pedometer	4	Wearing pedometer	13
Safety Leash	14-15	Warranty	25
Setting up pedometer.	8-12		

Free Manuals Download Website

<http://myh66.com>

<http://usermanuals.us>

<http://www.somanuals.com>

<http://www.4manuals.cc>

<http://www.manual-lib.com>

<http://www.404manual.com>

<http://www.luxmanual.com>

<http://aubethermostatmanual.com>

Golf course search by state

<http://golfingnear.com>

Email search by domain

<http://emailbydomain.com>

Auto manuals search

<http://auto.somanuals.com>

TV manuals search

<http://tv.somanuals.com>