

ACS-61100 Quick Guide

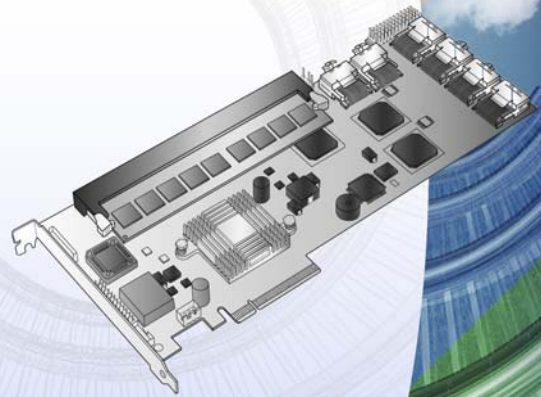

RAID Card

The RAID Architects

ACS 61100 Quick Start Guide

Welcome

Thank you for purchasing the ACS 61100 PCI Express to SATA II RAID adaptor. This model provides the latest functionality and performance for Windows, Linux and MAC operating systems. And with a Java based GUI the RAIDGuard X server and client software offers improved functionality and manageability.

What's in the box...

- ✂ This guide
- ✂ ACS-61100 RAID PCI-Express to SATA controller card.
- ✂ Installation CD-ROM including: user manuals for RAIDGuardX and 61100; JRE, Drivers and RAIDGuardX Client and Server.
- ✂ Mini Multi-Lane iPass cables (50cm), including SGPIO connector.

What you'll need...

- ✂ SATA II Hard Disk Drives (the number will vary depending on the RAID configuration).
- ✂ Host computer with spare PCI-e slot.
- ✂ Disk storage and power connection for each drive.
- ✂ Static grounding strap or electrostatic discharge (ESD) safe work area.

Optional items...

- ✂ Battery backup module to back up cached data in the event of a power failure.
- ✂ LCD Control Panel for Card status and advanced configuration.

Familiarizing yourself with the ACS-61100 RAID Card

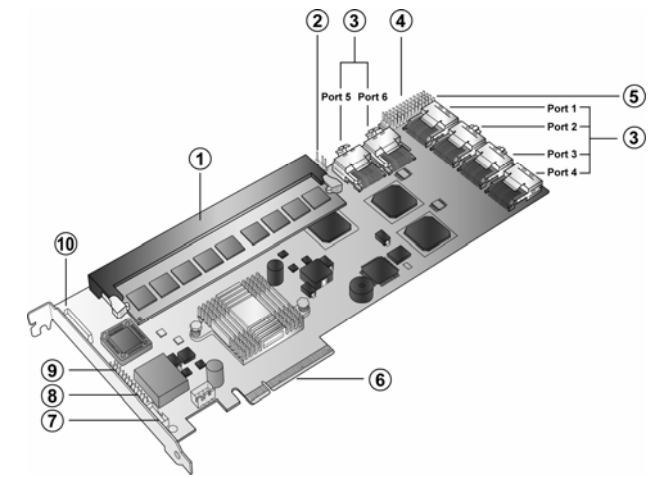

- | | |
|------------------------------|------------------------------|
| 1. DDRII memory connector | 6. PCI-Express x 8 connector |
| 2. I2C connector | 7. Serial port connector |
| 3. Mini SAS connectors | 8. Button port connector |
| 4. Disk access LED connector | 9. LCD panel connector |
| 5. Disk fault LED connector | 10. Battery module connector |

Card Installation

Card Installation

- Remove the blanking plate from the PCI-e slot.
- Position the connector of the card over the expansion slot.
- Press the connector of the card gently but firmly into the expansion slot until it is correctly and securely seated.
- Secure the metal bracket of the card to the system case with a screw.
- Go to the **Hard drive** connection.

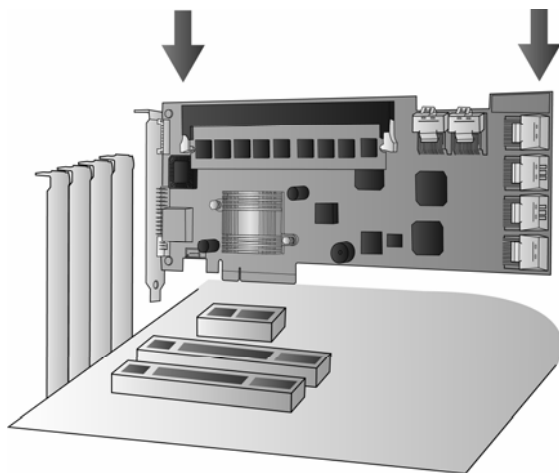

Hard Drive Connection

- Attach Mini SAS cables to the connectors on the card. One cable can control a maximum of 4 HDDs.
- Install the disks in the desired location eg within the system case or in an independent disk rack.
- Connect the other end of each cable to the connectors on each of the hard drives.
- Attach a power connector to each drive, either from the host system or from an independent power source.

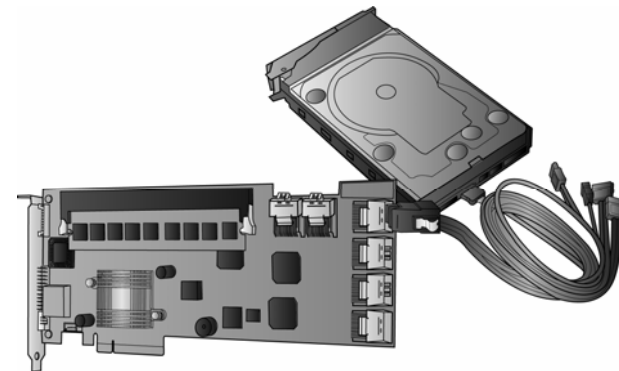

Note: The hard drives in a RAID should match in size and speed. All drives in any array should be identical models with the same firmware versions. Arrays only support LBA 48 bit HDDs (bigger 128GB), however, the smallest drive will determine the size of the array.

Initial Setup

The easiest way to start is to run the **Quick Array Configuration** from the BIOS.

BIOS

- Start the server and watch the screen. When it gets to the position shown below press **Enter**.

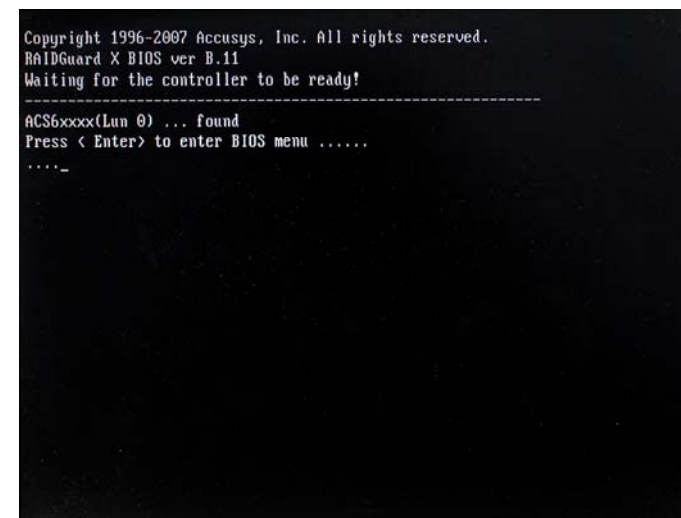

- Enter the password (the default is 00000000 (8 zeros) and press **Enter**.
- Go to **RAID Configuration > Create Array > Quick Array Configuration**. The BIOS will recognize how many drives are installed and provide the best solution. Type "Y" to begin configuration.

Software Installation

The details below are applicable only to the **Microsoft Windows** operating system. For other operating systems see the User Manual. First insert the CD into the CD-ROM drive of the server and/or client. Choose the required application from the on-screen menu.

Installing Java

It is necessary to install Java Runtime Environment v1.5.09 or later. For the latest version see www.java.com. From the on-screen menu choose to install **Java**.

Installing RAIDGuardX server

RAIDGuard X server is the application that runs on the host server that the 61100 is connected to. Once it is installed correctly the controller can be monitored from any remote computer with Java installed. From the on-screen menu choose which operating system to install for and follow the on-screen instructions.

Installing RAIDGuardX Client

From the on-screen menu choose which operating system to install for and follow the on-screen instructions.

RAIDGUARDX Server

Run the server application when you want to connect to the controller card.

1. Start the RAIDGuardServer from **Start > Programs > Accusys > RAIDGuardServer**.
2. The RAIDGuardServer icon  will be displayed in the Windows notification area.

Basic Configuration

RAIDGuard X Client

The RAIDGuard X Client is responsible for monitoring and administering the 61100 remotely from any computer with Java installed.

1. Start RAIDGuardX Client either click the desktop icon or go to **Start > Programs > Accusys > RAIDGuardX Client**.
2. Add a controller by clicking the  **Add Controller** icon.
3. Click the controller to administer and enter the password. The default password for the 61100 is 00000000 (8 zeros). Click **Add**.

Follow the steps to below to either add another array or configure the existing one.

Migration

Migration allows RAID types to be changed, for example from RAID level 1 to RAID level 5, without the need to delete the array and rebuild.

Follow the steps below to select an array to migrate.

1. Select the Array to migrate. From the drop down menu select the RAID Level to Migrate to then select the Total Drives to include in the array. A "+" sign is added above the disk(s) to be added and a "-" sign above the disk(s) to be removed.
2. Check the **Confirm** box and then click **Migrate**.

Snapshot

The snapshot function mirrors the data from one slice onto another thereby backing up the data.

Follow the steps below to take a snapshot:

1. Select **Create Shot**.
2. Select the shot, Source Slice and Destination Slice.
3. Check the **Confirm** box and then click **OK**.

Note: The destination slice must be the same size or bigger than the source slice.

Creating and Deleting an Array

Administrators can choose how best to distribute the disks available. Once an array has been created or deleted it can be further administered.

Follow the steps to create an array.

1. Click the **Create Array** icon .
2. Select the level from the drop down menu. Available levels are: 0, 1, 0+1, 5, 6, 0+1, and JBOD.
3. Select the stripe size from the drop down menu. Available stripe sizes are: 8-256KB.
4. Click the drives to be added to the array.

Optional: From the drop down menu select either *On The Fly Initialization* or *Performance Evaluation*.

5. To automatically assign a LUN check the box.
6. Click **Create Array** to complete the process.

Deleting an array removes the selected array and allows the drives to be used in another array or reconfigured for a new array.

Follow the steps below to delete an array.

1. Click the **Delete Array** icon .
2. Click on the disks containing the array to be deleted.
3. Check the **Confirm** box when you understand that all the data on the disks will be lost.
4. Click **Delete Array** to complete the process.

Health Center

The health center can help to resolve any problems with the array.



Follow the steps below to select an array to verify, rebuild or condition.

1. Select the Array to verify, rebuild or condition.
2. Click the radio button to Rebuild parity data, Verify parity data or Refresh array data and parity (for this option choose the priority between Low, Med or High).
3. Click **OK** to start the operation.

Unlock drives

Locked drives are drives that for one reason or another have stopped being recognized by the controller.

Follow the steps below to select a drive to unlock or change the ID.

1. Select the drive with the  icon. It will change to the  icon.
2. Check the **Confirm** box and then click **Unlock Drive**.

Updating ACS-61100 Firmware, BIOS and ROM

1. Download the latest firmware from www.accusys.com.tw.
2. Start the RAIDGuard X client.
3. Add a controller.
4. Click **Controller > Update > Update Firmware, Update Boot Code or Update BIOS & EFI**.
5. Go to the location of the downloaded files and click **Open**.

Error Alerts

Error alerts are activated when a problem occurs with the RAID controller or array. The alerts can be detected in two ways:

Beeper - An audible alarm sounds when an error has occurred. To set the beeper:

1. Click the **Preferences** icon  > **Mode** tab > Check the **Beeper** box.
2. Click **OK** to set the beeper.

E-Mail - E-mails are sent to administrative staff when an error or event occurs. To set e-mail alerts:

1. Click the **Email** icon .
2. Enter the e-mail addresses of recipients (max 20).
3. Enter the SMTP Server name and e-mail address.
4. If required enter the SMTP user name and password.
5. Click **OK**.

Advanced Configuration

Options

The Options menu provides the methods for changing the details of the array. Click the required option and then click **Next** to proceed.

FAQ

- 1. Q:** RAIDGuard X server displays the "Find no RAID Card" window.
A: Make sure that the controller card is connected inserted.
- 2. Q:** Hard drives aren't being displayed in the RAIDGuard X Client
A: Make sure that the Mini SAS cables are correctly installed and that the hard drives have power.
- 3. Q:** The software has stopped working correctly.
A: Restart the remote computer or server. If this doesn't work, insert the Installation CD into the computer/servers CD-ROM drive, click **Setup > Next > Repair > Install > Finish**.
- 4. Q:** Updating Firmware, Boot Code or Option ROM doesn't work correctly.
A: Do the following: 1) Check that the correct version is being installed eg, if, when updating the firmware the BIOS software is selected then the following message will be displayed "Command Failed"; 2) Don't unzip the .gz file 3) Download the file again.
- 5. Q:** E-Mail alerts aren't working.
A: Check that the correct details are inserted and that if a username and password are required they are inserted. See your network administrator for details.

Contact Us

Taiwan - Accusys, Inc.

Address: 5F, No.38, Taiyuan St., Jhubei City, Hsinchu County 302, Taiwan, R.O.C
Tel: +886-3-5600288, Fax: +886-3-5600299 <http://www.accusys.com.tw/>
e-mail: sales@accusys.com.tw

America - Accusys U.S.A., Inc.

Address: 46710 Fremont Blvd. Fremont, CA 94538, U.S.A.
Tel: +1-510-661-0800, FAX: +1-510-661-9800 Toll-free number: +1-866-277-5888
<http://www.accusysusa.com/> e-mail: support@accusysUSA.com, sales@accusysusa.com

Korea - Accusys Korea, Inc.

Address: Baegang B/D 5F Shinsa-Dong 666-14 Kangnam-Gu, Seoul, Korea
Tel : (02)6245-9050, Fax : (02)3443-9050 <http://www.accusys.co.kr/>
e-mail : sales@accusys.co.kr

China Beijing - Accusys China, Inc.

B1701, Horizon International Tower, No.6, ZhiChun Road, HaiDian District, Beijing
Tel: +86-10-82800080 Fax: +86-10-82800784 E-mail: sales@accusys.com.cn
<http://www.accusys.cn>

Europe - Accusys EU B.V

Address: Columbusstraat 2-10, 3165 AD Rotterdam, Netherlands
Tel : +31-10-4284117 Fax : +31-10-4284114 <http://www.accusyseu.com>, <ftp://ftp.accusyseu.com>
E-mail : sales@accusyseu.com, support@accusyseu.com

Slicing

Hard drive slicing partitions the drives of an array so that it appears as a separate volume.

Follow the steps below to select an array to slice or merge.

1. Select the array to slice or merge by clicking on a disk with an array number.
2. Click the slice to create and use the slider bar or buttons to adjust the size. Click **OK** to complete.
3. Check the **Confirm** box and then click **OK**.

LUN Map

A LUN is a unique identifier used on a SCSI bus that enables it to differentiate between up to eight separate devices. Use the LUN map to attach a unique identifier to a slice.

Follow the steps below to map a LUN.

1. Select the Array to map.
2. Choose a LUN and from the drop down list select a series to map to.
3. Check the **Confirm** box and then click **OK**.

Expansion

Expansion allows the adding of extra drives to an array with the need to rebuild the array.

Follow the steps below to select an array to expand.

1. Select the array to add additional disks to and select the number of disks to be added. A "+" sign is added above the disk(s) to be added.
2. Check the **Confirm** box and then click **Expand Array**.



Accusys
The RAID Architects

ACS-61100 Quick Guide
Copyright 2008 Accusys, Inc. Version 1.0
[Http://www.accusys.com.tw](http://www.accusys.com.tw) P/N: 42-34000-5013

The RAID Architects

Free Manuals Download Website

<http://myh66.com>

<http://usermanuals.us>

<http://www.somanuals.com>

<http://www.4manuals.cc>

<http://www.manual-lib.com>

<http://www.404manual.com>

<http://www.luxmanual.com>

<http://aubethermostatmanual.com>

Golf course search by state

<http://golfingnear.com>

Email search by domain

<http://emailbydomain.com>

Auto manuals search

<http://auto.somanuals.com>

TV manuals search

<http://tv.somanuals.com>