



# INSTALLATION MANUAL

# JET TANK SYSTEM

CONSUMER HOT-LINE: 1-800-942-3343 • MONDAY - FRIDAY • 7 AM to 5 PM

EASTERN  
STANDARD  
TIME

## JET TANK SYSTEM

with 7-gallon  
diaphragm  
pressure  
tank

**MODEL R-30-T7**  
**1/3 Horse Power**  
**Convertible Pump**

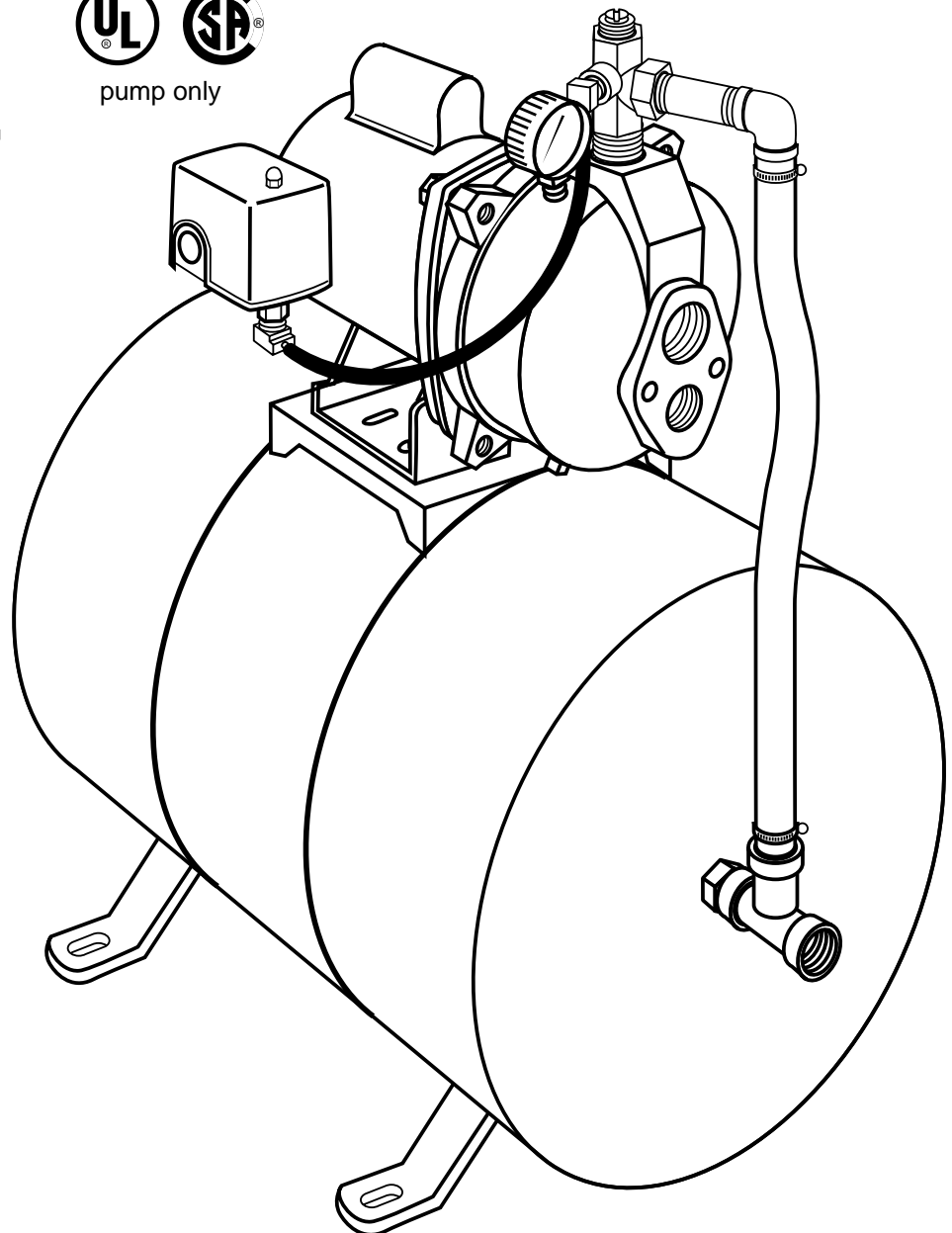

## WARRANTY

PRODUCT DEFECTS  
COVERED TWELVE  
MONTHS FROM  
DATE OF PURCHASE  
OR EIGHTEEN  
MONTHS FROM  
DATE OF MANUFACTURE,  
WHICHEVER  
COMES FIRST. RECEIPT  
AND PRODUCT DATE CODE  
REQUIRED FOR  
WARRANTY CLAIM.

**WATER ACE PUMP COMPANY • ASHLAND, OHIO 44805-1969**

23833A343

# IMPORTANT INSTRUCTIONS BEFORE INSTALLATION

Failure to follow these instructions may cause serious bodily injury and/or property damage.



**Warning void if product modified, drilled, painted, or altered in any way; if used to pump hot water, or to pump liquids other than water (such as but not limited to chemicals, fertilizers, flammable liquids, herbicides, mud, tar, cement, wood chips); or otherwise abused.**

1. Before installing or servicing your pump, BE CERTAIN pump power source is disconnected.
2. All installation and electrical wiring must adhere to state and local codes and must be complete before priming the pump. Check with appropriate community agencies, or contact your local electrical and pump professionals.
3. Pump should be installed in a dry, convenient location which is close to the well and provides ample space for installation and servicing the well. A dry basement, pit, or utility room is an excellent choice when allowed by law.
4. **CALL AN ELECTRICIAN WHEN IN DOUBT.** Pump should be connected to a separate electrical circuit directly from main switch. There must be a fuse box or circuit breaker installed in this line. Plugging into existing outlets may cause low voltage at motor, resulting in blown fuses, tripping of motor overload, or burned out motor. **Refer to electrical diagrams on following page for electrical connections.**
5. It is mandatory that a permanent ground connection be made from the pump to the grounding bar at the service panel. Do not connect pump to a power supply until permanently grounded. For maximum safety, ground the pump to a circuit equipped with a fault interrupter device.
6. **Motor Grounding Instructions: WARNING**  
Reduced risk of electric shock during operation of this

pump requires the provision of acceptable grounding. **Caution: Failure to ground this unit properly may result in severe electrical shock.** If the means of connection to the supply-connection box is other than grounded metal conduit, ground the pump back to the service by connecting a copper conductor, at least the size of the circuit conductors supplying the pump, to the grounding screw provided within the wiring compartment. NOTE: N.E.C. requires pumps be grounded at installation.

7. Voltage of power supply must match the voltage of the pump which is factory preset to 115V, but may be rewired for 230V (see following page).
8. During installation, cover well to prevent foreign matter from contaminating the well or later damaging the pump during operation. Test well water for purity. Chlorination may be necessary. Check local Health Department for proper testing and recommendations.
9. Hand pump new wells until clear. Sand or other sediment will seriously damage the pump.
10. The 7-gallon diaphragm pressure tank is factory preset to 30 PSI. **It must be reset to 18 PSI for proper system operation.** Use an air gauge to measure pressure in tank as air is released.
11. The following may cause severe damage to pump and/or piping and will void warranty:
  - Failure to protect pump and piping against below freezing temperatures.
  - Pumping chemicals or corrosive liquids.
  - Running the pump dry. Follow priming instructions on pages 4 or 8, depending on the installation.
  - Using extension cords.
  - Pumping gasoline or other flammable liquids.
  - Using this pump in or near a swimming pool.

**SHALLOW WELL PUMP CAPACITIES**

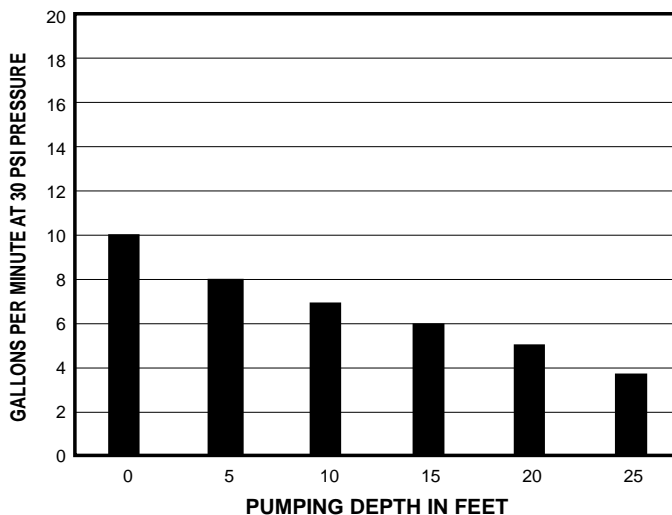

**DEEP WELL PUMP CAPACITIES**

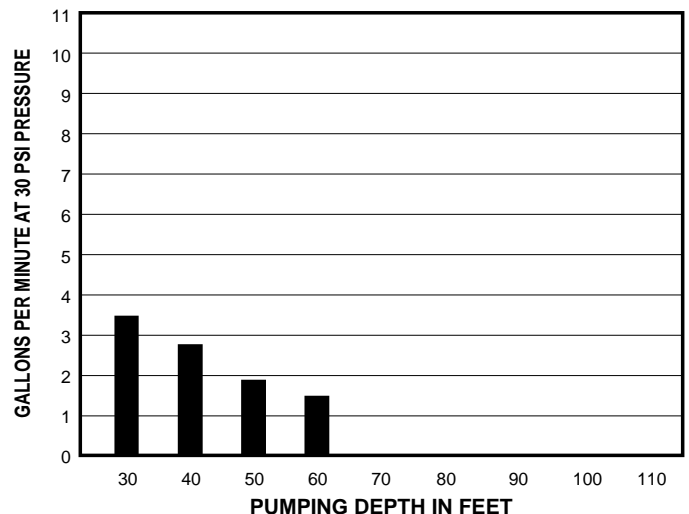

## FINDING THE DEPTH OF YOUR WELL

The jet tank system installs differently depending on the depth of your well. Tie a small but heavy weight to the end of a piece of string (be sure there is enough string; some wells are very deep). Lower the weight into the well until it reaches the bottom. Take up the slack and mark the string at ground level. Pull the weight out of the well and measure from the bottom of the weight to the ground level mark. This is the depth of your well. Subtract five feet from the depth of your well. This number should not exceed the maximum rated depth for your pump. If it does, it will greatly hinder or prevent the proper operation of the pump.

## 115V OR 230V OPERATION

Your pump is equipped with one of two types of dual voltage motors. Follow the instructions to wire the motor for the proper voltage. The voltage of the pump must match the voltage of the power supply.

## IMPORTANT SELECT CORRECT VOLTAGE

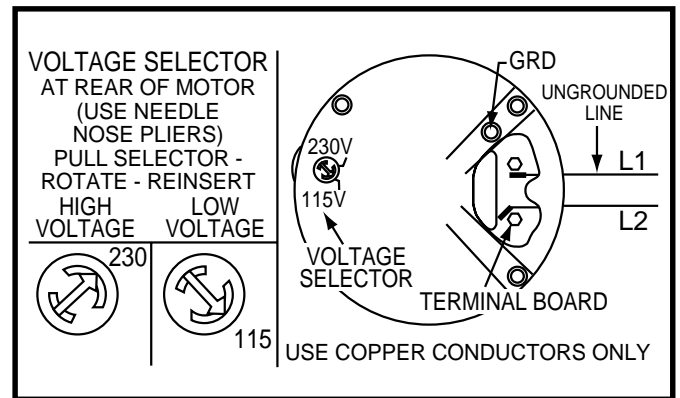

## WIRE SELECTION GUIDE

VOLTAGE	NAME PLATE AMPS	MAX. WIRE LENGTH USING AWG SIZE			
		#14	#12	#10	#8
115	10.6	118	189	296	464
230	5.3	475	756	1184	1857

## WIRING YOUR PUMP

Remove the cover from the pressure switch. Connect the bare copper ground to the ground screw in the pressure switch. Connect the power supply to the terminals marked "Line" in the diagram below.

## FUSE AND CIRCUIT BREAKER SIZE GUIDE

STANDARD LINE PLUG FUSE*		LOW PEAK - CART. TYPE FUSETRON - CART. TYPE FUSTAT - PLUG TYPE*		CIRCUIT BREAKER	
115V	230V	115V	230V	115V	230V
20	10	12	6-1/4	20	15

\*For circuits not over 150 volts to ground.

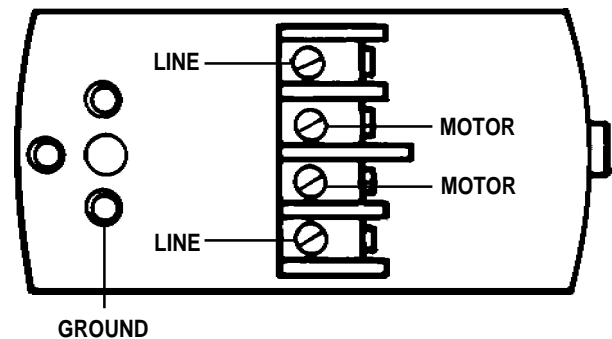

## PIPING

Plastic PVC pipe is shown in the illustrations, but galvanized steel pipe may be used if desired. All piping must be clean and free of all foreign matter to prevent clogging. **ALL JOINTS AND CONNECTIONS IN THE WELL ASSEMBLY MUST BE AIRTIGHT.** Even a pin-hole leak will prevent the proper operation of the pump (this is the most common problem). Use thread compound on all threaded joints unless specified otherwise.

## DRAINING FOR SERVICING OR FOR WINTER

The pump should be drained before it is disconnected for servicing or if it is in danger of freezing. To drain:

- Remove drain plug from bottom of pump case.
- Remove discharge tee to vent the pump.
- Drain all piping to a point 3 feet below ground level.

## SHALLOW WELL PUMP INSTALLATION (4" DIAMETER CASED WELL)

For wells 25 feet or less in depth, the ejector may be attached to the front of the tank-mounted jet pump. For lower depths, the ejector must be placed down inside the well (see DEEP WELL PUMP INSTALLATION). All materials with part numbers are quality Water Ace parts.

### General Materials

- One Jet Tank System #R-30-T7. Includes: 1/3 HP jet pump mounted on a 7-gallon diaphragm pressure tank, pressure gauge, and twin ejector with gasket, bolts, venturi tubes, and foot valve.

- One can PVC cement (read instructions carefully)
- One can thread compound (read instructions carefully)
- Two male 1-1/4" PVC adapters
- Enough rigid 1-1/4" PVC pipe and couplings to reach from bottom of well to pump.
- One 4" well seal #RWS4-1012 with vent plug
- One 1-1/4" PVC elbow

### Tools Needed for all pump installations

Pipe wrench, pipe clamp, crescent wrench, slot screwdriver, 24-tooth hacksaw, knife or round file.

**REMINDER: ALL JOINTS AND CONNECTIONS MUST BE AIRTIGHT. A SINGLE PIN-HOLE LEAK WILL PREVENT THE PROPER OPERATION OF THE PUMP. USE THREAD COMPOUND ON ALL THREADED CONNECTIONS UNLESS SPECIFIED OTHERWISE.**

- STEP 1** Thread 1-1/4" male PVC adapter into foot valve. Hand tighten, then tighten 1/4 turn with crescent wrench.

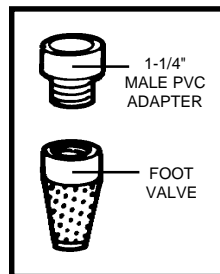

- STEP 2** Subtract five feet from the depth of your well (See page 3 "Finding the Depth of Your Well"). This is the total length of rigid PVC pipe and couplings to cement onto the 1-1/4" male PVC adapter. Cement one section of rigid PVC pipe to the PVC adapter which is connected to the foot valve, then lower the whole assembly into the well, foot valve first. Firmly clamp the end of the rigid PVC pipe with a pipe clamp to prevent the assembly from sliding down into the well.

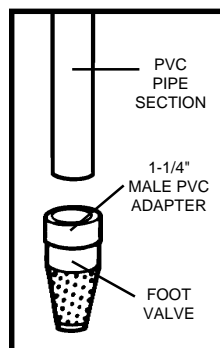

- STEP 3** Cement as many couplings and sections of rigid PVC pipe as it takes to equal the depth of your well minus five feet, then firmly clamp the assembly with a pipe clamp to prevent assembly from sliding down into the well.

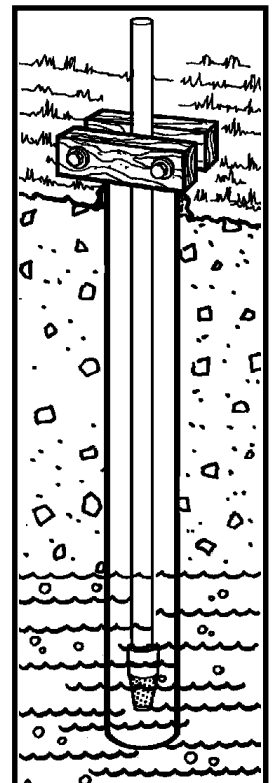

**STEP 4** Remove pipe clamp and slide Well Seal #RWS4-12 over PVC pipe and onto well casing. Position assembly so twelve inches of PVC pipe protrude from well seal. Alternately turn bolts on well seal counterclockwise until rubber gaskets are tight against well casing and PVC pipe.

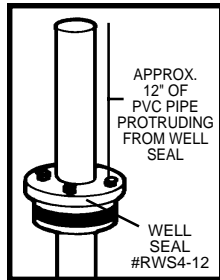

**STEP 5** Cement 1-1/4" PVC elbow onto PVC pipe protruding from well seal. If desired, some length may be cut off of PVC pipe before cementing elbow. Smooth inside of any cut PVC pipe with file or knife.

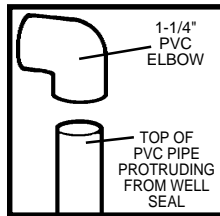

**STEP 6** Open ejector pack included with your jet system. The ejector has two holes in its top. Thread the venturi tube (part #25881A281 stamped on the side) into larger hole until snug. Put gasket over venturi tube so openings in gasket line up with openings in ejector.

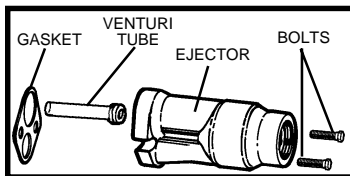

**STEP 7** Secure ejector and gasket to front of tank-mounted pump with bolts provided. Thread a 1-1/14" male PVC adapter into front of ejector.

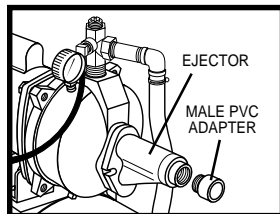

**STEP 8** Cement as much PVC pipe and couplings needed to connect PVC elbow to male PVC adapter in front of ejector. **The diaphragm pressure tank is preset to 30 PSI. Reset pressure to 18 PSI using a tire gauge.** This is vital to proper operation of the system.

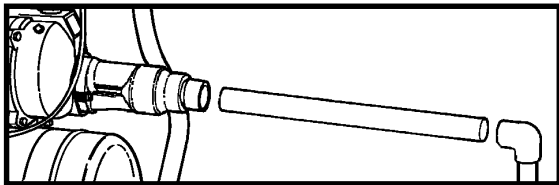

**STEP 9** Place a large bucket beneath the pressure regulator outlet. Start motor. Turn regulator adjustment screw down tight. If pump is properly primed a high pressure will immediately show on the pressure gauge. With pump operating at high pressure, slowly unscrew regulator adjustment screw until

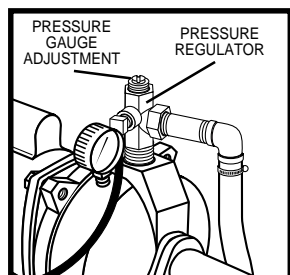

**STEP 9 CONT'D** maximum water flow is obtained without pressure dropping to zero. If pressure falls completely, retighten adjustment screw and read-just. **Steady pressure must not be less than 24 lbs. for the R520. If no pressure shows:** Stop motor, remove pressure gauge plug from pressure regulator, add more water, and try again.

**STEP 10** Thread pressure gauge plug back into discharge tee. Thread pressure gauge into pressure gauge plug. Make sure all connections are tightly sealed. Place a large basin beneath diaphragm tank outlet. Start motor. If pump is off-set from well 4 feet or more, it may take a few minutes for pump to prime. **Failure to prime in 5 minutes:**

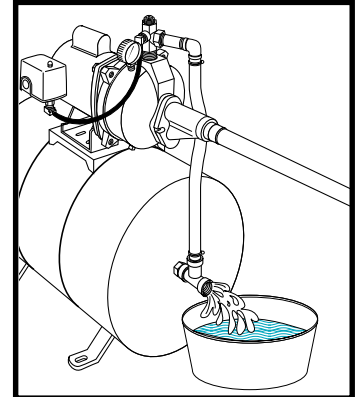

Stop motor, remove pressure gauge plug from discharge tee, add more water, try again. Allow pump to run long enough to clear the well of sand or dirt and to insure well will not run dry. Stop motor.

**STEP 11** Connect the 1" tank outlet to the service line. Total installation should look like the drawing below.

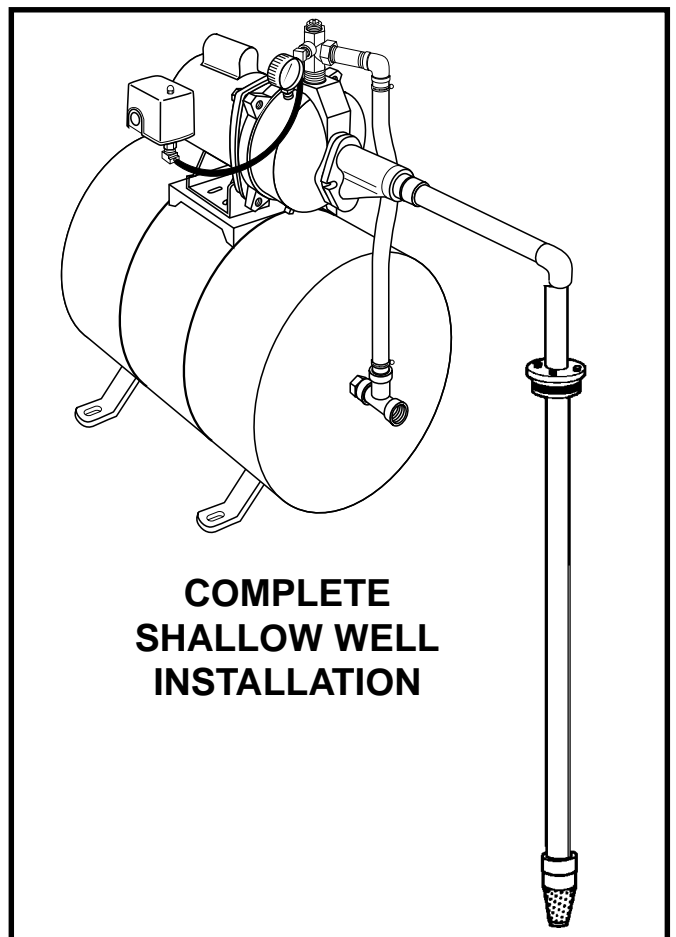

# DEEP WELL PUMP INSTALLATION (4" DIAMETER CASED WELL)

For wells over 25, but not exceeding 60 feet in depth, the twin ejector must be installed down inside the well rather than attached to the front of the pump. Materials with part numbers are quality Water Ace parts.

## General Materials

- One Jet Tank System #R-30-T7. Includes: 1/3 HP jet pump mounted on a 7-gallon diaphragm pressure tank, pressure gauge, and twin ejector with gasket, bolts, venturi tubes, and foot valve.
- One can PVC cement (read instructions carefully)
- One can thread compound (read instructions carefully)

- One 1-1/4" close nipple
- One 1" x 4" nipple
- One 1-1/4" x 5" nipple
- Two 1" female PVC adapters
- One 1" male PVC adapter
- Two 1-1/4" male PVC adapters
- Enough rigid 1-1/4" PVC pipe and couplings to reach from bottom of well to pump (delivery pipe)
- Enough rigid 1" PVC pipe and couplings to reach from bottom of well to pump (pressure pipe)
- One well seal #RWS4-1012
- One 1-1/4" PVC elbow
- One 1" PVC elbow

**REMINDER: ALL JOINTS AND CONNECTIONS MUST BE AIRTIGHT. A SINGLE PIN-HOLE LEAK WILL PREVENT THE PROPER OPERATION OF THE PUMP. USE THREAD COMPOUND ON ALL THREADED CONNECTIONS UNLESS SPECIFIED OTHERWISE.**

- STEP 1** Thread 1-1/4" close nipple into foot valve. Thread the other end of 1-1/4" close nipple into bottom of twin ejector. Hand tighten, then tighten 1/4 turn with pipe wrench.

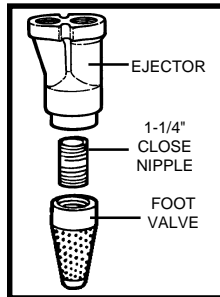

- STEP 2** The ejector has two holes in the top of it. Thread venturi tube (part #25881A281 stamped on the side) into larger hole until snug. Thread 1" x 5" nipple into smaller hole. Only hand tighten venturi tube. Tighten nipple 1/4 turn with pipe wrench.

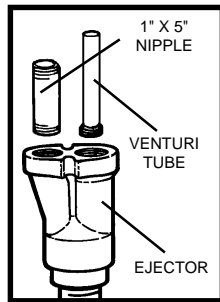

- STEP 3** Thread a 1-1/4" male PVC adapter over the venturi tube and into ejector. Thread a 1" female PVC adapter onto 1" x 5" nipple. Tighten adapters 1/4 turn with crescent wrench.

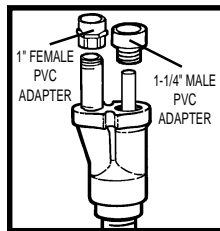

- STEP 4** Subtract five feet from the depth of your well. This is the total length of PVC pipe and couplings to cement onto both the 1-1/4" male and 1" female PVC adapters. Cement a section of PVC pipe to each adapter.

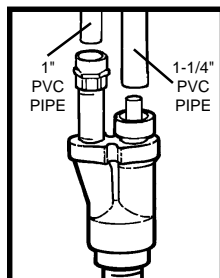

- STEP 5** Lower the assembly into the well, foot valve first. Use a pipe clamp to prevent assembly for sliding down into well. Cement as many couplings and sections of rigid PVC pipe on both sides of ejector as it takes to equal the depth of your well minus five feet, then firmly clamp assembly with a pipe clamp to prevent it from sliding down into the well.

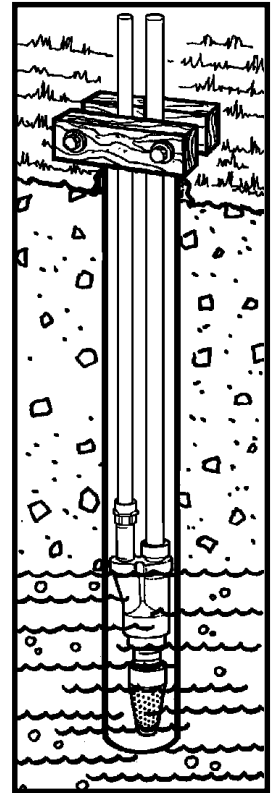

- STEP 6** Remove pipe clamp and slide well seal #RWS4-1012 over PVC pipes and onto well casing. DO NOT let assembly slide down into well. Position assembly so that twelve inches of PVC pipes protrude from well seal. Using crescent wrench, turn bolts on well seal counterclockwise until rubber gaskets are tight against the well casing and the PVC pipes.

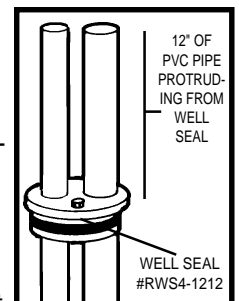

**STEP 7** Cut 1" pipe 2" shorter than the 1-1/4" pipe. Smooth rough edges. Cement 1" and 1-1/4" PVC elbows to pipes protruding from the well seal.

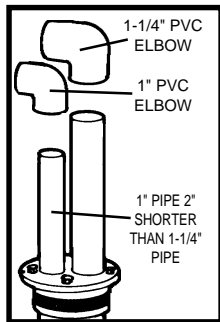

**STEP 8** Thread 1-1/4" male PVC adapter into top hole in front of tank-mounted pump. Thread 1" x 4" nipple into bottom hole in front of pump.

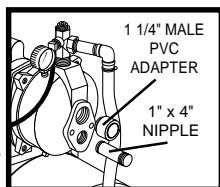

**STEP 9** Thread the 1" female PVC adapter onto the 1" x 4" nipple.

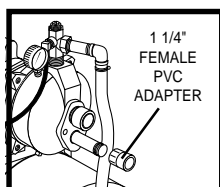

**STEP 10**

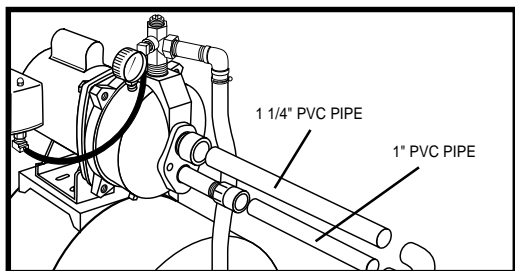

Cement as many sections and couplings of rigid 1" and 1-1/4" PVC pipe needed to connect the 1" female PVC adapter and the 1-1/4" male PVC adapter to the 1" and 1-1/4" PVC elbows. **The diaphragm pressure tank is factory preset to 30 PSI. Reset the pressure to 18 PSI using a tire gauge.** This is vital to the proper operation of the system. Remove pressure gauge plug.

**STEP 11** Place a large bucket beneath the pressure regulator outlet. Start motor. Turn regulator adjustment screw down tight. If pump is properly primed a high pressure will immediately show on the pressure gauge. With pump operating at high pressure, slowly unscrew regulator adjustment screw until maximum water flow is obtained without pressure dropping to zero. If pressure falls completely, retighten adjustment screw and re-adjust. **Steady pressure must not be less than 24 lbs. for the R520 and 32 lbs. for the R100. If no pressure shows:** Stop motor, remove pressure gauge plug from pressure regulator, add more water, and try again. Complete installation should look like the drawing to the right.

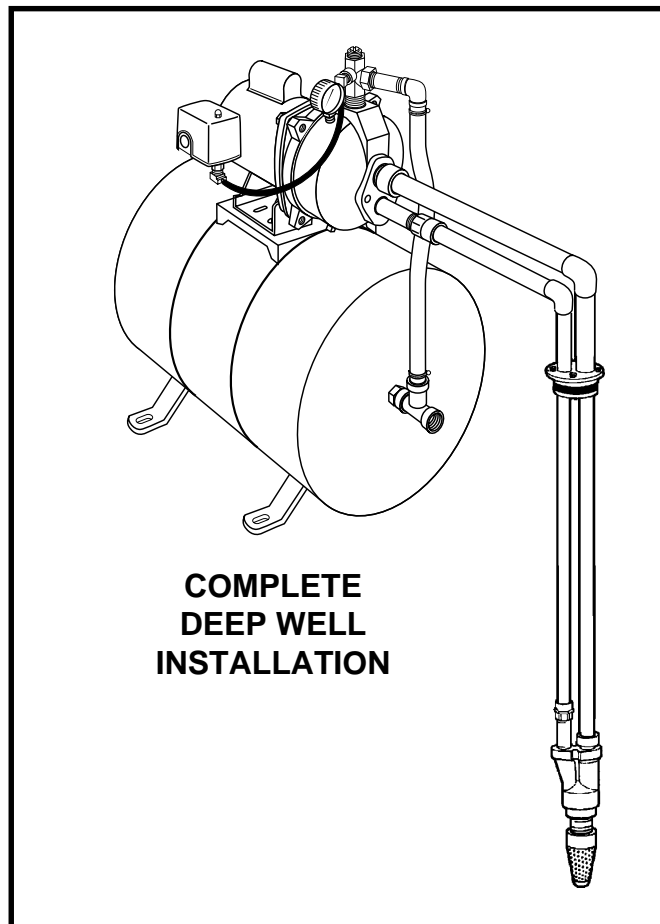
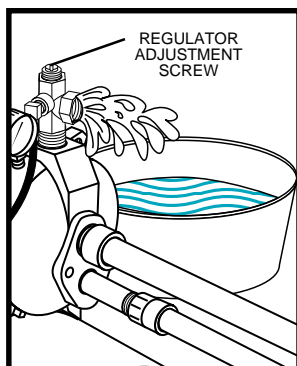

**CAUTION:** If you change pressure switch settings, set the cut-off pressure low enough to shut off the pump. The recommended pressure is 2 PSI below your pump cut-off pressure. Example: if a 20-40 PSI pressure switch is being used, tank pressure should be 18 PSI. If a valve shuts off and the cut-off setting is too high, the pump will run continuously without water flow causing overheating and serious damage.

# TROUBLESHOOTING CHECKLIST (CAUTION: SHUT OFF POWER TO PUMP)

PROBLEM	POSSIBLE CAUSES
<b>Pump will not prime</b>	<ul style="list-style-type: none"> <li>• Not enough water. Stop motor, remove pressure gauge plug, and fill case with water.</li> <li>• Pump wired incorrectly.</li> <li>• Plugged venturi tube or nozzle.</li> <li>• Foot valve is sitting in sand or mud, or is stuck shut, or leaks.</li> <li>• Low well water level. In deep wells, the ejector as well as the foot valve must be below water level.</li> <li>• Leaks. Check all connections for airtightness.</li> </ul>
<b>Pump delivers water for a period of time, then stops pumping</b>	<ul style="list-style-type: none"> <li>• Low well water level. Use a water-level tester while pump is operating.</li> <li>• Plugged venturi tube, nozzle, or impeller parts.</li> </ul>
<b>Pump does not deliver rated capacity</b>	<ul style="list-style-type: none"> <li>• Plugged venturi or nozzle.</li> <li>• Faulty pressure gauge resulting in false readings.</li> <li>• In deep wells, the operating pressure may be too high.</li> <li>• Low well water level. Use a water-level tester while pump is operating.</li> <li>• Over-submergence of ejector. In deep wells, if ejector is more than 10 feet below pumping level, pumping capacity is reduced.</li> <li>• In deep wells, the ejector may have improper size and depth setting.</li> </ul>
<b>Motor overheats and shuts off (overload)</b>	<ul style="list-style-type: none"> <li>• Motor voltage does not match power supply voltage. See pages 2 and 3.</li> <li>• Improper wire size. See Wire Size Guide on page 3.</li> <li>• Impeller is rubbing against pump case.</li> </ul>
<b>Pump delivers water but will not shut off</b>	<ul style="list-style-type: none"> <li>• Impeller neck is worn.</li> <li>• Defective pressure switch.</li> <li>• The tube connecting the two brass fittings may be clogged.</li> <li>• Tank precharge pressure too high. Tank precharge pressure must be 1-2 pounds less than switch turn-on setting.</li> <li>• In deep wells, the water level may be going below limit of ejector. Use water-level tester while pump is operating.</li> </ul>
<b>Pressure switch turns on and off every few seconds</b>	<ul style="list-style-type: none"> <li>• Galvanized storage tank is waterlogged.</li> <li>• Leaky foot valve.</li> <li>• Too much tank pressure.</li> </ul>
<b>Motor fails or does not operate properly</b>	<ul style="list-style-type: none"> <li>• If within Warranty, return pump/motor unit to place of purchase (with proof of purchase) for exchange.</li> </ul>

## LIMITED WARRANTY

WATER ACE PUMP CO. will repair or replace for the original user any portion of a new Water Ace product which proves defective due to materials or workmanship of WATER ACE PUMP CO. Contact the nearest authorized WATER ACE PUMP CO. dealer for warranty service. WATER ACE PUMP CO. shall possess the sole right to determine whether to repair or replace defective equipment, parts or components. THIS WARRANTY DOES NOT COVER DAMAGE DUE TO LIGHTNING OR OTHER CONDITIONS BEYOND THE CONTROL OF WATER ACE PUMP CO.

**PUMPS:** Warranted 12 months from date of purchase or 18 months from date of manufacture, whichever occurs first. Receipt and product date code required for warranty claim.

**LABOR & COSTS:** WATER ACE PUMP CO. shall IN NO EVENT be liable for the cost of field labor or other charges incurred by any customer in removing and/or reaffixing any WATER ACE PUMP product, part or component.

**THIS WARRANTY WILL NOT APPLY:** (a) to defects or malfunctions resulting from failure to properly install, operate, or maintain the unit in accordance with printed instructions provided; (b) to failures resulting from abuse, accident, or negligence; (c) to normal maintenance services and the parts used in connection with such service; (d) to units which are not installed in accordance with applicable local codes, ordinances, and good trade practices; (e) if the unit is moved from its original installation location; (f) if unit is used for purposes other than for what it was designed and manufactured.

**PRODUCT IMPROVEMENTS:** WATER ACE PUMP CO. reserves the right to change or improve its products or any component without obligation to provide such a change or improvement for units previously sold and/or shipped.

**WARRANTY EXCLUSIONS:** After the expiration of this warranty period, THERE WILL BE NO WARRANTIES INCLUDING ANY IMPLIED WARRANTIES OF MERCHANTABILITY OR FITNESS FOR ANY PARTICULAR PURPOSE ON ANY SPECIFIC WATER ACE PUMP PRODUCT. Some states do not allow limitations on how long an implied warranty lasts, so the above limitation may not apply to you. No warranties or representations at any time made by any representative of WATER ACE PUMP CO. shall vary or expand the provisions hereof.

**LIABILITY LIMITATION:** IN NO EVENT SHALL WATER ACE PUMP CO. BE LIABLE FOR CONSEQUENTIAL, INCIDENTAL OR SPECIAL DAMAGES RESULTING FROM OR RELATED IN ANY MANNER TO ANY WATER ACE PUMP PRODUCT OR PARTS. Some states do not allow the exclusion or limitation of incidental or consequential damages, so the above limitation may not apply to you. This Warranty gives you specific legal rights. You may have other rights which vary from state to state. In the absence of suitable proof of purchase date, the effective date of this warranty will be based upon the date of manufacture plus 180 days.

**Direct all Notices, etc. to: Product Warranty and Return Dept., WATER ACE PUMP CO., 1101 Myers Parkway, Ashland, OH 44805-1969**



# REPLACEMENT PARTS

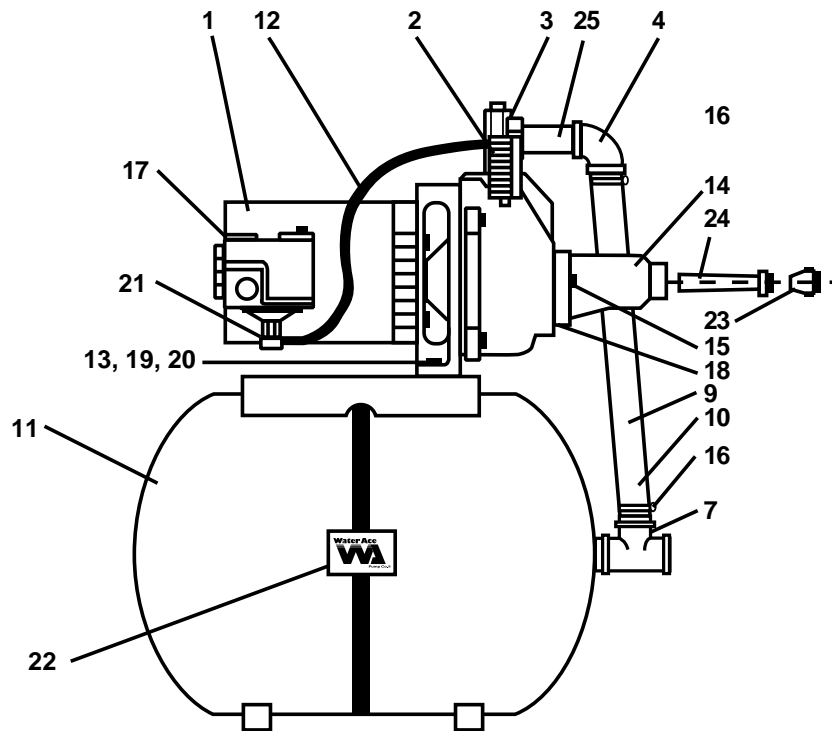

## JET TANK SYSTEM MODEL R-30-T7

REF. NO.	PART NUMBER	DESCRIPTION
1	20929D501	PUMP
2	05003A000	PRESSURE GAUGE
3	24349B000	REGULATOR
4	23188A005	HOSE ADAPTER
5	05004A015	BUSHING
6	05004A087	BUSHING
7	05126A013	PIPE TEE
8	05916A171	PIPE NIPPLE
9	05920A173	HOSE
10	06190A001	T.O.E. NIPPLE
11	25800A500	TANK
12	10649A120	TUBE
13	11933A002	SHIM (2 required)

REF. NO.	PART NUMBER	DESCRIPTION
14	24859C500	EJECTOR BODY
15	19101A019	SCREW (2 required)
16	14740A001	HOSE CLAMP (2 required)
17	15760A510	REGULATOR SWITCH
18	19277A001	GASKET
19	19100A029	SCREW (2 required)
20	19109A012	NUT (2 required)
21	23188A002	FITTING
22	25579A108	EMBLEM
23	08728A006	NOZZLE
24	25881A281	VENTURI TUBE
25	23188A001	FITTING

# REVISION TO PARTS LIST

---

If a 3/4" x 3/4" regulator is used, follow the replacement parts list found in the jet tank system installation manual.

If a 1" x 1" regulator is used, the following parts will be different than the parts list found in the jet tank system installation manual.

Ref. No.	Part Number	Description	Replaced by Part Number	Description
3	25443A000	3/4" Regulator	25443A001	1" Regulator
4	05762A055	3/4" x 1" Elbow	05762A009	1" Elbow
5	05004A016	3/4" x 1/4" Reducer Bushing	05004A035	1" x 1/4" Reducer Bushing
6	05004A087	3/4" x 1" Reducer Bushing	—	Not Required
8	05916A191	3/4" x 3" Nipple	05427A250	1" x 3-1/2" Nipple
21	23188A002	1/4" Barbed Fitting	23188A001	1/8" Barbed Fitting

**Retain these instructions for future reference.**



Water Ace Pump Co. • 1101 Myers Parkway • Ashland, OH 44805

## Free Manuals Download Website

<http://myh66.com>

<http://usermanuals.us>

<http://www.somanuals.com>

<http://www.4manuals.cc>

<http://www.manual-lib.com>

<http://www.404manual.com>

<http://www.luxmanual.com>

<http://aubethermostatmanual.com>

Golf course search by state

<http://golfingnear.com>

Email search by domain

<http://emailbydomain.com>

Auto manuals search

<http://auto.somanuals.com>

TV manuals search

<http://tv.somanuals.com>