

Acer TravelMate 2400/3210/3220/3230 Series

Service Guide

Service guide files and updates are available on the ACER/CSD web; for more information, please refer to <http://csd.acer.com.tw>

PRINTED IN TAIWAN

Revision History

Please refer to the table below for the updates made on TravelMate 2400/3210/3220/3230 service guide.

Date	Chapter	Updates
2005/08/22	Chapter 1, 4, 5, 6	Add docking spec. to Chapter 1, 5, 6. Add Insyde BIOS POST codes and POST messages to Chapter 4.
2005/09/30	Chapter 1, 2, 6	Add TravelMate 3230 specification.
2005/12/07	Chapter 1	Add environment conditions on page 3.

Copyright

Copyright © 2005 by Acer Incorporated. All rights reserved. No part of this publication may be reproduced, transmitted, transcribed, stored in a retrieval system, or translated into any language or computer language, in any form or by any means, electronic, mechanical, magnetic, optical, chemical, manual or otherwise, without the prior written permission of Acer Incorporated.

Disclaimer

The information in this guide is subject to change without notice.

Acer Incorporated makes no representations or warranties, either expressed or implied, with respect to the contents hereof and specifically disclaims any warranties of merchantability or fitness for any particular purpose. Any Acer Incorporated software described in this manual is sold or licensed "as is". Should the programs prove defective following their purchase, the buyer (and not Acer Incorporated, its distributor, or its dealer) assumes the entire cost of all necessary servicing, repair, and any incidental or consequential damages resulting from any defect in the software.

Acer is a registered trademark of Acer Corporation.

Intel is a registered trademark of Intel Corporation.

Pentium and Pentium II/III are trademarks of Intel Corporation.

Other brand and product names are trademarks and/or registered trademarks of their respective holders.

Conventions

The following conventions are used in this manual:

SCREEN MESSAGES	Denotes actual messages that appear on screen.
NOTE	Gives bits and pieces of additional information related to the current topic.
WARNING	Alerts you to any damage that might result from doing or not doing specific actions.
CAUTION	Gives precautionary measures to avoid possible hardware or software problems.
IMPORTANT	Reminds you to do specific actions relevant to the accomplishment of procedures.

Preface

Before using this information and the product it supports, please read the following general information.

1. This Service Guide provides you with all technical information relating to the BASIC CONFIGURATION decided for Acer's "global" product offering. To better fit local market requirements and enhance product competitiveness, your regional office MAY have decided to extend the functionality of a machine (e.g. add-on card, modem, or extra memory capability). These LOCALIZED FEATURES will NOT be covered in this generic service guide. In such cases, please contact your regional offices or the responsible personnel/channel to provide you with further technical details.
2. Please note WHEN ORDERING FRU PARTS, that you should check the most up-to-date information available on your regional web or channel. If, for whatever reason, a part number change is made, it will not be noted in the printed Service Guide. For ACER-AUTHORIZED SERVICE PROVIDERS, your Acer office may have a DIFFERENT part number code to those given in the FRU list of this printed Service Guide. You MUST use the list provided by your regional Acer office to order FRU parts for repair and service of customer machines.

System Specifications

Features

Below is a brief summary of the computer's many feature:

Platform and memroy

TravelMate 3210/TravelMate 3220/TravelMate 3230

Intel® Centrino™ Mobile Technology, featuring:

- Intel® Pentium® M Processor 730/740/750/760/770 (2 MB L2 cache, 1.60/1.73/1.86/2/2.13 GHz, 533 MHz FSB)
- Intel® Pentium® M Processor 725 (2MB L2 cache, 1.6 GHz, 400 MHz FSB)
- Intel® 915GM/PM Express chipset
- Wireless solution: integrated Intel® PRO/Wireless 2200BG network connection (dual-band 802.11b/g) Wi-Fi® CERTIFIED™ solution, supporting Acer SignalUp wireless technology

TravelMate 2400

- Intel® Pentium® M Processor 725 (2MB L2 cache, 1.6 GHz, 400 MHz FSB)
- Intel® Celeron® M Processor 350/360/370 (1 MB L2 cache, 1.30/1.40/1.50 GHz, 400 MHz FSB)
- Intel® 910GML Express chipset
- Wireless solution: integrated Intel® PRO/Wireless 2200BG network connection (dual-band 802.11b/g) Wi-Fi® CERTIFIED™ solution, supporting Acer SignalUp wireless technology
- Intel® 915GM/PM (for TravelMate 3210/3220/3230)/Intel® 910GML (for TravelMate 2400)+Intel ICH6-M (Mobile Intel 82801FB)
- 256/512 MB of DDR2 400/533 MHz memory, upgradeable to 2 GB using two soDIMM modules (dual-channel support)

Display

- 14.1 WXGA color TFT LCD, 1280 x 800 resolution; 16:10 viewing ratio, supporting simultaneous multi-window viewing on dual displays via Acer GridVista 16.7 million colors
- Intel® 915GM/PM (TravelMate 3210/3220/3230)/Intel® 910GML (TravelMate 2400) integrated 3D graphics, featuring Intel Graphics Media Accelerator 900 and up to 128 MB of VRAM, supporting Microsoft® DirectX® 9.0 and dual independent display
- ATI MOBILITY™ RADEON™ X700 with 64 MB or higher of dedicated VRAM, supporting ATI POWERPLAY™ 5.0, PCI Express™, Microsoft® DirectX® 9.0 and DualView (TravelMate 3210/3220/3230 only)
- MPEG-2/DVD hardware-assisted capability
- S-video/TV-out (NTSC/PAL) support (TravelMate 3210/3220/3230 only)

Storage subsystem

- 40/60/80 GB ATA/100 hard disk drive
- Optical drive options:
 - DVD-Super Multi double layer (TravelMate 3210/3220/3230)

-
- ▶DVD-Dual double layer (TravelMate 2400)
 - ▶DVD/CD-RW combo
 - 5-in-1 card reader (MS/MS PRO/MMC/SD/xD-Picture Card)

Input devices

- Acer FineTouch™ keyboard
- 84/85-key keyboard
- Touchpad with 4-way integrated scroll button
- Four easy-launch buttons
- Two front-access LED-buttons: WLAN and Bluetooth®

Audio

- Audio system with two built-in speakers
- MS-Sound compatible

Communication

- Modem: 56K ITU V.90/V.92 modem with PTT approval; wake-on ring ready
- LAN: 10/100/ (TravelMate 2400) or gigabit Ethernet (TravelMate 3210/3220/3230); wake-on ring ready
- WLAN: integrated 802.11b/g Wi-Fi® CERTIFIED™ solution (TravelMate 2400), or Intel® PRO/Wireless 2200BG network connection (dual-band 802.11b/g) Wi-Fi® CERTIFIED™ solution (TravelMate 3210/3220/3230)
- Acer SignalUp wireless technology support
- WPAN: integrated Bluetooth®

Human-centric design and ergonomics

- Rugged, yet extremely portable design
- Stylish appearance
- Full-size keyboard with four programmable launch keys
- Ergonomically-centered touchpad pointing device
- Acer FineTouch keyboard with a 5-degree curve
- Internet 4-way scroll button

I/O Ports

- Three USB 2.0 ports
- 5-in-1 card reader (MS/MS-PRO/MMC/SD/XD)
- PC Card slot (one Type II)
- IEEE 1394 port (TravelMate 3210/3220/3230)
- Fast infrared (FIR) port (TravelMate 3210/3220/3230)
- External display (VGA) port
- S-video/TV-out (NTSC/PAL) port (TravelMate 3210/3220/3230)
- Headphones/speaker/line-out port
- Microphone/line-in jack
- Ethernet (RJ-45) port
- Modem (RJ-11) port

-
- DC-in jack for AC adaptor
 - Acer ezDock (TravelMate 3220 only)

Dimensions and weight

- 335 (W) x 240 (D) x31.9/34.1 (H) mm (13.2 x 9.45 x 1.26/1.34 inches)
- TravelMate 3220: 2.6 Kg (5.73lbs)
- TravelMate 2400/3210: 2.25 kg (4.96 lbs)
- TravelMate 3230: 2.0 kg (4.4lbs)

Environment

- Temperature:
 - Non-operating: -20 degree C to 65 degree C
 - Operating: 5 degree C to 35 degree C
- Humidity:
 - Operating: 20%~80%
 - Non-operating: 20%~80%

System Block Diagram

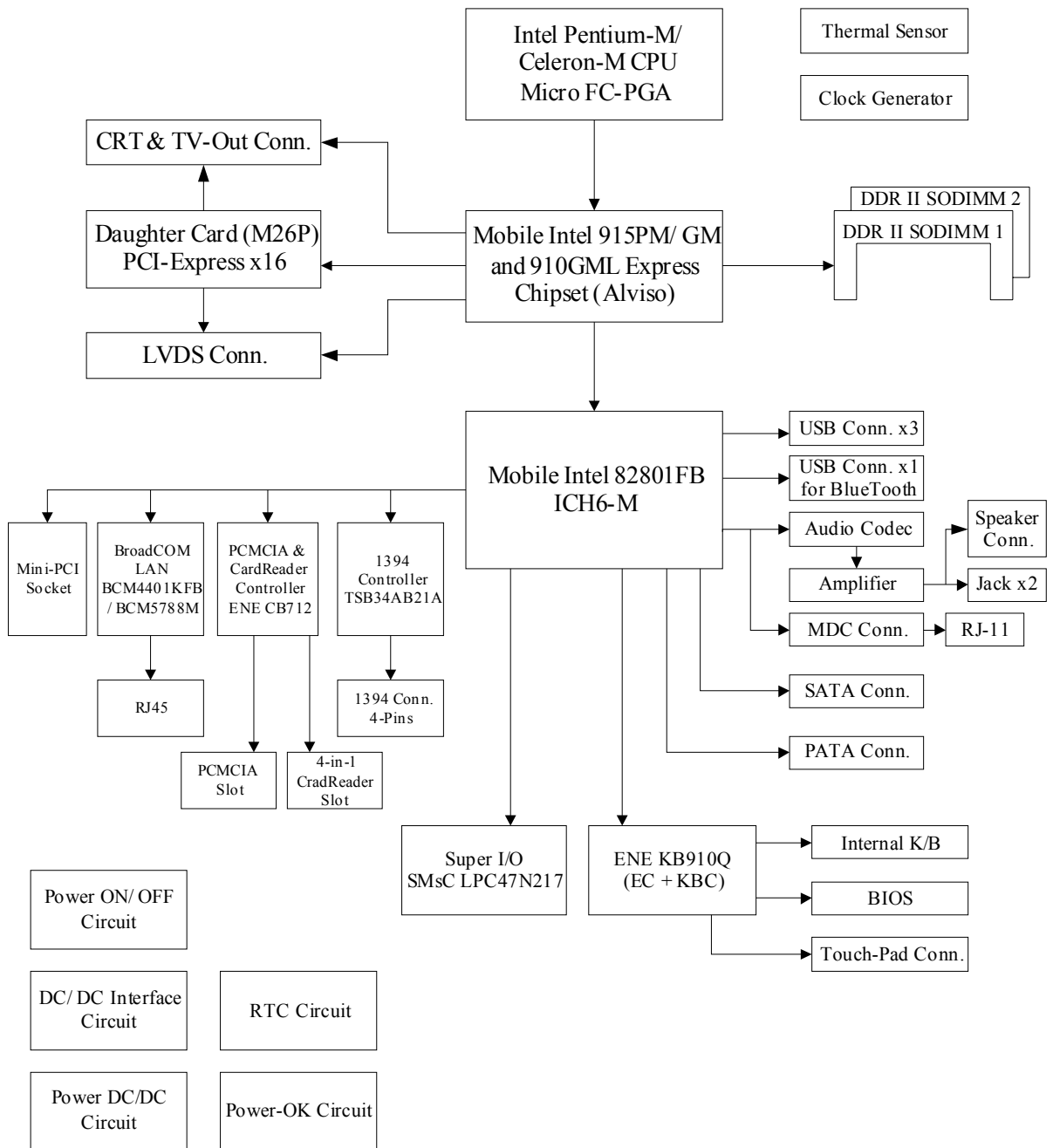

Board Layout

Top View

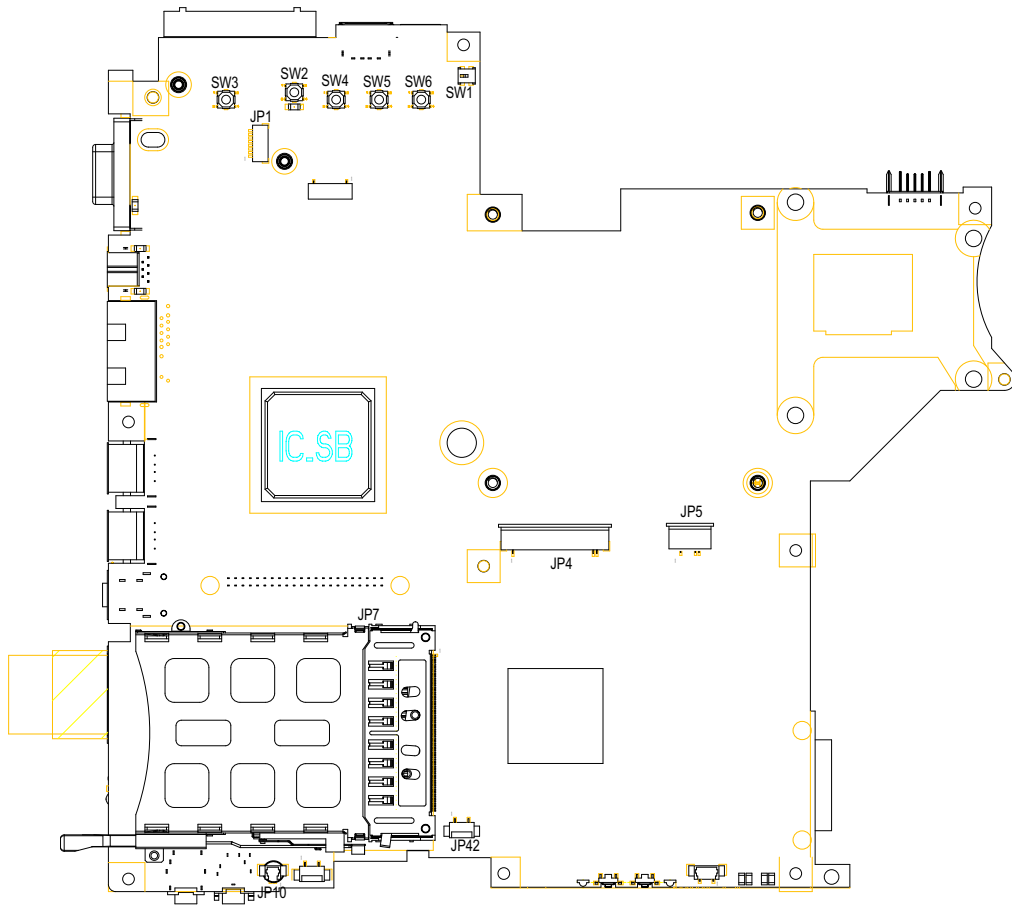

SW3	Power Switch	SW1	Lid Switch
JP1	Bluetooth Connector	JP5	Touchpad Connector
SW2	E-mail Switch	JP4	Keyboard Connector
SW4	Internet Browser Switch	JP42	Speaker Connector
SW5	Emanager Switch	JP7	PCMCIA Slot
SW6	User Programmable Switch	JP10	Microphone Connector

Bottom View

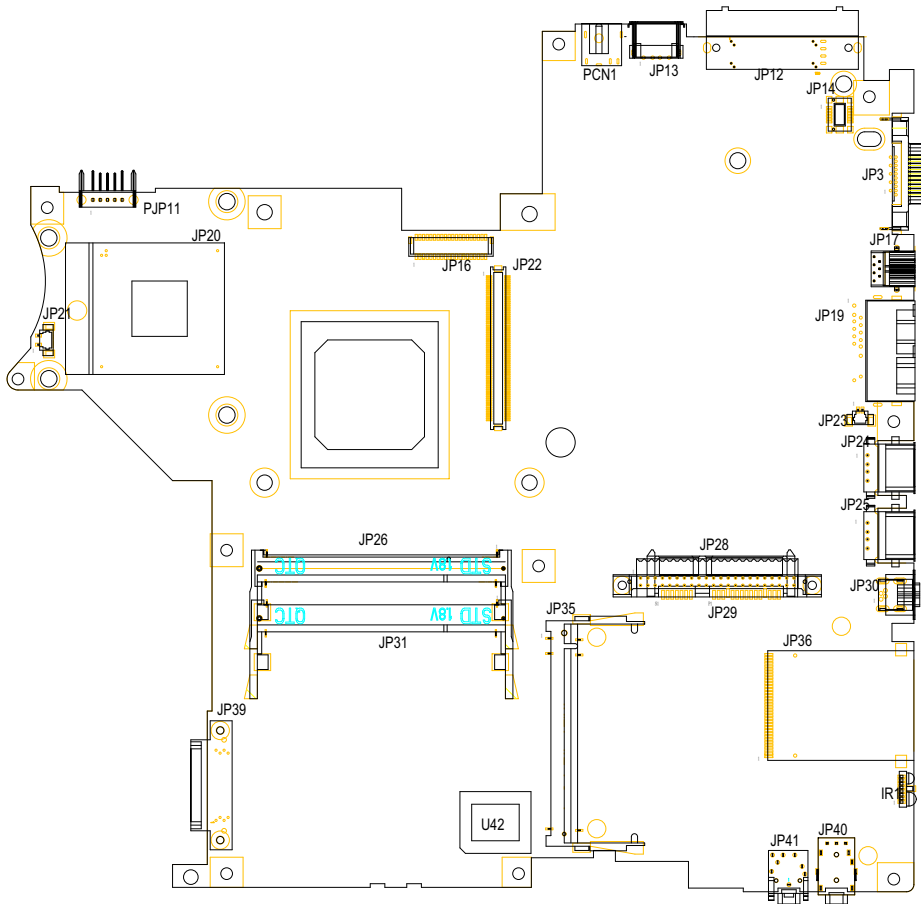

JP21	Fan Connector	JP24	USB Port
PJP11	Battery Connector	JP25	USB Port
JP20	CPU Socket	JP30	IEEE 1394 Port
JP16	LVDS Connector	JP36	Card Reader Connector
JP22	VGA Board Connector	IR	Infrared Receiver
PCN1	AC-IN	JP40	Headphone out/line-out Jack (support SPDIF)
JP13	USB Port	JP41	Mic-in Jack
JP12	Acer ezDock (for TravelMate 3220 only)	JP28	HDD Connector
JP14	Modem Board Connector	JP35	Wireless LAN Card Connector
JP3	External Display Port	U42	BIOS
JP17	S-Video Port	JP26	DDR2 Socket
JP19	RJ11/RJ45	JP31	DDR2 Socket
JP23	Modem Cable Connector	JP39	ODD Connector

A TravelMate tour

After knowing your computer features, let us show you around your new TravelMate computer.





Front View

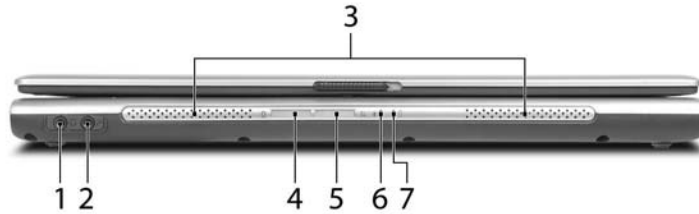

#	Icon	Item	Description
1		Display screen	Also called LCD (liquid-crystal display), displays computer output.
2		Power button	Turns the computer on and off.
3		Launch keys	Buttons for launching frequently used programs. See "Launch keys" section for more details.
4		Microphone	Internal microphone for sound recording.
5		Status indicators	Light-Emitting Diodes (LEDs) that turn on and off to show the status of the computer's functions and components.
6		Palmrest	Comfortable support area for our hands when you use the computer.
7		Click buttons (left, center and right)	The left and right buttons function like the left and right mouse buttons; the center button serves as a 4-way scroll button.
8		Touchpad	Touch-sensitive pointing device which functions like a computer mouse.
9		Keyboard	For entering data into your computer.

Closed Front View







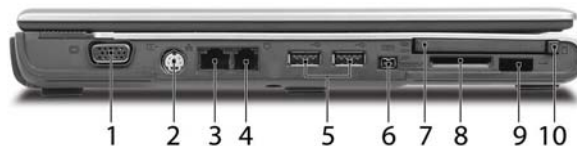



#	Icon	Item	Description
1		Speaker-out/line-out/Headphone jack	Connects to audio line-out devices (e.g., speakers, headphones).
2		Mic-in jack	Accepts inputs from external microphone.
3		Speakers	Left and right speakers deliver stereo audio output.
4		Bluetooth® communication button/indicator	Press to enable/disable Bluetooth function. Lights to indicate the status of Bluetooth communications (option only available for TravelMate 3210/3220/3230).
5		Wireless communication button/indicator	Press to enable/disable Wireless function. Lights to indicate the status of wireless LAN communications.
6		Power indicator	Lights when the computer is on.
7		Battery indicator	Lights when the battery is being charged

Left View



#	Icon	Item	Description
1		External display port	Connects a display device (e.g., external monitor, LCD projector).

2		S-video/TV-out port	Connects to a television or display device with S-video input (TravelMate 3210/3220/3230 only).
3		Network jack	Connects to an Ethernet 10/100/1000-based network.
4		Modem jack	Connects to a phone line.
5		Two USB 2.0 ports	Connects to USB 2.0 devices (e.g., USB mouse, USB camera).
6		IEEE 1394 port	Connects to IEEE 1394 devices (TravelMate 3210/3220/3230 only).
7		PC Card slot	Connects to one Type II PC Card.
8		5-in-1 card reader	Accepts and MS, MS PRO, MMC, SD, or xD-Picture card (manufacturing option). Note: Only one card can operate at any given time.
9		Infrared port	Interfaces with infrared devices like infrared printer and IR-aware computer (TravelMate 3210/3220/3230 only).
10		PC Card slot eject button	Ejects the PC Card from the slot.

Right View





#	Icon	Item	Description
1		Optical drive	Internal optical drive; accepts CDs or DVDs depending on the optical drive type.
2		LED indicator	Lights up when the optical drive is active.
3		Optical drive eject button	Ejects the optical drive tray from the drive.
4		Emergency eject hole	Ejects the optical drive tray when the computer is turned off.
5		Ventilation slots	Enable the computer to stay cool, even after prolonged use.
6		Security Keylock	Connects to a Kensington-compatible computer security lock.

Rear Panel



TravelMate 3210/3230 Rear View



#	Icon	Item	Description
1		Battery bay	Houses the computer's battery pack.
2		Power jack	Connects to an AC adaptor.
3			Connect to USB 2.0 devices (e.g., USB mouse, USB camera).

TravelMate 3220 Rear View



#	Icon	Item	Description
1		Battery bay	Houses the computer's battery pack.
2		Power jack	Connects to an AC adaptor.
3			Connect to USB 2.0 devices (e.g., USB mouse, USB camera).
4		Acer ezDock port	Connects to the Acer ezDock (TravelMate 3220 only)

Bottom Panel









#	Item	Description
1	Battery bay	Houses the computer's battery pack.
2	Battery lock	Locks the battery in place.
3	Cooling fan	Helps keep the computer cool. Note: Do not cover or obstruct the opening of the fan.
4	Memory compartment	Houses the computer's main memory.
5	Hard disk bay	Houses the computer's hard disk (secured by two screws).
6	Battery release latch	Releases the battery for removal.
7	Wireless LAN card compartment	Houses the computer's mini PCI.

Indicators

The computer has three easy-to-read status indicators on the upper-left above the keyboard, and four on the front panel.



The power, battery and wireless communication status indicators are visible even when the LCD display is closed.

Icon	Function	Description
	Cap lock	Lights when Cap Lock is activated
	Num lock	Lights when Num Lock is activated.
	Media Activity	Indicates when the hard disc or optical drive is active.
	Bluetooth	Indicates the status of Bluetooth communication.
	Wireless LAN	Indicates the status of wireless LAN communication.
	Power	Lights up when the computer is on.
	Battery	Lights up when the battery is being charged.

NOTE: 1. **Charging:** The light shows amber when the battery is charging. 2. **Fully charged:** The light shows green when in AC mode.

Launch Keys

Located at the upper-right, above the keyboard are four buttons. These buttons are called launch keys. They are: mail, Web browser, Acer Empowering key “*e*” and one user-programmable button.

Press “*e*” to run the Acer eManager. Please see “Acer eManager”. The mail and Web buttons are pre-set to email and Internet programs, but can be reset by users. To set the Web browser, mail and programmable keys, run the Acer Launch Manager.



Launch key	Default application
Mail	Email application (user-programmable)
Web browser	Internet browser (user-programmable)
<i>e</i>	Acer eManager (user-programmable)
P	User-programmable

Touchpad

The built-in touchpad is a pointing device that senses movement on its surface. This means the cursor responds as you move your finger across the surface of the touchpad. The central location on the palmrest provides optimum comfort and support.



Touchpad Basics

The following teaches you how to use the touchpad:



- ❑ Move your finger across the touchpad (2) to move the cursor.
- ❑ Press the left (1) and right (4) buttons located beneath the touchpad to perform selection and execution functions. These two buttons are similar to the left and right buttons on a mouse. Tapping on the touchpad is the same as clicking the left button.
- ❑ Use the 4-way scroll (3) button to scroll up or down and move left or right a page. This button mimics your cursor pressing on the right scroll bar of Windows applications.

Function	Left Button (1)	Right Button (4)	Main touchpad (2)	Center button (3)
Execute	Click twice quickly		Tap twice (at the same speed as double-clicking the mouse button)	
Select	Click once		Tap once	

Function	Left Button (1)	Right Button (4)	Main touchpad (2)	Center button (3)
Drag	Click and hold, then use finger to drag the cursor on the touchpad		Tap twice (at the same speed as double-clicking a mouse button) then hold finger to the touchpad on the second tap to drag the cursor.	
Access context menu		Click once		
Scroll				Click and hold to move up/down/left/right.

NOTE: Keep your fingers dry and clean when using the touchpad. Also keep the touchpad dry and clean. The touchpad is sensitive to finger movements. Hence, the lighter the touch, the better the response. Tapping too hard will not increase the touchpad's responsiveness.

Using the Keyboard

The keyboard has full-sized keys and an embedded keypad, separate cursor keys, two Windows keys and twelve function keys.

Lock Keys and embedded numeric keypad

The keyboard has three lock keys which you can toggle on and off.











Lock Key	Description
Caps Lock	When Caps Lock is on, all alphabetic characters typed are in uppercase.
Num lock <Fn>+<F11>	When Num Lock is on, the embedded keypad is in numeric mode. The keys function as a calculator (complete with the arithmetic operators +, -, *, and /). Use this mode when you need to do a lot of numeric data entry. A better solution would be to connect an external keypad.
Scroll lock <Fn>+<F12>	When Scroll Lock is on, the screen moves one line up or down when you press the up or down arrow keys respectively. Scroll Lock does not work with some applications.

The embedded numeric keypad functions like a desktop numeric keypad. It is indicated by small characters located on the upper right corner of the keycaps. To simplify the keyboard legend, cursor-control key symbols are not printed on the keys.

Desired Access	Num Lock On	Num Lock Off
Number keys on embedded keypad	Type numbers in a normal manner.	
Cursor-control keys on embedded keypad	Hold <Shift> while using cursor-control keys.	Hold <Fn> while using cursor-control keys.
Main keyboard keys	Hold <Fn> while typing letters on embedded keypad.	Type the letters in a normal manner.

Windows Keys

The keyboard has two keys that perform Windows-specific functions.







Key	Icon	Description
Windows key 		<p>Pressed alone, this key has the same effect as clicking on the Windows Start button; it launches the Start menu. It can also be used with other keys to provide a variety of function:</p> <ul style="list-style-type: none"> + <Tab> Activates next taskbar button. + <E> Opens the My Computer window + <F1> Opens Help and Support. + <F> Opens the Find: All Files dialog box. + <R> Opens the Run dialog box. + <M> Minimizes all windows. <p><Shift>+  + <M> Undoes the minimize all windows action.</p>
Application key		<p>This key has the same effect as clicking the right mouse button; it opens the application's context menu.</p>







Hot Keys

The computer employs hotkeys or key combinations to access most of the computer's controls like screen brightness, volume output and the BIOS utility.

To activate hot keys, press and hold the <Fn> key before pressing the other key in the hotkey combination.



Hot Key	Icon	Function	Description
Fn-F1	?	Hot key help	Displays help on hot keys.
Fn-F2		Acer eSetting	Launches the Acer eSettings in Acer eManager.
Fn-F3		Acer ePowerManagement	Launches the Acer ePowerManagement in Acer eManager.
Fn-F4	Z ^z	Sleep	Puts the computer in Sleep mode.
Fn-F5		Display toggle	Switches display output between the display screen, external monitor (if connected) and both.
Fn-F6		Screen blank	Turns the display screen backlight off to save power. Press any key to return.
Fn-F7		Touchpad toggle	Turns the internal touchpad on and off.
Fn-F8		Speaker toggle	Turns the speakers on and off.
Fn-F9		Volume up	Increases the speaker volume.

Hot Key	Icon	Function	Description
Fn- 		Volume down	Decreases the speaker volume.
Fn- 		Brightness up	Increases the screen brightness.
Fn- 		Brightness down	Decreases the screen brightness

Special Key

You can locate the Euro symbol and US dollar sign at the upper-center and/or bottom-right of your keyboard. To type:



The Euro symbol

1. Open a text editor or word processor.
2. Either directly press the <€> symbol at the bottom-right of the keyboard, or hold <Alt Gr> and then press the <5> symbol at the upper-center of the keyboard.

The US dollar sign

1. Open a text editor or word processor.
2. Either directly press the <\$> key at the bottom-right of the keyboard, or hold <Shift> and then press the <4> key at the upper-center of the keyboard.

NOTE: This function varies by the operating system version.

NOTE: Some fonts and software do not support the Euro symbol. Please refer to www.microsoft.com/typography/faq/faq12.htm for more information.

Hardware Specifications and Configurations

Processor

Item	Specification
CPU type	TravelMate 3210/TravelMate 3220/TravelMate 3230 Intel® Pentium® M Processor 730/740/750/760/770 (2 MB L2 cache, 1.60/1.73/1.86/2/2.13 GHz, 533 MHz FSB) Intel® Pentium® M Processor 725 (2MB L2 cache, 1.6 GHz, 400 MHz FSB) TravelMate 2400 Intel® Pentium® M Processor 725 (2MB L2 cache, 1.6 GHz, 400 MHz FSB) Intel® Celeron® M Processor 350/360/370 (1 MB L2 cache, 1.30/1.40/1.50 GHz, 400 MHz FSB)
Core logic	Intel® 915GM/PM (for TravelMate 3210)/Intel® 910GML (for TravelMate 2400)+Intel ICH6-M (Mobile Intel 82801FB)
CPU package	Intel socketable 478pin Micro-BGA
CPU core voltage	1.308V (highest frequency mode) to 0.956V (low frequency mode) 0.748V (deeper sleep mode)

BIOS

Item	Specification
BIOS vendor	Phoenix
BIOS Version	3A03
BIOS ROM type	SST 39SF040A, 512KX8 CMOS Boot Block Flash Memory
BIOS ROM size	512KB
BIOS package	32-pin PLCC
Supported protocols	ACPI 1.0b, PC Card 95, SM BIOS 2.3, IEEE1284-ECP/EPP, PCI 2.2, PnP 1.0a, DMI 2.0, PS/2 keyboard and mouse, USB 2.0, VGA BIOS, CD-ROM bootable, IEEE 1394
BIOS password control	Set by setup manual

Second Level Cache

Item	Specification
Cache controller	Built-in CPU
Cache size	1MB for Intel® Celeron® CPU/2MB for Intel® Pentium®
1st level cache control	Always enabled
2st level cache control	Always enabled
Cache scheme control	Fixed in write-back

System Memory

Item	Specification
Memory controller	Intel® 915GM/PM or Intel® 910GML built-in
Memory size	0MB (no on-board memory)
DIMM socket number	2 sockets
Supports memory size per socket	1024MB
Supports maximum memory size	2G (by two 1024MB SO-DIMM module)
Supports DIMM type	DDR Synchronous DRAM
Supports DIMM Speed	400 MHz/533 MHz
Supports DIMM voltage	2.5V and 1.25V

System Memory

Item	Specification
Supports DIMM package	200-pin soDIMM
Memory module combinations	You can install memory modules in any combinations as long as they match the above specifications.

Memory Combinations

Slot 1	Slot 2	Total Memory
0MB	128MB	128MB
0MB	256MB	256MB
0MB	512MB	512MB
0MB	1024MB	1024MB
128MB	128MB	256MB
128MB	256MB	384MB
128MB	512MB	640MB
128MB	1024MB	1152MB
256MB	128MB	384MB
256MB	256MB	512MB
256MB	512MB	768MB
256MB	1024MB	1280MB
512MB	128MB	640MB
512MB	256MB	768MB
512MB	512MB	1024MB
512MB	1024MB	1536MB
1024MB	0MB	1024MB
1024MB	128MB	1125MB
1024MB	256MB	1280MB
1024MB	512MB	1536MB
1024MB	1024MB	2048MB

NOTE: Above table lists some system memory configurations. You may combine DIMMs with various capacities to form other combinations. On above table, the configuration of slot 1 and slot 2 could be reversed.

LAN Interface

Item	Specification
Chipset	BroadCOM BCM5788M(10/100/1000M) TM3210/TM3220/TM3230; BCM4401KFB(10/100M)TM2400
Supports LAN protocol	10/100/1000Mbps
LAN connector type	RJ45
LAN connector location	Left side
Features	Integrated 10/100 BASE-T transceiver Wake on LAN support compliant with ACPI 2.0 PCI v2.2

IR Interface

Item	Specification
Part name	VISHAY TFU6102F
Package	8-pin SMT type

IR Interface

Item	Specification
Performance	4Mbit/s
Compliant	IrDA 1.1

Modem Interface

Item	Specification
Data modem data baud rate (bps)	56K
Supports modem protocol	V.90/V.92
Modem connector type	RJ11
Modem connector location	Left side

Bluetooth Interface

Item	Specification
Chipset	built-in Mobile Intel® 82801FB (ICH6-M)
Data throughput	723 bps (full speed data rate)
Protocol	Bluetooth 1.1 (Upgradeable to Bluetooth 1.2 when SIG specification is ratified).
Interface	USB 1.1
Connector type	Mini-USB

Wireless Module 802.11b/g (optional device)

Item	Specification
Chipset	built-in Mobile Intel® 82801FB (ICH6-M)
Data throughput	11~54 Mbps
Protocol	802.11b+g
Interface	Mini-PCI type II

5-in-1 card reader

Item	Specification
Chipset	ENE CB712
Protocol	support MS/MS PRO/MMC/SD/xD

Hard Disk Drive Interface

Item	Specification			
Vendor & Model Name	SEAGATE ST94019A Toshiba Pluto MK4025GAS	SEAGATE N2 ST960821A Toshiba Pluto MK6025GAS	SEAGATE N2 ST9808210A Toshiba Pluto MK8025GAS	SEAGATE ST9100822A TOSHIBA PLUTO MK1031GAS
Capacity (MB)	40000	60000	80000	100000
Bytes per sector	512	512	512	512
Data heads	2/2	3/4	4/4	4/4
Drive Format				
Disks	1/1	2/2	2/2	2/2

Hard Disk Drive Interface

Item	Specification			
Spindle speed (RPM)	4200/4200 RPM	4200/4200 RPM	4200/4200 RPM	4200/4200 RPM
Performance Specifications				
Buffer size	2MB/8192KB	8192KB	8192KB	8192KB
Interface	ATA/ATAPI-6; ATA-6	ATA/ATAPI-6; ATA-6	ATA/ATA-6; ATA-6	ATA/ATA-6; ATA-6
Max. media transfer rate (disk-buffer, Mbytes/s)	372	350	350	373
Data transfer rate (host~buffer, Mbytes/s)	100 MB/Sec. Ultra DMA mode-5	100 MB/Sec. Ultra DMA mode-5	100 MB/Sec. Ultra DMA mode-5	100 MB/Sec. Ultra DMA mode-5
DC Power Requirements				
Voltage tolerance	5V(DC) +/- 5%	5V(DC) +/- 5%	5V(DC) +/- 5%	5V(DC) +/- 5%

Combo Drive Interface

Item	Specification
Vendor & model name	Philips SCB5265+UJDA770
Performance Specification	With CD Diskette With DVD Diskette
Transfer rate (KB/sec)	Sustained: Max 3.6Mbytes/sec Sustained: Max 10.8Mbytes/sec
Buffer Memory	2MB
Interface	Enhanced IDE(ATAPI) compatible
Applicable disc format	Read: DVD: DVD-ROM, (DVD-5, DVD-9, DVD-10, DVD-18), DVD-Video, DVD-R (3.95 and 4.7G), DVD-RW, DVD+R, DVD+RW, Multi-Border DVD-R/DVD-RW, Multi-Session DVD+R, DVD+RW and DVD-RAM (optional) CD: CD-DA, CD-ROM Mode-1, CD-ROM/XA Mode-2 Form-1 and Mode-2 Form-2, CD-i Ready, Video-CD (MPEG-1), Karaoke CD, Super Video CD, Photo-CD, Enhanced CD, CD Plus, CD Extra, i-trax CD, CD-Text, CD-R, CD-RW Write: CD-DA, CD-ROM Mode-1CD-ROM/XA Mode-2 Form-1 and Mode-2 Form-2, CD-i, Video-CD, CD-Text
Loading mechanism	Load: Manual Release: (a) Electrical Release (Release Button) (b) Release by ATAPI command (c) Emergency Release
Power Requirement	
Input Voltage	5 V +/- 5 % (Operating)

DVD-Dual Interface

Item	Specification
Vendor & model name	DVD Dual Pioneer DVR-K15RA DVD Dual Pioneer DVR-K05RA LiteOn SOSW-833S Panasonic UJ-845
Performance Specification	With CD Diskette With DVD Diskette

DVD-Dual Interface

Item	Specification	
Transfer rate (KB/sec)	Sustained: Max 3.6Mbytes/sec	Sustained: Max 10.8Mbytes/sec
Buffer Memory	2MBytes	
Interface	Enhanced IDE(ATAPI) compatible	
Applicable disc format for LiteOn SOSW-833S	Read: DVD: DVD single/dual layer (PTP, OTP), DVD-R (3.9G/4.7G), DVD-R multi-borders, DVD-R Double Layer, DVD+R, DVD+R multi-sessions, DVD+R Double Layer, DVD-RW, and DVD+RW discs with diameter of 8 or 12cm CD: CD-DA, CD-ROM, CD-ROM/XA, Photo-CD, Multi-session, Karaoke-CD, Video-CD, CD-I FMV, CD Extra, CD Plus, CD-R, and CD-RW discs of 8 or 12 cm diameter	
Applicable disc format for Panasonic UJ-845	Read: DVD: DVD-5, 9,10,18, DVD-R (3.95G/4.7G), DVD-RW, DVD_RAM (4.7G), DVD+R, DVD+RW CD: CD-Audio, CD-ROM (mode1 and mode 2), CD-ROM XA (mode 2, form 1 and form 2), CD-I (mode 2, form 1 and form 2), CD-I Ready, CD-I Bridge, CD-R, CD-RW, Photo CD, Video CD, Enhanced Music CD, CD-TEXT Write: DVD: DVD-RAM, DVD-R4.7GB, DVD-RW, DVD+R, DVD+RW CD: CD-R, CD-RW (disc at once, sessionat once, track at once, fixed/variable packet writing, multi-session)	
Applicable disc format for Pioneer DVR-K15RA	KODAK Photo CD Single and Multi-session CD Extra (CD PLUS) Video CD CD text data (Read / Write) CD-R discs (Read / Write) CD-RW discs (Read / Write) DVD-ROM DVD-R Ver.2.00 for General (Read / Write) DVD-R-DL (Read/Write) DVD-RW Ver.1.0 & 1.1 & 1.2 (Read / Write) DVD+R Ver.1.0 & 1.11& 1.2 (Read/Write) DVD+R -DL Ver1.0 (Read / Write) DVD+RW Ver.1.1 & 1.2 (Read/Write) DVD-RAM (Ver.2.0 & 2.1) (Read only)	
Applicable disc format for Pioneer DVR-K05RA	KODAK Photo CD Single and Multi-session CD Extra (CD PLUS) Video CD CD text data (Read / Write) CD-R discs (Read / Write) CD-RW discs (Read / Write) DVD-ROM DVD-R Ver.2.00 for General (Read / Write) DVD-RW Ver.1.0 & 1.1 & 1.2 (Read / Write) DVD+R Ver.1.0 & 1.11& 1.2 (Read/Write) DVD+R -DL Ver1.0 (Read / Write) DVD+RW Ver.1.1 & 1.2 (Read/Write) DVD-RAM (Ver.2.0 & 2.1) (Read only)	
Loading mechanism	Load: Manual (SOSW-833S/DVR-K15) Auto (UJ-845/DVR-K05) Release: (a) Electrical Release (Release Button) (b) Release by ATAPI command (c) Emergency Release (Except for UJ-845/DVR-K05)	
Power Requirement		
Input Voltage	5 V +/- 5 % (Operating)	

Audio Interface

Item	Specification
Audio Controller	ALC250
Audio onboard or optional	Built-in
Mono or Stereo	Stereo
Resolution	18 bit stereo digital to analog converter 18 bit stereo analog to digital converter
Compatibility	AC97
Mixed sound source	Line-in, CD
Voice channel	8/16-bit, mono/stereo
Sampling rate	44,1 KHz (48K byte for AC97 interface)
Internal microphone	Yes
Internal speaker / Quantity	Yes/2

Video Interface

Item	Specification
Chipset	ATI Mobility RADEON® X700 (for discrete models)
Package	MBGA 708 pin
Interface	PCIE x16
Supports ZV (Zoomed Video) port	Yes

Video Memory

Item	Specification
Chipset	ATI Mobility RADEON® X700 (for discrete models)
Memory size	64MB/128MB
Interface	DDR

USB Port

Item	Specification
Chipset	built-in Mobile Intel® 82801FB (ICH6-M)
USB Compliancy Level	2.0
OHCI	USB 1.1 and USB 2.0 Host controller
Number of USB port	3
Location	two on the left side; one on the rear side
Serial port function control	Enable/Disable by BIOS Setup

IEEE 1394 Port

Item	Specification
Chipset	TSB34AB21A
Number of IEEE 1394 port	1
Location	Left side
Connector type	IEEE 1394

PCMCIA Port

Item	Specification
PCMCIA controller	ENE CB712
Supports card type	Type-II
Number of slots	One type-II
Access location	Left panel
Supports ZV (Zoomed Video) port	No ZV support
Supports 32 bit CardBus	Yes

System Board Major Chips

Item	Controller
Core logic	Intel® 915GM/PM (for TravelMate 3210/3220/3230)/Intel® 910GML (for TravelMate 2400)+Intel® ICH6-M (Mobile Intel 82801FB)
VGA	ATI Mobility RADEON® X700 (for discrete models)
LAN	BroadCom BCM4401(10/100M for TravelMate 2400); BCM5788M(1G for TravelMate 3210/TravelMate 3220/TravelMate 3230)
IEEE 1394	TSB34AB21A
USB 2.0	built-in Intel® ICH6-M (Mobile Intel 82801FB)
Super I/O controller	SMsC LPC 47N217
Bluetooth	built-in Intel® ICH6-M (Mobile Intel 82801FB)
Wireless 802.11 b+g	built-in Intel® ICH6-M (Mobile Intel 82801FB)
PCMCIA	ENE CB712
Audio	ALC250
5-in-1 card reader	ENE CB712

Keyboard

Item	Specification
Keyboard controller	KB 910Q
Total number of keypads	84-/85-key
Windows logo key	Yes
Internal & external keyboard work simultaneously	1. Plug USB keyboard to the USB port directly: Yes 2. Use port replicator then plug a USB/PS 2 keyboard to the USB port/PS 2 port on the port replicator: Yes

Battery

Item	Specification
Vendor & model name	BATTERY LI-ION 6 CELLS-SANYO 2000mAh UR18650F BATTERY LI-ION 6 CELLS-SONY 2000mAh US18650G4 BATTERY LI-ION 6 CELLS-SANYO 2400mAh UR18650F BATTERY LI-ION 6 CELLS-SONY 2400mAh US18650G7 BATTERY LI-ION 9 CELLS-SANYO 2400mAh UR18650F
Battery Type	Li-ion
Pack capacity	4800mAh 6cell and 7200mAh 9cell for TravelMate 3210 4000mAh 6cell for TravelMate 2400
Number of battery cell	53.3W 6cell and 79.9W 9cell for TravelMate 3210 44.6W 6cell for TravelMate 2400
Package configuration	3 cells in series, 2 series in parallel for 6-cell battery 2 cells in series, 3 series in parallel for 9-cell battery
Normal voltage	11.1V
Charge voltage	12.6+-0.1v

LCD 14.1 inch

Item	Specification		
Vendor & model name	QDI: QD14TL01 (Glare) Surface treatment: glare+hard coating 3H	QDI QD14TL01	CMO N14111-L03 CMO N14111-L02 (non-glare)
Screen Diagonal (mm)	14.1 inches	14.1 inches	14.1 inches
Active Area (mm)	303.7x189.8	303.7x189.8	303.3x189.6
Display resolution (pixels)	1280x800 WXGA	1280x800 WXGA	1280x800 WXGA
Pixel Pitch	0.2373x0.2373	0.2373x0.2373	0.2373x0.2373
Pixel Arrangement	R.G.B. Vertical Stripe	R.G.B. Vertical Stripe	R.G.B. Vertical Stripe
Display Mode	Normally White	Normally White	Normally White
Typical White Luminance (cd/m ²) also called Brightness	185	185	185
Luminance Uniformity	1.25 (5 points)	1.25 (5 points)	N/A
Contrast Ratio	300	300	400
Response Time (Optical Rise Time/Fall Time)msec	10/15	10/15	5/11
Nominal Input Voltage VDD	+3.3V Typ.	+3.3V	+3.3V
Typical Power Consumption (watt)	N/A	N/A	N/A
Weight	440g	440g	425g
Physical Size(mm)	320x206x5.5	320x206x5.5	320x206x5.5
Electrical Interface	1 channel LVDS	1 channel LVDS	1 channel LVDS

LCD 14.1 inch

Item	Specification		
Support Color	262K colors (RGB 6-bit data driver)	262,144	262,144
Viewing Angle (degree) Horizontal: Right/Left Vertical: Upper/Lower	45/45 20/35	45/45 20/35	45/45 20/45
Temperature Range(° C) Operating Storage (shipping)	0 to +40 (with high humidity more than 90%RH) -25 to +60	0 to +40 (with high humidity more than 90%RH) -25 to +60	0 to +40 (with high humidity more than 90%RH) -20 to +60

LCD Inverter

Item	Specification
Vendor & model name	Delta DAC-07B037 B YEC YNV-C01 SumidaTWS-442-125
Brightness conditions	Vadj=3.3V
Input voltage (V)	9~21
Input current (mA)	350 (max)
Output voltage (V, rms)	1600 (starting voltage)
Output current (mA, rms)	6.2~6.8 (DAC=0)
Output voltage frequency (k Hz)	45~65K Hz

AC Adaptor

Item	Specification
Input rating	90V AC to 264V AC, 47Hz to 63Hz
Maximum input AC current	1.7A
Inrush current	240A@115VAC 240A@230VAC
Efficiency	83% min. @115VAC input full load

System Power Management

ACPI mode	Power Management
Mech. Off (G3)	All devices in the system are turned off completely.
Soft Off (G2/S5)	OS initiated shutdown. All devices in the system are turned off completely.
Working (G0/S0)	Individual devices such as the CPU and hard disc may be power managed in this state.
Suspend to RAM (S3)	CPU set power down VGA Suspend PCMCIA Suspend Audio Power Down Hard Disk Power Down CD-ROM Power Down Super I/O Low Power mode
Save to Disk (S4)	Also called Hibernate state. System saves all system states and data onto the disc prior to power off the whole system.

System Utilities

BIOS Setup Utility

The BIOS Setup Utility is a hardware configuration program built into your computer's BIOS (Basic Input/Output System).

Your computer is already properly configured and optimized, and you do not need to run this utility. However, if you encounter configuration problems, you may need to run Setup. Please also refer to Chapter 4 Troubleshooting when problem arises.

To activate the BIOS Utility, press **F2** during POST (when "Press <F2> to enter Setup" message is prompted on the bottom of screen).

Press **F2** to enter setup. The default parameter of F12 Boot Menu is set to "disabled". If you want to change boot device without entering BIOS Setup Utility, please set the parameter to "enabled".

Press <F12> during POST to enter multi-boot menu. In this menu, user can change boot device without entering BIOS SETUP Utility.

Navigating the BIOS Utility

There are six menu options: Info., Main, System Devices, Security, Boot, and Exit.

Follow these instructions:

- To choose a menu, use the cursor left/right keys (← →).
- To choose a parameter, use the cursor up/down keys (↑ ↓).
- To change the value of a parameter, press F5 or F6.
- A plus sign (+) indicates the item has sub-items. Press ENTER to expand this item.
- Press ESC while you are in any of the menu options to go to the Exit menu.
- In any menu, you can load default settings by pressing F9. You can also press F10 to save any changes made and exit the BIOS Setup Utility.

Insyde Software SCUSep 20, 2005 11:40:09 AM

MainAdvancedSecurityBootExit

-----Devices-----

Product Name = TravelMate 3210 Light

Manufacture Name = Acer

BIOS Version = V1.00

VGA Version = 3104

HDD Model Name = HTC426040G9AT00

HDD Serial Number = 4EB660

ATAPI Model Name = MATSHITADVD-RAM UJ-832S

Serial Number = (32 bytes)

Asset Tag = (32 bytes)

UUID = (16 bytes)

-----System-----

CPU = Intel® Pentium® M

CPU speed = 1.73 GHz

L2 Cache = 2048 KB

-----Memory-----

System Memory = 640 KB

Extended Memory = 247MB

VGA Memory = 8 MB

Setup system date, time. Enable boot logo and get system information.

NOTE: You can change the value of a parameter if it is enclosed in square brackets. Navigation keys for a particular menu are shown on the bottom of the screen. Help for parameters are found in the Item Specific Help part of the screen. Read this carefully when making changes to parameter values. **Please note that system information vary in models.**

Main

Insyde Software SCU		Sep 20, 2005 11:40:09 AM	
Main	Advanced	Security	Boot
		Exit	
<p>-----Devices-----</p> <p>Product Name = TravelMate 3210 Light</p> <p>Manufacture Name = Acer</p> <p>BIOS Version = V1.00</p> <p>VGA Version = 3104</p> <p>HDD Model Name = HTC426040G9AT00</p> <p>HDD Serial Number = 4EB660</p> <p>ATAPI Model Name = MATSHITADVD-RAM UJ-832S</p> <p>Serial Number = (32 bytes)</p> <p>Asset Tag = (32 bytes)</p> <p>UUID = (16 bytes)</p>	<p>-----System-----</p> <p>CPU = Intel® Pentium® M</p> <p>CPU speed = 1.73 GHz</p> <p>L2 Cache = 2048 KB</p> <p>-----Memory-----</p> <p>System Memory = 640 KB</p> <p>Extended Memory = 247MB</p> <p>VGA Memory = 8 MB</p>		
<p>Setup system date, time. Enable boot logo and get system information.</p>			

NOTE: The system information is subject to different models.

Parameter	Description
Product Name	This field displays the product name of the system.
Manufacturer Name	This field displays the manufacturer name of the system
BIOS Version	This field displays the BIOS version of the system.
VGA Version	This field shows the VGA firmware version of the system.
HDD Model Name	This field shows the model name of HDD installed on primary IDE master.
HDD Serial Number	This field displays the serial number of HDD installed on primary IDE master.
ATAPI Mode Name	This field displays the model name of devices installed on secondary IDE master. The hard disk drive or optical drive model name is automatically detected by the system.
Serial Number	This field displays the serial number of this unit.
Asset Tag	This field displays the asset tag of this unit.
UUID	This will be visible only when an internal LAN device is presenting. UUID=32bytes
CPU	This field shows the brand name of the system CPU.

Parameter	Description
CPU speed	
L2 Cache	This field displays CPU L2 cache size. It varies in CPU type.
System Memory	This field reports the memory size of system base memory. The size is fixed to 640 KB.
Extended Memory	This field reports the memory size of the extended memory in the system. Extended memory size = Total memory size - 2MB
VGA Memory	VGA Memory size: Discrete = 64 or 128MB (depends on actual VRAM size) TurboCache = 32MB (actual TurboCache VRAM size) Intel(R) 915 DVMT: you can select the following options: 1. 64MB (8MB pre-allocated + 56MB DVMT) 2. 128MB (8MB pre-allocated + 128MB DVMT)- Default value 3. Max DVMT (160MB on 256MB system memory, 224MB on 512 and above system memory).

The Main screen displays a summary of your computer hardware information, and also includes basic setup parameters. It allows the user to specify standard IBM PC AT system parameters.

Insyde Software SCU		Sep 30, 2005 11:40:09 AM
Main	Advanced	Security Boot Exit
Date and Time	<div style="border: 1px solid black; padding: 10px; text-align: center;"> <p>-----Power On Display-----</p> <div style="border: 1px solid black; padding: 5px; margin: 10px auto; width: 80%;"> <p>(•) Auto</p> <p>() Both</p> </div> <p>OK Cancel</p> </div>	
Power On Display		
v Quiet Boot		
v LCD Auto DIM		
v Network Boot		
_ F12 Boot Menu		
v D2D Recovery		
<p>Press <Tab> key to select a control. <OK> button or <Enter> key accept entries. <Cancel> button or <Esc> key reject entries. Use cursor, spacebar, and numeric keys to change values. <Alt> key activates accelerators.</p>		

NOTE: The screen above is for your reference only. Actual values may differ.

The table below describes the parameters in this screen. Settings in **boldface** are the default and suggested parameter settings.

Parameter	Description	Format/Option
Date and Time	The hours are displayed with 12 hour format. The values set in these two fields take effect immediately.	
Quiet Boot	Determines if the system will display customer logo and summary screen or not. Enable: Customer logo is displayed, and summary screen is disabled. Disabled: Customer logo is not displayed, and summary screen is enabled.	Option: Enabled or Disabled
Power on display	Auto: During power process, the system will detect if any display device is connected on external video port. If any external display device is connected, the power on display will be in CRT (or projector) only mode. Otherwise it will be in LCD only mode. Both: Simultaneously enable both the integrated LCD screen and the system's external video port (for an external CRT or projector).	Option: Auto or Both
LCD Auto Dim	Determines if the system will automatically dim the LCD brightness in order to save power when AC is not present. The system will support an automatic dimming of the LCD backlight when the AC power is NOT available (running on battery power).	Option: Enabled or Disabled
Network Boot	Enables, disables the system boot from LAN (remote server).	Option: Enabled or Disabled
F12 Boot Menu	Enables, disables Boot Menu during POST.	Option: Disabled or Enabled
D2D Recovery	Enables, disables D2D Recovery function. The function allows the user to create a hidden partition on hard disc drive to store operation system and restore the system to factory defaults.	Option: Enabled or Disabled

NOTE: You can also enable Acer disc-to-disc system recovery via Alt+F10 during POST.

Advanced

The Advanced menu screen contains parameters involving your hardware devices. It also provides advanced settings of the system.

Insyde Software SCU Sep 30, 2005 11:40:09 AM

Main **Advanced** Security Boot Exit

Infrared Port (IR)

Max. Graphics Memory

Legacy USB Support

-----Infrared Port(FIR)-----

-----FIR I/O settings---

Disabled

Enabled

-Mode Setting for IRDA-

Normal (16550)

IrDA (HPSIR)

ASK IR

FAST IR

DMA Setting For FIR

DMA1

DMA2

DMA3

OK Cancel

<Tab> <Right> <Left> for block select. <Up> <Down> for item select.
<Enter> for accept. <Cancel> <Esc> for reject. <Alt> activates accelerators.
<Space> for Enable or Disable.

The table below describes the parameters in the screen. Settings in **boldface** are the default and suggested parameter settings.

Parameter	Description	Options
Infrared Port	Enables or disables the infrared port.	Disabled /Enabled
Max Graphics Memory	This option is only available on Intel (R) 915 UMA system.	64MB/ 128MB /DVMT
Legacy USB support	This feature allows you to USB keyboard entering BIOS Setup. This feature also allows you to use a USB keyboard in DOS without additional driver. USB floppy boot and Crisis Recovery from USB floppy is also supported.	Enabled /Disabled

Security

The Security screen contains parameters that help safeguard and protect your computer from unauthorized use.

Insyde Software SCU		Sep 30, 2005 11:40:09 AM	
Main	Advanced	Security	Boot Exit
	Set User Password		
	Set Supervisor Password		
	_ Lock HardDisk Drive	-----Set Supervisor password-----	
		Enter old Supervisor password:	
		Enter new Supervisor Password:	
		Verify new Supervisor Password:	
		[] Boot System	
		OK Cancel	

Enter new password. Password will NOT be displayed

The table below describes the parameters in this screen. Settings in **boldface** are the default and suggested parameter settings.

Set Supervisor/User Password

If password on boot is required, the password must be set otherwise it cannot be enabled.

The formats of the password are as follows:

Length 10 characters

Characters Alphanumeric keys only. The shift status i.e. Ctrl, Shift, Alt and Capital are ignored.

Parameter	Description	Option
Set User Password	Press Enter to set the user password. When set, this password protects the BIOS Setup Utility from unauthorized access.	
Set Supervisor Password	Press Enter to set the administrator password. When set, this password protects the BIOS Setup Utility from unauthorized access.	
Lock HardDisk Drive	Allows the user to specify whether or not a password is required to access hard disk drive.	Disabled or Enabled

NOTE: When you are prompted to enter a password, you have three tries before the system halts. Don't forget your password. If you forget your password, you may have to return your notebook computer to your dealer to reset it.

Boot

This menu allows the user to decide the order of boot devices to load the operating system. Bootable devices includes the distette drive in module bay, the onboard hard disk drive and the CD-ROM in module bay.

Insyde Software SCU			Se[30, 2005 11:40:09 AM	
Main	Advanced	Security	Boot	Exit
			Boot Device	
<div style="border: 1px solid black; padding: 10px; margin: 10px auto; width: 80%;"><p>----- Boot Device -----</p><p>Hard Drive</p><p>CD-ROM/DVD Drive</p><p>Floppy Device</p><p>Network Boot</p></div>				
<p>Press <Tab> key to select a control. <OK> button or <Enter> key accept entries. <Cancel> button or <ESC> key reject entries. Use spacebar and number keys to change value <Alt> key activates accelerators.</p>				

Exit

The Exit screen contains parameters that help safeguard and protect your computer from unauthorized use.

Insyde Software SCU				Sep 30, 2005 11:40:09
Main	Advanced	Security	Boot	Exit
				Exit Saving Changes
				Exit Discarding Changes
				Load Setup Defaults
				Discard Changes
<div style="border: 2px solid cyan; padding: 10px; text-align: center;"> <p>-----Exit Saving Changes-----</p> <p>Press <OK> to save the current Setup parameters to CMOS RAM.</p> <p>The system will reboot!!!</p> <div style="display: flex; justify-content: space-around; margin-top: 10px;"> <div style="border: 1px solid black; padding: 5px 15px;">OK</div> <div style="border: 1px solid black; padding: 5px 15px;">Cancel</div> </div> </div>				
<p><Tab> <Right> <Left> for block select. <Up> <Down> for item select. <Enter> for accept. <Cancel> <Esc> for reject. <Alt> activates accelerators. <Space> for Enable or Disable.</p>				

The table below describes the parameters in this screen.

Parameter	Description
Exit Saving Changes	Exit System Setup and save your changes to CMOS.
Exit Discarding Changes	Exit utility without saving setup data to CMOS.
Load Setup Default	Load default values for all SETUP item.
Discard Changes	Load previous values from CMOS for all SETUP items.

BIOS Flash Utility

The BIOS flash memory update is required for the following conditions:

- New versions of system programs
- New features or options
- Restore a BIOS when it becomes corrupted.

Use the Phlash utility to update the system BIOS flash ROM.

NOTE: If you do not have a crisis recovery diskette at hand, then you should create a **Crisis Recovery Diskette** before you use the Phlash utility.

NOTE: Do not install memory-related drivers (XMS, EMS, DPMS) when you use the Phlash.

NOTE: Please use the AC adaptor power supply when you run the Phlash utility. If the battery pack does not contain enough power to finish BIOS flash, you may not boot the system because the BIOS is not completely loaded.

Follow the steps below to run the Phlash.

1. Prepare a bootable diskette.
2. Copy the Phlash utilities to the bootable diskette.
3. Then boot the system from the bootable diskette. The Phlash utility has auto-execution function.

Remove BIOS Password

Please find J3 jumper on the main board. Then short the jumper to remove BIOS supervisor password. J3 locates under the memory module. Please see the image below.



Machine Disassembly and Replacement

This chapter contains step-by-step procedures on how to disassemble the notebook computer for maintenance and troubleshooting.

To disassemble the computer, you need the following tools:

- Wrist grounding strap and conductive mat for preventing electrostatic discharge
- Small Philips screw driver
- Philips screwdriver
- Plastic flat head screw driver
- Tweezers

NOTE: The screws for the different components vary in size. During the disassembly process, group the screws with the corresponding components to avoid mismatch when putting back the components. When you remove the stripe cover, please be careful not to scrape the cover.

General Information

Before You Begin

Before proceeding with the disassembly procedure, make sure that you do the following:

1. Turn off the power to the system and all peripherals.
2. Unplug the AC adapter and all power and signal cables from the system.
3. Remove the battery pack.

Disassembly Procedure Flowchart

The flowchart on the succeeding page gives you a graphic representation on the entire disassembly sequence and instructs you on the components that need to be removed during servicing. For example, if you want to remove the system board, you must first remove the keyboard, then disassemble the inside assembly frame in that order.

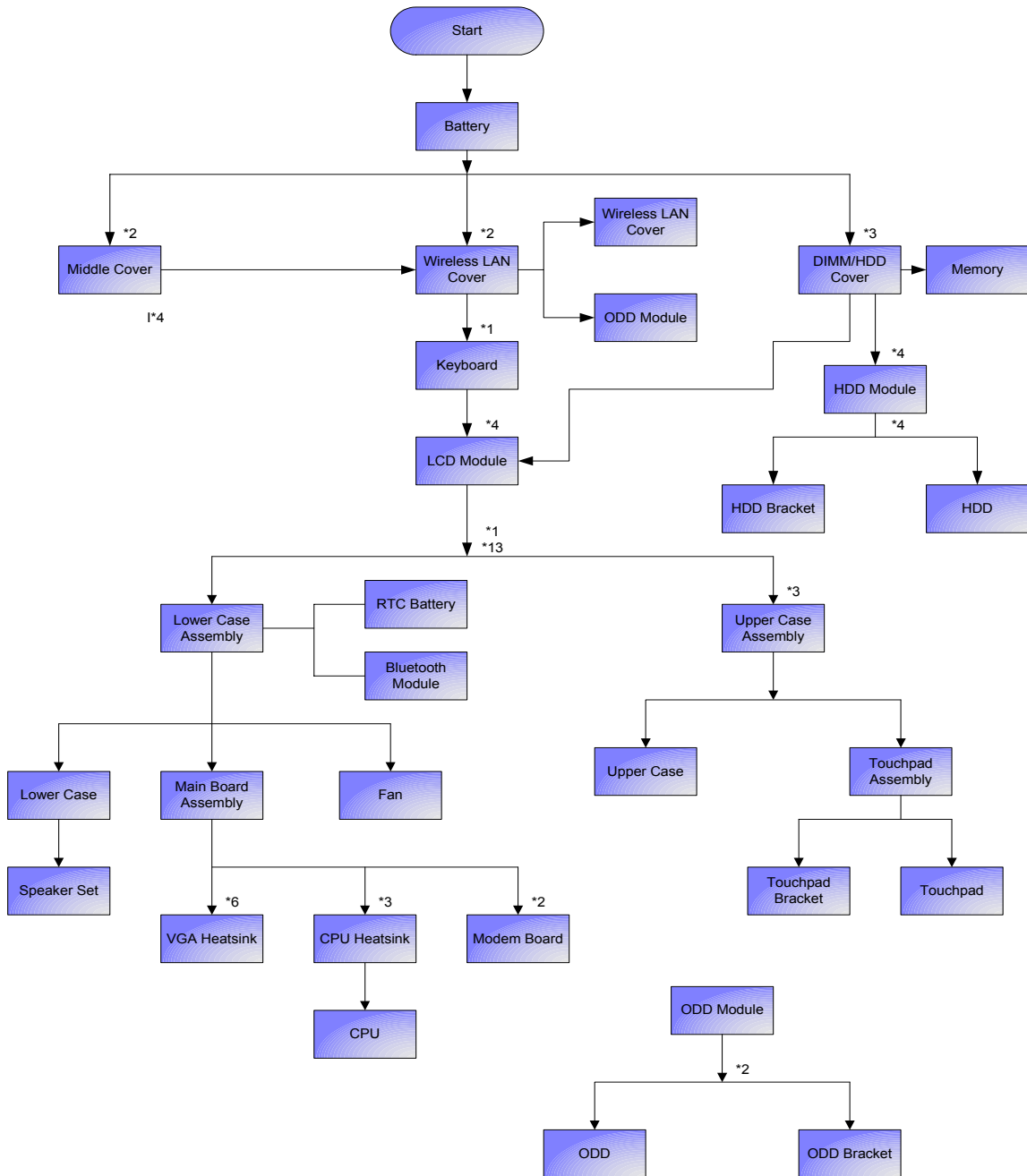

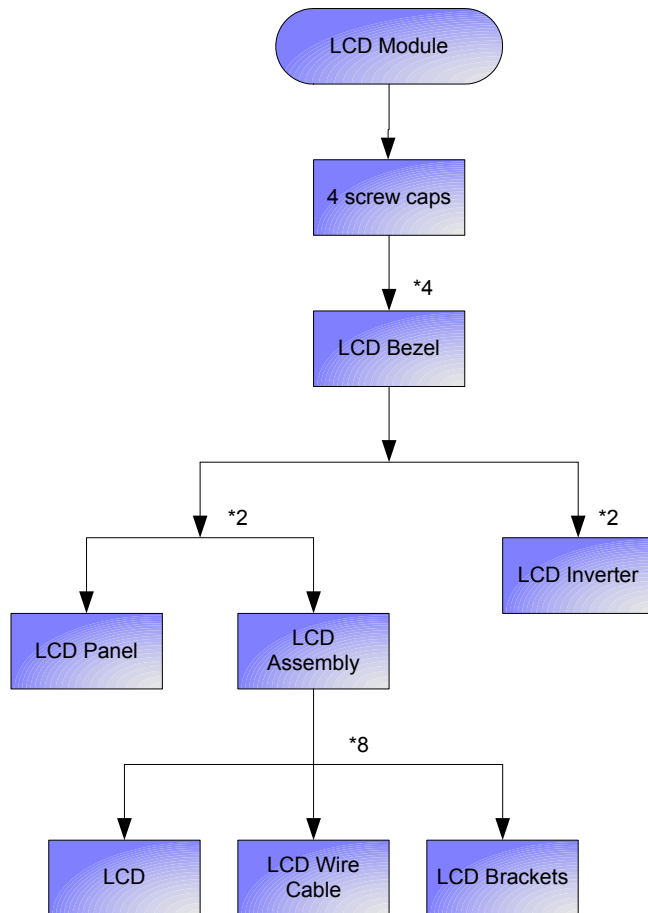

Screw List

Item	Description
A	SCW HEX NYL I#R-40/O#4-40 L5.5
B	SCREW MACH WAFER M2*L4 NI
C	CPU SCREW M2.5*6.5 (2.7KG)
D	CPU SCREW M2.5*6.5 (4.5KG)
E	SCRW WH MS+CBZ M2.5+L4 BLACK
F	SCREW M2.5-6
G	SCREW M2*3 NYLON 1JMCPC-420325
H	SCREW M2.5X6
I	SCREW M2-3
J	SCRW M2.5*L3(NON NYLOK)
K	SCREW M2.5-5
L	SCREW M3x4(86.9A524.4R0)
M	SCREW WAFER NYLOK NI 2ML3
N	SCREW NI M2*6L

Removing the Battery Pack

1. Unlock the battery lock.
2. Slide the battery latch then remove the battery.



Removing the Wireless LAN Card/the HDD Module/the Memory/the CPU/ the ODD Module and the LCD Module

Removing the Wireless LAN Card and the HDD Module

1. Remove the two screws fastening the PCI door.
2. Detach the PCI door.



3. Disconnect the wireless antennae.
4. Pop out the wireless LAN card then remove it.



5. Remove the two screws fastening the HDD cover.
6. Remove HDD cover carefully.
7. Pull the HDD module backwards to disconnect the HDD module then remove it from the main unit.

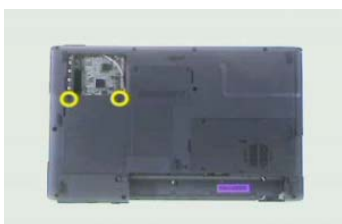

Removing the Memory and the CPU

1. Remove the two screws fastening DIMM cover.
2. Then detach the DIMM cover.
3. Pop out the memory then remove it from the DIMM socket.



4. Remove the two screws fastening the thermal door.
5. Detach the thermal door from the main unit.



6. Remove the four screws holding the thermal module. (Follow the order indicated by the numbers: 4, 3, 2 then 1. Please reverse the order when you assemble the system).
7. Disconnect the fan cable as shown.
8. Take out the thermal module from the main unit carefully.



9. Use a flat headed screwdriver to release the CPU lock.
10. Then remove the CPU from the CPU socket carefully.



Removing the ODD Module and the LCD module

1. Remove the screws fastening the ODD module as shown.
2. Use a flat headed screwdriver to push the ODD module outwards then remove it.



3. Open the LCD module as shown and detach the middle cover carefully.
4. Remove the two screws fastening the keyboard.



5. Turn over the keyboard as shown.
6. Disconnect the keyboard cable then remove the keyboard.

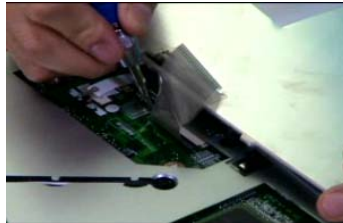

7. Tear off the mylar festening the wireless antenna set.
8. Pull out the wireless antenna from the main unit carefully.
9. Disconnect the LCD cable from the main board.



10. Remove two screws holding the LCD module.
11. Remove another two screws fastening the LCD module on the bottom.
12. Then detach the LCD module from the main unit carefully.



Disassembling the Main Unit

Separate the Main Unit Into the Upper and the Lower Case Assembly

1. To separate the upper and the lower case assembly, remove six screws as shown.
2. Turn over the main unit, remove 9 screws on the other side.
3. Separate the main unit into the upper case assembly and the lower case assembly.

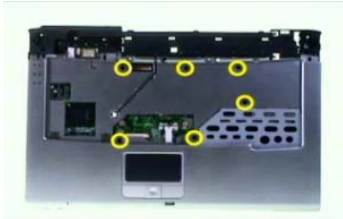

Disassembling the Upper Case Assembly

1. Disconnect the touchpad FFC from the main board.
2. Disconnect the bluetooth cable.
3. Detach the bluetooth module from the upper case.



4. Disconnect the bluetooth cable from the bluetooth card.
5. Disconnect the touchpad to touchpad board FFC.
6. Remove the three screws fastening the touchpad board.

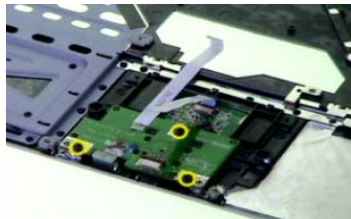
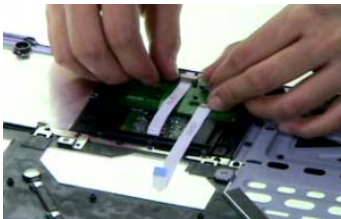

7. Detach the touchpad board.
8. Remove the four-way button from the upper case.
9. Remove the two screws fastening the touchpad support to the upper case.

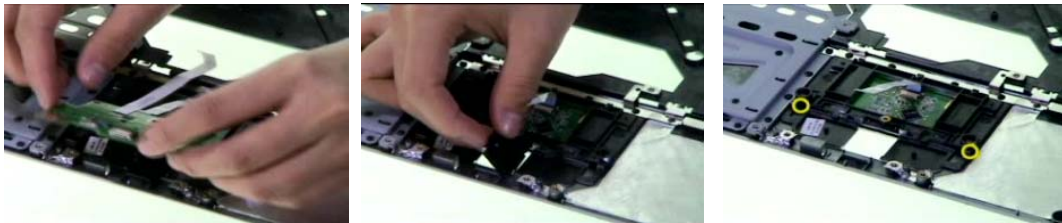

10. Detach the touchpad support from the upper case carefully.
11. Detach the touchpad from the upper case.
12. Disconnect the FFC from the touchpad.

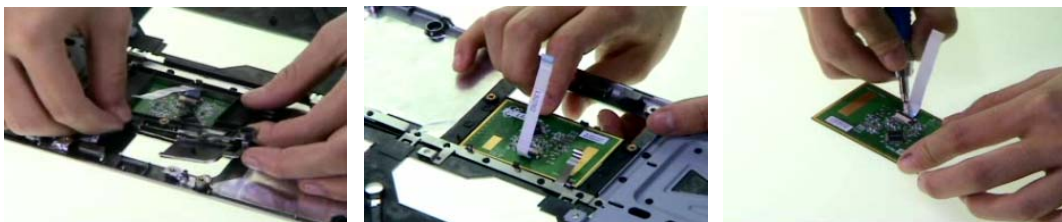

Disassembling the Lower Case Assembly

1. Remove four screws fastening the main board to the lower case.
2. Turn over the lower case assembly, then remove one screw on the other side as shown.

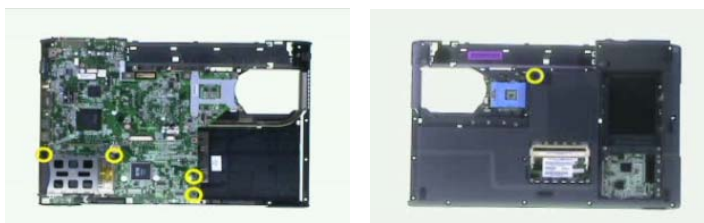

3. Disconnect the speaker cable.
4. Detach the main board assembly from the lower case carefully.
5. Remove the three screws fastening the VGA board.



6. Disconnect the VGA board assembly from the main board.
7. Remove the three screws fastening the VGA thermal to the VGA board. Detach the main board assembly from the lower case carefully. (Follow the order indicated by the numbers: 3, 2 then 1. Please reverse the order when you assemble the system).

8. Detach the VGA thermal from the VGA board.

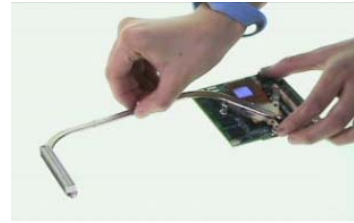
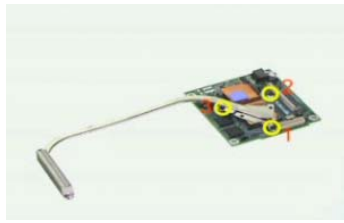
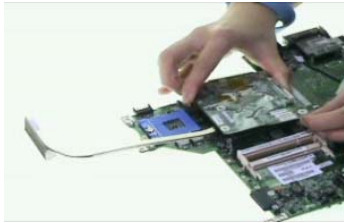

9. Disconnect the modem cable from the main board.
10. Remove the two screws fastening the modem board as shown.
11. Disconnect the modem board from the main board.

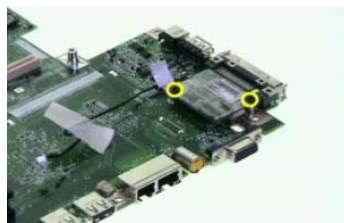

12. Disconnect the modem cable from the modem board.
13. Remove the two screws holding the speaker set to the lower case.
14. Take out the speaker set from the lower case. This completes the main unit disassembly.

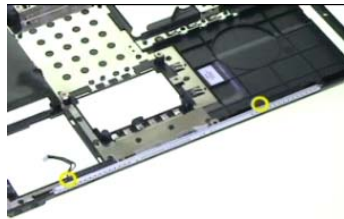
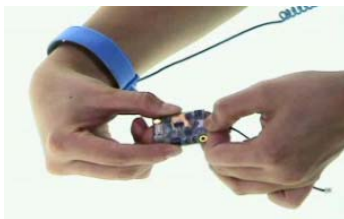

Disassembling the LCD Module

1. Remove the four screw caps as shown.
2. Remove the four screws holding the LCD bezel.
3. Then detach the LCD bezel from the LCD module.



4. Remove the screw fastening the LCD inverter.
5. Disconnect the LCD cable and disconnect the inverter cable, then remove the inverter.
6. Remove the two screws fastening the LCD assembly to the LCD panel.

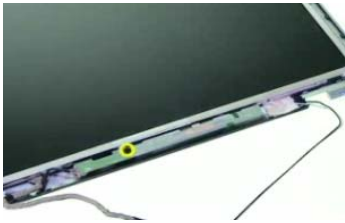

7. Take out the LCD assembly from the LCD panel.
8. Remove the four screws fastening the LCD left bracket then remove it.
9. Remove the four screws fastening the LCD right bracket.

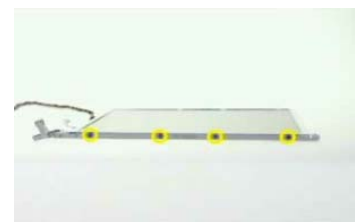
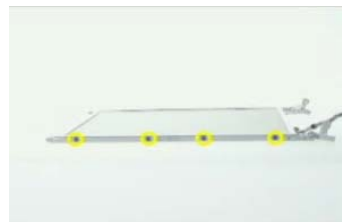

10. Then remove the LCD right bracket.
11. Tear off the mylar and disconnect the LCD cable from the LCD then remove the cable.

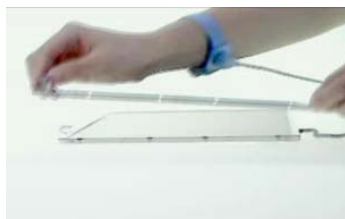

Disassembling the External Modules

Disassembling the HDD Module

1. Remove the two screws holding the HDD bracket on one side.
2. Remove another two screws holding the HDD bracket on the other side.
3. Then take the hard disc drive out of the HDD bracket.



Disassembling the ODD Module

1. Remove the two screws fastening the ODD bracket.
2. Remove the ODD bracket from the optical disc drive module.



Troubleshooting

Use the following procedure as a guide for computer problems.

NOTE: The diagnostic tests are intended to test this model. Non-Acer products, prototype cards, or modified options can give false errors and invalid system responses.

1. Duplicate symptom and obtain the failing symptoms in as much detail as possible.
2. Distinguish symptom. Verify the symptoms by attempting to re-create the failure by running the diagnostic test or by repeating the same operation.
3. Disassemble and assemble the unit without any power sources.
4. If any problem occurs, you can perform visual inspection before you follow this chapter's instructions. You can check the following:
 - power cords are properly connected and secured;
 - there are no obvious shorts or opens;
 - there are no obviously burned or heated components;
 - all components appear normal.
5. Use the following table with the verified symptom to determine which page to go to.

Symptoms (Verified)	Go To
Power failure. (The power indicator does not go on or stay on.)	"Power System Check" on page 59.
POST does not complete. No beep or error codes are indicated.	"Insyde MobilePro BIOS POST Beep Code and POST Messages" on page 61 "Insyde MobilePro BIOS POST Codes" on page 63 "Undetermined Problems" on page 72
POST detects an error and displayed messages on screen.	"Insyde MobilePro BIOS POST Beep Code and POST Messages" on page 61 "Insyde MobilePro BIOS POST Codes" on page 63
Other symptoms (i.e. LCD display problems or others).	"Insyde MobilePro BIOS POST Beep Code and POST Messages" on page 61 "Insyde MobilePro BIOS POST Codes" on page 63 "Index of Symptom-to-FRU Error Message" on page 67
Symptoms cannot be re-created (intermittent problems).	Use the customer-reported symptoms and go to "Insyde MobilePro BIOS POST Beep Code and POST Messages" on page 61 "Insyde MobilePro BIOS POST Codes" on page 63 "Intermittent Problems" on page 71 "Undetermined Problems" on page 72

System Check Procedures

External Diskette Drive Check

If an error occurs with the internal diskette drive, reconnect the diskette connector on the system board.

If the error still remains:

1. Reconnect the external diskette drive/DVD-ROM module.
2. Replace the external diskette drive/CD-ROM module.
3. Replace the main board.

External CD-ROM Drive Check

Do the following to isolate the problem to a controller, drive, or CD-ROM. Make sure that the CD-ROM does not have any label attached to it. The label can cause damage to the drive or can cause the drive to fail.

Do the following to select the test device:

1. Boot from the diagnostics diskette and start the diagnostics program.
2. See if CD-ROM Test is passed when the program runs to CD-ROM Test.
3. Follow the instructions in the message window.

If an error occurs, reconnect the connector on the System board. If the error still remains:

1. Reconnect the external diskette drive/CD-ROM module.
2. Replace the external diskette drive/CD-ROM module.
3. Replace the main board.

Keyboard or Auxiliary Input Device Check

Remove the external keyboard if the internal keyboard is to be tested.

If the internal keyboard does not work or an unexpected character appears, make sure that the flexible cable extending from the keyboard is correctly seated in the connector on the system board.

If the keyboard cable connection is correct, run the Keyboard Test.

If the tests detect a keyboard problem, do the following one at a time to correct the problem. Do not replace a non-defective FRU:

1. Reconnect the keyboard cables.
2. Replace the keyboard.
3. Replace the main board.

The following auxiliary input devices are supported by this computer:

- Numeric keypad
- External keyboard

If any of these devices do not work, reconnect the cable connector and repeat the failing operation.

Memory check

Memory errors might stop system operations, show error messages on the screen, or hang the system.

1. Boot from the diagnostics diskette and start the doagmpstotics program (please refer to main board).
2. Go to the diagnostic memory in the test items.
3. Press F2 in the test items.
4. Follow the instructions in the message window.

NOTE: Make sure that the DIMM is fully installed into the connector. A loose connection can cause an error.

Power System Check

To verify the symptom of the problem, power on the computer using each of the following power sources:

1. Remove the battery pack.
2. Connect the power adapter and check that power is supplied.
3. Disconnect the power adapter and install the charged battery pack; then check that power is supplied by the battery pack.

If you suspect a power problem, see the appropriate power supply check in the following list:

- “Check the Battery Pack” on page 60

Check the Battery Pack

To check the battery pack, do the following:

From Software:

1. Check out the Power Management in control Panel
2. In Power Meter, confirm that if the parameters shown in the screen for Current Power Source and Total Battery Power Remaining are correct.
3. Repeat the steps 1 and 2, for both battery and adapter.
4. This helps you identify first the problem is on recharging or discharging.

From Hardware:

1. Power off the computer.
2. Remove the battery pack and measure the voltage between battery terminals 1(+) and 6(ground). See the following figure
3. If the voltage is still less than 7.5 Vdc after recharging, replace the battery.

To check the battery charge operation, use a discharged battery pack or a battery pack that has less than 50% of the total power remaining when installed in the computer.

If the battery status indicator does not light up, remove the battery pack and let it return to room temperature. Re-install the battery pack.

If the charge indicator still does not light up, replace the battery pack. If the charge indicator still does not light up, replace the DC/DC charger board.

Touchpad check

If the touchpad doesn't work, do the following actions one at a time to correct the problem. Do not replace a non-defective FRU:

1. After rebooting, run Tracking Pad PS2 Mode Driver. For example, run Syn touch driver.
2. Run utility with the PS/2 mouse function and check if the mouse is working.
3. If the the PS/2 mouse does not work, then check if the main board to switch board FPC is connected O.K.
4. If the main board to switch board FPC is connected well, then check if the FCC on touch pad PCB connects properly.
5. If the FFC on touch pad PCB connects properly, then check if LS851 JP1 Pin6=5V are pulese. If yes, then replace switch board. If no, then go to next step.
6. Replace touch pad PCB.
7. If the touch pad still does not work, then replace FPC on Track Pad PCB.

After you use the touchpad, the pointer drifts on the screen for a short time. This self-acting pointer movement can occur when a slight, steady pressure is applied to the touchpad pointer. This symptom is not a hardware problem. No service actions are necessary if the pointer movement stops in a short period of time.

Insyde MobilePro BIOS POST Beep Code and POST Messages

The POST error message index lists the error message and their possible causes. The most likely cause is listed first.

NOTE: Perform the FRU replacement or actions in the sequence shown in FRU/Action column, if the FRU replacement does not solve the problem, put the original part back in the computer. Do not replace a non-defective FRU.

This index can also help you determine the next possible FRU to be replaced when servicing a computer.

If the symptom is not listed, see “Undetermined Problems” on page 72.

The following lists the error messages that the BIOS displays on the screen and the error symptoms classified by function.

NOTE: Most of the error messages occur during POST. Some of them display information about a hardware device, e.g., the amount of memory installed. Others may indicate a problem with a device, such as the way it has been configured.

NOTE: If the system fails after you make changes in the BIOS Setup Utility menus, reset the computer, enter Setup and install Setup defaults or correct the error.

Beep Code	Message	Description
short, short, short; short, short, long	“FAULTY DMA PAGE REGISTERS”	DMA page registers do not function properly.
short, short, short; short, long, short	“FAULTY REFRESH CIRCUIT”	RAM refresh circuit does not function properly.
short, short, short; short, long, long	“ROM CHECKSUM INCORRECT”	BIOS ROM checksum failed.
short, short, short; long, short, short	“CMOS RAM TEST FAILED”	CMOS RAM test failed.
short, short, short; long, short, long	“DMA CONTROLLER FAULTY”	DMA controller does not work properly.
short, short, short; long, long short	“INTERRUPT CONTROLLER FAILED”	The interrupt controller does not work properly.
short, short, short; long, long, long	N/A	Keyboard controller failed to respond with the self-test command.
short, short, long; short, short, short	N/A	No video device found.
short, short, long; short, short, long	N/A	No RAM installed.
N/A	“KEYBOARD CONTROLLER FAILURE”	Keyboard controller failed during system inquiry about connected devices.
N/A	“KEYBOARD FAILURE”	The keyboard fails to respond or no keyboard is connected.
N/A	“CMOS FAILURE - RUN SCU”	CMOS data error, probably due to battery power loss.
N/A	“CMOS CHECKSUM INVALID - RUN SCU”	CMOS checksum error.
N/A	“RAM ERROR AT LOCATION xxxxxx: WROTE: xxxx READ: xxxx”	The RAM failed during memory test at the indicated location.
N/A	“PARITY ERROR AT UNKNOWN LOCATION”	Parity error during memory test at unknown location.
N/A	“PARITY ERROR AT LOCATION XXXXXX”	Parity error during memory test at the indicated location.

Beep Code	Message	Description
N/A	"NO INTERRUPTS FROM TIMER 0"	Timer 0 of the clock timer controller does not generate system interrupts correctly.
N/A	"UNEXPECTED AMOUNT OF MEMORY - RUN SCU"	The system memory size does not match with the CMOS record.
N/A	"CLOCK NOT TICKING CORRECTLY"	The system clock does not working correctly.
N/A	"TIME/DATA CORRUPT - RUN SCU"	The time/date information in CMOS is invalid.
N/A	"MACHINE IS LOCKED - TURN KEY"	The keyboard operation is locked.
N/A	"BOOT SECTOR 0 HAS CHANGED"	The boot sector of the hard disk has been changed, probably because of a virus attack.
N/A	Suspend-to-Disk partition MISSING!"	No Suspend-to-Disk partition found.
N/A	"Hard Disk ERROR!"	Access to the Suspend-to-Disk partition failed.
N/A	"Suspend-to-Disk partition signature NOT FOUND!"	No Suspend-to-Disk partition signature found.
N/A	"Suspend-to-Disk partition size TOO SMALL!"	The capacity of the Suspend-to-Disk partition is not enough.
N/A	"MEMORY SIZE HAS CHANGED -- REBOOTING"	The memory size has changed after previous Suspend-to-Disk operation.

Insyde MobilePro BIOS POST Codes

POST Code	Macro Name	Description
Boot Loader--BLOAD.ASM		
00	DIAG_SYSTEM_INIT	Boot started, check motherboard power is stable.
01	DIAG_A20_DISABLE	Disable A20 through A20
02	DIAG_INIT_CHIPSET	Initialize Chipset
03	DIAG_TEST_RAM	Test the basic 640k RAM
04	DIAG_MOVE_BB_LOADER	Move boot load segment into the RAM
05	DIAG_EXECUTE_IN_DRAM	program execution from DRAM
06	DIAG_USER_FLASH_CHECK	Test print port for check crisis option is enable or disable
07	DIAG_SHADOW_BIOS	Decompress the system BIOS, and Shadow System BIOS to RAM
08	DIAG_CHECKSUM_BIOS	Checksum System BIOS ROM
09	DIAG_NORMAL_BOOT	Jump to the reset point
0A	DIAG_CRISIS_BOOT	Proceed with Crisis Boot, first initial super I/O and boot device
0F	DIAG_FATAL_ERROR	Fatal Error, like the RAM error or ROM error
CC	DIAG_CRISIS_BEGIN	Start process the Crisis recovery procedure
99	DIAG_RESUME_RAM_ERROR	Resume SMRAM not Found
POST DIAG -- BIOSPINE.ASM		
10	DEBUG_MISC_RESET	Disable internal cache ram, and reset cpu
11	DEBUG_CS_FAST_A20_RESET	Turn off FASTA20 for post, and check have keyboard
12	DEBUG_POST_SIGNAL_POR	Initial PIC enable INT and Signal Power On Reset
13	DEBUG_CS_CHIP_INIT	Initialize the Chipset and hook PCI BIOS
14	DEBUG_OEM_ISA_VGA_SEARCH	Search For ISA Bus VGA Adapter, from address c000 to e000
15	DEBUG_HWIO_SETUP CTC1	Initialize Counter and Timer chip
16	DEBUG_OEM_SET_CMOS_REGS	User register config through CMOS
17	DEBUG_CS_MEMORY_SIZE	Size Memory, and detect memory timing, setup memory controller
18	DEBUG_POST_TEST_RAM	Initialize and test the first 64k memory
19	DEBUG_GEN_TEST_ROMS	checksum the system ROM
1A	DEBUG_HWIO_RESET_INTS	Reset PIC's status
1B	DEBUG_VIDEO_VIDEO_INIT	Initialize Video Adapter(s),and check vga rom and vga ram
1C	DEBUG_VIDEO_EQUIP_INIT	Initialize Video (6845 Regs),set display mode
1D	DEBUG_VIDEO_COLOR_INIT	Initialize Color Adapter, and setup display reg.
1E	DEBUG_VIDEO_BW_INIT	Initialize Monochrome Adapter, and setup display reg.
1F	DEBUG_HWIO_TEST_DMA_PAG	Send out some value, to test 8237A Page Registers
20	DEBUG_KEYB_SELFTEST_CTLR	Send self test command (AAH) to test Keyboard controller. If o.k. return (55h)
21	DEBUG_KEYB_RESET_KEYBOARD	TestKeyboardControllerandinitializekeyboard controller.
22	DEBUG_POST_CHECK_CMOS_RAM	Send test petten to Check CMOS Ram

POST Code	Macro Name	Description
23	DEBUG_POST_TEST_BATT_CMOS_SUM	Test Battery Fail & check CMOS X-SUM
24	DEBUG_HWIO_TEST_DMA_CTLRS	Use DMA to copy data for Test the DMA controllers
25	DEBUG_HWIO_INIT_8237	Initialize 8237A Controller
26	DEBUG_POST_INIT_VECS	Install and Initialize interrupt Vectors
27	DEBUG_RAM_QUICK_SIZE	Enter memory protect mode, use change RAM bank to do RAM Quick Sizing
28	DEBUG_RAM_PROT_ENTRY_1	Memory protected mode entered safely
29	DEBUG_RAM_SIZE_DONE	Test the basic 640k ram , RAM test completed
2A	DEBUG_RAM_PROT_EXIT	Protected mode exit successful
2B	DEBUG_CS_SHADOW_SETUP	Shadow system and video BIOS to RAM, if CMOS requests shadow
2C	DEBUG_VIDEO_EQUIP_INIT_INIT	Going To Initialize 6845 CRT controller
2D	DEBUG_VIDEO_BW_SEARCH	Search For Monochrome Adapter
2E	DEBUG_VIDEO_COLOR_SEARCH	Search For Color Adapter
2F	DEBUG_VIDEO_SIGNON	Signon messages displayed
30	DEBUG_OEM_CONFIG_KBD_CTL	For special initialize of keyboard controller
31	DEBUG_KEYB_PRESENT_TEST	Test the keyboard controller , If Keyboard Present
32	DEBUG_KEYB_TEST_IRQ1	Clear keyboard buffer and send keyboard command to test Keyboard Interrupt
33	DEBUG_KEYB_TEST_CMD	Send keyboard command to turn off keyboard LED and Test some Keyboard Command Byte
34	DEBUG_RAM_FULL_TEST	TEST memory procedure, for test, blank and count all RAM
35	DEBUG_RAM_PROT_ENTRY_2	Enter the memory protected mode for test all expand memory
36	DEBUG_RAM_TEST_DONE	Test and blank all memory complete
37	DEBUG_RAM_PROT_EXIT_2	Switch the memory from Protected mode to real mode
38	DEBUG_KEYB_OUTPUT_PORT	Disable A20 status for memory test finish
39	DEBUG_CS_CACHE_SETUP	Setup Cache Controller
3A	DEBUG_HWIO_TEST_PERIODIC	Check and test the timer 0 interrupt function is Working
3B	DEBUG_GEN_CHECK_RTC	test for RTC ticking
3C	DEBUG_GEN_INIT_HARD_VECS	Install and initialize the hardware vectors
3D	DEBUG_MOUSE_INIT	Clear keyboard buffer for search and Init the Mouse
3E	DEBUG_KEYB_SET_LEDS_1	Send keyboard command to Update keyboard NUMLOCK status
3F	DEBUG_OEM_DEVICE_CONFIG	special init of COMM and LPT ports
40	DEBUG_CS_CONFIG_PORTS	Configure the COMM and LPT ports
41	DEBUG_FLOP_INIT	According cmos data to initialize the floppies
42	DEBUG_WINI_INIT	Scan and initialize the hard disk, and display the result n crt
43	DEBUG_HWIO_ROM_INIT	Search option rom from c800 to e000 and to Initialize option ROMs

POST Code	Macro Name	Description
44	DEBUG_OEM_INIT_POWER_MAN	Check special device initial power management function
45	DEBUG_KEYB_SET_LEDS_2	Clear keyboard buffer and Update NUMLOCK status
46	DEBUG_HWIO_FIND_80X87	Test For Coprocessor Installed, and enable coprocessor interrupt
47	DEBUG_OEM_LAST_MINUTE_INIT	Run OEM functions before boot, and enable L1,L2 cache
48	DEBUG_MISC_LAUNCH_INT19	Post code will finish, ready to run int19 and load OS
49	DEBUG_BEGIN_BOOT_CODE	Into Int19, to boot from floppy or other boot device
50	DEBUG_ACPI_INIT	Initialize the ACPI function
51	DEBUG_PM_CPU_INIT	Power manager initial & GEYSERVILLE CPU initialize
52	DEBUG_USB_HC_INIT	Clear USB status register and Initialize the USB Hub controller.
PCI BIOS -- PCICORE.ASM		
D0	DEBUG_ROM_MAPPED_OK	check PCI 1.x VGA card rom mapping and rom signature
D1	DEBUG_SEGMENTENABLE_COPYSTATE_1	enable PCI device use ram area, record in PCI register
D2	DEBUG_COPY_HROM_RAM_1	Enable PCI device ROM copy to RAM, record in PCI register
D3	DEBUG_SEGMENTENABLE_READWRITE_1	update PCI device segment range attribute registers
D4	DEBUG_MAP_MEM_1	Configure PCI device memory registers
D5	DEBUG_MAP_IO_1	Configure PCI device I/O registers
D6	DEBUG_MAP_IRQ_1	Configure PCI device IRQ assignments
D7	DEBUG_CONFIG_COM_REG_1	turn on PCI device
D8	DEBUG_REVISION_1	PCI 2.x video card rom mapping
D9	DEBUG_OEM_DEV_CLEANUP_1	OEM PCI device defined, and initial OEM rom
DA	DEBUG_PCI_ADDIN_ROM_DISABLE_1	disable add-in rom card decode
DB	DEBUG_RET_PCI_1	PCI device config finish
DC	DEBUG_SEGMENTENABLE_COPYSTATE_2	enable PCI video device use ram area, record in PCI register
DD	DEBUG_COPY_HROM_RAM_2	Enable PCI video device ROM copy to RAM, record in PCI register
DE	DEBUG_SEGMENTENABLE_READWRITE_2	update PCI video device segment range attribute registers
DF	DEBUG_MAP_MEM_2	configure PCI video device memory registers
E0	DEBUG_MAP_IO_2	configure PCI video device I/O registers
E1	DEBUG_MAP_IRQ_2	configure PCI video device IRQ assignments
E2	DEBUG_CONFIG_COM_REG_2	turn on PCI video device
E3	DEBUG_REVISION_2	PCI 2.x video rom mapping
E4	DEBUG_OEM_DEV_CLEANUP_2	OEM PCI video device defined, and initial OEM rom
E5	DEBUG_PCI_ADDIN_ROM_DISABLE_2	disable PCI video device add-in rom card decode

POST Code	Macro Name	Description
E6	DEBUG_RET_PCI_2	PCI device config finish
E7	DEBUG_BRIDGE_HUNT	Search for PCI bridge controller device
E8	DEBUG_PCI_IDE_FIND	Search IDE controllers on the PCI bus, and config the IDE controllers
E9	DEBUG_CB_CONFIG	start of cardbus config
PNP BIOS -- PNPINIT.ASM		
A1	DEBUG_PNP_ENABLE_VERIFY_RT_DATA	Enable and Verify R/W Status for PNP BIOS Runtime Data Area
A2	DEBUG_PNP_GET_VERIFY_NVRAM	Get and Verify R/W Status for PNP BIOS NVRAM data area
A3	DEBUG_PNP_SYSTEM_NODES	Resolve System Nodes with the CMOS settings
A4	DEBUG_PNP_INITIALIZE_RTDATA	Initialize variable in the PNP BIOS Runtime Data area
A5	DEBUG_PNP_HOOK_INT15	Hook INT 15
A6	DEBUG_PNP_SET_COPY_AREA	copy and setup PnP BIOS system node
A7	DEBUG_PNP_OEM_LATE_HOOK	Allow the OEM any Last Minute Hooks
A8	DEBUG_PNP_WRITE_PROTECT_RT_DAT	Write protect RTData Area and NVRAM Copy Buffer, and make runtime data checksum
A9	DEBUG_PNP_INIT_RETURN	PNP BIOS initialize finish
General SMI Entry/Exit Code -- SMICHIP.ASM		
C0	dSMI_ENTRY	SMI procedure entry point
C1	dSMI_EXIT	SMI procedure exit
C2	dSMI_APM_ENTRY	APM MODE SMI procedure entry point
C3	dSMI_APM_EXIT	APM MODE SMI procedure exit
Software SMI request Codes -- SWSHELL.ASM		
C4	dSMI_SWEXEFN	SoftWare SMI function execution
C5	dSMI_HWEXEFN	HardWare SMI function execution

Index of Symptom-to-FRU Error Message

LCD-Related Symptoms

Symptom / Error	Action in Sequence
LCD backlight doesn't work	First, plug a monitor to CRT port. Next, enter BIOS utility to running "Load Default Settings" then reboot the system. Reconnect the LCD connectors. Keyboard (if the brightness function key doesn't work). LCD cable LCD inverter LCD Main board
LCD is too dark LCD brightness cannot be adjusted	Enter BIOS Utility to execute "Load Setup Default Settings", then reboot system. Reconnect the LCD connectors. Keyboard (if the brightness function key doesn't work). LCD cable LCD inverter LCD Main board
Unreadable LCD screen Missing pels in characters Abnormal screen Wrong color displayed LCD has extra horizontal or vertical lines displayed.	Reconnect the LCD cable LCD cable LCD Main board

Indicator-Related Symptoms

Symptom / Error	Action in Sequence
Indicator incorrectly remains off or on, but system runs correctly	Main board
HDD/CD-ROM active indicators cannot work	HDD/CD-ROM drive Device driver Main board

Power-Related Symptoms

Symptom / Error	Action in Sequence
Power shuts down during operation	Power source (battery pack and power adapter). See "Power System Check" on page 59. Battery pack AC adapter See if the thermal module is overheat (Heat sink or fan). Main board
The system cannot power-on.	Power source (battery pack and power adapter). See "Power System Check" on page 59. Battery pack Power adapter CPU Main board
The system cannot power-off.	In Windows XP operating system, hold and press the power switch for more than 4 seconds. If the system can power off, then the main board is OK. Verify OS in the HDD. Main board

Power-Related Symptoms

Symptom / Error	Action in Sequence
Battery can't be charged or discharged	See "Check the Battery Pack" on page 60. Battery pack Main board
System hang during POST	ODD/HDD/FDD/RAM module Main board

PCMCIA-Related Symptoms

Symptom / Error	Action in Sequence
System cannot detect the PC Card (PCMCIA)	PCMCIA slot assembly Main board
PCMCIA slot pin is damaged.	PCMCIA slot assembly
PC Card cannot be inserted or ejected	Check if the PCMCIA slot is blocked Main board

Memory-Related Symptoms

Symptom / Error	Action in Sequence
Memory count (size) appears different from actual size.	Enter BIOS Setup Utility to execute "Load Default Settings" then reboot system. RAM module Main board Check BIOS revision
System can power on, but you hear two long beeps: "B--, B--" and the LCD is blank.	Reinsert DIMM DIMM Main board

Speaker-Related Symptoms

Symptom / Error	Action in Sequence
In Windows, multimedia programs, no sound comes from the computer.	OS volume control Audio driver Speaker Main board
Internal speakers make noise or emit no sound.	Speaker Main board
Microphone cannot work	Audio driver Volume control in Windows XP Main board

Power Management-Related Symptoms

Symptom / Error	Action in Sequence
The system will not enter hibernation mode	Power option in Windows XP Hard disk drive Main board
The system doesn't enter standby mode after closing the lid of the portable computer.	Driver of Power Option Properties Lid close switch in upper case Main board

Power Management-Related Symptoms

Symptom / Error	Action in Sequence
The system doesn't resume from hibernation/standby mode.	Connect AC adapter then check if the system resumes from Standby/Hibernation mode. Check if the battery is low. Hard disk drive Main board
The system doesn't resume from standby mode after opening the lid of the portable computer.	LCD cover switch Main board
Battery fuel gauge in Windows doesn't go higher than 90%.	Refresh battery (continue use battery until power off, then charge battery). Battery pack Main board
System hangs intermittently.	Reconnect hard disk/CD-ROM drives. Main board

Peripheral-Related Symptoms

Symptom / Error	Action in Sequence
System configuration does not match the installed devices.	Enter BIOS Setup Utility to execute "Load Setup defaults", then reboot system. Reconnect hard disk/CD-ROM drives/FDD or other peripherals. Main board
External display does not work correctly.	Press Fn+F5, LCD/CRT/Both display switching Keyboard Main board
USB does not work correctly	Main board
Print problems.	Enter BIOS Setup Utility to execute "Load Default Settings" then reboot the system. Run printer self-test. Printer driver Printer cable Printer Main board
Parallel port device problems	Enter BIOS Setup Utility to execute "Load Default Settings" then reboot the system. Device driver Device cable Device Main board

Keyboard/Touchpad-Related Symptoms

Symptom / Error	Action in Sequence
Keyboard (one or more keys) does not work.	Reconnect the keyboard cable. Keyboard Main board
Touchpad does not work.	Reconnect touchpad cable. Touchpad board Main board

Modem/LAN-Related Symptoms

Symptom / Error	Action in Sequence
Internal modem does not work correctly.	Phone cable Driver Reconnect the Internal modem cable to the main board tightly. Main board
Internal LAN does not work correctly	Lan cable Driver Main board

NOTE: If you cannot find a symptom or an error in this list and the problem remains, see “Undetermined Problems” on page 72.

Intermittent Problems

Intermittent system hang problems can be caused by a variety of reasons that have nothing to do with a hardware defect, such as: cosmic radiation, electrostatic discharge, or software errors. FRU replacement should be considered only when a recurring problem exists.

When analyzing an intermittent problem, do the following:

1. Run the diagnostic test for the system board in loop mode at least 10 times.
2. If no error is detected, do not replace any FRU.
3. If any error is detected, replace the FRU. Rerun the test to verify that there are no more errors.

Undetermined Problems

The diagnostic problems does not identify which adapter or device failed, which installed devices are incorrect, whether a short circuit is suspected, or whether the system is inoperative.

Follow these procedures to isolate the failing FRU (do not isolate non-defective FRU).

NOTE: Verify that all attached devices are supported by the computer.

NOTE: Verify that the power supply being used at the time of the failure is operating correctly. (See "Power System Check" on page 59):

1. Power-off the computer.
2. Visually check them for damage. If any problems are found, replace the FRU.
3. Remove or disconnect all of the following devices:
 - Non-Acer devices
 - Printer, mouse, and other external devices
 - Battery pack
 - Hard disk drive
 - DIMM
 - PC Cards
4. Power-on the computer.
5. Determine if the problem has changed.
6. If the problem does not recur, reconnect the removed devices one at a time until you find the failing FRU.
7. If the problem remains, replace the following FRU one at a time. Do not replace a non-defective FRU:
 - System board
 - LCD assembly

Jumper and Connector Locations

Top View

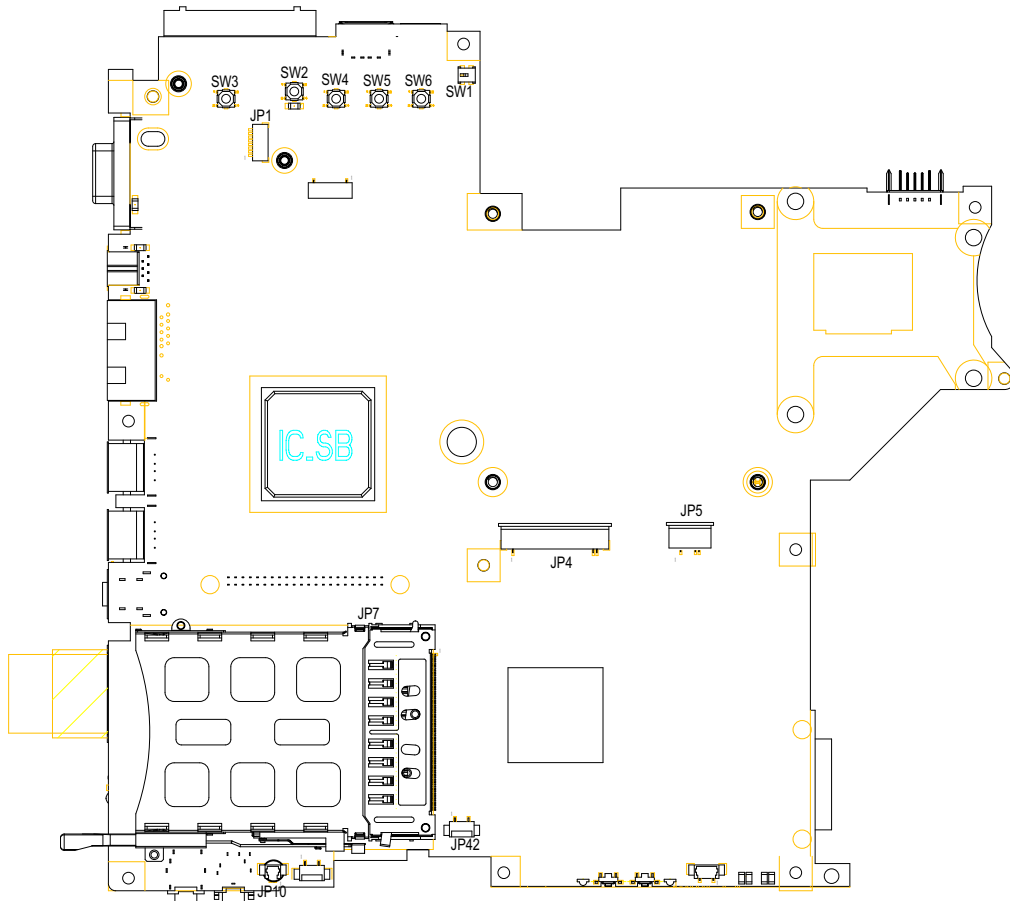

SW3	Power Switch	SW1	Lid Switch
JP1	Bluetooth Connector	JP5	Touchpad Connector
SW2	E-mail Switch	JP4	Keyboard Connector
SW4	Internet Browser Switch	JP42	Speaker Connector
SW5	Emanager Switch	JP7	PCMCIA Slot
SW6	User Programmable Switch	JP10	Microphone Connector

Bottom View

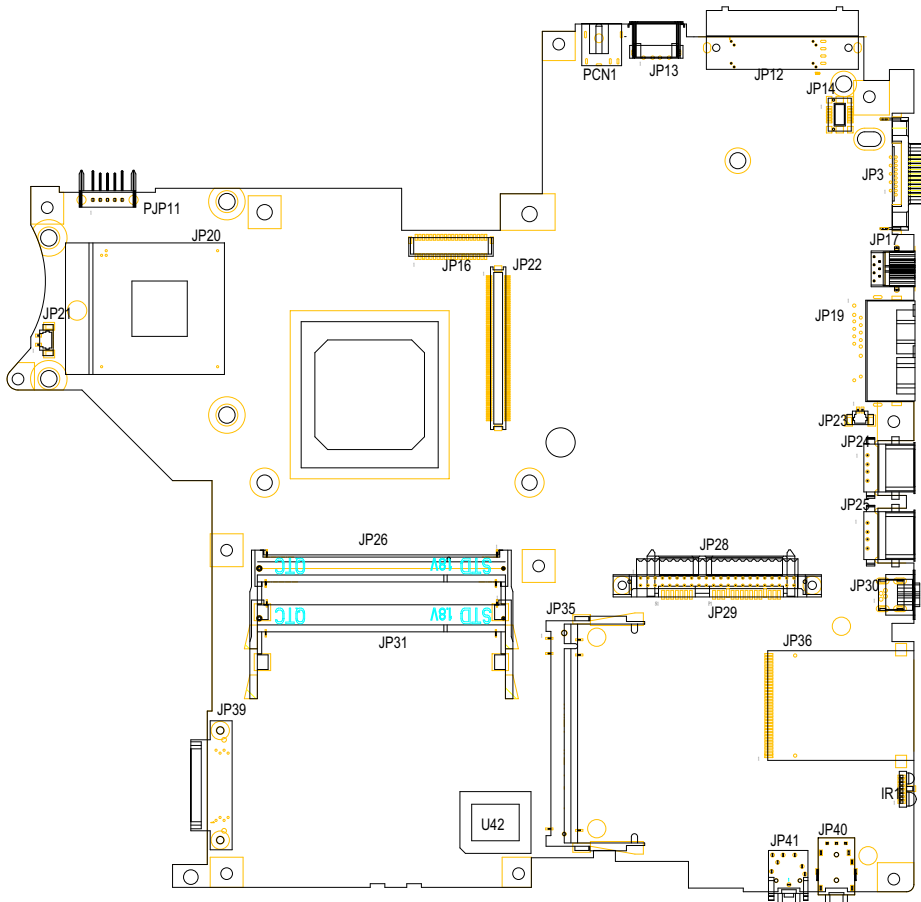

JP21	Fan Connector	JP24	USB Port
PJP11	Battery Connector	JP25	USB Port
JP20	CPU Socket	JP30	IEEE 1394 Port
JP16	LVDS Connector	JP36	Card Reader Connector
JP22	VGA Board Connector	IR	Infrared Receiver
PCN1	AC-IN	JP40	Headphone out/line-out Jack (support SPDIF)
JP13	USB Port	JP41	Mic-in Jack
JP12	Acer ezDock (TravelMate 3220 only)	JP28	HDD Connector
JP14	Modem Board Connector	JP35	Wireless LAN Card Connector
JP3	External Display Port	U42	BIOS
JP17	S-Video Port	JP26	DDR2 Socket
JP19	RJ11/RJ45	JP31	DDR2 Socket
JP23	Modem Cable Connector	JP39	ODD Connector

FRU (Field Replaceable Unit) List

This chapter gives you the FRU (Field Replaceable Unit) listing in global configurations of TravelMate 2400/3210/3220/3230 series products. Refer to this chapter whenever ordering for parts to repair or for RMA (Return Merchandise Authorization).

Please note that WHEN ORDERING FRU PARTS, you should check the most up-to-date information available on your regional web or channel. For whatever reasons a part number change is made, it will not be noted on the printed Service Guide. For ACER AUTHORIZED SERVICE PROVIDERS, your Acer office may have a DIFFERENT part number code from those given in the FRU list of this printed Service Guide. You MUST use the local FRU list provided by your regional Acer office to order FRU parts for repair and service of customer machines.

NOTE: To scrap or to return the defective parts, you should follow the local government ordinance or regulations on how to dispose it properly, or follow the rules set by your regional Acer office on how to return it.

Exploded Diagram

The System

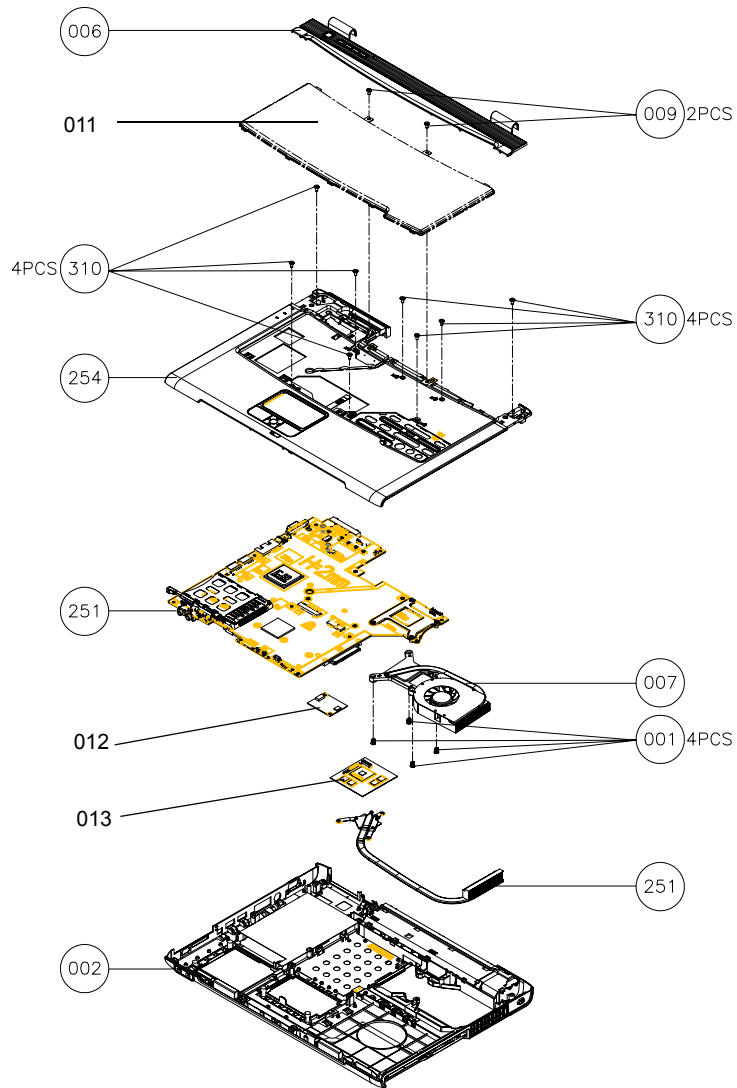

Upper Case Assembly

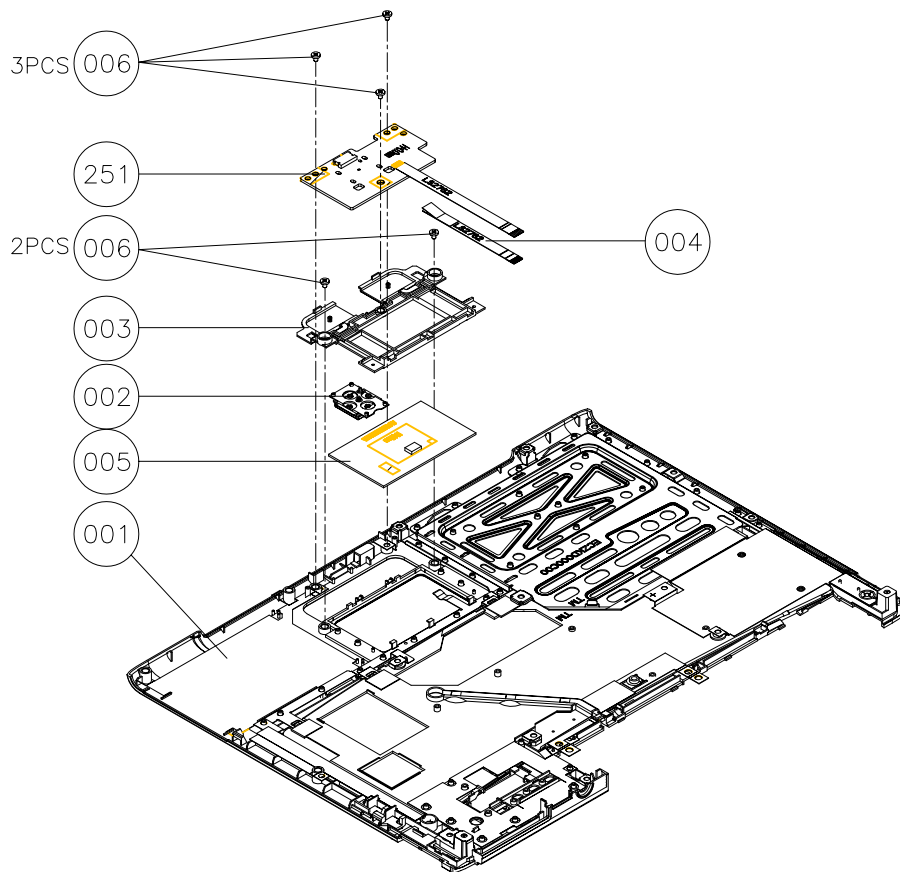

Lower Case Assembly

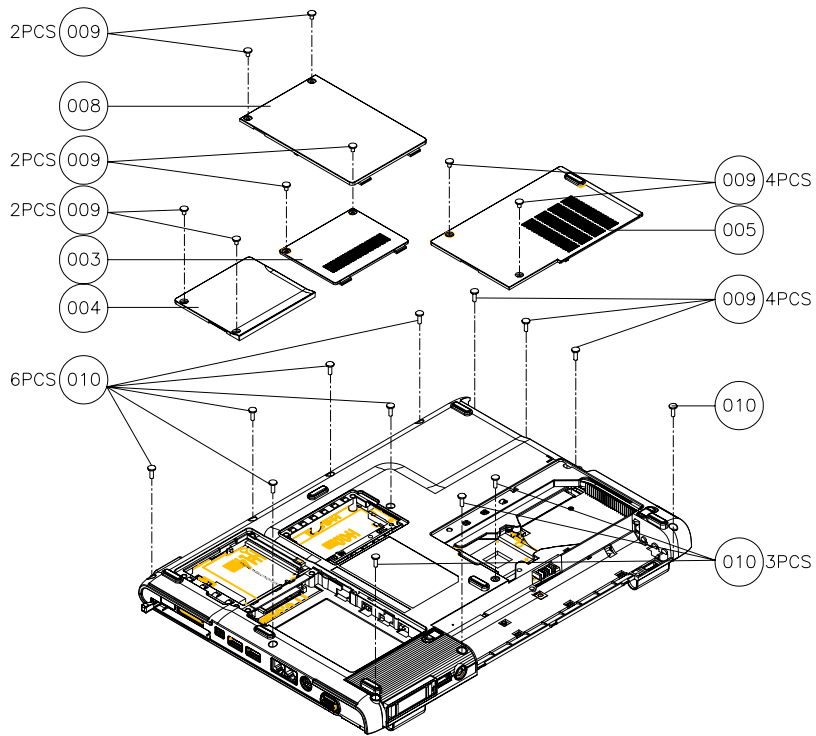

LCD Module

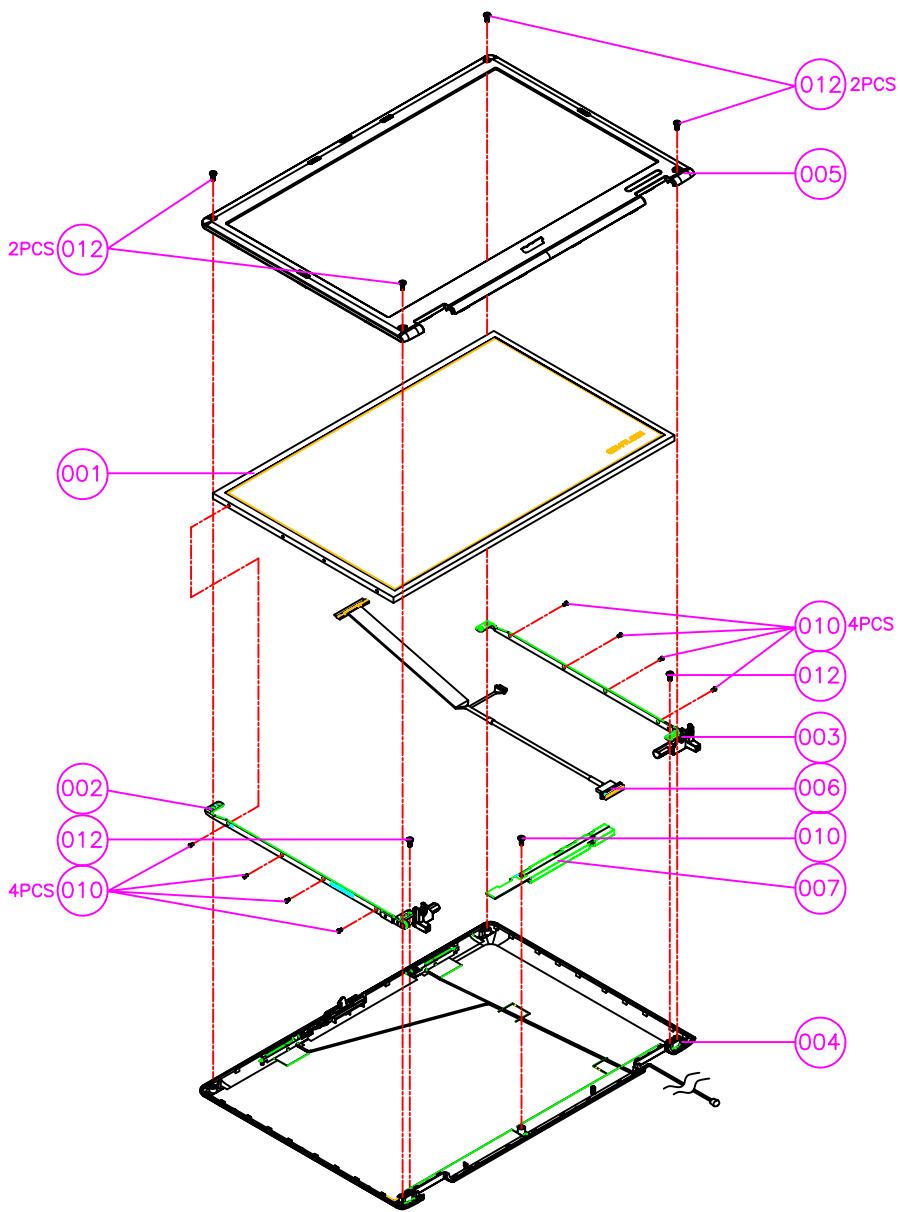

HDD Module

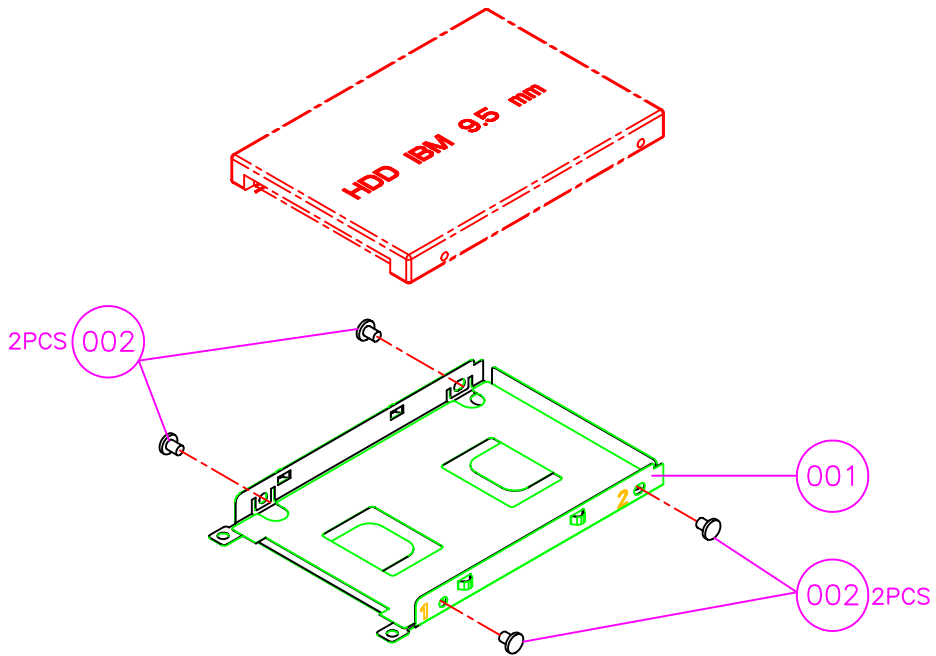



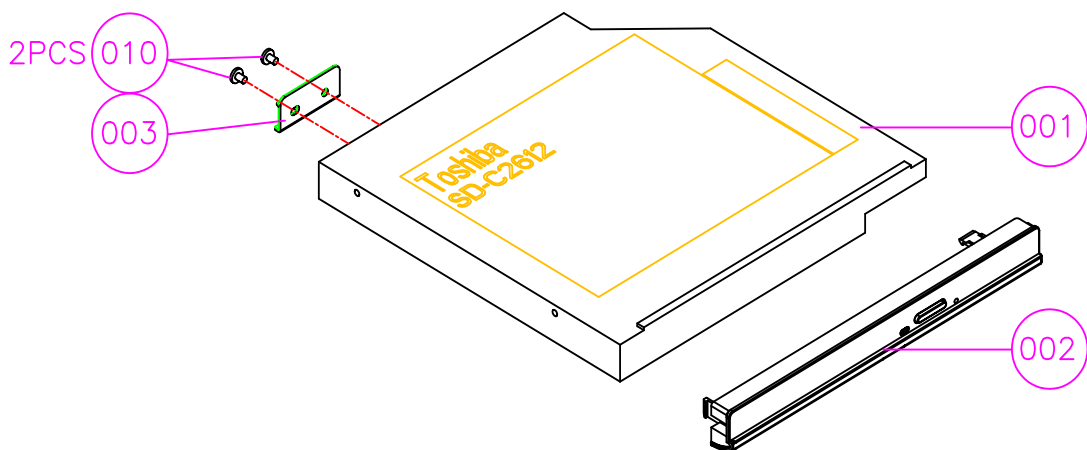

ODD Module



NOTE: Below is TravelMate 2400/3210/3220 FRU List. The columns highlighted in blue indicate the differential parts for TravelMate 3220.







TravelMate 2400/3210/3220/3230 FRU List

Picture	No.	Part Name and Description	Part Number
Adapter			
	NS (Not Show)	ADAPTER 3 PIN 65W DELTA SADP-65KB BEF 19V 3PIN	AP.06501.006
		ADAPTER 3 PIN 65W LITEON PA-1650-02CO 65W 3 PIN	AP.06503.007
		ADAPTER 3 PIN 65W HIPRO HP-OK066B13CP 3P 65W	AP.0650A.004
Battery			
	NS	BATTERY LI-ION 6 CELLS-SANYO 2000mAH UR18650F	BT.00603.001
		BATTERY LI-ION 6 CELLS-SONY 2000mAH US18650G4	BT.00604.004
		BATTERY LI-ION 6 CELLS-SANYO 2400mAH UR18650F	BT.00604.001
		BATTERY LI-ION 6 CELLS-SONY 2400mAH US18650G7	BT.00604.001
	NS	BATTERY LI-ION 9 CELLS-SANYO 2400mAH UR18650F	BT.00903.002
Board			
	The System-012	MODEM BOARD FOXCONN T60M845.01	54.A70V5.001
	NS	BLUETOOTH CARD WNC 91.BU513.002	54.A70V5.002
	NS	MINI PCI WIRELESS BOARD 802.11 b+g INTEL WM3B2200/CH11	KI.CAX01.008
	Upper Case Assembly-251	T/P BOARD W/FFC CABLE	55.A70V5.001

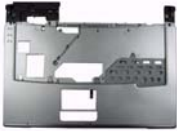

TravelMate 2400/3210/3220/3230 FRU List

Picture	No.	Part Name and Description	Part Number
	The System-013	VGA BOARD M26P 64MB	55.A70V5.002
Cable			
	Upper Case Assembly-004	FFC CABLE - T/P TO T/P BOARD	50.A70V5.001
	NS	BLUETOOTH CABLE	50.A70V5.002
	NS	MODEM CABLE	50.A70V5.003
	NS	POWER CORD-AUS	27.A70V5.001
	NS	POWER CORD-CHINA	27.A70V5.002
	NS	POWER CORD-DENMARK	27.A70V5.003
	NS	POWER CORD-EC	27.A70V5.004
	NS	POWER CORD-INDIA	27.A70V5.005
	NS	POWER CORD-ISREL	27.A70V5.006
	NS	POWER CORD-ITALIAN	27.A70V5.007
	NS	POWER CORD-JP	27.A70V5.008
	NS	POWER CORD-KOREA	27.A70V5.009
	NS	POWER CORD-SOUTH AFRICA	27.A70V5.010
	NS	POWER CORD-SWISS	27.A70V5.011
	NS	POWER CORDTWN	27.A70V5.012
	NS	POWER CORD-UK	27.A70V5.013
CABLE	NS	POWER CORD-US	27.A70V5.014
Case/Cover/Bracket Assembly			
	The System-006	MIDDLE COVER - TM	42.TAAV5.001

TravelMate 2400/3210/3220/3230 FRU List

Picture	No.	Part Name and Description	Part Number
	The System-254; Upper Case Assembly-001	UPPER CASE-TM	60.TAAV5.001
	NS	UPPER CASE FOR DUCKING(TravelMate 3220)	60.TAMV5.001
	The System-002	LOWER CASE- UMA	60.A70V5.002
	NS	LOWER CASE- NON UMA	60.A70V5.003
	NS	LOWER CASE FOR DUCKING(TravelMate 3220)	60.TAMV5.002
	Upper Case Assembly-002	4 - WAY BUTTON	42.A70V5.002
	Upper Case Assembly-003	TP SUPPORT	33.A70V5.001
	Lower Case Assembly-003	DIMM COVER	42.A70V5.003
	Lower Case Assembly-004	PCI DOOR	42.A70V5.005
	Lower Case Assembly-005	THERMAL DOOR	42.A70V5.006
Communication Module			
	NS	ANTENNA ASSY	50.A70V5.004
CPU/Procussor			





TravelMate 2400/3210/3220/3230 FRU List

Picture	No.	Part Name and Description	Part Number
	NS	CELERON M 350 (1.3G 1M) C0	KC.NC001.350
	NS	CELERON M 360 (1.4G 1M) C0	KC.NC001.360
	NS	CELERON M 370 (1.5G 1M) C0	KC.NC001.370
	NS	INTEL PENTIUM M DOTHAN 1.6GHZ 2M UFCBGA SL7EG B-1 STEPPING	KC.N0001.725
	NS	INTEL PENTIUM M 1.6G 2M 533FSB uFCPGA2 SL86G C-1 STEPPING	KC.N0001.730
	NS	INTEL PENTIUM M 1.73G 2M 533FSB uFCPGA2 SL7SA C-1 STEPPING	KC.N0001.740
	NS	INTEL PENTIUM M 1.87G 2M 533FSB uFCPGA2 SL7S9 C-1 STEPPING	KC.N0001.750
	NS	INTEL PENTIUM M 2.0G 2M 533FSB uFCPGA2 SL7SM C-1 STEPPING	KC.N0001.760
Combo Drive			
	ODD Module	DVD/CDRW COMBO MODULE 24X PHILIPS SCB5265	6M.A70V5.001
	ODD Module-001	DVD/CDRW COMBO DRIVE 24X PHILIPS SCB5265	KO.02403.007
	ODD Module-002	DVD/CDRW COMBO BEZEL	42.A70V5.007
	ODD Module-003	ODD BRACKET	33.A70V5.002
	ODD Module	DVD/CDRW COMBO 24X MODULE PANASONIC UJDA-770	6M.A70V5.002
	ODD Module-001	DVD/CDRW COMBO 24X DRIVE PANASONIC UJDA-770	KO.02406.013
	ODD Module-002	DVD/CDRW COMBO BEZEL	42.A70V5.007
	ODD Module-003	ODD BRACKET	33.A70V5.002
DVD RW Drive			
	ODD Module	DVD DUAL MODULE 8X LITE-ON SOSW-833S (DL) TRAY IN	6M.A70V5.004
	ODD Module-001	DVD DUAL 8X DRIVE LITE-ON SOSW-833S (DL)	KU.00804.012







TravelMate 2400/3210/3220/3230 FRU List

Picture	No.	Part Name and Description	Part Number
	ODD Module-002	DVD DUAL BEZEL - TRAY IN	42.A70V5.008
	ODD Module-003	ODD BRACKET	33.A70V5.002
	ODD Module	DVD DUAL MODULE 8X HLDS GWA-4082N (DL)	6M.A70V5.007
	ODD Module-001	DVD DUAL 8X DRIVE HLDS GWA-4082N (DL)	KU.0080D.016
	ODD Module-002	DVD DUAL BEZEL - TRAY IN	42.A70V5.008
	ODD Module-003	ODD BRACKET	33.A70V5.002
	ODD Module	SUPER MULTI MODULE 8X PANASONIC UJ-840BAA (DL)	6M.A70V5.008
	ODD Module-001	SUPER MULTI 8X DRIVE PANASONIC UJ-840BAA	KU.00807.011
	ODD Module-002	SUPER MULIT BEZEL	42.A70V5.010
	ODD Module-003	ODD BRACKET	33.A70V5.002
HDD Module			
	HDD Module	HDD 40G 4200PRM SEAGATE ST94019A	KH.04001.010
	HDD Module	HDD 40G 2.5 IN. 420RPM TOSHIBA PLUTO MK4025GAS	KH.04004.002
	HDD Module	HGST 40G 2.5" 4200 MORAGA+ HTS424040M9AT00 13G1132 FW:A71A	KH.04007.012
	HDD Module	HDD 60GB 2.5 IN. 4200RPM SEAGATE N2 ST960821A F/W: 3.01	KH.06001.002
	HDD Module	HDD 60G 2.5IN. 4200RPM TOSHIBA PLUTO MK6025GAS 2M F/W KA200A	KH.06004.003
	HDD Module	HDD 60GB 2.5IN. 4200RPM MORAGA 60G IC25N060ATMR04-0 08K0634 F/S:AD4A	KH.06007.006
	HDD Module	HDD 80GB 2.5 IN. 4200RPM SEAGATE N2 ST9808210A F/W: 3.01	KH.08001.012
	HDD Module	HDD 80GB 2.5IN. 4200RPM TOSHIBA PLUTO MK8025GAS	KH.08004.001
	HDD Module	HDD 80GB 2.5IN. 4200RPM HGST MORAGA IC25N080ATMR04-0	KH.08007.007
	HDD Module	HDD 100G 4200PRM SEAGATE ST9100822A F/W:3.01	KH.10001.001
	HDD Module	HDD 100GB 2.5IN. 4200RPM TOSHIBA PLUTO MK1031GAS F/W AA20	KH.10004.001







TravelMate 2400/3210/3220/3230 FRU List

Picture	No.	Part Name and Description	Part Number
	HDD Module-001	HDD BRACKET	33.A70V5.003
	Lower Case Assembly-008	HDD DOOR	42.A70V5.011
Keyboard			
	The System-011	KEYBOARD DARFON CHINESE	KB.T5902.001
		KEYBOARD DARFON US INTERNATIONAL	KB.T5902.002
		KEYBOARD DARFON THAI	KB.T5902.003
		KEYBOARD DARFON GERMAN	KB.T5902.004
		KEYBOARD DARFON UK	KB.T5902.005
		KEYBOARD DARFON ITALIAN	KB.T5902.006
		KEYBOARD DARFON FRENCH	KB.T5902.007
		KEYBOARD DARFON SWISS/G	KB.T5902.008
		KEYBOARD DARFON BELGIUM	KB.T5902.009
		KEYBOARD DARFON SPANISH	KB.T5902.010
		KEYBOARD PORTUGUESE	KB.T5902.011
		KEYBOARD CZECH	KB.T5902.012
		KEYBOARD HUNGARIAN	KB.T5902.013
		KEYBOARD RUSSIAN	KB.T5902.014
		KEYBOARD SWEDEN	KB.T5902.015
		KEYBOARD NORWEGIAN	KB.T5902.016
		KEYBOARD DANISH	KB.T5902.017
		KEYBOARD ARABIC	KB.T5902.018
KEYBOARD BRAZILIAN PORTUGUESE	KB.T5902.019		
KEYBOARD CANADIAN FRENCH	KB.T5902.020		
KEYBOARD GREEK	KB.T5902.021		
KEYBOARD TURKISH	KB.T5902.022		
KEYBOARD HEBREW	KB.T5902.023		
KEYBOARD SLOVENIA/CROATIA)	KB.T5902.024		
LCD Module			
	LCD Module	ASSY LCD MODULE 14 .1 WXGA NON GLARE QDI (N141V2 QD14TL01 REV 01) W/ ANT - TM	6M.TAAV5.003
	LCD Module-001	LCD 14 .1 WXGA NON GLARE QDI N141V2 QD14TL01 REV 01	LK.14109.004







TravelMate 2400/3210/3220/3230 FRU List

Picture	No.	Part Name and Description	Part Number
	LCD Module-007	LCD INVERTER	19.A70V5.001
	LCD Module-006	LCD WIRE CABLE	50.A70V5.005
	LCD Module-004	LCD PANEL WITH LOGO W/ANTENNA - TM	60.TAAV5.002
	LCD Module-005	LCD BEZEL	60.A70V5.006
	LCD Module-002, 003	LCD BRACKET SET	6K.A70V5.001
	LCD Module	ASSY LCD MODULE 14.1 WXGA NON GLARE CMO (N141I 1-L03) W/ANT-TM	6M.TAAV5.004
	LCD Module-001	LCD 14.1 WXGA NON GLARE CMO (N141I 1-L02)	LK.1410D.004
	LCD Module-007	LCD INVERTER	19.A70V5.001

TravelMate 2400/3210/3220/3230 FRU List

Picture	No.	Part Name and Description	Part Number
	LCD Module-006	LCD WIRE CABLE	50.A70V5.005
	LCD Module-004	LCD PANEL WITH LOGO W/ANTENNA - TM	60.TAAV5.002
	LCD Module-005	LCD BEZEL	60.A70V5.006
	LCD Module-002, 003	LCD BRACKET SET	6K.A70V5.001
	LCD Module	ASSY LCD MODULE 14 .1 WXGA NON GLARE QDI (N141V2 QD14TL01 REV 01) W/O ANT - TM	6M.TAAV5.007
	LCD Module-001	LCD 14 .1 WXGA NON GLARE QDI N141V2 QD14TL01 REV 01	LK.14109.004
	LCD Module-007	LCD INVERTER	19.A70V5.001
	LCD Module-006	LCD WIRE CABLE	50.A70V5.005





TravelMate 2400/3210/3220/3230 FRU List

Picture	No.	Part Name and Description	Part Number
	LCD Module-004	LCD PANEL WITH LOGO W/O ANTENNA - TM	60.TAAV5.003
	LCD Module-005	LCD BEZEL	60.A70V5.006
	LCD Module-002, 003	LCD BRACKET SET	6K.A70V5.001
	LCD Module	ASSY LCD MODULE 14.1 WXGA NON GLARE CMO (N141I 1-L03) W/O ANT-TM	6M.TAAV5.008
	LCD Module-001	LCD 14.1 WXGA NON GLARE CMO (N141I 1-L02)	LK.1410D.004
	LCD Module-007	LCD INVERTER	19.A70V5.001
	LCD Module-006	LCD WIRE CABLE	50.A70V5.005
	LCD Module-004	LCD PANEL WITH LOGO W/O ANTENNA - TM	60.TAAV5.003

TravelMate 2400/3210/3220/3230 FRU List

Picture	No.	Part Name and Description	Part Number
	LCD Module-005	LCD BEZEL	60.A70V5.006
	LCD Module-002, 003	LCD BRACKET SET	6K.A70V5.001
Mainboard			
	The System-251	MAINBOARD 915PM FOR VGA GLAN W/ READER PCMCIA SLOT W/O CPU MEMORY	LB.TAA02.002
		MAINBOARD 915GM UMA GLAN W/ READER PCMCIA SLOT W/O CPU MEMORY	LB.TAA02.001
		MAINBOARD 910GML UMA GLAN W/ PCMCIA SLOT W/O READER CPU MEMORY	LB.TA902.001
		MAINBOARD 915PM FOR VGA GLAN W/ READER PCMCIA SLOT W/O CPU MEMORY (for TravelMate 3220)	LB.TAM06.001
	NS	PCMCIA SLOT	22.A70V5.001
Memory			
	NS	MEMORY IFX 256MB/ 533MHZ, HYS64T32000HDL-3.7-A	KN.25602.023
		MEMORY DDRII533 256MB NANYA NT256T64UH4A0FN-37B	KN.25603.020
		MEMORY SAMSUNG 512MB/ 533MHZ, M470T3354BG0-CD5	KN.2560B.011
		MEMORY DDRII 533 256MB HYNIX HYMP532S64P6-C4	KN.2560G.006
		MEMORY IFX 512MB/ 533MHZ, HYS64T64020HDL-3.7-A	KN.51202.021
Heatsink			
	The System-007	CPU THERMAL	60.A70V5.007
	The System-251	VGA THERMAL	60.A70V5.008
Pointing Device			

TravelMate 2400/3210/3220/3230 FRU List

Picture	No.	Part Name and Description	Part Number
	Upper Case Assembly-005	TOUCHPAD	56.A70V5.001
Speaker			
	NS	SPEAKER SET (R&L)	23.A70V5.002
Miscellaneous			
	NS	LCD RUBBER PAD	47.A70V5.001
	NS	LCD SCREW PAD	47.A70V5.002
	NS	LCD RUBBER	47.A70V5.003
	NS	NAME PLATE - TM3210	47.TAAV5.001
	NS	NAME PLATE - TM3220	40.TAMV5.001
	NS	NAME PLATE - TM2400	47.TA9V5.001
	NS	RUBBER FOOT - ONE PIN	47.A70V5.004
	NS	RUBBER FOOT - TWO PINS	47.A70V5.005
SCREW			
SCREW	NS	SCREW M2*3(NL)	86.A70V5.001
SCREW	NS	SCREW M2*4	86.A70V5.002
SCREW	NS	SCREW M2*6	86.A70V5.003
SCREW	NS	SCREW M2*6(p Ni)	86.A70V5.004
SCREW	NS	SCREW M2.5*4(NL)	86.A70V5.005
SCREW	NS	SCREW M2.5*6(NL)	86.A70V5.006
SCREW	NS	SCREW M2.5*8(NL)	86.A70V5.007
SCREW	NS	SCREW M3*4 (NL)	86.A70V5.008
SCREW	NS	SCREW THERMAL SCREW ASSY	86.A70V5.009

Free Manuals Download Website

<http://myh66.com>

<http://usermanuals.us>

<http://www.somanuals.com>

<http://www.4manuals.cc>

<http://www.manual-lib.com>

<http://www.404manual.com>

<http://www.luxmanual.com>

<http://aubethermostatmanual.com>

Golf course search by state

<http://golfingnear.com>

Email search by domain

<http://emailbydomain.com>

Auto manuals search

<http://auto.somanuals.com>

TV manuals search

<http://tv.somanuals.com>