

TABLE OF CONTENTS

FOR YOUR SAFETY -----	1
SAFETY PRECAUTIONS -----	2
SPECIAL NOTES ON LCD MONITORS -----	3
BEFORE YOU OPERATE THE MONITOR -----	3
FEATURES -----	3
PACKING LIST -----	3
INSTALLATION INSTRUCTIONS -----	4
CONTROLS AND CONNECTORS -----	5
ADJUSTING THE VIEWING ANGLE -----	6
OPERATING INSTRUCTIONS -----	7
GENERAL INSTRUCTIONS -----	7
HOW TO ADJUST A SETTING -----	9
ADJUSTING THE PICTURE -----	10-11
PLUG AND PLAY -----	12
TECHNICAL SUPPORT(FAQ) -----	13-14
ERROR MESSAGE & POSSIBLE SOLUTION -----	15
APPENDIX -----	16
SPECIFICATIONS -----	16-17
FACTORY PRESET TIMING TABLE -----	18
CONNECTOR PIN ASSIGNMENT -----	19

41L1500-786-1A 英文

Before operating the monitor please read this manual thoroughly. This manual should be retained for future reference.

FCC Class B Radio Frequency Interference Statement
WARNING: (FOR FCC CERTIFIED MODELS)

NOTE: This equipment has been tested and found to comply with the limits for a Class B digital device, pursuant to Part 15 of the FCC Rules. These limits are designed to provide reasonable protection against harmful interference in a residential installation. This equipment generates, uses and can radiate radio frequency energy, and if not installed and used in accordance with the instructions, may cause harmful interference to radio communications. However, there is no guarantee that interference will not occur in a particular installation. If this equipment does cause harmful interference to radio or television reception, which can be determined by turning the equipment off and on, the user is encouraged to try to correct the interference by one or more of the following measures:

1. Reorient or relocate the receiving antenna.
2. Increase the separation between the equipment and receiver.
3. Connect the equipment into an outlet on a circuit different from that to which the receiver is connected.
4. Consult the dealer or an experienced radio/TV technician for help.

NOTICE:

1. The changes or modifications not expressly approved by the party responsible for compliance could void the user's authority to operate the equipment.
2. Shielded interface cables and AC power cord, if any, must be used in order to comply with the emission limits.
3. The manufacturer is not responsible for any radio or TV interference caused by unauthorized modification to this equipment. It is the responsibility of the user to correct such interference.

As an ENERGY STAR® Partner our company has determined that this product meets the ENERGY STAR® guidelines for energy efficiency.

WARNING:

To prevent fire or shock hazard, do not expose the monitor to rain or moisture. Dangerously high voltages are present inside the monitor. Do not open the cabinet. Refer servicing to qualified personnel only.

PRECAUTIONS

- Do not use the monitor near water, e.g. near a bathtub, washbowl, kitchen sink, laundry tub, swimming pool or in a wet basement.
- Do not place the monitor on an unstable trolley, stand, or table. If the monitor falls, it can injure a person and cause serious damage to the appliance. Use only a trolley or stand recommended by the manufacturer or sold with the monitor. If you mount the monitor on a wall or shelf, use a mounting kit approved by the manufacturer and follow the kit instructions.
- Slots and openings in the back and bottom of the cabinet are provided for ventilation. To ensure reliable operation of the monitor and to protect it from overheating, be sure these openings are not blocked or covered. Do not place the monitor on a bed, sofa, rug, or similar surface. Do not place the monitor near or over a radiator or heat register. Do not place the monitor in a bookcase or cabinet unless proper ventilation is provided.
- The monitor should be operated only from the type of power source indicated on the label. If you are not sure of the type of power supplied to your home, consult your dealer or local power company.
- The monitor is equipped with a three-pronged grounded plug, a plug with a third (grounding) pin. This plug will fit only into a grounded power outlet as a safety feature. If your outlet does not accommodate the three-wire plug, have an electrician install the correct outlet, or use an adapter to ground the appliance safely. Do not defeat the safety purpose of the grounded plug.
- Unplug the unit during a lightning storm or when it will not be used for long periods of time. This will protect the monitor from damage due to power surges.
- Do not overload power strips and extension cords. Overloading can result in fire or electric shock.
- Never push any object into the slot on the monitor cabinet. It could short circuit parts causing a fire or electric shock. Never spill liquids on the monitor.
- Do not attempt to service the monitor yourself; opening or removing covers can expose you to dangerous voltages and other hazards. Please refer all servicing to qualified service personnel
- To ensure satisfactory operation, use the monitor only with UL listed computers which have appropriate configured receptacles marked between 100 - 240V AC, Min. 3.5A.
- The wall socket shall be installed near the equipment and shall be easily accessible.
- For use only with the attached power adapter (output 12V DC) which have **UL, CSA** listed license.

SPECIAL NOTES ON LCD MONITORS

The following symptoms are normal with LCD monitor and do not indicate a problem.

NOTES

- Due to the nature of the fluorescent light, the screen may flicker during initial use. Turn off the Power Switch and then turn it on again to make sure the flicker disappears.
- You may find slightly uneven brightness on the screen depending on the desktop pattern you use.
- The LCD screen has effective pixels of 99.99% or more. It may include blemishes of 0.01% or less such as a missing pixel or a pixel lit all of the time.
- Due to the nature of the LCD screen, an afterimage of the previous screen may remain after switching the image, when the same image is displayed for hours. In this case, the screen is recovered slowly by changing the image or turning off the Power Switch for hours.

BEFORE YOU OPERATE THE MONITOR

FEATURES

- 38.1cm(15") TFT Color LCD Monitor
- Crisp, Clear Display for Windows
- **Recommended Resolutions: 1024 X 768 @60Hz**
- EPA ENERGY STAR®
- Ergonomic Design (TCO'99 Approved)
- Dual Input (DVI + Analog) (Only Dual-Input Model)
- Space Saving, Compact Case Design

CHECKING THE CONTENTS OF THE PACKAGE

The product package should include the following items:

1. LCD Monitor
2. Owner's Manual
3. Power Cord
4. D-SUB CABLE
5. DVI CABLE (Only Dual-Input Model)
6. External Adapter
7. Audio Cable

POWERCORD

Power Source:

1. Make sure the power cord is the correct type required in your area.
2. This LCD monitor has an External universal power supply that allows operation in either 100/120V AC or 220/240V AC voltage area (No user adjustment is required.)
3. Connect the AC-power cord into your LCD monitor's External Adapter input socket, and then plug the other end of External adapter to LCD monitor's DC-power-input. The AC-power cord may be connected to either a wall power outlet or the power outlet socket on your PC, depending on the type of power cord supplied with your LCD monitor.

NOTES

A certified power supply cord has to be used with this equipment. The relevant national installation and/or equipment regulations shall be considered. A certified power supply cord not lighter than ordinary polyvinyl chloride flexible cord according to IEC 60227 (designation H05VV-F 3G 0.75mm² or H05VVH2-F2 3G 0.75mm²) shall be used. Alternatively a flexible cord of synthetic rubber according to IEC 60245 (designation H05RR-F 3G 0.75mm²) may be used.

CONTROLS AND CONNECTORS

CABLE CONNECTIONS

Turn off your computer before performing the procedure below.

1. Connect the power adapter dc cable to the DC-In port on the back of the monitor.
2. Connect one end of the 15-pin D-Sub cable to the back of the monitor and connect the other end to the computer's D-Sub port.
3. (Only Dual-Input Model) Connect one end of the 24-pin DVI cable to the back of the monitor and connect the other end to the computer's DVI port.
4. Connect the audio cable between the monitor's audio input and the PC's audio output (green port).
5. Plug the power cable of your monitor into a nearby outlet. Plug the other end of the power cord into the power adapter.
6. Turn on your monitor and computer.

Caution: If the AC outlet is not grounded (with three holes), install the proper grounding adapter (not supplied).

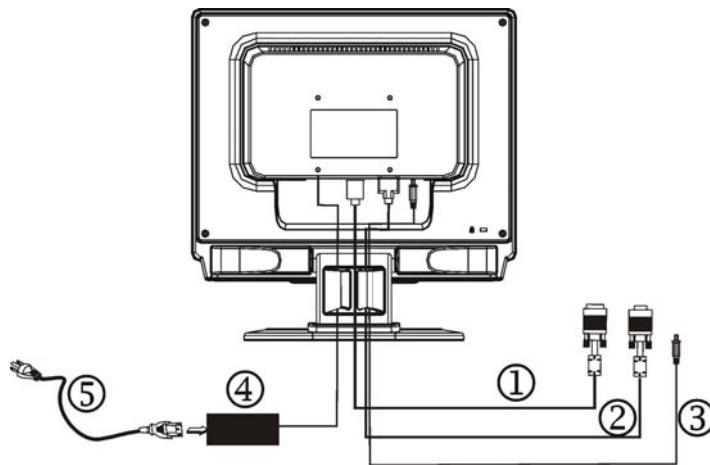

Figure 1 Connecting Cables

1.	D-SUB Cable	4.	External Adapter
2.	DVI Cable	5.	AC Power Cord
3.	Audio Cable		

ADJUSTING THE VIEWING ANGLE

- For optimal viewing it is recommended to look at the full face of the monitor, then to adjust the monitor's angle to your own preference.
- Hold the stand so you do not topple the monitor when you change the monitor's angle.
- You may adjust the monitor's angle from -5° to 20° .

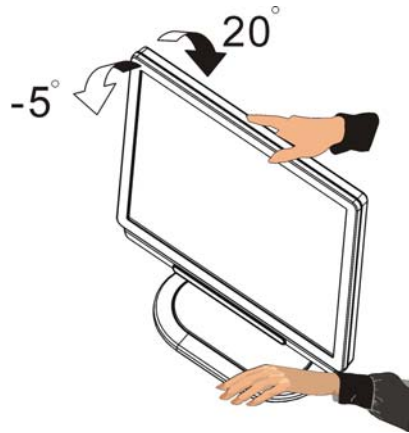

Figure 2

NOTES

- Do not touch the LCD screen when you change the angle. It may cause damage or break the LCD screen.
- Careful attention is required not to catch your fingers or hands when you change the angle.

OPERATING INSTRUCTIONS

GENERAL INSTRUCTIONS

Press the power switch to turn the monitor on or off. The other control knobs are located at front panel of the monitor (See Figure 3). By changing these settings, the picture can be adjusted to your personal preferences.

- The power cord should be connected.
- Connect the video cable from the monitor to the video card.
- Press the power switch to turn on the monitor. The power indicator LED will light up.

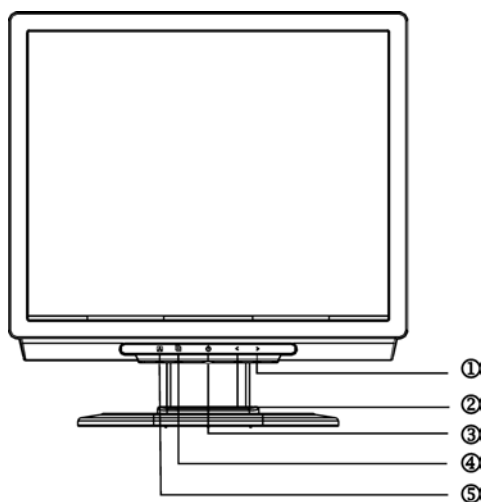







Figure 3 External Controls

EXTERNAL CONTROLS

1. >/ Volume	4.  /MENU/ENTER
2. </ Volume	5.  /Auto Adjust Key/Exit
3.  /Power Key	

FRONT PANEL CONTROL

- /Power Key:
Press this knob to switch ON/OFF of monitor's power.
- /MENU/ENTER :
Activate OSD menu when OSD is OFF or activate/de-activate adjustment function when OSD is ON or Exit OSD menu when in Volume Adjust OSD status.
- </Volume:
Activates the volume control when the OSD is OFF or navigate through adjustment icons when OSD is ON or adjust a function when function is activated.
- >/Volume:
Activates the volume control when the OSD is OFF or navigate through adjustment icons when OSD is ON or adjust a function when function is activated.
- /Auto Adjust Key/Exit:
 1. When OSD menu is in active status, this button will act as EXIT-KEY (EXIT OSD menu)
 2. When OSD menu is in off status, press this button over 2 seconds to activate the Auto Adjustment function.
The Auto Adjustment function is used to set the HPos, VPos, Clock and Focus.
- **Power Indicator:**
 - Blue — Power On mode.
 - Orange — Power Saving
 - Light Blue — Power Off mode.

NOTES

- Do not install the monitor in a location near heat sources such as radiators or air ducts, or in a place subject to direct sunlight, or excessive dust or mechanical vibration or shock.
- Save the original shipping box and packing materials, as they will come in handy if you ever have to ship your monitor.
- For maximum protection, repackage your monitor as it was originally packed at the factory.
- To keep the monitor looking new, periodically clean it with a soft cloth. Stubborn stains may be removed with a cloth lightly dampened with a mild detergent solution. Never use strong solvents such as thinner, benzene, or abrasive cleaners, since these will damage the cabinet. As a safety precaution, always unplug the monitor before cleaning it.

HOW TO ADJUST A SETTING

1. Press the MENU key to make the OSD window appear.
2. Press < or > to select the desired function.
3. Press the MENU key to select the function that you want to adjust.
4. Press < or > to change the settings of the current function.
5. To exit and save, select the exit functions,. If you want to adjust any other function, repeat steps 2-4.



I. Analog-Only Mode



II. Dual-Input Model, Analog Signal Input











III. Dual-Input Model, Digital Signal Input

ADJUSTING THE PICTURE

The description for function control icons

Main Menu Icon	Sub Menu Icon	Sub Menu Item	Description
		Contrast	Adjusts the contrast between the foreground and background of the screen image.
		Brightness	Adjusts the background brightness of the screen image.
		Focus	Adjust picture Focus (available in Analog mode only).
		Clock	Adjust picture Clock (available in Analog mode only).
		H. Position	Adjust the horizontal position of the picture (available in Analog mode only).
		V. Position	Adjust the vertical position of the picture (available in Analog mode only).
	N/A	Warm	Set the color temperature to warm white.
	N/A	Cool	Set the color temperature to cool white.
		User / Red	Adjusts Red/Green/blue intensity.
		User / Green	
		User / Blue	

	N/A	English	Multi-Language selection
	N/A	繁體中文	
	N/A	Deutsch	
	N/A	Français	
	N/A	Español	
	N/A	Italiano	
	N/A	简体中文	
	N/A	日本語	
	H. Position	Adjust the horizontal position of the OSD.	
		V. Position	Adjust the vertical position of the OSD.
			OSD-Timeout
 (Analog-Only Model)	N/A	Auto Config	Auto Adjust the H/V Position, Focus and Clock of picture.
 (Dual-Input Model)	N/A	Analog	Select input signal from analog (D-Sub).
	N/A	Digital	Select input signal from digital (DVI).
	N/A	Information	Show the resolution, H/V frequency and input port of current inputs timing.
	N/A	Reset	Clears all old status of auto-configuration And re-does auto-configuration.
	N/A	Exit	Save user adjustment and exit OSD menu.

PLUG AND PLAY

Plug & Play DDC1/2B Feature

This monitor is equipped with VESA DDC1/2B capabilities according to the VESA DDC STANDARD. This allows the monitor to inform the host system of its identity and, depending on the level of DDC used, to communicate additional information about its display capabilities. The communication channel is divided in two levels, DDC1 and DDC2B.

The DDC1 is a unidirectional data channel from the display to the host that continuously transmits EDID information. The DDC2B is a bidirectional data channel based on the I²C protocol. The host can request EDID information over the DDC2B channel.

THIS MONITOR WILL NOT WORK IF THERE IS NO VIDEO INPUT SIGNAL. IN ORDER FOR THIS MONITOR TO OPERATE PROPERLY, THERE MUST BE A VIDEO INPUT SIGNAL.

This monitor meets the Green monitor standards as set by the Video Electronics Standards Association (VESA) and/or the United States Environmental Protection Agency (EPA) and The Swedish Confederation Employees (NUTEK). This feature is designed to save electrical energy by reducing power consumption when there is no video-input signal present. When there is no video input signal this monitor, following a time-out period, will automatically switch to an OFF mode. This reduces the monitor's internal power supply consumption. After the video input signal is restored, full power is restored and the display is automatically redrawn. This is similar to a "Screen Saver" feature except the display is completely off. The display is restored by pressing a key on the keyboard, or clicking the mouse.

USING THE RIGHT POWER CORD:

The accessory power cord for the Northern American region is the wallet plug with NEMA 5-15 style and is UL listed and CSA labeled. The voltage rating for the power cord shall be 125 volts AC.

Supplied with units intended for connection to power outlet of personal computer: Please use a cord set consisting of a minimum No. 18 AWG, type SJT or SVT three conductors flexible cord. One end terminates with a grounding type attachment plug, rated 10A, 250V, CEE-22 male configuration. The other end terminates with a molded-on type connector body, rated 10A, 250V, having standard CEE-22 female configuration.

Please note that power supply cord needs to use VDE 0602, 0625, 0821 approval power cord in European countries.

TECHNICAL SUPPORT (FAQ)

Problem & Question	Possible Solution
Power LED is not on	*Check that the Power Switch is in the ON position *Power Cord should be connected
No Plug & Play	*Check that the PC system is Plug & Play compatible *Check that the Video Card is Plug & Play compatible *Check that the D-15 plug pin of Video Cable is not bent.
Picture is fuzzy	*Adjust the Contrast and Brightness Controls.
Picture bounces or a wave pattern is present in the picture	*Move electrical devices that may cause electrical interference.
The power LED is ON (light blue) but there's no video or no picture.	*The Computer Power Switch should be in the ON position. *The Computer Video Card should be snugly seated in its slot. *Make sure the video cable is properly connected to the computer. *Inspect the video cable and make sure none of the pins are bent. *Make sure the computer is operational by hitting the CAPS LOCK key on the keyboard while observing the CAPS LOCK LED. The LED should either turn ON or OFF after hitting the CAPS LOCK key.
Missing one of the primary colors (RED, GREEN, or BLUE)	*Inspect the video cable and make sure that none of the pins are bent.

Screen image is not centered or sized properly.	*Adjust pixel frequency (CLOCK) and FOCUS or press hot-key (AUTO).
Picture has color defects (white does not look white)	*Adjust RGB color or select color temperature
Horizontal or vertical disturbances on the screen	*Use win 95/98 shut-down mode Adjust CLOCK and FOCUS or perform hot-key (AUTO-key).

CLOCK (pixel frequency) controls the number of pixels scanned by one horizontal sweep. If the frequency is not right, the screen will show vertical stripes and the picture will not have the right width.

FOCUS adjusts the phase of the pixel clock signal. With a wrong phase adjustment the picture has horizontal disturbances on light pictures.

For FOCUS and CLOCK adjustment use "dot-pattern" or win 95/98 shut-down mode pattern.

ERROR MESSAGE & POSSIBLE SOLUTION

CABLE NOT CONNECTED:

1. Check that the signal-cable is properly connected, if the connector is loose, tighten the connector's screws.
2. Check the signal-cable's connection pins for damage.

INPUT NOT SUPPORTS:

Your computer has been set to unsuitable display mode, set the computer to Display mode given in the following table(See page 18).

APPENDIX

SPECIFICATIONS

LCD Panel	Driving system	TFT Color LCD
	Size	38.1cm(15")
	Pixel pitch	0.297mm(H) × 0.297mm(V)
	Viewable angle	120° (H) 110° (V)
	Brightness	250 cd/m ² (typ.)
	Contrast Ratio	400:1(typ.)
	Response time (Tr+Tf)	25 (8+17) ms (typ.)
Input	Video	R,G,B Analog Interface Digital Interface (Only Dual-Input Model)
	H-Frequency	30kHz – 60kHz
	V-Frequency	55-75Hz
Display Colors		16.2 million Colors
Dot Clock		80MHz
Max. Resolution		1024 × 768@75 Hz
Plug & Play		VESA DDC1/2B™
EPA ENERGY STAR®	ON Mode	≤30W
	OFF Mode	≤3W
Audio output		Rated Power 1.5W rms (Per channel)
Input Connector		D-Sub 15pin
		DVI 24 pin (Only Dual-Input Model)
Input Video Signal		Analog:0.7Vp-p(standard),75 OHM, Positive
		Digital signal (Only Dual-Input Model)
Maximum Screen Size		Horizontal : 12.0"(304.1mm) Vertical : 9.0"(228.1mm)
Power Source		100~240VAC,47~63Hz
Environmental Considerations		Operating Temp: 0°C to 50°C Storage Temp.: -20°C to 60°C Operating Humidity : 10% to 90%
Weight (N. W.)		3.7kg
Dimension		338 (W) × 347 (H) × 154 (D)mm

External Controls:	Switch	<ul style="list-style-type: none"> • Power Switch • MENU/ ENTER • >/Volume • </Volume • Auto Adjust Key
	Functions	<ul style="list-style-type: none"> • Contrast • Brightness • Focus • Clock • H.Position • V.Position • (Warm) Color • (Cool)Color • RGB Color temperature • Language • OSD Position .Timeout • Auto Config (only Analog-input Model) • Input signal Selection (only Dual-Input Model) • Display Information • Reset • Exit
Regulatory Compliance		UL, CUL, FCC, TÜV/GS, VCCI, CE, CCC, ISO13406-2, TCO'99, MPR II

Preset Display Modes

VIDEO MODE		RESOLUTION	HORIZONTAL FREQUENCY (kHz)	VERTICAL FREQUENCY (Hz)
VESA	VGA	640 × 480	31.469	59.940
		640 × 480	37.500	75.000
		640 × 480	37.861	72.809
	SVGA	800 × 600	35.156	56.250
		800 × 600	37.879	60.317
		800 × 600	46.875	75.000
	XGA	1024 × 768	48.363	60.004
		1024 × 768	56.476	70.069
		1024 × 768	60.023	75.029
IBM	DOS	720 × 400	31.469	70.087
MAC	XGA	1024 × 768	48.780	60.001
		1024 × 768	60.241	74.927

CONNECTOR PIN ASSIGNMENT

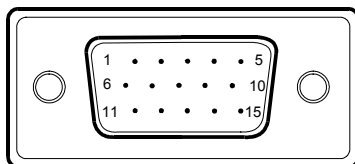

15 - Pin Color Display Signal Cable

PIN NO.	DESCRIPTION	PIN NO.	DESCRIPTION
1.	Red	9.	+5V
2.	Green	10.	Logic Ground
3.	Blue	11.	Monitor Ground
4.	Monitor Ground	12.	DDC-Serial Data
5.	DDC-Return	13.	H-Sync
6.	R-Ground	14.	V-Sync
7.	G-Ground	15.	DDC-Serial Clock
8.	B-Ground		

(Dual-Input Model)

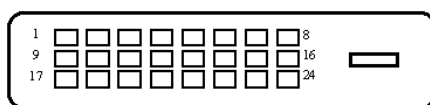

24 - Pin Color Display Signal Cable

PIN NO.	DESCRIPTION	PIN NO.	DESCRIPTION
1.	TMDS Data 2-	13.	TMDS Data 3+
2.	TMDS Data 2+	14.	+5V Power
3.	TMDS Data 2/4 Shield	15.	Ground(for+5V)
4.	TMDS Data 4-	16.	Hot Plug Detect
5.	TMDS Data 4+	17.	TMDS Data 0-
6.	DDC Clock	18.	TMDS Data 0+
7.	DDC Data	19.	TMDS Data 0/5 Shield
8.	Analog Vertical sync	20.	TMDS Data 5-
9.	TMDS Data 1-	21.	TMDS Data 5+
10.	TMDS Data 1+	22.	TMDS Clock Shield
11.	TMDS Data 1/3 Shield	23.	TMDS Clock +
12.	TMDS Data 3-	24.	TMDS Clock -

Free Manuals Download Website

<http://myh66.com>

<http://usermanuals.us>

<http://www.somanuals.com>

<http://www.4manuals.cc>

<http://www.manual-lib.com>

<http://www.404manual.com>

<http://www.luxmanual.com>

<http://aubethermostatmanual.com>

Golf course search by state

<http://golfingnear.com>

Email search by domain

<http://emailbydomain.com>

Auto manuals search

<http://auto.somanuals.com>

TV manuals search

<http://tv.somanuals.com>