

TABLE OF CONTENTS

Special notes on LCD monitors	1
Introduction	2
Features	2
Unpacking	3
Attaching/Removing the base	4
Screen position adjustment	4
Connecting the power cord	5
Safety precaution	5
Cleaning your monitor	5
Preset modes	6
Power saving	7
DDC	7
Installation	8
User controls	9
Troubleshooting	13
Specification	15

For more information and help in recycling, please visit the following websites:

Worldwide: <http://global.acer.com/about/sustainability.htm>

SPECIAL NOTES ON LCD MONITORS

The following symptoms are normal with LCD monitor and do not indicate a problem.

NOTES

- Due to the nature of the fluorescent light, the screen may flicker during initial use. Turn off the Power Switch and then turn it on again to make sure the flicker disappears.
- You may find slightly uneven brightness on the screen depending on the desktop pattern you use.
- The LCD screen has effective pixels of 99.99% or more. It may include blemishes of 0.01% or less such as a missing pixel or a pixel lit all of the time.
- Due to the nature of the LCD screen, an afterimage of the previous screen may remain after switching the image, when the same image is displayed for hours. In this case, the screen is recovered slowly by changing the image or turning off the Power Switch for hours.

JAPANESE MATERIAL CONTENT DECLARATION

A Japanese regulatory requirement, defined by specification JIS 0950, 2005, mandates that manufactures provide Material Content Declarations for certain categories of electronic products offered for sale after July 1, 2006.

To view the JIS C 0950 material declaration for this product. Visit

<http://global.acer.com/about/sustainability.htm>

INTRODUCTION

Congratulations for purchasing model AL1716W, a high performance 17-inch color TFT LCD monitor. The AL1716W monitor provides flicker-free and color images at optional resolutions. Through this user guide, we will introduce you step-by-step all the features, functions and technical specifications of the LCD monitor. Surely you will have a refreshing experience working with the monitor.

FEATURES

The AL1716W is a 17-inch TFT LCD monitor that is intelligent, microprocessor-based and ergonomically designed display, compatible with most analog RGB (Red, Green, Blue) and Digital display standards, including PS/V, PS/2, optional for Apple Macintosh Centris, Quadra, and Macintosh II family signals. The LCD monitor is capable of displaying crisp and vibrant color graphics with VGA, SVGA, XGA, SXGA (non-interlaced), WXGA and most Macintosh compatible color video cards.

- The monitor is able to properly function even in case of upgrade video cards or software because of the wide auto-scanning compatibility range without requiring to buy a new monitor.
- The internal microprocessor digitally controls auto-scanning. For horizontal scan frequencies between 31KHz and 83KHz, and vertical scan frequencies between 56 Hz and 76 Hz. In each frequency mode, the microprocessor-based circuitry allows the monitor to function at the precision-of a fixed frequency.
- The resident memory allows for storing factory default settings and also additional user adjustment parameters.
- The maximum resolution achievable is WXGA (1440 x 900), best suited for Windows applications
- The compact and sleek cabinet design saves lot of your desk space and makes your desk look neat and tidy.

UNPACKING

Please check the following items are present when you unpack the box, and save the packing materials in case you will need to ship or transport the monitor in future.

- LCD Monitor

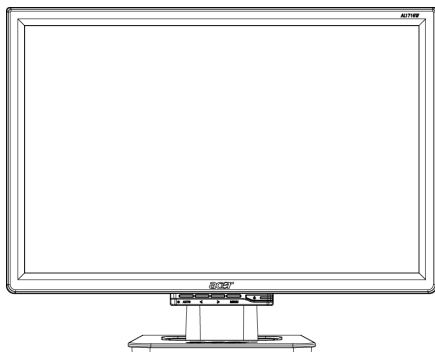

- AC Power Cord

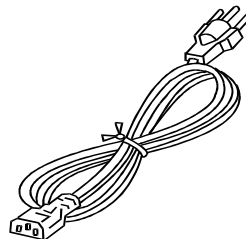

- DVI Cable
(Only Dual-Input Model)

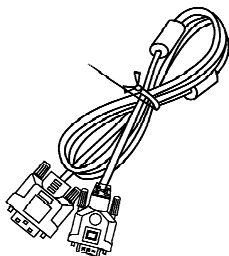

- D-SUB Cable



- User Manual



- Quick Start Guide



Attaching / Removing the Base

Install:

Align the four hooks on the bottom of the monitor with the corresponding slots on the bottom of the base.

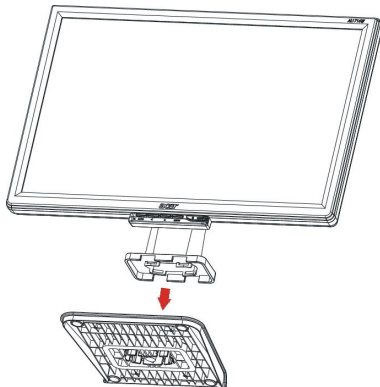

Remove:

Depress the four hooks as indicated first before removing the base and follow the arrow direction to remove it.



SCREEN POSITION ADJUSTMENT

In order to optimize the best viewing position, you can adjust the tilt of the monitor by using both of your hands to hold the edges of the monitor as shown in the figure below. The monitor can be adjusted to 15 degrees up or 5 degrees down as indicated by arrow below.

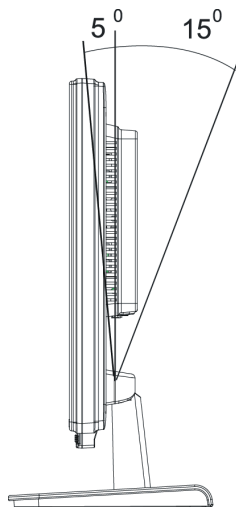

CONNECTING THE POWER CORD

- Check first to make sure that the power cord you use is the correct type required for your area.
- This monitor has a universal power supply that allows operation in either 100/120V AC or 220/240 V AC voltage area. No user-adjustment is required.
- Plug one end of the power cord to the AC Inlet, plug another end to a proper AC outlet.
- For unit using at 120 V AC:
Use a UL Listed Cord Set, Type SVT wire and plug rated 10 A/125 V.
- For unit using at 220/240 V AC (outside of U.S.):
Use a Cord Set consisting of H05VV-F cord and plug rated 10 A, 250 V. The cord set should have the appropriate safety approvals for the country in which the equipment will be installed.

SAFETY PRECAUTION

- *Avoid placing the monitor, or any other heavy object, on the power cord to avoid damage to the cable.*
- *Do not expose the monitor to rain, excessive moisture, or dust.*
- *Do not cover the ventilation slots or openings of the monitor. Always put the monitor in a place where there is adequate ventilation.*
- *Avoid placing the monitor against a bright background or where sunlight or other light sources may reflect on the face of the monitor. Place the monitor just below eye level.*
- *Handle with care when transporting the monitor.*
- *Refrain from giving shock or scratch to the screen, as screen is fragile.*

CLEANING YOUR MONITOR

Please carefully follow the below guidelines when cleaning the monitor.

- Always unplug the monitor before cleaning.
- Use a soft cloth to wipe the screen and cabinet front and sides.

PRESET MODES

To reduce the need for adjustment for different modes, the monitor has default setting modes that are most commonly used as given in the table below. For optimum adjustment, the user is suggested to perform the Auto Setup under Windows "Full Screen" pattern or using the pattern in the floppy disk provided. When none of the mode is matched, the user can store their preferred modes in the user modes. The monitor is capable of storing up to 9 user modes. The only condition to store as a user mode is the new display information must have 1 KHz difference for horizontal frequency or 1 Hz for vertical frequency or the sync signal polarities are different from the default modes.

Mode	Resolution			H. Freq. (KHz)	Band Width (MHz)	Polarity	
						H	V
1	VGA	720 x 400	70 Hz	31.47	28.322	-	+
2	VGA	640 x 480	60 Hz	31.47	25.175	-	-
3	MAC	640 x 480	67 Hz	35.00	32.24	-	-
4	VGA	640 x 480	72 Hz	37.86	31.5	-	-
5	VESA	640 x 480	75 Hz	37.50	31.5	-	-
6	VESA	800 x 600	56 Hz	35.16	36.00	+	+
7	VESA	800 x 600	60 Hz	37.88	40	+	+
8	VESA	800 x 600	72 Hz	48.08	50.00	-	-
9	VESA	800 x 600	75 Hz	46.88	49.5	+	+
10	MAC	832 x 624	75 Hz	49.73	57.28	-	-
11	VESA	1024 x 768	60 Hz	48.36	65	-	-
12	VESA	1024 x 768	70 Hz	56.48	75	-	-
13	VESA	1024 x 768	75 Hz	60.02	78.75	+	+
14	MAC	1125 x 870	75 Hz	68.68	100	-	-
15		1280 x 720	60 Hz	44.772	74.50	-	+
16		1280 x 800	75 Hz	62.63	106.22	-	-
17	WXGA	1440 x 900	75 Hz	70.635	136.75	-	+
18	WXGA	1440 x 900	60 Hz	55.935	106.5	-	+

POWER SAVING

The monitor will be driven into “Power Saving” mode by the control signal from the display controller, as indicated by the amber-color power LED.

State	Power Consumption	LED Light
ON	Normal	Green
Power Saving Mode	<2 W	Amber

The power saving states will be kept until a control signal has been detected or the keyboard or mouse is activated. The recovery time from Active OFF state back to ON state is around 5 seconds.

DDC

To make your installation easier, the monitor is able to Plug and Play with your system if your system also supports DDC protocol. The DDC (Display Data Channel) is a communication protocol through which the monitor automatically informs the host system about its capabilities, for example, supported resolutions and corresponding timing. The monitor supports DDC2B standard.

INSTALLATION

To install the monitor to your host system, please follow the steps as given below:

Steps

1. 1-1 Connect Video Cable
 - a. Make sure both the monitor and computer are powered-OFF.
 - b. Connect the VGA video cable to the computer.
- 1-2 Digital Cable (Only Dual-Input Model)
 - a. Make sure both the monitor and computer are powered-OFF.
 - b. Connect one end of the 24-pin DVI cable to the back of the monitor and connect the other end to the computer's port.
2. Connect power cord
Connect the power cord to the monitor, then to a properly grounded AC outlet.
3. Power-ON Monitor and Computer
Power-ON the monitor first, then power-ON the computer.
This sequence is very important.
4. If the monitor still does not function properly, please refer to the troubleshooting section to diagnose the problem.

Please don't open the cover

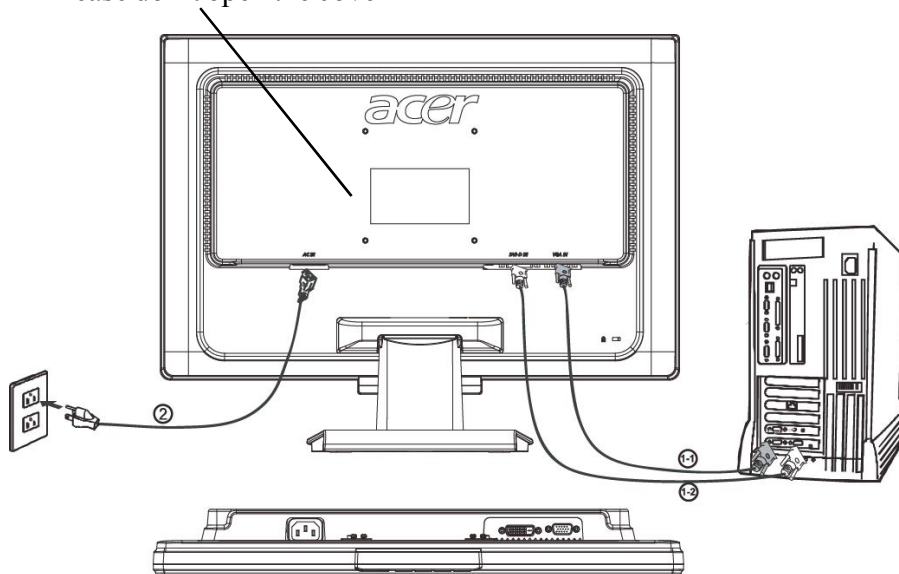

USER CONTROLS

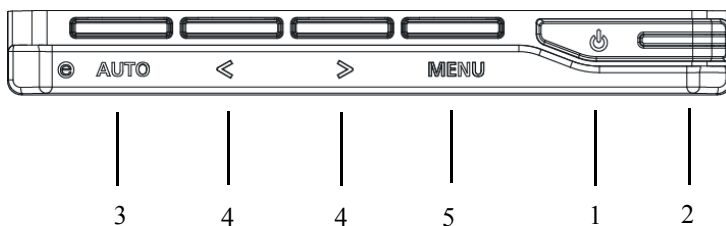

Front Panel Controls

1. Power Switch:

To turn ON or OFF the power.

2. Power LED:

Lights up to indicate the power is turned ON.

3. Empowering / Exit:

- 1) When OSD menu is in active status, this button will act as EXIT-KEY (EXIT OSD menu).
- 2) When OSD menu is in off status, press this button to select scenario mode.

4. </>

Press < or > to select the desired function.

Press < or > to change the settings of the current function.

5. MENU / ENTER:

Activate OSD menu when OSD is OFF or activate/de-activate adjustment function when OSD is ON or Exit OSD menu when in Volume Adjust OSD status.

HOW TO ADJUST A SETTING

1. Press the MENU-button to activate the OSD window.
2. Press < or > to select the desired function.
3. Press the MENU-button to select the function that you want to adjust.
4. Press < or > to change the settings of the current function.
5. To exit and save, select the exit function. If you want to adjust any other function, repeat steps 2-4.



I. Analog Signal Input



















II. Digital Signal Input

ADJUSTING THE PICTURE

The descriptions for function control LEDs

Main Menu Icon	Sub Menu Icon	Sub Menu Item	Description
		Contrast	Adjusts the contrast between the foreground and background of the screen image.
		Brightness	Adjusts the background brightness of the screen image.
		Focus	Adjusts picture Focus. (available in Analog mode only)
		Clock	Adjusts picture Clock. (available in Analog mode only)

Main Menu Icon	Sub Menu Icon	Sub Menu Item	Description
		H. Position	Adjust the horizontal position. (available in Analog mode only)
		V. Position	Adjust the vertical position. (available in Analog mode only)
	N/A	Warm	Set the color temperature to warm white.
	N/A	Cool	Set the color temperature to cool white.
		User /Red	Adjusts Red/Green/Blue intensity.
		User/Green	
		User/Blue	
	N/A	English	Multi-language selection.
	N/A	繁體中文	
	N/A	Deutsch	
	N/A	Francais	
	N/A	Espanol	
	N/A	Italiano	
	N/A	简体中文	
	N/A	日本語	

Main Menu Icon	Sub Menu Icon	Sub Menu Item	Description
		H. Position	Adjust the horizontal position of the OSD.
		V. Position	Adjust the vertical position of the OSD.
		OSD Timeout	Adjust the OSD timeout.
	N/A	Analog	Select input signal from analog (D-Sub)
	N/A	Digital	Select input signal from digital (DVI)
	N/A	DDC/CI	Turn ON/OFF DDC/CI support
	N/A	Information	Show the resolution, H/V frequency and input port of current input timing.
	N/A	Reset	Clear each old status of Auto-configuration and set the color temperature to Cool.
	N/A	Exit	Save user adjustment and OSD disappear.

TROUBLESHOOTING

Before sending your LCD monitor for servicing, please check the troubleshooting list below to see if you can self-diagnose the problem.

(VGA Mode)

Problems	Current Status	Remedy
No Picture	LED ON	<ul style="list-style-type: none"> Using OSD, adjust brightness and contrast to maximum or reset to their default settings.
	LED OFF	<ul style="list-style-type: none"> Check the power switch.
		<ul style="list-style-type: none"> Check if AC power cord is properly connected to the monitor.
	LED displays amber color	<ul style="list-style-type: none"> Check if video signal cable is properly connected at the back of monitor.
<ul style="list-style-type: none"> Check if the power of computer system is ON. 		
Abnormal Picture	Unstable Picture	<ul style="list-style-type: none"> Check if the specification of graphics adapter and monitor is in compliance which may be causing the input signal frequency mismatch.
	Display is missing, center shift, or too small or too large in display size	<ul style="list-style-type: none"> Using OSD, adjust RESOLUTION, CLOCK, CLOCK-PHASE, H-POSITION and V-POSITION with non-standard signals.
		<ul style="list-style-type: none"> Using OSD, in case of missing full-screen image, please select other resolution or other vertical refresh timing.
		<ul style="list-style-type: none"> Wait for a few seconds after adjusting the size of the image before changing or disconnecting the signal cable or powering OFF the monitor.

(DVI Mode)

Problems	Current Status	Remedy
No Picture	LED ON	<ul style="list-style-type: none">Using OSD, adjust brightness and contrast to maximum or reset to their default settings.
	LED OFF	<ul style="list-style-type: none">Check the power switch.
		<ul style="list-style-type: none">Check if AC power cord is properly connected to the monitor.
	LED displays amber color	<ul style="list-style-type: none">Check if video signal cable is properly connected at the back of monitor.
		<ul style="list-style-type: none">Check if the power of computer system is ON.

SPECIFICATION

LCD Panel	Driving system	TFT Color LCD
	Size	17" wide
	Pixel pitch	0.255mm(H)x 0.255mm(V)
	Brightness	270cd/m ² (Typical)
	Contrast	500:1(Typical)
	Viewable angle	140 ⁰ (H) 130 ⁰ (V)
	Response time	8 ms (Typical)
	Video	R,G,B Analog Interface
	H-Frequency	31KHz - 83KHz
	V-Frequency	56-76Hz
Display Colors		26K Colors
Dot Clock		135MHz
Max. Resolution		1440 x 900 @60Hz
Plug & Play		VESA DDCCI/DDC2B
EPA ENERGY STAR	ON Mode	<35W
	OFF Mode	≤ 1W
Input Connector		D-Sub
		DVI-D 24pin (Only Dual-Input Model)
Input Video Signal		Analog:0.7Vp-p(standard), 75 OHM, Positive
		Digital signal (Only Dual-Input Model)
Maximum Screen Size		Horizontal : 367.2mm Vertical : 229.5mm
Power Source		100-240VAC, 50/60Hz, 0.9A

Environmental Considerations		Operating Temp: 5 ^o to 35 ^o C Storage Temp.: -20 ^o to 60 ^o C Operating Humidity: 10% to 85%
Dimensions		404.1(W) x 334.6(H) x 158.8(D)mm
Weight (N. W.)		3.5kg Unit (net)
External Controls:	Switch	Auto Adjust Key < / > Power Button MENU/ Exit
	Functions	Contrast Brightness Focus Clock H.Position V.Position Language Auto configuration (only Analog input model) Input signal Selection (only Dual input model) (Warm) Color (Cool) Color RGB Color temperature Reset OSD position . timeout Display information Exit
Power Consumption (Maximum)		35 Watts
Regulatory Compliance		CUL, FCC, VCCI, CCC, MPR II, CE, TUV/GS, UL, ISO13406-2

* All specifications are subject to change without notice.

Free Manuals Download Website

<http://myh66.com>

<http://usermanuals.us>

<http://www.somanuals.com>

<http://www.4manuals.cc>

<http://www.manual-lib.com>

<http://www.404manual.com>

<http://www.luxmanual.com>

<http://aubethermostatmanual.com>

Golf course search by state

<http://golfingnear.com>

Email search by domain

<http://emailbydomain.com>

Auto manuals search

<http://auto.somanuals.com>

TV manuals search

<http://tv.somanuals.com>