

Service Manual

LCD Monitor Acer H243H

Table of Contents

- Important Safety Notice02
- 01 Product Specification03
- 02 Flat Panel Specification 15
- 03 Exploded Diagram36
- 04 Troubleshooting37
- 05 Spare Parts List42
- 06 Schematics and Layouts.....43
- 07 Assembly and Disassembly46

Appendix : User’s manual

Copyright
 Copyright 2006 InnoLux Tech. Corp. Ltd

All Rights Reserved

This manual may not, in whole or in part, be copied, Photocopied, reproduced, translated, or converted to any electronic or machine readable form without prior written permission of InnoLux Tech. Corp. Ltd.

Acer H243H Service Manual

Important Safety Notice

1. Safety precautions

This monitor is manufactured and tested on a ground principle that a user's safety comes first. However, improper used or installation may cause damage to the monitor as well as to the user.

Warning:

- This monitor should be operated only at the correct power sources indicated on the label on the rear of the monitor. If you're unsure of the power supply in you residence, consult your local dealer or Power Company.
- Do not try to repair the monitor by yourself, as it contains no user-serviceable parts. This monitor should only be repaired by a qualified technician.
- Do not remove the monitor cabinet. There are high-voltage parts inside that may cause electric shock to human bodies.
- Stop using the monitor if the cabinet is damaged. Have it checked by a service technician.
- Put your monitor only in a lean, cool, dry environment. If it gets wet, unplug the power cable immediately and consult your closed dealer.
- Always unplug the monitor before cleaning it. Clean the cabinet with a clean, dry cloth. Apply non-ammonia based cleaner onto the cloth, not directly onto the class screen.
- Do not place heavy objects on the monitor or power cord.

2. Product safety notice

Many electrical and mechanical parts in this chassis have special safety visual inspections and the protection afforded by them cannot necessarily be obtained by using replacement components rated for higher voltage, wattage, etc. Before replacing any of these components read the parts list in this manual carefully. The use of substitute replacement parts, which do not have the same safety characteristics as specified in the parts list, may create shock, fire, or other hazards.

3. Service notes

- When replacing parts or circuit boards, clamp the lead wires around terminals before soldering.
- Keep wires away from high voltage, high temperature components and sharp edges.
- Keep wires in their original position so as to reduce interference.
- Adjustment of this product please refers to the user' manual.

01 Product Specification

1. General:

H243H is designed with LVDS interface and VGA/DVI-D/HDMI input, it featured with embedded universal AC power supplies and audio input. It's a green product and meets all ROHS standard. The power button and display control buttons are on the front of the monitor. The monitors shall automatically to display lower resolution video modes into 1920x1080 full screen display. The image can be adjusted through OSD control. It support HDCP and color management function.

1.1 Main Features

Maximum resolution	: 1920(x3) x 1080 @ 60Hz
Back light system	: 4 CCFL (top & bottom edge side)
Pixel pitch	: 276.75 um (H) x 276.75 um (V)
Display area	: 531.36mm (H) x 298.89mm (V)
Brightness	: 300cd/m ² (TYP.)
Contrast ratio	: 1000:1 (TYP.) (1)
DCR	: 40000:1 (Max)
Response time (Tr+Tf)	: 5ms (TYP. ON/OFF) (2) 2ms (Gray to Gray)
Viewing angle	: 170° (H)/ 160°(V), (TYP.) (3)
Input interface	: Analog (D-sub 15 pin) Digital Option (DVI-D 24 pin & HDMI 19Pin)
Power management	: Compatible with VESA DPMS
Plug & Play	: VESA DDCCI
OSD language	: English, French, Spanish, Italian, Deutsch, Simplified Chinese, Traditional Chinese, Japanese (Dutch, Finnish, Russian depend on sale region)
Universal AC power supply	

Note (1)(2)(3): This item spec depend on the LCD panel.

1.2 Accessories

AC Power Cord	: 1.8 m. (Black. Cord type depend on sale region)
VGA cable	: 1.8 m. (15 pin D-SUB, black cable with blue male connector)
User manual	: English (640Mb CD)
Warranty card	:
DVI cable (option)	: 1.8 m. (18+1 pin, black cable with white connector)
HDMI cable (option)	: 1.8 m. (19 pin, black cable with white connector)

2. Operation Specifications

The unit should suffer no visible cosmetic damage and should operate with no degradation in display quality during exposure to the operating conditions and after exposure to the non-operating conditions, in any sequence.

2.1 Environmental conditions

2.1.1 Operating:

Temperature range	: 0°C to 50°C
Relative humidity	: 5% to 90%

2.1.2 Storage ^{note 1}:

Temperature range : -20°C to 60°C
 Humidity range : 5% to 90%

2.1.3 Altitude ^{note 2}

Operating 10000 ft (Ta=50, t=24h)
 Storage 30000 ft (Ta=30, t=24h)

Note 1: Temperature and relative humidity range must be in the area shown as the following figure due to panel limited

Note 2: Altitude spec must not over panel spec.

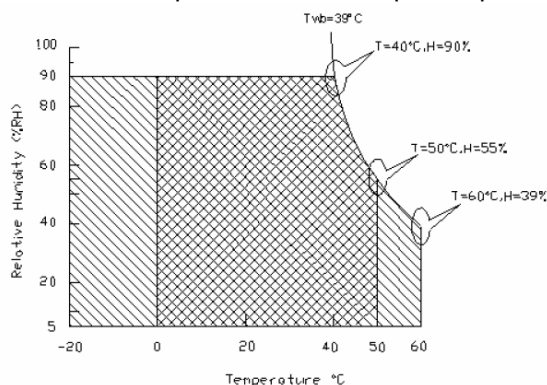

Operating Range Storage Range +

2.2 Safety, EMC, Ergonomics and Compatibility Requirements

Safety & EMC	MET, CB, Bauart, CCC, FCC, CE, VCCI-B
Ergonomics	MPRII ISO13406-2
Compatibility	Windows 95/98/Me/2000, Windows XP, Window Vista
Power Management	Energy Star

2.3 Electrostatic Discharge Requirements

The subject unit must withstand ± 8KV for contact discharge and ± 15KV for air discharge of Electrostatic Discharge and meet the standard of IEC61000-4-2(EN55024). (without discharge on VGA/DVI pin)

2.4 Reliability

The MTBF of this product shall be greater than 25,000 hours excluding the LCD panel. The LCD panel life which is defined as the time period for the maximum luminance to reduce to 50% of the initial value is 40,000 hours minimum at the condition of displaying an all WHITE field at mid Brightness and Contrast settings.

3. Electrical and Optical Characteristics and Performance

3.1 Main Power Supply

3.1.1 AC Input Voltage Range

It is a universal type and the input voltage range is from 100 ~ 240Vrms

3.1.2 AC Input Current

1.5A (max) at 100VAC input
 0.8A (max) at 240VAC input

AC Frequency Range

The frequency range is from 50Hz to 60Hz

Inrush Current

- a. 40A max at cold-start, 25°C, DC output full-loading and 100Vac input
- b. 60A max at cold-start, 25°C, DC output full-loading and 240Vac input

Regulator Efficiency

75%
(DC output full loading and nominal AC input voltage range)

Ripple and Noise

Total composite ripple and noise less than 800mV for +25V output, and less than 150mV for +5V output, and 50mV for +3.3V output tested by DC loading side parallel with a 47uF/EC and 0.1uF/Ceramic. Capacitors and measured band-width with DC-20MHz

DC Output Voltage and Current

3.1 Brightness output

The test to verify specifications in this section shall be performed under the following standard conditions unless otherwise noted.

- Temperature : 25 ± 5°C
- Test pattern : white
- Video Resolution : 1920 x 1080
- Video input level : 700 mV ± 2%
- Warm-up time : 30 minutes

Set brightness control and also contrast control at maximum, to measure the screen center, the light output shall BL ≥ 240 cd/m² (as panel spec).

3.2 White balance

The test standard conditions refer to Sec 3.1.(Brightness and contrast are under default value)

Mode		Chromaticity Coordinate	
		x	y
Cool	9300K	0.283 ± 0.030	0.297 ± 0.030
Warm	6500K	0.313 ± 0.030	0.329 ± 0.030
User		Panel While x	Panel While y

3.3 Brightness uniformity

The test standard conditions refer to Sec 3.1.

- Min. luminance of nine points (backlight) 75%
- Max. luminance of nine points (backlight)

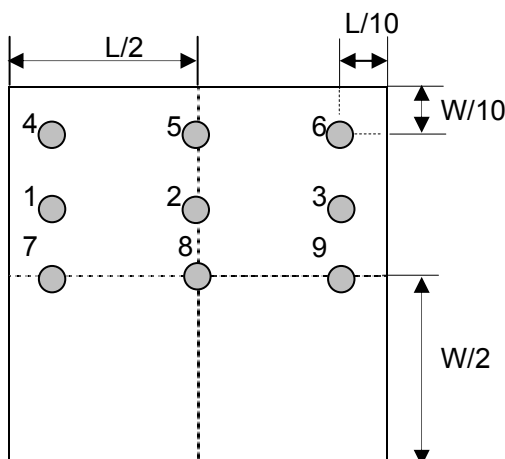

4. Input / Output Signal Specifications

4.1 Video signals

Analog RGB signal: 0.7Vp-p (Input impedance = 75 Ohm)

Sync: TTL level (Input impedance 1k Ohm)

Positive and negative sync of Separate Horizontal/Vertical Sync

Digital : TMDS Signal: (min) $\pm 200\text{mVpp}@24\text{Bit}$

4.2 Signal Timing

Through D-SUB/DVI connectors, this unit can support $F_H=31\sim 80\text{ KHz}$, $F_v=55\sim 76\text{Hz}$, with maximum pixel clock 165MHz input signal and WSXGA+ output. Modes details as below:

VESA MODES					
Mode	Resolution	Total	H Frequency	V Frequency	Pixel Clock (MHz)
VGA	640x480	800 x 525	31.469	59.941	25.175
	640x480	832 x 520	37.861	72.809	31.500
	640x480	840 x 500	37.500	75.000	31.500
SVGA	800x600	1024 x 625	35.156	56.250	36.000
	800x600	1056 x 628	37.879	60.317	40.000
	800x600	1040 x 666	48.077	72.188	50.000
	800x600	1056x625	46.875	75.000	49.500
XGA	1024x768	1344x806	48.363	60.004	65.000
	1024x768	1328x806	56.476	70.069	75.000
	1024x768	1312x800	60.023	75.029	78.750
VESA	1152x864	1600x900	67.5	75	108
	1280x960	1800x1000	60	60	108
SXGA	1280x1024	1688x1066	63.981	60.020	108.000
	1280x1024	1688x1066	79.976	75.025	135.000
VESA	1280x720	1650x750	44.955	59.940	74.176
WXGA	1280x800	1680x831	49.702	59.810	83.500
	1360x768	1792x795	47.712	60.015	85.500
WXGA+	1440x900	1904x931	55.935	59.887	106.500
	1440x900	1936x942	70.635	75.000	136.750
SXGA+	1400x1050	1864x1089	65.317	59.978	121.75
WSXGA+	1680x1050	2240*1089	65.290	59.954	146.250
UXGA	1600x1200	2160x1250	75.000	60.000	162.000
	1920x1080-R	2080x1111	66.587	59.934	138.50
IBM MODES					
EGA	720x400	900x449	31.469	70.087	28.322
MAC MODES					
VGA	640x480	864x525	35	66.66	30.24
SVGA	832x624	1152x667	49.722	74.55	57.28
SXGA	1152x870	1568x909	68.700	75.000	84.520

- Note:
1. Non-interlace signals only (An interlace signal cannot be display)
 2. Please refer to F/W specification for more detail
 3. Each frequency of Power Macintosh and Sun Ultra is a reference value

4.3 Timing requirements

The LCD monitor must be capable of displaying standard resolutions within the vertical frequency range of 55 ~ 76 Hz and the horizontal scan range of 31 ~ 80 KHz with maximum pixel clock of 190MHz.

Vertical / Horizontal Sync polarity: positive or negative.

If input signal is out of range of horizontal 31~80 KHz or vertical 55-76Hz, or pixel clock large than 165MHz, message "Input Not Supported" is shown on screen.

4.1 DDC data

H243H Analog

	0	1	2	3	4	5	6	7	8	9	A	B	C	D	E	F
0	00	FF	FF	FF	FF	FF	FF	00	04	72	74	00	01	01	01	01
1	00	00	01	03	68	35	1D	78	EA	60	85	A6	56	4A	9C	25
2	12	50	54	AF	CF	00	81	80	71	4F	95	00	95	0F	A9	40
3	B3	00	01	01	01	01	1A	36	80	A0	70	38	1F	40	30	20
4	35	00	13	2A	21	00	00	1A	00	00	00	FC	00	48	32	34
5	33	48	0A	20	20	20	20	20	20	20	00	00	00	FD	00	38
6	4C	1F	53	12	00	0A	20	20	20	20	20	20	00	00	00	FF
7	00	30	30	30	30	30	30	30	30	30	30	30	30	30	00	CS

H243H DVI

	0	1	2	3	4	5	6	7	8	9	A	B	C	D	E	F
0	00	FF	FF	FF	FF	FF	FF	00	04	72	74	00	01	01	01	01
1	00	00	01	03	80	35	1D	78	EA	60	85	A6	56	4A	9C	25
2	12	50	54	AF	CF	00	81	80	71	4F	95	00	95	0F	A9	40
3	B3	00	01	01	01	01	1A	36	80	A0	70	38	1F	40	30	20
4	35	00	13	2A	21	00	00	1A	00	00	00	FC	00	48	32	34
5	33	48	0A	20	20	20	20	20	20	20	00	00	00	FD	00	38
6	4C	1F	53	12	00	0A	20	20	20	20	20	20	00	00	00	FF
7	00	30	30	30	30	30	30	30	30	30	30	30	30	30	00	CS

5. Function Specifications

All the tests to verify specifications in this section shall be performed under the following standard conditions unless otherwise noted. The standard conditions are:

Temperature	: 25 ± 5°C
Warm-up time	: 30 minutes minimum
Checking display modes	: All the specified modes

5.1 Panel general specifications

A General specifications

Supplier	AUO
Model name	M240HW01-V0
Display Area	531.36 × 298.89
Pixel Pitch	276.75(Per one triad) × 276.75
Display Colors:	16.7M colors (RGB 6-bit + Hi_FRC)

Number of Pixel	1920 × 1080
Pixel Arrangement	R.G.B. Vertical Stripe
Brightness	300 cd/m ² (TYP.)
Contrast Ratio	1000 (TYP.)
Viewing Angle	170(Horizontal) / 160(Vertical)
Display Mode	Normally White
Frame rate	75
Response Time	5ms (TYP. ON/OFF) / 2ms (Gray to Gray)
Surface Treatment	Anti-Glare, 3H
Lamp	4
Outline Dimension	556.0(W) × 323.2(H) × 16.65(D) (TYP.)

5.2 Keypad Function

5.2.1 Control buttons on the front bezel

CONTROL KEY	KEYS FUNCTION
[POWER]	Power on or power off the monitor
[▶], [◀]	A. When “Main OSD” displays, press these keys to change the contents of an adjustment item, or change an adjustment value B. When “Main OSD” un-displays, press [▶] to show “Audio” OSD and increase the volume, press [◀] to show “Audio” OSD and decrease the volume .
[MENU]	A. When “Main OSD” un-displays, press [MENU] to enter OSD interface. B. When “Main OSD” displays, press [MENU] to perform function of menu icon that is highlight or enter next level menu.
[AUTO]	A. When “Main OSD” un-displays, press [AUTO] to perform auto-adjustment B. When “Main OSD” displays, press [AUTO] to return to previous level menu C. When “Empowering Technology OSD” displays, press [AUTO] to exit the OSD
[e Color]	A. When “Main OSD” un-displays, press [e Color] to show “Empowering Technology OSD”. B. When “Main OSD” displays, press [e Color] to exit the OSD, and to show “Empowering Technology OSD”
[Input select]	A. Press “input key” one time to search (a port with signal in order) B. Show “source icon” at the same time, as searching that port C. Go into next port automatically, if search the port without signal D. Display it, if search the port with signal

5.3 Hot Key Operation

FUNCTION	HOT KEY OPERATION						
	e Color	AUTO	MENU	◀	▶	POWER	DESCRIPTION

FACTORY MODE	•					ON	Press [e], and then press [POWER] for DC power on. OSD menu will be shown with "F" on the left top. Select "F" for entering factory mode.
--------------	---	--	--	--	--	----	---

5.4 OSD Structure

The On-Screen Display (OSD) shall be an easy to use icon based menu through keypad OSD buttons or remote control unit. The unit shall leave the factory with all OSD controls set to their default values.

First	Second	Third	Fourth	Control Range	Default Value		
Picture	Acer e color Management	Empowering Technology	User	---	Standard		
			Text				
			Standard				
			Graphics				
			Movie				
	Brightness	---	---	---	0~100	User mode	77
						Text mode	44
						Standard mode	77
						Graphics mode	97
						Movie mode	77
	Contrast	---	---	---	0~100	User mode	50
						Text mode	50
						Standard mode	50
						Graphics mode	60
						Movie mode	56
	H. Position	---	---	---	0~100	50	
	V. Position				0~100	50	
	Focus				0~100	---	
	Clock				0~100	50 (1)	
	Color Temp	---	Warm	---	---	---	
Cool						---	
User			Red			0~100	80
			Green			0~100	80
		Blue	0~100	80			
Auto Configure	---	---	---	---	---		
OSD	H. Position	---	---	0~100	Depending on the keypad position		
	V. Position	---	---	0~100	3		
	OSD Timeout	---	---	10~120	10		
Setting	Wide Mode	Full	---	---	Full		
		Aspect	---	---			
	DDC/CI	ON	---	---	ON		

		OFF				
	ACM	ON		---	---	OFF
		OFF				
	Input	VGA		---	---	---
		DVI		---	---	
		HDMI		---	---	
	Language	EMEA	NO-EMEA	---	---	English
		English	English	---	---	
		Russian	繁體中文	---	---	
		Deutsch	Deutsch	---	---	
Français		Français	---	---		
Español		Español	---	---		
Italiano		Italiano	---	---		
Dutch		简体中文	---	---		
Finnish	日本語	---	---			
Reset	---		---	---	---	
Info	Resolution	---		---	---	(2)
	H. Freq	---		---	---	
	V. Freq	---		---	---	
	Input Type	---		---	---	
	S/N	---		---	---	

Notes: (1) Clock default 50 is for Visa timing. Others depend on timing.

(2) Depend on timing & S/N

6. SOP of firmware upgrade (Manufacturer of Scaler is Mstar)

6.1 Operational condition:

Equipment: PC, ISP card, signal cable and power cable.

ESD requirements: antistatic wrists, antistatic gloves (fingers), and connecting cable

Name of ISP program: ISP_Tool_v3.7.5.exe

Manufacture of FW IC : PMC/SST/MX

6.2 Operational steps:

1. Connection: connect PC to PCBA with signal cable, and then keep AC and DC in open state.



signal cable

One port of ISP program card is connected to PC print port.



2. Adjust ISP programming

Firstly, double click ISP_Tool_v3.7.5EXE1 and open ISP program, then select "Device", next select manufacturer model of FW IC, which should be correspondent with that of PCBA FW IC. Double click Figure One.

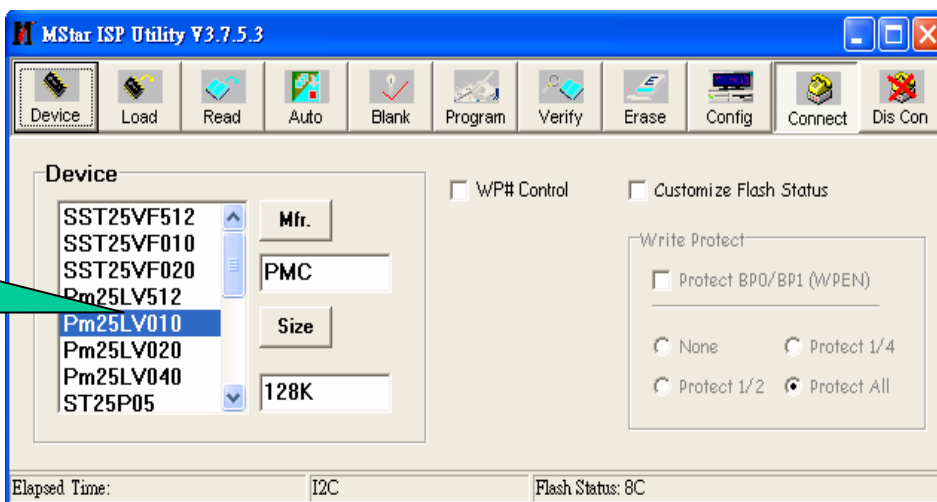

FW IC Model

Secondly, download FW software: first select "READ", and then load FW software in Router (Fig.2).

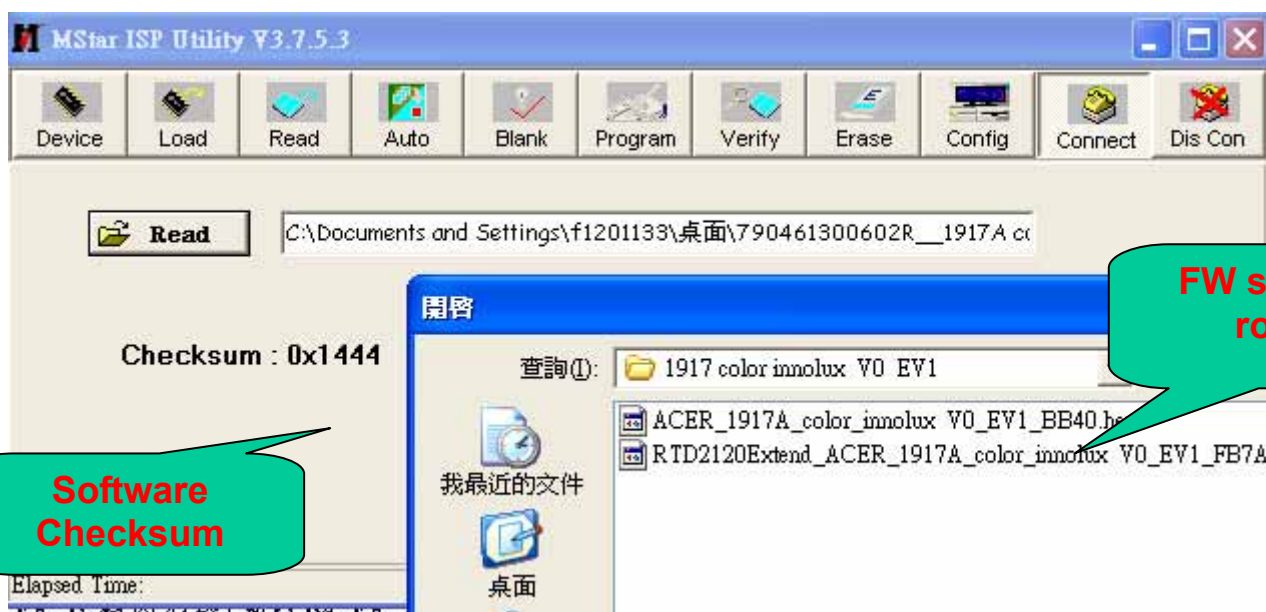

Software Checksum

FW software router

Thirdly, select “Connect” and enter ISP MODE as in the following Figure 3.

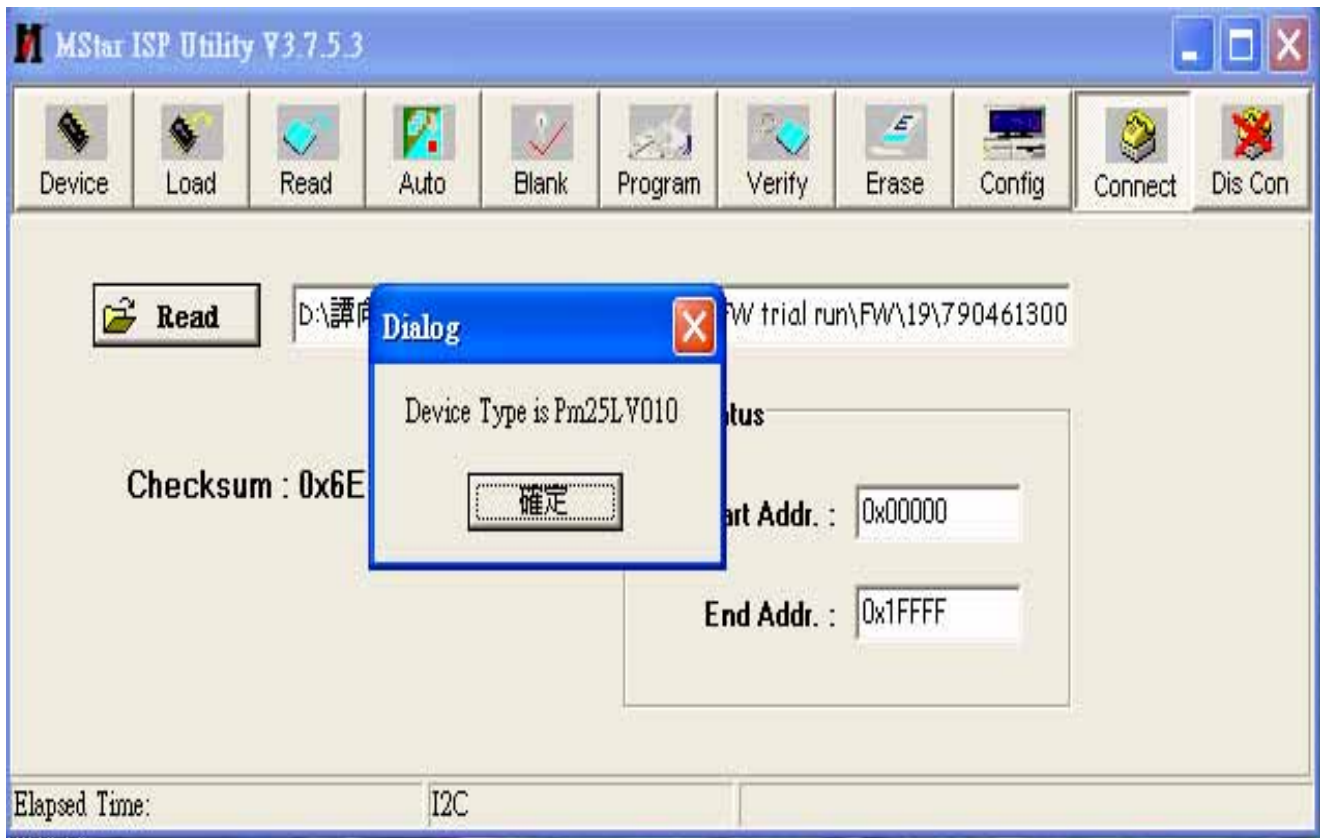

Fourthly, select “AUTO”, and keep its default value. Click “RUN” for beginning programming. There will be prompting if programming is OK.

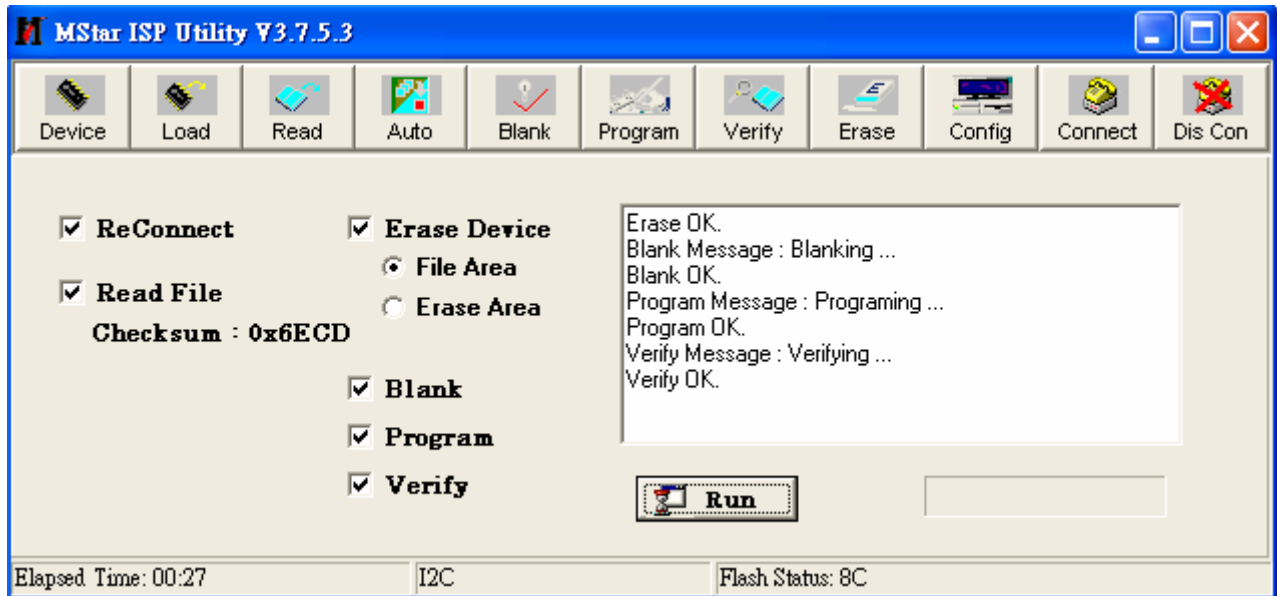

Note: if programming fails or success rate is not high, click “Config” and adjust its speed in “E2PROM DEVICE SETTING”

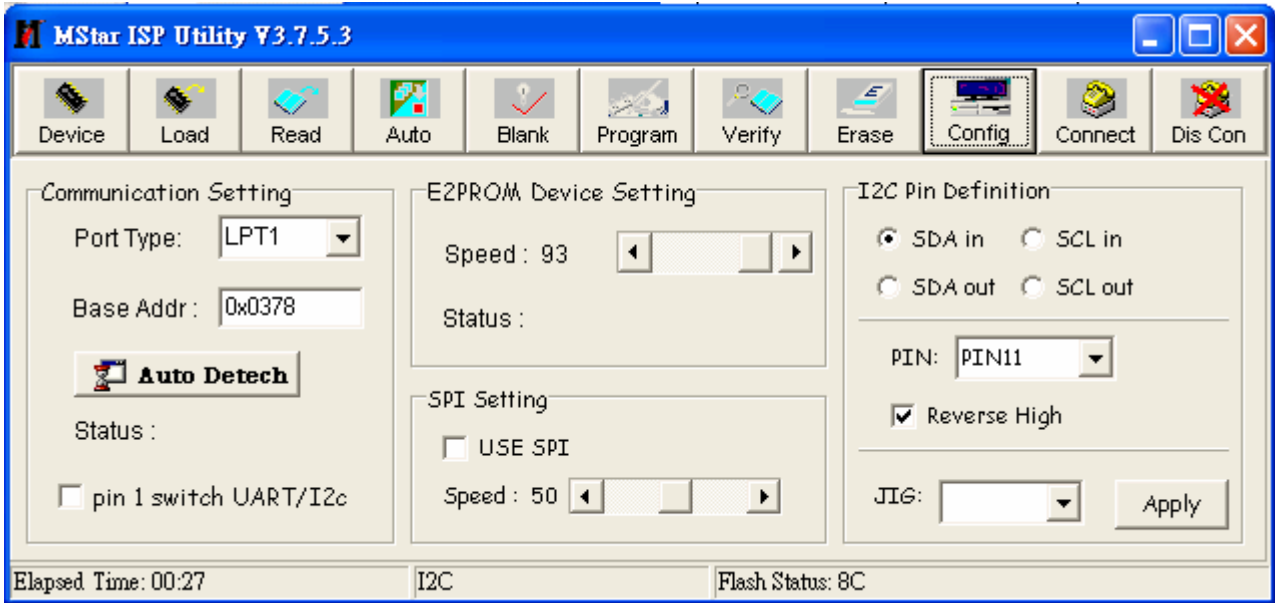

Flowing chart

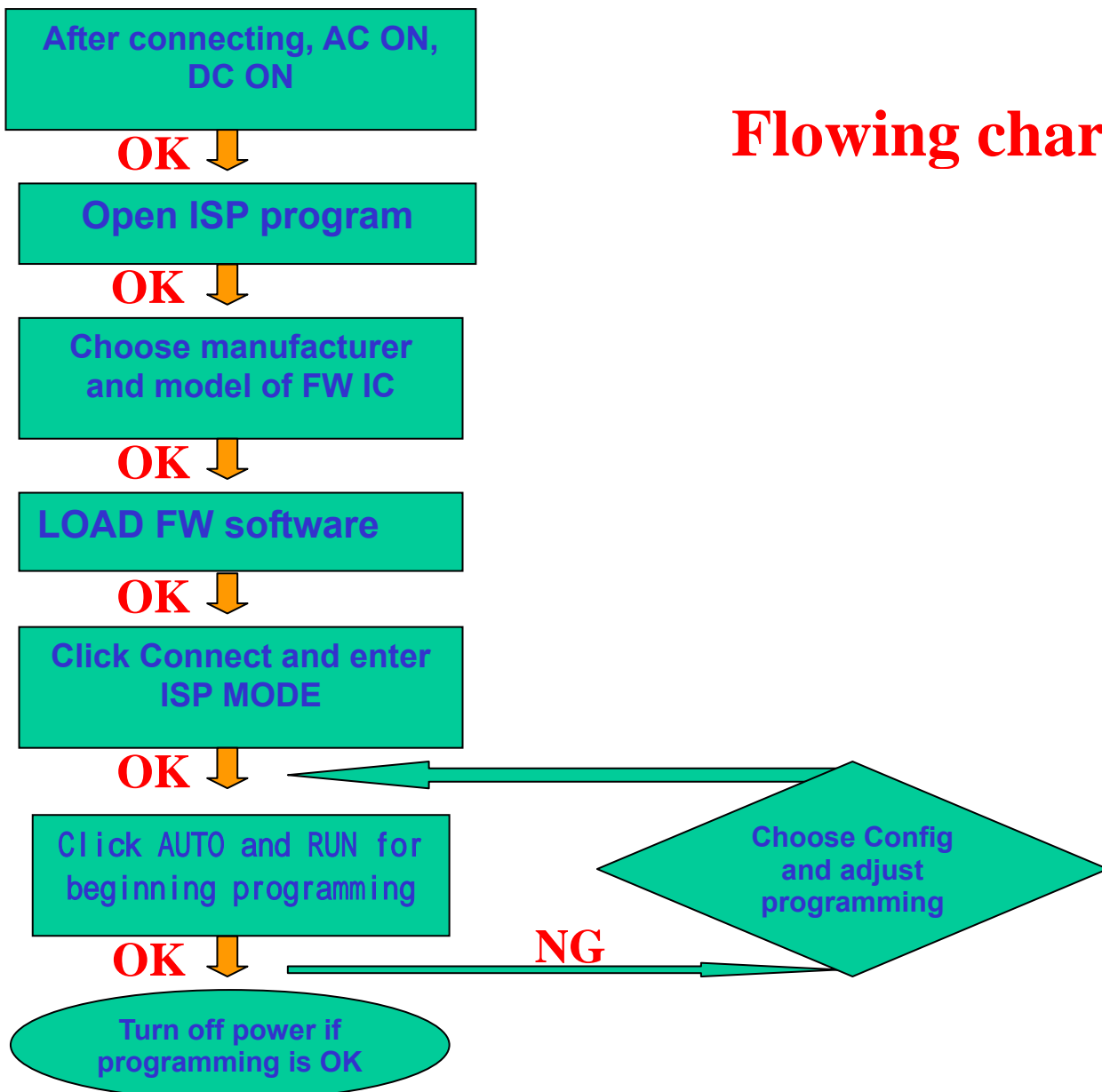

2. Flat Panel Specification



Product Specification

M240HW01 V0

AU OPTRONICS CORPORATION

Contents

1.0 Handling Precautions	4
2.0 General Description	5
2.1 Display Characteristics.....	5
2.2 Optical Characteristics	6
3.0 Functional Block Diagram	11
4.0 Absolute Maximum Ratings	12
4.1 TFT LCD Module.....	12
4.2 Backlight Unit.....	12
4.3 Absolute Ratings of Environment.....	12
5.0 Electrical characteristics	13
5.1 TFT LCD Module.....	13
5.1.1 Power Specification	13
5.1.2 Signal Electrical Characteristics.....	14
5.2 Backlight Unit.....	15
6.0 Signal Characteristic	17
6.1 Pixel Format Image	17
6.2 The input data format.....	17
6.3 Signal Description	18
6.4 Timing Characteristics.....	19
6.5 Timing diagram	20
6.6 Power ON/OFF Sequence	21
7.0 Connector & Pin Assignment	22
7.1 TFT LCD Module.....	22
7.1.1 Pin Assignment.....	22
7.2 Backlight Unit.....	23
7.2.1 Signal for Lamp connector	23
8.0 Reliability Test	24
9.0 Shipping Label	25
10.0 Mechanical Characteristics	26



Contents

1.0 Handling Precautions	4
2.0 General Description	5
2.1 Display Characteristics.....	5
2.2 Optical Characteristics	6
3.0 Functional Block Diagram	11
4.0 Absolute Maximum Ratings	12
4.1 TFT LCD Module.....	12
4.2 Backlight Unit	12
4.3 Absolute Ratings of Environment.....	12
5.0 Electrical characteristics	13
5.1 TFT LCD Module.....	13
5.1.1 Power Specification	13
5.1.2 Signal Electrical Characteristics.....	14
5.2 Backlight Unit	15
6.0 Signal Characteristic.....	17
6.1 Pixel Format Image	17
6.2 The input data format.....	17
6.3 Signal Description	18
6.4 Timing Characteristics.....	19
6.5 Timing diagram	20
6.6 Power ON/OFF Sequence	21
7.0 Connector & Pin Assignment.....	22
7.1 TFT LCD Module.....	22
7.1.1 Pin Assignment.....	22
7.2 Backlight Unit	23
7.2.1 Signal for Lamp connector	23
8.0 Reliability Test.....	24
9.0 Shipping Label	25
10.0 Mechanical Characteristics	26

Version and Date	Page	Old description	New Description	Remark																																												
0.1	2008/01/18	All	First Edition for Customer	N/A																																												
0.2	2008/03/04	5	Weight : 3300	2860																																												
	6	Some notes and testing equipments missing	Note 3,5,6 with TOPCON SR-3 added and Note 1~9 re-ordered																																													
	6	Max. Raising Time, T_{FR} = TBD Max. Falling Time, T_{FC} = TBD	Max. Raising Time, T_{FR} = 7.4 msec Max. Falling Time, T_{FC} = 2.6 msec																																													
	6	Color / Chromaticity Coordinates (CIE) : TBD	<table border="1"> <tr><td>Red x</td><td>0.619</td><td>0.649</td><td>0.679</td></tr> <tr><td>Red y</td><td>0.308</td><td>0.338</td><td>0.368</td></tr> <tr><td>Green x</td><td>0.299</td><td>0.269</td><td>0.319</td></tr> <tr><td>Green y</td><td>0.579</td><td>0.609</td><td>0.639</td></tr> <tr><td>Blue x</td><td>0.116</td><td>0.146</td><td>0.176</td></tr> <tr><td>Blue y</td><td>0.04</td><td>0.07</td><td>0.100</td></tr> </table>	Red x	0.619	0.649	0.679	Red y	0.308	0.338	0.368	Green x	0.299	0.269	0.319	Green y	0.579	0.609	0.639	Blue x	0.116	0.146	0.176	Blue y	0.04	0.07	0.100																					
Red x	0.619	0.649	0.679																																													
Red y	0.308	0.338	0.368																																													
Green x	0.299	0.269	0.319																																													
Green y	0.579	0.609	0.639																																													
Blue x	0.116	0.146	0.176																																													
Blue y	0.04	0.07	0.100																																													
	8	Note 4	$T_{FR} + T_{FC} = 5$ msec (typ.) and algorithm of Gray to Gray level response time added in Note 4																																													
	12	Logic/LCD Drive Voltage max : 5.5 CCFL Current max : 7.5	Logic/LCD Drive Voltage max : 6.0 CCFL Current max : 8.0																																													
	13	Inrush Current : TBD	Inrush Current : 3.0																																													
	15	CCFL Frequency, CCFL Ignition Voltage, CCFL Operation Voltage, CCFL Power Consumption : TBD	<table border="1"> <thead> <tr> <th>Parameter</th> <th>Min.</th> <th>Typ.</th> <th>Max.</th> <th>Unit</th> </tr> </thead> <tbody> <tr> <td>CCFL Frequency (CCFL)</td> <td>40</td> <td>60</td> <td>60</td> <td>[kHz]</td> </tr> <tr> <td>CCFL Ignition Voltage (V_{CCFL}, T_a = 0°C)</td> <td>2000</td> <td>-</td> <td>-</td> <td>[Volt] rms</td> </tr> <tr> <td>CCFL Ignition Voltage (V_{CCFL}, T_a = 25°C)</td> <td>2000</td> <td>-</td> <td>-</td> <td>[Volt] rms</td> </tr> <tr> <td>CCFL Operation Voltage (V_{CCFL})</td> <td>-</td> <td>800</td> <td>-</td> <td>[Volt] rms</td> </tr> <tr> <td>CCFL Power Consumption (CCFL)</td> <td>-</td> <td>27</td> <td>-</td> <td>[Watt]</td> </tr> </tbody> </table>	Parameter	Min.	Typ.	Max.	Unit	CCFL Frequency (CCFL)	40	60	60	[kHz]	CCFL Ignition Voltage (V _{CCFL} , T _a = 0°C)	2000	-	-	[Volt] rms	CCFL Ignition Voltage (V _{CCFL} , T _a = 25°C)	2000	-	-	[Volt] rms	CCFL Operation Voltage (V _{CCFL})	-	800	-	[Volt] rms	CCFL Power Consumption (CCFL)	-	27	-	[Watt]															
Parameter	Min.	Typ.	Max.	Unit																																												
CCFL Frequency (CCFL)	40	60	60	[kHz]																																												
CCFL Ignition Voltage (V _{CCFL} , T _a = 0°C)	2000	-	-	[Volt] rms																																												
CCFL Ignition Voltage (V _{CCFL} , T _a = 25°C)	2000	-	-	[Volt] rms																																												
CCFL Operation Voltage (V _{CCFL})	-	800	-	[Volt] rms																																												
CCFL Power Consumption (CCFL)	-	27	-	[Watt]																																												
	15	N/A	Note 6 for designing CCFL current added																																													
	19	Timing Characteristics	<table border="1"> <thead> <tr> <th>Item</th> <th>Symbol</th> <th>Min.</th> <th>Typ.</th> <th>Max.</th> <th>Unit</th> </tr> </thead> <tbody> <tr> <td>Data CLK</td> <td>Tclk</td> <td>40</td> <td>75</td> <td>90</td> <td>[MHz]</td> </tr> <tr> <td rowspan="2">H-section</td> <td>Period</td> <td>T_H</td> <td>1024</td> <td>1050</td> <td>2047</td> <td>[Tclk]</td> </tr> <tr> <td>Display Area</td> <td>T_{dspH}</td> <td>960</td> <td>960</td> <td>960</td> <td>[Tclk]</td> </tr> <tr> <td rowspan="2">V-section</td> <td>Period</td> <td>T_V</td> <td>1088</td> <td>1150</td> <td>2047</td> <td>[Tclk]</td> </tr> <tr> <td>Display Area</td> <td>T_{dspV}</td> <td>1080</td> <td>1080</td> <td>1080</td> <td>[Tclk]</td> </tr> <tr> <td>Frame Rate</td> <td>F_r</td> <td>50</td> <td>60</td> <td>75</td> <td>[Hz]</td> </tr> </tbody> </table>	Item	Symbol	Min.	Typ.	Max.	Unit	Data CLK	Tclk	40	75	90	[MHz]	H-section	Period	T _H	1024	1050	2047	[Tclk]	Display Area	T _{dspH}	960	960	960	[Tclk]	V-section	Period	T _V	1088	1150	2047	[Tclk]	Display Area	T _{dspV}	1080	1080	1080	[Tclk]	Frame Rate	F _r	50	60	75	[Hz]	
Item	Symbol	Min.	Typ.	Max.	Unit																																											
Data CLK	Tclk	40	75	90	[MHz]																																											
H-section	Period	T _H	1024	1050	2047	[Tclk]																																										
	Display Area	T _{dspH}	960	960	960	[Tclk]																																										
V-section	Period	T _V	1088	1150	2047	[Tclk]																																										
	Display Area	T _{dspV}	1080	1080	1080	[Tclk]																																										
Frame Rate	F _r	50	60	75	[Hz]																																											
	25	N/A	Note 3 and China RoHS sign added																																													
	26	Drawing	Change BL label position																																													
	27	Drawing	Change BL label position																																													
1.0	2008/05/20	15	<table border="1"> <thead> <tr> <th>Parameter</th> <th>Min.</th> <th>Typ.</th> <th>Max.</th> <th>Unit</th> </tr> </thead> <tbody> <tr> <td>CCFL Ignition Voltage (V_{CCFL}, T_a = 0°C)</td> <td>2000</td> <td>-</td> <td>-</td> <td>[Volt] rms</td> </tr> <tr> <td>CCFL Ignition Voltage (V_{CCFL}, T_a = 25°C)</td> <td>2000</td> <td>-</td> <td>-</td> <td>[Volt] rms</td> </tr> </tbody> </table>	Parameter	Min.	Typ.	Max.	Unit	CCFL Ignition Voltage (V _{CCFL} , T _a = 0°C)	2000	-	-	[Volt] rms	CCFL Ignition Voltage (V _{CCFL} , T _a = 25°C)	2000	-	-	[Volt] rms	<table border="1"> <thead> <tr> <th>Parameter</th> <th>Min.</th> <th>Typ.</th> <th>Max.</th> <th>Unit</th> </tr> </thead> <tbody> <tr> <td>CCFL Ignition Voltage (V_{CCFL}, T_a = 0°C)</td> <td>2000</td> <td>-</td> <td>-</td> <td>[Volt] rms</td> </tr> <tr> <td>CCFL Ignition Voltage (V_{CCFL}, T_a = 25°C)</td> <td>1950</td> <td>-</td> <td>-</td> <td>[Volt] rms</td> </tr> </tbody> </table>	Parameter	Min.	Typ.	Max.	Unit	CCFL Ignition Voltage (V _{CCFL} , T _a = 0°C)	2000	-	-	[Volt] rms	CCFL Ignition Voltage (V _{CCFL} , T _a = 25°C)	1950	-	-	[Volt] rms														
Parameter	Min.	Typ.	Max.	Unit																																												
CCFL Ignition Voltage (V _{CCFL} , T _a = 0°C)	2000	-	-	[Volt] rms																																												
CCFL Ignition Voltage (V _{CCFL} , T _a = 25°C)	2000	-	-	[Volt] rms																																												
Parameter	Min.	Typ.	Max.	Unit																																												
CCFL Ignition Voltage (V _{CCFL} , T _a = 0°C)	2000	-	-	[Volt] rms																																												
CCFL Ignition Voltage (V _{CCFL} , T _a = 25°C)	1950	-	-	[Volt] rms																																												
	21	<table border="1"> <thead> <tr> <th rowspan="2">Parameter</th> <th colspan="3">Value</th> <th rowspan="2">Unit</th> </tr> <tr> <th>Min.</th> <th>Typ.</th> <th>Max.</th> </tr> </thead> <tbody> <tr> <td>T2</td> <td>0</td> <td>-</td> <td>20</td> <td rowspan="2">[msec]</td> </tr> <tr> <td>T3</td> <td>300</td> <td>-</td> <td>-</td> </tr> </tbody> </table>	Parameter	Value			Unit	Min.	Typ.	Max.	T2	0	-	20	[msec]	T3	300	-	-	<table border="1"> <thead> <tr> <th rowspan="2">Parameter</th> <th colspan="3">Value</th> <th rowspan="2">Unit</th> </tr> <tr> <th>Min.</th> <th>Typ.</th> <th>Max.</th> </tr> </thead> <tbody> <tr> <td>T2</td> <td>0</td> <td>-</td> <td>15</td> <td rowspan="2">[msec]</td> </tr> <tr> <td>T3</td> <td>300</td> <td>-</td> <td>-</td> </tr> </tbody> </table>	Parameter	Value			Unit	Min.	Typ.	Max.	T2	0	-	15	[msec]	T3	300	-	-											
Parameter	Value			Unit																																												
	Min.	Typ.	Max.																																													
T2	0	-	20	[msec]																																												
T3	300	-	-																																													
Parameter	Value			Unit																																												
	Min.	Typ.	Max.																																													
T2	0	-	15	[msec]																																												
T3	300	-	-																																													



Product Specification

M240HW01 V0

AU OPTONICS CORPORATION

1.0 Handling Precautions

- 1) Since front polarizer is easily damaged, pay attention not to scratch it.
- 2) Be sure to turn off power supply when inserting or disconnecting from input connector.
- 3) Wipe off water drop immediately. Long contact with water may cause discoloration or spots.
- 4) When the panel surface is soiled, wipe it with absorbent cotton or other soft cloth.
- 5) Since the panel is made of glass, it may break or crack if dropped or bumped on hard surface.
- 6) Since CMOS LSI is used in this module, take care of static electricity and insure human earth when handling.
- 7) Do not open or modify the Module Assembly.
- 8) Do not press the reflector sheet at the back of the module to any directions.
- 9) In case if a Module has to be put back into the packing container slot after once it was taken out from the container, do not press the center of the CCFL reflector edge. Instead, press at the far ends of the CCFL Reflector edge softly. Otherwise the TFT Module may be damaged.
- 10) At the insertion or removal of the Signal Interface Connector, be sure not to rotate nor tilt the Interface Connector of the TFT Module.
- 11) After installation of the TFT Module into an enclosure, do not twist nor bend the TFT Module even momentary. At designing the enclosure, it should be taken into consideration that no bending/twisting forces are applied to the TFT Module from outside. Otherwise the TFT Module may be damaged.
- 12) Cold cathode fluorescent lamp in LCD contains a small amount of mercury. Please follow local ordinances or regulations for disposal.
- 13) Small amount of materials having no flammability grade is used in the LCD module. The LCD module should be supplied by power complied with requirements of Limited Power Source (IEC60950 or UL1950), or be applied exemption.
- 14) The LCD module is designed so that the CCFL in it is supplied by Limited Current Circuit (IEC60950 or UL1950). Do not connect the CCFL in Hazardous Voltage Circuit.



Product Specification

M240HW01 V0

AU OPTRONICS CORPORATION

2.0 General Description

This specification applies to the 24 inch-wide Color a-Si TFT-LCD Module M240HW01. The display supports the Full HD - 1920(H) x 1080(V) screen format and 16.7M colors (RGB 6-bits + Hi-FRC data). All input signals are 2-channel LVDS interface and this module doesn't contain an inverter board for backlight.

2.1 Display Characteristics

The following items are characteristics summary on the table under 25°C condition:

ITEMS	Unit	SPECIFICATIONS
Screen Diagonal	[mm]	609.7(24.0")
Active Area	[mm]	531.36 (H) x 298.89 (V)
Pixels H x V		1920(x3) x 1080
Pixel Pitch	[um]	276.75 (per one triad) x 276.75
Pixel Arrangement		R.G.B. Vertical Stripe
Display Mode		TN Mode, Normally White
White Luminance (Center)	[cd/m ²]	300 cd/m ² (Typ.)
Contrast Ratio		1000 (Typ.)
Optical Response Time	[msec]	5ms (Typ., on/off) 2ms (Gray to Gray)
Nominal Input Voltage VDD	[Volt]	+5.0 V
Power Consumption (VDD line + CCFL line)	[Watt]	35 W (Typ.) (without inverter, all black pattern)
Weight	[g]	2860 (Typ.)
Physical Size	[mm]	556.0 (W) x 323.2 (H) x 16.65 (D) typ
Electrical Interface		Dual channel LVDS
Support Color		16.7M colors (RGB 6-bit + Hi FRC)
Surface Treatment		Anti-Glare, 3H
Temperature Range		
Operating	[°C]	0 to +50
Storage (Shipping)	[°C]	-20 to +60
RoHS Compliance		RoHS Compliance



Product Specification

M240HW01 V0

AU OPTRONICS CORPORATION

2.2 Optical Characteristics

The optical characteristics are measured under stable conditions at 25°C:

Item	Unit	Conditions	Min.	Typ.	Max.	Note
Viewing Angle	[degree]	Horizontal (Right) CR = 10 (Left)	150	170	-	2
		Vertical (Up) CR = 10 (Down)	140	160	-	
Contrast ratio		Normal Direction	600	1000	-	3
Response Time	[msec]	Raising Time (T_{R})	-	3.4	7.4	4
		Falling Time (T_{F})	-	1.6	2.6	
		Raising + Falling	-	5	10	
		Gray to Gray	-	2	-	
Color / Chromaticity Coordinates (CIE)		Red x	0.619	0.649	0.679	5
		Red y	0.308	0.338	0.368	
		Green x	0.259	0.289	0.319	
		Green y	0.579	0.609	0.639	
		Blue x	0.116	0.146	0.176	
		Blue y	0.040	0.070	0.100	
Color Coordinates (CIE) White		White x	0.283	0.313	0.343	
		White y	0.299	0.329	0.359	
Central Luminance	[cd/m ²]		240	300	-	6
Luminance Uniformity	[%]		75	80	-	7
Crosstalk (in 60Hz)	[%]				1.5	8
Flicker	dB				-20	9



Note 1: Measurement method

The LCD module should be stabilized at given temperature for 30 minutes to avoid abrupt temperature change during measuring (at surface 35°C). In order to stabilize the luminance, the measurement should be executed after lighting Backlight for 30 minutes in a stable, windless and dark room.

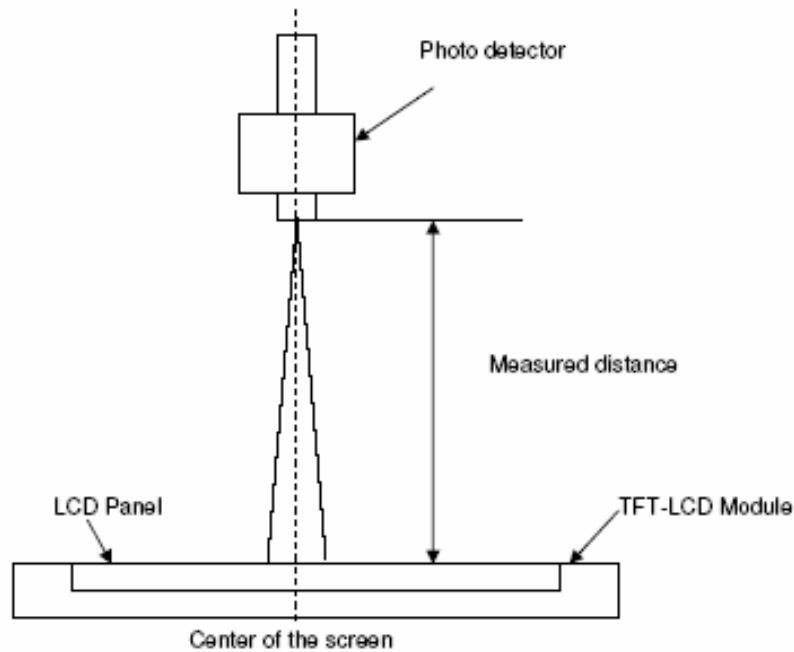

Note 2: Definition of viewing angle measured by ELDIM (EZContrast 88)

Viewing angle is the measurement of contrast ratio ≥ 10 , at the screen center, over a 180° horizontal and 180° vertical range (off-normal viewing angles). The 180° viewing angle range is broken down as follows; 90° (θ) horizontal left and right and 90° (ϕ) vertical, high (up) and low (down). The measurement direction is typically perpendicular to the display surface with the screen rotated about its center to develop the desired measurement viewing angle.

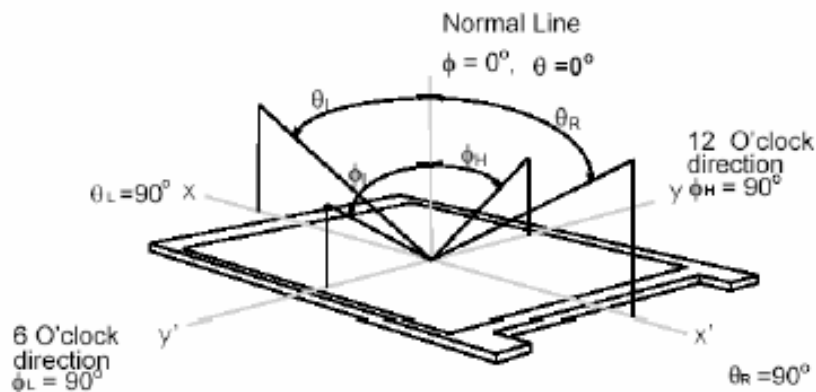

documer

7



Product Specification

M240HW01 V0

AU OPTRONICS CORPORATION

Note 3: Contrast ratio is measured by TOPCON SR-3

Note 4: Definition of Response time measured by Westar TRD-100A

The output signals of photo detector are measured when the input signals are changed from "Full Black" to "Full White" (rising time, T_{rR}), and from "Full White" to "Full Black" (falling time, T_{rF}), respectively. The response time is interval between the 10% and 90% (1 frame at 60 Hz) of amplitudes.

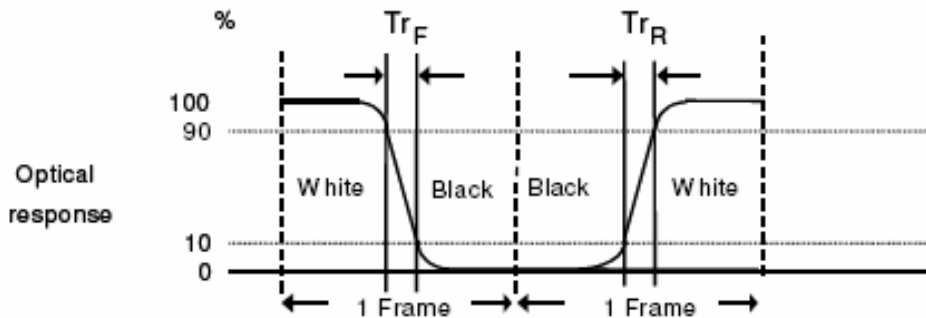

$T_{rR} + T_{rF} = 5 \text{ msec (typ.)}$.

Algorithm: | Gray Level A – Gray Level B | $\square 32$, then the average gray to gray response time is 2 ms.

Response Time		START LEVEL								
		L0	L32	L64	L96	L128	L160	L192	L224	L255
TARGET LEVEL	L0									
	L32									
	L64									
	L96									
	L128									
	L160									
	L192									
	L224									
	L255									

Note 5: Color chromaticity and coordinates (CIE) is measured by TOPCON SR-3

Note 6: Central luminance is measured by TOPCON SR-3

Note 7: Luminance uniformity of these 9 points is defined as below and measured by TOPCON SR-3



Product Specification

M240HW01 V0

AU OPTRONICS CORPORATION

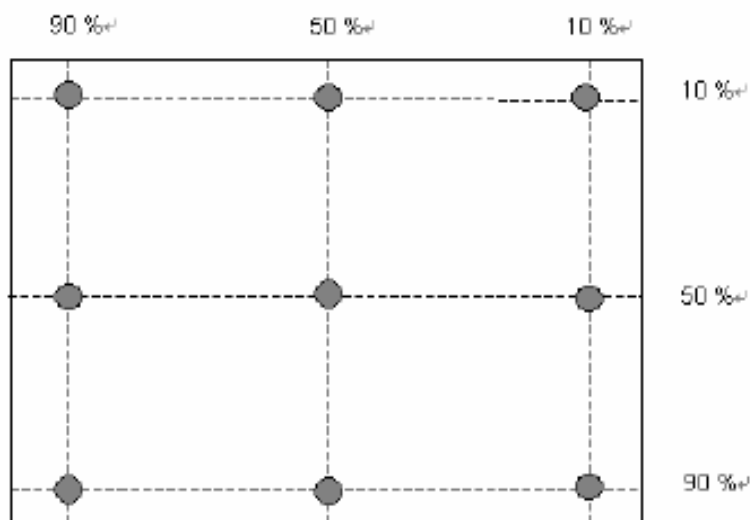

$$\text{Uniformity} = \frac{\text{Minimum Luminance in 9 points (1-9)}}{\text{Maximum Luminance in 9 Points (1-9)}}$$

Note 8: Crosstalk is defined as below and measured by TOPCON SR-3

$$CT = | YB - YA | / YA \times 100 (\%)$$

Where

YA = Luminance of measured location without gray level 0 pattern (cd/m²)

YB = Luminance of measured location with gray level 0 pattern (cd/m²)

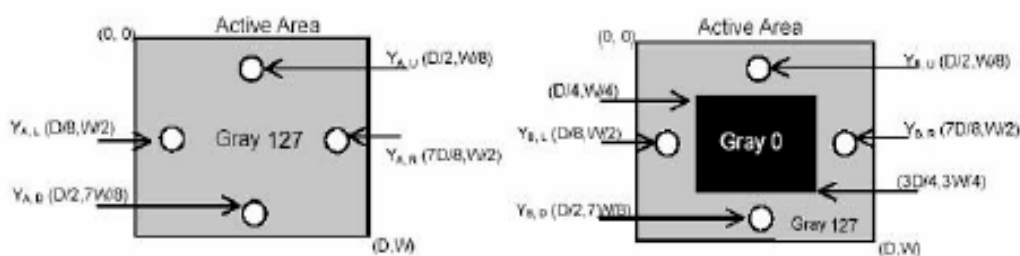

Note 9: Test Pattern: Subchecker Pattern measured by TOPCON SR-3

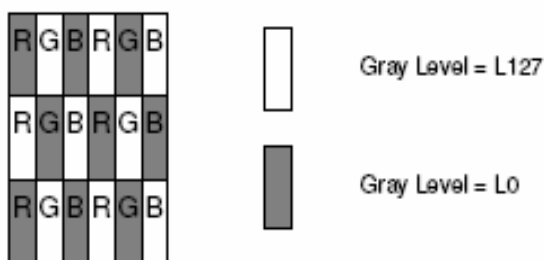



Product Specification
AU OPTRONICS CORPORATION

M240HW01 V0

Method: Record dBV & DC value with TRD-100

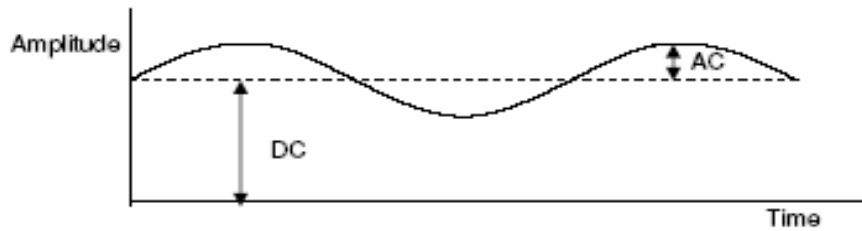

$$\text{Flicker (dB)} = 20 \log \frac{\text{AC Level(at 30 Hz)}}{\text{DC Level}}$$



3.0 Functional Block Diagram

The following diagram shows the functional block of the 24.0 inch Color TFT-LCD Module:

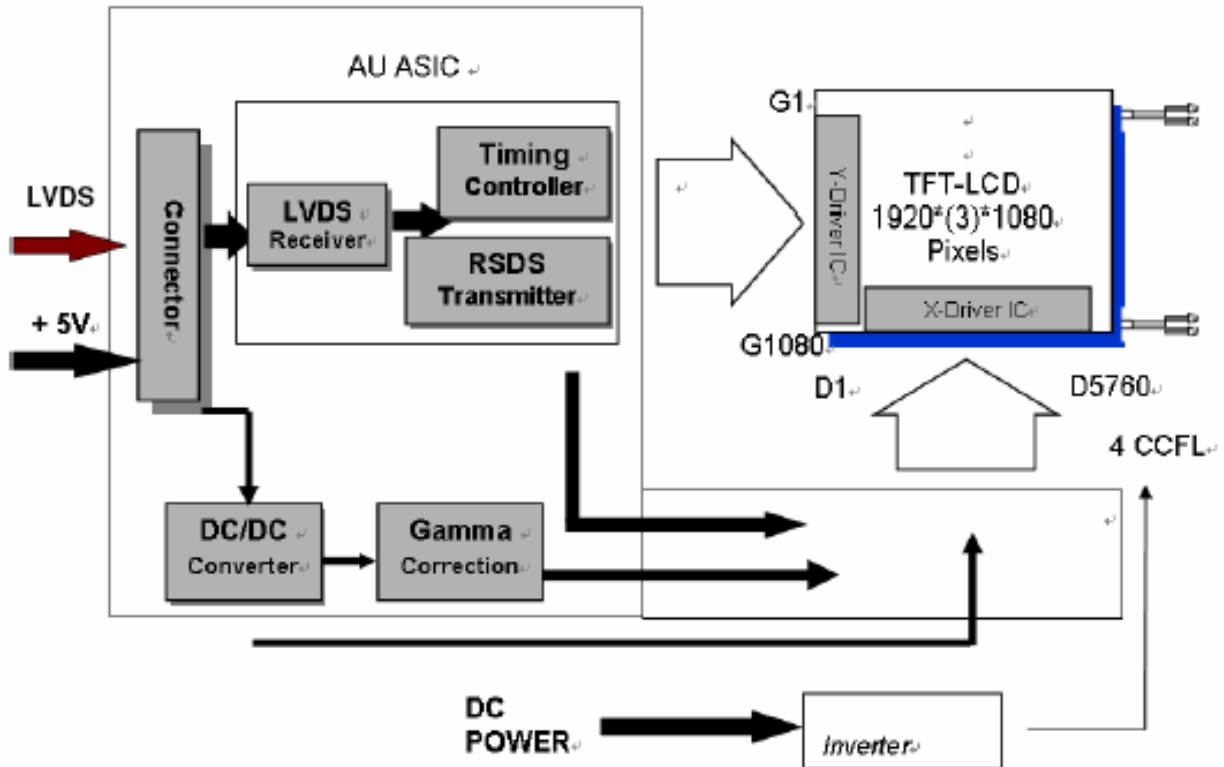

I/F PCB Interface:

STM MSCKT2407P30B

MDF76URW-30S-1H(58)

Mating Type:

FI-X30HL (Locked Type)



Product Specification

M240HW01 V0

AU OPTRONICS CORPORATION

4.0 Absolute Maximum Ratings

Absolute maximum ratings of the module are as following:

4.1 TFT LCD Module

Item	Symbol	Min	Max	Unit	Conditions
Logic/LCD Drive Voltage	VDD	0	6.0	[Volt]	Note 1,2

4.2 Backlight Unit

Item	Symbol	Min	Max	Unit	Conditions
CCFL Current	ICFL	3.0	8.0	[mA] rms	Note 1,2

4.3 Absolute Ratings of Environment

Item	Symbol	Min.	Max.	Unit	Conditions
Operating Temperature	TOP	0	+50	[°C]	Note 3
Operation Humidity	HOP	5	90	[%RH]	
Storage Temperature	TST	-20	+60	[°C]	
Storage Humidity	HST	5	90	[%RH]	

Note 1: With in Ta (25°C)

Note 2: Permanent damage to the device may occur if exceeding maximum values

Note 3: For quality performance, please refer to AUO IIS(Incoming Inspection Standard).

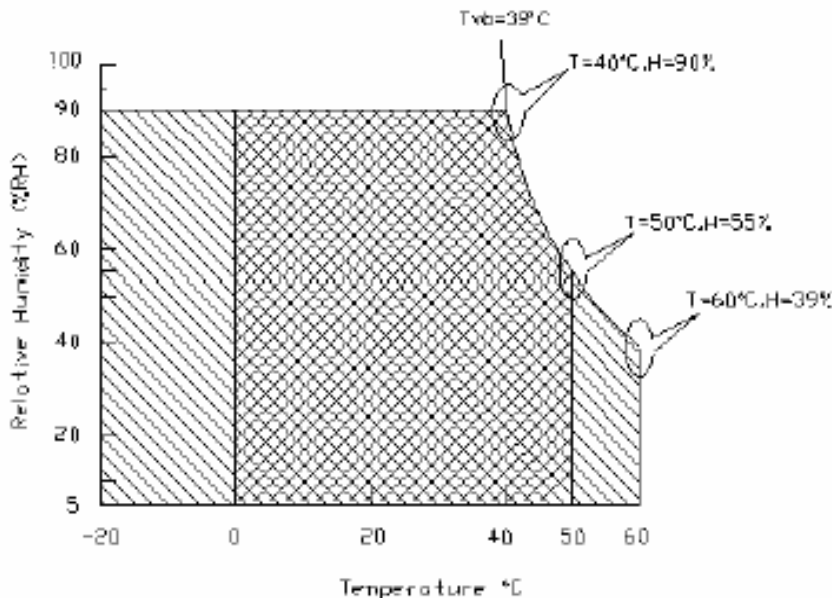

Operating Range Storage Range +



5.0 Electrical characteristics

5.1 TFT LCD Module

5.1.1 Power Specification

Input power specifications are as following:

Symbol	Parameter	Min	Typ	Max	Unit	Conditions
VDD	Logic/LCD Drive Voltage	4.5	5.0	5.5	[Volt]	+/-10%
IDD	Input Current	-	1.4	1.8	[A]	VDD= 5.0V, All Black Pattern At 75Hz, +30%
PDD	VDD Power	-	7.0	10	[Watt]	VDD= 5.0V, All Black Pattern At 75Hz
IRush	Inrush Current	-	-	3.0	[A]	Note 1
VDDrp	Allowable Logic/LCD Drive Ripple Voltage	-	-	300	[mV] p-p	VDD= 5.0V, All Black Pattern At 75Hz

Note 1: Measurement conditions:

The duration of rising time of power input is 470 us.

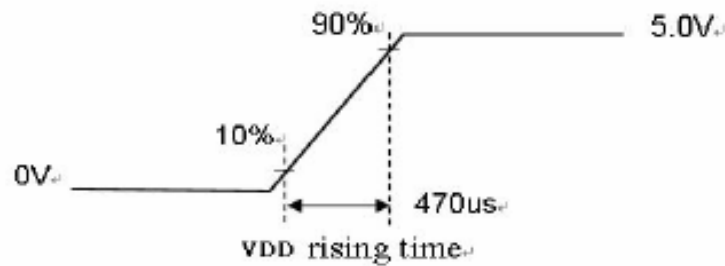
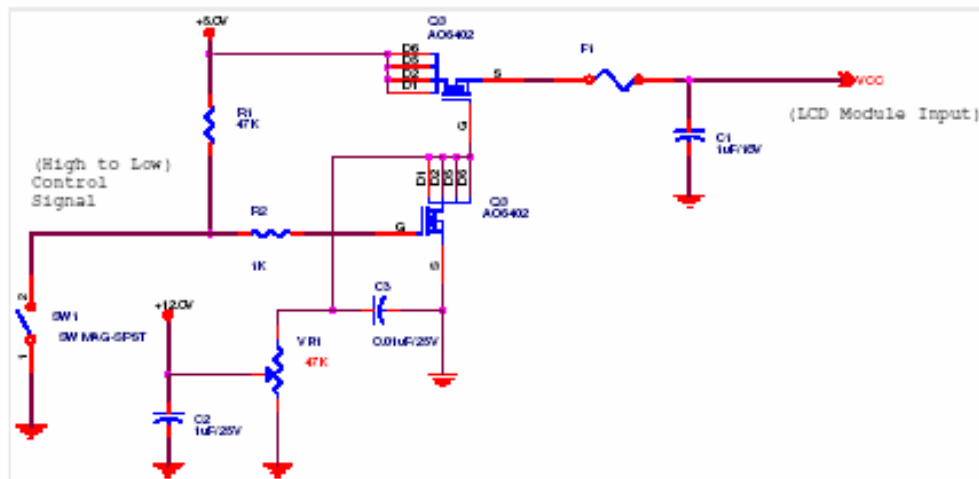



Product Specification

M240HW01 V0

AU OPTRONICS CORPORATION

5.1.2 Signal Electrical Characteristics

Input signals shall be low or Hi-Z state when VDD is off. Please refer to specifications of SN75LVDS82DGG (Texas Instruments) in detail.

Characteristics of each signal are as following:

Symbol	Parameter	Min	Typ	Max	Units	Condition
VTH	Differential Input High Threshold	-	+50	+100	[mV]	VICM = 1.2V <i>Note 1</i>
VTL	Differential Input Low Threshold	-100	-50	-	[mV]	VICM = 1.2V <i>Note 1</i>
VID	Input Differential Voltage	100	-	600	[mV]	<i>Note 1</i>
VICM	Differential Input Common Mode Voltage	+1.0	+1.2	+1.5	[V]	VTH-VTL = 200MV (max) <i>Note 1</i>

Note 1: LVDS Signal Waveform

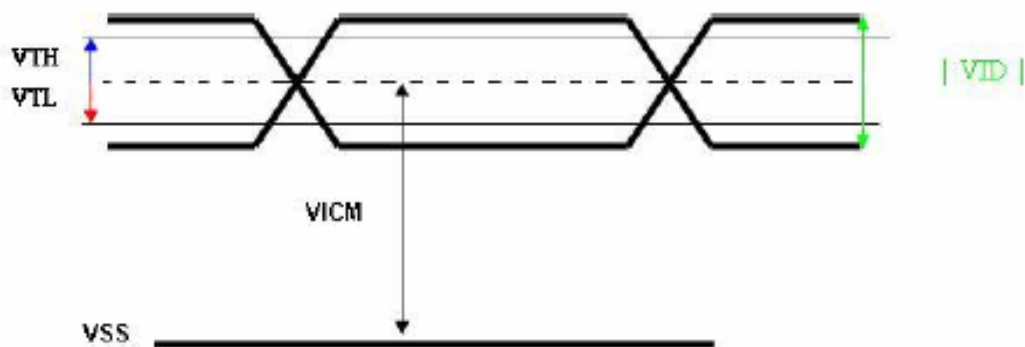



Product Specification

M240HW01 V0

AU OPTRONICS CORPORATION

5.2 Backlight Unit

Parameter guideline for CCFL Inverter is under stable conditions at 25°C (Room Temperature):

Parameter	Min.□	Typ.	Max.□	Unit	Note
CCFL Standard Current (ISCFL)	7.0	7.5	8.0	[mA] rms	
CCFL Operation Current (IRCFL)	3.0	7.5	8.0	[mA] rms	2
CCFL Frequency (FCFL)	40	53	60	[KHz]	3, 4
CCFL Ignition Voltage (VICFL, Ta= 0°C)	2000	-	-	[Volt] rms	5
CCFL Ignition Voltage (VICF, Ta= 25°C)	1850	-	-	[Volt] rms	
CCFL Operation Voltage (VCFL)	-	900 (@7.5mA)	-	[Volt] rms	6
CCFL Power Consumption (PCFL)	-	27	-	[Watt]	
CCFL Life Time (LTCFL)	40,000	50,000	-	[Hour]	7

Note 1: Typ. values are AUO recommended design values.

*1 All of characteristics listed are measured under the condition using the AUO test inverter.

*2 It is recommended to check the inverter carefully. Sometimes, interfering noise stripes appear on the screen, and substandard luminance or flicker at low power may happen.

*3 While designing an inverter, it is suggested to check safety circuit very carefully. Impedance of CCFL, for instance, becomes more than 1 [M ohm] when CCFL is damaged.

*4 Generally, CCFL has certain delay time after applying kick-off voltage. It is recommended to keep on applying kick-off voltage for 1 [Sec] until discharge.

*5 Reducing CCFL current will increase CCFL discharge voltage and generally increases CCFL discharge frequency. So all the parameters of the inverter should be carefully designed so the inverter will not produce too much leakage current from high-voltage output.

*6 For designing CCFL current, it is highly recommended to use symmetric and consistent sinusoidal wave for each CCFL input current with asymmetric ratio of 10% or less in both positive area and negative area (ie. $0.9 \cdot \sqrt{2} \cdot I_{rms} < I_1$ & $I_2 < 1.1 \cdot \sqrt{2} \cdot I_{rms}$) as refer to the following diagram, otherwise proper CCFL functionality cannot be guaranteed.

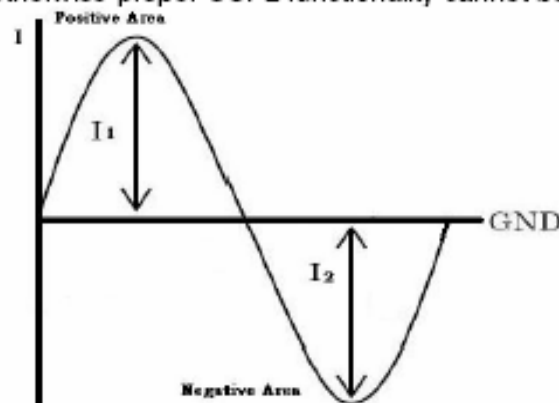

Note 2: CCFL standard current is measured at 25±2°C.



Product Specification

M240HW01 V0

AU OPTONICS CORPORATION

Note 3: CCFL discharge frequency should be carefully determined to avoid interference between inverter and TFT LCD.

Note 4: The frequency range will not affect lamp life and reliability characteristics.

Note 5: CCFL inverter should be able to release power that has generating capacity exceeding 2000 volt. Lamp units need minimum voltage, 2000 Volt, for ignition.

Note 6: The variance of CCFL power consumption is $\pm 10\%$. ($IRCFL \times VCFL \times 4 = PCFL$)

Note 7: Definition of life time: brightness becomes 50%. The minimum life time of CCFL unit is on the condition of 7.5mA CCFL current and $25 \pm 2^\circ\text{C}$.



Product Specification

M240HW01 V0

AU OPTRONICS CORPORATION

6.0 Signal Characteristic

6.1 Pixel Format Image

Following figure shows the relationship of the input signals and LCD pixel format.

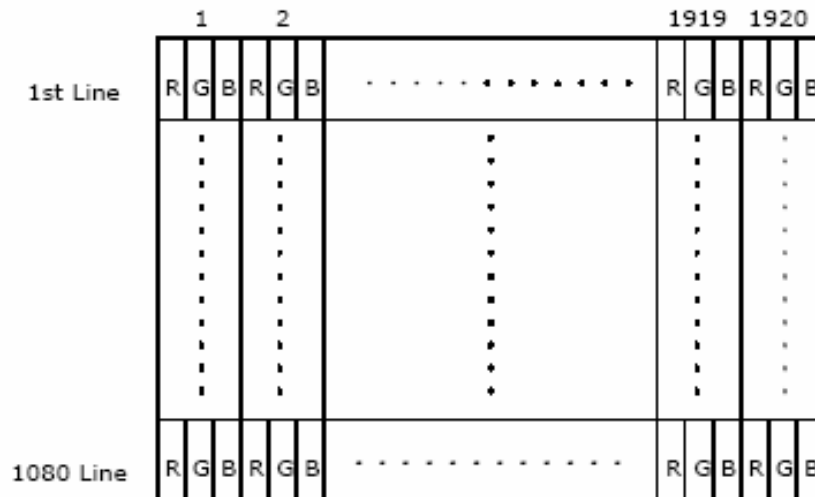

6.2 The input data format

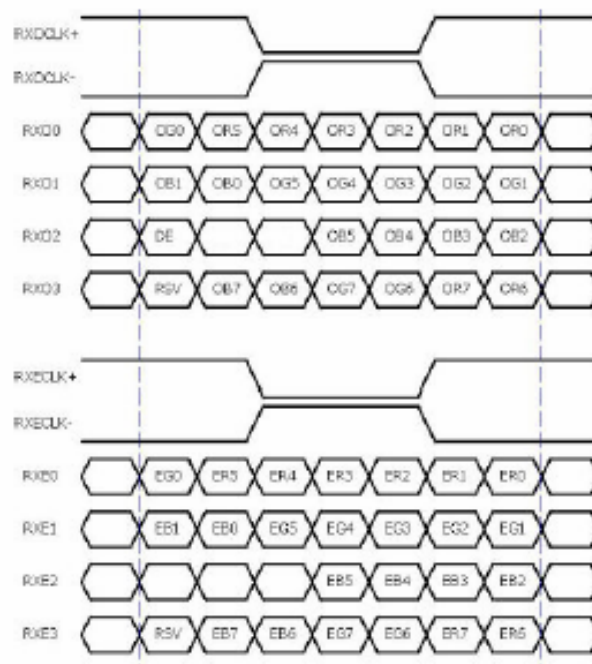

Note 1: R/G/B data 7:MSB, R/G/B data 0:LSB O = "Odd Pixel Data" E = "Even Pixel Data"



6.3 Signal Description

The module using one LVDS receiver SN75LVDS82(Texas Instruments). LVDS is a differential signal technology for LCD interface and high speed data transfer device. LVDS transmitters shall be SN75LVDS83(negative edge sampling). The first LVDS port(RxOxxx) transmits odd pixels while the second LVDS port(RxExxx) transmits even pixels.

PIN #	SIGNAL NAME	DESCRIPTION
1	RxOIN0-	Negative LVDS differential data input (Odd data)
2	RxOIN0+	Positive LVDS differential data input (Odd data)
3	RxOIN1-	Negative LVDS differential data input (Odd data)
4	RxOIN1+	Positive LVDS differential data input (Odd data)
5	RxOIN2-	Negative LVDS differential data input (Odd data, DSPTMG)
6	RxOIN2+	Positive LVDS differential data input (Odd data, DSPTMG)
7	GND	Power Ground
8	RxOCLK-	Negative LVDS differential clock input (Odd clock)
9	RxOCLK+	Positive LVDS differential clock input (Odd clock)
10	RxOIN3-	Negative LVDS differential data input (Odd data)
11	RxOIN3+	Positive LVDS differential data input (Odd data)
12	RxEIN0-	Negative LVDS differential data input (Even data)
13	RxEIN0+	Positive LVDS differential data input (Even data)
14	GND	Power Ground
15	RxEIN1-	Negative LVDS differential data input (Even data)
16	RxEIN1+	Positive LVDS differential data input (Even data)
17	GND	Power Ground
18	RxEIN2-	Negative LVDS differential data input (Even data)
19	RxEIN2+	Positive LVDS differential data input (Even data)
20	RxECLK-	Negative LVDS differential clock input (Even clock)
21	RxECLK+	Positive LVDS differential clock input (Even clock)
22	RxEIN3-	Negative LVDS differential data input (Even data)
23	RxEIN3+	Positive LVDS differential data input (Even data)
24	GND	Power Ground
25	NC	No connection (for AUO test only. Do not connect)
26	NC	No connection (for AUO test only. Do not connect)
27	VDD	Power +5V
28	VDD	Power +5V
29	VDD	Power +5V
30	VDD	Power +5V



Product Specification

M240HW01 V0

AU OPTRONICS CORPORATION

Note1: Start from left side

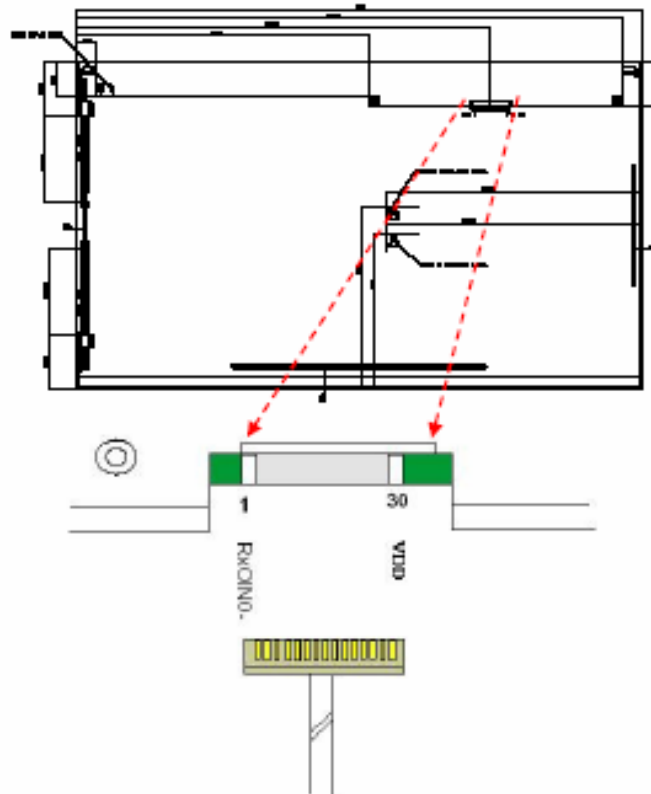

Note2: Input signals of odd and even clock shall be the same timing.

6.4 Timing Characteristics

Basically, interface timing described here is not actual input timing of LCD module but close to output timing of SN75LVDS82DGG (Texas Instruments) or equivalent.

Item	Symbol	Min	Typ	Max	Unit	
Data CLK	Tclk	40	75	90	[MHz]	
H-section	Period	Th	1034	1060	2047	[Tclk]
	Display Area	Tdisp(h)	960	960	960	[Tclk]
	Blanking	Tblk(h)	74	100	1087	[Tclk]
V-section	Period	Tv	1088	1120	2047	[Th]
	Display Area	Tdisp(v)	1080	1080	1080	[Th]
	Blanking	Tblk(v)	8	40	967	[Th]
Frame Rate	F	50	60	75	[Hz]	

Note : DE mode only



6.5 Timing diagram

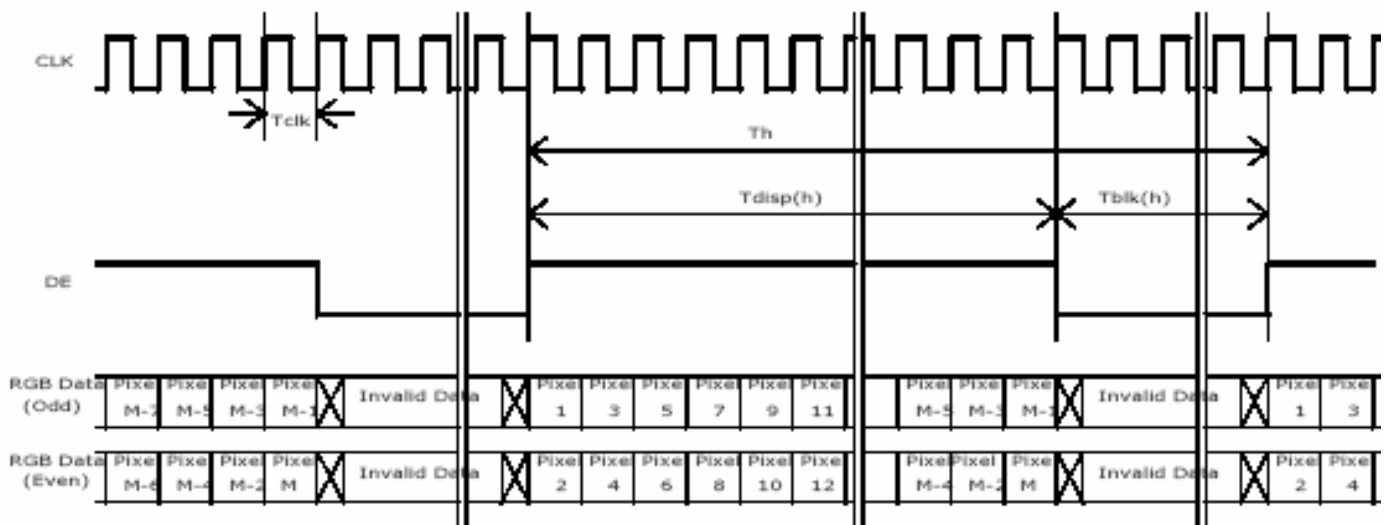
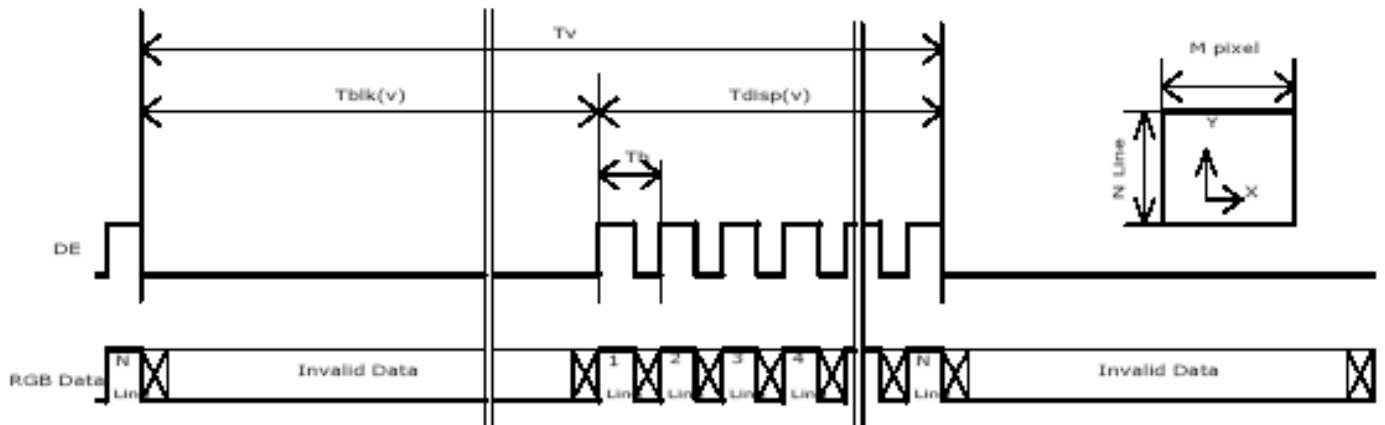



6.6 Power ON/OFF Sequence

VDD power and lamp on/off sequence are as follows. Interface signals are also shown in the chart. Signals from any system shall be Hi-Z state or low level when VDD is off.

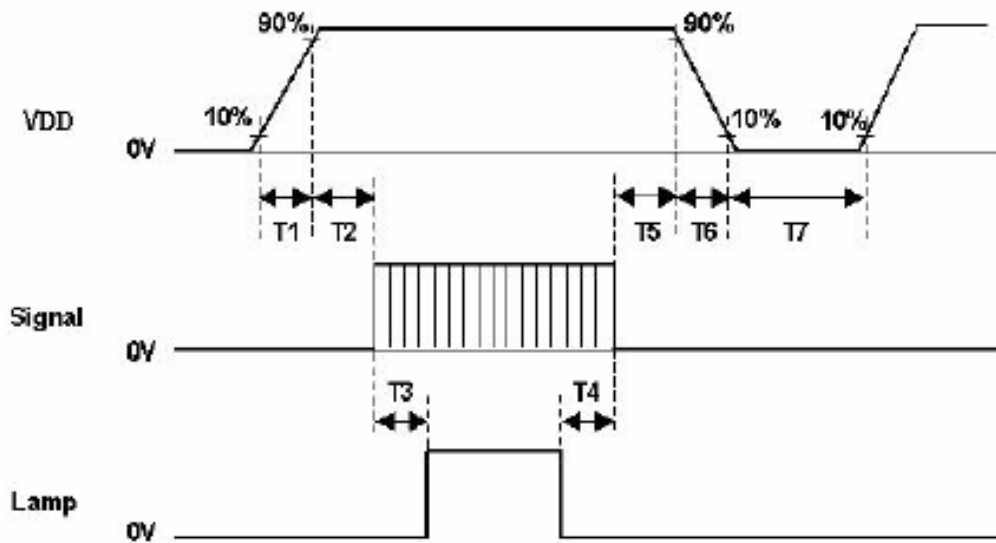

Parameter	Value			Unit
	Min.	Typ.	Max.	
T1	0.5	-	10	[msec]
T2	0	-	15	[msec]
T3	300	-	-	[msec]
T4	200	-	-	[msec]
T5	0	16	50	[msec]
T6	-	-	100	[msec]
T7	1000	-	-	[msec]



Product Specification

M240HW01 V0

AU OPTRONICS CORPORATION

7.0 Connector & Pin Assignment

Physical interface is described as for the connector on module. These connectors are capable of accommodating the following signals and will be following components.

7.1 TFT LCD Module

Connector Name / Designation	Interface Connector / Interface card
Manufacturer	STM Hirose
Type Part Number	MSCKT2407P30B MDF76URW-30S-1H(58)
Mating Housing Part Number	FI-X30HL (Locked Type)

7.1.1 Pin Assignment

Pin#	Signal Name	Pin#	Signal Name
1	RxOIN0-	2	RxOIN0+
3	RxOIN1-	4	RxOIN1+
5	RxOIN2-	6	RxOIN2+
7	GND	8	RxOCLKIN-
9	RxOCLKIN+	10	RxOIN3-
11	RxOIN3+	12	RxEIN0-
13	RxEIN0+	14	GND
15	RxEIN1-	16	RxEIN1+
17	GND	18	RxEIN2-
19	RxEIN2+	20	RxECLKIN-
21	RxECLKIN+	22	RxEIN3-
23	RxEIN3+	24	GND
25	NC (for AUO test only. Do not connect)	26	NC (for AUO test only. Do not connect)
27	VDD	28	VDD
29	VDD	30	VDD



Product Specification

M240HW01 V0

AU OPTRONICS CORPORATION

7.2 Backlight Unit

Physical interface is described as for the connector on module. These connectors are capable of accommodating the following signals and will be following components.

Connector Name / Designation	Lamp Connector / Backlight lamp
Manufacturer	CVILUX
Type Part Number	CP0502SL090
Mating Type Part Number	CP0502P1ML0

7.2.1 Signal for Lamp connector

	Connector No.	Pin No.	Input	Color	Function
Upper	CN1	1	Hot1	Pink	High Voltage
		2	Cold1	White	Low Voltage
	CN2	1	Hot2	Blue	High Voltage
		2	Cold2	Black	Low Voltage

	Connector No.	Pin No.	Input	Color	Function
Lower	CN3	1	Hot1	Pink	High Voltage
		2	Cold1	White	Low Voltage
	CN4	1	Hot2	Blue	High Voltage
		2	Cold2	Black	Low Voltage



Product Specification

M240HW01 V0

AU OPTRONICS CORPORATION

8.0 Reliability Test

Environment test conditions are listed as following table.

Items	Required Condition	Note
Temperature Humidity Bias (THB)	Ta= 50°C, 80%RH, 300hours	
High Temperature Operation (HTO)	Ta= 50°C, 50%RH, 300hours	
Low Temperature Operation (LTO)	Ta= 0°C, 300hours	
High Temperature Storage (HTS)	Ta= 60°C, 300hours	
Low Temperature Storage (LTS)	Ta= -20°C, 300hours	
Vibration Test (Non-operation)	Acceleration: 1.5 Grms Wave: Random Frequency: 10 - 200 Hz Duration: 30 Minutes each Axis (X, Y, Z)	
Shock Test (Non-operation)	Acceleration: 50 G Wave: Half-sine Active Time: 20 ms Direction: ±X, ±Y, ±Z (one time for each Axis)	
Drop Test	Height: 46 cm, package test	
Thermal Shock Test (TST)	-20°C/30min, 60°C/30min, 100 cycles	1
On/Off Test	On/10sec, Off/10sec, 30,000 cycles	
ESD (Electro Static Discharge)	Contact Discharge: ± 8KV, 150pF(330Ω) 1sec, 15 points, 25 times/ point.	2
	Air Discharge: ± 15KV, 150pF(330Ω) 1sec 15 points, 25 times/ point.	
Altitude Test	Operation:10,000 ft Non-Operation:30,000 ft	

Note 1: The TFT-LCD module will not sustain damage after being subjected to 100 cycles of rapid temperature change. A cycle of rapid temperature change consists of varying the temperature from -20°C to 60°C, and back again. Power is not applied during the test. After temperature cycling, the unit is placed in normal room ambient for at least 4 hours before power on.

Note 2: EN61000-4-2, ESD class B: Certain performance degradation allowed
No data lost
Self-recoverable
No hardware failures.



Product Specification

M240HW01 V0

AU OPTRONICS CORPORATION

9.0 Shipping Label

The label is on the panel as shown below:



Note 1: For Pb Free products, AUO will add  for identification.

Note 2: For RoHS compatible products, AUO will add  for identification.

Note 3: For China RoHS compatible products, AUO will add  for identification.

Note 4: The Green Mark will be presented only when the green documents have been ready by AUO Internal Green Team.

03 Exploded Diagram

3.1 H243H_SCREW_LIST

ITEM	PN	Description	Q'T Y(P CS)	Fixed T(kg*cm)	Remark
1	509146306 200R	SCREW,P,CROSS,W/WAS ,M3*6,Zn-Cc	7	6.5±0.5	For NVBD/PWRBD/HDMI
2	509216608 110R	SCREW,F,CROSS,M4*8,B LACK,NL,ROHS(NYLOK)	4	12±1	For Hingle toBack cover
3	509412610 500R	SCREW B CROSS T T-4*10 BLK ROHS	3	8.5±0.5	For Hingle to Stand Front
4	509000000 700R	BOLT,#4-40x11.8,Ni	4	4.0±0.25	For D-SUB CON&DVI

3.2. LCD Exploded drawing (All)

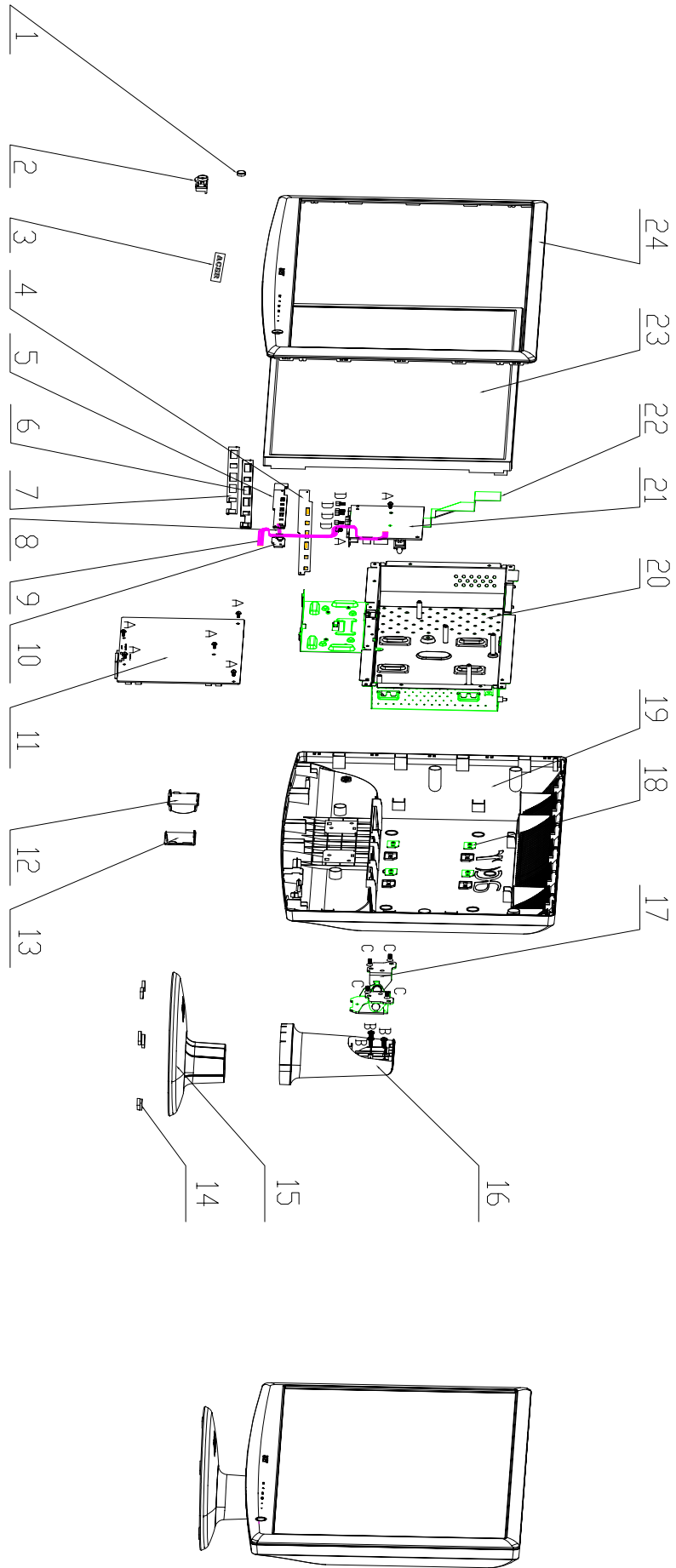

ITEM	PART NUMBER	DESCRIPTION	Q'TY	ITEM	PART NUMBER	DESCRIPTION	Q'TY	FINISH	STAMP	SCALE	DWG. NO.	SHEET
24	501010223600R	BEZEL, H243H LP2441	9									
23		24AUD Panel	1	8								
22		HRN LVDS FFC	1	7	501120201100R	CABLE, POWERKEY TO TOUCHPAD	1					
21		JF. BOARD	1	6	506380201800R	TOUCH-KEYPAD	1					
20	502090103100R	CHASSIS, W /HDMI, W/DVI, LP2441	1	5								
19	501020228602R	COVER, BACK, LP2441	1	4	505040505400R	MYLAR ADHENSIVE, TOUCHPAD, LP2441	1					
18	502020301400R	BRACKET, VESA, LE1729	4	3	501110500400R	LOGO, ACER, ELEC. RDP, LATED, 26.8x6.5mm, LE22F1	1					
17	502060201100R	HINGE, L, P2441	1	2	50103012900R	BUTTON, POWER KEY, LP2441	1					
16	501260210800R	STAND, LP2441	1	1	50120110200R	LENS, PAINTING, LP2441	1					
15	501240213700R	BASE, LP2441	1									
14	503020006300R	RUBBER FOOT, L148xW9.6xH3.5mm	6									
13	501020228600R	HINGE COVER, LEFT, LP2441	1									
12	501020228601R	HINGE COVER, RIGHT, LP2441	1									
11		POWER BOARD	1									
10		POWER KEY PAD	1									
4												
4	509216608510R	SCREW, F, CROSS, M4x8, BLACK, NL, RH(S), (N.Y.L.D.K)	4									
3	509412610500R	SCREW, B CROSS, T-4x10, BLK, RH(S)	3									
7	509146306200R	SCREW, P, CROSS, W/WAS, M3x6, Zn-Cc	7									

Screw list LP2441

D	50900000700R	BOLT, #4-40x1.18, N	4
C	509216608510R	SCREW, F, CROSS, M4x8, BLACK, NL, RH(S), (N.Y.L.D.K)	4
B	509412610500R	SCREW, B CROSS, T-4x10, BLK, RH(S)	3
A	509146306200R	SCREW, P, CROSS, W/WAS, M3x6, Zn-Cc	7

MODEL NO.	ACERH243H	DATE	2008/08/20
SIGNATURE		TITLE	FDXCDDN CORP. (INNOVUX)
DRAWN	Lee Jiu	DATE	2008/08/20
CHECKED BY	Yong	DATE	2008/08/20
ISSUED BY	Wang	DATE	2008/08/20
SCALE	1:1	PART NO.	
DWG. NO.		REV	A

04 Troubleshooting

4.1 No Power & LED Off

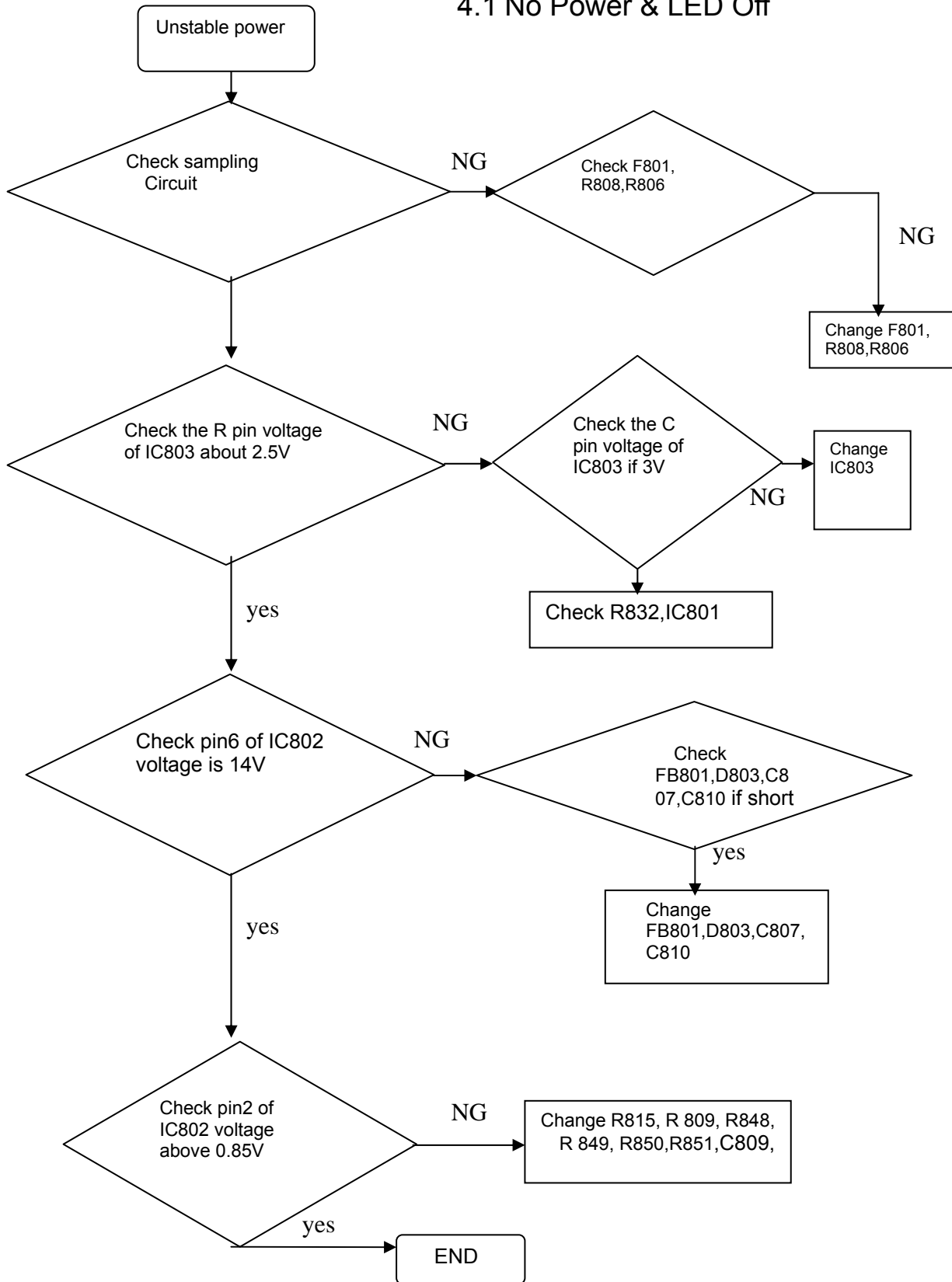

4.2 No raster

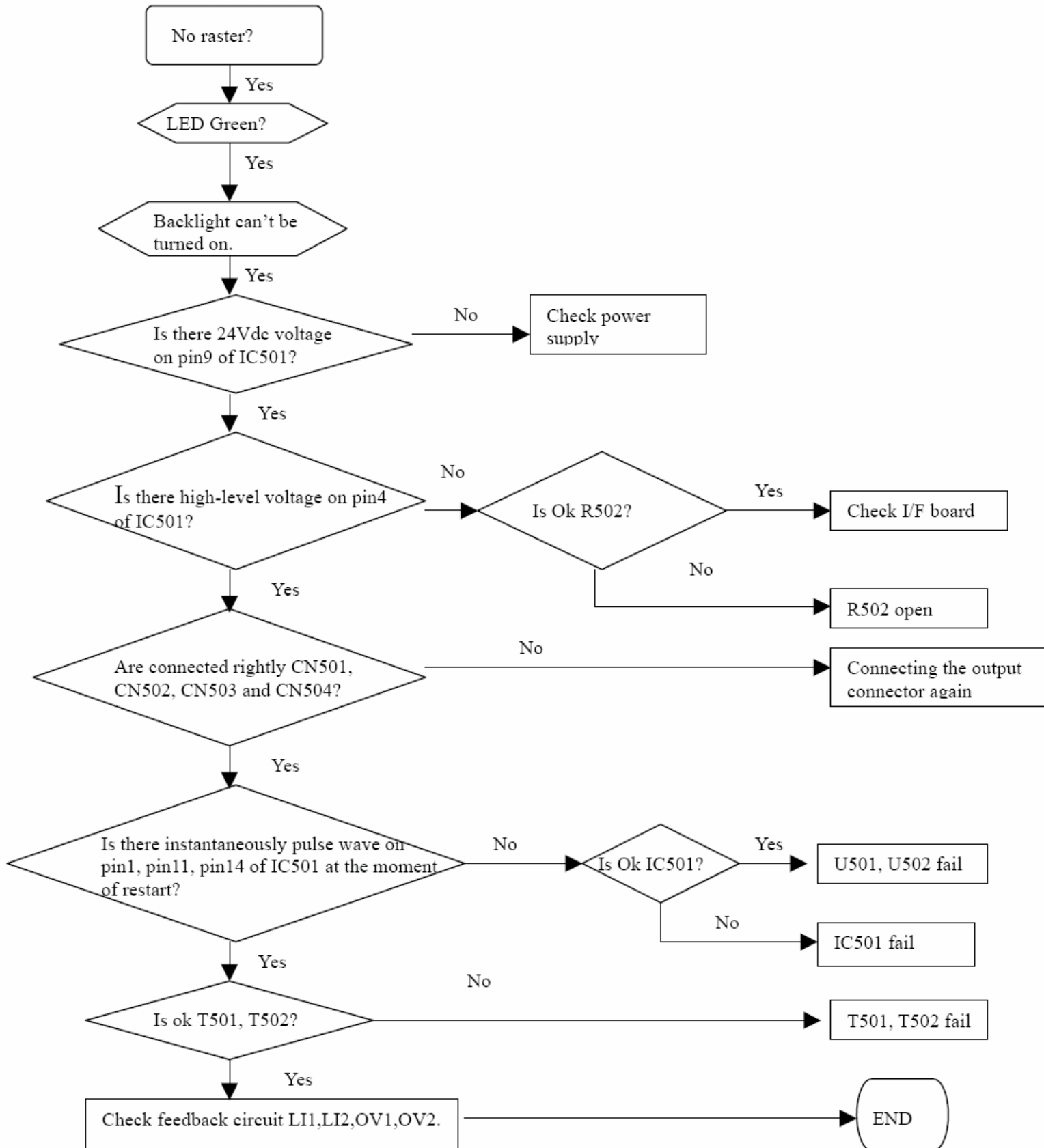

4.2 Black screen

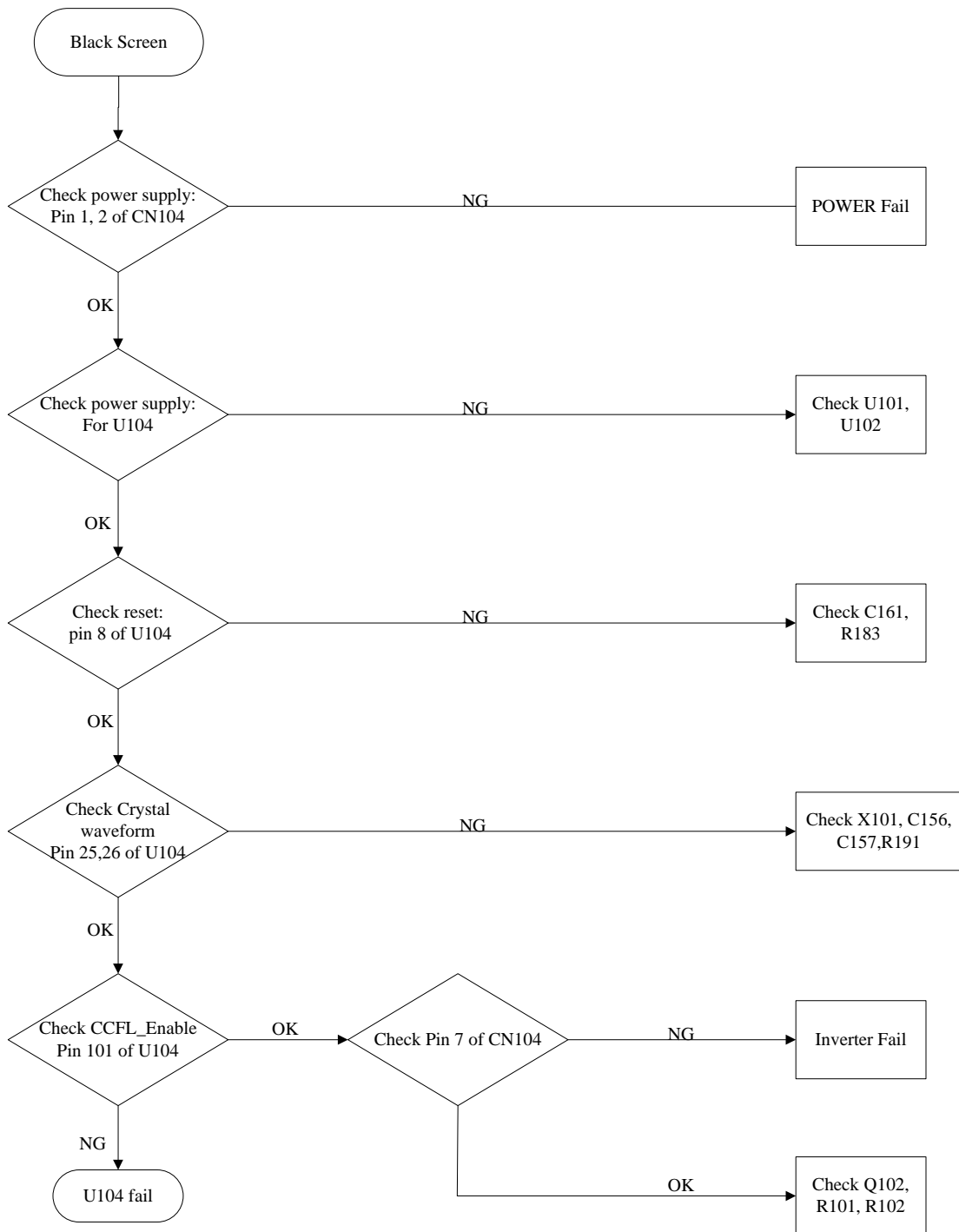

4.4 Bad Screen

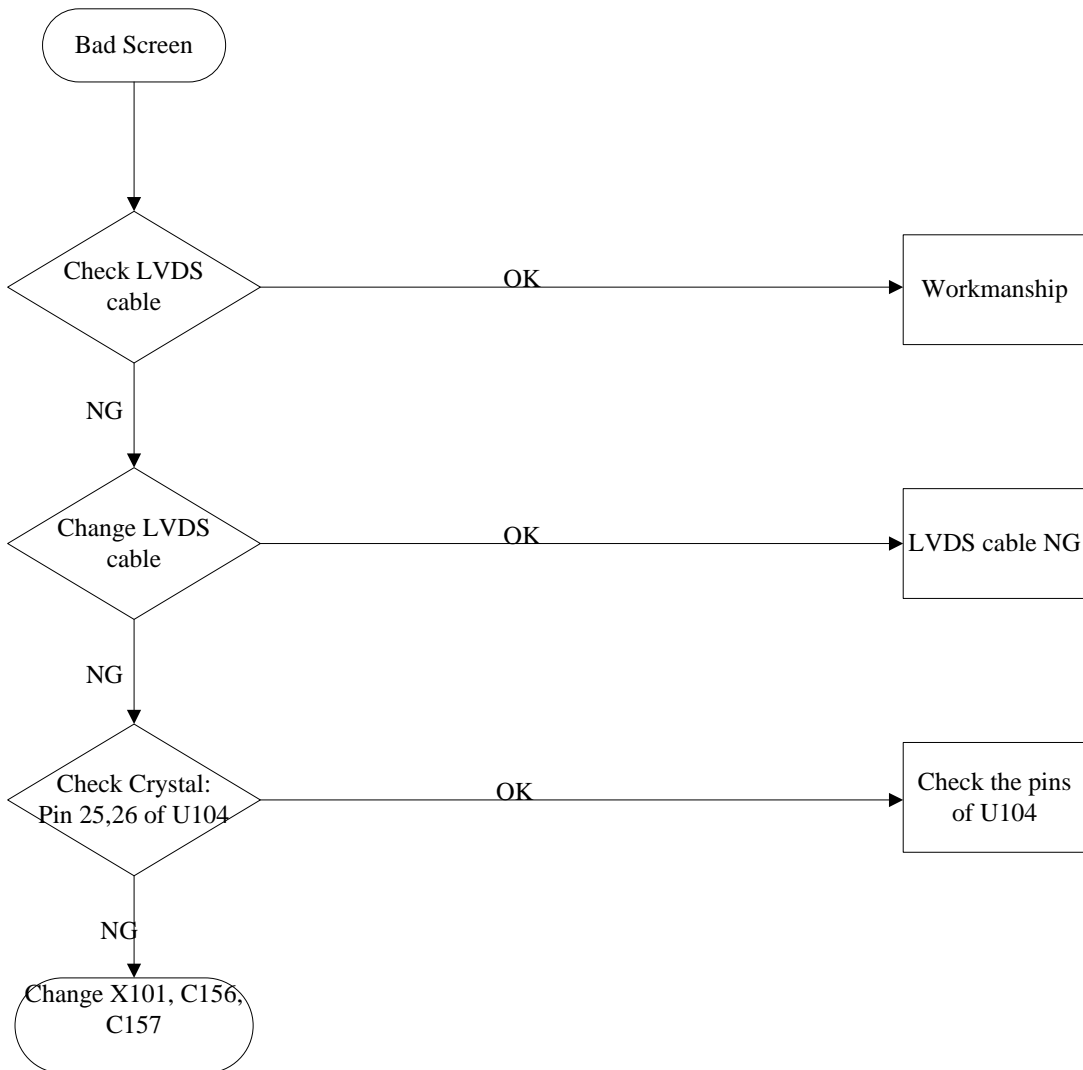

4.5 White screen

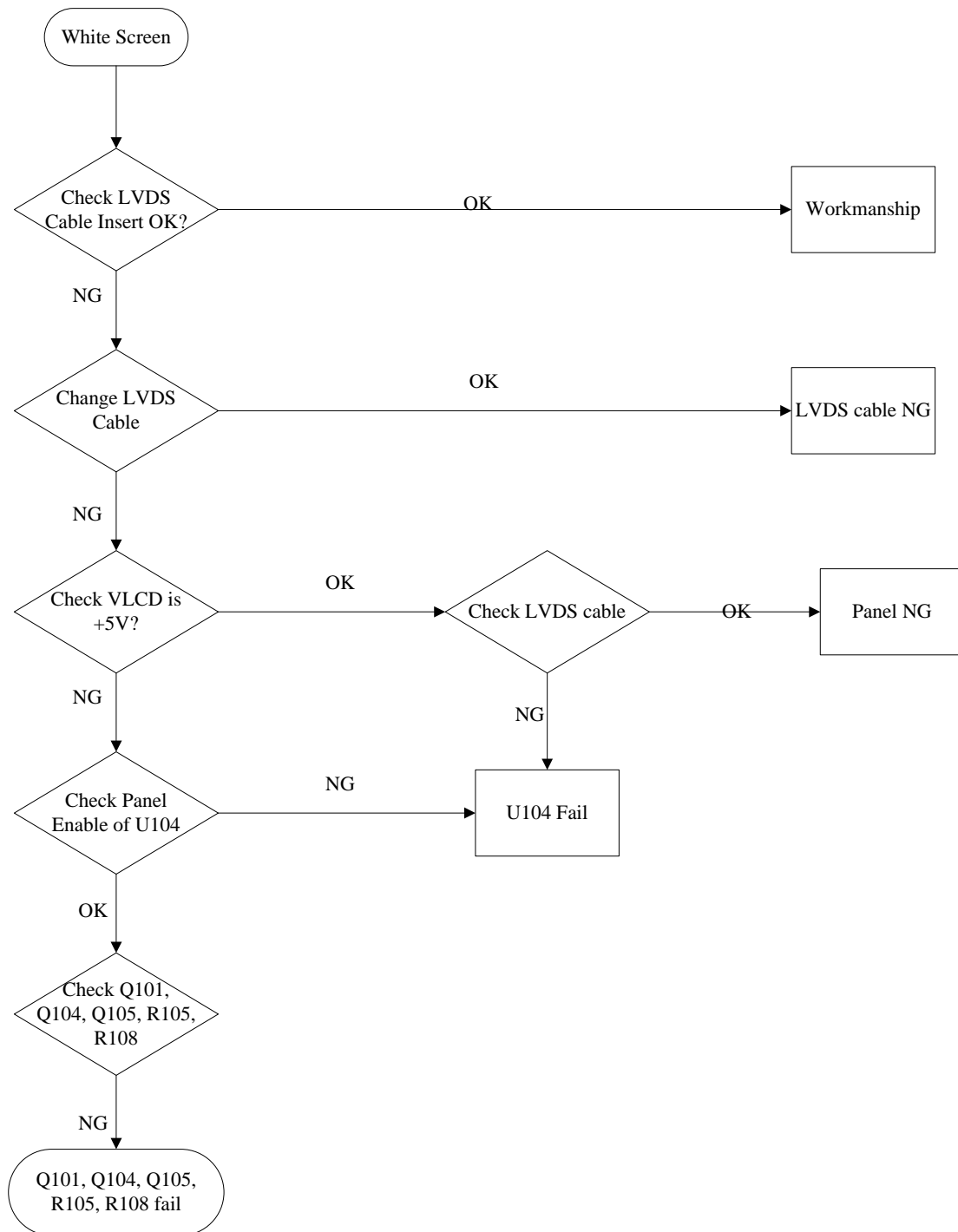

05 Spare parts List

			82424171A120R
OEM PART NO	DESCRIPTION	MOQ	N/A
792381300701R	PCBA,I/F BOARD(EMEA,W/SPK),LP2441-717 RO	50	1
792381400700R	PCBA,P/I BOARD,W/SPK,LP2441-717 ROHS	50	1
792381500000R	PCBA,POWER KYEPAD/B,LP2441 ROHS	50	1
792381500010R	PCBA,TOUCHPAD BOARD,LP2441 ROHS	50	1
453070801190R	PWRCORD 16A/250V BLK 6FT VDE/KTL H05VV-F	50	1
453030300370R	CABLE,DVI-D 18+1P MALE 6FT BLACK , ROHS	50	1
453030300371R	CABLE,DVI-D 18+1P MALE 6FT BLACK	50	1
453010100380R	CABLE,D-SUB 15P MALE 6FT BLACK/BLUE, ROH	50	1
453030300120R	CABLE AUDIO 1P 6FT BLACK/GREEN CP03B06P0	50	1
430303002230R	HRN LVDS FFC 30P 166.5mm W/TASTE	50	1
430300400390R	HRN ASS'Y 4P 27MM UL1571#28	50	1
430300802060R	HRN ASSY, 2X4P TO 1X8P ,220mm,UL1571#28	50	1
714050021200R	ASSY BACK COVER,LP2441	50	1
714030022100R	ASSY BEZEL ,LP2441	50	1
714011206200R	ASSY STAND ,LP2441	50	1
714020018200R	ASSY BASE,LP2441	50	1
501020228602R	COVER,BACK,LP2441	50	1
502060201100R	HINGE,LP2441	50	1
501260210800R	STAND, LP2441	50	1
502090103100R	CHASSIS,W /HDMI, W/DVI,LP2441	50	1
631102240130R	LCP 24" M240HW01-V0-00(A)(AUO)ROHS	50	1

06 Schematics and Layouts

6.1 PI BD Layout

LAYER	SILKSCREEN TOP				
PCB NO :	492091400100R	REV :	A	DESIGNER:	HUA LIU
FILE NAME :	ILPI-129	DATE :	2008.09.29.		

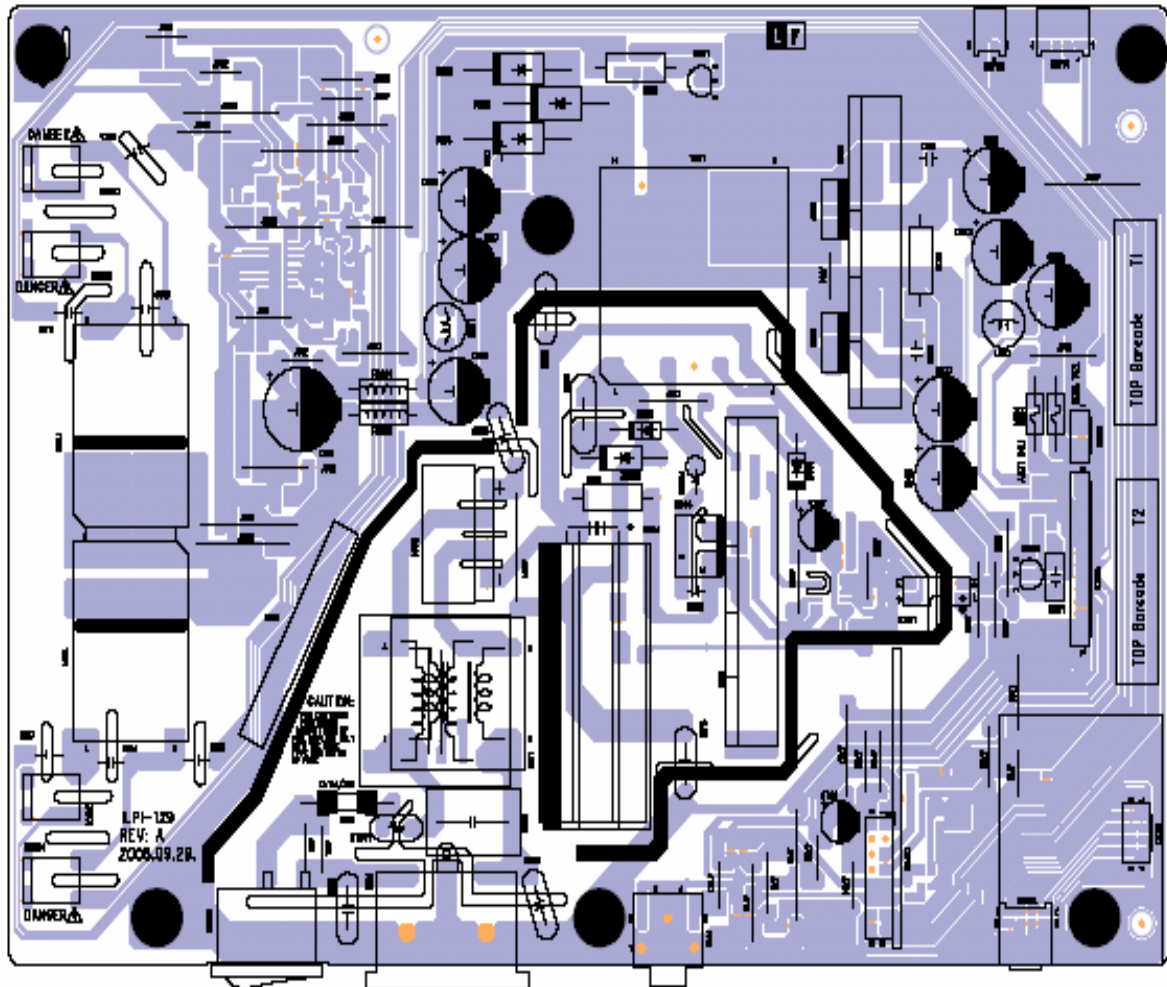

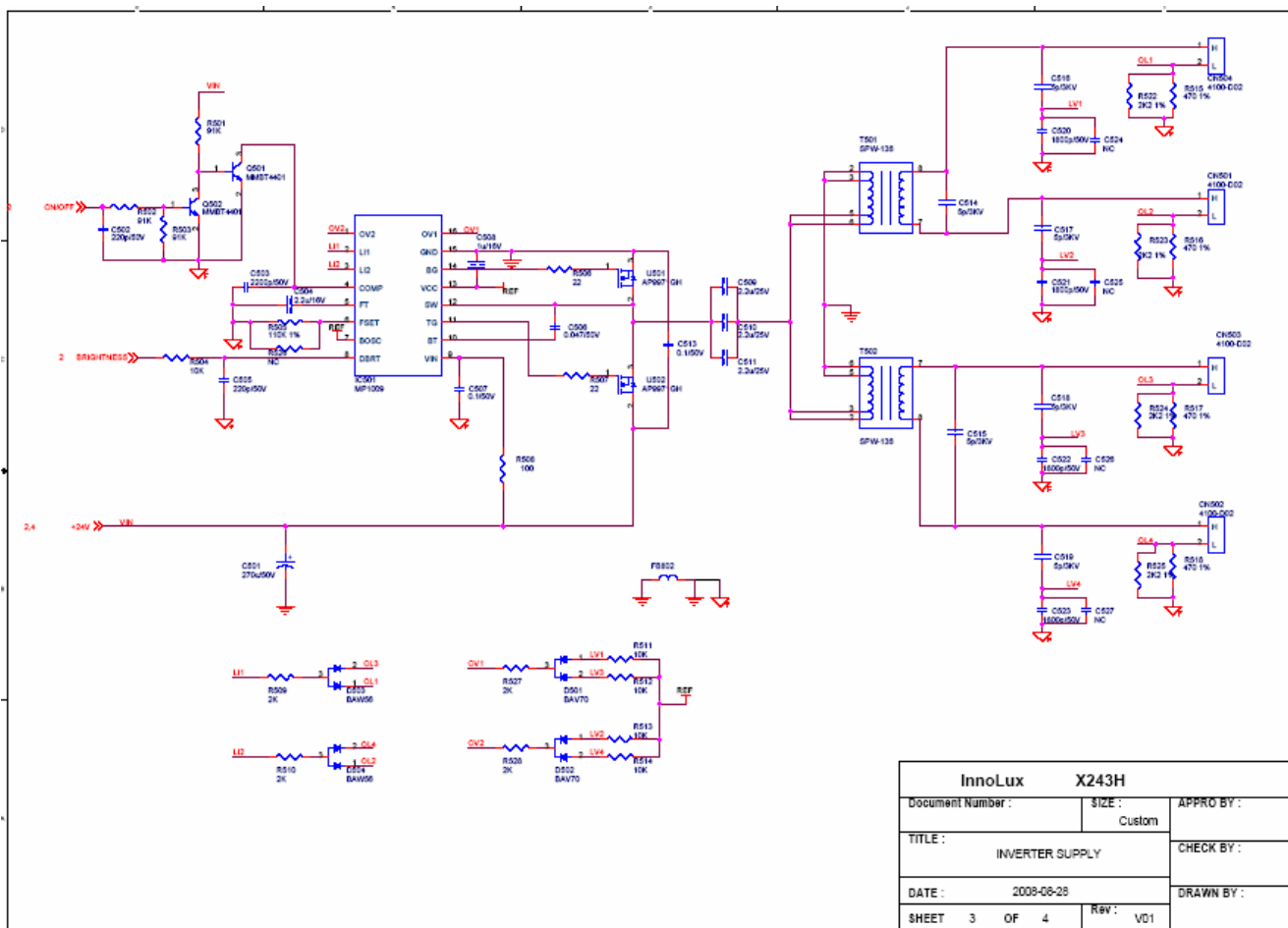
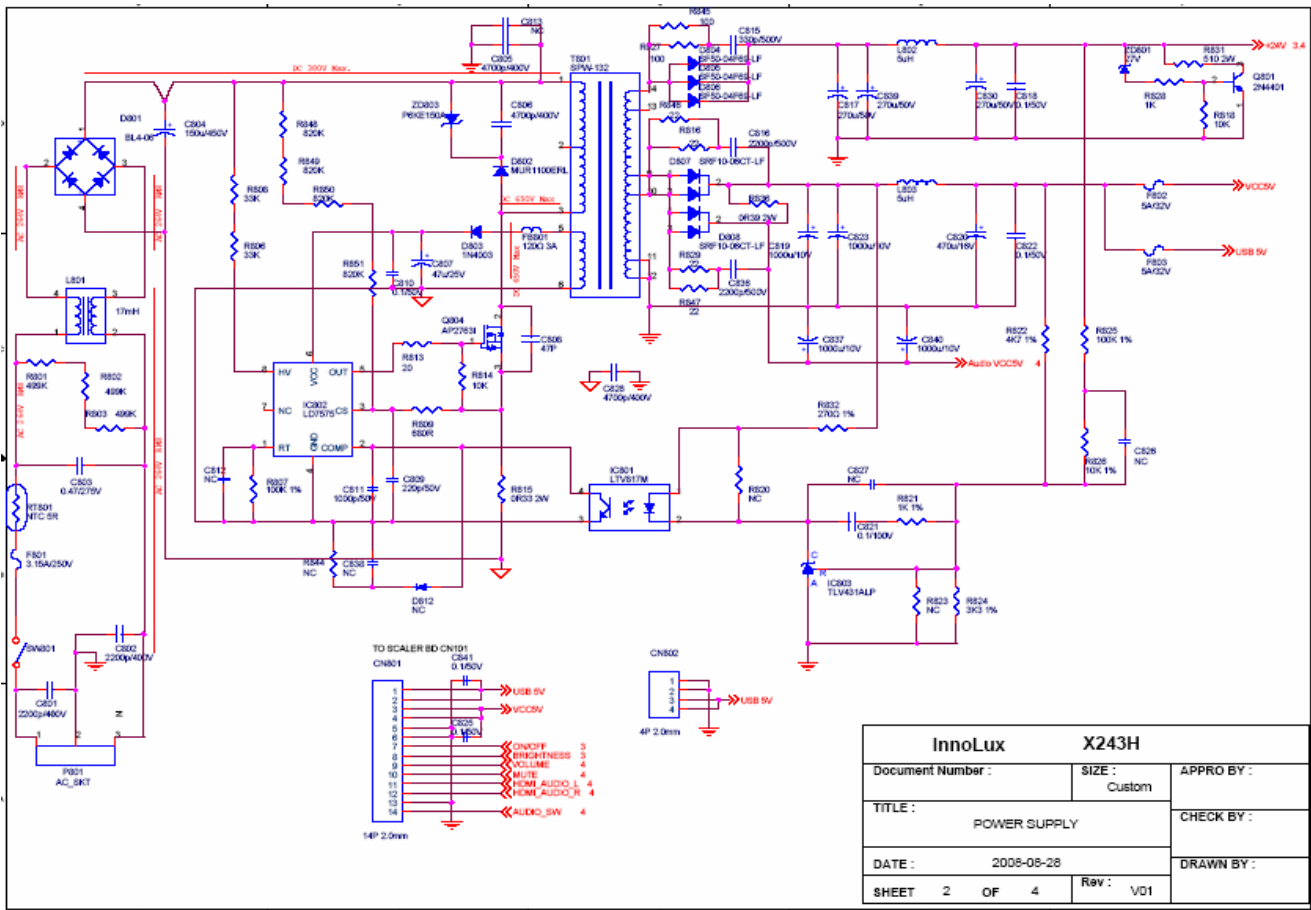

6.2 Switching Mode Power Supply circuit





7.0 Assembly and Disassembly

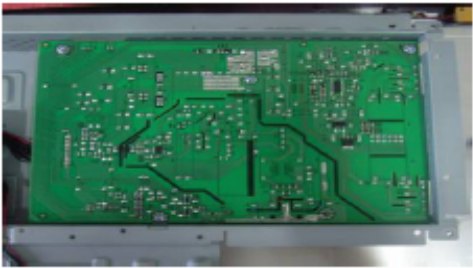

The tool of Assembly and disassembly : 1) Electrostatic gloves 2) Electric screwdriver: the lengthe of screwdriver top is $6\pm 0.5\text{cm}$ and $15\pm 0.5\text{cm}$; the diameter of screwdriver top is $\Phi 5\text{H}5\text{mm}$

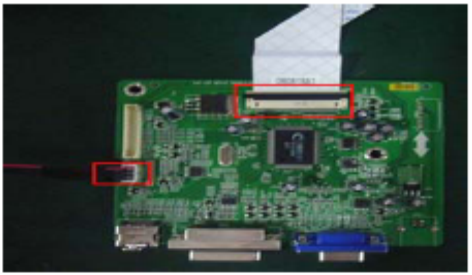
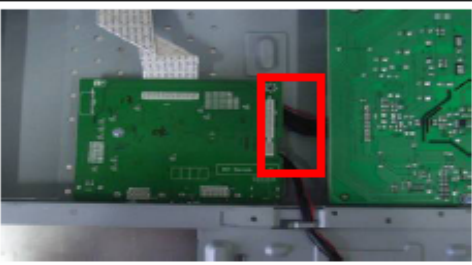
Sequence	Item	Photo	Procedures	PN	Description
S1	Place panel		<ol style="list-style-type: none"> 1. Take panel out of box and place it on the foam; 2. Tear open the PE bag and put it in the designated carton; 3. Place panel on the foma like the attached picture. Remark: Do not touch the lamp cord and place the surface of panel doansides on the cushion.	631102240130R	LCP 24" M240HW01-V0-00(A)(AUO)ROHS
S2	Assemble front bezel		<ol style="list-style-type: none"> 1. Take aluminum foil to stick it on the position near to keypad as attached ficture (Stick from the low-side of PANEL) 2. Fix front bezel on the panel and make sure to fix it well. 	714030022100R	ASSY BEZEL ,LP2441
S3	Assemble chassis and PI board		Place the chassis on the cushion after check, like the attached picture	502090103100R	CHASSIS,W /HDMI, W/DVI,LP2441
S4	Assemble chassis and PI board		Insert power board into the designated location of chassis, like the attached picture.	792381400700R	PCBA,POWER KYEPAD/B,LP2441 ROHS

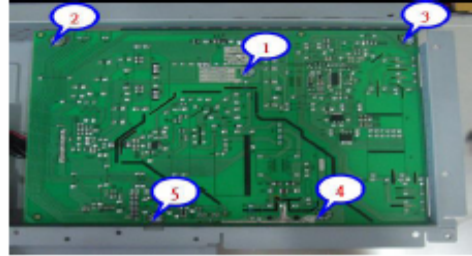

Assembly and Disassembly (continue)

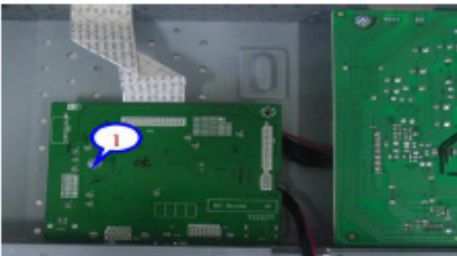
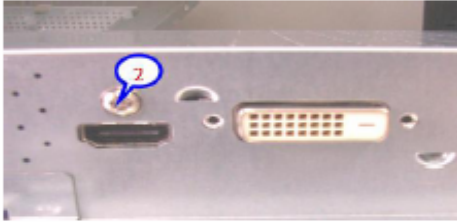
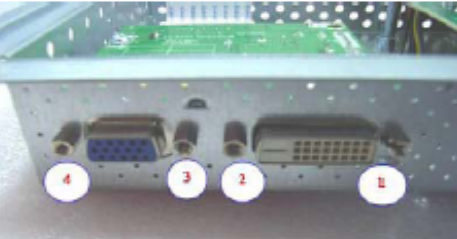
S5	Insert FFC cable		<ol style="list-style-type: none"> 1. Take FFC cable & main board, check the board if OK; 2. Insert FFC cables into designated location ; 3. Take 8P keypad LVDS cable to insert it into designated location well. 		
S6	Connect main board and power board		Connect powerboard with the relevant PIN in the mainboard like the attached picture.		
S7	Fix keypad cable		Press mainboard, fix keypad cable into the hook as attached picture		
S8	Fix powerboard		Take 5PCs M3*6 screws to fix powerboard as attached picture.	509146306200R	SCREW,P,CROSS, W/WAS,M3*6,Zn-Cc

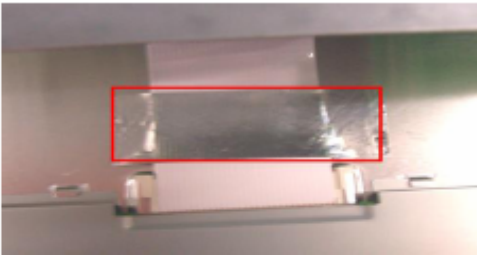

Assembly and Disassembly (continue)

S9	Fix mainboard	 <p>A photograph showing the mainboard being installed into the chassis. A blue callout bubble with the number '1' points to a screw hole on the board.</p>	Take 1PC M3*6 screw to fix mainboard as attached picture.	509146306200R	SCREW,P,CROSS, W/WAS,M3*6,Zn-Cc
S10	Fix HDMI connector	 <p>A photograph showing the HDMI connector being secured. A blue callout bubble with the number '2' points to a screw hole on the connector's housing.</p>	Take 1PC M3*6 screw to fix HDMI connector as attached picture.	509146306200R	SCREW,P,CROSS, W/WAS,M3*6,Zn-Cc
S11	Twist hexagonal screws	 <p>A photograph showing four screws being twisted into the bezel. Red callout bubbles with numbers 1, 2, 3, and 4 point to each screw location.</p>	<ol style="list-style-type: none"> 1. Handle hexagonal screws and electric opener; 2. Twist screw in the interface as attached picture; 3. Place cushion on the designated location after iron frame is taken away. 		
S12	Fix chassis	 <p>A photograph showing the metal chassis being attached to the back of the bezel. The chassis is being pushed into a hook-like structure.</p>	Reverse chassis 180degree and fix chassis into bezel hook as attached picture.		

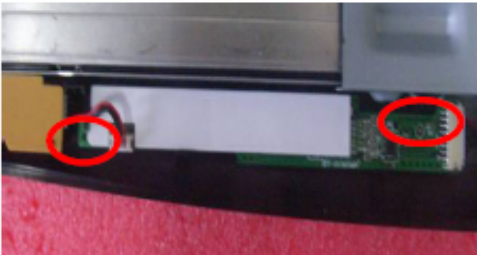

Assembly and Disassembly (continue)

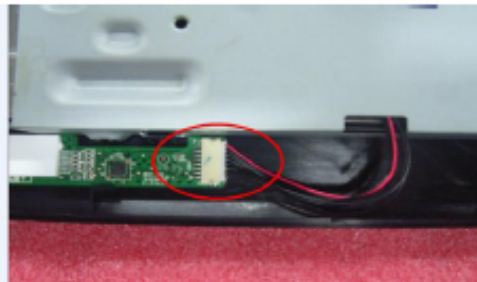
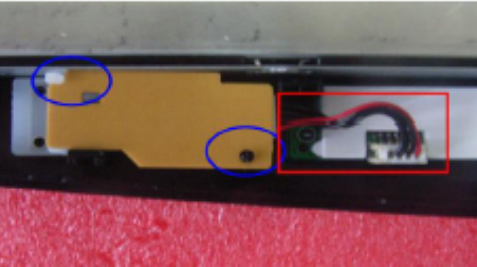
S13	Insert FFC cable		<p>1. Insert FFC cable into designated connector and use jig to insert it; 2. Tear off foil to stick the cable for fix.</p>		
S14	Insert lamp wire		<p>Insert 4pcs lamp wire into the relevant position and make sure the red one is on the left and the blue is on the right as attached picture.</p>		
S15	Connect keypad and power board		<p>Connect powerboard to the keypad with a cable like the attached picture.</p>		
S16	Fix keypad		<p>Fix keypad as attached picture</p>		

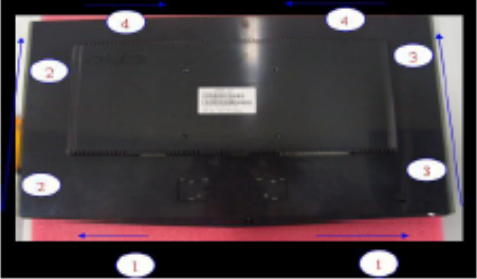
Assembly and Disassembly (continue)

S17	Fix keypad cable		Insert keypad cable into designated location as attached picture.		
S18	Assemble power button		<ol style="list-style-type: none"> 1. Fix power button into bezel's fixed pillar; 2. Lightly press the connect cable between power button and keypad to avoid cable being pressed by bezel as attached picture. 		
S19	Assemble speaker		<ol style="list-style-type: none"> 1. Take speakers to insert designated location and make sure to cross the speakers' cables, the red one is on the right and the green one is on the left as attached picture; 2. Fix speakers on the chassis as attached picture. 	618100200430R	SPEAKER 2.5W4Ω 230mm&210mm R/G/B W/CASE
S20	Assemble back cover		Buckle back cover according to the sequence as attached picture and check if the cover is fixed properly.	714050021200R	ASSY BACK COVER,LP2441

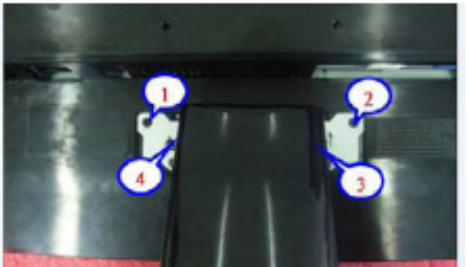
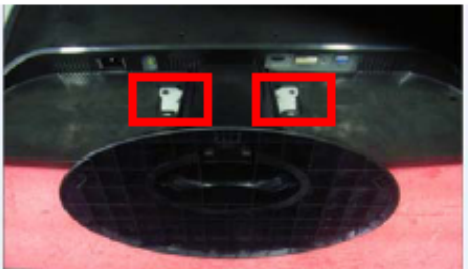
Assembly and Disassembly (continue)

S21	Fix stand		Place stand on the location and take 4pcs M4*8 screws to lock the stand as attached picture	714011206200R	ASSY STAND ,LP2441
S22	Fix hinge cover and base		Fix hinge cover and base like attached picture	714020018200R	ASSY BASE,LP2441
S23	Packing		Release monitor the packing like and pack it like attached picture		

Free Manuals Download Website

<http://myh66.com>

<http://usermanuals.us>

<http://www.somanuals.com>

<http://www.4manuals.cc>

<http://www.manual-lib.com>

<http://www.404manual.com>

<http://www.luxmanual.com>

<http://aubethermostatmanual.com>

Golf course search by state

<http://golfingnear.com>

Email search by domain

<http://emailbydomain.com>

Auto manuals search

<http://auto.somanuals.com>

TV manuals search

<http://tv.somanuals.com>