

## Safety Instructions

Observe the following safety guidelines when connection and using your monitor:

- Be sure that your monitor is electrically rated to operate with the AC power available in your location.
- Locate your monitor near an easily accessible electrical outlet.
- Place the monitor on a solid surface and treat it carefully. The screen can be damaged if dropped, sharply hit, or touched with a sharp or abrasive implement.
- Put your monitor in a location with low humidity and a minimum of dust.
- Never use your monitor if the power cable has been damaged. Do not allow anything to rest on the power cable, and keep the cable away from where people could trip over it.
- Never insert anything metallic into the monitor openings. Doing so may create the danger of electric shock.
- To avoid electric shock, never touch the inside of the monitor. Only a qualified technician should open the monitor's case.
- Be sure to hold the plug, not the cable, when disconnecting the monitor from an electrical outlet.
- Openings in the monitor cabinet are provided for ventilation. To prevent overheating, these openings should not be blocked or covered. Also, avoid using the monitor on a bed, sofa, rug, or other soft surface.
- Doing so may block the ventilation openings in the bottom of the cabinet. If you put the monitor in a bookcase or some other enclosed space, be sure to provide adequate ventilation.
- Do not expose the monitor to rain or use it near water. If the monitor accidentally gets wet, unplug it and contact an authorized dealer immediately. You can clean the exterior of the monitor with a damp cloth when necessary, but be sure to unplug the monitor first. If your monitor does not operate normally-in particular, if there are any unusual sounds or smells coming from it -unplug the monitor immediately and contact an authorized dealer or service center.

## Connecting Your Monitor to a Computer

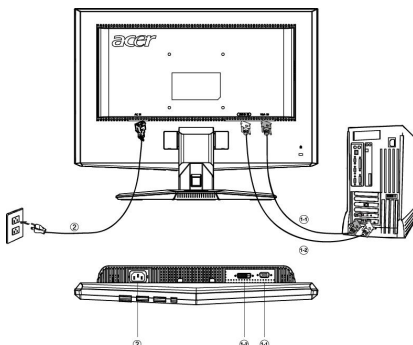

### 1. Connect Video Cable

- a. Make sure both the monitor and computer are powered-OFF.
- b. Connect the video cable to the computer.
- c. (only Dual-Input Model) Connect one end of the 24-pin DVI cable to the back of the monitor and connect the other end to the computer's port.

### 2. Connect power cord

Connect the power cord to the monitor, then to a properly grounded AC outlet.

### 3. Connect the Audio Cable.(optional)

### 4. Power-ON Monitor and Computer

Power-ON the monitor first, then power-ON the computer.

This sequence is very important.

5. If the monitor still does not function properly, please refer to the troubleshooting section to diagnose the problem.

## Troubleshooting Tips

### No Power - The monitor's power indicator is off.

Make sure the monitor power cable is fully inserted in the monitor's power port and the electrical outlet.

Test the electrical outlet by plugging in a working electrical device such as a lamp.

Try another power cable on the monitor. You can use the computer's power cable to perform this test.

### No Video - The monitor's power indicator is on but there are no image on the screen.

Ensure that the video connector is properly connected to the computer.

Ensure that the computer is on and functioning properly.

Turn off the monitor and check the video cable pins. Make sure no pins are bent.

## Operating Detail

Please refer to user's guide in CD-ROM packaged with this monitor

## TABLE OF CONTENTS

---

|  |    |
|--|----|
| Special notes on LCD monitors .....          | 1  |
| Information for your safety and comfort..... | 2  |
| Unpacking .....                              | 5  |
| Attaching/Removing the base .....            | 6  |
| Screen position adjustment .....             | 6  |
| Connecting the power cord .....              | 7  |
| Safety precaution .....                      | 7  |
| Cleaning your monitor .....                  | 7  |
| Power saving .....                           | 8  |
| DDC .....                                    | 8  |
| Connector Pin Assignment .....               | 9  |
| Standard Timing Table.....                   | 11 |
| Installation.....                            | 12 |
| User controls.....                           | 13 |
| How to adjust a setting.....                 | 14 |
| Troubleshooting.....                         | 19 |

---

### *SPECIAL NOTES ON LCD MONITORS*

The following symptoms are normal with LCD monitor and do not indicate a problem.

### *NOTES*

- Due to the nature of the fluorescent light, the screen may flicker during initial use. Turn off the Power Switch and then turn it on again to make sure the flicker disappears.
- You may find slightly uneven brightness on the screen depending on the desktop pattern you use.
- The LCD screen has effective pixels of 99.99% or more. It may include blemishes of 0.01% or less such as a missing pixel or a pixel lit all of the time.
- Due to the nature of the LCD screen, an afterimage of the previous screen may remain after switching the image, when the same image is displayed for hours. In this case, the screen is recovered slowly by changing the image or turning off the Power Switch for hours.

## *Information for your safety and comfort*

### Safety instructions

Read these instructions carefully. Keep this document for future reference. Follow all warnings and instructions marked on the product.

#### CAUTION for plug as disconnecting device

Observe the following guidelines when connecting and disconnecting power to the power supply unit:

Install the power supply unit before connecting the power cord to the AC power outlet. Unplug the power cord before removing the power supply unit from the product. If the system has multiple sources of power, disconnect power from the system by unplugging all power cords from the power supplies.

#### CAUTION for accessibility

Be sure that the power outlet you plug the power cord into is easily accessible and located as close to the equipment operator as possible. When you need to disconnect power to the equipment, be sure to unplug the power cord from the electrical outlet.

### Warnings

- Do not use this product near water.
- Do not place this product on an unstable cart, stand or table. If the product falls, it could be seriously damaged.
- Slots and openings are provided for ventilation to ensure reliable operation of the product and to protect it from overheating. These openings must not be blocked or covered. The openings should never be blocked by placing the product on a bed, sofa, rug or other similar surface. This product should never be placed near or over a radiator or heat register, or in a built-in installation unless proper ventilation is provided.
- Never push objects of any kind into this product through cabinet slots as they may touch dangerous voltage points or short-out parts that could result in a fire or electric shock. Never spill liquid of any kind onto or into the product.
- To avoid damage of internal components and to prevent battery leakage, do not place the product on a vibrating surface.
- Never use it under sporting, exercising, or any vibrating environment which will probably cause unexpected short current or damage rotor devices, HDD, Optical drive, and even exposure risk from lithium battery pack.

### Safe listening

Follow these instructions, suggested by hearing experts, to protect your hearing.

- Gradually increase the volume until you can hear it clearly and comfortably and without distortion.
- After setting the volume level, do not increase it after your ears adjust.
- Limit the amount of time listening to music at high volume.
- Avoid turning up the volume to block out noisy surroundings.
- Turn the volume down if you can't hear people speaking near you.

## Product servicing

Do not attempt to service this product yourself, as opening or removing covers may expose you to dangerous voltage points or other risks. Refer all servicing to qualified service personnel.

Unplug this product from the wall outlet and refer servicing to qualified service personnel when:

- the power cord or plug is damaged, cut or frayed
- liquid was spilled into the product
- the product was exposed to rain or water
- the product has been dropped or the case has been damaged
- the product exhibits a distinct change in performance, indicating a need for service
- the product does not operate normally after following the operating instructions



Note: Adjust only those controls that are covered by the operating instructions, since improper adjustment of other controls may result in damage and will often require extensive work by a qualified technician to restore the product to normal condition.

## LCD Pixel Statement

The LCD unit is produced with high-precision manufacturing techniques. Nevertheless, some pixels may occasionally misfire or appear as black or red dots. This has no effect on the recorded image and does not constitute a malfunction.

## Tips and information for comfortable use

Computer users may complain of eyestrain and headaches after prolonged use. Users are also at risk of physical injury after long hours of working in front of a computer. Long work periods, bad posture, poor work habits, stress, inadequate working conditions, personal health and other factors greatly increase the risk of physical injury.

Incorrect computer usage may lead to carpal tunnel syndrome, tendonitis, tenosynovitis or other musculoskeletal disorders. The following symptoms may appear in the hands, wrists, arms, shoulders, neck or back:

- numbness, or a burning or tingling sensation
- aching, soreness or tenderness
- pain, swelling or throbbing
- stiffness or tightness
- coldness or weakness

If you have these symptoms, or any other recurring or persistent discomfort and/or pain related to computer use, consult a physician immediately and inform your company's health and safety department.

The following section provides tips for more comfortable computer use.

## Finding your comfort zone

Find your comfort zone by adjusting the viewing angle of the monitor, using a footrest, or raising your sitting height to achieve maximum comfort. Observe the following tips:

- refrain from staying too long in one fixed posture
- avoid slouching forward and/or leaning backward
- stand up and walk around regularly to remove the strain on your leg muscles

- take short rests to relax your neck and shoulders
- avoid tensing your muscles or shrugging your shoulders
- install the external display, keyboard and mouse properly and within comfortable reach
- if you view your monitor more than your documents, place the display at the center of your desk to minimize neck strain

## Taking care of your vision

Long viewing hours, wearing incorrect glasses or contact lenses, glare, excessive room lighting, poorly focused screens, very small typefaces and low-contrast displays could stress your eyes. The following sections provide suggestions on how to reduce eyestrain.

### Eyes

- Rest your eyes frequently.
- Give your eyes regular breaks by looking away from the monitor and focusing on a distant point.
- Blink frequently to keep your eyes from drying out.

### Display

- Keep your display clean.
- Keep your head at a higher level than the top edge of the display so your eyes point downward when looking at the middle of the display.
- Adjust the display brightness and/or contrast to a comfortable level for enhanced text readability and graphics clarity.
- Eliminate glare and reflections by:
  - placing your display in such a way that the side faces the window or any light source
  - minimizing room light by using drapes, shades or blinds
  - using a task light
  - changing the display's viewing angle
  - using a glare-reduction filter
  - using a display visor, such as a piece of cardboard extended from the display's top front edge
- Avoid adjusting your display to an awkward viewing angle.
- Avoid looking at bright light sources, such as open windows, for extended periods of time.

## Developing good work habits

Develop the following work habits to make your computer use more relaxing and productive:

- Take short breaks regularly and often.
- Perform some stretching exercises.
- Breathe fresh air as often as possible.
- Exercise regularly and maintain a healthy body.



Warning! We do not recommend using the product on a couch or bed. If this is unavoidable, work for only short periods, take breaks regularly, and do some stretching exercises.



For more information and help in recycling, please visit the following websites:  
Worldwide: <http://global.acer.com/about/sustainability.htm>

## UNPACKING

Please check the following items are present when you unpack the box, and save the packing materials in case you will need to ship or transport the monitor in future.

- LCD Monitor

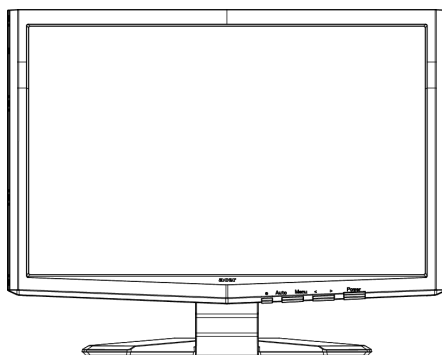

- D-Sub Cable



- DVI Cable  
(Only Dual-Input Model)

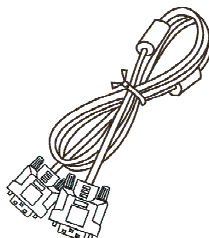

- AC Power Cord

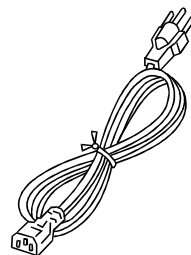

- User Manual

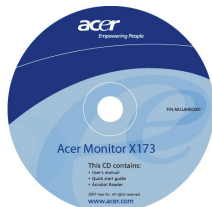

- Quick Start Guide



EN-5

## Attaching / Removing the Base

### Install:

Align the release button on the bottom of the monitor with the corresponding slots on the bottom of the base.

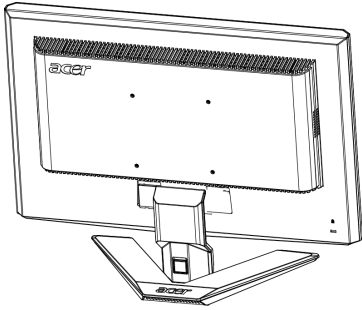

### Remove:

Depress the release button as indicated first before removing the base and follow the arrow direction to remove it.

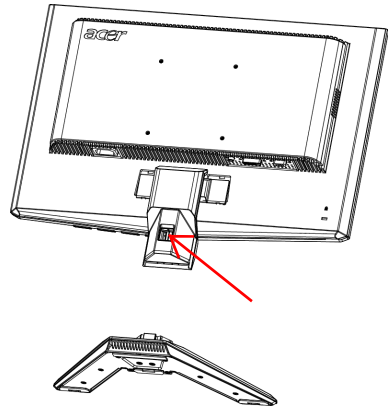

## SCREEN POSITION ADJUSTMENT

In order to optimize the best viewing position, you can adjust the tilt of the monitor by using both of your hands to hold the edges of the monitor as shown in the figure below.

The monitor can be adjusted to 15 degrees up or 5 degrees down as indicated by arrow below.

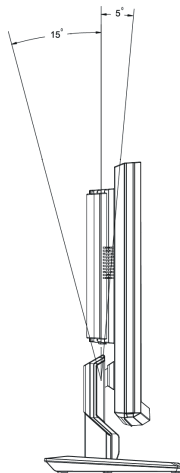

EN-6



## ***CONNECTING THE POWER CORD***

- Check first to make sure that the power cord you use is the correct type required for your area.
- This monitor has a universal power supply that allows operation in either 100/120V AC or 220/240 V AC voltage area. No user-adjustment is required.
- Plug one end of the power cord to the AC Inlet, plug another end to a proper AC outlet.
- For unit using at 120 V AC:  
Use a UL Listed Cord Set, Type SVT wire and plug rated 10 A/125 V.
- For unit using at 220/240 V AC (outside of U.S.):  
Use a Cord Set consisting of H05VV-F cord and plug rated 10 A, 250 V. The cord set should have the appropriate safety approvals for the country in which the equipment will be installed.

## ***SAFETY PRECAUTION***

- Avoid placing the monitor, or any other heavy object, on the power cord to avoid damage to the cable.
- Do not expose the monitor to rain, excessive moisture, or dust.
- Do not cover the ventilation slots or openings of the monitor. Always put the monitor in a place where there is adequate ventilation.
- Avoid placing the monitor against a bright background or where sunlight or other light sources may reflect on the face of the monitor. Place the monitor just below eye level.
- Handle with care when transporting the monitor.
- Refrain from giving shock or scratch to the screen, as screen is fragile.

## ***CLEANING YOUR MONITOR***

Please carefully follow the below guidelines when cleaning the monitor.

- Always unplug the monitor before cleaning.
- Use a soft cloth to wipe the screen and cabinet front and sides.

### *Power saving*

The monitor will be driven into Power Saving" mode by the control signal from the display controller, as indicated by the amber-color power LED.

| State             | LED Light |
|-------------------|-----------|
| ON                | Blue      |
| Power Saving Mode | Amber     |

The power saving states will be kept until a control signal has been detected or the keyboard or mouse is activated. The recovery time from Active OFF state back to ON state is around 3 seconds.

### *DDC*

To make your installation easier, the monitor is able to Plug and Play with your system if your system also supports DDC protocol. The DDC (Display Data Channel) is a communication protocol through which the monitor automatically informs the host system about its capabilities, for example, supported resolutions and corresponding timing. The monitor supports DDC2B standard.

## CONNECTOR PIN ASSIGNMENT

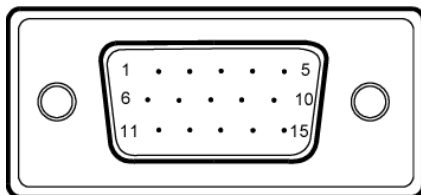

15-Pin Color Display Signal Cable

| PIN NO. | DESCRIPTION    | PIN NO. | DESCRIPTION      |
|---------|----------------|---------|------------------|
| 1.      | Red            | 9.      | +5V              |
| 2.      | Green          | 10.     | Logic Ground     |
| 3.      | Blue           | 11.     | Monitor Ground   |
| 4.      | Monitor Ground | 12.     | DDC-Serial Data  |
| 5.      | DDC-return     | 13.     | H-Sync           |
| 6.      | R-Ground       | 14.     | V-Sync           |
| 7.      | G-Ground       | 15.     | DDC-Serial Clock |
| 8.      | B-Ground       |         |                  |

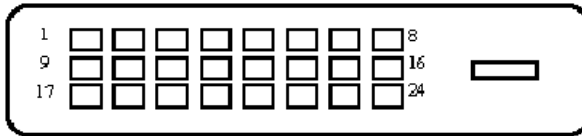

24-Pin Color Display Signal Cable

| PIN | Meaning                 | PIN | Meaning                            |
|-----|-------------------------|-----|------------------------------------|
| 1.  | TMDS Data2-             | 13. | NC                                 |
| 2.  | TMDS Data2+             | 14. | +5V Power                          |
| 3.  | TMDS Data 2/4<br>Shield | 15. | GND(return for<br>+5V hsync.vsync) |
| 4.  | NC                      | 16. | Hot Plug Detect                    |
| 5.  | NC                      | 17. | TMDS Data0-                        |
| 6.  | DDC Clock               | 18. | TMDS Data0+                        |
| 7.  | DDC Data                | 19. | TMDS Data 0/5<br>Shield            |
| 8.  | NC                      | 20. | NC                                 |
| 9.  | TMDS Data1-             | 21. | NC                                 |
| 10. | TMDS Data1+             | 22. | TMDS Clock Shield                  |
| 11. | TMDS Data 1/3<br>Shield | 23. | TMDS Clock+                        |
| 12. | NC                      | 24. | DDC TMDS Clock-                    |

### Standard Timing Table

To reduce the need for adjustment for different modes, the monitor has default setting modes that are most commonly used as given in the table below. For optimum adjustment, the user is suggested to perform the Auto Setup under Windows "Full Screen" pattern or using the pattern in the floppy disk provided. When none of the mode is matched, the user can store their preferred modes in the user modes. The monitor is capable of storing up to 9 user modes. The only condition to store as a user mode is the new display information must have 1 KHz difference for horizontal frequency or 1 Hz for vertical frequency or the sync signal polarities are different from the default modes.

| Mode | Resolution |             |          |
|------|------------|-------------|----------|
| 1    | VGA        | 720 x 400   | 70 Hz    |
| 2    | VGA        | 640 x 480   | 59.94 Hz |
| 3    | MAC        | 640 x 480   | 66.66 Hz |
| 4    | VESA       | 640 x 480   | 72 Hz    |
| 5    | VESA       | 640 x 480   | 75 Hz    |
| 6    |            | 648 x 500   | 57.7 Hz  |
| 7    | VESA       | 800 x 600   | 56.25 Hz |
| 8    | VESA       | 800 x 600   | 60 Hz    |
| 9    | VESA       | 800 x 600   | 72 Hz    |
| 10   | VESA       | 800 x 600   | 75 Hz    |
| 11   | MAC        | 832 x 624   | 74.55 Hz |
| 12   | VESA       | 1024 x 768  | 60 Hz    |
| 13   | VESA       | 1024 x 768  | 70 Hz    |
| 14   | VESA       | 1024 x 768  | 75 Hz    |
| 15   | VESA       | 1152 x 864  | 75 Hz    |
| 16   | VESA       | 1280 x 960  | 60 Hz    |
| 17   | VESA       | 1280 x 1024 | 60 Hz    |
| 18   | VESA       | 1280 x 1024 | 75 Hz    |

## INSTALLATION

To install the monitor to your host system, please follow the steps as given below:

### Steps

1. 1-1 Connect Video Cable
  - a. Make sure both the monitor and computer are powered-OFF.
  - b. Connect the VGA video cable to the computer.
- 1-2 Digital Cable (Only Dual-Input Model)
  - a. Make sure both the monitor and computer are powered-OFF.
  - b. Connect one end of the 24-pin DVI cable to the back of the monitor and connect the other end to the computer's port.
2. Connect power cord  
Connect the power cord to the monitor, then to a properly grounded AC outlet.
3. Power-ON Monitor and Computer  
Power-ON the monitor first, then power-ON the computer.  
This sequence is very important.
4. If the monitor still does not function properly, please refer to the troubleshooting section to diagnose the problem.

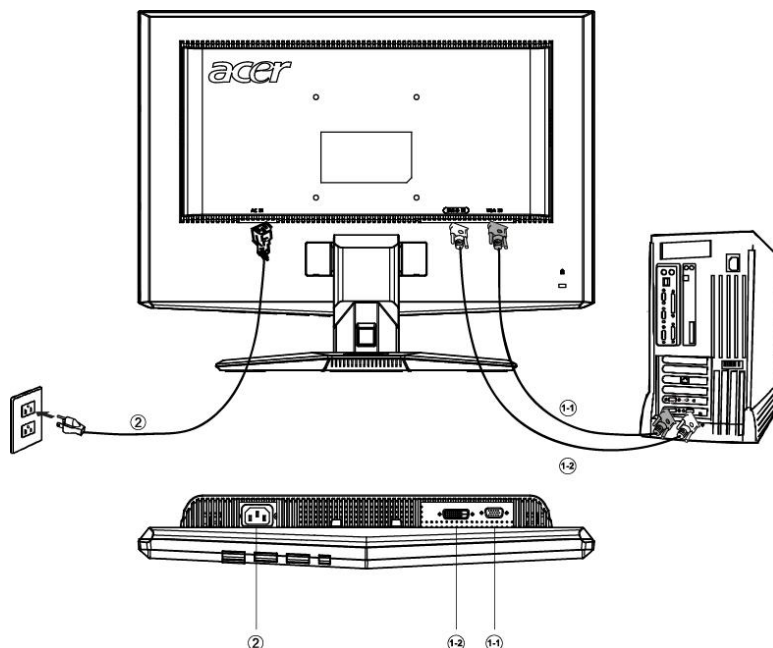

## USER CONTROLS

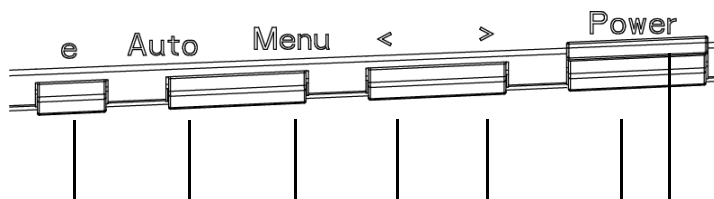

### Front Panel Controls

#### 1.Power Switch:

To turn ON or OFF the power.

#### 2.Power LED:

Lights up to indicate the power is turned ON.

#### 3. Empowering / Exit:

1) When OSD menu is in active status, this button will act as EXIT-KEY (EXIT OSD menu).

2) When OSD menu is in off status, press this button to select scenario mode.

#### 4.Auto Adjust button / Exit:

1) When OSD menu is in active status, this button will act as EXIT-KEY (EXIT OSD menu).

2) When OSD menu is in off status, press this button for 2 seconds to activate the AutoAdjustment function. The Auto Adjustment function is used to set the HPos, VPos, Clock and Focus.

#### 5.< / >

Press < or > to select the desired function. Press < or > to change the settings of the current function.

#### 6.MENU / ENTER:

Activate OSD menu when OSD is OFF or activate/de-activate adjustment function when OSD is ON.

## HOW TO ADJUST A SETTING

1. Press the MENU-button to activate the OSD window.
2. Press < or > to select the desired function.
3. Press the MENU-button to select the function that you want to adjust.
4. Press < or > to change the settings of the current function.
5. To exit and save, select the exit function. If you want to adjust any other function, repeat steps 2-4.

- P/X Series OSD behave  
When user press "MENU" button on front bezel

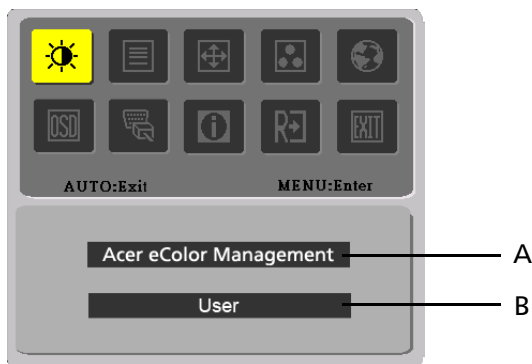

### A. Acer eColor Management

If selected to "Acer eColor Management " item, will appear the Acer eColor" OSD

### B. USER

If selected to "USER" item, will appear the Standard OSD



I. Only Analog Input Model







II. Only Dual Input Model









- ADJUSTING THE PICTURE









The descriptions for function control LEDs









A. Acer eColor Management

| Main Menu icon  | Sub Menu icon | Sub Menu item | Description  |
|---|---------------|---------------|--|
|  | N/A           | User mode     | User defined. Settings can be fine-tuned to suit any situation   |
|  | N/A           | Text mode     | Optimal balance of brightness and contrast prevent eyestrain. The most comfortable way to read onscreen text |
|  | N/A           | Standard mode | Default Setting. Reflects native display capability  |
|  | N/A           | Graphic mode  | Enhances colors and emphasize fine detail  |
|  | N/A           | Movie mode    | Displays scenes in clearest detail. Pictures and photographs appear in vibrant colors with sharp detail)     |

B. USER

| Main Menu icon  | Sub Menu icon   | Sub Menu item | Description   |
|---|---|---------------|---|
|  |  | Contrast      | Adjust the contrast between the foreground and background of the screen image |
|   |  | Brightness    | Adjust the background brightness of the screen image                          |
|   |  | ACM           | ACM (Adaptive Contrast Management)A CM ON/OFF Switch, default "OFF"           |
|  |  | Focus         | Adjust picture Focus (available in analog mode only)                          |
|   |  | Clock         | Adjust picture Clock (available in analog mode only)                          |

| Main Menu Icon  | Sub Menu Icon   | Sub Menu Item | Description   |
|---|---|---------------|---|
|    |  | H. Position   | Adjust the horizontal position. (available in Analog mode only) |
|   |  | V. Position   | Adjust the vertical position. (available in Analog mode only)   |
|    | N/A   | Warm          | Set the color temperature to warm white.                        |
|   | N/A   | Cool          | Set the color temperature to cool white.                        |
|   |  | User /Red     | Adjusts Red/Green/Blue intensity.                               |
|   |  | User /Green   |   |
|    | User /Blue  |               |   |
|  | N/A   | English       | Multi-language selection.                                       |
|   | N/A   | 繁體中文          |   |
|   | N/A   | Deutsch       |   |
|   | N/A   | Francais      |   |
|   | N/A   | Espanol       |   |
|   | N/A   | Italiano      |   |
|   | N/A   | 简体中文          |   |
|   | N/A   | 日本語           |   |
|   | N/A   | Suomi         | EMEA version OSD only   |
|   | N/A   | Nederlands    |   |
|   | N/A   | Pyccknn       |   |

| Main Menu Icon  | Sub Menu Icon   | Sub Menu Item                   | Description  |
|---|---|---------------------------------|--|
|  |  | H. Position                     | Adjust the horizontal position of the OSD.   |
|   |  | V. Position                     | Adjust the vertical position of the OSD.   |
|   |  | OSD Timeout                     | Adjust the OSD timeout.  |
|  | N/A   | Analog                          | Select input signal from analog (D-Sub)  |
|   | N/A   | Digital (only Dual-Input Model) | Select input signal from digital(DVI) (only Dual-Input Model)                      |
|   | N/A   | DDC/CI                          | Turn ON/OFF DDC/CI support   |
|  | N/A   | Information                     | Show the resolution, H/V frequency and input port of current input timing.         |
|  | N/A   | Reset                           | Clear each old status of Auto-configuration and set the color temperature to Cool. |
|  | N/A   | Exit                            | Save user adjustment and OSD disappear.  |

- Acer eColor Management OSD

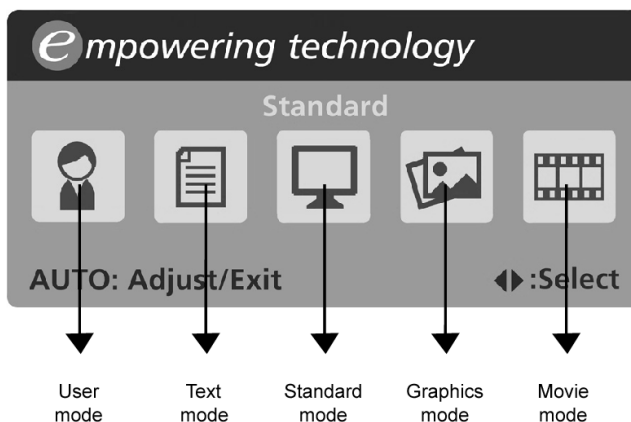

- Operation instructions

#### Acer eColor Management

Step 1: Press "  Key " to open the Acer eColor Management OSD and access the scenario modes

Step 2: Press "<" or ">" to select the mode

Step 3: Press " Auto Key " to confirm the mode and run Auto Adjust

- Features and Benefits

| Mode     | Features  | Benefits  |
|----------|---|---|
| Standard | Default settings  | Reflects native display capability                                  |
| Text     | Optimal balance of brightness and contrast prevents eyestrain | The most comfortable way to read onscreen text                      |
| Graphics | Enhances colors and emphasizes fine detail                    | Pictures and photographs appear in vibrant colors with sharp detail |
| Movie    | Displays scenes in clearest detail                            | Presents great visuals, even in unsuitably-lit environments         |
| User     | User defined  | Settings can be fine-tuned to suit any situation                    |

## TROUBLESHOOTING

Before sending your LCD monitor for servicing, please check the troubleshooting list below to see if you can self-diagnose the problem.

(VGA Mode)

| Problems                                       | Current Status  | Remedy  |
|--|---|---|
| No Picture                                     | LED ON  | · Using OSD, adjust brightness and contrast to maximum or reset to their default settings.  |
|  | LED OFF   | · Check the power switch.   |
|  |   | · Check if AC power cord is properly connected to the monitor.  |
|  | LED displays amber color  | · Check if video signal cable is properly connected at the back of monitor.   |
| · Check if the power of computer system is ON. |   |   |
| Abnormal Picture                               | Unstable Picture  | · Check if the specification of graphics adapter and monitor is in compliance which may be causing the input signal frequency mismatch.       |
|  | Display is missing, center shift, or too small or too large in display size | · Using OSD, adjust RESOLUTION, CLOCK, CLOCK-PHASE, H-POSITION and V-POSITION with non-standard signals.                                      |
|  |   | · Using OSD, in case of missing full-screen image, please select other resolution or other vertical refresh timing.                           |
|  |   | · Wait for a few seconds after adjusting the size of the image before changing or disconnecting the signal cable or powering OFF the monitor. |

## (DVI Mode)

| Problems   | Current Status           | Remedy   |
|------------|--------------------------|--|
| No Picture | LED ON                   | <ul style="list-style-type: none"><li>· Using OSD, adjust brightness and contrast to maximum or reset to their default settings.</li></ul> |
|            | LED OFF                  | <ul style="list-style-type: none"><li>· Check the power switch.</li></ul>  |
|            |                          | <ul style="list-style-type: none"><li>· Check if AC power cord is properly connected to the monitor.</li></ul>                             |
|            | LED displays amber color | <ul style="list-style-type: none"><li>· Check if video signal cable is properly connected at the back of monitor.</li></ul>                |
|            |                          | <ul style="list-style-type: none"><li>· Check if the power of computer system is ON.</li></ul>   |

## *Regulations and safety notices*

### FCC notice

This device has been tested and found to comply with the limits for a Class B digital device pursuant to Part 15 of the FCC rules. These limits are designed to provide reasonable protection against harmful interference in a residential installation. This device generates, uses, and can radiate radio frequency energy and, if not installed and used in accordance with the instructions, may cause harmful interference to radio communications.

However, there is no guarantee that interference will not occur in a particular installation. If this device does cause harmful interference to radio or television reception, which can be determined by turning the device off and on, the user is encouraged to try to correct the interference by one or more of the following measures:

- Reorient or relocate the receiving antenna.
- Increase the separation between the device and receiver.
- Connect the device into an outlet on a circuit different from that to which the receiver is connected.
- Consult the dealer or an experienced radio/television technician for help.

### Notice: Shielded cables

All connections to other computing devices must be made using shielded cables to maintain compliance with FCC regulations.

### Notice: Peripheral devices

Only peripherals (input/output devices, terminals, printers, etc.) certified to comply with the Class B limits may be attached to this equipment. Operation with non-certified peripherals is likely to result in interference to radio and TV reception.

### Caution

Changes or modifications not expressly approved by the manufacturer could void the user authority, which is granted by the Federal Communications Commission, to operate this product.

### Operation conditions

This device complies with Part 15 of the FCC Rules. Operation is subject to the following two conditions: (1) this device may not cause harmful interference, and (2) this device must accept any interference received, including interference that may cause undesired operation.

### Notice: Canadian users

This Class B digital apparatus complies with Canadian ICES-003.

### Remarque à l'intention des utilisateurs canadiens

Cet appareil numérique de la classe B est conforme à la norme NMB-003 du Canada.

## LAMP Disposal



LAMP(S) INSIDE THIS PRODUCT CONTAIN MERCURY AND MUST BE RECYCLED OR DISPOSED OF ACCORDING TO LOCAL, STATE OR FEDERAL LAWS. FOR MORE INFORMATION, CONTACT THE ELECTRONIC INDUSTRIES ALLIANCE AT [WWW.EIAE.ORG](http://WWW.EIAE.ORG). FOR LAMP SPECIFIC DISPOSAL INFORMATION CHECK [WWW.LAMPRECYCLE.ORG](http://WWW.LAMPRECYCLE.ORG).

依据中国《电子信息产品污染控制管理办法》，简称《管理办法》或《China RoHS》之规定，列出宏碁电子信息产品中可能含有的有毒或有害物质的名称及含量于以下表格中。

### 显示器（液晶及 CRT）

| 零部件名称        | 有毒有害物质或元素 |        |        |                         |            |              |
|--------------|-----------|--------|--------|-------------------------|------------|--------------|
|              | 铅 (Pb)    | 汞 (Hg) | 镉 (Cd) | 六价铬 (Cr <sup>6+</sup> ) | 多溴联苯 (PBB) | 多溴二苯醚 (PBDE) |
| 金属结构件        | X         | O      | O      | O                       | O          | O            |
| 塑料结构件        | O         | O      | O      | O                       | O          | O            |
| 电路板组件*       | X         | O      | O      | O                       | O          | O            |
| 液晶显示屏 / 灯管   | X         | X      | O      | O                       | O          | O            |
| CRT 显示屏 / 灯管 | X         | O      | O      | O                       | O          | O            |
| 电源模块         | X         | O      | O      | O                       | O          | O            |
| 电源线          | O         | O      | O      | O                       | O          | O            |
| 外部信号连接线      | X         | O      | O      | O                       | O          | O            |
| 喇叭           | X         | O      | O      | O                       | O          | O            |

\*: 电路板组件包括印刷电路板及其构成的零部件，如电阻、电容、集成电路、连接器等

O: 表示该有毒有害物质在该部件所有均质材料中的含量均在《电子信息产品中有毒有害物质的限量要求标准》规定的限量要求以下

X: 表示该有毒有害物质至少存在于该部件的某一均质材料中，是因为目前业界还没有成熟的可替代技术，以致含量虽然超出《电子信息产品中有毒有害物质的限量要求标准》规定的限量要求；但仍然符合欧盟 RoHS 指令所容许的豁免条款及电池指令的要求。

## JAPANESE MATERIAL CONTENT DECLARATION

A Japanese regulatory requirement, defined by specification JIS 0950, 2005, mandates that manufacturers provide Material Content Declarations for certain categories of electronic products offered for sale after July 1, 2006.

To view the JIS C 0950 material declaration for this product. Visit <http://global.acer.com/about/sustainability.htm>

## Disposal of Waste Equipment by Users in Private Household in the European Union



This symbol on the product or on its packaging indicates that this product must not be disposed of with your other household waste. Instead, it is your responsibility to dispose of your waste equipment by handing it over to a designated collection point for the recycling of waste electrical and electronic equipment. The separate collection and recycling of your waste equipment at the time of disposal will help to conserve natural resources and ensure that it is recycled in a manner that protects human health and the environment. For more information about where you can drop off your waste equipment for recycling, please contact your local city office, your household waste disposal service or the shop where you purchased the product.



## SPECIFICATION

|                               |                |   |
|-------------------------------|----------------|---|
| LCD Panel                     | Driving system | TFT Color LCD                                 |
|                               | Size           | 17.0"   |
|                               | Pixel pitch    | 0.264mm( H )x 0.264mm( V )                    |
|                               | Brightness     | 300cd/m <sup>2</sup> (Typical)                |
|                               | Contrast       | 2000:1 (ACM)                                  |
|                               | Viewable angle | 160° (H) 160° (V)                             |
|                               | Response time  | 5 ms (Typical)                                |
|                               | Video          | R,G,B Analog Interface                        |
|                               | H-Frequency    | 30KHz - 82KHz                                 |
|                               | V-Frequency    | 55-76Hz                                       |
| Display Colors                |                | 16.7M Colors                                  |
| Dot Clock                     |                | 135MHz  |
| Max. Resolution               |                | 1280 x 1024 @75Hz                             |
| Plug & Play                   |                | VESA DDCCI/DDC2B                              |
| ENERGY STAR                   | ON Mode        | ≤ 35W   |
|                               | OFF Mode       | ≤ 1 W   |
| Power Consumption ( Maximum ) |                | 38 Watts                                      |
| Input Connector               |                | D-Sub   |
|                               |                | DVI-D 24pin (Only Dual-Input Model)           |
| Input Video Signal            |                | Analog:0.7Vp-p(standard),<br>75 OHM, Positive |
|                               |                | Digital signal (Only Dual-Input Model)        |
| Maximum Screen Size           |                | Horizontal :337.92mm<br>Vertical : 270.34mm   |
| Power Source                  |                | 100-240VAC,50/60Hz                            |

## SPECIFICATION

|                              |           |   |
|------------------------------|-----------|---|
| Environmental Considerations |           | Operating Temp: 5° to 40°C<br>Storage Temp.: -20° to 60°C<br>Operating Humidity: 10% to 85%   |
| Dimensions                   |           | 381.33(W) x 375.39(H) x 163.72(D)mm   |
| Weight (N. W.)               |           | 4.2 kg Unit (net)   |
| External Controls:           | Switch    | Power Button<br></><br>MENU/ENTER<br>Automatic adjustment/ Exit<br>Empowering Key/ Exit   |
|                              | Functions | Contrast<br>Brightness<br>ACM On/Off<br>Focus<br>Clock<br>H.Position<br>V.Position<br>(Warm) Color<br>(Cool) Color<br>RGB Color temperature<br>Language<br>OSD position . timeout<br>Auto configuration (only Analog input model)<br>Input signal Selection (only Dual input model)<br>DDCCI On/Off<br>Display information<br>Reset<br>Exit |

\* All specifications are subject to change without notice.

## Regulatory Compliance



## Free Manuals Download Website

<http://myh66.com>

<http://usermanuals.us>

<http://www.somanuals.com>

<http://www.4manuals.cc>

<http://www.manual-lib.com>

<http://www.404manual.com>

<http://www.luxmanual.com>

<http://aubethermostatmanual.com>

Golf course search by state

<http://golfingnear.com>

Email search by domain

<http://emailbydomain.com>

Auto manuals search

<http://auto.somanuals.com>

TV manuals search

<http://tv.somanuals.com>