

Important safety instructions	3
Disposal instructions	3
Declaration of Conformity	3
First things first	4
Packing checklist	4
Your LCD TV overview	4
Front panel view	4
Rear panel view	5
Remote control	6
General keys	6
Teletext	6
Basic connections	7
Connecting the power cord	7
Setting up the remote control	7
Enjoying analog and digital TV	7
Connecting an antenna/cable	7
Getting started watching your TV	7
Connecting external audio/video devices	8
Connecting a DVD, VCR, STB or audio/video equipment	8
Connecting a camera, camcorder or video game	9
Connecting a PC or notebook computer	9
Selecting the input source	9
OSD navigation	10
Navigating the OSD with the remote control	10
Adjusting the OSD settings	11
Empowering Technology	12
Set-up Empowering mode	12
Default setting in different Empowering mode	13
Advanced features	14
Parental Control	14
Reorder for channels	15
TV ratings (for digital TV mode)	17
Channel list (for digital TV mode)	18
Electronic programme guide (for digital TV mode)	19
Audio effects	20
Widescreen display mode	21
Troubleshooting	22
PC Input Signal Reference Chart	23
Product specifications	24

Copyright © 2007. Acer Incorporated.
All Rights Reserved.

Acer LCD TV User's Guide
Original Issue: 10/2007

Changes may be made periodically to the information in this publication without obligation to notify any person of such revisions or changes. Such changes will be incorporated in new editions of this manual or supplementary documents and publications. This company makes no representations or warranties, either expressed or implied, with respect to the contents hereof and specifically disclaims the implied warranties of merchantability or fitness for a particular purpose.

Record the model number, serial number, purchase date, and place of purchase information in the space provided below. The serial number and model number are indicated on the label affixed to your device. All correspondence concerning your unit should include the serial number, model number, and purchase information.

No part of this publication may be reproduced, stored in a retrieval system, or transmitted, in any form or by any means, electronically, mechanically, by photocopy, recording, or otherwise, without the prior written permission of Acer Incorporated.



Model Number: _____

Serial Number: _____

Purchase Date: _____

Place of Purchase: _____

Acer and the Acer Logo are registered trademarks of Acer Inc. Other companies' product names or trademarks are used herein for identification purposes only and belong to their respective companies.

	HDMI, the HDMI logo and High-Definition Multimedia Interface are trademarks or registered trademarks of HDMI Licensing LLC.
	DVB is a registered trademark of the DVB Project.

Important safety instructions

Read these instructions carefully. Please put them somewhere safe for future reference.

- 1 Follow all warnings and instructions marked on the product.
- 2 Unplug this product from the wall outlet before cleaning. Do not use liquid cleaners or aerosol cleaners. Use a damp cloth for cleaning.
- 3 Do not use this product near water.
- 4 Do not place this product on an unstable cart, stand or table. The product may fall, sustaining serious damage.
- 5 Slots and openings are provided for ventilation; to ensure reliable operation of the product and to protect it from overheating, these openings must not be blocked or covered. The openings should never be blocked by placing the product on a bed, sofa, rug or other similar surface. This product should never be placed near or over a radiator or heat register or in a built-in installation unless proper ventilation is provided.
- 6 This product should be operated from the type of power indicated on the marking label. If you are not sure of the type of power available, consult your dealer or local power company.
- 7 Do not allow anything to rest on the power cord. Do not locate this product where the cord will be stepped on.
- 8 If an extension cord is used with this product, make sure that the total ampere rating of the equipment plugged into the extension cord does not exceed the extension cord ampere rating. Also, make sure that the total rating of all products plugged into the wall outlet does not exceed the fuse rating.
- 9 Never push objects of any kind into this product through cabinet slots as they may touch dangerous voltage points or short-out parts, which could result in a fire or electric shock. Never spill liquid of any kind on the product.
- 10 Do not attempt to service this product yourself, as opening or removing covers may expose you to dangerous voltage points or other risks. Refer all servicing to qualified service personnel.
- 11 Unplug this product from the wall outlet and refer servicing to qualified service personnel under the following conditions:
 - a. When the power cord or plug is damaged or frayed.
 - b. If liquid has been spilled into the product.
 - c. If the product has been exposed to rain or water.
 - d. If the product does not operate normally when the operating instructions are followed. Adjust only those controls that are covered by the operating instructions. Improper adjustment of other controls could result in damage; extensive work by a qualified technician might then be required to restore the product to normal condition.
 - e. If the product has been dropped or the case has been damaged.
 - f. If the product exhibits a distinct change in performance, indicating a need for service.
- 12 Use only the proper type of power supply cord set (provided in your accessories box) for this unit. Always disconnect the power cord from the wall outlet before servicing or disassembling this equipment.
- 13 Do not overload an electrical AC outlet, power strip, or convenience receptacle. The overall system load must not exceed 80% of the branch circuit rating. If power strips are used, the load should not exceed 80% of the power strip input rating.
- 14 Some products are equipped with a three-wire electrical grounding-type plug that has a third pin for grounding. This plug only fits into a grounded electrical outlet. This is a safety feature. Make sure the AC outlet is properly grounded. Do not defeat the safety purpose of the grounding-type plug by trying to insert it into a non-grounded outlet. If you cannot insert the plug into the outlet, contact your electrician to replace the obsolete outlet.
- 15 Do not use this LCD TV in the workplace, and maintain ample distance from it when watching. Watching a big-screen TV too close can cause eyestrain.



The grounding pin is an important safety feature. It is possible to receive an electric shock from a system that is not properly grounded



The grounding pin is also providing good immunity ability against unexpected noise that interferes performance of this product and is produced by other nearby electrical devices.

Disposal instructions

Do not throw this electronic device into the rubbish bin / container when discarding. To minimize pollution and ensure utmost protection of the global environment, please recycle.

For more information regarding WEEE, please refer to <http://global.acer.com/about/environmental.htm>



Declaration of Conformity

We,
ACER EUROPE AG

Centro Galleria 2 Via Cantonale 0 6928 Manno – SWITZERLAND
Tel: +41 (91) 222 13 11 - Fax: +41 (91) 222 13 22

Contact Person:

Mr. Lutz Schoppe
Tel +49-89-189 290-14 Fax +49-89-96 209-321
E-mail: lutz_schoppe@acer-euro.com

Mr. Easy Lai

Tel: +886-2-8691-3089 Fax: +886-2-8691-3120
E-mail: easy_lai@acer.com.tw

Hereby declare that:

Product: 19" LCD TV Monitor
Trade Name: Acer
Model Number: AT1935

Is compliant with the essential requirements and other relevant provisions of the following EC directives, and that all the necessary steps have been taken and are in force to assure that production units of the same product will continue comply with the requirements.

EMC Directive 2004/108/EC as attested by conformity with the following harmonized standards:

- EN55022:1998 + A1:2000 + A2:2003, AS/NZS CISPR22:2002, Class B
- EN55024:1998 + A1:2001 + A2:2003
- EN55013:2001 + A1:2003
- EN55020:2002 + A1:2003
- EN61000-3-2:2000 +A2:2005, Class D
- EN61000-3-3:1995 + A1:2001

Low Voltage Directive 2006/95/EC as attested by conformity with the following harmonized standard:

- EN60065:2002

RoHS Directive 2002/95/EC on the Restriction of the Use of certain Hazardous Substances in Electrical and Electronic Equipment

Easy Lai

Easy Lai / Director
Computer (Shanghai) Limited

Lutz Schoppe

Lutz Schoppe/DirectorAcer
Acer Europe AG

First things first

We would like to thank you for making this Acer LCD TV your choice. With proper care, your new Acer LCD TV will provide you with years of entertainment and satisfaction.

This User's Guide introduces you to the various features your LCD TV can offer, and provides clear and concise information about the product, so please read it thoroughly and retain it for future reference.

Packing checklist

Your LCD TV package should contain the following accessories, in addition to the accessory box. Please ensure that they are all present. If any of the items is missing, then please contact your retailer.

- Remote control (x1) / AAA batteries (x2)
- Power cord (x1)
- User's Guide / Quick Guide



* The power cord supplied varies according to your region.

Your LCD TV overview

Front panel view

1	Power On/Off
2	Menu key
3	Channel up/down
4	Volume +/-
5	Input key

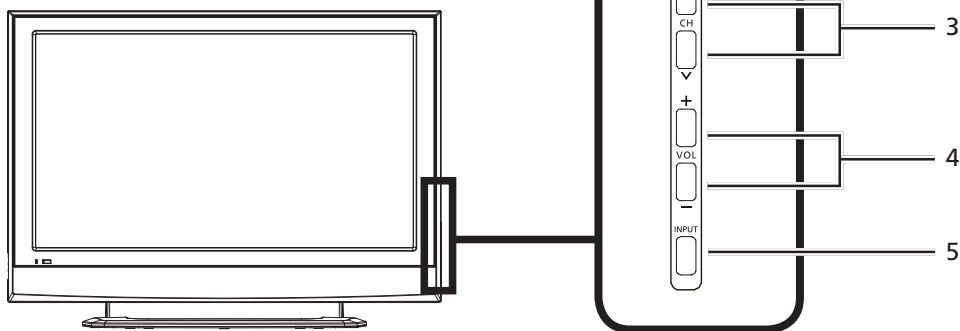

2	MENU	Menu key	Turns the OSD menu ON and OFF
3	CH ^	Channel up	When the OSD is on, functions the same as the Up arrow
	CH v	Channel down	When the OSD is on, functions the same as the Down arrow
4	VOL+	Volume up	When the OSD is on, functions the same as the Right arrow
	VOL-	Volume down	When the OSD is on, functions the same as the Left arrow
5	INPUT	Input key	When the OSD is on, press this button to confirm selection

Rear panel view

1	AC-in	2	HDMI
3	VGA-in	4	Earphone
5	PC Audio-in	6	AV-Audio L/R + CVBS + COMPONENT*
7	SCART	8	Tuner**

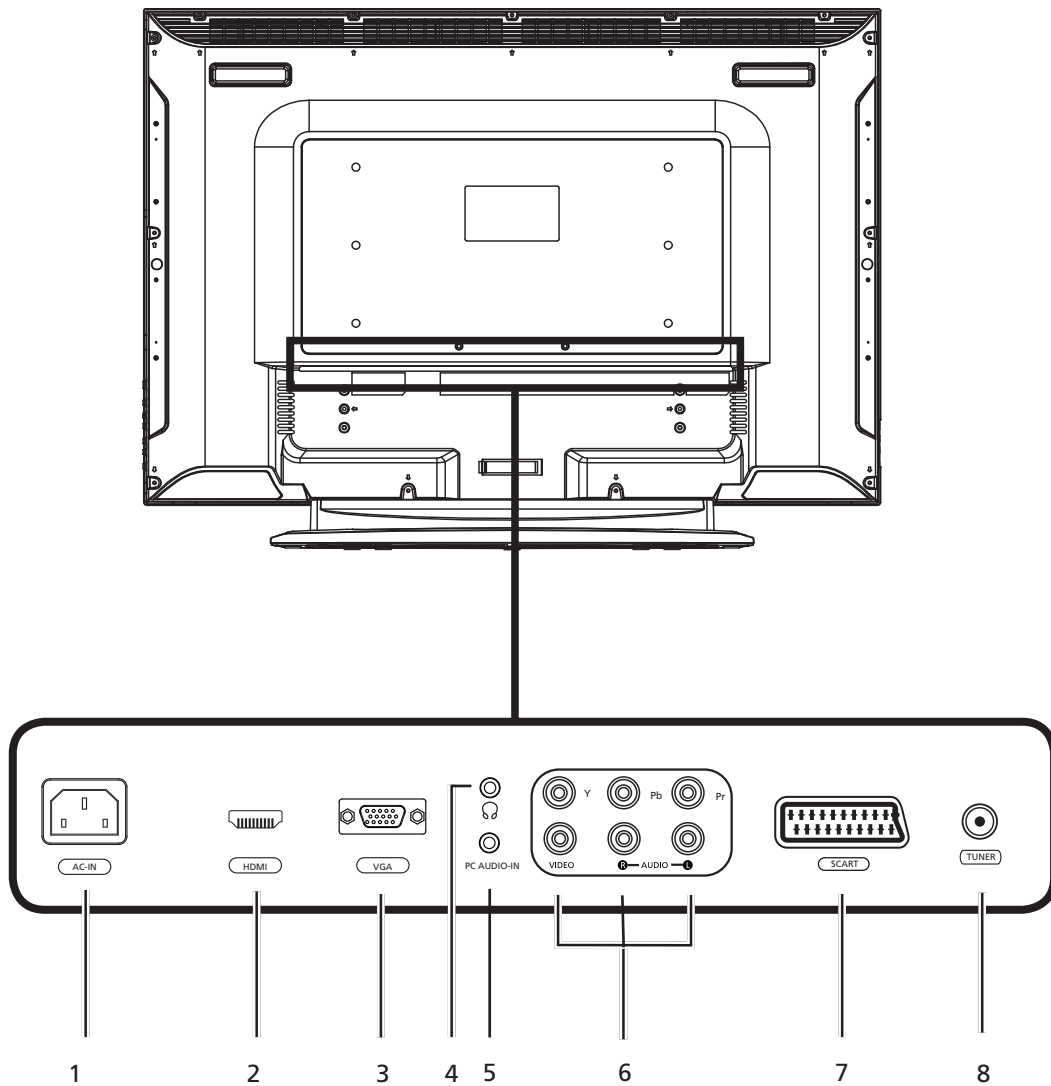

* For AV: Composite and component inputs share the same audio ports.

** Tuner could support analog, digital and mixed signal.

Remote control

General keys

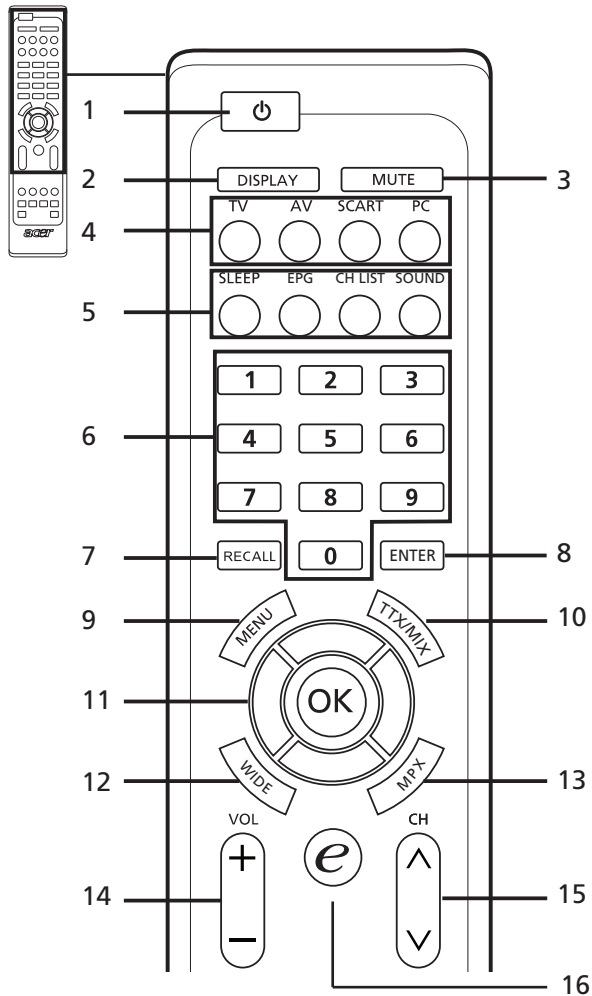

- 1 POWER**
Press to turn your TV on/off.
- 2 DISPLAY**
Press once to display input/channel information (dependent on input/source type).
- 3 MUTE**
Press to toggle audio on and off.
- 4 Input buttons (TV/AV/SCART/PC)**
Press to select correct input mode.
- 5-1 SLEEP**
Press to set a time period after which the TV will switch itself to standby (15, 30, 45, 60, 90 or 120 minutes).
- 5-2 EPG**
Press to launch Electronic Programme Guide (EPG) mode (Digital TV mode only). See page 19.
- 5-3 CH LIST**
Press to launch the channel list. See page 18.
- 5-4 SOUND**
Press to turn audio mode to Surround mode.
- 6 Number keys.**
- 7 RECALL**
Press to return to the previous channel.
- 8 ENTER**
Press to confirm channel number selection.
- 9 MENU**
Press to open or close the Menu.
- 10 TTX/MIX (TELETEXT/MIX)**
Press to switch from TV/AV to Teletext mode.
Press to overlay teletext page on the TV image.
- 11 Directional keys/OK**
VOL (up/down), CH (up/down)
- 12 WIDE**
Press to toggle scaling mode between Wide detect, 4:3, 16:9, Panorama and Letterbox 1, 2, 3 modes.
- 13 MPX**
Press to select the sound input, displayed in the top right-hand corner (mono, stereo, bilingual).
- 14 VOL (+/-)**
Press to increase or decrease the volume.
- 15 CH (up/down)**
Press to sequentially select the TV channel.
- 16 e (Empowering Technology)**
Press to activate Acer Empowering Technology. See page 12.

Teletext

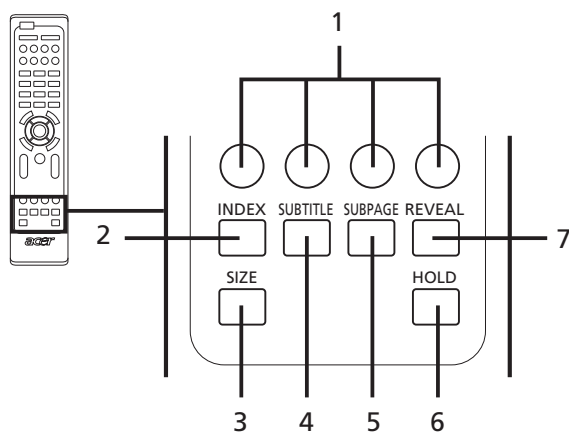

- 1 Colour buttons (R/G/Y/B)**
Operates corresponding button on the teletext page.
- 2 INDEX**
Press to go to the index page
- 3 SIZE**
Press once to zoom teletext page to 2X.
Press again to resume.
- 4 SUBTITLE**
Press to view subtitles on the screen.
- 5 SUBPAGE**
Press to access the teletext's subpages directly.
- 6 HOLD**
Press to pause the current teletext page in multi-page viewing mode.
- 7 REVEAL**
Press to reveal hidden teletext information.

Basic connections

Connecting the power cord

- 1 Connect the AC cord into the AC input on the back of the set.
- 2 Connect the plug to the wall outlet as shown.

Setting up the remote control

- 1 Open the cover on the back of the remote unit.
- 2 Insert two AAA batteries (supplied) to match the polarity indicated inside the battery compartment.

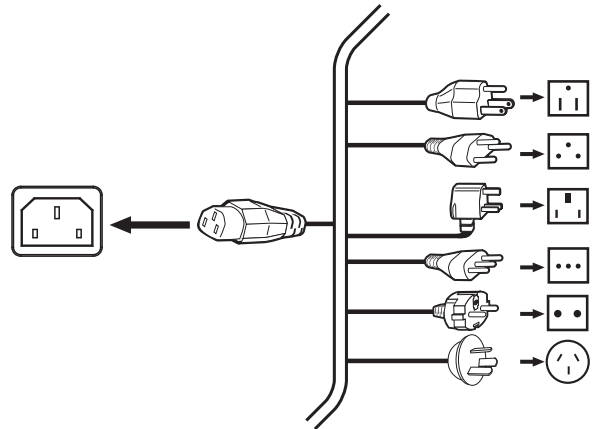

Enjoying analog and digital TV

Connecting an antenna/cable

Connect the antenna cable to the appropriate antenna terminal on the back of the TV set as shown below.

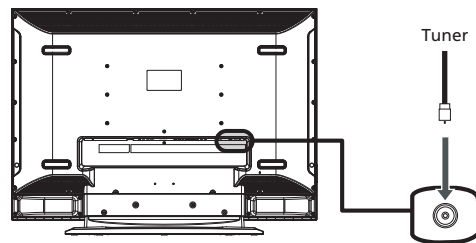

Getting started watching your TV

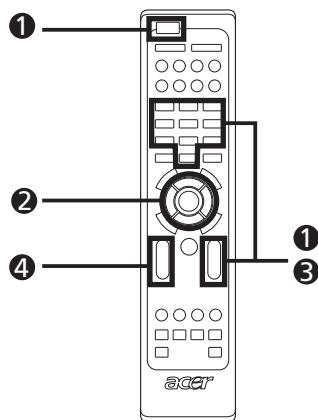
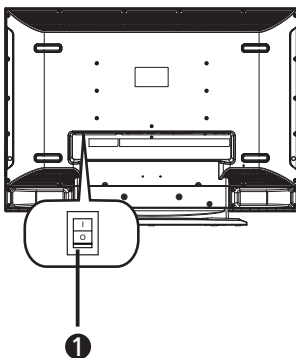

1 Power

- a. Turn on the power switch beneath the screen.
- b. Press the power button, number keys or channel up / down button on the remote control.

2 Setup Wizard

The first time you switch on the TV, the Setup Wizard will guide you to complete the language selection and channel scanning.

Press the OK key to begin the setup process.



You can also adjust these settings using the front control panel. Please see "Front panel view" on page 4 for details.

- Step 1. Select the setup language you prefer.
- Step 2. Please select country.

- Step 3. Enter the correct time zone using the remote control.
- Step 4. Enable or disable daylight saving time.
- Step 5. Ensure that your co-axial cables are connected correctly before proceeding.
- Step 6. Scan for digital channels and analog channels.
- Step 7. Setup is now complete. You are ready to begin watching TV.



If you leave the setup process before it is complete, you will be given a choice of options:

1. Resume setup
2. Resume setup wizard at next startup
3. Exit and do not remind me

Select an option and press OK to exit.

3 Changing channels

- a. Press 0 - 9 on the remote control to select a channel. The channel changes after 2 seconds. Press ENTER to select the channel immediately.
- b. Pressing the channel (CH) up / down button on the remote control will also change the channel.

4 Adjusting the volume

Adjust the volume level using the (VOL) up/down button on the remote control.



Setup may vary due to local broadcast differences.

Connecting external audio/video devices

Connecting a DVD, VCR, STB or audio/video equipment

Connect your DVD player, VCR or audio/video equipment using the SCART port located at the rear of your LCD TV as shown below.

Source-IN

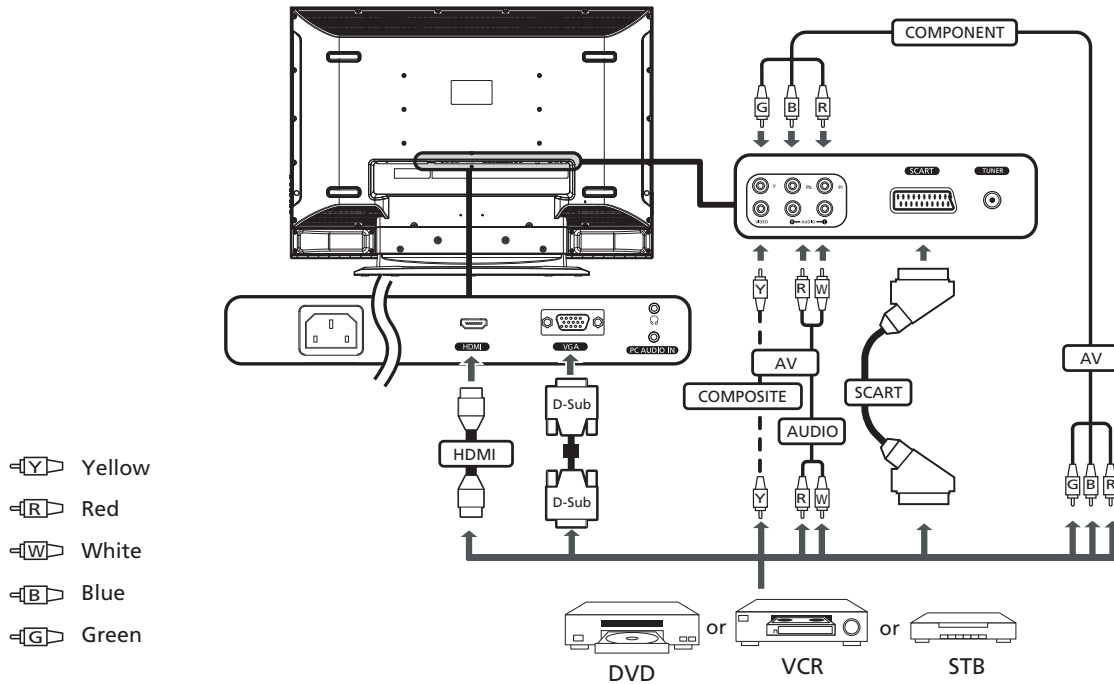

* Acer recommends the following priority for connection types:
HDMI -> COMPONENT -> SCART -> Composite.

** For AV, Composite and component inputs share the same audio ports.

TV-OUT

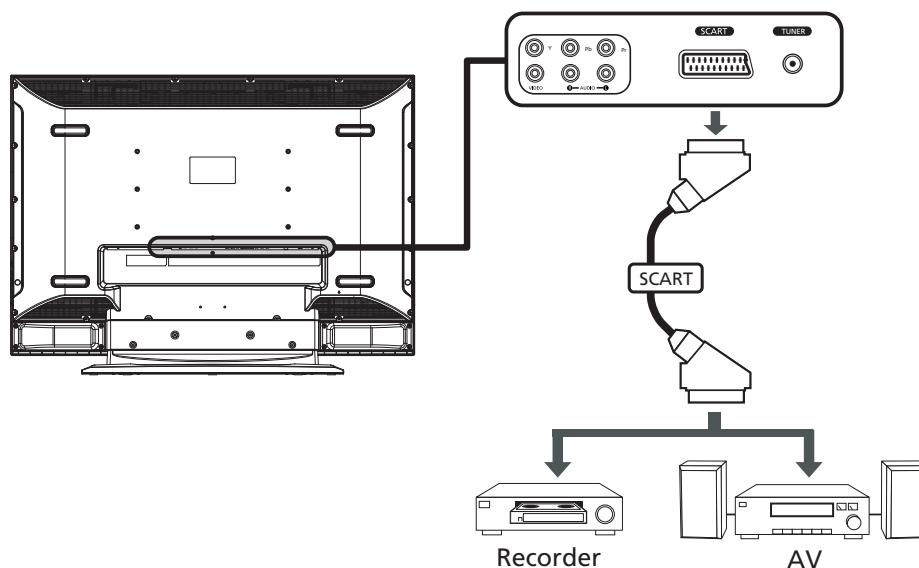

*SCART-out only works with analog broadcasts.

Connecting a camera, camcorder or video game

Connect your camera or camcorder to the video/audio ports on the left of the TV set as shown below.

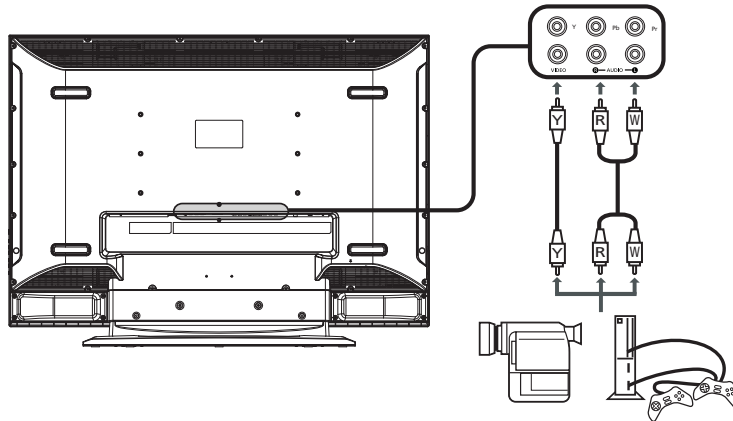

Connecting a PC or notebook computer

To display PC output on your TV, connect your PC or notebook computer to the TV as shown below.

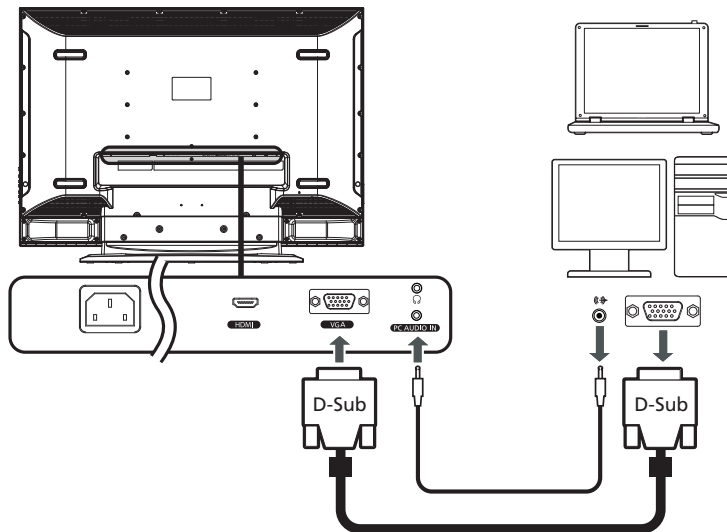

For VGA input, Acer recommends setting your PC's external monitor resolution to 1440 x 900 pixels @ 60 Hz refresh rate.

Selecting the input source

Once you have connected your antenna or external equipment to the TV, you need to select the correct input source.

Press the corresponding button on the remote control to select the correct input source.

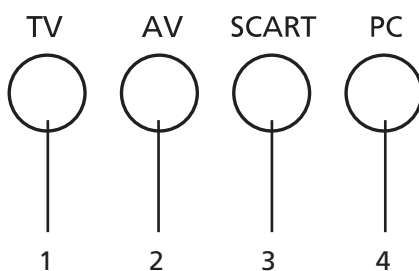

Input button guide:

- 1 **TV key**
Toggle TV (Analog TV and Digital TV) between input sources.
- 2 **AV key**
Toggle Composite, Component, HDMI1 and HDMI2 between input sources.
- 3 **SCART key**
Toggle SCART1 and SCART2 between input sources.
- 4 **PC key**
Toggle VGA between input sources.

OSD navigation

Many of the advanced settings and adjustments are available through using the OSD (onscreen display) menus, as shown in the example screenshot below.

Basic operations required to navigate these menus (Picture, Audio, Channel management, Settings and Parental control) are described in this section.

Navigating the OSD with the remote control

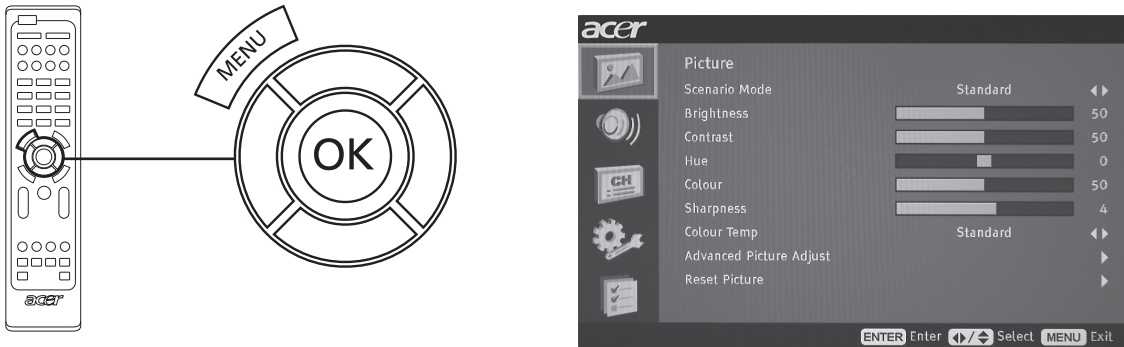





You can also interact with these menus using the right panel controls. Please see "Front panel view" on page 4 for details.

There are five main OSD menus. These are: Picture, Audio, Channel management, Settings and Parental control. Use the following method to navigate these menus.		
1		Press the MENU button on the remote control or the MENU button on the control panel.
2		Select your desired menu by using the up and down directional keys to switch between the five menus.
3		Use the directional keys to interact with the menu. The up / down directions will scroll through the menu options, while left/right will adjust the different settings (for example, in the Picture menu, settings such as brightness, contrast, etc.). Press MENU to exit.

Adjusting the OSD settings

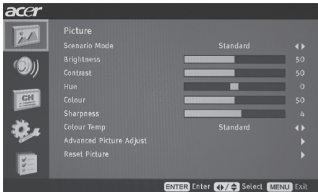
The OSD can be used for adjusting the settings of your LCD TV.

Press the **MENU** key to open the OSD. You can use the OSD to adjust the picture quality, audio settings, channel settings and general settings. For advanced settings, please refer to following page:

Adjusting the picture quality	
	<ol style="list-style-type: none"> 1 Press the MENU key to bring up the OSD. 2 Using the directional keys, select Picture from the OSD. Then navigate to the picture element you wish to adjust. 3 Use the left or right keys to adjust the sliding scales. 4 The Picture menu can be used to adjust the current Scenario mode, brightness, contrast, colour, sharpness and other image-related qualities.
Adjusting the audio settings	
	<ol style="list-style-type: none"> 1 Press the MENU key to bring up the OSD. 2 Using the directional keys, select Audio from the onscreen display. Then navigate to the feature you wish to adjust. 3 Use the left or right keys to adjust the sliding scale. Press OK to save. 4 The Audio menu can also be used to adjust the the current Scenario mode, treble, Bass, balance, Sound Surround and other important sound-related settings.
Adjusting the channel management	
	<ol style="list-style-type: none"> 1 Press the MENU key to bring up the OSD. 2 Using the directional keys, select Channel management from the OSD. 3 Use the directional keys to navigate the menus. 4 The Channel management menu can be used to adjust Country, Daylight Saving, Time Zone, Auto Scan and other important channel-related settings.
Adjusting the settings	
	<ol style="list-style-type: none"> 1 Press the MENU key to bring up the OSD. 2 Using the directional keys, select Settings from the OSD. Then navigate to the feature you wish to adjust. 3 The Settings menu can be used to adjust the screen wide mode, menu language and other important settings.
Adjusting the parental control	
	<ol style="list-style-type: none"> 1 Press the MENU key to bring up the OSD. 2 Using the directional keys, select Parental Control from the OSD. 3 Use the directional keys to navigate the menus. 4 The Parental Control menu can be used to set the password and effectively stop anyone without the password from watching TV.



The options available on the OSD may vary depending on the TV signal source. Some digital options may not be available with an analog signal and vice versa.

Empowering Technology

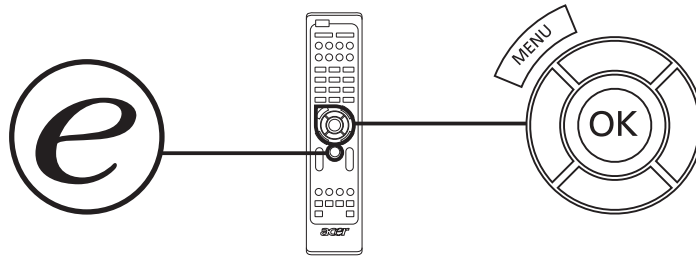

The Empowering Key opens up the Acer Empowering Technology functions.

Empowering Technology has choice is between Scenario mode and Favourite channel.

Set-up Empowering mode

To change your Empowering Key's default setting:

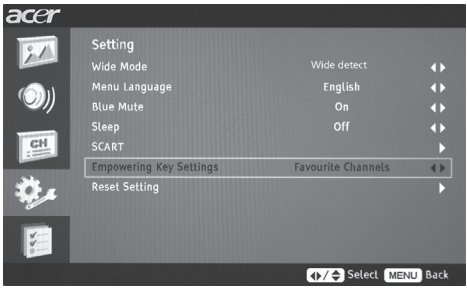
Set-up Empowering mode		
1		Press the MENU key on the remote control to bring up the OSD.
2		Use the directional keys to navigate and select Settings .
3		 <p>Highlight Empowering key settings. Then, select the setting you wish to use and press OK to confirm.</p>
4		Press MENU to exit.

Default setting in different Empowering mode

Scenario mode in TV (default setting)





Scenario mode has five preset viewing modes designed to give you the best picture quality when watching a particular kind of programme. There are five pre-defined audio and video settings for optimal enjoyment of the following scenarios: Standard TV, Movie, Game, Sports, Concert, User.

	Pressing the Empowering Key will toggle between the different modes.
Mode	Information
Standard	Standard mode allows you to watch your favourite channels with sharp, brilliant imagery via adaptive brightness and contrast adjustments, and listen to clear-sounding audio.
Movie	For comfortably enjoying movies at home, Movie mode displays dim scenes in clear detail; compensates for colour; and smoothly presents motion images. This is accomplished through optimal Gamma correction plus saturation, brightness and contrast adjustments. Movie mode makes the most of high-definition movie soundtracks.
Game	Game mode carefully details the exquisite graphics of modern video games, providing lifelike entertainment while protecting your eyesight by adjusting brightness and contrast. What's more, Game mode provides a heightened audio experience.
Sports	Sports mode is suited for outdoor sports programmes, with accurate background depth and clear gradation between the bright, outdoor playing field and darker auditoriums. Sports mode also brilliantly enhances colours and presents swiftly moving pictures without residual images. All of this is achieved via specific Gamma corrections and saturation adjustments. Precise audio can be heard.
Concert	Concert mode places you in a virtual concert hall, opera house or other dim environment by means of adaptive brightness and contrast adjustments. Concert mode accentuates symphonic harmonies and the tenor audio range.

Favourite channel mode in TV

Favourite channel allows you to store five of your favourite TV channels and flick between them at the touch of a single button.

To set Favourite channel as the default, follow the steps described on this page.

Storing favourite channels	
1	<div style="text-align: center;">CH LIST </div> <p>Press the CH LIST key on the remote control. This will bring up the channel list menu.</p>
2	<div style="text-align: center;">  </div> <p>The current channel will be highlighted and press the Empowering Key to storing favourite channel.</p>
3	<div style="text-align: center;">CH LIST </div> <p>Press the CH LIST key on the remote control to exit.</p>
Viewing your favourite channels	
	<div style="text-align: center;"></div> <p>On the remote control, if you press the Empowering Key, the TV will toggle between the five stored TV channels sequentially according to your list of favourites.</p>

Advanced features

Parental Control

Locking TV content

Parental control is a handy feature that can block all TV sources.

Parental control allows you to enter a password and effectively stop anyone without the password from watching TV.

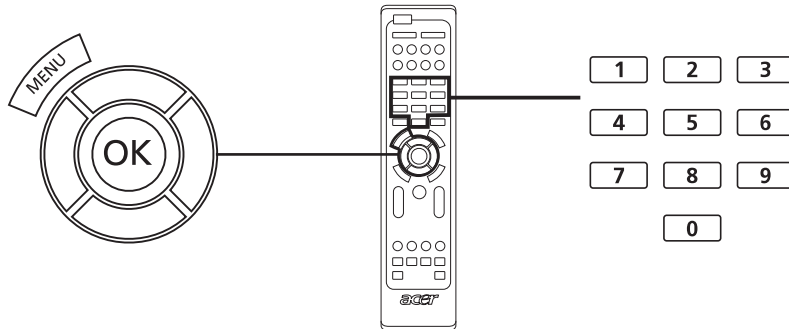



To enable this feature:

Setting a password		
1		<p>Press the MENU key on the remote control to bring up the OSD.</p>
2		Use the directional keys to navigate to the Parental Control menu. Then select Password . (see note)
3		Enter a four-digit password. Type it again and press OK to reconfirm.
4		Press MENU to exit.



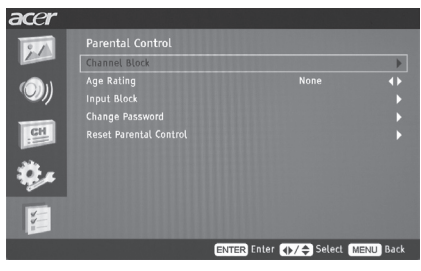

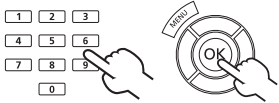

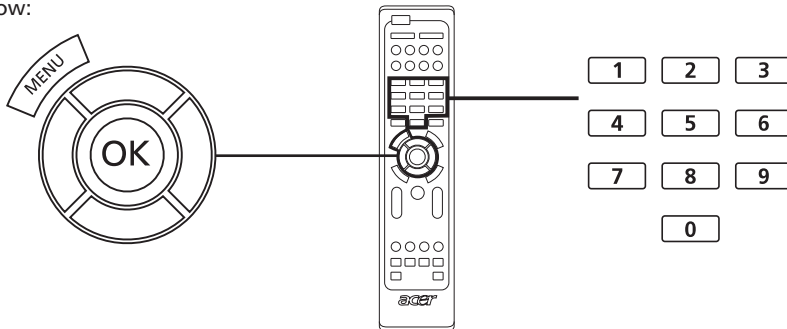

The default PIN for this TV is "0000." First enter "0000" when you want to change the PIN. If you forget your PIN, please enter 6163 to reset.

Locking your TV		
1		 <p>Press the MENU key on the remote control to bring up the OSD.</p>
2		Use the directional keys to navigate to the  Parental Control menu. Then select Password .
3		Enter your Password. Then, select Channel block , Age Rating or Input block for further settings. (see page 14 note)

Reorder for channels

The first time you completed the setup wizard, all available channels were listed. If you need to reorder for new channels, please follow the steps below:

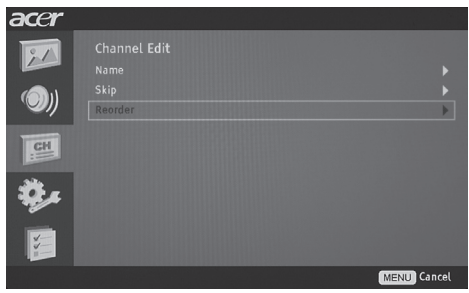

Reordering for channels		
1		Press the MENU key on the remote control to bring up the OSD.
2		Use the directional keys to navigate and select  Channel Management . Then select Channel Edit .
3		 <p>Highlight Reorder. Then, select the channel you wish to reorder and press OK to confirm. Move to the right channel number and press OK to reconfirm.</p>
4		Press MENU to exit.

Re-scan for channels

The first time you completed the setup wizard, all available channels were listed. If you need to re-scan for new channels, please follow the steps below:

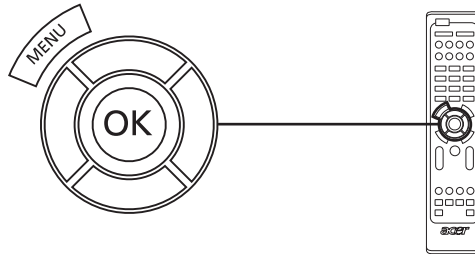

Scanning for channels		
1		Press the MENU key on the remote control to bring up the OSD.
2		Use the directional keys to navigate and select Channel Management.
3		Highlight Auto Scan . Then, select Start and press OK to begin.
4		
6		Press MENU to exit.

TV ratings (for digital TV mode)

Most digital TV allows you to block content according to rating systems. The rating system available is dependent on region.

DVB ratings

The DVB system rates content by age. The categories are increase by increments of one year from 4 to 18 years of age.

The categories are as follows:

Rating	Description
4 years	4 years and under
5 years	5 years and under
⋮	⋮
17 years	17 years and under
18 years	18 years and under

Like other rating systems, when you lock a category, all the more restricted categories will automatically be blocked.

Setting or changing the ratings

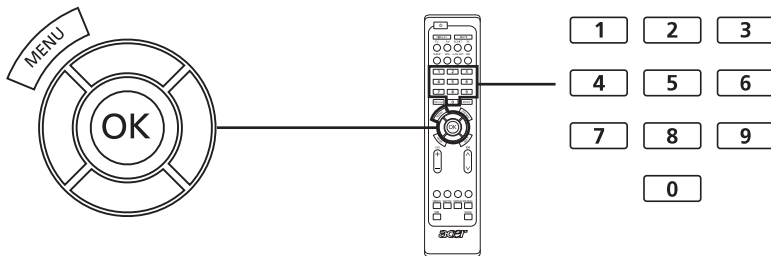

To set or change your TV ratings settings:		
1		Navigate to the channel you wish to manage and make sure that the channel is unlocked.
2		Press MENU then select Channel management from the OSD.
3		Navigate down to TV rating system and then select the categories you wish to block.
4		You will need to enter your PIN before you make any adjustments to the settings. Press OK to set the age-rating yourself using the directional keys . Press OK to confirm your settings.
5		Press MENU to exit.



The default PIN for this TV is "0000." First enter "0000" when you want to change the PIN. If you forget your PIN, please enter 6163 to reset.

Channel list (for digital TV mode)

Channel list allows you to quickly find the TV channel you are searching for.

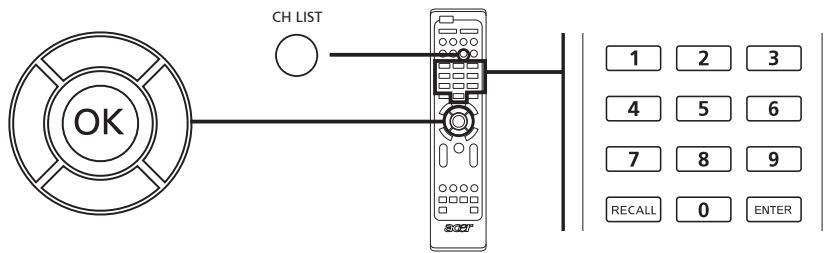

To open the channel list feature:		
1		Press the CH LIST key on the remote control. This will bring up the channel list menu.
2		The current channel will be highlighted and press OK to view detail of programme information.
3		Use the directional keys to navigate the list and select the channel you wish to watch. Press OK to select your desired channel and exit the channel list.

Electronic programme guide (for digital TV mode)

The electronic programme guide (EPG) is an onscreen service available on digital and cable TV that provides information about scheduled broadcast programmes on all channels by time, title, channel and genre.

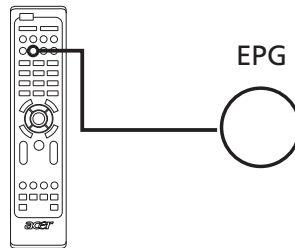

EPG screen

There are four main areas of the EPG screen:

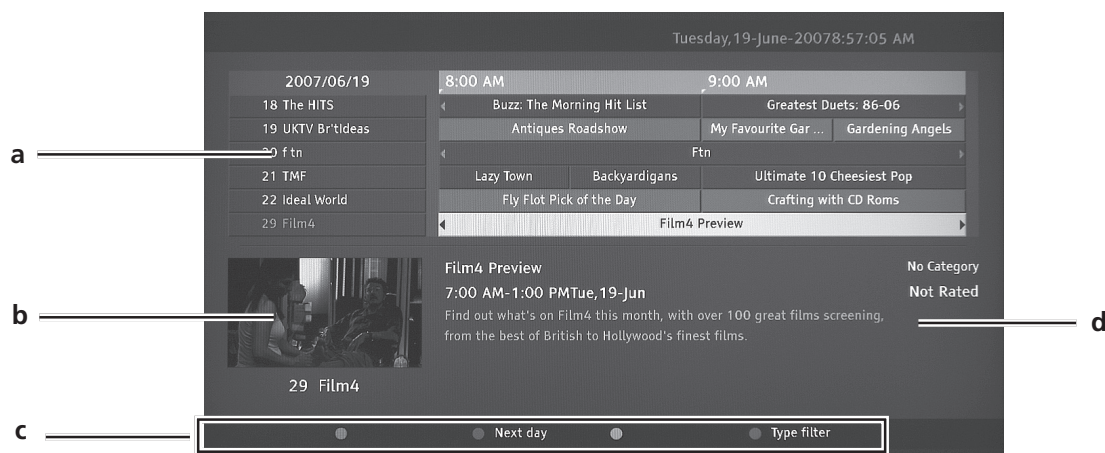

a. Content area

The content area is divided into three columns: date, channel and programme.

Use the directional keys and the OK key to navigate between the items in the content area.

Highlight a new programme and press **OK** or the blue key to display the programme in the preview and introduction areas.

b. Preview area

In the top right-hand corner of the EPG screen is the preview area. The preview area will show live TV content from the channel currently highlighted.

Highlight a new channel or programme and press **OK** to display it in the preview area.

c. Indication

This area of the EPG indicates which shortcut keys can be used while on an EPG screen.

d. Programme introduction area

A short description of the highlighted programme is located at the top center of the EPG page; lengthy descriptions will be cut short using "..." to indicate extra text.

Highlight the introduction and press **OK** to view the whole introduction section on a separate page.

Navigating the EPG (for Digital TV mode)

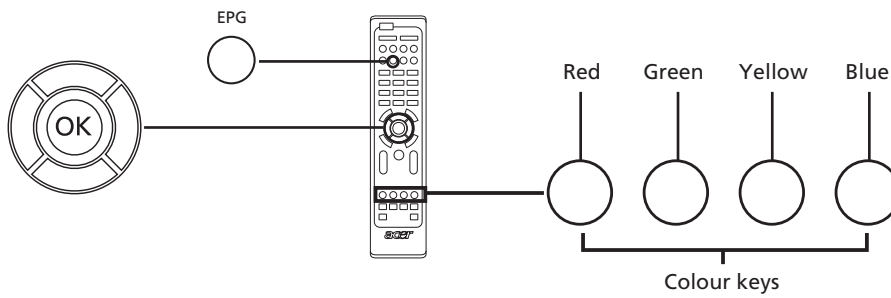

1		Press the EPG key on the remote control.
2		Use the directional keys to navigate around the EPG menu and press OK to select your highlighted option.

short-cuts	EPG features
Red	Press the red key to view the previous day's list of channels.
Green	Press the green key to view the next day's list of channels.
Yellow	Press the yellow key to view details of the selected item.
Blue	Press the blue key to go to the Type filter page. The Type filter feature can help you to select a certain category of programmes that you may wish to watch.

Audio effects

Your Acer LCD TV is equipped with high-quality sound specifications to ensure that you enjoy the best audio experience possible.

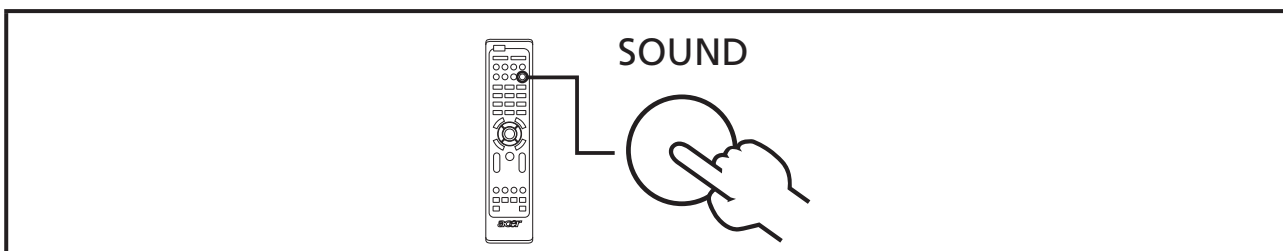

Widescreen display mode

Your Acer LCD TV has a special widescreen mode that allows you to toggle between Wide detect, 4:3, 16:9, Panorama, and Letterbox 1, 2 and 3 type views.

Press the **WIDE** key on the remote control to toggle the display between the four wide modes.

Wide mode

The Acer LCD contains four widescreen modes, including Wide detect, 4:3, 16:9, Panorama, and Letterbox 1, 2 and 3.

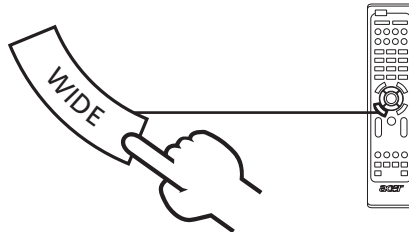

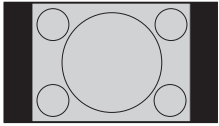
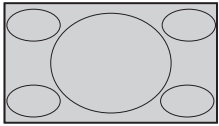
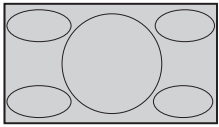
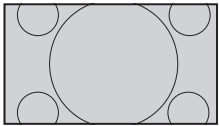
Wide detect	In this mode, TV will auto detect picture source and fit in suitable size.
4:3	For 4:3 standard pictures. A side bar appears on each side.
	
16:9	In this mode, the whole picture is stretched toward each side of the screen.
	
Panorama	In this mode, the picture is progressively stretched toward each side of the screen.
	
Letterbox 1, 2, and 3	In this mode, the picture is enlarged linearly to fit the screen. The top and bottom portions of the picture may be cut off.
	

Troubleshooting

Before you call the Acer service center, please check the following items:

Here is a list of possible situations that may arise during the use of your LCD TV. Easy answers and solutions are provided for each.

There is no picture or sound.

- Make sure the power cord is properly inserted in the power outlet.
- Make sure the input mode is correctly set by your selected input.
- Make sure the antenna at the rear of the TV is properly connected.
- Make sure the main power switch is turned on.
- Make sure the volume is not set to minimum or the sound is not set to mute.
- Make sure the headphones are not connected.
- Reception other than those of broadcasting stations can be considered.

Picture is not clear.

- Make sure the antenna cable is properly connected.
- Consider whether your TV signal is being properly received.
- Poor picture quality can occur due to a VHS camera, camcorder, or other peripheral being connected at the same time. Switch off one of the other peripherals.
- The 'ghost' or double image may be caused by obstruction to the antenna due to high-rise buildings or hills. Using a highly directional antenna may improve the picture quality.
- The horizontal dotted lines shown on the pictures may be caused by electrical interference, e.g., hair dryer, nearby neon lights, etc. Turn off or remove these.

Picture is too dark, too light or tinted.

- Check the colour adjustment.
- Check the brightness setting.
- Check the sharpness function.
- The fluorescent lamp may have reached the end of its service life.

Remote control does not work.

- Check the batteries of the remote control.
- Make sure the remote sensor window is not under strong fluorescent lighting.
- Try to clean the remote control sensor lens on the TV with a soft cloth.
- Use the buttons (hotkeys) on the TV before the remote control works.

If the above suggestions do not solve your technical issue, please refer to the warranty card for service information.

PC Input Signal Reference Chart

	Resolution	Horizontal Frequency (kHz)	Vertical Frequency (Hz)	Standard	Format
1	640 x 350	31.5	70.0	VGA	
2	720 x 400	31.5	70.1	VGA	
3	640 x 480	31.5	59.9	VGA	
4	640 x 480	35.0	66.7	MAC	
5	640 x 480	37.9	72.8	VESA	
6	640 x 480	37.5	75.0	VESA	
7	640 x 480	43.3	85.0	VESA	
8	800 x 600	35.2	56.3	VESA	
9	800 x 600	37.9	60.3	VESA	
10	800 x 600	48.1	72.2	VESA	
11	800 x 600	46.9	75.0	VESA	
12	800 x 600	53.7	85.1	VESA	
13	832 x 624	49.7	74.6	MAC	
14	1024 x 768	48.4	60.0	VESA	
15	1024 x 768	56.5	70.1	VESA	
16	1024 x 768	60.0	75.0	VESA	
17	1280 x 768	47.8	59.9	VESA	
18	1280 x 768	60.3	74.9	VESA	
19	1280 x 720	45.0	59.9	VESA	16:9
20	1280 x 1024	64.0	60.0	VESA	
21	1440 x 900	55.9	59.9	VESA	16:9
22	1440 x 900	70.6	75.0	VESA	16:9



-
- 1). The PC input does not support Sync on Green or Composite Sync.
 - 2). The PC input does not support interlaced signals.

Product specifications

Model	AT1935
Panel spec	
Resolution (pixels)	1440 x 900
Brightness (tpe.)	300 nit
Contrast Ratio (tpe.)	800 : 1
Display colour	16.7 M
Viewing angle (tpe.)	H: 160° ; V:160°
Response (tpe.)	5 ms (Gray to Gray)
Power supply	
Input	90 ~ 264 V , 47 ~ 63 Hz
Max. power consumption	60 W
Power saving	<1 W
Mechanical	
Dimensions (W x H x D mm)	490.5 x 412.2 x 138.9
Weight (kg)	5
Weight (lbs.)	11.0
Gross weight (Kg)	6.5
Gross weight (lbs)	14.3
Wall-mounting holes	100mm x 100mm
Analog TV system	
Colour system	PAL, SECAM
Sound system	B/G/D/K/I/L (multi-European)
Stereo system	NICAM/A2
Subtitle	Teletext 1.5 (1000 pages)
Digital TV system	
Digital TV standard	DVB-T
Sound system	ISO11172-3 layer1 & layer2 32KHz,44.1KHz,48KHz
Stereo system	MPEG (Layer I & II) Stereo 32 / 44.1 / 48KHz
Frequency	7/8 MHz
Terminal	
Analog/Digital Tuner In	Yes
SCART	SCART for CVBS(In/Out), RGB(In), Audio R/L, FB, S Video
AV-in	YPbPr/YCbCr,CVBS, Audio R/L
HDMI	Yes (HDMI 1.1)
PC D-sub in	Yes
PC audio-in	Yes
Resolution	
HDMI	480i/p, 576i/p, 720p, 1080i
Audio system	
Speakers	5W + 5 W

Free Manuals Download Website

<http://myh66.com>

<http://usermanuals.us>

<http://www.somanuals.com>

<http://www.4manuals.cc>

<http://www.manual-lib.com>

<http://www.404manual.com>

<http://www.luxmanual.com>

<http://aubethermostatmanual.com>

Golf course search by state

<http://golfingnear.com>

Email search by domain

<http://emailbydomain.com>

Auto manuals search

<http://auto.somanuals.com>

TV manuals search

<http://tv.somanuals.com>