

Acer LCD TV AT2001 User's Guide

Copyright © 2005. Acer Incorporated.
All Rights Reserved.

Acer AT2001 User' s Guide
Original Issue: May 2005

Acer and the Acer logo are registered trademarks of Acer Incorporated. Other companies' product names or trademarks are used herein for identification purposes only and belong to their respective companies

Contents

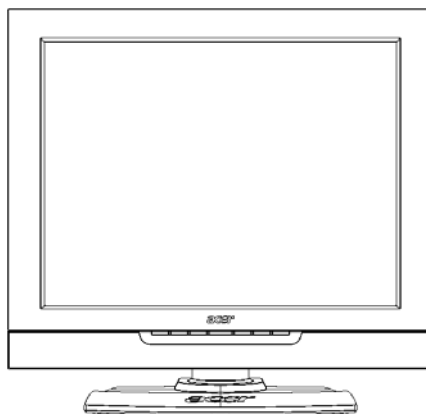

Important safety instructions.....	5
Taking care of your remote control.....	6
Cleaning and servicing.....	6
Declaration of Environmental Protection Conformity.....	6
1 BEFORE YOU START	7
1-1 What's in the Box	7
2 YOUR LCD TV AT A GLANCE.....	8
2-1 Control Panel	8
2-2 Left-side Connectors.....	9
2-3 Back Connectors	10
3 YOUR REMOTE CONTROL AT A GLANCE	11
4 BASIC LCD TV SETUP	13
4-1 Connecting to the Aerial.....	13
4-2 Using the Remote Control (Basic Operation).....	13
4-3 Plugging In Your LCD TV.....	14
4-4 Turning ON the Power	15
4-5 Tuning Channels Automatically (AUTO SETUP).....	16
4-6 Program Sort.....	17
4-7 Naming Channels.....	17
4-8 Tuning Channels Manually (MANUAL TUNING)	18
5 CONNECTING EXTERNAL DEVICES.....	18
5-1 Connecting a YPBPR Device	18
5-2 Connecting a Composite Device	19
5-3 Connecting a S-Video Device	20
5-4 Connecting a VCR Using Coaxial (RF)	21
5-5 Connecting Speakers	22
6 ADJUSTING SETTINGS	23
6-1 Basic Operations	23
6-1-1 ADJUSTING THE VOLUME	23

6-1-2	SELECTING PROGRAMS.....	25
6-2	Using the On-Screen Display (OSD)	26
6-2-1	MAKING ADJUSTMENTS.....	26
6-3	OSD Menus and Options.....	27
6-3-1	With Source Input Set to TV.....	30
7	ADVANCED SETTINGS	31
7-1	Setting the Sleep Timer	31
7-2	Displaying Teletext.....	32
7-2-1	TO TURN ON/OFF TELETEXT MODE	32
	TROUBLESHOOTING AND SUPPORT	32
	PRODUCT SPECIFICATIONS.....	34

Important safety instructions

Read these instructions carefully. Save them for future reference.

- 1 Follow all warnings and instructions marked on the product.
- 2 Unplug this product from the power outlet before cleaning. Use a soft, moist cloth for cleaning. Do not use liquid or aerosol cleaners.
- 3 Do not use this product near water.



- 4 Do not place this product on an unstable cart, stand, or table. The product may fall, causing serious damage to the product.



- 5 Slots and openings are provided for ventilation; to ensure reliable operation of the product and to protect it from overheating. These openings must not be blocked or covered. The openings should never be blocked by placing the product on a bed, sofa, rug, or other similar surface. This product should never be placed near or over a radiator or heat register, or in a built-in installation unless proper ventilation is provided.

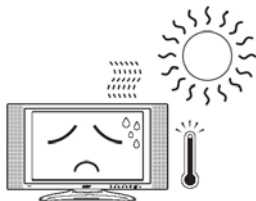

- 6 This product should be operated from the type of power source indicated on the label. If you are unsure of the type of power source available, consult your dealer or local power company before use.
- 7 Do not step on or place heavy objects on the power cord. Carefully route the power cord and any cables away from foot traffic. Do not locate this product where persons will step on the cord.



- 8 If an extension cord is used with this product, make sure that the total ampere rating of the equipment plugged into the extension cord does not exceed the extension cord ampere rating. Also, make sure that the total rating of all products plugged into the wall outlet does not exceed the fuse rating.
- 9 Never push objects of any kind into this product through cabinet slots as they may touch dangerous voltage points or short out parts that could result in a fire or electric shock.
- 10 Do not attempt to service this product yourself, as opening or removing covers may expose you to dangerous voltage points or other risks. Refer all servicing to qualified service personnel.
- 11 Unplug this product from the wall outlet and refer servicing to qualified service personnel under the following conditions:
 - a. When the power cord or plug is damaged or frayed.
 - b. If liquid has been spilled into the product.
 - c. If the product has been exposed to rain or water.
 - d. If the product does not operate normally when the operating instructions are followed. Adjust only those controls that are covered by the operating instructions since improper adjustment of other controls may result in damage and will often require extensive work by a qualified technician to restore the product to normal condition.
 - e. If the product has been dropped or the case has been damaged.
 - f. If the product exhibits a distinct change in performance, indicating a need for service.
- 12 Only use the correct power cord (provided in your accessories box) for this product. Always disconnect the power cord from the wall outlet before servicing or disassembling this equipment.

Taking care of your remote control

Follow these steps to ensure proper care of your remote control:

- Handle the remote control with care. Dropping it, placing it in direct sunlight, or allowing it to get wet may cause damage.
- Do not tamper with the batteries, and keep them away from children.
- When you anticipate that the remote control will not be used for an extended period, remove the batteries to prevent possible damage from battery leakage.
- Dispose of batteries according to local regulations. Recycle if possible.

Cleaning and servicing







When cleaning your LCD TV, follow these steps:

- 1 Power off the TV.
- 2 Disconnect the power cord.
- 3 Use a soft, moist cloth. Do not use liquid or aerosol cleaners.

1 BEFORE YOU START

1-1 What's in the Box

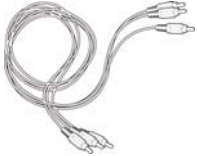
When you receive your LCD TV, unpack it carefully, and check to make sure you have all the items below.

REMOTE CONTROL and ONE L3120 BATTERY	POWER CORD	USER'S MANUAL	WARRANTY
			
TV CABLE	COMPONENT CABLE	COMPOSITE CABLE	S-VIDEO CABLE
			

2 YOUR LCD TV AT A GLANCE

English

2-1 Control Panel

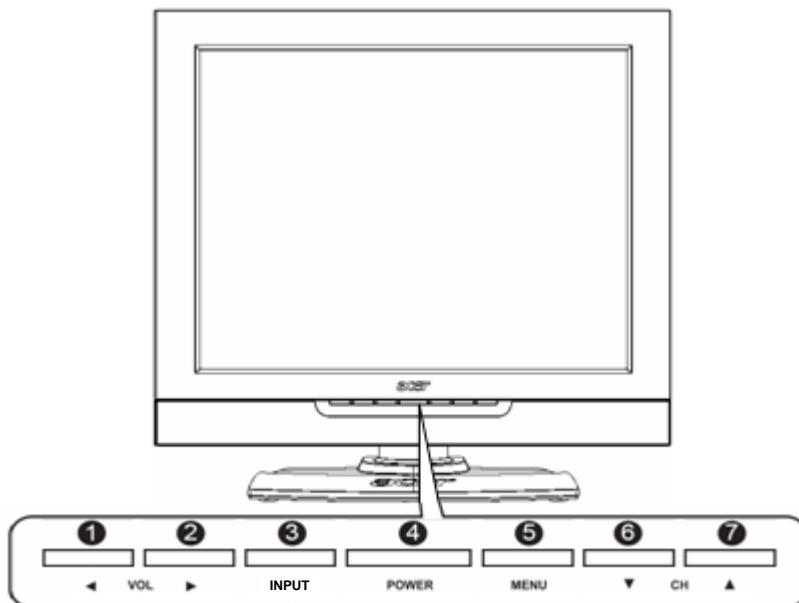

BUTTON	VIEWING FUNCTION (OSD OFF)	MENU FUNCTION (OSD ON)
1	Lowers the sound level.	Reduces a menu option value.
2	Increases the sound level.	Displays a submenu with selections for the current menu option. Increases a menu option value.
3	Selects the input source.	N/A
4	Turns the LCD TV ON/OFF.	N/A
5	Activates the OSD main menu.	Returns to the previous menu or to normal viewing.
6	Displays the previous stored channel.	Selects the previous menu option.
7	Displays the next stored channel.	Selects the next menu option.

2-2 Left-side Connectors

To access these connectors , you will need to open the protective cover.

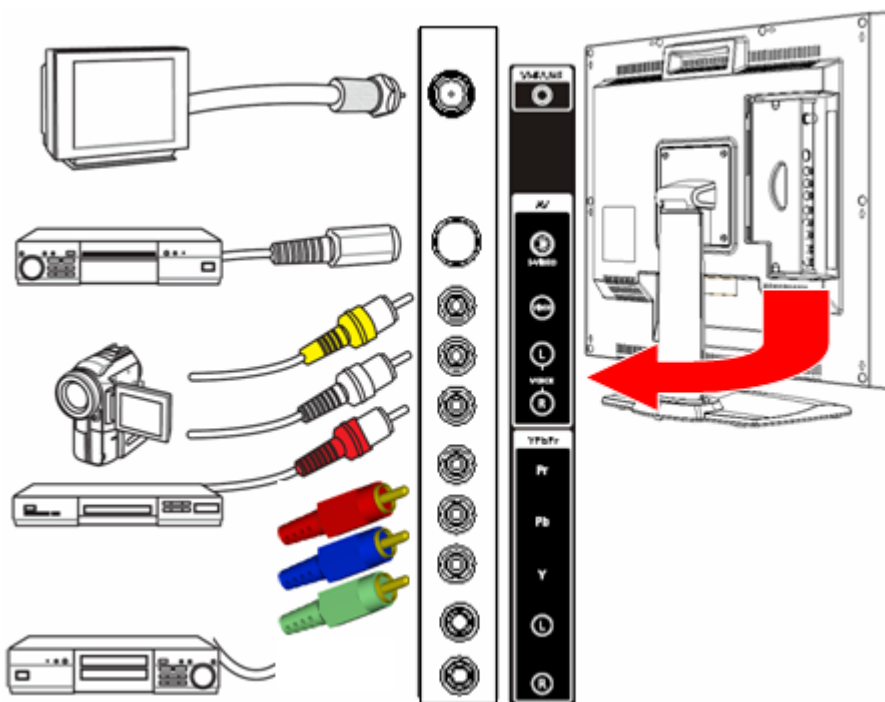

(FOR Red/Blue/Green cable, please use same design as Yellow/White/Red cable, only need to change the cable color)

CONNECTOR	DESCRIPTION
1	TUNER (UHF/VHF-CATV) - Connect to antenna, cable service, or VCR.
2	S-Video - Connect an S-video device, such as a DVD player or VCR, to this connector.
3	Composite - Connect a composite device, such as a DVD player or VCR, to this connector.
4	YPbPr - Connect a video device, such as a DVD player or VCR, to this connector.



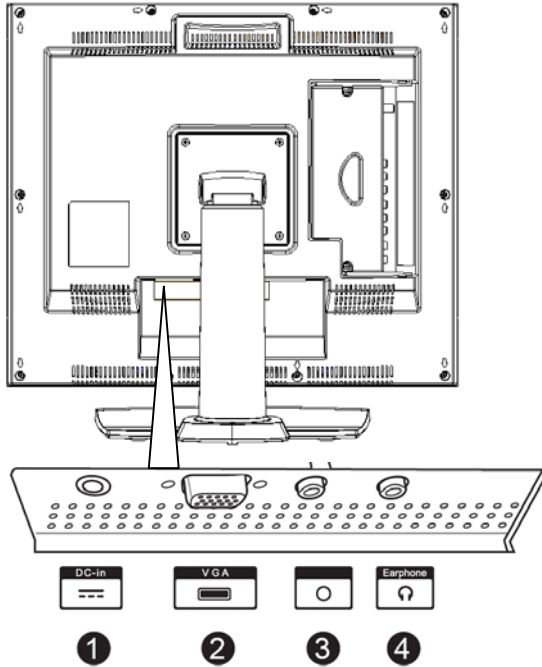

2-3 Back Connectors



CONNECTOR	DESCRIPTION
1	DC-in - Connect the AC power adapter to this.
2	VGA - Connects to a computer's VGA terminal output.
3	Audio-in - Connects to a computer's audio out jack.
4	Audio-out - Connect a headphone, external amplifier, or speakers to this.

3 YOUR REMOTE CONTROL AT A GLANCE



	BUTTON	DESCRIPTION
1	POWER	Turns the selected component ON/OFF.
2	TV	Selects a programmed TV.
3	INPUT	Changes the input source.
4	MPX	Changes the audio output.
5	SLEEP	Turns on the sleep timer.
6	UP/DOWN	Navigates up and down in the on-screen display (OSD) menus.
7	LEFT/RIGHT	Navigates left and right in the on-screen display (OSD) menus.
8	MENU	Displays menus for TV and other options.
9	RECALL	Shows last channel and video source
10	CH  / 	Changes the channel.
11	VOL  / 	Increases/decreases the volume.
12	MUTE	Mutes or restores the sound volume.
13	MTS	Select Multi Sound
14	CC	Turns on close caption function

4 BASIC LCD TV SETUP

4-1 Connecting to the Aerial

Connect the outdoor aerial (antenna) cable lead or your cable TV box to the TUNER (UHF/VHF-CATV) jack on the back of your LCD TV using an RF (coaxial) lead. See *2-2 Left-side Connectors* for location.

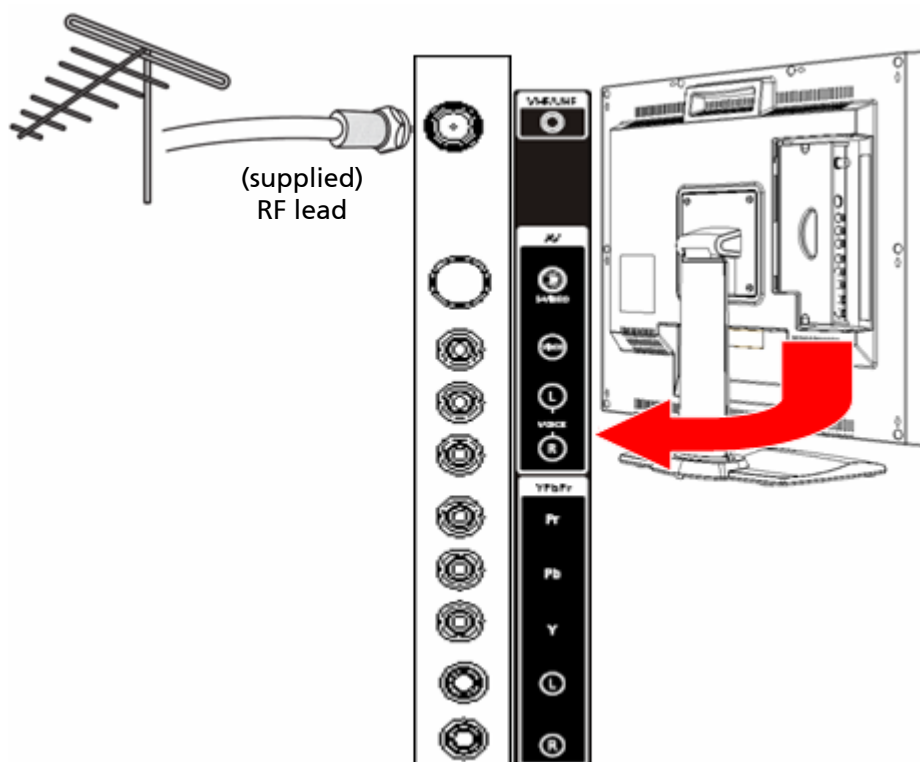

4-2 Using the Remote Control (Basic Operation)

Point the remote control towards the remote control sensor window located on the front of your LCD TV. Make sure no objects are in the line of aim, otherwise the remote control may not operate properly.

4-3 Plugging In Your LCD TV

1. Connect the power cord to the power cord connector on the back of your LCD TV.
2. Plug the other end of the power cord into a properly grounded electrical outlet or surge protector.

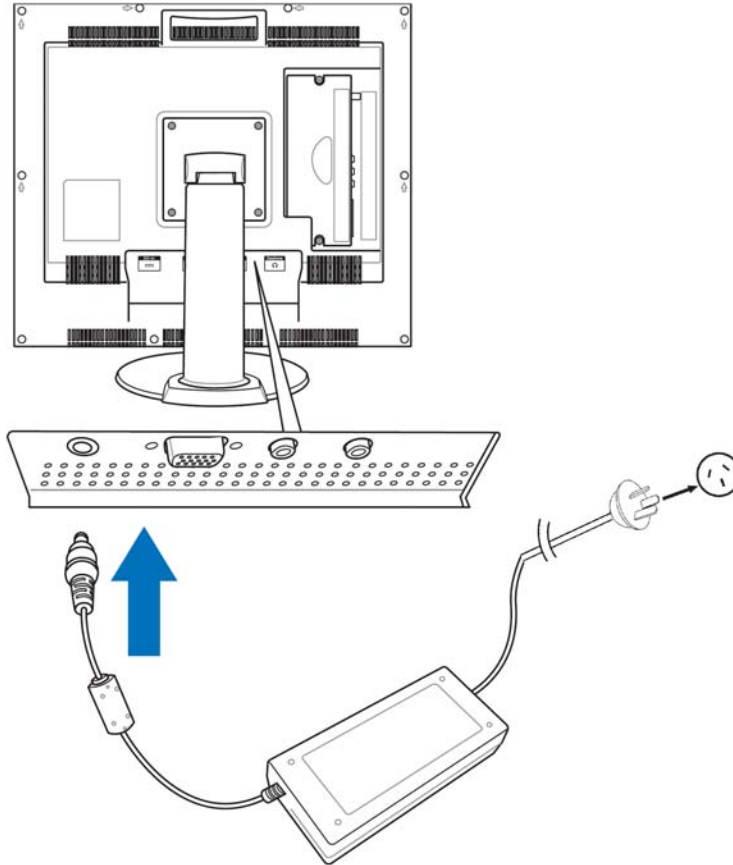

4-4 Turning ON the Power

Press the **Power** button on the top of the LCD TV (see *2-1 Control Panel* for location). The Status LED on the front turns green and your LCD TV turns on.

-OR-

Press the **POWER** button on your remote control. The Status LED on the front turns green, and the unit turns on.



WARNING! For added protection during a lightning storm or when it is left unattended or unused for long periods of time, unplug your LCD TV from the wall outlet and disconnect the aerial or cable system.

4-5 Tuning Channels Automatically (AUTO SETUP)

Use this option to quickly add all channels that have a signal to the channel list.

TO TUNE CHANNELS AUTOMATICALLY

1. Press the **MENU** button on the remote control to open the OSD.
2. Press the **▲/▼** buttons to select **SETUP**.
3. Press **▶** to open the **Setup** menu.
4. Press the **▲/▼** buttons to select **AUTO SETUP**.
5. Press to start auto setup.
The LCD TV will search for all available channels. Please be patient, this will take a few minutes.
6. When the LCD TV has finished searching, the **SORT** menu will appear.

NOTE: Submenus can be accessed by pressing either **◀** or **▶**.

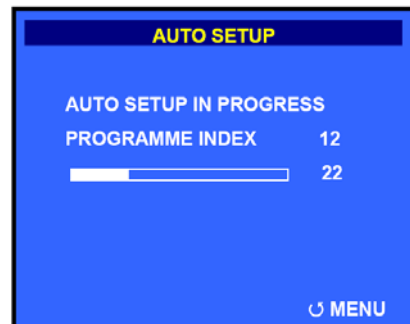
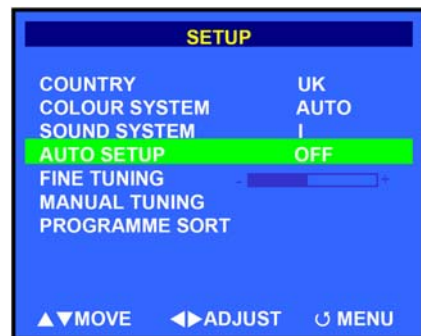

4-6 Naming Channels

Use this option to give a channel a name, e.g. BBC1.

1. Press the **MENU** button on the remote control to open the **Main** menu.
2. Press the / buttons to select **SETUP**.
3. Press to select.
The **Setup** menu opens.
4. Press the / buttons to highlight **PROGRAM SORT**.
5. Press to select.
The **Program Sort** menu opens.
6. Press the / buttons to select the channel that you want to name.
7. Press to move the selection block to the **NAME** column.
8. Enter a name for this channel using the number keypad on the remote control. After the first letter or number is entered, press and enter the next letter or number. A maximum of five letters and/or numbers may be entered.
9. When finished, press **MENU** to return to the previous menu.

Now you will be able to see the channel name that corresponds with the selected channel.

NOTE: Submenus can be accessed by pressing either or .

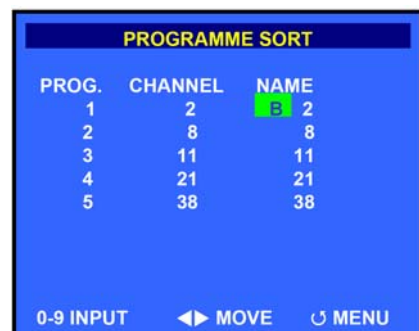
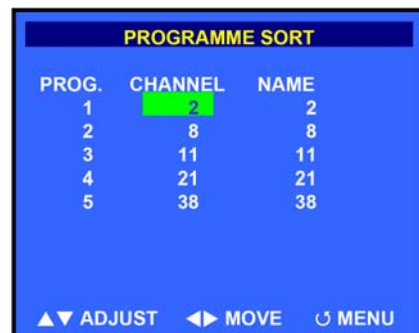

5 CONNECTING EXTERNAL DEVICES

Read this section to learn how to connect the following devices:

- DVD players
- HDTV decoder set-top boxes
- VCRs
- Computers

WARNING! Before connecting any external components, make sure to unplug your LCD TV and any connecting devices to prevent damage.

5-1 Connecting a YPbPr Device

1. Connect one end of a 3-pin YPbPr lead (not supplied) to your YPBPR device and the other to the YPbPr connector on the side of your LCD TV.
2. Turn on your LCD TV (see **4-4 Turning ON the Power**), then press the **INPUT** button repeatedly to select **YPBPR**.

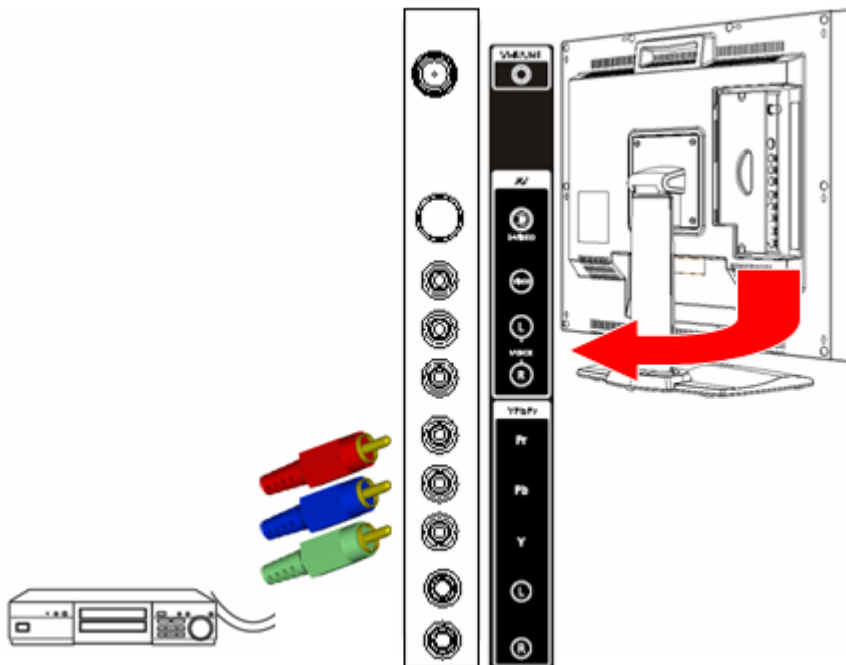

5-2 Connecting a Composite Device

1. Connect the yellow video jack from your composite device to the yellow AV jack on the side of your LCD TV with an RCA cable (not supplied).
2. Connect the red (R) and white (L) audio jacks from your composite device to the AV R and L audio-in jacks on the side of your LCD TV.
3. Turn on your LCD TV (see **4-4 Turning ON the Power**), then press the **INPUT** button repeatedly to select **AV**.

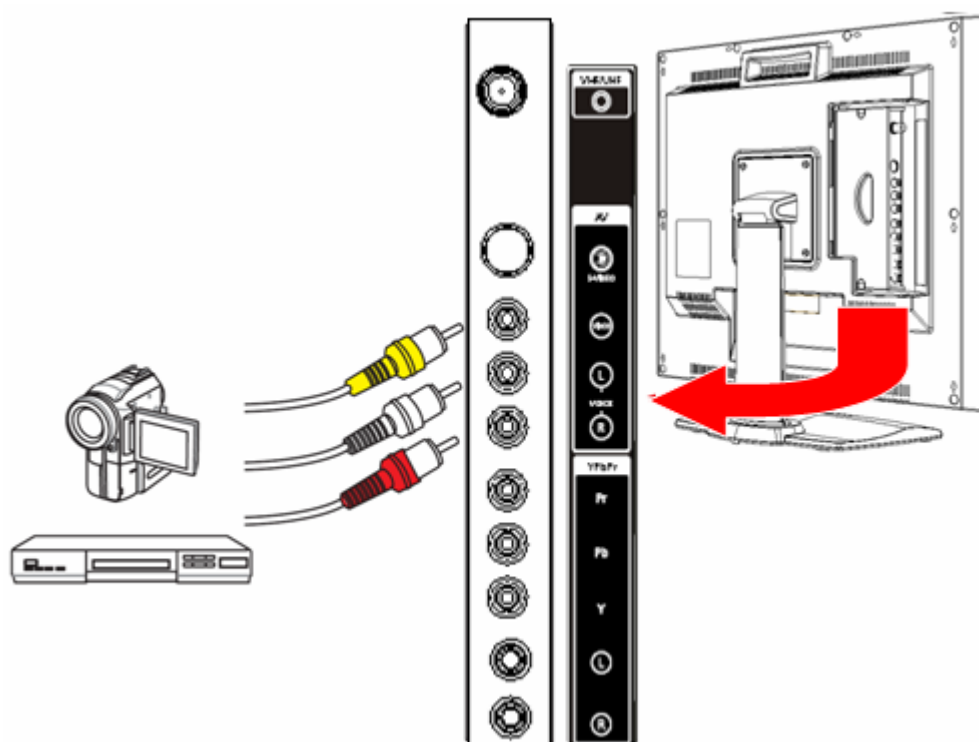

5-3 Connecting a S-Video Device

1. Connect one end of the S-video cable (not supplied) to your device and the other end to the S-video jack on the left-side of your LCD TV.
2. Connect the red (R) and white (L) audio jacks from your device to the AV R and L audio-in jacks on the side of your LCD TV.
3. Turn on your LCD TV (see **4-4 Turning ON the Power**), then press the **INPUT** button repeatedly to select **AV**.

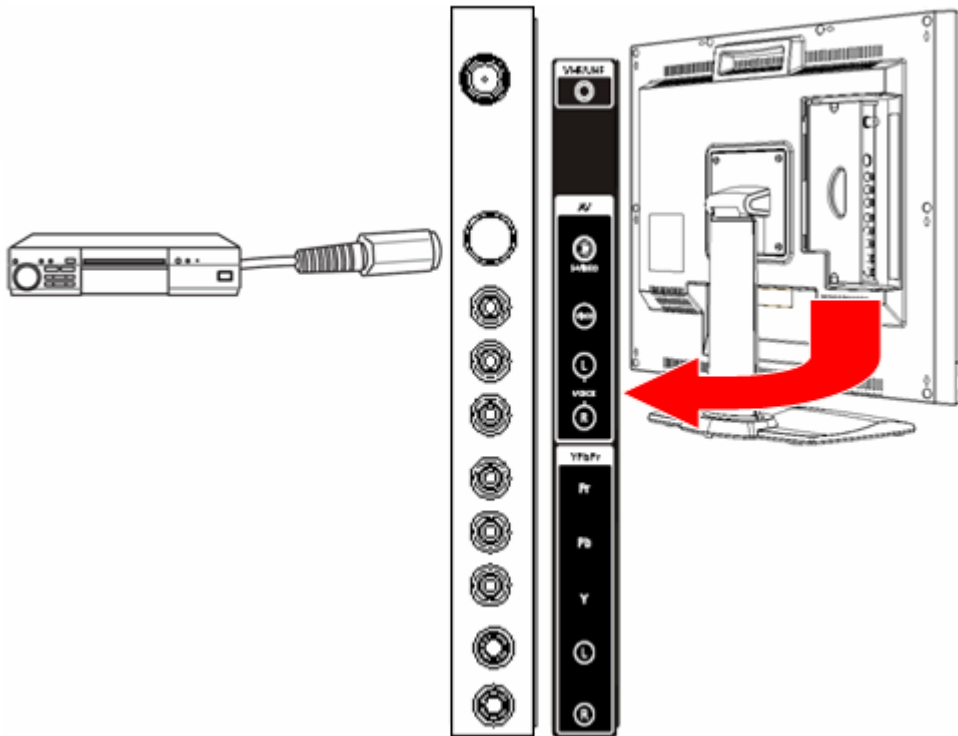

5-4 Connecting a VCR Using Coaxial (RF)

1. Connect the "output to TV" (RF out or Antenna out) jack on the back of your VCR to the TUNER (UHF/VHF-CATV) jack on the back of your LCD TV with the supplied RF lead.
2. Turn on your LCD TV (see **4-4 Turning ON the Power**), then press the **INPUT** button repeatedly to select **TV**.
3. If you have a broadcast antenna or cable box, connect your broadcast antenna or cable TV coaxial (RF) cable to the UHF/VHF connector on the back of your VCR.

WARNING! If an outdoor antenna or cable system is connected to your LCD TV, make sure that the antenna or cable system is correctly grounded.

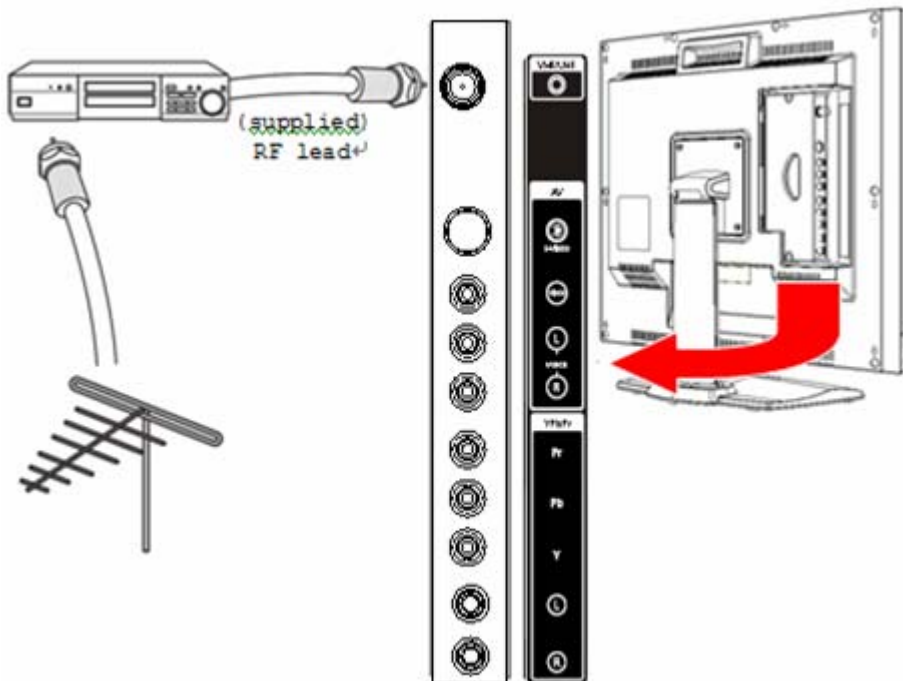

5-5 Connecting Speakers

Connect a headphone or speakers to the Audio-out jack on the back of your LCD TV. See **2-3 Back Connectors Connectors** for the location of the Audio-out jack.

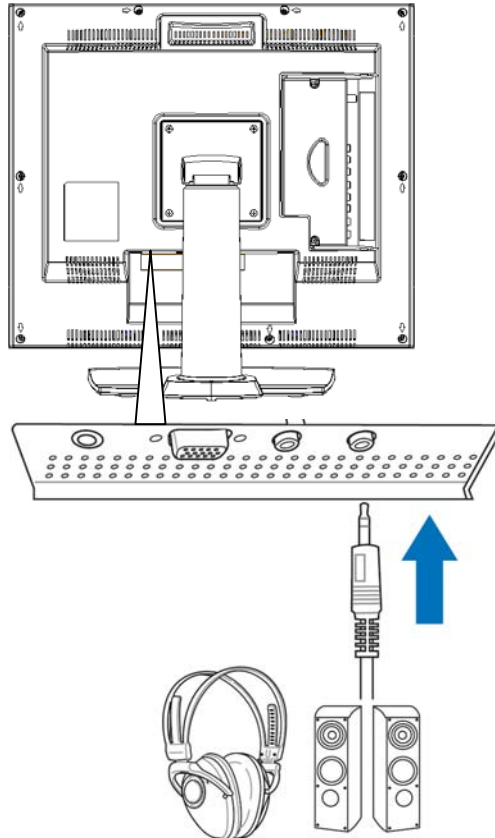



6 ADJUSTING SETTINGS

6-1 Basic Operations

6-1-1 ADJUSTING THE VOLUME



You can adjust the volume in two ways - from your LCD TV's front panel or by using the remote control.

To adjust volume from the front panel:

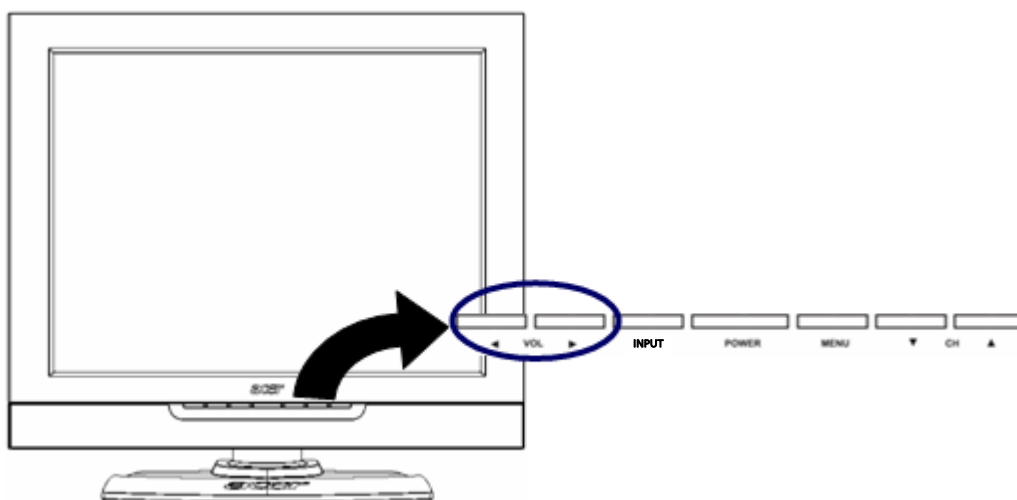
Press  VOL  to increase/decrease the sound level.



TO ADJUST VOLUME FROM THE REMOTE

Press **VOL**  /  (see illustration for location) to turn the volume up or down.

TO TEMPORARILY TURN OFF VOLUME (MUTE)

Press the **MUTE** button on the remote control.



TO TURN VOLUME BACK ON

Press the **MUTE** button again or press **VOL** .



6-1-2 SELECTING PROGRAMS

TO SELECT PROGRAMS FROM THE LCD TV

Press  VOL  to select programs (see *6-1-1 Adjusting the Volume* for location).

TO SELECT PROGRAMS FROM THE REMOTE

Press CH  /  (see illustration for location).

OR



Press the number buttons on the number pad (see *3 Your Remote Control At a Glance* for location).



6-2 Using the On-Screen Display (OSD)

Your LCD TV features an on-screen display (OSD) that lets you adjust and save contrast, brightness, and other settings. All the function settings are accessible either through the proper front display buttons or through the remote control. OSD menus may be different depending on the current input source.

6-2-1 MAKING ADJUSTMENTS

1. With the power ON, press the **TV** button .
2. Press the **MENU** button to show the main menu.
3. Press the  buttons to select one of the menu options.
4. Press the  buttons to access the submenu for the highlighted option.
5. Press the  buttons to make adjustments.
6. Press the **MENU** button to return to the previous menu option.
– OR –
Press the **MENU** button twice to close the OSD.



6-3 OSD Menus and Options

You can use these OSD menus and options to adjust various settings for your LCD TV.

6-3-1 With Source Input Set to TV

Main Menu



Input Select Menu

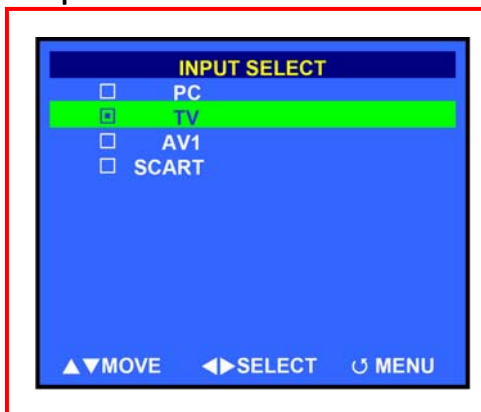

Use this menu to switch between available signal input sources.

NOTE: AV shares the either S-video or CVBS (RCA phono).

圖片有錯, 未提供

Picture Menu

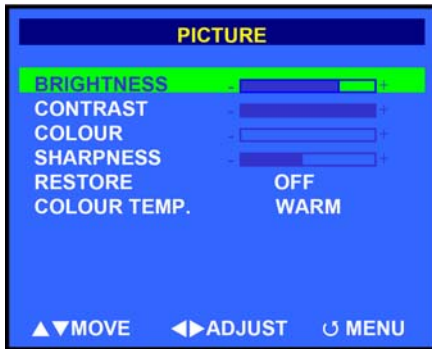

Brightness - Adjusts the luminance of the image.

Contrast - Adjusts the contrast ratio.

Color - Adjusts the color saturation, making colors more or less intense.

Sharpness - Adjusts the sharpness of the image.

Restore - Select ON to use factory default image settings.

Color Temp - Adjusts the color temperature.

Sound Menu



Treble - Adjusts the treble value to enhance high frequency sounds.

Bass - Adjusts the bass value to enhance the low frequency sounds.

Balance - Adjusts the level of sounds between the left and right speakers.

Restore - Select ON to use factory default sound settings.

Surround - Turns ON/OFF surround sound feature.

Language Menu



Use this menu to change the language of the OSD menu between English, Spanish, and Portuguese.

Special Features Menu



Sleep Timer - Turns the sleep timer ON/OFF. Select 30, 60, or 90 minutes.

Teletext - Choose between displaying the FASTEXT line and a LIST of menu commands. The FASTEXT line contains onscreen operating instructions associated with the colored buttons on the remote control.

Setup Menu



Country - Select the appropriate country signal. If your country is not listed, choose one that uses the same TV system.

Color System - Select a color system. Choices are Auto, PAL, and SECAM.

Sound System - Select from BG, DK, I, and L.

Auto Setup - Select this option to add all channels that have a signal to the channel list.

Fine Tuning - Use to improve reception of channels in areas of weak signal reception.

Manual Tuning - Select this option to add only certain channels to the channel list.

Program Sort - Select this option will bring up a submenu that allows you to rearrange the channel list.

7 ADVANCED SETTINGS

7-1 Setting the Sleep Timer

The sleep timer allows your LCD TV to automatically turn OFF after a given amount of time.

TO SET THE SLEEP TIMER USING THE REMOTE CONTROL

1. Press the **TV** button.
2. Press the **SLEEP** button on the remote control. The sleep timer appears at the bottom of your screen.
3. Press the **SLEEP** button one or more times to select the time you want.
4. The Sleep Timer screen will automatically disappear after ten seconds. Your sleep timer is now running in the background.



TO TURN OFF THE SLEEP TIMER

Press the **SLEEP** button repeatedly until the number 0 appears.

TROUBLESHOOTING AND SUPPORT

Before contacting customer service, use the following information to solve common problems.

No Picture

- Make sure that the power cord is properly plugged into a grounded electrical outlet.
- Make sure that the main power switch and power button are turned ON.
- Make sure that the selected video input source is connected to a working device.
- If your LCD TV is connected to your computer in VGA mode, press any key on your keyboard to wake up your computer.

No Sound

- Try pressing the **MUTE** button.
- Make sure that the headphones are not connected.
- Check Audio setting under the OSD Audio menu.

Distorted Picture or Unusual Sounds

You may be getting interference from electrical appliances, cars, motorcycles, or fluorescent lights. Try moving your LCD TV to another location.

Abnormal Patterns

- Make sure that the input source cable is attached securely and correctly.
- Make sure that the video input source is within the range of your LCD TV.
- Compare the video input source's specifications with your LCD TV's specifications.

Abnormal Colors

Make sure that the input source cable is connected securely and correctly to your LCD TV.

Normal Picture, No Sound

- Make sure that the volume is not turned down.
- Make sure that the sound is not muted.
- Make sure that your audio input source cables are connected securely and correctly.

Wrong Image Size

If you are using VGA mode, make sure that the H-Position and V-Position in the OSD is set correctly.

Screen Noise

When your LCD TV's digital capabilities exceed a digital broadcast signal, the signal is up-converted (increased) to match your LCD TV's display capabilities. Up-converting can cause noise or trash.

Dim Screen

Video display devices experience degradation of brightness over the life of the device. Normal brightness degradation is not covered by your warranty.

Pixel Problems

Your LCD TV is manufactured using an extremely high level of precision technology. However, sometimes some pixels of your LCD TV may not display correctly. Pixel defects within industry specifications are inherent to this type of product and do not constitute a defective product.

Remote Control Not Working

- Make sure that the batteries are inserted correctly.
- Make sure the remote control sensor window is not under strong lighting.

Technical Support

If this troubleshooting information does not resolve your problem or if you have other questions relating to your LCD TV, please contact your local dealer.

PRODUCT SPECIFICATIONS

English

Model Name	AT2001
Panel spec	
Resolution	800*600
Brightness (typ.)	450 nits
Contrast Ratio (typ.)	500:1
Display color	16.7 M
Viewing Angle (typ.)	H:160 ; V:120
Response Time (typ.)	16 ms (gray to gray)
Power Supply	
Input	100V~240V-AC
Max. Power	63W
Power Saving	5W
Mechanical	
Dimensions (W*H*D)	495.9*468.2*198.4mm
Tilt angle	Up 15 degree, Down 5 degree.
Weight (Kg/lb)	7.8 Kg/17.16lb
Wall Mounting	Yes (100*100mm)
Terminal	
AV1	RCA for CVBS, S Din for S-Video, Audio R/L
Av2	RCA for YPbPr, Audio R/L
PC D-Sub	Yes
PC Audio In	Yes
Headphone	Yes
Audio system	
Speaker	3W+3W

Free Manuals Download Website

<http://myh66.com>

<http://usermanuals.us>

<http://www.somanuals.com>

<http://www.4manuals.cc>

<http://www.manual-lib.com>

<http://www.404manual.com>

<http://www.luxmanual.com>

<http://aubethermostatmanual.com>

Golf course search by state

<http://golfingnear.com>

Email search by domain

<http://emailbydomain.com>

Auto manuals search

<http://auto.somanuals.com>

TV manuals search

<http://tv.somanuals.com>