



Acer LCD TV

AT3201W

User's Guide





Copyright © 2005. Acer Incorporated.
All Rights Reserved.

Acer LCD TV AT3201W User's Guide
Original Issue: May 2005

Acer and the Acer logo are registered trademarks of Acer Incorporated. Other companies' product names or trademarks are used herein for identification purposes only and belong to their respective companies.



Contents

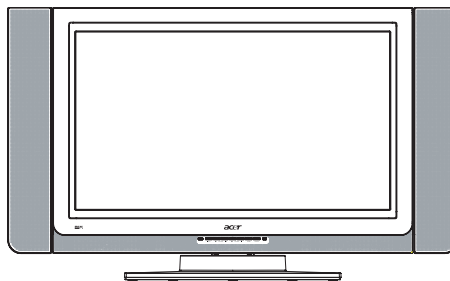

Important safety instructions	5
Taking care of your remote control	6
Cleaning and servicing	6
First things first	7
Basic features and benefits	7
Packing checklist	7
Your LCD TV overview	8
Front panel view	8
Rear panel view	9
Basic connection	11
Connecting the power cord	11
Connecting an antenna	11
Connecting DVD/VCR/AV equipment	12
Connecting a camera, camcorder or video game	12
Connecting headphones	13
Connecting a PC or Notebook	13
Remote control overview	14
Getting started	18
Power On	18
Setup Wizard	18
Changing channels	18
Adjusting the volume	18
OSD Navigation	19
Navigating the OSD using the remote control:	19
Advanced Features	20
Empowering Key: Scenario Mode and Favourite Channels	20
PIP/PBP/POP	22
Parental Control	22
Troubleshooting	23
Product specifications	24





Important safety instructions

Read these instructions carefully. Save them for future reference.

- 1 Follow all warnings and instructions marked on the product.
- 2 Unplug this product from the power outlet before cleaning. Use a soft, moist cloth for cleaning. Do not use liquid or aerosol cleaners.
- 3 Do not use this product near water. Do not spill water or any other liquid on the product.



- 4 Do not place this product on an unstable cart, stand, or table. The product may fall, causing serious damage to the product.



- 5 Slots and openings are provided for ventilation; to ensure reliable operation of the product and to protect it from overheating. These openings must not be blocked or covered. The openings should never be blocked by placing the product on a bed, sofa, rug, or other similar surface. This product should never be placed near or over a radiator or heat register, or in a built-in installation unless proper ventilation is provided.

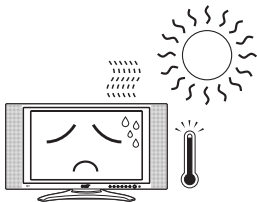

- 6 This product should be operated from the type of power source indicated on the label. If you are unsure of the type of power source available, consult your dealer or local power company before use.
- 7 Do not step on or place heavy objects on the power cord. Carefully route the power cord and any cables away from foot traffic. Do not locate this product where persons will step on the cord.

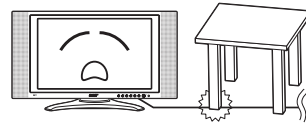

- 8 If an extension cord is used with this product, make sure that the total ampere rating of the equipment plugged into the extension cord does not exceed the extension cord ampere rating. Also, make sure that the total rating of all products plugged into the wall outlet does not exceed the fuse rating.
- 9 Never push objects of any kind into this product through cabinet slots as they may touch dangerous voltage points or short out parts that could result in a fire or electric shock.
- 10 Do not attempt to service this product yourself, as opening or removing covers may expose you to dangerous voltage points or other risks. Refer all servicing to qualified service personnel.
- 11 Unplug this product from the wall outlet and refer servicing to qualified service personnel under the following conditions:
 - a. When the power cord or plug is damaged or frayed.
 - b. If liquid has been spilled into the product.
 - c. If the product has been exposed to rain or water.
 - d. If the product does not operate normally when the operating instructions are followed. Adjust only those controls that are covered by the operating instructions since improper adjustment of other controls may result in damage and will often require extensive work by a qualified technician to restore the product to normal condition.
 - e. If the product has been dropped or the case has been damaged.
 - f. If the product exhibits a distinct change in performance, indicating a need for service.
- 12 Only use the correct power cord (provided in your accessories box) for this product. Always disconnect the power cord from the wall outlet before servicing or disassembling this equipment.

Taking care of your remote control

Follow these steps to ensure proper care of your remote control:

- Handle the remote control with care. Dropping it, placing it in direct sunlight, or allowing it to get wet may cause damage.
- Do not tamper with the batteries, and keep them away from children.
- When you anticipate that the remote control will not be used for an extended period, remove the batteries to prevent possible damage from battery leakage.
- Dispose of batteries according to local regulations. Recycle if possible.

Cleaning and servicing

When cleaning your LCD TV, follow these steps:

- 1 Power off the TV.
- 2 Disconnect the power cord.
- 3 Use a soft, moist cloth. Do not use liquid or aerosol cleaners.



First things first

We would like to thank you for making the Acer LCD TV your choice. Your new Acer LCD TV will provide you with years of entertainment, versatility, and satisfaction.

This User's Guide introduces you to the various features of your LCD TV, and provides clear and concise information about the product. It is important that you read it thoroughly before use and retain it for future reference.

Basic features and benefits

- Wide display with 1366 x 768 resolution - HDTV ready display
- Simultaneous pre-viewing of programs with 4 different Picture-In-Picture modes
- Excellent sound enhancement with SRS WOW technologies
- Brilliant color with gamma correction
- Minimized motion artefacts through noise reduction
- Sharp and accurate image with de-interlacing and comb filter
- Best DVD video quality with 3:2/2:2 pull down recovery
- Stylish appearance

Packing checklist

In addition to the accessory box, your LCD TV package should contain the following accessories. Please ensure that they are all present.

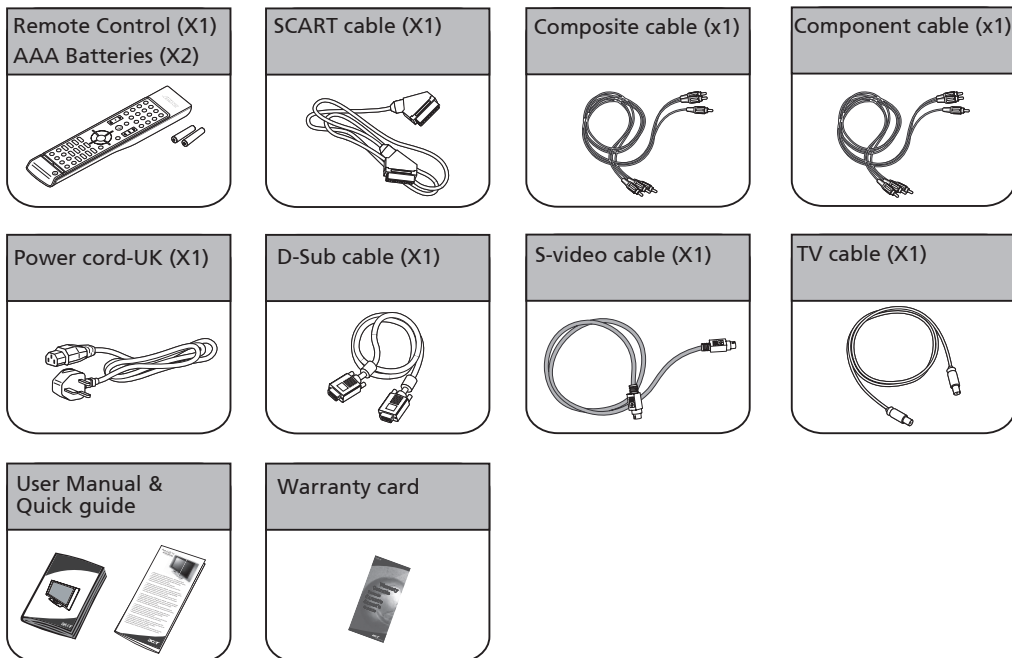



Your LCD TV overview

English

Front panel view

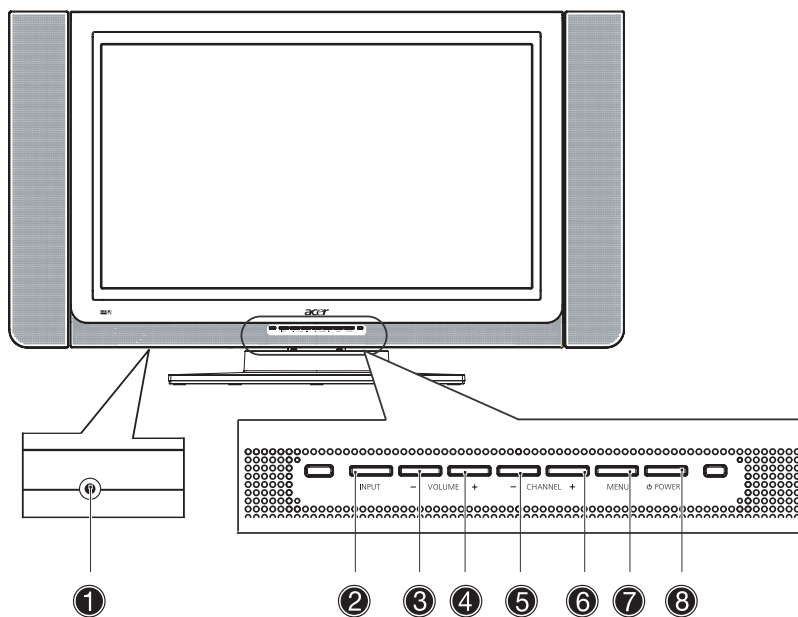

No.	Item	Description
①	Headphone	Connects to headphones.
②	Input	Select source. When the OSD is on, press this button to confirm selection
③	Vol Down	Volume down. When the OSD is on, functions the same as the Left arrow
④	Vol Up	Volume up. When OSD is on, functions the same as the Right arrow
⑤	Channel Down	Channel down. When the OSD is on, functions the same as the Down arrow
⑥	Channel Up	Channel up. When the OSD is on, functions the same as the Up arrow
⑦	Menu	Turns the OSD menu ON and OFF
⑧	Power	Turns the Power ON and OFF



Rear panel view

English

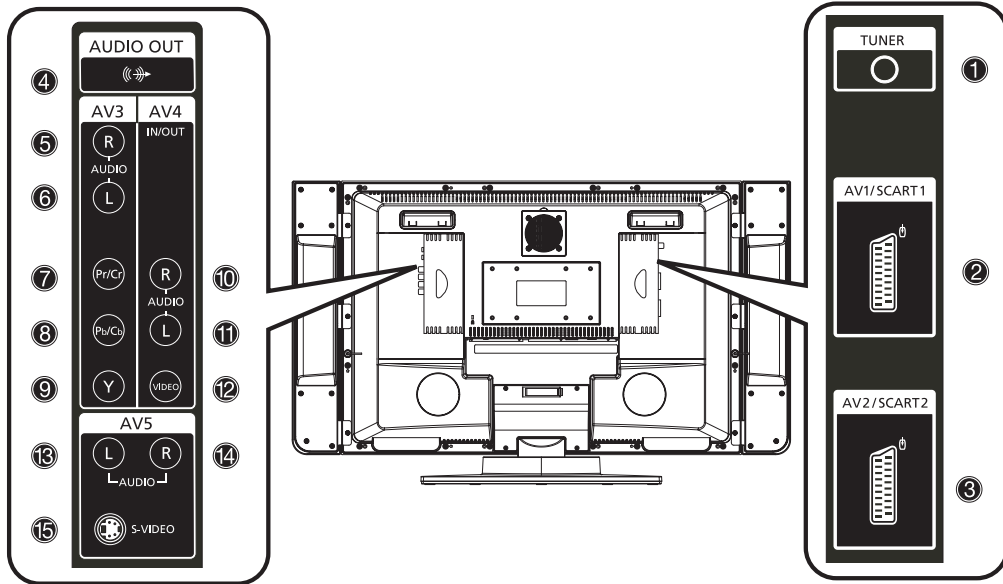

No.	Item	Description
①	Tuner	Connects to the outdoor antenna cable
②	AV1 / SCART 1	In Supports an external device with a SCART cable(for RGB, CVBS, S-Video, Audio left/right input)
		Out In TV mode, connects to your VCR In or PVR In with SCART cable to record TV programs
③	AV2 / SCART 2	In Supports external device with a SCART cable(for RGB, CVBS, S-Video, YPbPr/YCbCr, Audio left/right input)
		Out In TV mode, connect to your VCR In or PVR In with a SCART cable to record TV programs
④	Audio Out	Connects to the audio jack input of your external device.
AV3		
⑤	Audio-R	Connects to the Audio-R output of your DVD, VCR player using the red composite cable
⑥	Audio-L	Connects to the Audio-L output of your DVD, VCR player using the white composite cable
⑦	Pr/Cr	Connects to the Component- Pr/Cr output of your DVD, VCR player using the red component cable
⑧	Pb/Cb	Connects to the Component- Pb/Cb output of your DVD, VCR player using the blue component cable
⑨	Y	Connects to the Component-Y output of your DVD, VCR player using the green component cable



Rear panel view

English

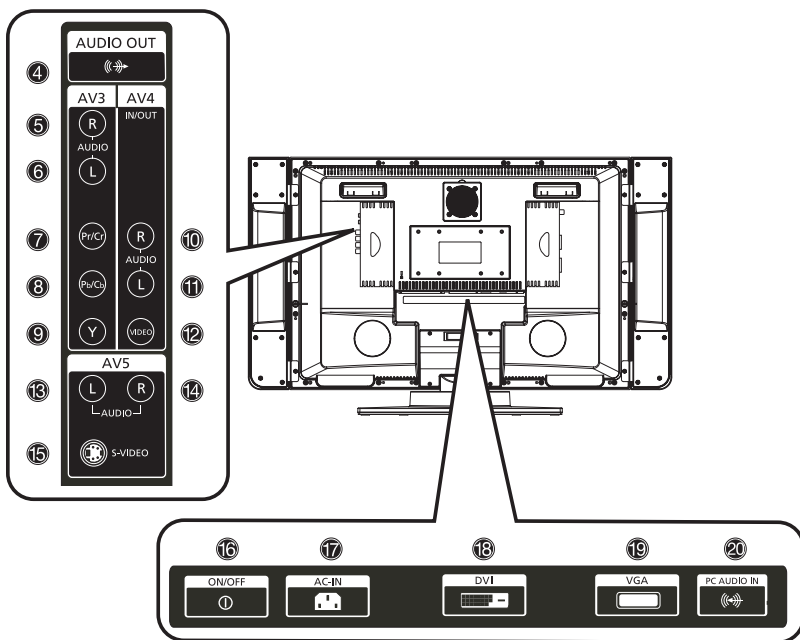

No.	Item	Description
AV4		
10	Audio-R	In Connects to the Audio-R output of your external device with the red composite cable Out In TV mode, connects to your VCR In or PVR In with the red composite cable to record TV programs (Please set AV4 to "Out" in OSD)
11	Audio-L	In Connects to the Audio-L output of your external device with the white composite cable Out In TV mode, connects to your VCR In or PVR In with the white composite cable to record TV programs (Please set AV4 to "Out" in OSD)
12	Video	In Connects to the Composite - Video output of your external device with the yellow composite cable Out In TV mode, connects to your VCR In or PVR In with the white composite cable to record TV programs (Please set AV4 to "Out" in OSD)
AV5		
13	Audio-R	Connects to the Audio-R output of your external device with the red composite cable
14	Audio-L	Connects to the Audio-L output of your external device with the white composite cable
15	S-Video	Connects to the S-Video output of your external device with the S-video cable
Bottom		
16	ON/OFF	Turn the power on and off
17	AC In	Connects to an AC power source
18	DVI	Connects to an external DVI source
19	VGA	Connects to a PC VGA Out
20	PC Audio In	Connects to a PC audio jack Out

10



Basic connection

Connecting the power cord

1. Plug the AC cord into the AC input on the back of the set.
2. Connect the male plug to the wall outlet as shown.

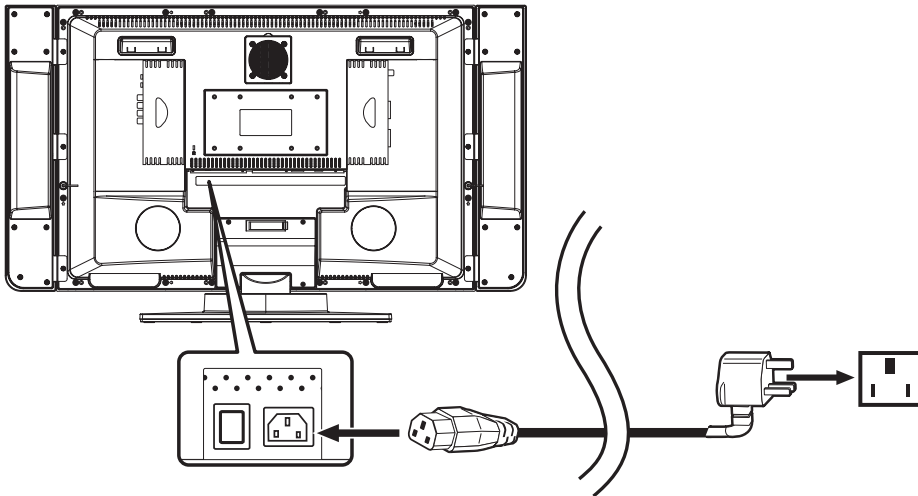

English

Connecting an antenna

Plug the outdoor antenna cable lead-into the antenna terminal on the back of the TV set as shown.

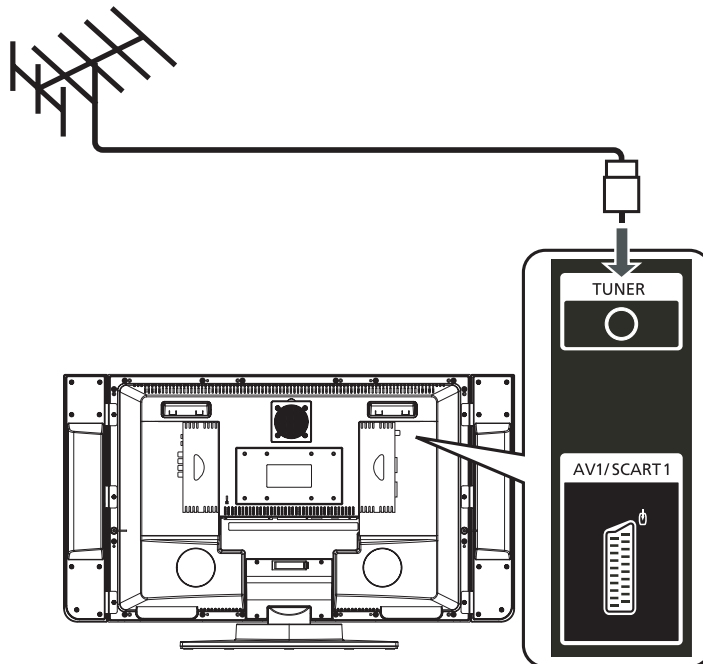

Connecting DVD/VCR/AV equipment

Connect the SCART cable to the SCART port as shown below.

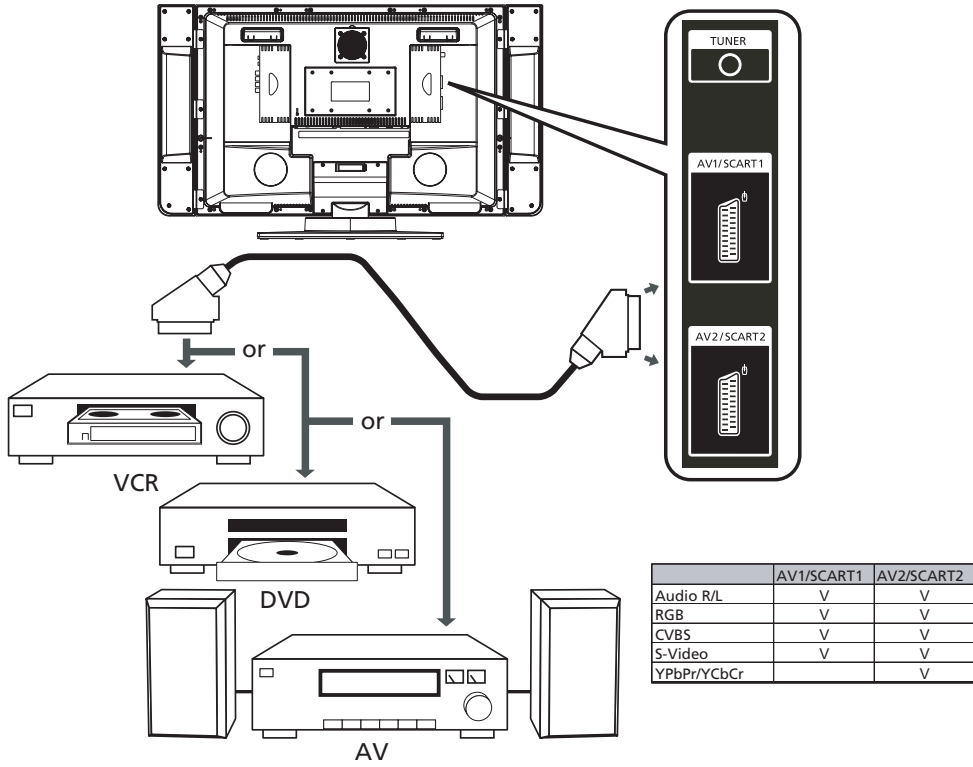

Alternatively you can use other connectors such as Component, S-Video, Video and Audio R/L for appropriate equipment

Connecting a camera, camcorder or video game

Connect your camera or camcorder to the Video/Audio ports on the bottom of the TV set as shown below.

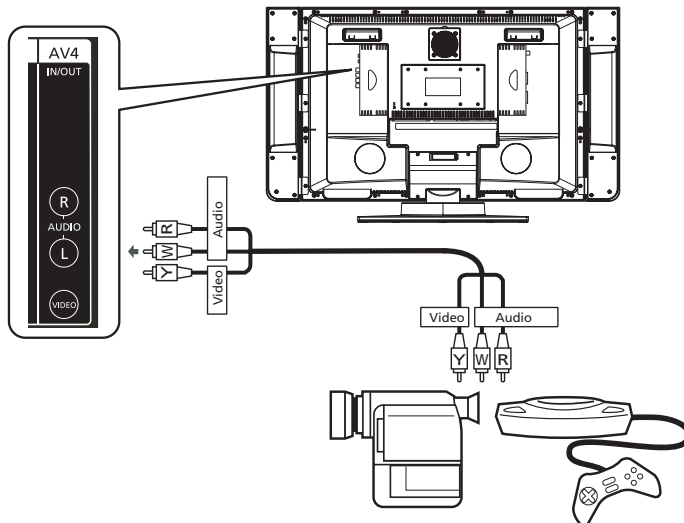



Connecting headphones

Connect your headphones to the headphone input port on the bottom of the TV set as shown below.

English



Connecting a PC or Notebook

Connect your PC or notebook to the D-Sub or DVI ports on the bottom of the TV set as shown below.

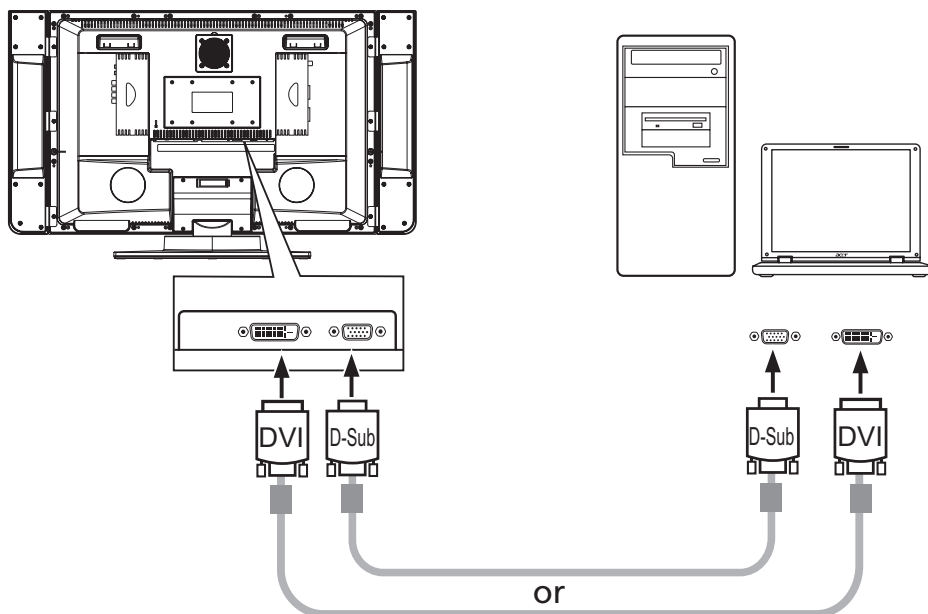

The Max. resolution is 1366 x 768. For PC connections, the optimal setting is 1360 x 768@60Hz.

13

Remote control overview

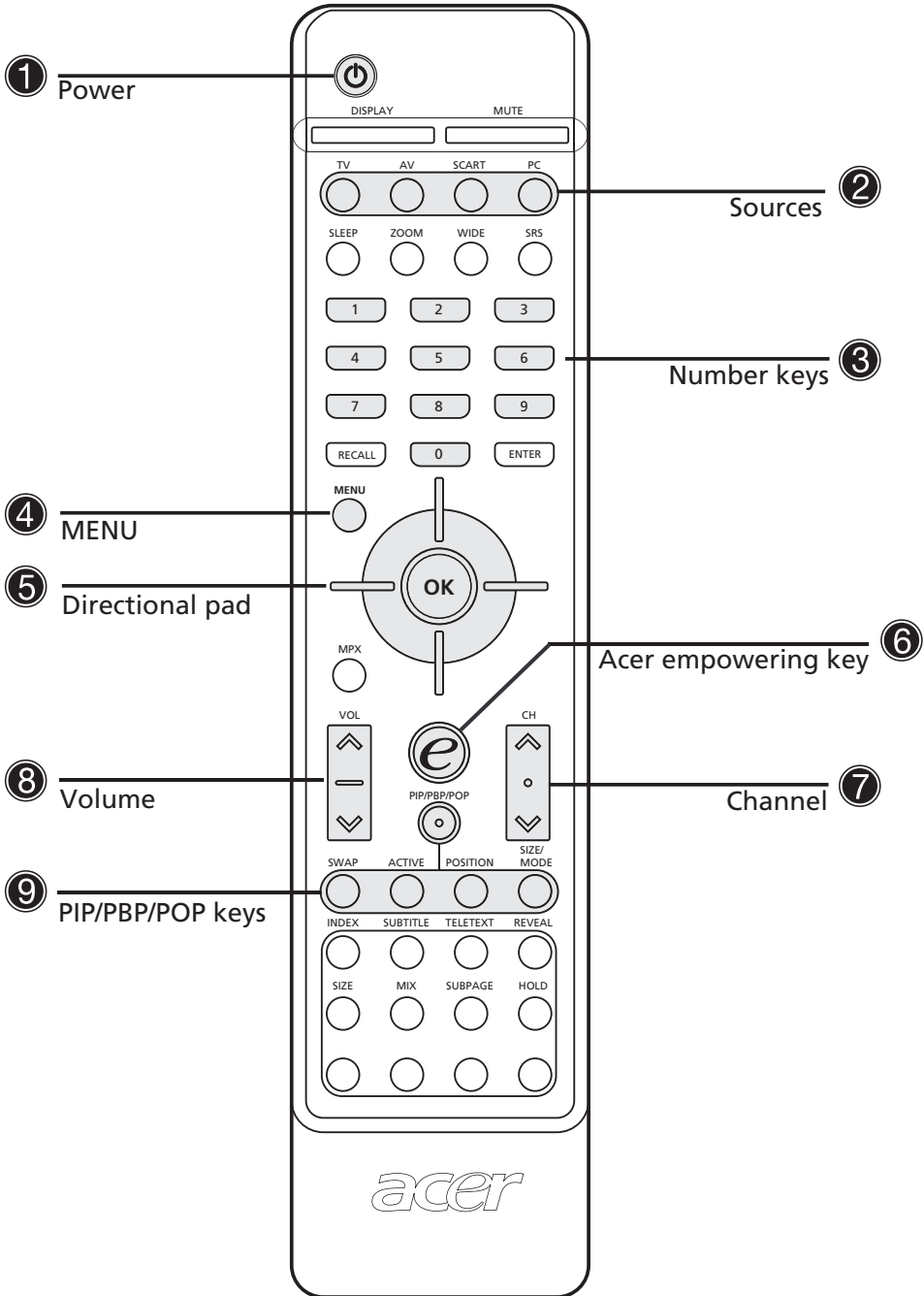



Item	Description
① Power button	Press to turn your TV on/off.
DISPLAY	Displays channel number and input source on the upper right-hand corner of the screen.
MUTE	Press once to mute the sound; press again to restore.
TV	Press to toggle TV mode.
② AV	Press to toggle sources between AV3, AV4 and AV5
SCART	Press to toggle sources between SCART1 and SCART2.
PC	Press to toggle sources between VGA and DVI
SLEEP	Set a time period after which the TV will switch itself to standby. Press repeatedly to select the number of minutes.
ZOOM	Press to toggle the image between Normal, Zoom1 (2X) and Zoom2 (4X). After pressing the zoom key, press the 4-way scroll key to select the zoom area, then, press OK to activate.
WIDE	Press to switch the scaling mode between 4:3, 16:9, Panorama and Letterbox
SRS	Press to select SRS WOW, TruBass, SRS, Off modes sequentially. SRS WOW is a technology to enhance 3D sound, bass performance and to produce a wider sound field.
③ Number keys	Number keys from 0-9.
ENTER	Press to confirm channel selection made using the number keys.
RECALL	Press to return to the previous channel.
④ MENU	Press to open Menu or leave Menu.
⑤ 4-way scroll key/OK	When OSD is on: Navigate up, down, left and right in the OSD menu / press OK to confirm. When in Zoom mode: Navigate up, down, left and right on the screen, press OK to zoom the selected area.
MPX	Press to select the sound system, displayed at the top right-hand corner.
⑥ e	Acer empowering key for Favourite channels, Scenario mode. See page 20.
⑦ CH (up/down)	Press these buttons to select the TV channel in sequence.
⑧ VOL (up/down)	Press these buttons to increase and decrease the volume.
PIP/PBP/POP	Switch between PIP/PBP/POP modes. See page 22.
SWAP	When in PIP/ PBP mode: Toggle primary and sub screen in toggle.
⑨ ACTIVE	When in POP mode: Toggle the active screen.
POSITION	When in PIP mode: Change position of subscreen
SIZE/MODE	When in PIP mode: Change subscreen size 25%, 37.5%, 50% When in POP mode: Switch POP mode between 1+5 and 1+12



Remote control overview

English

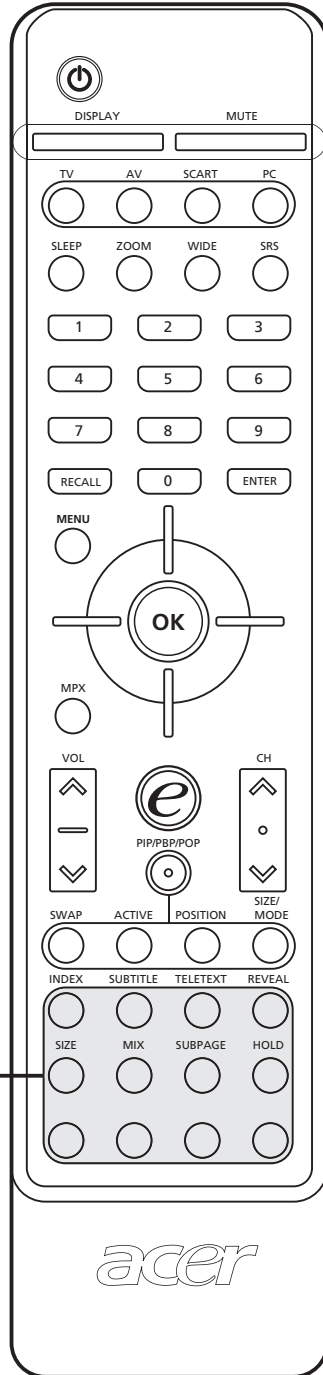

① Teletext keys



Teletext keys

English

Item	Description
INDEX	Go to the index page
SUBTITLE	Show subtitles
TELETEXT	Press to switch from TV/AV to Teletext mode.
REVEAL	Press to reveal hidden teletext information.
SIZE	Press once to zoom teletext page to 2X; press again to resume.
MIX	Press to overlay teletext page on the TV image, i.e. subtitles.
HOLD	Press to pause the current teletext page in multi-page viewing mode.
Color buttons (R/G/Y/B)	Operates corresponding button on the teletext page.

1

Getting started

Power On

- Press the power switch located on the bottom of the TV to the "on" position
- Push the power button, number keys, or channel up/down button on the remote control.

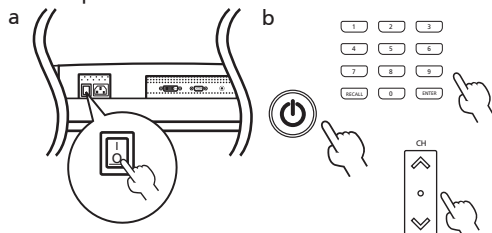

Setup Wizard

The first time you switch on the TV, the Setup wizard will guide you to complete the "language selection" and "channel scanning".

- Step 1. Please plug in the tuner coaxial cable and then press "OK" key
 - Step 2. Auto Scanning, please wait
- Setup completed

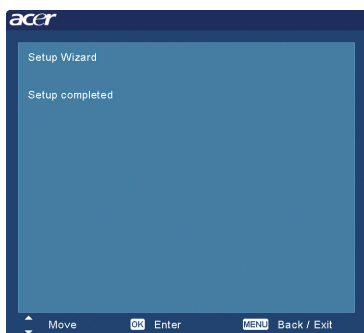

Changing channels

- Press 0-9 on the remote control to select a channel. The channel changes after 2 seconds. Press ENTER to select the channel immediately.

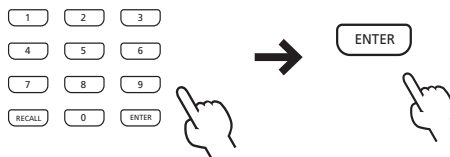

- You can also change the channel by pressing and holding the channel up/down button on the remote control. Up will increase the number, while down will decrease the number.

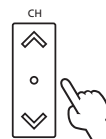

Adjusting the volume

Adjust the volume by pressing using the Vol +/- button on the remote control. Up will increase the volume, while down will decrease the volume.

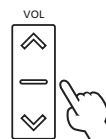

You can also adjust the volume and channel using the buttons on the front control panel. Please see "Front panel view" on page 8 for details.

OSD Navigation



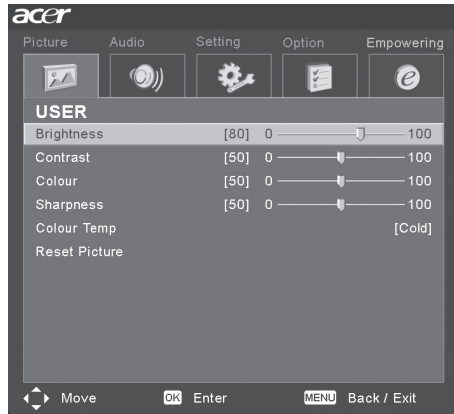

Advanced settings and picture adjustments are available through the OSD (on-screen display) menus, as shown in the example screenshot below.

English



You can also interact with these menus using the front panel controls. Please see "Front panel view" on page 8 for details.

Navigating the OSD using the remote control:

There are five main OSD menus. These are: Picture , Audio , Settings , Options  and Empowering . Use the following method to easily navigate these menus.

- 1 Press the "Menu" button on the remote control or the "Menu" button on the control panel.

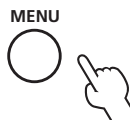

- 2 Select your desired menu by using the Left/Right sides of the directional pad to switch between the five menus.

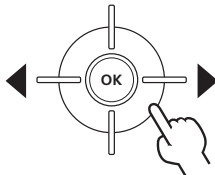

- 3 Use the directional pad to interact with the menu. The Up/Down directions will scroll through the menu options, while Left/Right will adjust the different settings (for example, in the Picture menu, settings such as brightness, contrast, etc). If there are no adjustments, press "OK" to select.



Advanced Features

English

Empowering Key: Scenario Mode and Favourite Channels

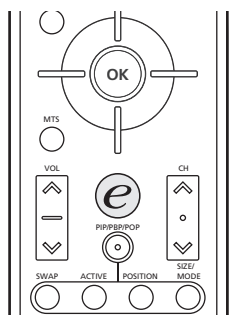

Use the OSD to define your “e” Empowering Key setting: Scenario mode or Favourite channel. The default for the “e” key is the Scenario mode. Follow these steps: Menu > Empowering > e Key Setting. Choose between “Favourite channel” or “Scenario mode.” Now, when you press the “e” key, your chosen selection will be accessed.

Scenario Mode

Press the “e” Empowering key and use the Scenario mode to select pre-defined audio and video settings for optimal enjoyment of the following scenarios: Standard, Movie, Sport, Concert, Game, User; and smoothly presents moving images.

Mode	Scenario Mode Design Direction
Standard	Standard mode allows you to watch your favourite channels with sharp, brilliant imagery via adaptive brightness and contrast adjustments. Clear-sounding audio is provided by SRS performance.
Movie	For comfortably enjoying movies at home, Movie mode displays dim scenes in clear detail; compensates for colour; and smoothly presents moving images. This is accomplished through optimal Gamma correction plus saturation, brightness and contrast adjustments. Movie mode makes the most of high-definition movie soundtracks by using SRS WOW technology.
Game	Game mode carefully details the exquisite graphics of modern video games, providing lifelike entertainment while protecting your eyesight by adjusting brightness and contrast. What’s more, Game mode provides a heightened audio experience via SRS WOW technology.
Sports	Sports mode is suited for outdoor sports programmes, with accurate background depth and clear gradation between the bright, outdoor playing field and darker auditoriums. Sports mode also brilliantly enhances colours and presents swiftly moving pictures without residual images. All of this is achieved via specific Gamma corrections and saturation adjustments. Precise audio can be heard, thanks to Tru-Bass performance.
Concert	Concert mode places you in a virtual concert hall, opera house or other dim environment by means of adaptive brightness and contrast adjustments. Concert mode accentuates symphonic harmonies and the tenor audio range using SRS WOW technology.



Favourite Channels

Please note that Scenario mode is the default value for the "e" Empowering key. In order to make use of the following instructions, please set Favourite channel as the default using the method described on the previous page.

Storing favourite channels

For quick access to your favourite channels, use the following method:

- To store a channel in memory for quick access, select your desired channel, then press and hold the "e" Empowering key on the remote control for more than 2 seconds. This will store the TV channel information at the bottom of the favourite list.
- There are a total of five slots in which you can store TV channels.
- If there is no empty slot in the favourite list, the first channel will be wiped out and the new TV channel is added at the bottom of the favourite list. Simply put, it's "First in, first out".
- When the current channel is stored in the favourite list, pressing the "e" key for more than 2 seconds will remove the channel from the favourite list.
- To view currently stored favourite channels, press the "e" Empowering key. You will see a screen similar to the one shown below

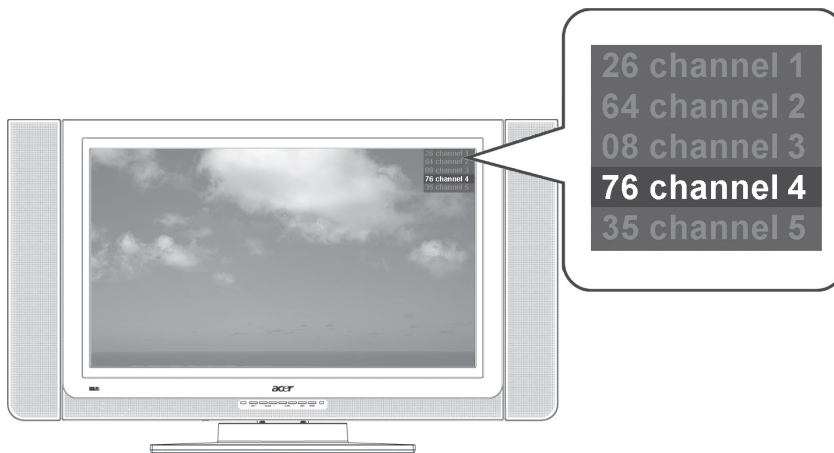

Viewing your favourite channels

- On the remote control, if you press the "e" Empowering key for less than 1 second, the favourite channel table will pop up. Your currently selected favourite channel will be highlighted. To view your other favourite channels, press the "e" Empowering key again to toggle the TV channels sequentially according to your favourite list.

PIP/PBP/POP

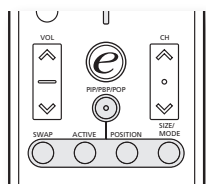

In TV, AV, SCART and PC mode, press PIP/PBP/POP button once to display using picture- in- picture (PIP). Press twice to display using picture- by- picture (PBP).



PIP (Picture in Picture)

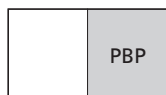

PBP (Picture by Picture)

In SCART and PC mode, press PIP/PBP/POP button three times to display picture-on-picture (POP). Then, the POP screens will display the subsequent TV channels one-by-one.

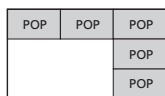

POP (Picture on Picture)

PIP

1. Press the "TV/SCART/AV/PC" keys, number keys or "CH up/down" key to change the content of the PIP screen.
2. Press "Swap" key to change the content between the primary and the PIP screen.

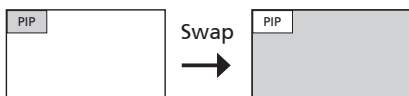

3. Press the "Position" key to select the location of the sub-screens; from Upper Left -> Upper Right -> Lower Right -> Lower Left, as shown in the image.

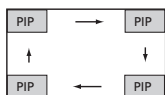

4. Press the "Size/Mode" key to change the size of the PIP screen between 25%, 37.5%, 50%

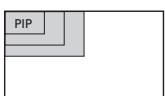

PBP

1. Press the "TV/SCART/AV/PC" keys, number keys or "CH up/down" key to change the content of the PBP screen.
2. Press "Swap" key to change the content between the primary and the PBP screen.

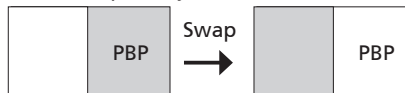

POP

1. Press "Activate" key to activate the TV channel on the top-left POP screen.
2. Press the number keys or "CH up/down" key to change the TV channel of the top-left POP screen. Then, press the "activate" key again. The other POP screens will show the following channels in sequence.
3. Press the "Size/Mode" key to access the 1 + 5 or 1+12 picture on picture mode as shown in the image below.

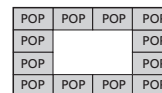
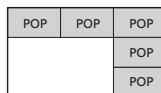

Parental Control

When in TV mode, you can find a Parental Control feature in the Settings menu. Enter a four-digit PIN number using the number keys on your remote control. Use this number to adjust the Parental Control settings, to prevent access to certain channels.

If you forget your PIN number, please enter 6163 to reset.

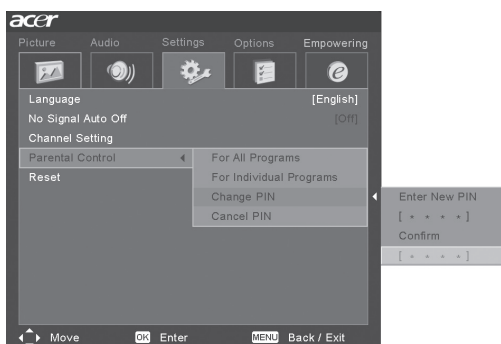



Troubleshooting

Before you call the Acer service center, please check the following items:

The following is a list of possible situations that may arise during the use of your LCD TV. Easy answers and solutions are provided for each one.

There is no picture or sound.

- Make sure the power cord is properly inserted in the power outlet.
- Make sure the input mode selector is set to the correct source.
- Make sure the antenna at the rear of the TV is properly connected.
- Make sure the main power switch is turned on.
- Make sure the volume is not set to minimum or the sound is not set to mute.
- Make sure the headphones are not connected.
- Reception other than those of broadcasting stations can be considered.

Picture is not clear.

- Make sure the antenna cable is properly connected.
- Consider whether TV signals are being properly received.
- Poor picture quality can occur due to a VHS camera, camcorder, or other peripheral being connected at the same time. Switch off one of the other peripherals.
- The 'ghost' or double image may be caused by obstruction to the antenna due to high rise buildings or hills. Using a highly directional antenna may improve the picture quality.
- The horizontal dotted lines shown on the pictures may be caused by electrical interference, e.g. hair dryer, nearby neon lights and etc. Turn off or remove these equipment.

Picture is too dark, too light or tinted.

- Check the color adjustment.
- Check the brightness setting.
- Check the sharpness function.
- Fluorescent lamp may have reached the end of service life.

Remote control does not work.

- Check the batteries of the remote control.
- Make sure the remote sensor window is not blocked or under strong fluorescent lighting.
- Try to clean the remote control sensor lens on the TV with a soft cloth.
- Use the buttons (hot keys) on the TV before the remote control works.

If the above items do not solve your technical issue, please refer to the warranty card for service information.

Product specifications

Item	Specification
Panel specifications	
Resolution	1366 x 768 pixels
Brightness (typical.)	500 nits
Contrast Ratio (typical.)	800:1
Display colors	16.7 M
Viewing Angle (typical.)	H:170 ; V:170
Response Time (typical.)	12 ms (gray to gray)
Power supply	
Input	100V to 240 V-AC.
Max. power consumption	210 W
Power Saving	5 W
Mechanical	
Dimensions (W x H x D mm)	1018 x 616 x 210 mm
Swivel angle	40 degrees(R20 & L20)
Weight (kg) / (lbs.)	20.7kg / 45.6lbs.
Wall Mounting	Yes
Terminal	
AV1/ SCART1	SCART(RGB,CVBS,S-Video,Audio R/L)
AV2/ SCART2	SCART(RGB,CVBS,S-Video,YPbPr/CbCr,Audio R/L)
AV3	RCA for YPbPr/CbCr,Audio R/L
AV4	RCA for CVBS, Audio R/L
AV5	S-Video, Audio R/L
PC D-sub	Yes
DVI-D(HDCP)	Yes
PC audio-in	Yes
Audio-out	Yes
Headphones	Yes
Audio system	
3D surround	Yes
Speakers	10 W + 10 W
SRS	WOW

Free Manuals Download Website

<http://myh66.com>

<http://usermanuals.us>

<http://www.somanuals.com>

<http://www.4manuals.cc>

<http://www.manual-lib.com>

<http://www.404manual.com>

<http://www.luxmanual.com>

<http://aubethermostatmanual.com>

Golf course search by state

<http://golfingnear.com>

Email search by domain

<http://emailbydomain.com>

Auto manuals search

<http://auto.somanuals.com>

TV manuals search

<http://tv.somanuals.com>