

Aspire One 752/1810T/1410 Service Guide

Service guide files and updates are available on the ACER/CSD web; for more information, please refer to <http://csd.acer.com.tw>

PRINTED IN TAIWAN

Revision History

Please refer to the table below for the updates made on this service guide.

Date	Chapter	Updates

Copyright

Copyright © 2010 by Acer Incorporated. All rights reserved. No part of this publication may be reproduced, transmitted, transcribed, stored in a retrieval system, or translated into any language or computer language, in any form or by any means, electronic, mechanical, magnetic, optical, chemical, manual or otherwise, without the prior written permission of Acer Incorporated.

Disclaimer

The information in this guide is subject to change without notice.

Acer Incorporated makes no representations or warranties, either expressed or implied, with respect to the contents hereof and specifically disclaims any warranties of merchantability or fitness for any particular purpose. Any Acer Incorporated software described in this manual is sold or licensed "as is". Should the programs prove defective following their purchase, the buyer (and not Acer Incorporated, its distributor, or its dealer) assumes the entire cost of all necessary servicing, repair, and any incidental or consequential damages resulting from any defect in the software.

Acer is a registered trademark of Acer Corporation.

Intel is a registered trademark of Intel Corporation.

Pentium and Pentium II/III are trademarks of Intel Corporation.

Other brand and product names are trademarks and/or registered trademarks of their respective holders.

Conventions

The following conventions are used in this manual:

SCREEN MESSAGES	Denotes actual messages that appear on screen.
NOTE	Gives bits and pieces of additional information related to the current topic.
WARNING	Alerts you to any damage that might result from doing or not doing specific actions.
CAUTION	Gives precautionary measures to avoid possible hardware or software problems.
IMPORTANT	Reminds you to do specific actions relevant to the accomplishment of procedures.

Preface

Before using this information and the product it supports, please read the following general information.

1. This Service Guide provides you with all technical information relating to the BASIC CONFIGURATION decided for Acer's "global" product offering. To better fit local market requirements and enhance product competitiveness, your regional office MAY have decided to extend the functionality of a machine (e.g. add-on card, modem, or extra memory capability). These LOCALIZED FEATURES will NOT be covered in this generic service guide. In such cases, please contact your regional offices or the responsible personnel/channel to provide you with further technical details.
2. Please note WHEN ORDERING FRU PARTS, that you should check the most up-to-date information available on your regional web or channel. If, for whatever reason, a part number change is made, it will not be noted in the printed Service Guide. For ACER-AUTHORIZED SERVICE PROVIDERS, your Acer office may have a DIFFERENT part number code to those given in the FRU list of this printed Service Guide. You MUST use the list provided by your regional Acer office to order FRU parts for repair and service of customer machines.

System Specifications	1
Features	1
System Block Diagram	4
Your Notebook Tour	5
Front View	5
Left View	7
Right View	7
Base View	8
Rear View	8
Indicators	9
TouchPad Basics	10
Using the Keyboard	11
Lock Keys and embedded numeric keypad	11
Windows Keys	12
Hot Keys	13
Special Keys	14
Hardware Specifications and Configurations	15
 System Utilities	 25
BIOS Setup Utility	25
Navigating the BIOS Utility	25
Information	26
Main	27
Security	28
Boot	31
Exit	32
BIOS Flash Utility	33
DOS Flash Utility	34
WinFlash Utility	35
Remove HDD/BIOS Password Utilities	36
Removing BIOS Passwords:	37
Miscellaneous Utilities	38
 Machine Disassembly and Replacement	 41
Disassembly Requirements	41
Related Information	41
Replacement Requirements	41
Pre-disassembly Instructions	42
Disassembly Process	43
External Module Disassembly Process	44
External Modules Disassembly Flowchart	44
Removing the Battery Pack	45
Removing the Dummy Card	46
Removing the Hard Disk Drive Module	47
Removing the DIMM Module	50
Removing the WLAN Module	52
Main Unit Disassembly Process	54
Main Unit Disassembly Flowchart	54
Removing the Keyboard	56
Removing the Upper Cover	58
Removing the Button Board	61
Removing the LCD Module	64
Removing the LED Board	66
Removing the Bluetooth Module	68

Table of Contents

Removing the I/O Board	69
Removing the Mainboard	71
Removing the CRT Board	73
Removing the Thermal Module	74
Removing the RTC Battery	75
Removing the Speaker Modules	76
LCD Module Disassembly Process	78
LCD Module Disassembly Flowchart	78
Removing the LCD Bezel	79
Removing the Camera Board	82
Removing the LCD Panel	83
Removing the LCD Brackets	85
Removing the FPC Cable	86
Removing the Antennas	87
LCD Reassembly Procedure	90
Replacing the Antennas	90
Replacing the FPC Cable	93
Replacing the LCD Brackets	94
Replacing the LCD Panel	95
Replacing the Camera Board	97
Replacing the LCD Bezel	98
Main Unit Reassembly Process	101
Replacing the Speaker Modules	101
Replacing the RTC Battery	103
Replacing the Thermal Module	104
Replacing the CRT Board	105
Replacing the Main Board	106
Replacing the I/O Card	108
Replacing the Bluetooth Module	110
Replacing the LED Board	111
Replacing the LCD Module	113
Replacing the Button Board	115
Replacing the Upper Cover	118
Replacing the Keyboard	121
Replacing the Wireless LAN Module	122
Replacing the DIMM Module	124
Replacing the Hard Disk Drive	126
Replacing the Battery	128
Replace the Dummy Card	129

Troubleshooting

131

Common Problems	131
Power On Issue	132
No Display Issue	133
Random Loss of BIOS Settings	134
LCD Failure	135
Built-In Keyboard Failure	136
TouchPad Failure	137
Internal Speaker Failure	138
Internal Microphone Failure	139
HDD Not Operating Correctly	140
USB Failure (Right up/down side)	141
Other Failures	141
Intermittent Problems	142
Undetermined Problems	142

Table of Contents

POST Code Reference Tables	143
Jumper and Connector Locations	147
Mainboard Top View	147
Mainboard Bottom View	148
Clearing Password Check and BIOS Recovery	149
Mainboard CMOS Discharge	149
BIOS Recovery by Crisis Disk	150
FRU (Field Replaceable Unit) List	151
Exploded Diagrams	151
Main Assembly	152
LCD Assembly	153
FRU List	154
Screw List	160
Model Definition and Configuration	161
Aspire 1810T/1410	161
Aspire One 752	219
Test Compatible Components	231
Aspire 1810T/1410	232
Aspire One 752	236
Online Support Information	241
Index	243

Table of Contents

System Specifications

Features

Below is a brief summary of the computer's many features:

Operating System

- Genuine Windows Vista ®
- Genuine Windows® 7 Home Premium 64-bit2 (AO752)
- Genuine Windows® 7 Home Basic 64-bit2 (AO752)
- Genuine Windows® 7 Starter 32-bit (AO752)

Platform

- Intel® Core™2 Solo processor*
- Intel® Celeron® mobile processor*
- Mobile Intel® GS45 Express Chipset
- Intel® Wireless WiFi Link 5100*
- Acer InviLink™ Nplify™ 802.11b/g/Draft-N*
- Acer InviLink™ 802.11b/g System Memory

AO752

- Intel® Celeron® processor 723/743 (1 MB L2 cache, 1.20/1.30 GHz, 800 MHz FSB, 10 W), supporting Intel® 64 architecture
- Intel® Celeron® processor SU2300 (1 MB L2 cache, 1.20 GHz, 800 MHz FSB,10 W), supporting Intel® 64 architecture

System memory

- Dual-channel DDR2 SDRAM support:
- Up to 2 GB of DDR2 667 MHz memory, upgradeable to 4 GB using two soDIMM modules (for 32-bit OS)

Display and graphics

- 16:9 aspect ratio
- 11.6" SD 1024 x 600
- 11.6" HD 1366 x 768
- Mobile Intel® GS45 Express Chipset

Storage subsystem

- 2.5" 9.5mm 160 GB or larger hard disk drive
- Multi-in-1 card reader

Audio subsystem

- High-definition audio support
- Two built-in stereo speakers
- MS-Sound compatible
- Built-in digital microphone
- S/PDIF (Sony/Philips Digital Interface) support for digital speakers

Communication

- Integrated Acer Crystal Eye webcam, supporting 0.3-megapixel resolution
- WLAN:
 - Intel® Wireless WiFi Link 5100
 - Acer InviLink™ Nplify™ 802.11b/g/Draft-N
 - Acer InviLink™ 802.11b/g
- LAN: Gigabit Ethernet; Wake-on-LAN ready
- WPAN: Bluetooth® 2.1+EDR
- WWAN: UMTS/HSPA at 850/900/1900/2100 MHz and quad-band GSM/GPRS/EDGE (850/900/1800/1900 MHz)*

Privacy control

- Kensington lock slot
- BIOS user, supervisor, HDD passwords

Dimensions and Weight)

- 285 (W) x 204 (D) x 22.1/30 (H) mm (11.22 x 8.03 x 0.87/1.18 inches)
- 1.35 kg (2.97 lbs.) with 6-cell battery pack

Power subsystem

- ACPI 3.0
- 62.16 W 5600 mAh
- 47.52 W 4400 mAh
- 3-pin 30 W AC adapter
- ENERGY STAR®

Input devices

- 84-/85-/88-key keyboard
- Touchpad pointing device with two buttons

I/O interface

- Multi-in-1 card reader (SD/MMC/MS/MS PRO/xD)
- USB 2.0 port
- HDMI™ port with HDCP support
- External display (VGA) port

-
- Headphones/speaker/line-out jack with S/PDIF support
 - Microphone-in jack
 - Ethernet (RJ-45) port
 - DC-in jack for AC adapter

Environment

- Temperature:
 - Operating: 5°C to 35°C
 - Non-operating: -20°C to 65°C
- Humidity (non-condensing):
 - Operating: 20% to 80%
 - Non-operating: 20% to 80%

NOTE: The specifications listed above are for reference only. The exact configuration of the PC depends on the model purchased.

System Block Diagram

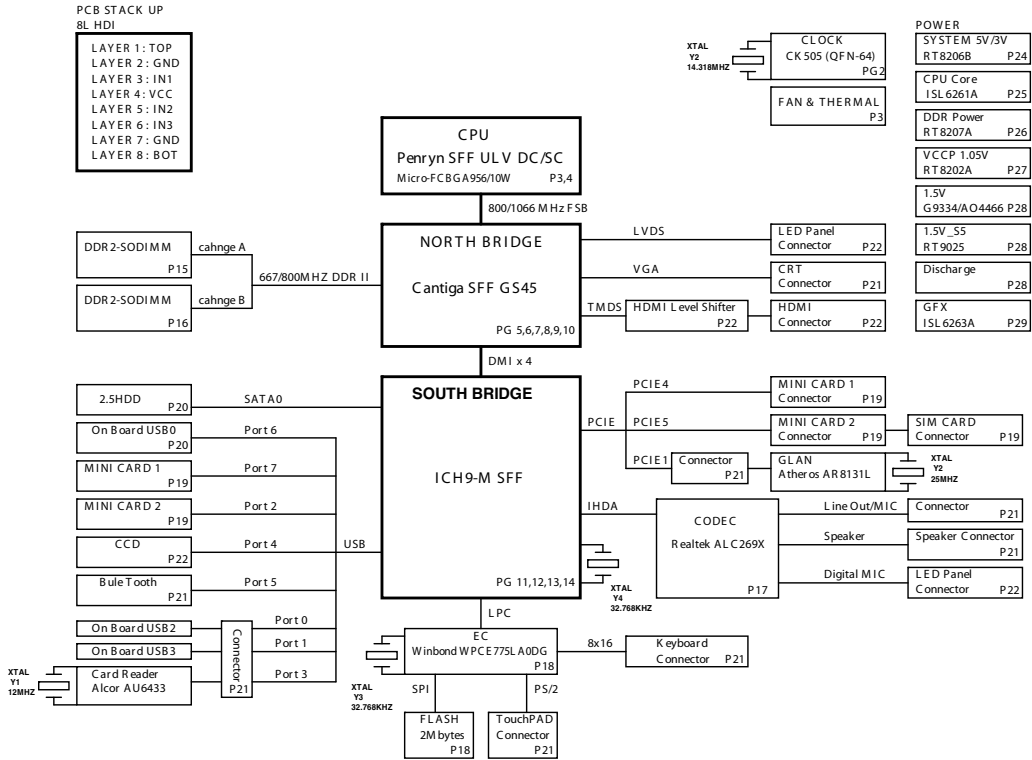









Your Notebook Tour

This section provides an overview of the features and functions of the notebook.

Front View





No.	Icon	Item	Description
1		Acer Crystal Eye webcam	Web camera for video communication.
2		Microphone	Internal microphone for sound recording.
3		Display screen	Also called Liquid-Crystal Display (LCD), displays computer output.
4		HDD	Indicates when the HDD is active.
		Num Lock	Lights up when the Num Lock is activated.
		Caps Lock	Lights up when the Caps Lock is activated.
5		Keyboard	For entering data into your computer
6		Touchpad	Touch-sensitive pointing device which functions like a computer mouse.

No.	Icon	Item	Description
7		Power	Indicates the computer's power status.
		Battery	Indicates the computer's battery status. 1. Charging: The light shows amber when the light is charging. 2. Fully charged: the light shows blue when in AC mode.
		Bluetooth	Indicates the status of Bluetooth communication (only for certain models)
		Communication indicator	Indicates the status of WLAN/3G communication.
8		Click buttons (left, and right)	The left and right buttons function like the left and right mouse buttons.
9		Palmrest	Comfortable support area for your hand when using the computer.
10		Power button/indicator	Turns the computer on and off.

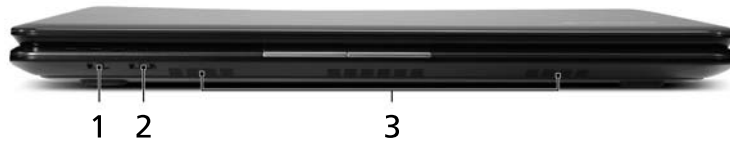

Closed Front View



No.	Icon	Item	Description
1		Bluetooth communication switch	Enables/disables the Bluetooth function.
2		3G/Wireless LAN communication switch	Enables/disables the 3G/Wireless LAN function.
3		Speakers	Left and right speakers deliver stereo audio output.

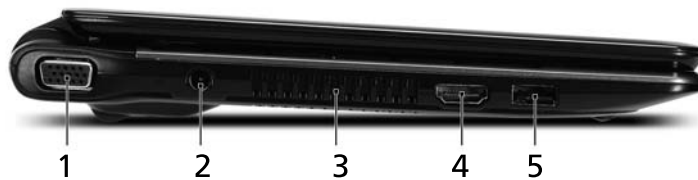





Left View



No.	Icon	Item	Description
1		External display (VGA) port	Connects to a display device (e.g. external, LCD monitor, LCD projector).
2		DC-in jack	Connects to an AC adapter.
3		Ventilation slots	Enable the computer to stay cool, even after prolonged use.
4	HDMI	HDMI port	Supports high definition digital video connections.
5		USB 2.0 port	Connects to USB 2.0 devices (e.g., USB mouse, USB camera).





Right View

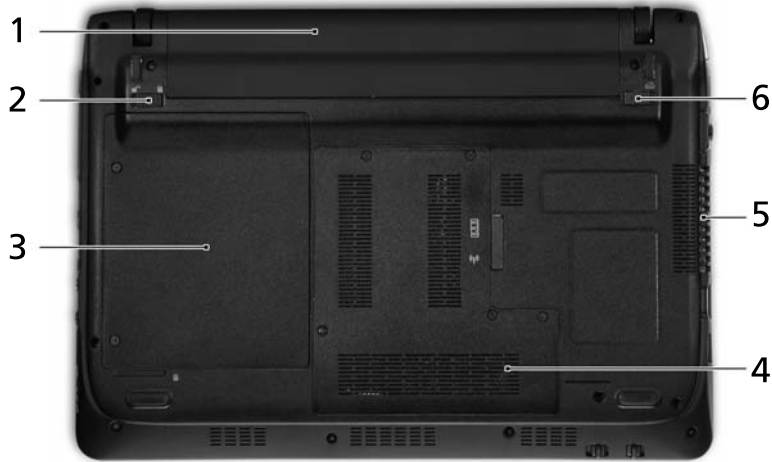

No.	Icon	Item	Description
1		Multi-in-one card reader	Accepts Secure Digital (SD), MultiMediaCard(MMC), Memory Stick(MS), Memory Stick PRO (MS PRO), xD-Picture Card (xD). Note: Push to remove/install the card. ONLY one card can operate at any given time.
2		Headphones/speaker/line-out jack with S/PDIF support.	Connects to audio line-out devices (e.g., speakers, headphones).
		Microphone-in jack	Accepts inputs from external microphones.
3		USB 2.0 port	Connects to USB 2.0 devices (e.g. USB mouse).
4		Kensington lock slot	Connects to a Kensington-compatible computer security lock.
5		Ethernet RJ-45) port	Connects to an Ethernet 10/100/1000-based network.

Base View



No.	Icon	Item	Description
1		Battery bay	Houses the computer's battery pack. Note: The battery shown is for reference only. Your PC may have a different battery depending on the model purchased.
2		Battery lock	Locks the battery in position
3		Hard disk bay	Houses the computer's hard disk (secured with screws)
4		Memory compartment	Houses the computer's main memory.
5		Ventilation slots and cooling fan	Enable the computer to stay cool, even after prolonged use. Note: Do not cover or obstruct the opening the fan.
6		Battery release latch	Releases the battery for removal.



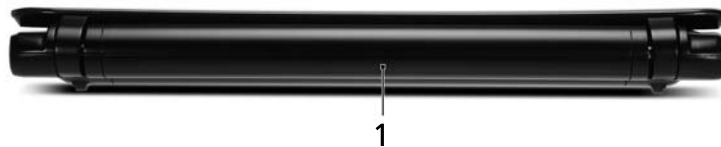



Rear View



No.	Icon	Item	Description
1		Battery bay	Houses the computer's battery pack. Note: The battery shown is for reference only. Your PC may have a different battery depending on the model purchased.

Indicators

The computer has several easy-to-read status indicators. The battery indicator is visible even when the computer cover is closed.

Icon	Function	Description
	Power	Indicates the computer is on or off.
	Battery	Indicates the computer's battery status.
	Bluetooth	Indicates the status of Bluetooth communication.
	Wireless LAN	Indicates the status of Wireless LAN communication.
	HDD	Indicates when the hard disk drive is active.
	Num Lock	Lights up when Num Lock is activated.
	Caps Lock	Lights up when Caps Lock is activated.

NOTE: 1. **Charging:** The battery light shows amber when the battery is charging. 2. **Fully charged:** The light shows green when in AC mode.

TouchPad Basics

The following items show you how to use the TouchPad:

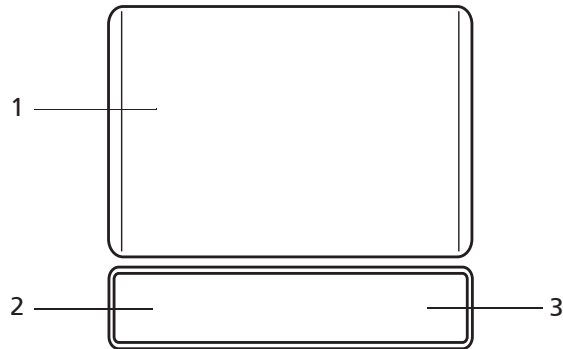

- Move your finger across the TouchPad (1) to move the cursor.
- Press the left (2) and right (3) buttons located beneath the TouchPad to perform selection and execution functions. These two buttons are similar to the left and right buttons on a mouse. Tapping on the TouchPad is the same as clicking the left button.

Function	Left Button (2)	Right Button (3)	Main TouchPad (1)
Execute	Quickly click twice.		Tap twice (at the same speed as double-clicking a mouse button).
Select	Click once.		Tap once.
Drag	Click and hold, then use finger on the TouchPad to drag the cursor.		Tap twice (at the same speed as double-clicking a mouse button); rest your finger on the TouchPad on the second tap and drag the cursor.
Access context menu		Click once.	

NOTE: When using the TouchPad, keep it - and your fingers - dry and clean. The TouchPad is sensitive to finger movement; hence, the lighter the touch, the better the response. Tapping too hard will not increase the TouchPad's responsiveness.

Using the Keyboard

Your computer has a close-to-full-sized keyboard and an embedded numeric keypad, separate cursor, lock, function and special keys.

Lock Keys and embedded numeric keypad

The keyboard has three lock keys which you can toggle on and off.













Lock key	Description
Caps Lock	When Caps Lock is on, all alphabetic characters typed are in uppercase.
Num Lock <Fn> + <F11>	When Num Lock is on, the embedded keypad is in numeric mode. The keys function as a calculator (complete with the arithmetic operators +, -, *, and /). Use this mode when you need to do a lot of numeric data entry. A better solution would be to connect an external keypad.
Scroll Lock <Fn> + <F12>	When Scroll Lock is on, the screen moves one line up or down when you press the up or down arrow keys respectively. Scroll Lock does not work with some applications.

The embedded numeric keypad functions like a desktop numeric keypad. It is indicated by small characters located on the upper right corner of the key caps. To simplify the keyboard legend, cursor-control key symbols are not printed on the keys.

Desired access	Num Lock on	Num Lock off
Number keys on embedded keypad	Type numbers in a normal manner.	
Cursor-control keys on embedded keypad	Hold <Shift> while using cursor-control keys.	Hold <Fn> while using cursor-control keys.
Main keyboard keys	Hold <Fn> while typing letters on embedded keypad.	Type the letters in a normal manner.

Windows Keys

The keyboard has two keys that perform Windows-specific functions.

Key	Description
 Windows key	<p>Pressed alone, this key has the same effect as clicking on the Windows Start button; it launches the Start menu. It can also be used with other keys to provide a variety of functions:</p> <ul style="list-style-type: none"><  >: Open or close the Start menu<  > + <D>: Display the desktop<  > + <E>: Open Windows Explore<  > + <F>: Search for a file or folder<  > + <L>: Lock your computer (if you are connected to a network domain), or switch users (if you're not connected to a network domain)<  > + <M>: Minimizes all windows<  > + <R>: Open the Run dialog box<  > + <U>: Open Ease of Access Center<  > + <BREAK>: Display the System Properties dialog box<  > + <TAB>: Cycle through programs on the task bar<CTRL> + <  > + <F>: Search for computers (if you are on a network) <p>Note: Depending on your edition of Windows XP, some shortcuts may not function as described.</p>
 Application key	This key has the same effect as clicking the right mouse button; it opens the application's context menu.

Hot Keys

The computer employs hotkeys or key combinations to access most of the computer's controls like screen brightness and volume output.

To activate hotkeys, press and hold the <Fn> key before pressing the other key in the hotkey combination.

Hotkey	Icon	Function	Description
<Fn> + <F2>		System Properties	Display the System Properties dialog box.
<Fn> + <F3>		Bluetooth communication switch	Enables/disables the Bluetooth function.
<Fn> + <F4>		Sleep	Puts the computer in Sleep mode.
<Fn> + <F5>		Display toggle	Switches display output between the display screen, external monitor (if connected) and both.
<Fn> + <F6>		Screen blank	Turns the display screen backlight off to save power. Press any key to return.
<Fn> + <F8>		Speaker toggle	Turns the speakers on and off.
<Fn> + <D>		Brightness up	Increases the screen brightness.
<Fn> + <Q>		Brightness down	Decreases the screen brightness.
<Fn> + <A>		Volume up	Increases the sound volume.
<Fn> + <V>		Volume down	Decreases the sound volume.

Special Keys

You can locate the Euro symbol and the US dollar sign at the upper-center and/or bottom-right of your keyboard.

The Euro symbol

1. Open a text editor or word processor.
2. Hold <Alt Gr> and then press the <5> key at the upper-center of the keyboard.

NOTE: Some fonts and software do not support the Euro symbol. See www.microsoft.com/typography/faq/faq12.htm for more information.

The US dollar sign

1. Open a text editor or word processor.
2. Hold <Shift> and then press the <4> key at the upper-center of the keyboard.

NOTE: This function varies according to the language settings.

Hardware Specifications and Configurations

Processor

Item	Specification
CPU type	Intel Penryn SFF (ULV)
CPU package	Micro-FCBGA 956 balls
Chipset	<ul style="list-style-type: none"> Intel Crestline GS45 SFF and ICH9M SFF
Features	<ul style="list-style-type: none"> Supports Intel architecture with Dynamic execution. On-die, primary 32-kB instruction cache and 32-kB write-back data cache. On-die, up to 3MB second level shared cache with advanced transfer cache architecture. Streaming SIMD Extensions 2 (SSE2), Streaming SIMD Extensions 3 (SSE3) Supplemental streaming SIMD extensions 3 (SSSE3) and SSE4.1 instruction sets. 800MHz source-synchronous front side bus (FSB) Advanced power management features including Enhanced Intel SpeedStep® Technology and dynamic FSB frequency switching. Digital thermal sensor (DTS). Execute disable bit support for enhanced security. Intel® Dynamic Acceleration Technology and Enhanced Multi-Threaded Thermal Management (EmTTM). Support enhanced Intel Virtualization Technology.

Processor Specifications

Item	CPU Speed	Cores	Mfg Tech	FSB Speed	Cache Size	Package	Power	Acer P/N
Core2Solo SU3500	1.4G	1	45nm	800 MHz	3M	BGA	5.5W	KC.35B0 1.SSU
Celeron 723	1.2G	TBC	45nm	800 MHz	1M	BGA	10W	KC.NB00 1.723
Core2Duo SU4100	TBC	2	45nm	800 MHz	2M	BGA	TBC	KC.41B0 1.DSU
Celeron 743	1.3G	1	45nm	800 MHz	1M	BGA	10W	KC.NB00 1.743
Celeron SU2300	1.2G	2	45nm	800 Mhz	1M	BGA	10W	KC.23B0 1.CSU

CPU Fan True Value Table

CPU Temperature (Celsius)	Fan Speed (RPM)	SPL Spec (dBA)
38	2400	23
43	3300	26
50	4000	29
56	4500	31

Throttling 50%: On= 90°C; OFF=80°C

OS shut down at 95°C; H/W shut down at 85°C

North Bridge Specifications

Item	Specification
Chipset	Intel Crestline GS45 SFF
Package	FCBGA 1363 balls
Features	<ul style="list-style-type: none">Processor hosts bus supports 667/800/1066MHz FSB support.Supports Dual Channel DDR2 SDRAM at 667/800MHzIntegrated SDRAM controller up to 8GB (2 SODIMM support)DMI x2 and DMI x4 for connection between GMCH and ICH9M

South Bridge Specifications

Item	Specification
Chipset	ICH9M SFF
Package	BGA 676 balls
Features	<ul style="list-style-type: none">Upstream accelerated Hub architecture interface for access to GMCH.PCI Express Base Specification, Revision 1.1 support.PCI 2.3 interface. (4 PCI Request/Grant pairs).ACPI Power Management Logi Support.Enhanced DMA controller, interrupt controller, timers functions.Integrated Serial ATA host controllers with independent DMA operation on six ports and AHCI support.USB 1.1 and USB 2.0 Host controllers.Supports Intel High Definition Audio (Intel HD Audio) Interface.Supports Intel® Matrix Storage Technology.Supports Intel® Active Management Technology.Low Pin Count (LPC) interface.6 PCIe ports.

System Memory

Item	Specification
Memory size	0MB (No on-board Memory)
DIMM socket number	2 sockets
Supports memory size per socket	2GB
Supports maximum memory size	4GB for 64bit OS (with two 2GB SO-DIMM)
Supports DIMM type	DDR2 Synchronous DRAM
Supports DIMM Speed	800/667 MHz

Video Specifications

Item	Specification
Chipset	Intel® GS45 Express Chipset
Package	<ul style="list-style-type: none"> 1329-ball FCBGA Size: 34mm x 34mm Ball pitch: 0.7mm
Features	<ul style="list-style-type: none"> Microsoft Windows Vista* Premium support with the highest level of Windows Aero* experience Blu-ray* logo capable HD video playback, with native support for Blu-ray* drives Great 3D graphics performance Intel® Clear Video Technology for excellent video quality

Hard Disk Drive Interface

Item	Specifications					
Vendor & Model Name	Hitachi HTS545050B 9A300	Hitachi HTS545032B 9A300	Hitachi HTS545025B 9A300	Hitachi HTS545016B 9A300	Hitachi HTS543225L 9A300	Hitachi HTS543216L9 SA00
Capacity (GB)	500	320	250	160	250	160
Bytes per sector	512					
Data heads	4	3	2	2	3	2
Drive Format						
Disks	2	2	1	1	2	1
Spindle speed (RPM)	5400					
Performance Specifications						
Buffer size	8MB					
Interface	SATA					
Internal transfer rate (Gbits/sec, max)	3GB/s maximum					1.5GB/s maximum
I/O data transfer rate (Mbytes/sec max)	875 Mbits/s maximum			845 Mbits/s maximum	775Mbits/s maximum	729Mbits/s maximum
DC Power Requirements						
Voltage	+5.0V ± 5%.					

Item	Specifications			
Vendor & Model Name	Seagate ST9160310AS	Seagate ST9250315AS	Seagate ST9320320AS	Seagate ST9500325AS
Capacity (GB)	160	250	320	500

Item	Specifications			
Bytes per sector	512	512	512	512
Data heads	2	2	4	4
Drive Format				
Disks	1	1	2	2
Spindle speed (RPM)	5400	5400	5400	5400
Performance Specifications				
Buffer size	8 MB	8 MB	8MB	8 MB
Interface	SATA	SATA	SATA	SATA
Internal transfer rate (Mbits/sec, max)	830	1175	830	1175
I/O data transfer rate (Mbytes/sec max)	875 Mbits/s maximum			845 Mbits/s maximum
DC Power Requirements				
Voltage	+5.0V ± 5%.			

Item	Specifications			
Vendor & Model Name	Toshiba MK1655GSX	Toshiba MK2555GSX	Toshiba MK3255GSX	Toshiba MK5055GSX
Capacity (GB)	160	250	320	500
Bytes per sector	512	512	512	512
Data heads	2	2	4	4
Drive Format				
Disks	1	1	2	2
Spindle speed (RPM)	5400			
Performance Specifications				
Buffer size	8MB			
Interface	SATA			
Internal transfer rate (Mbits/sec, max)	363 ~ 952 typical			
I/O data transfer rate (Mbytes/sec max)	300			
DC Power Requirements				
Voltage	5V ±5%			

Item	Specifications			
Vendor & Model Name	Western Digital WD1600BEVT-22ZCT0	Western Digital WD2500BEVT-22ZCT0	Western Digital WD3200BEVT-22ZCT0	Western Digital WD5000BEVT-22ZAT0

Item	Specifications			
Capacity (GB)	160	250	320	500
Bytes per sector	512			
Data heads	2	4	3	4
Drive Format				
Disks	1	2	2	2
Spindle speed (RPM)	5400			
Performance Specifications				
Buffer size	8 MB			
Interface	SATA			
Internal transfer rate (Mbits/sec, max)	N/A			
I/O data transfer rate (Mbytes/sec max)	300			
DC Power Requirements				
Voltage	5V ±5%			

BIOS

Item	Specification
BIOS vendor	Insyde
BIOS Version	3.5
BIOS Features	<ul style="list-style-type: none"> Flash ROM 1MB Support ISIPP Support Acer UI Support multi-boot Suspend to RAM (S3) / Disk (S4) Various hot-keys for system control Support SMBUS 2.0, PCI2.3 ACPI 2.0 compliance with Intel Speed Step Support C1e, C2, C3 and S3, S4,S5 for mobile CPU. DMI utility for BIOS serial number configuration/asset tag Support PXE Support Y2K solution Support Win Flash Wake on LAN from S3 Wake on LAN form S4 in AC mode System information

LCD 11.6"

Item	Specifications			
Vendor/model name	AUO B11.6XW02	CMO N116B6-L02	LG LP116WH1-TLA1	Samsung LTN116AT01-A01
Screen Diagonal (mm)	11.6"	11.6"	11.6"	11.6"
Display Area (mm)	256.125 x 144 (11.6" diagonal)			
Display resolution (pixels)	1366 x 768	1366 x 768	1366 x 768	1366 x 768

Item	Specifications			
Pixel Pitch (mm)	0.1875 x 0.1875	0.1875 x 0.1875	0.1875 x 0.1875	0.2265(H) x 0.2265(V)
Typical White Luminance (cd/m ²) also called Brightness	200	200	200	200
Contrast Ratio	500:1	500:1	500:1	500:1
Response Time (Optical Rise Time/Fall Time) msec	8	7	8	8
Typical Power Consumption (watt)	4.0	4	4	2.85
Weight (without inverter)	255g	225g	255g	255g
Physical Size (mm)	268 (L) x 161.5 (W)	268 x 161.5 x 5	268.0 x 161.5	268.0 x 161.5
Electrical Interface	LVDS	LVDS	LVDS	LVDS
Viewing Angle (degree) Horizontal (Right) / (Left) Vertical (Upper) / (Lower)	45/45 20/40	45/45 20/45	45/45 20/40	

Bluetooth

Item	Specification
Bluetooth Controller	Bluetooth module Foxconn Bluetooth BRM 2046 BT2.1 (T60H928.33) F/W:861
Features	<ul style="list-style-type: none"> Fully Qualified Bluetooth v2.1 with Class 2 specification RF output power. Enhanced Data Rate (EDR) compliant. Full Piconet and Scatternet operation. Integrated PIFA Antenna with better RF performance. USB 2.0 compliant interface. F/W upgradable via Flash downloads. Very low power consumption. Support Coexistence with Intel WCS (Wireless Coexistence System) & AFH (Adaptive Frequency Hopping).

Audio Codec and Amplifier

Item	Specification
Audio Controller	Realtek ALC269X
Features	<ul style="list-style-type: none"> Headphone-out with S/PDF, Line-In and Microphone-In. 2 stereo ADCs support 16/20/24-bit PCM format recording simultaneously.

LAN Interface

Item	Specification
LAN Chipset	ATHEROS AR8131L
Package	48pin QFN

Item	Specification
Features	<ul style="list-style-type: none"> The AR8131L is the third generation Gigabit Ethernet (GbE) controller solution from Atheros. It is an ultra-high performance, ultralow cost, and ultra-low power fully integrated 10/100/1000 Mbps NIC/LOM Ethernet controller perfectly suited for both PC and embedded applications. The AR8131L combines a 10/100/1000BASE-T GbE media access controller (MAC), a triplespeed Ethernet physical layer transceiver (PHY), and a PCI Express bus interface. The AR8131L is compliant with IEEE 802.3u specification for 10/100 Mbps Ethernet and IEEE 802.3ab specification for 1000 Mbps Ethernet. The AR8131L device combines pulse shaping, Tx/Rx PCS, echo canceller, NEXT canceller, equalizer, decoder, and timing recovery functions to deliver robust signal performance in noisy environments. The AR8131L GbE controller supports checksum offload features for IP, TCP, and UDP,

Keyboard

Item	Specification
Type	ACER NT1T JM11 Black
Total number of keypads	86/87/91
Windows logo key	Yes
Internal & external keyboard work simultaneously	Yes
Features	<ul style="list-style-type: none"> Supports application keys for Windows XP version

Media Card Reader

Item	Specification
Chipset	Alcor AU6433
Features	<ul style="list-style-type: none"> Fully compatible with USB2.0 High Speed and backward compatible with USB1.1 specifications Supports multiple flash card interfaces, including SD/MMC/xD/MS. Supports single LUN 48-pin LQFP

Camera

Item	Specifications		
Vendor and model	Lite On Model No. 09P2SF001	Suyin Model No.CN0316-S30C-OV06-1	Chicony CNF9011
Type	640 x 480 VGA (0.3M) size 1/6" CMOS	640 x 480 VGA (0.3M) size 1/6" CMOS	640 x 480 VGA (0.3M) size 1/6" CMOS
Interface	USB 2.0 high speed interface	USB 2.0 high speed interface	USB 2.0 high speed interface
Optical aperture	F2.4	F2.4	F2.4 ± 5%
Focusing range	18.65~Infinite, focus on 48cm	40 cm to Infinity	17.4cm ~ Infinity, focus on 40cm

Item	Specifications		
Dimensions (L x W x H mm)	65 x 8 x 3.84 +/- 0.25 (H) mm	65X 7.9X 3.8+/-0.2mm	64.8±0.3 X 7.9±0.1 X 3.64+0.15/-0.25 mm
Sensor type	CMOS (OV9710)	CMOS image sensor	CMOS
Pixel resolution	640x480	640X480	640 x 480
Pixel size	TBD	3.6um X3.6um	TBD
Image size	TBD	2.36mm(H) X1.76mm(V)	TBD

Wireless LAN

Item	Specification	Specification	Specification	Specification
Type	Atheros HB93 1x2 BGN	Intel MM#903341	Intel MM#897072	Intel MM#895373
802.11g				
Radio Technology	IEEE 802.11g standard compliant			
Operating Frequency	2412 ~ 2484MHz ISM band			
Modulation Schemes	OFDM, DQPSK, DBPSK and CCK			
Channel Numbers	<ul style="list-style-type: none"> 1---11 channels for active channels 12---13 channels for passive channels 			
Data Rate	54Mbps with fall back rates of 48, 36, 24, 18, 12, 9 and 6Mbps			
Media Access Protocol	CSMA/CA with ACK			
Transmitter Output Power	Typical 13.5 dBm for 54Mbps			
802.11b				
Radio Technology	IEEE 802.11b Direct Sequence Spread Spectrum			
Operating Frequency	2412 ~ 2484MHz ISM band			
Modulation Schemes	DQPSK, DBPSK and CCK			
Channel Number	<ul style="list-style-type: none"> 1---11 channels for active channels 12---13 channels for passive channels 			
Data Rate	11Mbps with fall back rates of 5.5, 2, and 1Mbps			
Media Access Protocol	CSMA/CA with ACK			
Transmitter Output Power	18dBm typically			

Battery

Item	Specification
	6 Cell
Vendor & model name	SANYO UM-2009E Li-Ion 3S2P PANASONIC UM-2009E Li-Ion 3S2P SIMPLO UM-2009E Li-Ion 3S2P SIMPLO UM-2009E Li-Ion 3S2P
Battery Type	Li-ion

Item	Specification
	6 Cell
Pack capacity	SANYO 6 cell 4400mAh SANYO 6 cell 5600mAh PANASONIC 6 cell 4400mAh PANASONIC 6 cell 5800mAh SAMSUNG 6 cell 4400mAh SAMSUNG 6 cell 5600mAh LGC 6 cell 5600mAh
Number of battery cell	6
Package configuration	3 cells in series, 2 series in parallel

System Utilities

BIOS Setup Utility

The BIOS Setup Utility is a hardware configuration program built into your computer's BIOS (Basic Input/Output System).

Your computer is already properly configured and optimized, and you do not need to run this utility. However, if you encounter configuration problems, you may need to run Setup. Please also refer to Chapter 4 Troubleshooting when a problem arises.

To activate the BIOS Utility, press **F2** during POST (when **Press <F2> to enter Setup** message is prompted on the bottom of screen).

Press **F2** to enter setup. The default parameter of F12 Boot Menu is set to "disabled". If you want to change boot device without entering BIOS Setup Utility, please set the parameter to "enabled".

Press **<F12>** during POST to enter multi-boot menu. In this menu, user can change boot device without entering BIOS SETUP Utility.

Navigating the BIOS Utility

There are six menu options: Information, Main, Advanced, Security, Power, Boot, and Exit.

Follow these instructions:

- To choose a menu, use the left and right arrow keys.
- To choose an item, use the up and down arrow keys.
- To change the value of a parameter, press **F5** or **F6**.
- A plus sign (+) indicates the item has sub-items. Press **Enter** to expand this item.
- Press **Esc** while you are in any of the menu options to go to the Exit menu.
- In any menu, you can load default settings by pressing **F9**. You can also press **F10** to save any changes made and exit the BIOS Setup Utility.

NOTE: You can change the value of a parameter if it is enclosed in square brackets. Navigation keys for a particular menu are shown on the bottom of the screen. Help for parameters are found in the Item Specific Help part of the screen. Read this carefully when making changes to parameter values. **Please note that system information is subject to different models.**

Information

The Information screen displays a summary of your computer hardware information.

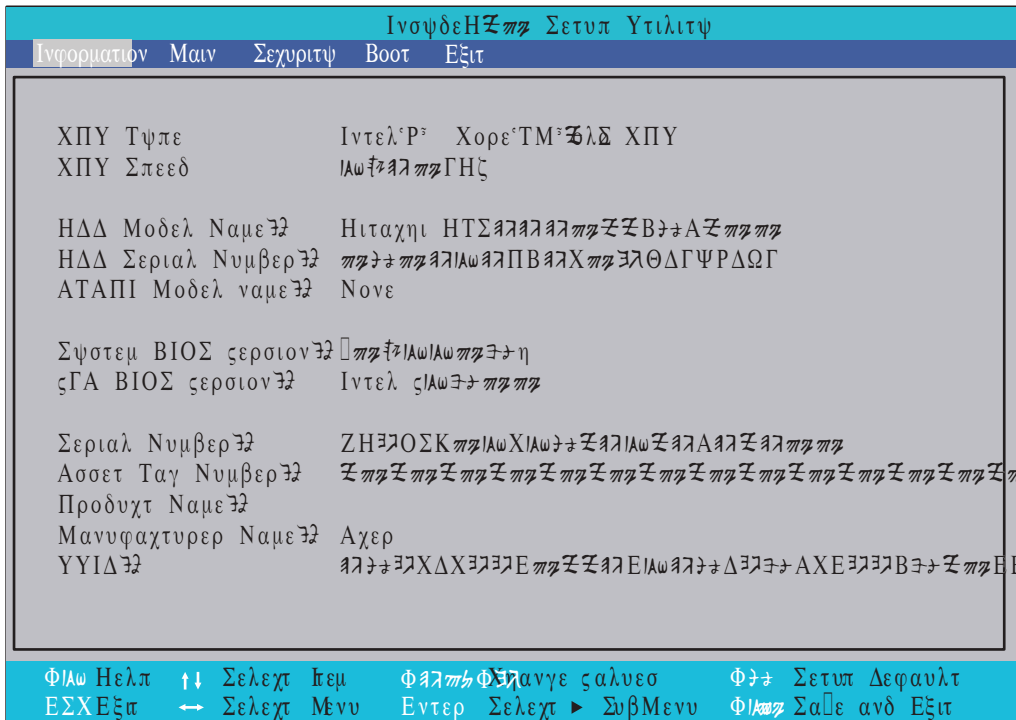

NOTE: The system information is subject to variance across different models.

Parameter	Description
CPU Type	This field shows the CPU type and speed of the system.
CPU Speed	This field shows the speed of the CPU.
HDD Model Name	This field shows the model name of HDD installed on primary IDE master.
HDD Serial Number	This field displays the serial number of HDD installed on primary IDE master.
ATAPI Model Name	This field displays the model name of the installed ODD drive.
System BIOS Version	Displays system BIOS version.
VGA BIOS Version	This field displays the VGA firmware version of the system.
Serial Number	This field displays the serial number of this unit.
Asset Tag Number	This field displays the asset tag number of the system.
Product Name	This field shows product name of the system.
Manufacturer Name	This field displays the manufacturer of this system.
UUID Number	Universally Unique Identifier (UUID) is an identifier standard used in software construction, standardized by the Open Software Foundation (OSF) as part of the Distributed Computing Environment (DCE).

Main

The Main screen allows the user to set the system time and date as well as enable and disable boot option and recovery.

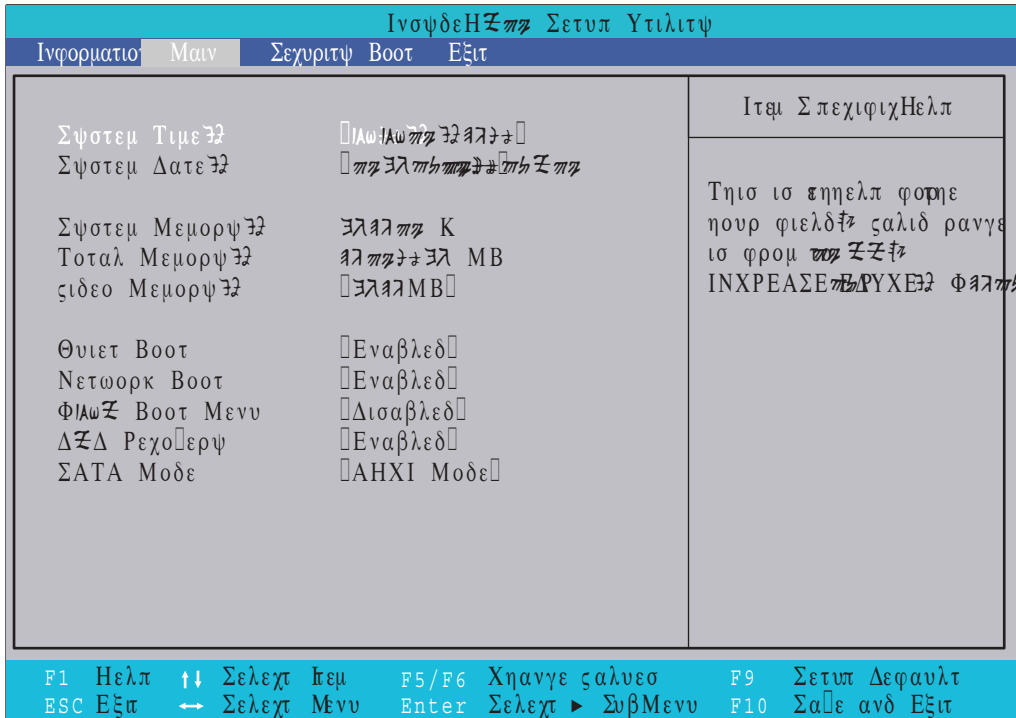

NOTE: The screen above is for your reference only. Actual values may differ.

The table below describes the parameters in this screen. Settings in **boldface** are the default and suggested parameter settings.

Parameter	Description	Format/Option
System Time	Sets the system time. The hours are displayed with 24-hour format.	Format: HH:MM:SS (hour:minute:second)
System Date	Sets the system date.	Format MM/DD/YYYY (month/day/year)
System Memory	This field reports system memory size.	N/A
Total Memory	This field reports the memory size of the system. Memory size is fixed to 4096MB.	N/A
Video Memory	Shows the video memory size. VGA Memory size=32 MB	N/A
Quiet Boot	This will hide POST messages while booting.	Option: Enabled or Disabled
Network Boot	Enables, disables the system boot from LAN (remote server).	Option: Enabled or Disabled
F12 Boot Menu	Enables, disables Boot Menu during POST.	Option: Enabled or Enabled
D2D Recovery	Enables, disables D2D Recovery function. The function allows the user to create a hidden partition on hard disc drive to store operation system and restore the system to factory defaults.	Option: Enabled or Disabled
SATA Mode	Control the mode in which the SATA controller should operate.	Option: AHCI or IDE

Security

The Security screen contains parameters that help safeguard and protect your computer from unauthorized use.

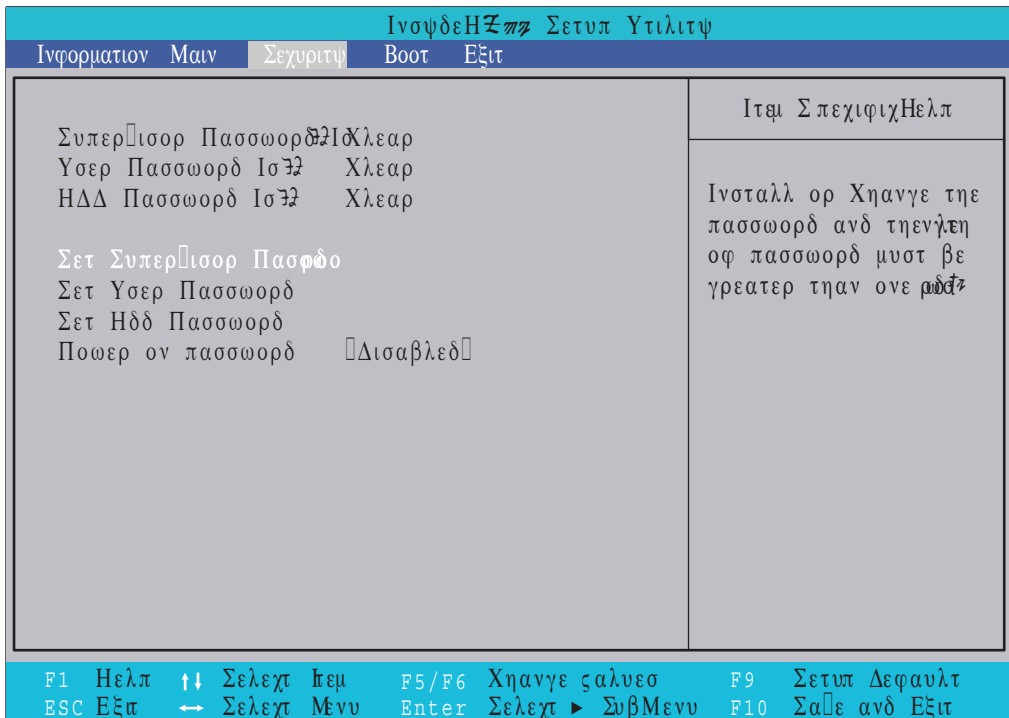

The table below describes the parameters in this screen. Settings in **boldface** are the default and suggested parameter settings.

Parameter	Description	Option
Supervisor Password Is	Shows the setting of the Supervisor password	Clear or Set
User Password Is	Shows the setting of the user password.	Clear or Set
Set Supervisor Password	Press Enter to set the supervisor password. When set, this password protects the BIOS Setup Utility from unauthorized access. The user can not either enter the Setup menu nor change the value of parameters.	
Set User Password	Press Enter to set the user password. When user password is set, this password protects the BIOS Setup Utility from unauthorized access. The user can enter Setup menu only and does not have right to change the value of parameters.	
Set HDD Password	Enter HDD password.	
Power on password	Defines whether a password is required or not while the events defined in this group happened. The following sub-options are all requires the Supervisor password for changes and should be grayed out if the user password was used to enter setup.	Enabled or Disabled

NOTE: When you are prompted to enter a password, you have three tries before the system halts. Don't forget the password. If you forget the password, you may have to reset the computer.

Setting a Password

Follow these steps as you set the user or the supervisor password:

1. Use the ↑ and ↓ keys to highlight the Set Supervisor Password parameter and press the **Enter** key. The Set Supervisor Password box appears:

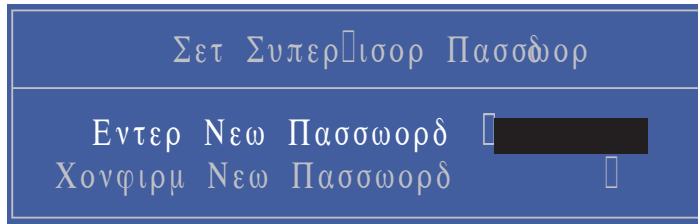

2. Type a password in the “Enter New Password” field. The password length can not exceeds 8 alphanumeric characters (A-Z, a-z, 0-9, not case sensitive). Retype the password in the “Confirm New Password” field.

IMPORTANT: Be very careful when typing your password because the characters do not appear on the screen.

3. Press **Enter**. After setting the password, the computer sets the User Password parameter to “Set”.
4. If desired, you can opt to enable the Password on boot parameter.
5. When you are done, press F10 to save the changes and exit the BIOS Setup Utility.

Removing a Password

Follow these steps:

1. Use the ↑ and ↓ keys to highlight the Set Supervisor Password parameter and press the **Enter** key. The Set Password box appears:



2. Type the current password in the Enter Current Password field and press **Enter**.
3. Press **Enter** twice **without** typing anything in the Enter New Password and Confirm New Password fields. The computer then sets the Supervisor Password parameter to “Clear”.
4. When you have changed the settings, press u to save the changes and exit the BIOS Setup Utility.

Changing a Password

1. Use the ↑ and ↓ keys to highlight the Set Supervisor Password parameter and press the **Enter** key. The Set Password box appears.



2. Type the current password in the Enter Current Password field and press **Enter**.
3. Type a password in the Enter New Password field. Retype the password in the Confirm New Password field.
4. Press **Enter**. After setting the password, the computer sets the User Password parameter to "Set".
5. If desired, you can enable the Password on boot parameter.
6. When you are done, press **F10** to save the changes and exit the BIOS Setup Utility.

If the verification is OK, the screen will display as following.

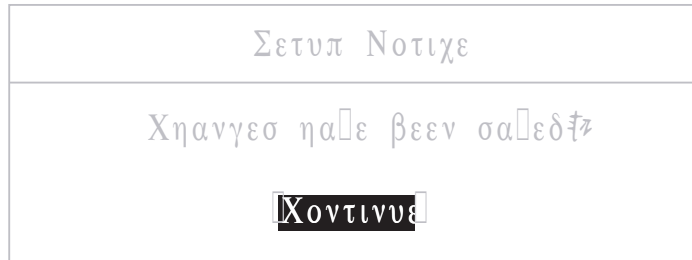

The password setting is complete after the user presses **Enter**.

If the current password entered does not match the actual current password, the screen will show you the Setup Warning.



If the new password and confirm new password strings do not match, the screen displays the following message.

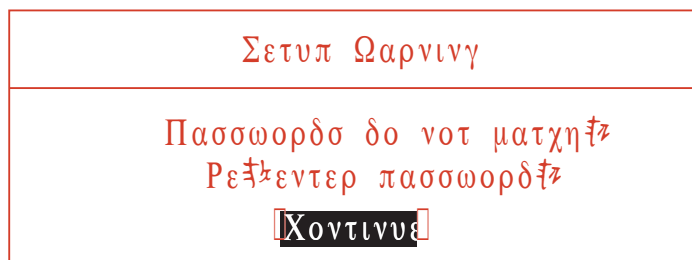

Boot

This menu allows the user to decide the order of boot devices to load the operating system. Bootable devices includes the USB diskette drives, the onboard hard disk drive and the DVD drive in the module bay.

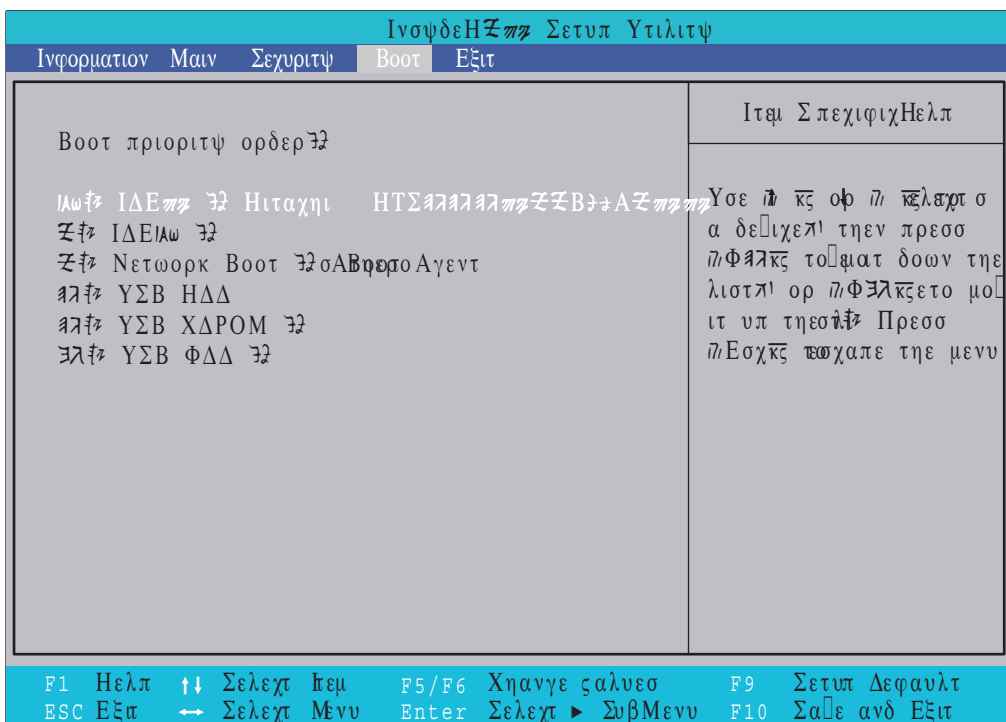

Exit

The Exit screen allows you to save or discard any changes you made and quit the BIOS Utility.

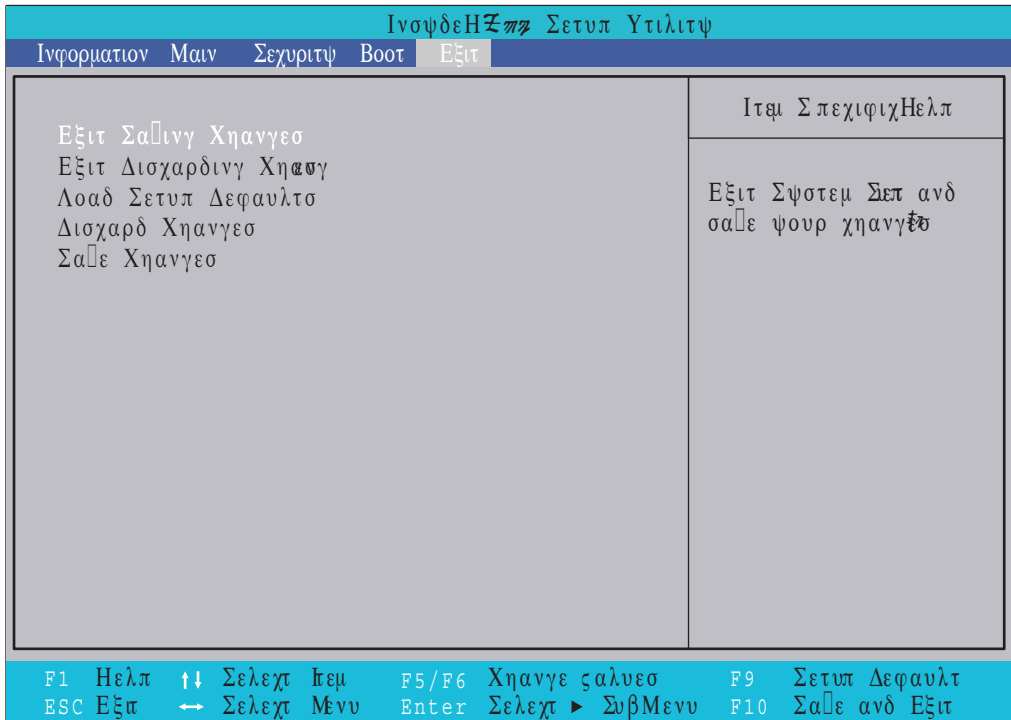

The table below describes the parameters in this screen.

Parameter	Description
Exit Saving Changes	Exit System Setup and save your changes to CMOS.
Exit Discarding Changes	Exit utility without saving setup data to CMOS.
Load Setup Default	Load default values for all SETUP item.
Discard Changes	Load previous values from CMOS for all SETUP items.
Save Changes	Save Setup Data to CMOS.

BIOS Flash Utility

The BIOS flash memory update is required for the following conditions:

- New versions of system programs
- New features or options
- Restore a BIOS when it becomes corrupted.

DOS Flash Utility

Perform the following steps to use the DOS Flash Utility:

1. Press F2 during boot to enter the Setup Menu.
2. Select **Boot Menu** to modify the boot priority order, for example, if using USB HDD to Update BIOS, move USB HDD to position 1.

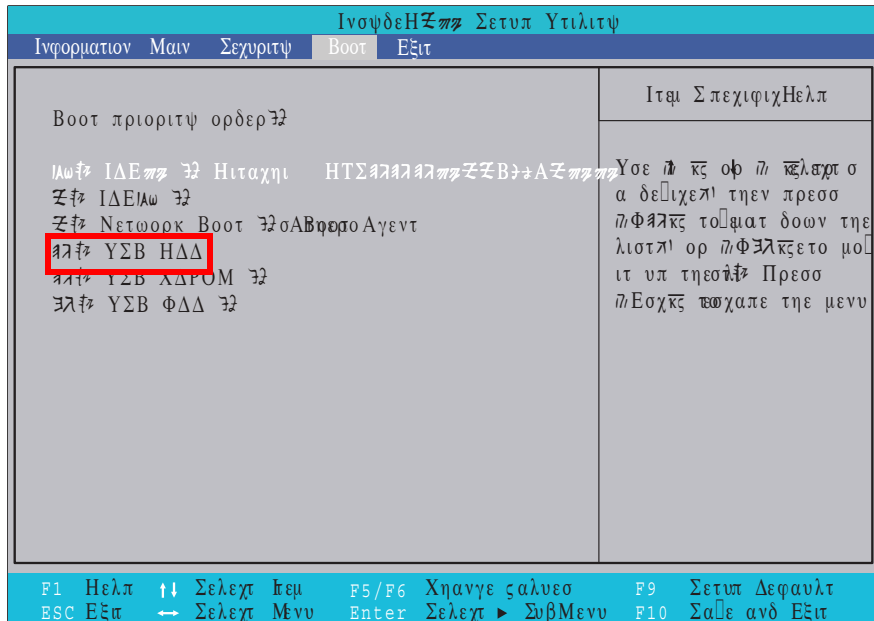

3. Execute the **FLASH.BAT** batch file to update BIOS. Or enter **C:\Flash it bios ver.f/d/c**
The flash process begins as shown.



4. In flash BIOS, the message **Please do not remove AC Power Source** displays.
NOTE: If the AC power is not connected, the following message displays.



Plug in the AC power to continue.

5. Flash is complete when the message Flash programming complete displays.

WinFlash Utility

Perform the following steps to use the WinFlash Utility:

1. Double click the WinFlash executable.
2. Click **OK** to begin the update. A progress screen displays.



3. When the process is complete, close all programs and applications and reboot the system.

Remove HDD/BIOS Password Utilities

This section provide you with removing HDD/BIOS method:

Remove HDD Password:

When the user keys in the wrong password three times, the system reports the following error code to user.

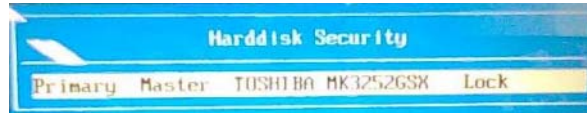

To unlock the HDD password, perform the following steps:

1. Press **Enter** to display the Select Item screen.

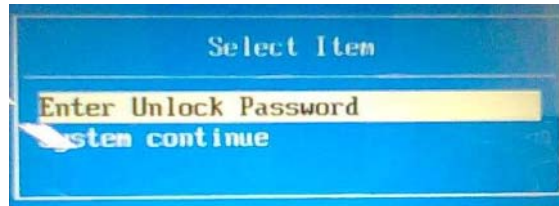

2. Select **Enter Unlock Password** and press **Enter**.

An Unlock Password displays.



3. Make a note of the key, **76943488** in the example.
4. Boot up the system to a removable bootable drive containing DOS and the UnlockHD.EXE program and open a DOS prompt. For instructions on changing boot priority see "Boot" on page 31.
5. From the DOS prompt, enter the **UnlockHD.EXE** command and input the key to create an unlock code. Make a note of the result, for example **46548274**.
6. Reboot to the hard disk and wait for the error code to reappear.
7. Press **Enter** to display the Select Item screen.
8. Select **Enter Unlock Password** and press **Enter**.
9. Enter the unlock code generated by UnlockHD.EXE.
10. Save and exit the BIOS to complete the process.

Removing BIOS Passwords:

If you key in the wrong Supervisor Password three times, System Disabled displays on the screen. See the image below.

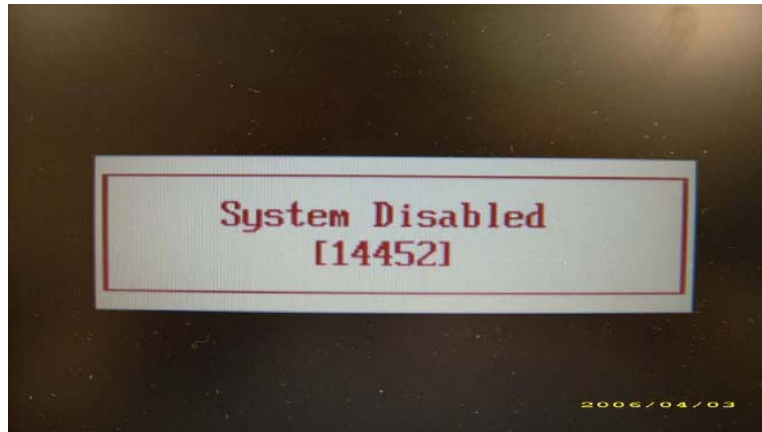

To reset the BIOS password, run clnpwd.exe as follows:

1. From a DOS prompt, Execute **clnpwd.exe**

```
d:\Clnpwd>clnpwd
ACER Clean Password Utility V1.00
Press 1 or 2 to clean any password shown as below
    1.User Password
    2.Supervisor Password

Clean User Password Successfully!
```

2. Press 1 or 2 to clean the desired password shown on the screen.

The onscreen message determines whether the function is successful or not.

Miscellaneous Utilities

Using Boot Sequence Selector

Boot Sequence Selector allows the boot order to be changes without accessing the BIOS. To use Boot Sequence Selector, perform the following steps:

1. Enter into DOS.
2. Execute BS.exe to display the usage screen.

```
d:\B00TSEQ>bs
*** Boot Sequence Selector Version 0.03 ***
Create by Rockwell Chuang 10/01/2005.
Usage:
      BS [ 1 | 2 | 3 | 4 ]
BS 1 : [ Floppy ] => [ HardDisk ] => [ CD-ROM ] => [ LAN   ]
BS 2 : [ HardDisk ] => [ CD-ROM ] => [ LAN   ] => [ Floppy ]
BS 3 : [ CD-ROM ] => [ HardDisk ] => [ LAN   ] => [ Floppy ]
BS 4 : [ LAN   ] => [ Floppy ] => [ HardDisk ] => [ CD-ROM ]
d:\B00TSEQ>
```

3. Select the desired boot sequence by entering the corresponding sequence, for example, enter BS2 to change the boot sequence to HDD|CD ROM|LAN|Floppy.

Using DMITools

The DMI (Desktop Management Interface) Tool copies BIOS information to eeprom to be used in the DMI pool for hardware management.

When the BIOS displays **Verifying DMI pool data** it is checking the table correlates with the hardware before sending to the operating system (Windows, etc.).

To update the DMI Pool, perform the following steps:

1. Enter into DOS.
2. Execute **dmitools.exe**. The following messages show dmitools usage:

```
*** Compal DMI String R/W Utility Ver1.40 for 2006/03/14 ***

Usage:

DMITOOLS [ /R | /WP | /WS | /WU ] [ STRING ]

[R]   : Read DMI Information from Memory
[WM]  : Write Manufacturer Name to EEPROM. (Max.= 16 characters)
[WP]  : Write Product Name to EEPROM.      (Max.= 16 characters)
[WS]  : Write Serial Number to EEPROM     (Max.= 22 characters)
[WU]  : Write UUID to EEPROM.             (Ignore String   )
[WA]  : Write Asset Tag to EEPROM.        (Max.= 32 characters)
```

IMPORTANT:The following write examples (2 to 5) require a system reboot to take effect

Example 1: Read DMI Information from Memory

Input:

```
dmitools /r
```

Output:

```
Manufacturer (Type1, Offset04h): Acer  
Product Name (Type1, Offset05h): Aspire one xxxxx  
Serial Number (Type1, Offset07h): 01234567890123456789  
UUID String (Type1, Offset08h): xxxxxxxx-xxxx-xxxx-xxxx-xxxxxxxxxxxx  
Asset Tag (Type3, Offset04h): Acer Asstag
```

Example 2: Write Product Name to EEPROM

Input:

```
dmitools /wp Acer
```

Example 3: Write Serial Number to EEPROM

Input:

```
dmitools /ws 01234567890123456789
```

Example 4: Write UUID to EEPROM

Input:

```
dmitools /wu
```

Example 5: Write Asset Tag to EEPROM

Input:

```
dmitools /wa Acer Asstag
```

Using the LAN MAC Utility

Perform the following steps to write MAC information to eeprom:

1. Use a text editor, for example Notepad, to edit the MAC.CFG file as shown:

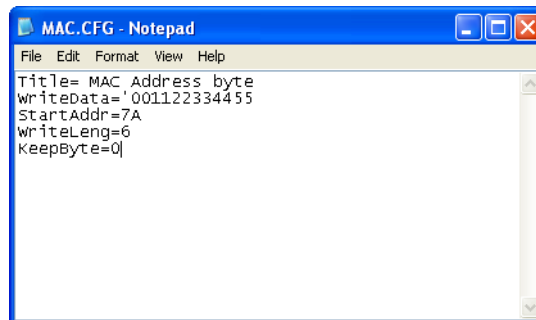

- WriteData= '001122334455' <----- MAC value
 - StartAddr=7A <----- MAC address
 - WriteLeng=6 <----- MAC value length
 - KeepByte=0 <----- can be any value
2. Boot into DOS.
 3. Execute **MAC.BAT** to write MAC information to eeprom.

Machine Disassembly and Replacement

This chapter contains step-by-step procedures on how to disassemble the notebook computer for maintenance and troubleshooting.

Disassembly Requirements

To disassemble the computer, you need the following tools:

- Wrist grounding strap and conductive mat for preventing electrostatic discharge
- Flat screwdriver
- Philips screwdriver
- Plastic flat screwdriver
- Plastic tweezers

NOTE: The screws for the different components vary in size. During the disassembly process, group the screws with the corresponding components to avoid mismatch when putting back the components.

Related Information

The product previews seen in the disassembly procedures may not represent the final product color or configuration.

IMPORTANT: Cable paths and positioning may not represent the actual model. During the removal and replacement of components, ensure all available cable channels and clips are used and that the cables are replaced in the same position.

Replacement Requirements

NOTE: Cabling and components require adhesive to be applied during the replacement and reassembly process.

NOTE: During manufacture a cyanoacrylate glue is used provided by Holdtite Adhesives LTD. This is not a specified requirement. The reassembler is free to select an alternative appropriate adhesive.

Pre-disassembly Instructions

Before proceeding with the disassembly procedure, make sure that you do the following:

1. Turn off the power to the system and all peripherals.
2. Unplug the AC adapter and all power and signal cables from the system.



3. Place the system on a flat, stable surface.

Disassembly Process

The disassembly process is divided into the following sections:

- External components disassembly
- Main unit disassembly
- LCD module disassembly

The flowcharts provided in the succeeding disassembly sections illustrate the entire disassembly sequence. Observe the order of the sequence to avoid damage to any of the hardware components. For example, if you want to remove the Mainboard, you must first remove the Keyboard, and LCD Module then disassemble the inside assembly frame in that order.

Main Screw List

Screw	Quantity	Acer Part Number
M2-0.4*2-I(BNI)(NYLOK)(7,0.6)IRON	2	86.W4107.002
M2.0X2.5-I(BNI)(NYLOK) IRON	4	86.SA107.002
M2*3.0 I (BNI,NYLOK)IRON	18	86.SA107.001
M2*5-I(BZN)(NYLOK)	26	86.TG607.004

External Module Disassembly Process

NOTE: The product previews seen in the disassembly procedures may not represent the final product color or configuration.

Screw List

Step	Screw	Quantity	Part No.
WAN Module Disassembly	2*3	1	86.SA107.001

External Modules Disassembly Flowchart

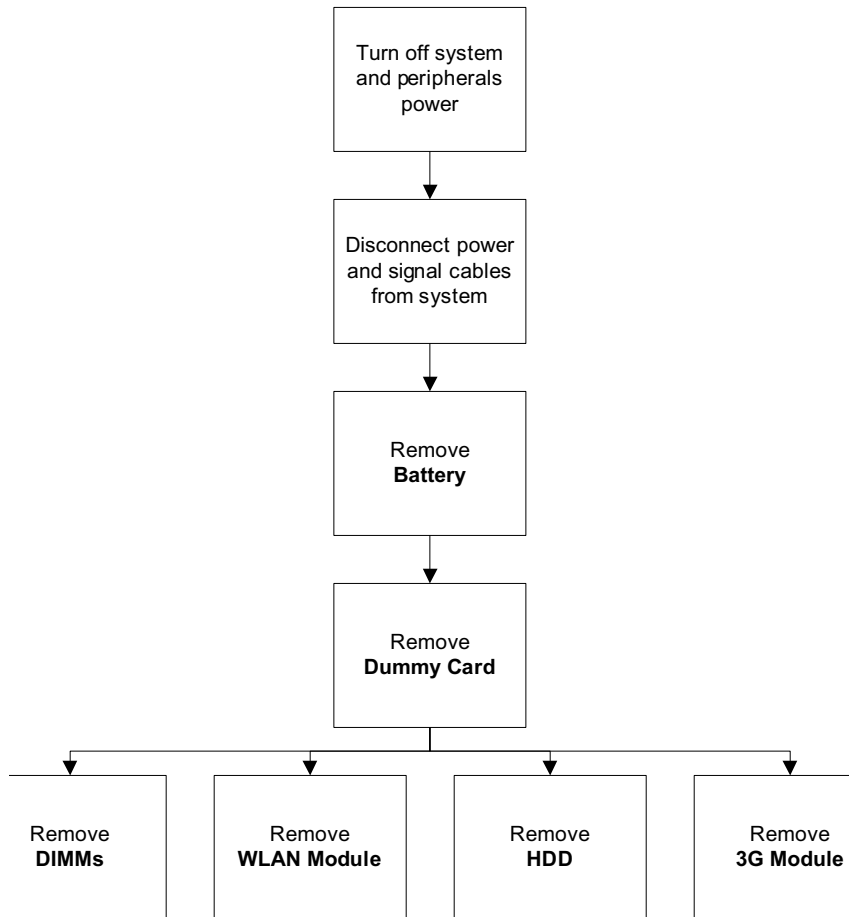

Removing the Battery Pack

1. Turn the computer over.
2. Slide the battery lock/unlock latch to the unlock position.



3. Slide and hold the battery release latch to the release position (1), then slide out the battery pack from the main unit (2).



Removing the Dummy Card

1. Press the dummy card in to allow it to spring out.



2. Pull the dummy card out



Removing the Hard Disk Drive Module



DISCLAIMER: The notebook sample in the following images shows an FFC. The actual model includes an FPC as pictured in the image on the right.

1. See "Removing the Battery Pack" on page 45.
2. Loosen the two captive screws.



3. Lift the HDD cover up and away by the corner.



4. Grasp the FPC cable and lift to remove.

NOTE: The cable pictured in the following images may differ from the actual sample.



5. Grasp the transparent tab at the top of the HDD and lift up to eject the HDD from the bay.

IMPORTANT:The transparent tab is attached to the bottom cover. Do not pull the transparent tab out of the chassis.



6. Pull the tab upwards to free the HDD from the bay.
7. At the same time, hold the HDD with the other hand and lift to remove from the chassis.



8. Unlock the HDD FPC and pull the FPC away.

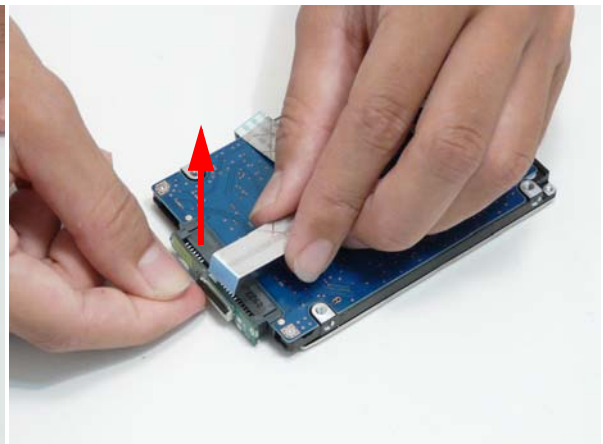
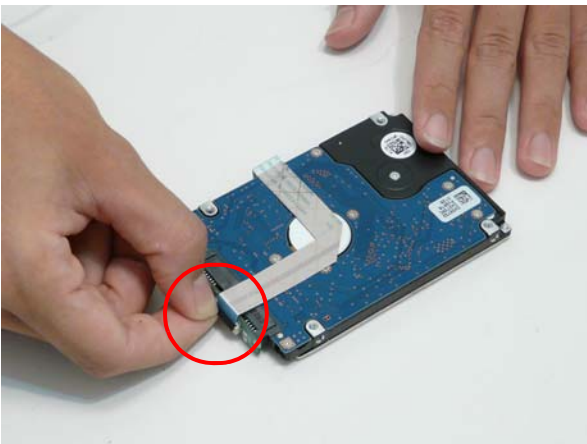

9. Detach the HDD board.

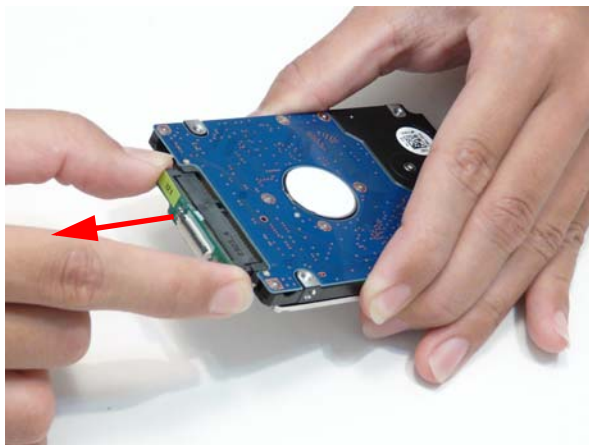

Removing the DIMM Module

1. See "Removing the Battery Pack" on page 45.
2. Loosen the four captive screws in the memory cover.



3. Lift the memory cover away.



4. Push outwards the memory module clips.

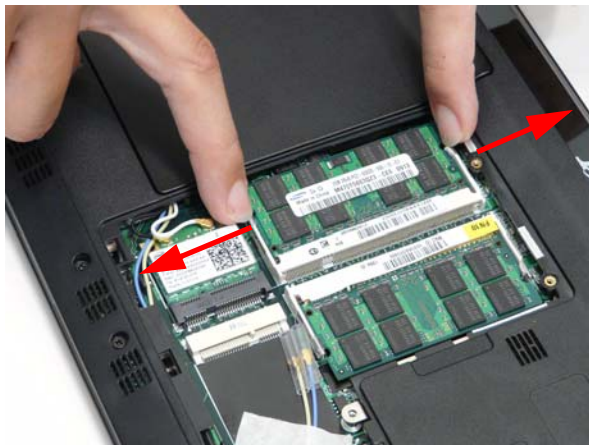

5. Pull the memory module out.



6. Repeat steps 4. and 5. for the second memory module.

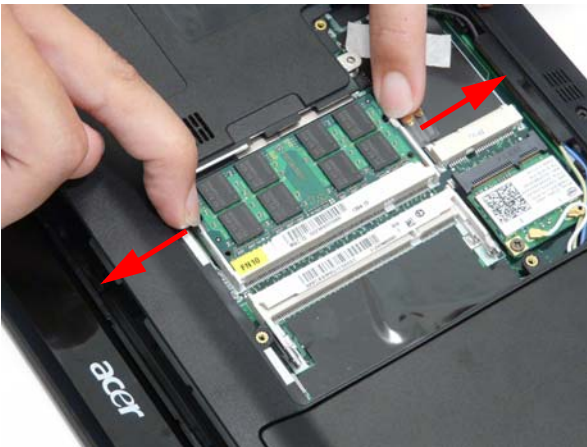

Removing the WLAN Module

1. See "Removing the Battery Pack" on page 45..
2. Loosen the four captive screws in the memory cover.



3. Lift and remove the memory cover.



4. Detach the two cables from the Wireless LAN module.

IMPORTANT: Take note of the Main (1. black) and Auxiliary (2. white) connectors.



5. Remove the one screw. Ensure the cables are well clear of the module



Screw List

Step	Screw	Quantity	Screw Type
WAN Module Disassembly	2*3	1	

6. Pull the WLAN module out and away.

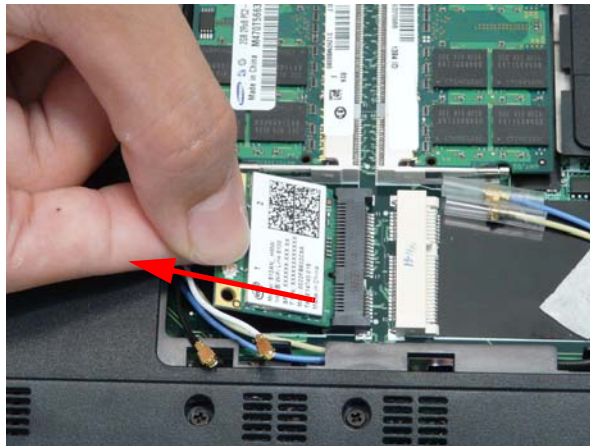

Main Unit Disassembly Process

IMPORTANT: Cable paths and positioning may not represent the actual model. During the removal and replacement of components, ensure all available cable channels and clips are used and that the cables are replaced in the same position.

NOTE: The product previews seen in the disassembly procedures may not represent the final product color or configuration.

Main Unit Disassembly Flowchart

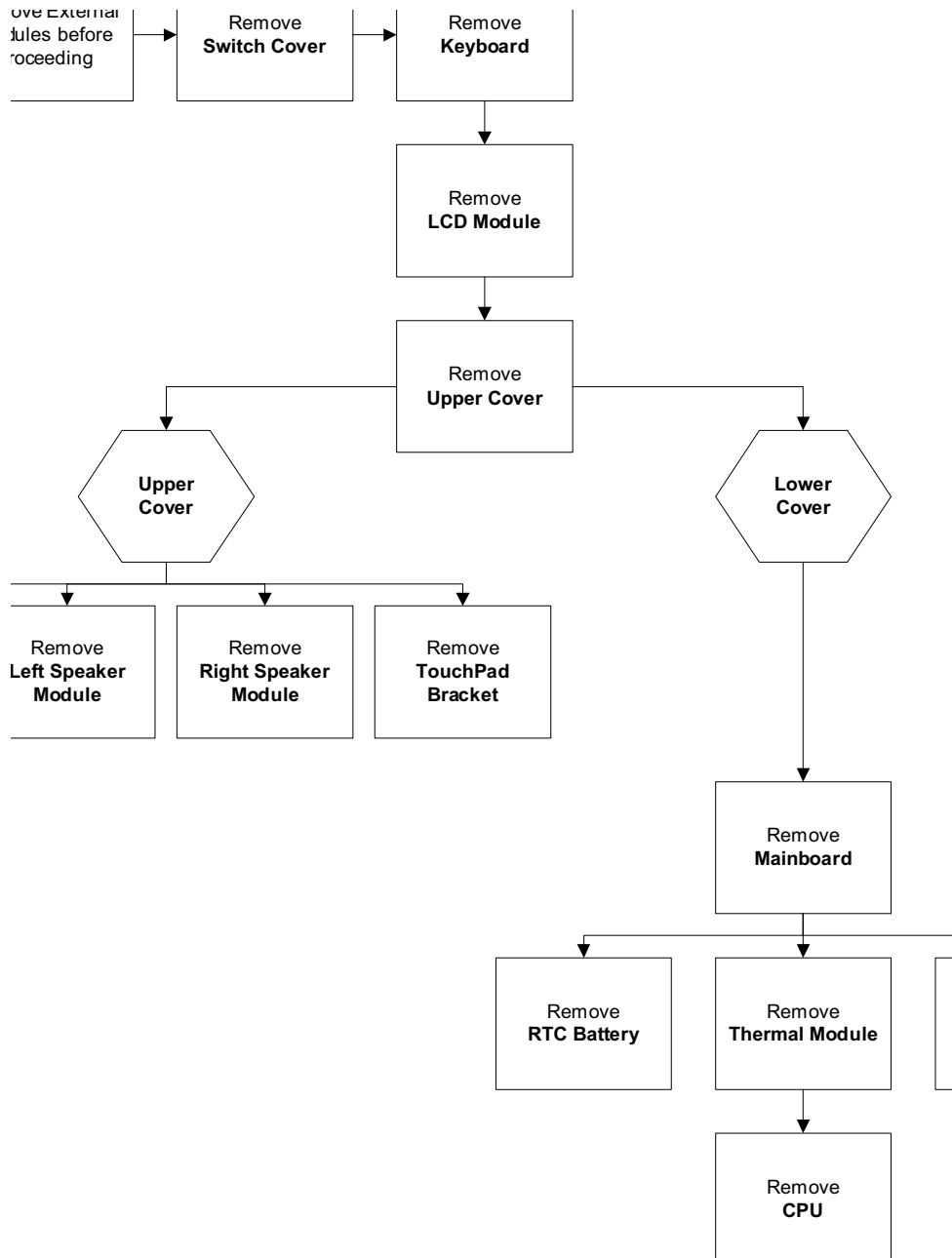

Screw List

Step	Screw	Quantity	Part No.
Remove Upper Cover	M2*3	3	86.SA107.001
	M2*5	18	86.TG607.004
Remove Button Board	M2-0.4*2	2	86.W4107.002
Remove LCD Module	2*5	2	86.TG607.004
Remove LED Board	M2*3	1	86.SA107.001
Remove I/O Board	M2*3	2	86.SA107.001
Remove Mainboard	M2*3	5	86.SA107.001
Remove Speaker Module	M2*3	4	86.SA107.001

Removing the Keyboard

IMPORTANT: The keyboard is easily warped or damaged during the removal process. Take care not to use excessive force when removing to prevent damage.

1. See “Removing the Battery Pack” on page 45.
2. See “Removing the Hard Disk Drive Module” on page 47.
3. See “Removing the DIMM Module” on page 50.
4. See “Removing the WLAN Module” on page 52.
5. Using the plastic pry, press in the four latches along the top of the keyboard to release the keyboard from the cover.

NOTE: The keyboard will spring up slightly when all retaining clips are unlocked.



6. Using the plastic pry, lift up the top edge of the keyboard and then lift the keyboard up.



7. Flip the keyboard over.

a. Unlock the FCC

b. Pull the keyboard away

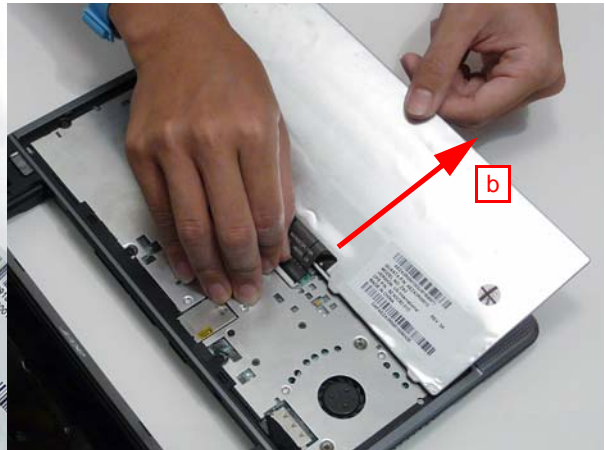
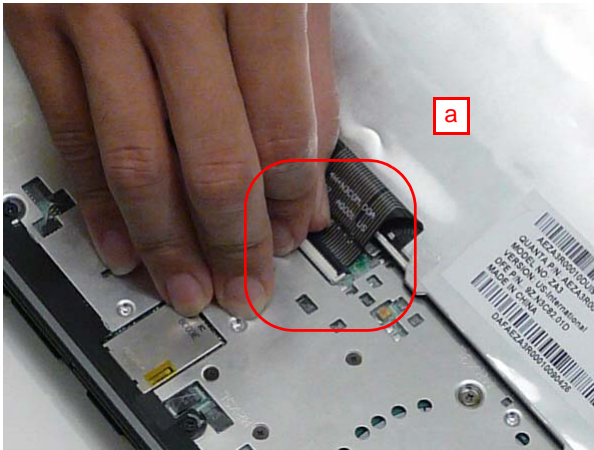

Removing the Upper Cover

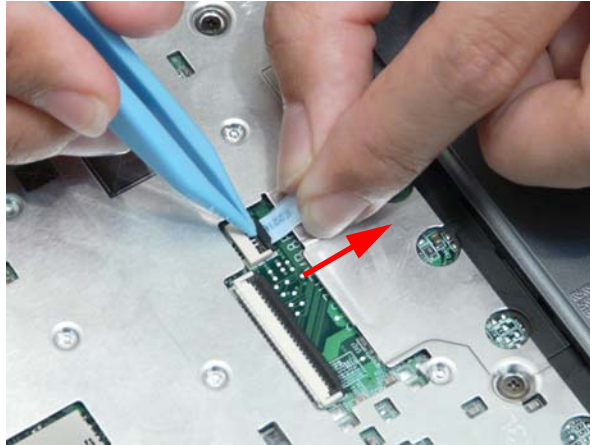

1. See "Removing the Keyboard" on page 56.
2. Disconnect the button board FCC from the main board by unlocking the FCC cable and pulling away.



3. Remove the nine screws in the upper cover.



Screw List

Step	Size	Quantity	Screw Type
Upper Cover Disassembly	M2*3	3 (green call out)	
	M2*5	6 (red call out)	

4. Turn the computer over and remove the twelve screws in the bottom cover.

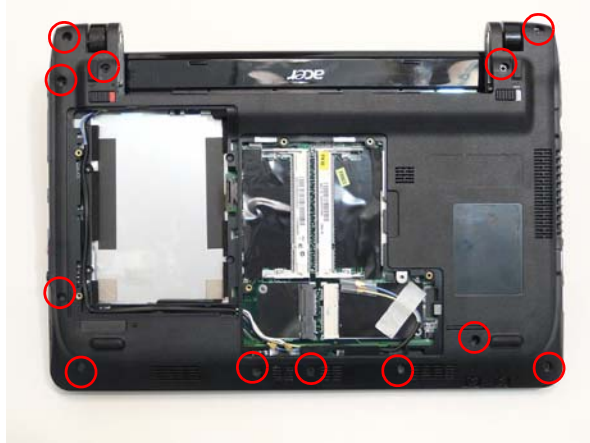

Screw List

Step	Size	Quantity	Screw Type
Upper Cover Disassembly	M2*5	12	

5. Pull off the tape from the 3M module cables.

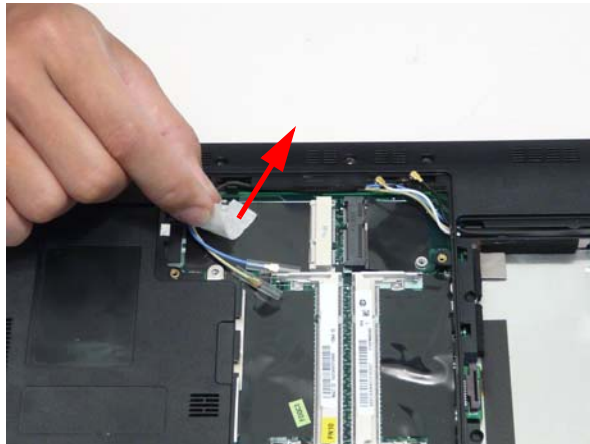

6. Pull the 3M module and WLAN cables away from the computer.

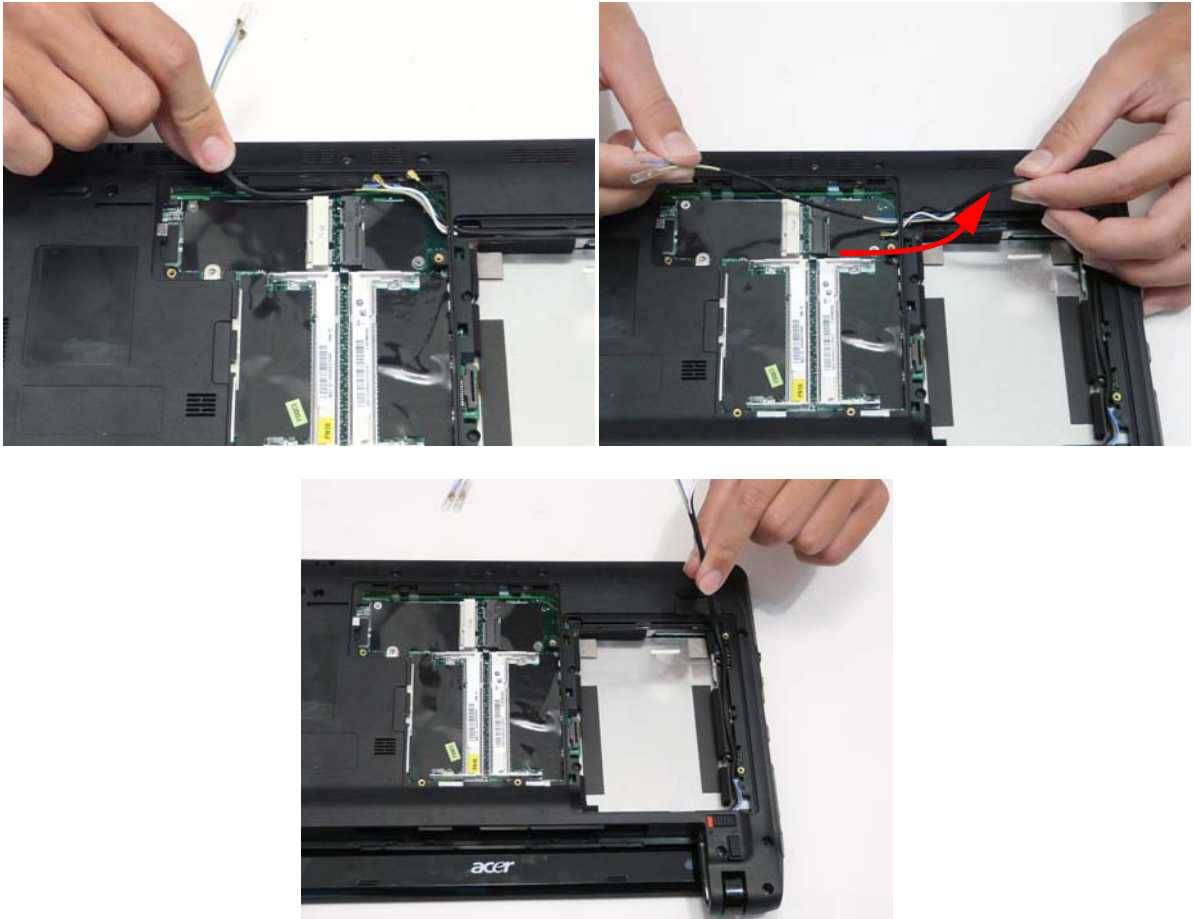

NOTE: Replace the plastic caps over the 3M module cable connectors immediately if they get dislodged during the process.

7. Turn the computer over and grasp the upper cover by the hinges. Then pull the upper cover up and away from the computer.



Removing the Button Board

IMPORTANT: The Touchpad Board cannot be removed individually. To replace the Touch Pad, replace the entire Upper Cover.

1. See "Removing the Upper Cover" on page 58.
2. Unlock and remove the touch-pad to mainboard FCC.



3. Unlock and detach the touch-pad to touch-pad FCC.

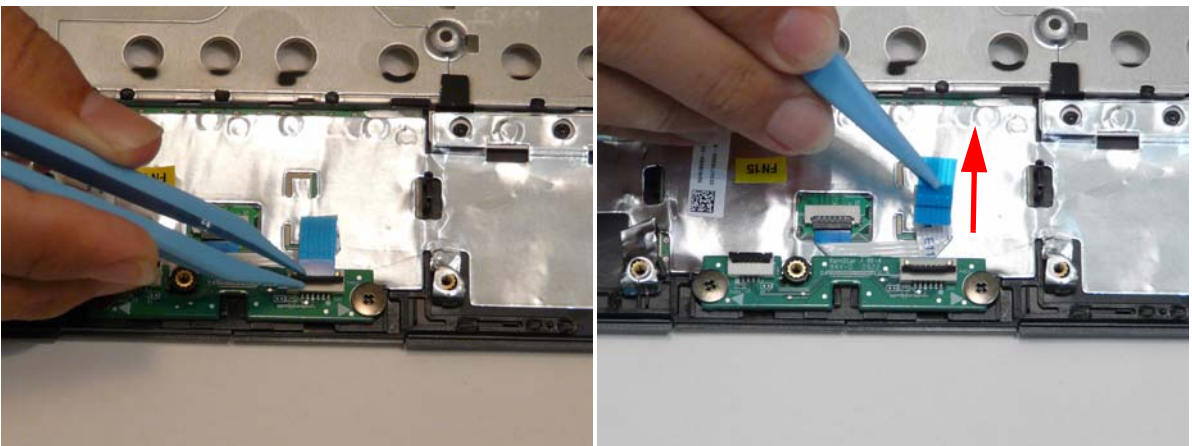

4. Remove the two screws holding the button board.

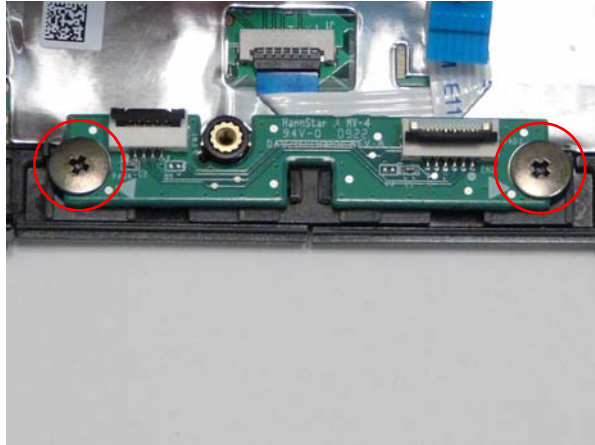

Screw List

Step	Size	Quantity	Screw Type
Button board	M2-0.4*2	2	

5. Lift the button board away

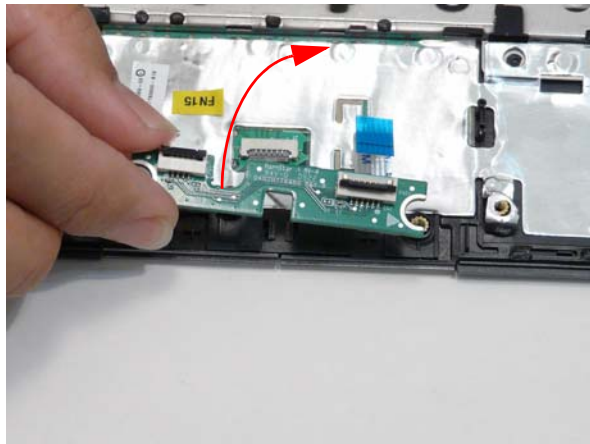

6. Peel the touch-pad FCC away from the adhesive.

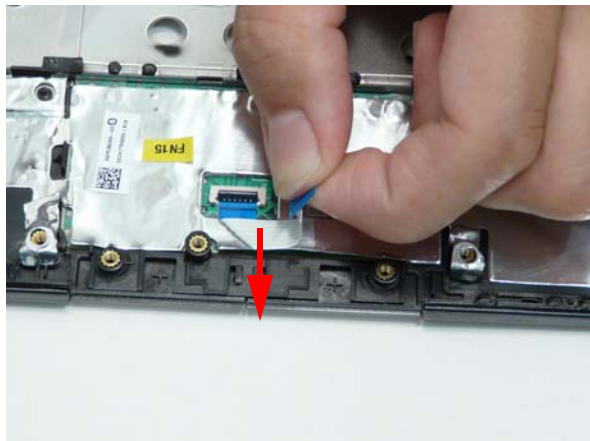

7. Unlock the touch-pad FCC and pull the cable away.

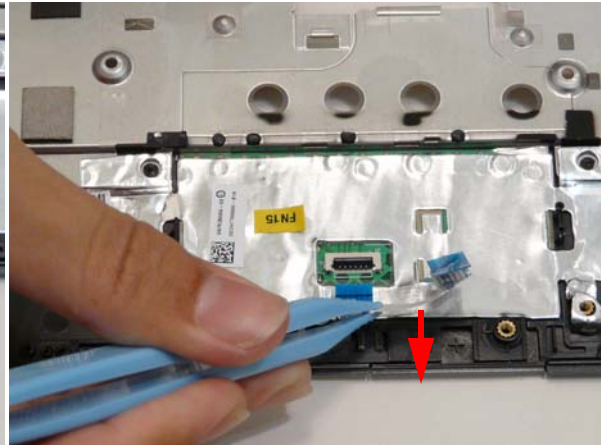
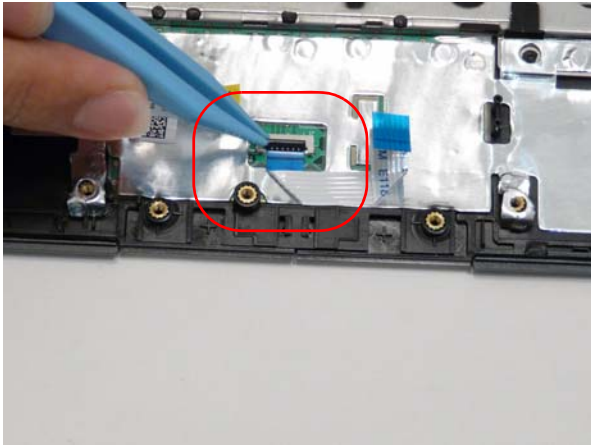

Removing the LCD Module

1. See "Removing the Upper Cover" on page 58.
2. Pull the 3M module and WLAN cables away from the computer.

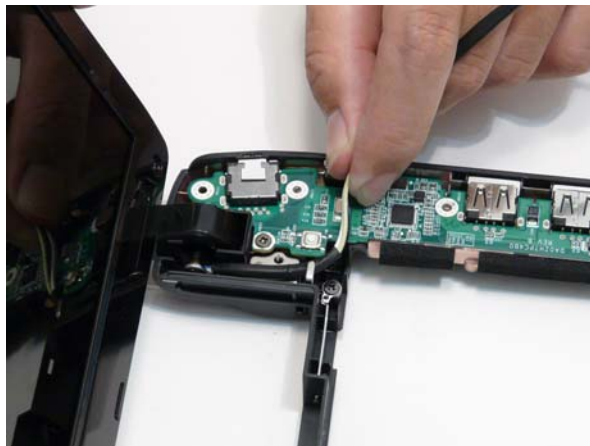

3. Lift the transparent adhesive tape off the LCD connector.

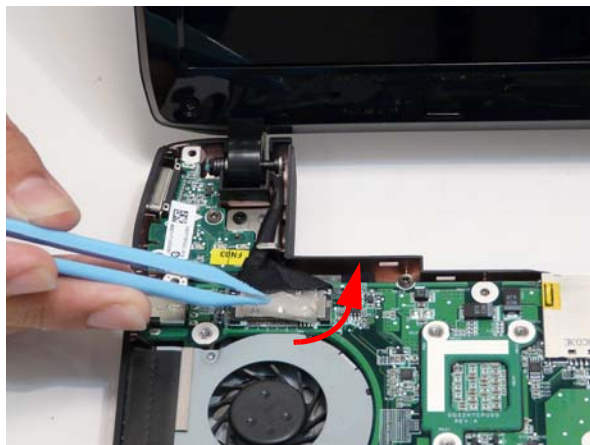

4. Push out the LCD connector.

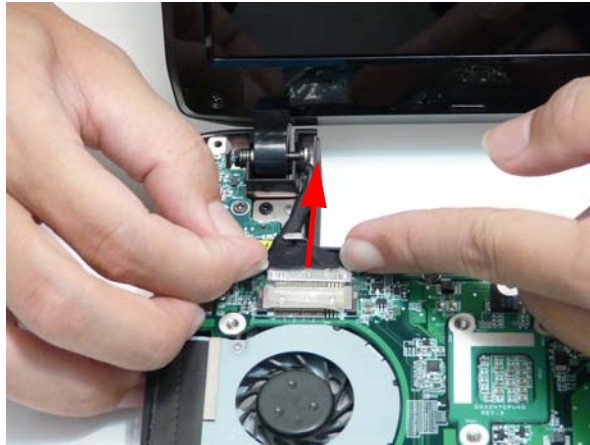

5. Remove the two screws of the LCD module hinges.



Screw List

Step	Screw	Quantity	Screw Type
LCD Module Disassembly	M2*5	2	

6. Lift the LCD module away.

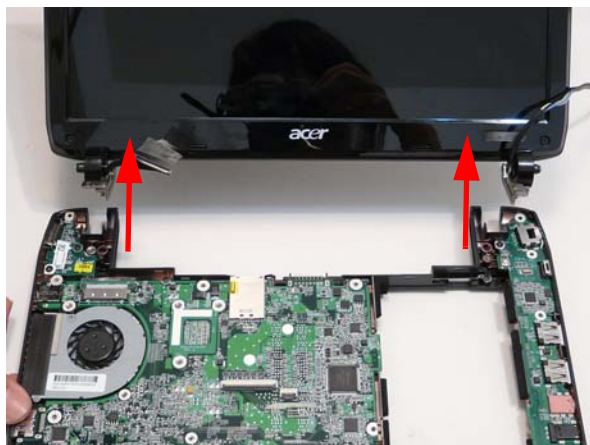

Removing the LED Board

1. See "Removing the Upper Cover" on page 58.
2. Unlock and remove the LCD board FCC.

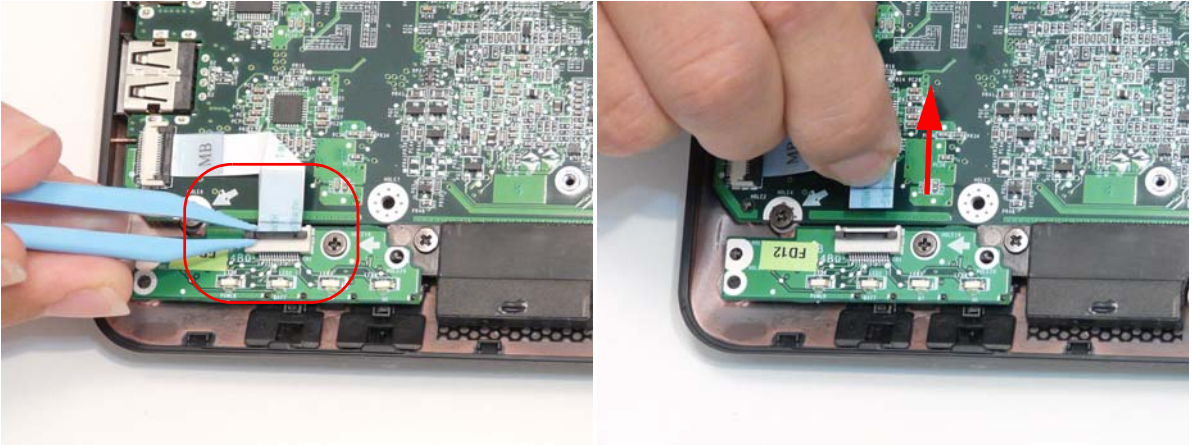

3. Remove the single screw securing the LED Board to the Lower Cover.

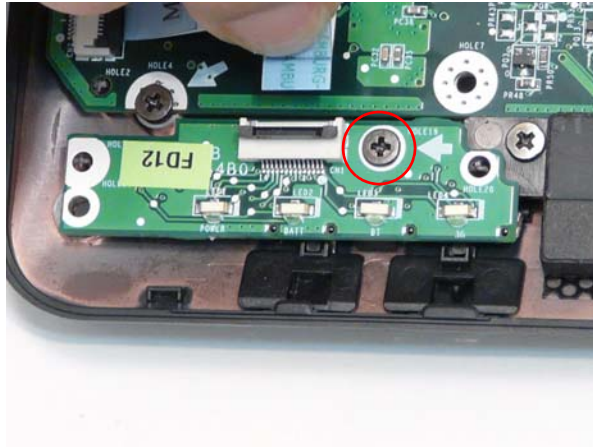

Screw List

Step	Screw	Quantity	Screw Type
LED Board Disassembly	2*3	1	

4. Lift off the LCD Board.

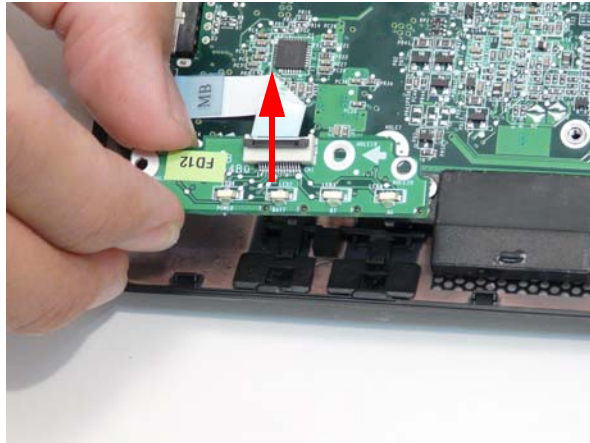

5. Unlock and remove the LED board FCC from the mainboard.

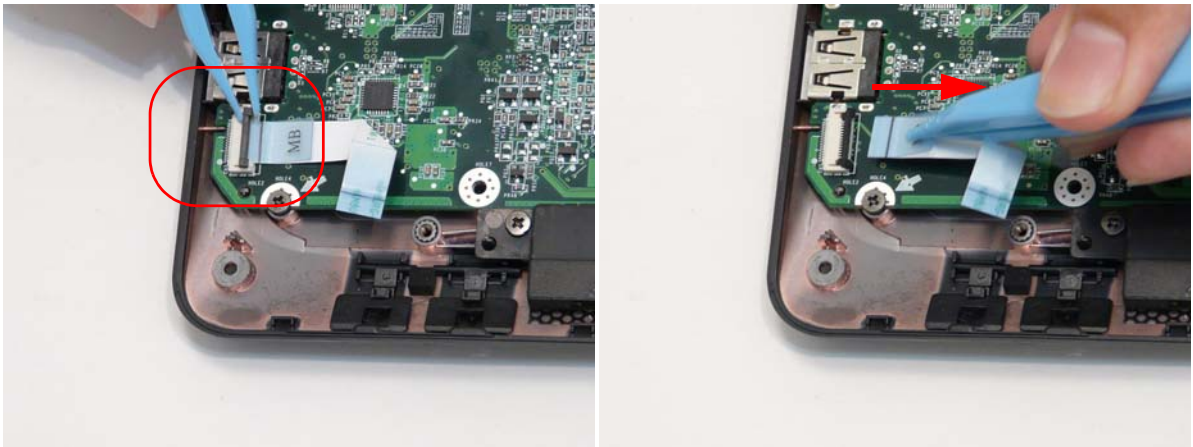

Removing the Bluetooth Module

1. See "Removing the Upper Cover" on page 58.
2. Detach the Bluetooth module cable from the mainboard.

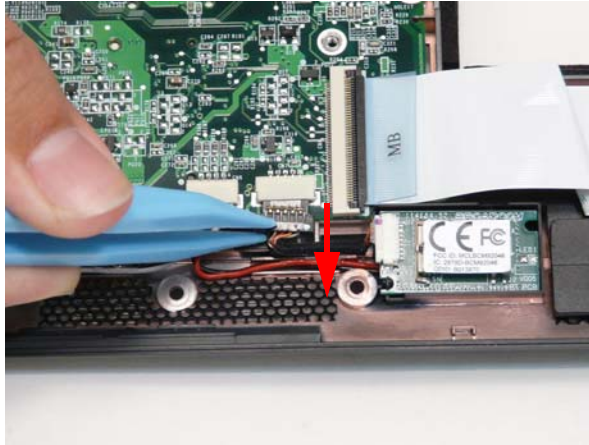

3. Lift the Bluetooth module away from the computer.

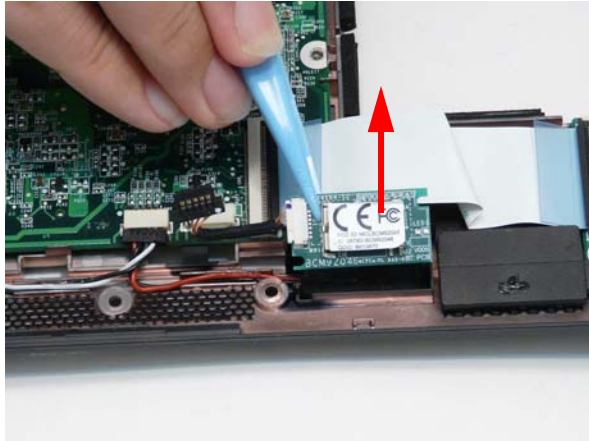

4. Detach the Bluetooth module cable from the module.

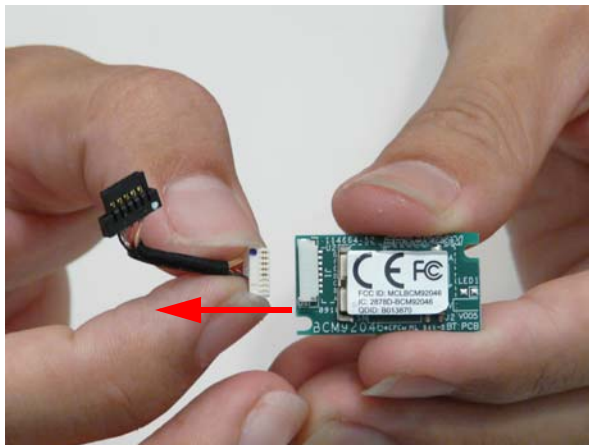

Removing the I/O Board

1. See "Removing the Upper Cover" on page 58..
2. Unlock and remove the I/O board FCC from the main board

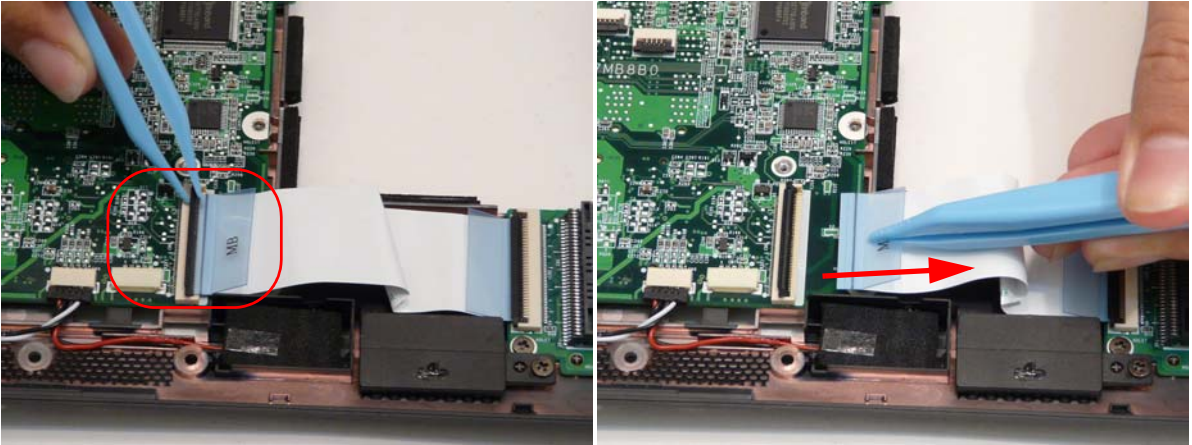

3. Unlock and remove the I/O board FCC from the I/O board.

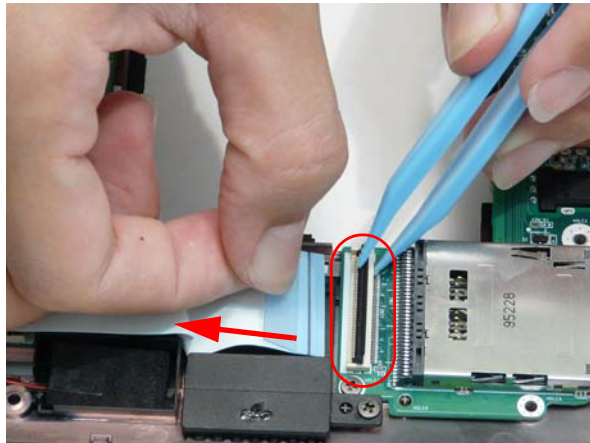

4. Remove the two screws from the I/O board.

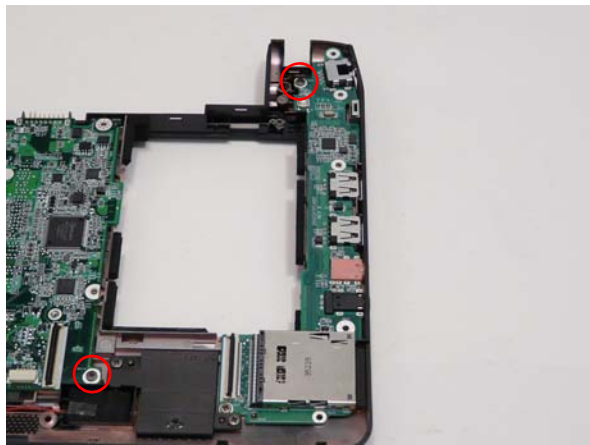

Screw List

Step	Screw	Quantity	Screw Type.
I/O Board Disassembly	M2*3	2	

5. Lift the board up from the internal edge and then pull away diagonally.

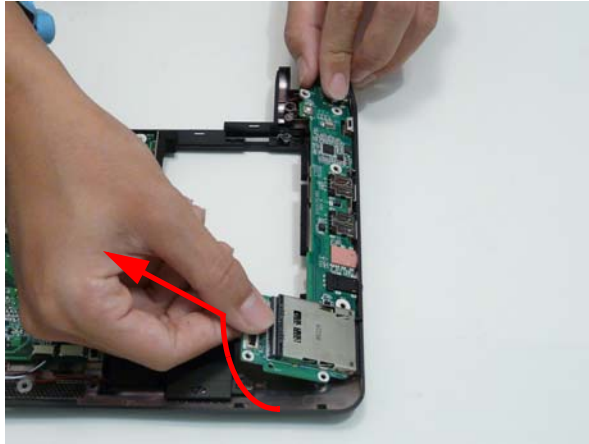

Removing the Mainboard

1. See "Removing the Upper Cover" on page 58.
2. See "Removing the LCD Module" on page 64.
3. See "Removing the LED Board" on page 66.
4. See "Removing the Bluetooth Module" on page 68.
5. See "Removing the I/O Board" on page 69.
6. Disconnect the speaker cable from the mainboard.

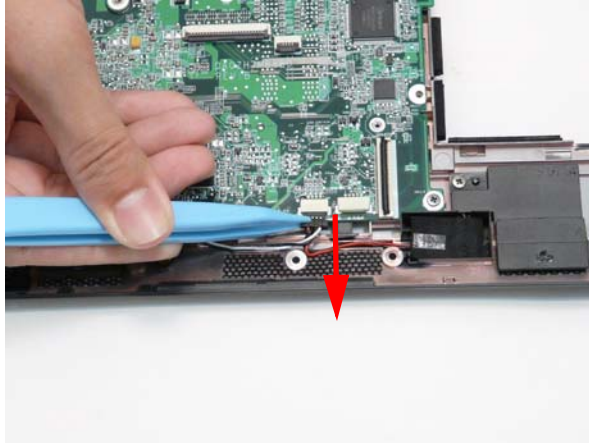

7. Remove the five screws of the main board and the CRT board.



Screw List

Step	Screw	Quantity	Screw Type.
Main Board Disassembly	2*3	5	

-
8. Lift the main board and the CRT board out together. Lift the internal edge up first then pull out the external connector edge.

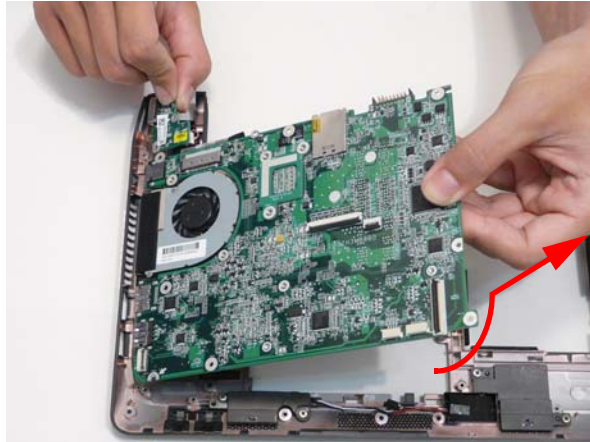

Removing the CRT Board

1. See "Removing the Mainboard" on page 71.
2. Disconnect the CRT cable from the CRT board.

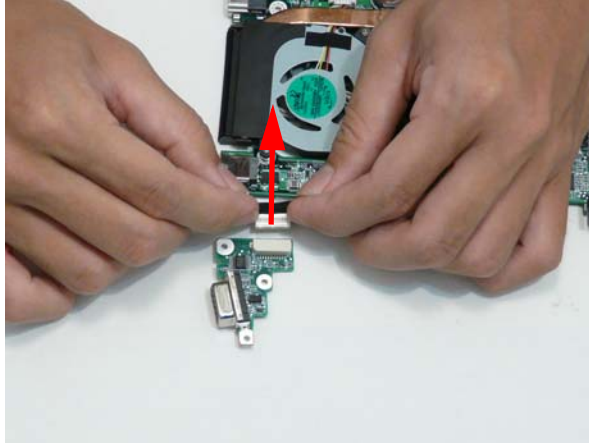

3. Disconnect the CRT cable from the main board.

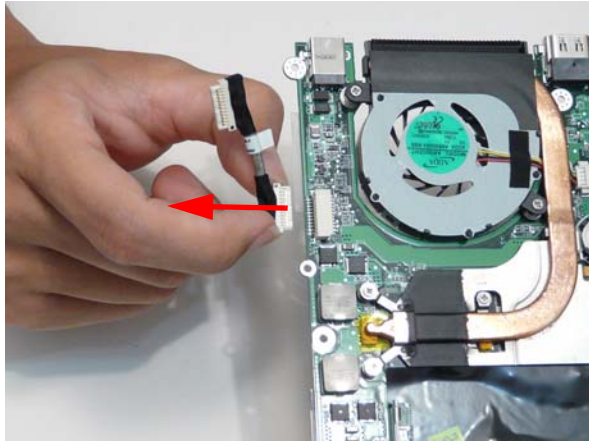

Removing the Thermal Module

1. See "Removing the Mainboard" on page 71.
2. See "Removing the CRT Board" on page 73.
3. Remove the five captive screws of the thermal module.

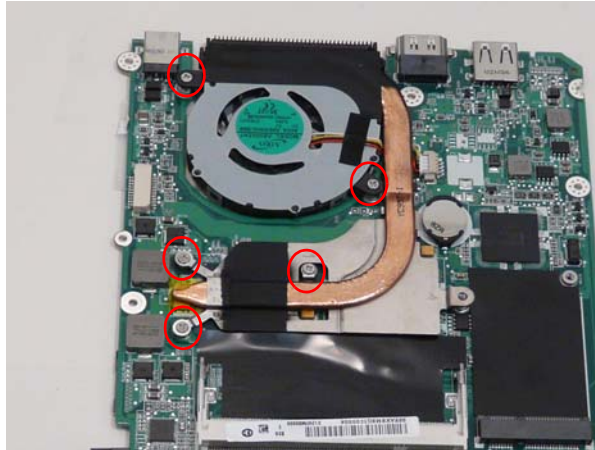

4. Lift the thermal module up slightly and then disconnect the thermal module cable from the main board.

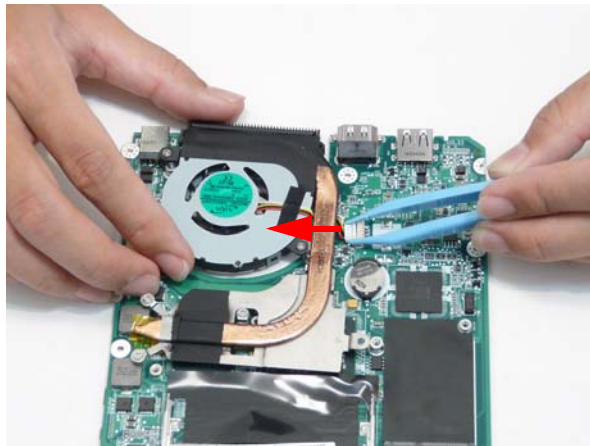

5. Lift the thermal module away from the main board.

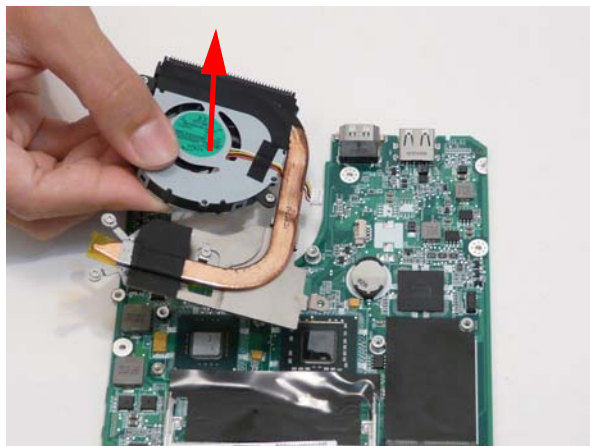

Removing the RTC Battery

IMPORTANT: Observe local regulations in the disposal of all batteries.

1. See "Removing the Mainboard" on page 71.
2. Pry the RTC battery out of the holding clips.

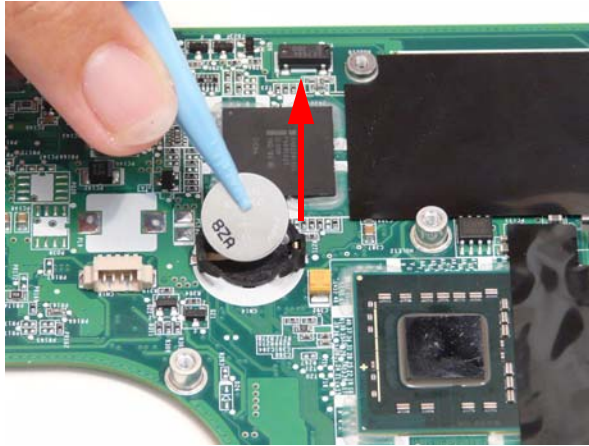

Removing the Speaker Modules

1. See "Removing the Mainboard" on page 71.
2. Remove the four screws from the speaker modules.

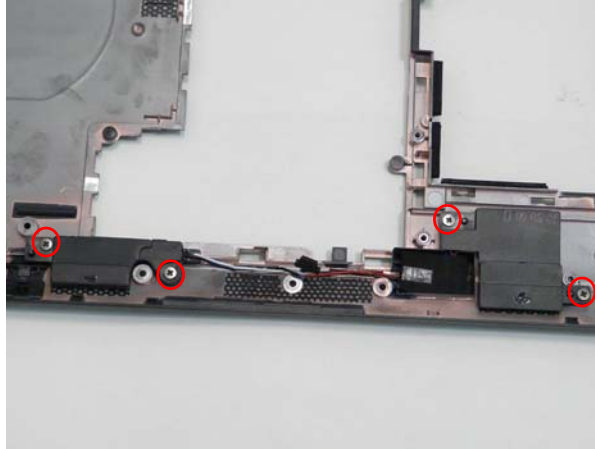

Screw List

Step	Screw	Quantity	Screw Type
Speaker Module Disassembly	M2*3	4	

3. Remove the black foam piece.

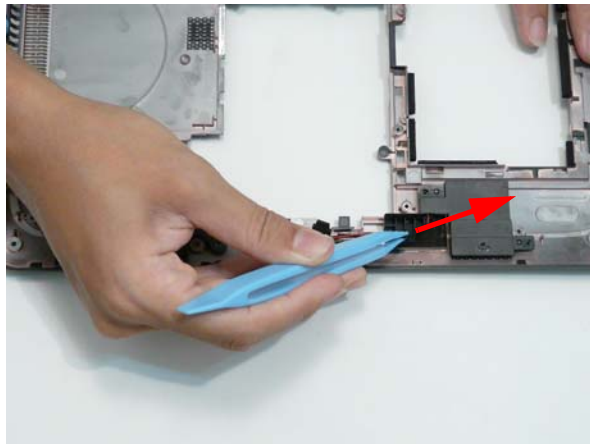

4. Pull the cables away from the two adhesive locations.

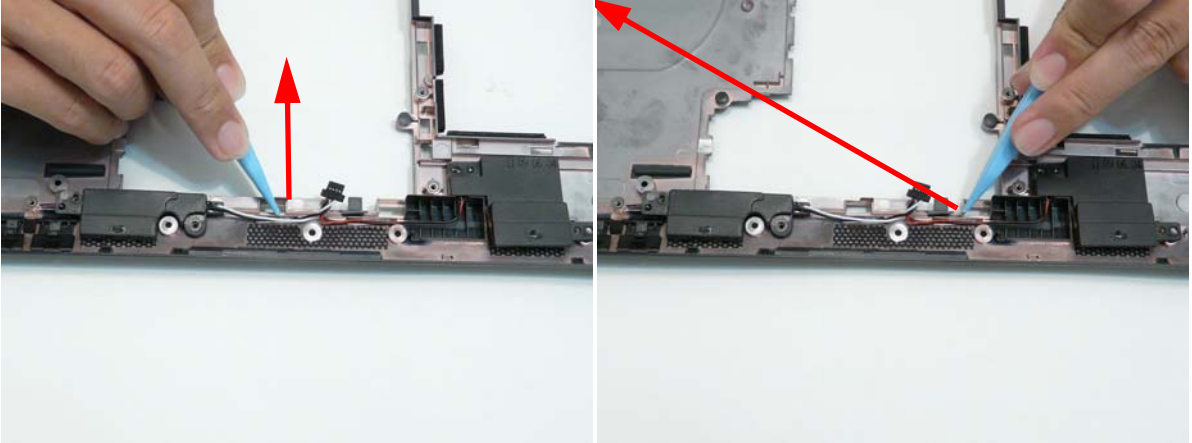

5. Lift the modules away.

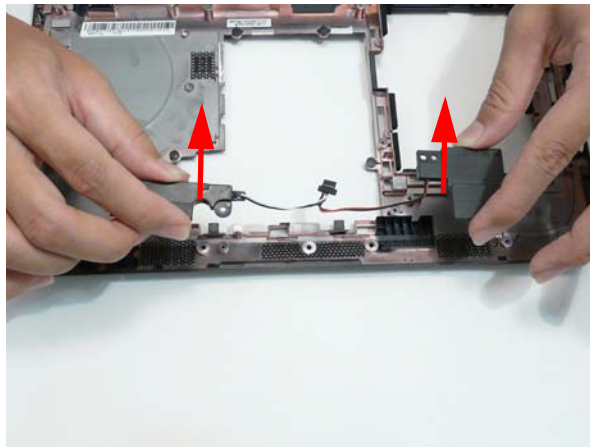

LCD Module Disassembly Process

IMPORTANT: Cable paths and positioning may not represent the actual model. During the removal and replacement of components, ensure all available cable channels and clips are used and that the cables are replaced in the same position.

NOTE: The product previews seen in the disassembly procedures may not represent the final product color or configuration.

LCD Module Disassembly Flowchart

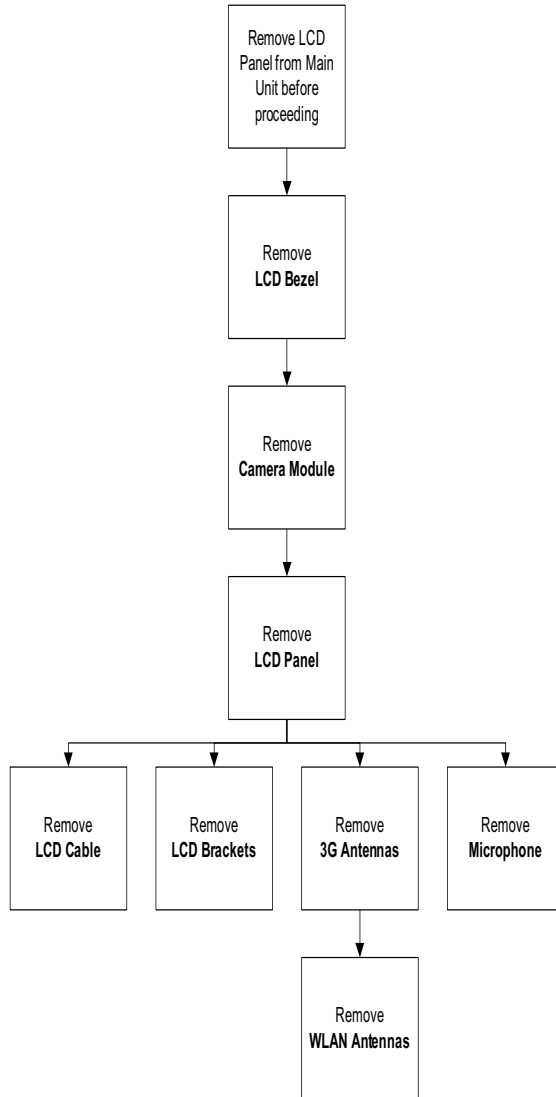

Screw List

Step	Screw	Quantity	Part No.
Remove LCD Bezel	2*5	6	86.TG607.004
Remove LCD Brackets	2*2.5	4	86.SA107.002
Remove LCD Panel	2*3	2	86.SA107.001

Removing the LCD Bezel

1. See "Removing the LCD Module" on page 64.
2. Remove the six rubber screw covers.



3. Remove the six screws securing the bezel.



Screw List

Step	Screw	Quantity	Screw Type
LCD Bezel Disassembly	2x5	6	

-
4. Pull the bezel away from the top and then work down one side, along the bottom, then up the other side.



-
5. Roll the bezel up and away from the hinges.



Removing the Camera Board

1. See "Removing the LCD Bezel" on page 79.
2. Disconnect the camera connector.

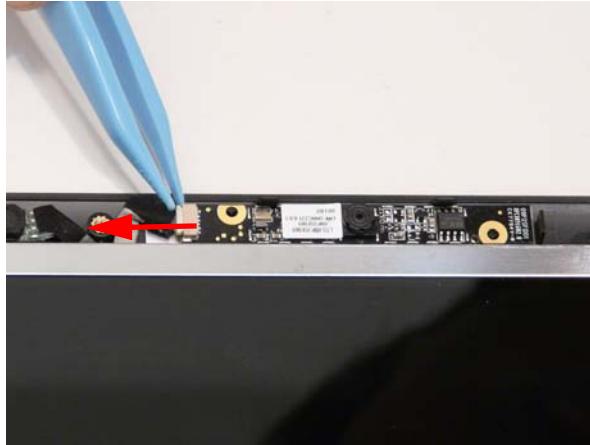

3. Pull up the camera board.

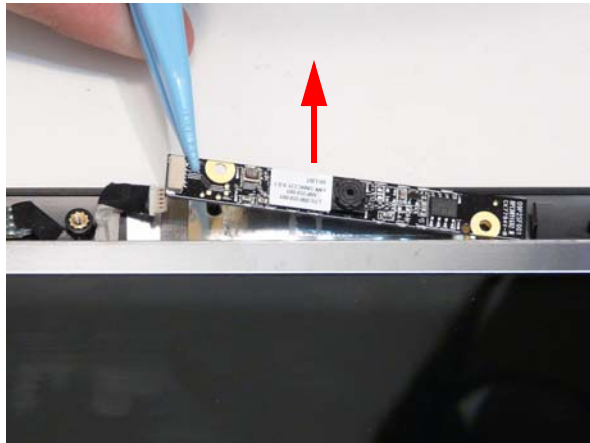

Removing the LCD Panel

1. See "Removing the Camera Board" on page 82.
2. Pull up the microphone.

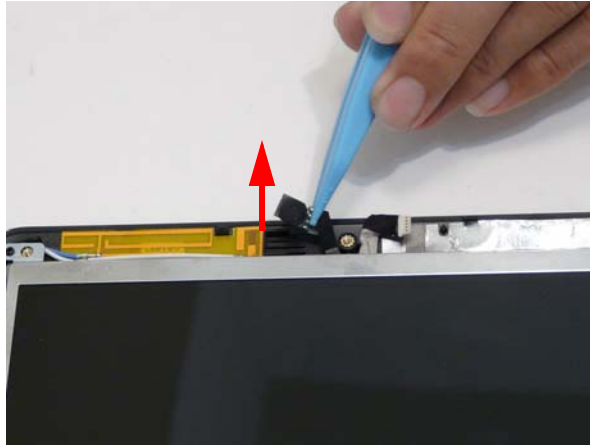

3. Remove the two screws.



Screw List

Step	Screw	Quantity	Screw Type
LCD Panel Disassembly	2x3	2	

-
4. Lift the LCD panel out lifting the bottom of the panel first.



Removing the LCD Brackets

1. See "Removing the LCD Panel" on page 83.
2. Remove the four LCD bracket screws.



Screw List

Step	Screw	Quantity	Screw Type
LCD Brackets Disassembly	M2*2.5	4	

Removing the FPC Cable

1. See "Removing the LCD Panel" on page 83.
2. Place the panel face down on a clean smooth surface. Pull the microphone/camera cable off the adhesive.

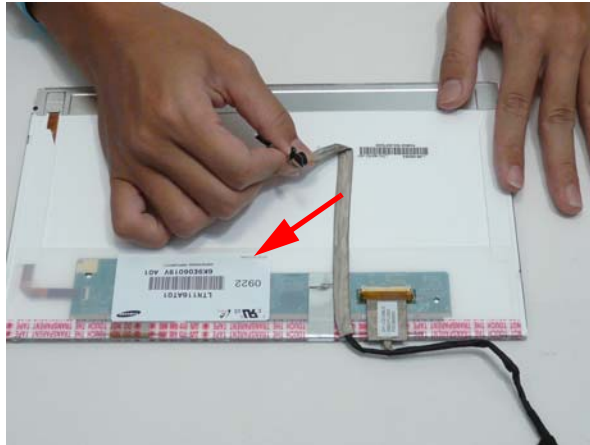

3. Lift up the protective plastic tab.

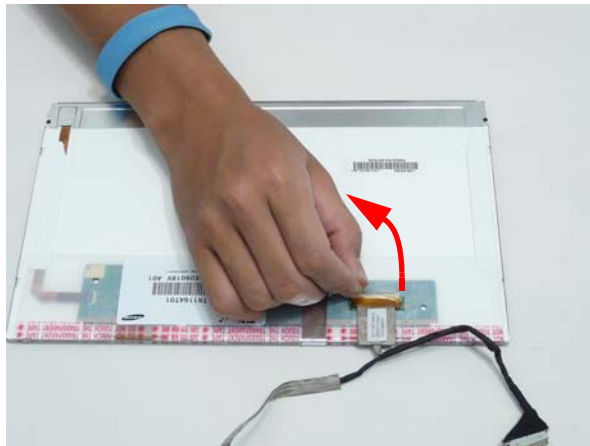

4. Disconnect the LCD connector.

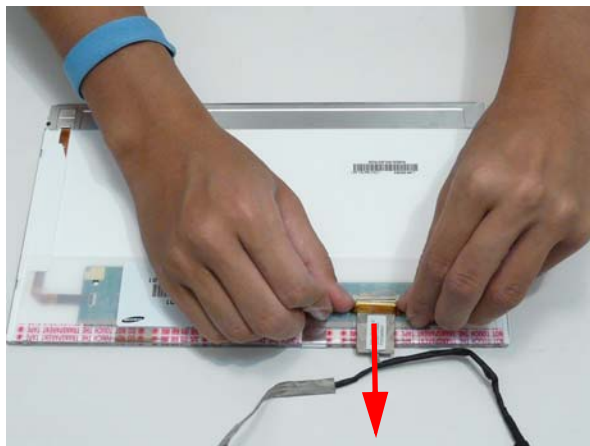

Removing the Antennas

1. See "Removing the LCD Panel" on page 83.
2. Lift up the two foil flaps at the corners of the LCD module.



3. Lift up the foil of the left antenna.



4. Lift up the left antenna.



5. Pull the left antenna cable away from around the edges of the LCD module.



6. Lift up the foil of the right antenna.



7. Lift up the right antenna.



8. Pull the right antenna cable away from the LCD module.

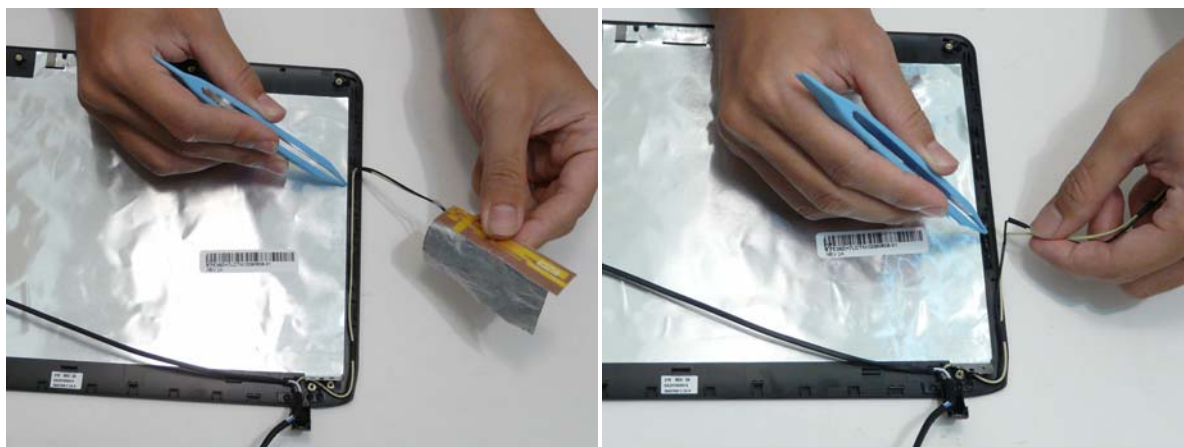

LCD Reassembly Procedure

NOTE: Adhesive is required to be added at various steps to cables and components. Locations of adhesive to be added is designated with a: ●

NOTE: During manufacture a cyanoacrylate glue is used provided by Holdtite Adhesives LTD. This is not a specified requirement. The reassembler is free to select an alternative appropriate adhesive.

Replacing the Antennas

1. Stick the two antennas into position left and right, pressing down firmly.

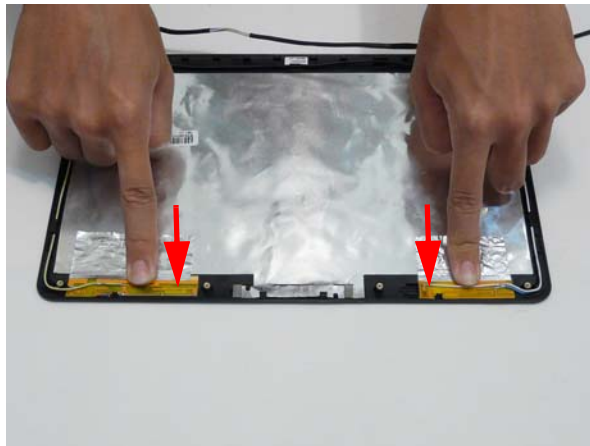

2. Stick down the antenna foil pads.



3. Ensure the cable is properly laid through the hinge. Apply adhesive on the locations shown.



4. Relay the cables around the module edge for the right antenna.



5. Relay the cables around the edge for the left antenna.

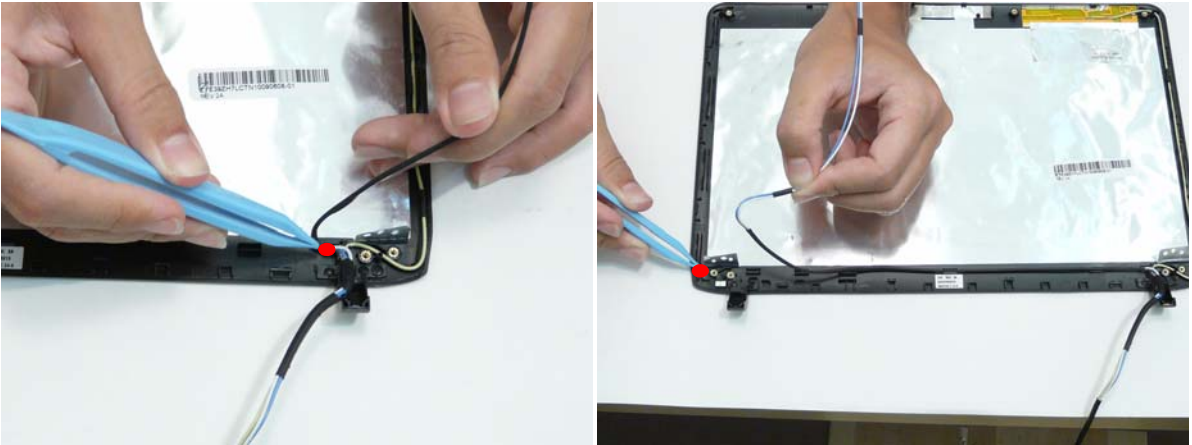

6. Flatten the two foil tabs ensuring the screw holes are properly aligned.



Replacing the FPC Cable

1. Connect the FPC cable connector.

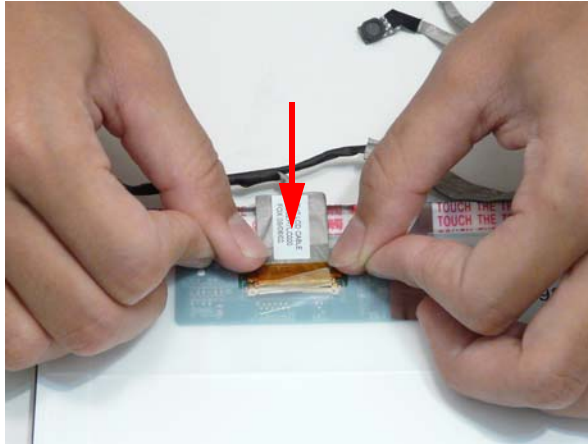

2. Place the protective clear adhesive tape down firmly over the connector.

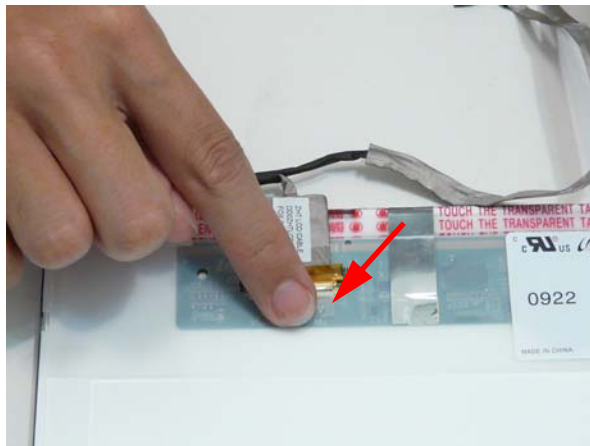

3. Apply adhesive behind the cable and stick the FPC cable down on the rear of the panel.

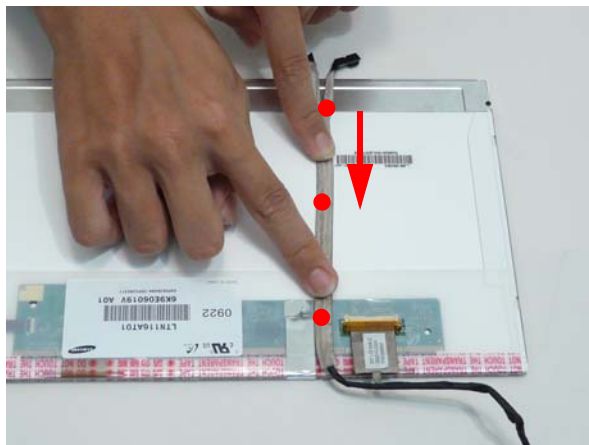

Replacing the LCD Brackets

1. Replace the four screws holding the LCD brackets in place.

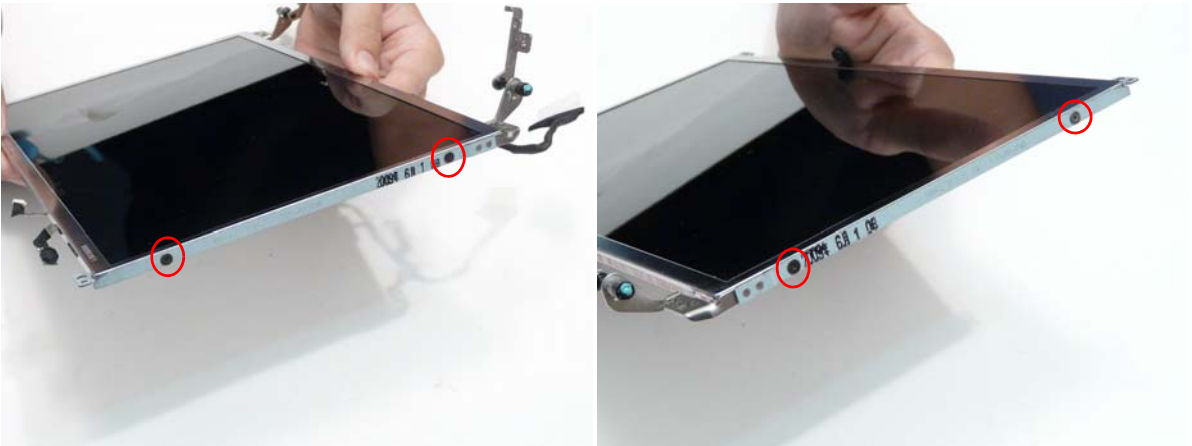

Screw List

Step	Screw	Quantity	Screw Type
LCD Brackets Disassembly	M2*2.5	4	

Replacing the LCD Panel

1. Place the LCD panel into LCD module as shown top edge first, making sure the cable is not trapped behind the panel.



2. Replace the two screws while ensuring the cables pass through the hinges correctly.



Screw List

Step	Screw	Quantity	Screw Type
LCD Panel Assembly	2x3	2	

-
3. Apply adhesive and stick the microphone down.

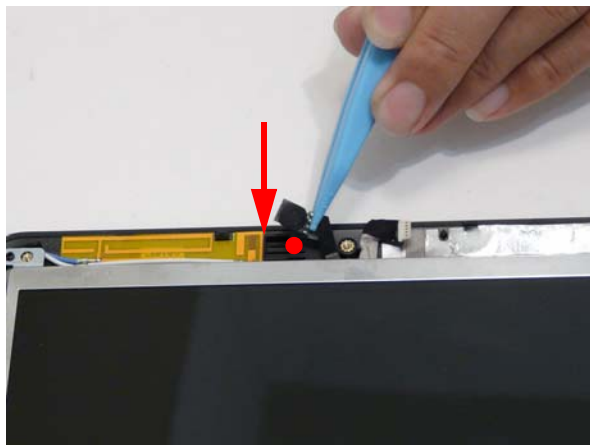

Replacing the Camera Board

1. Apply adhesive and lay the Camera Board board down pressing firmly.

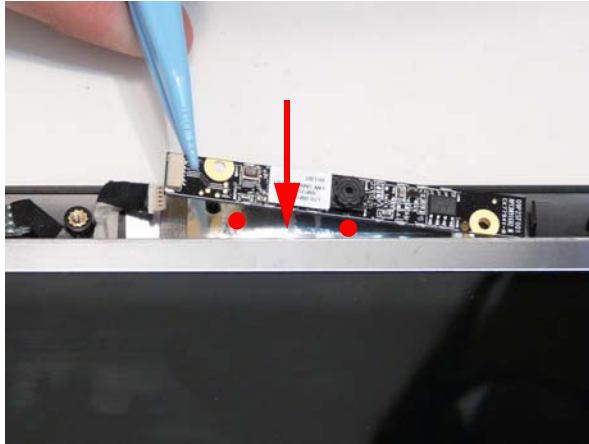

2. Connect the cable to the Camera Board.

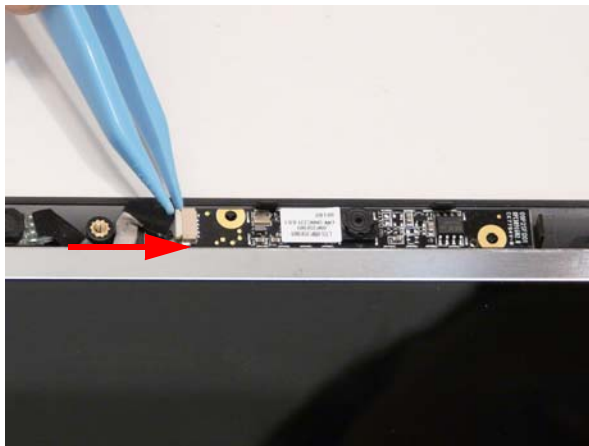

Replacing the LCD Bezel

1. Place the bezel hinge covers over the hinges.



2. Ensure the cables are correctly exiting the hinges.

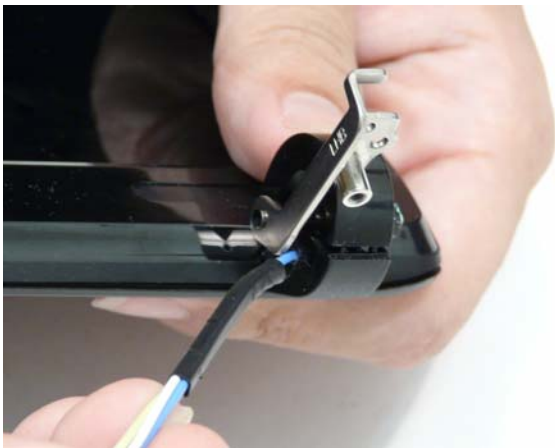

3. Press down around the bezel starting from the bottom and working simultaneously around the edges to the top.



4. Replace the six screws.



Screw List

Step	Screw	Quantity	Screw Type
LCD Bezel Assembly	M2*5	4	

5. Replace the six rubber screw covers.



Main Unit Reassembly Process

Replacing the Speaker Modules

1. Put the speakers in place.

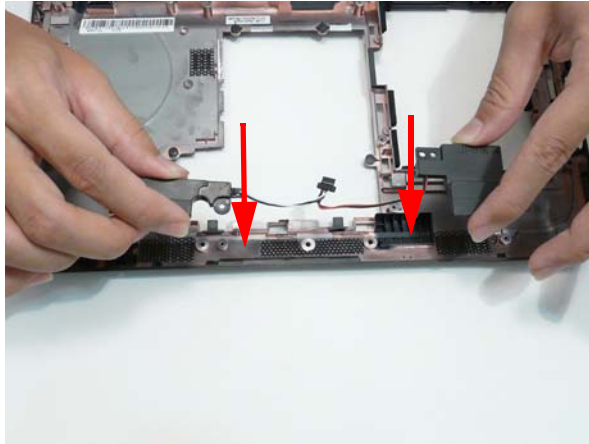

2. Apply adhesive and attach the speaker cables in two locations.

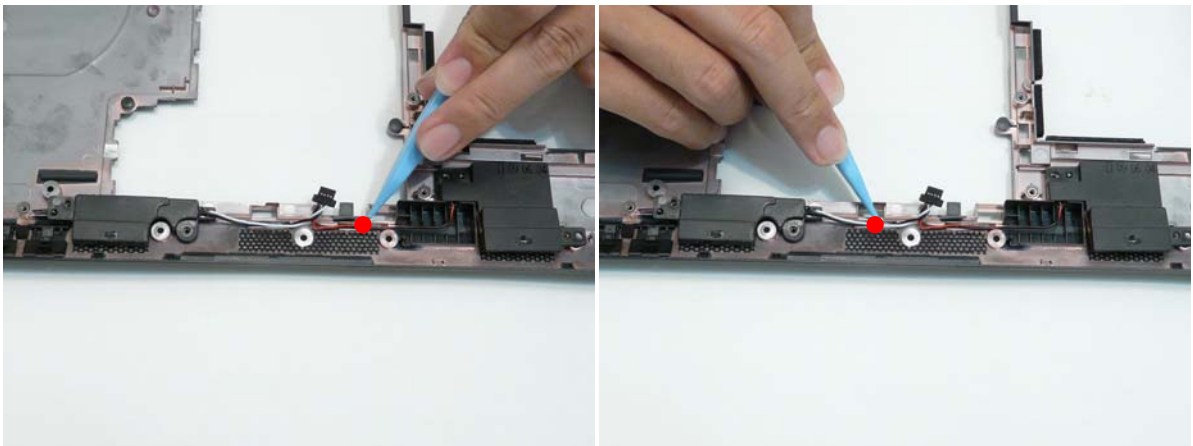

3. Replace the foam piece.

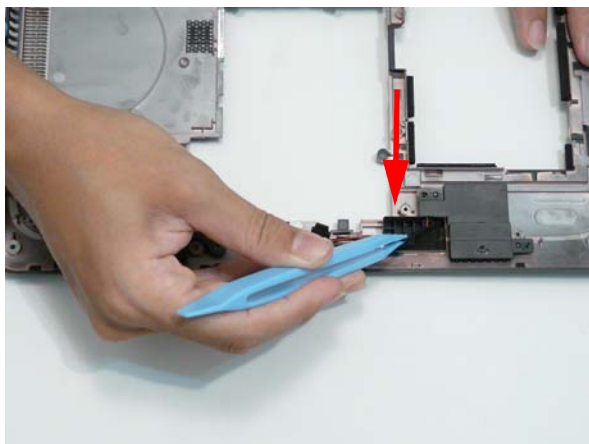

4. Replace the speaker module four screws.

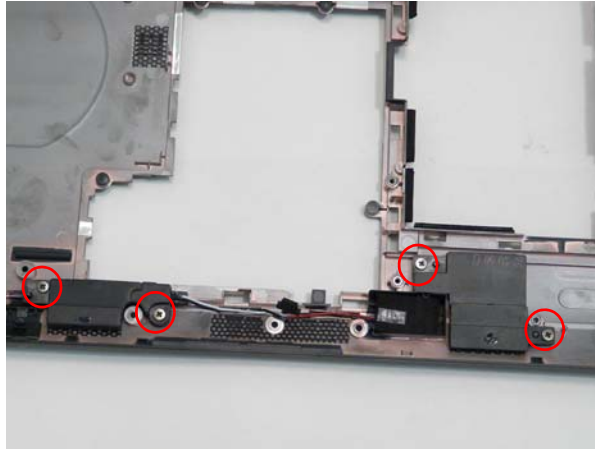

Screw List

Step	Screw	Quantity	Screw Type
Speaker Module Assembly	M2*3	4	

Replacing the RTC Battery

1. Place the RTC battery into the holding clips on the main board.

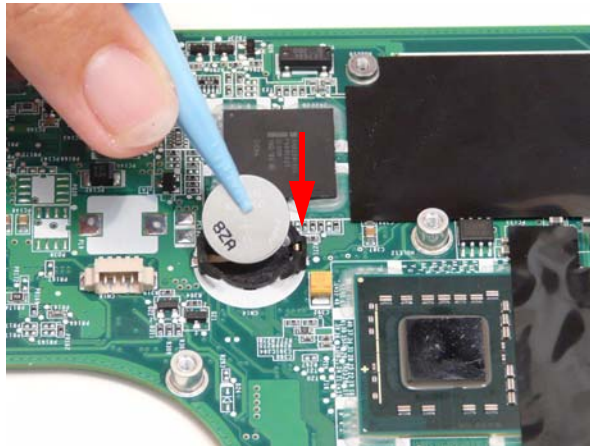

Replacing the Thermal Module

1. Connect the thermal module connector to the main board.

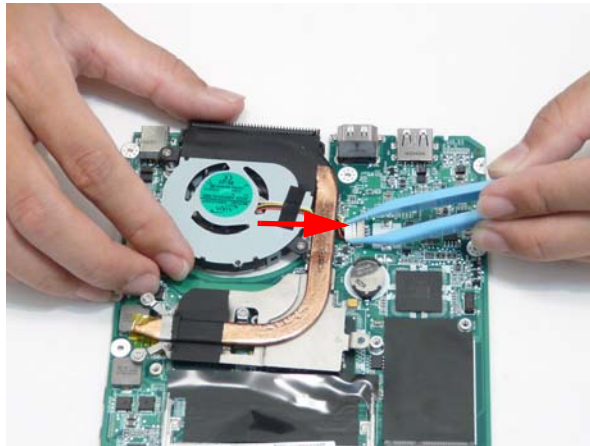

2. Place the Thermal Module onto the main board. Then first tighten the three captive screws marked 1, 2, 3 on the thermal module in order: 1-2-3. First tighten Screw 1, then screw 2, then screw 3.

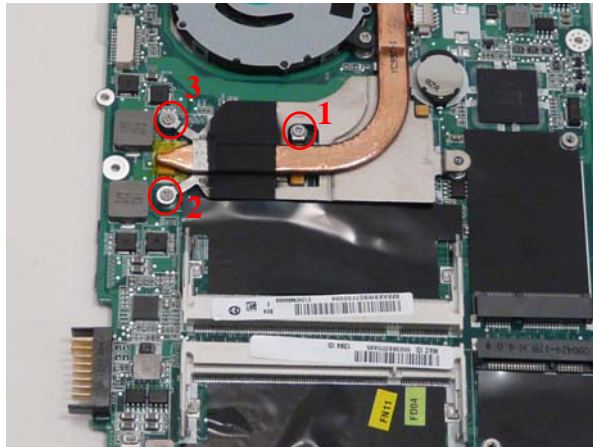

IMPORTANT: Incorrect order of screw replacement could harm the CPU.

3. The tighten the other two captive screws

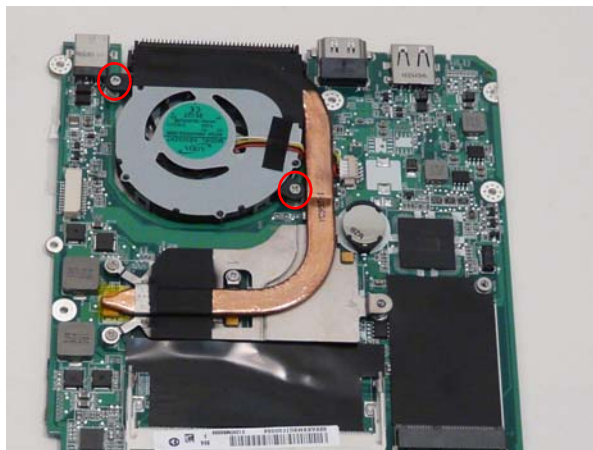

Replacing the CRT Board

1. Connect the CRT board cable to the main board.

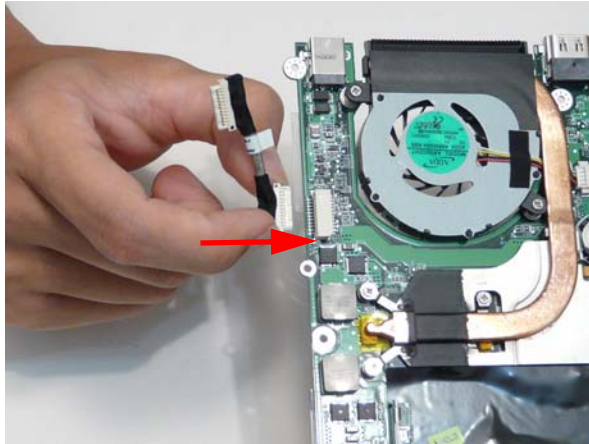

2. Connect the CRT board cable to the CRT board.

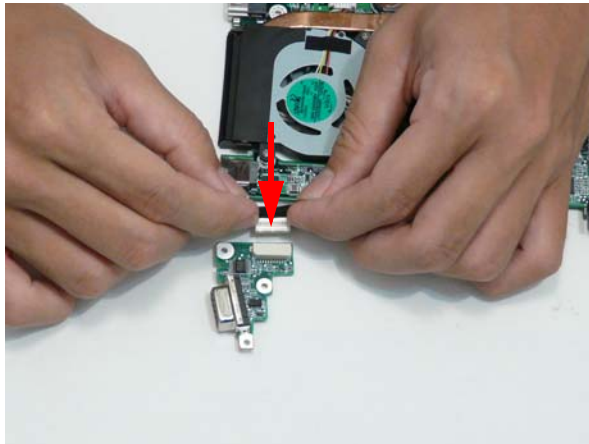

3. Align the CRT board cable carefully between the main board and the CRT board and stick down the attached tape of the cable.

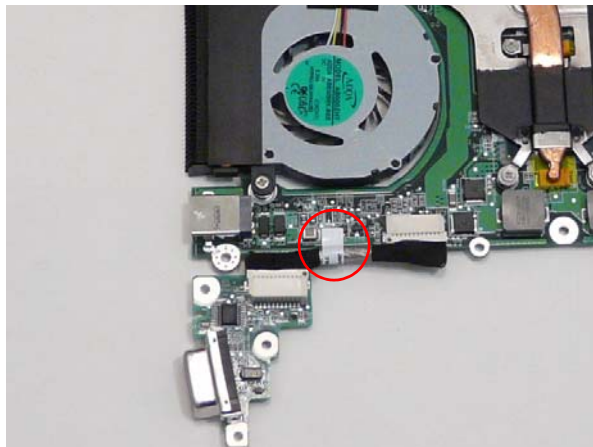

Replacing the Main Board

1. Slide the main board external connector edge in first to the lower case.

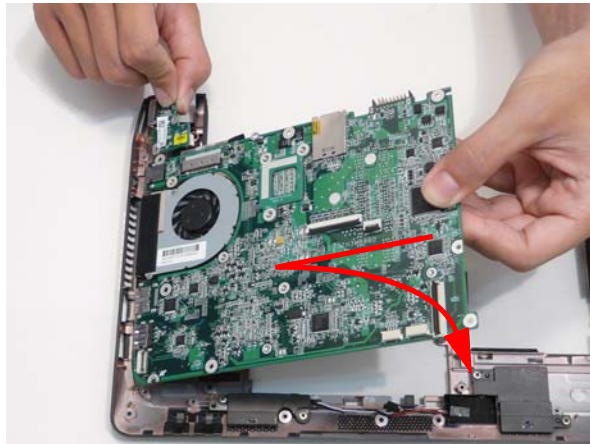

2. Replace the five screws to secure the mainboard to the lower cover.



Screw List

Step	Screw	Quantity	Screw Type
Main Board Assembly	2x3	5	

3. Connect the speaker connector.

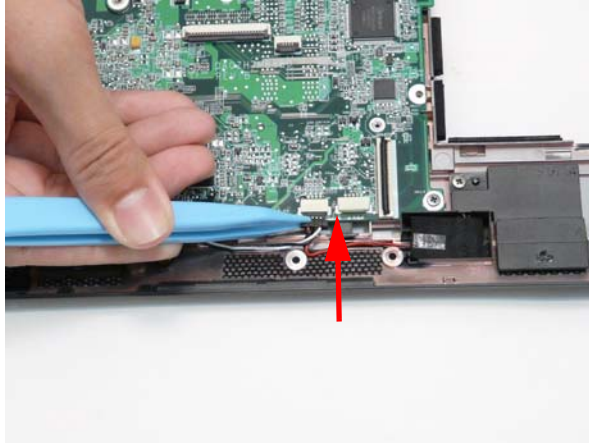

Replacing the I/O Card

1. Place the I/O card into the lower case edge first.

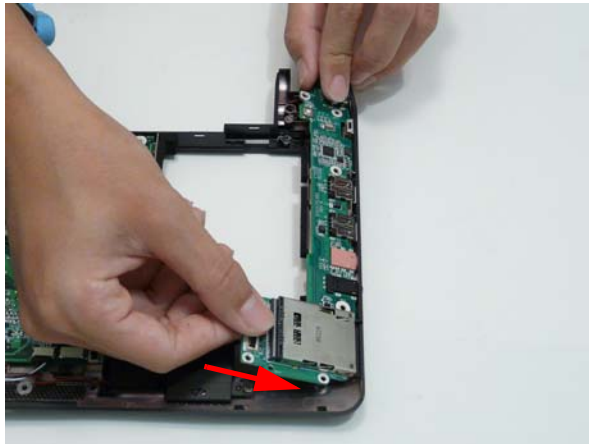

2. Replace the two screws.

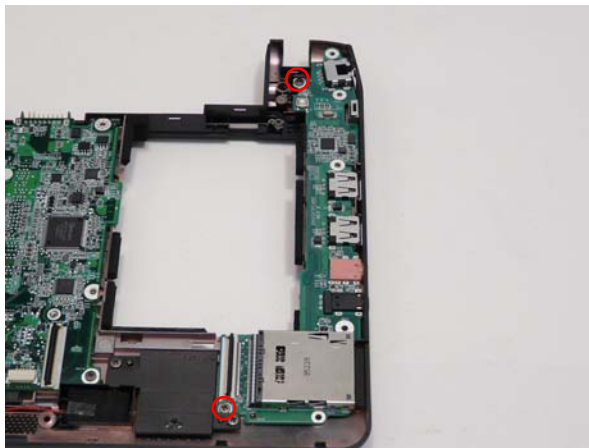

Screw List

Step	Screw	Quantity	Screw Type
I/O Card Assembly	2x3	2	

3. Connect the I/O card FCC to the I/O board.

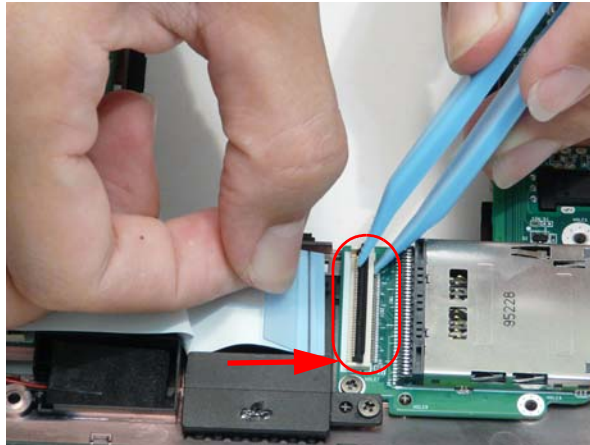

4. Connect the I/O card FCC to the main board.

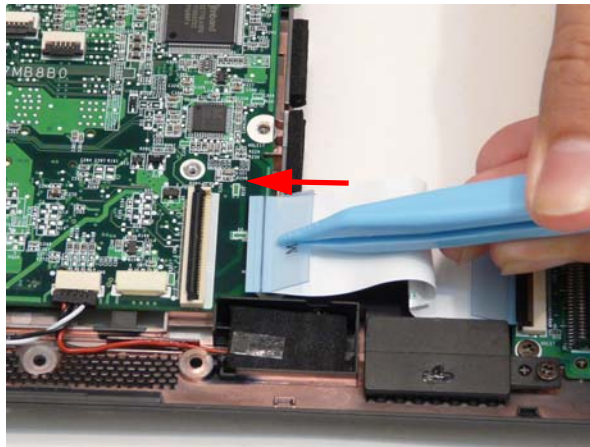

5. Lock the I/O Card FCC on the main board.

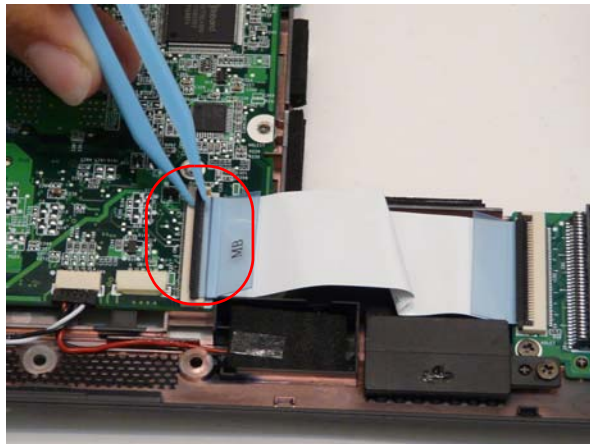

Replacing the Bluetooth Module

1. Connect the Bluetooth module cable to the Bluetooth module.

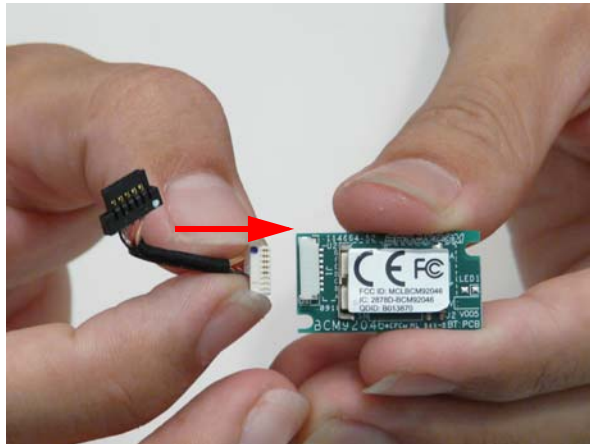

2. Apply adhesive and place the Bluetooth module into place pressing down firmly.

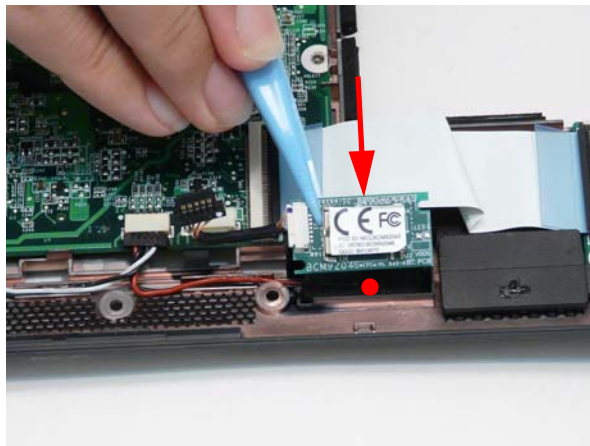

3. Connect the Bluetooth module cable to the main board.

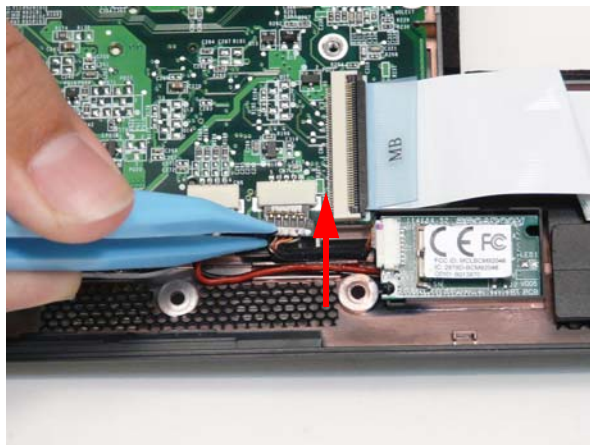

Replacing the LED Board

1. Connect the LED board FCC to the mainboard.

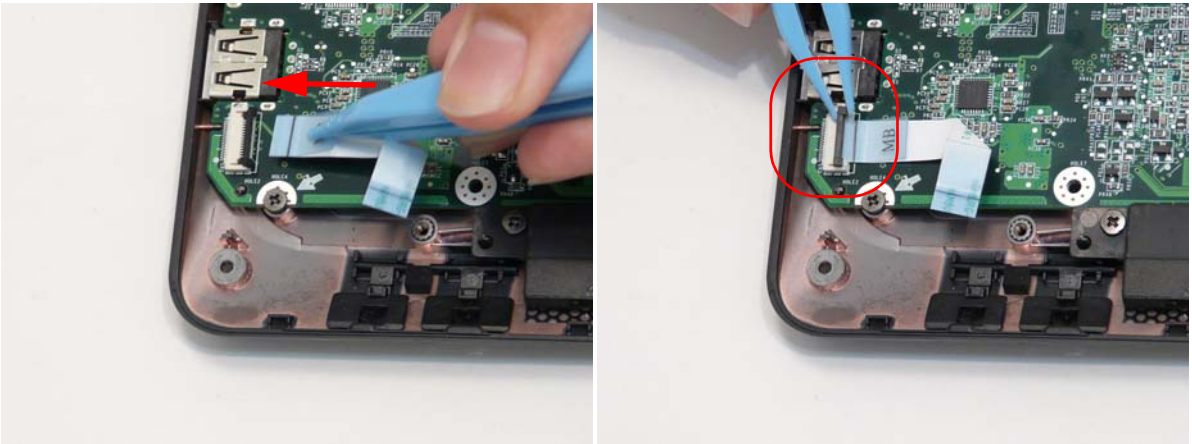

2. Place the LED board into place ensuring the slide switches on the front are properly aligned in the lower cover slots.

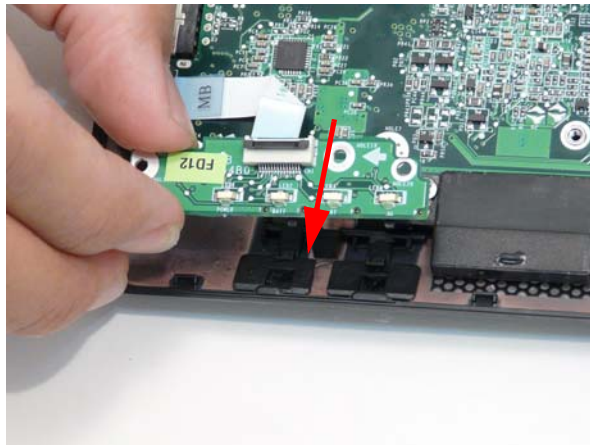

3. Replace the one screw.

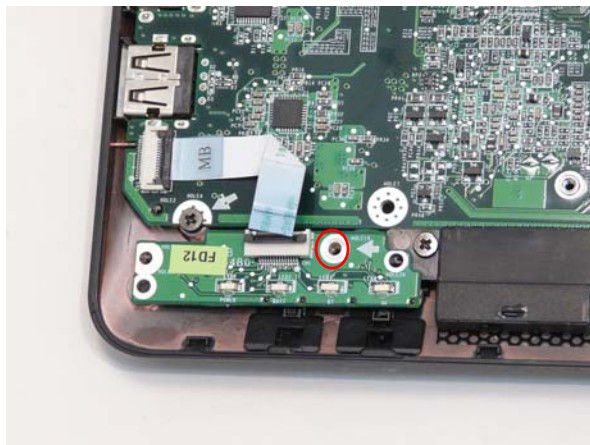

Screw List

Step	Screw	Quantity	Screw Type
LED Board Assembly	M2*3	1	

4. Connect the LED board FCC to LED board.

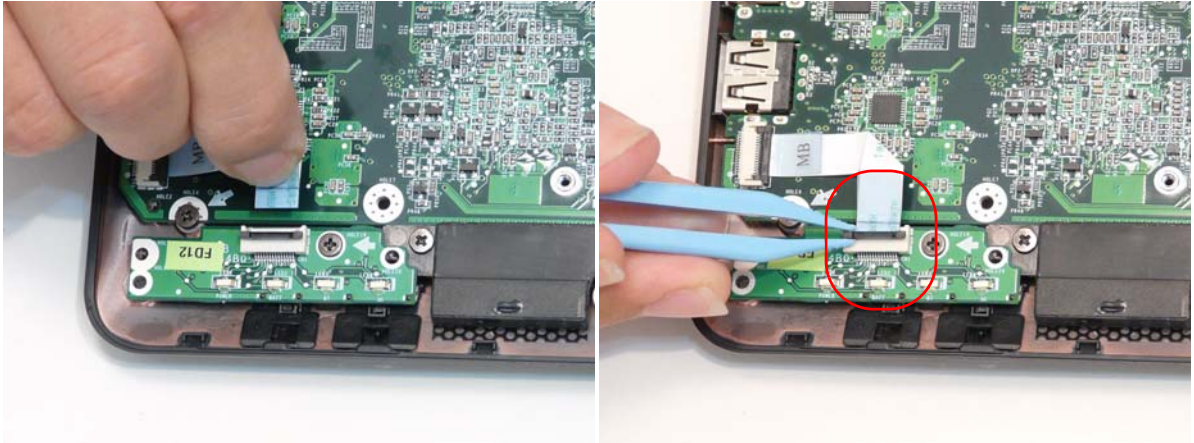

Replacing the LCD Module

1. Place the LCD module hinges into position on the lower case.



2. Replace the two screws.

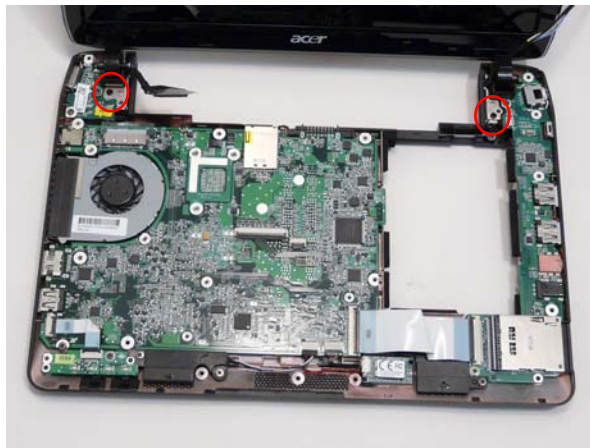

Screw List

Step	Screw	Quantity	Screw Type
LCD Module Assembly	M2x5	2	

3. Reconnect the LCD module connector.

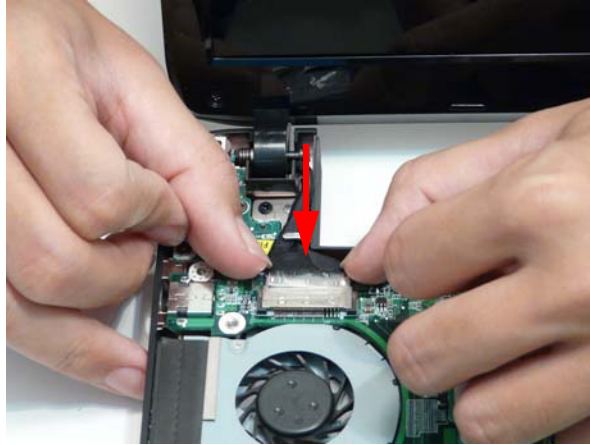

4. Press the adhesive plastic tape of the LCD module connector down firmly.

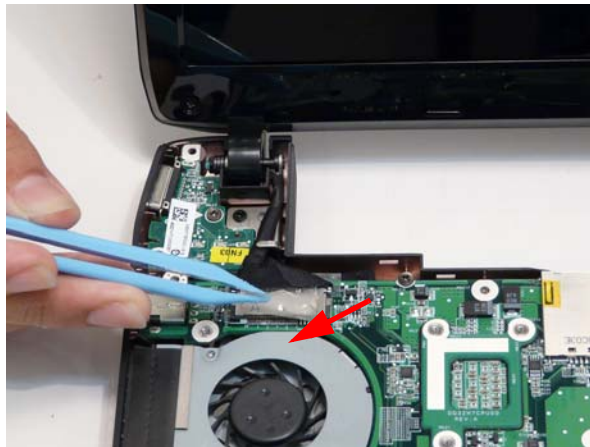

5. Relay the WLAN and 3M module cables around and through the lower case.

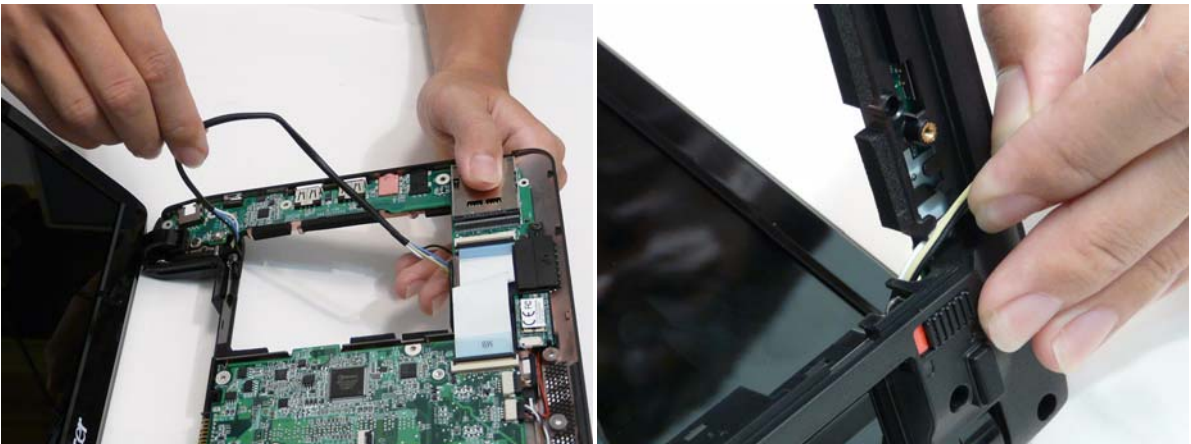

Replacing the Button Board

1. Apply adhesive and stick the touch pad FCC down onto the upper cover.

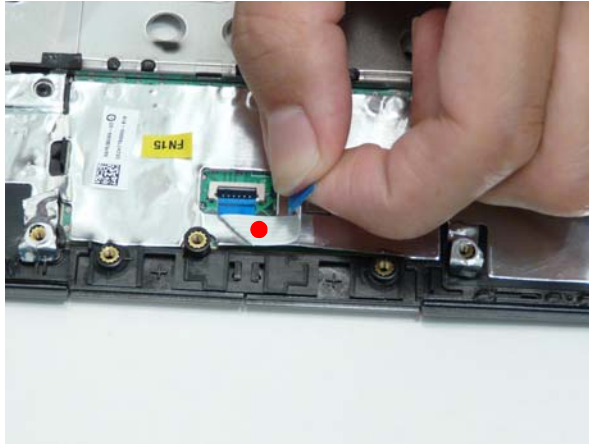

2. Connect the touch pad FCC to the touch pad.

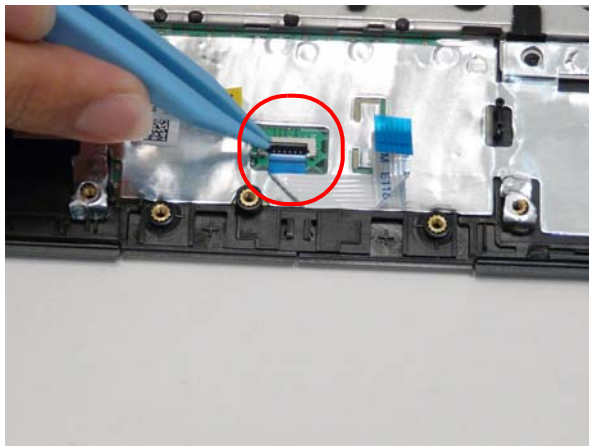

3. Place the button board onto the upper cover and replace the two screws.

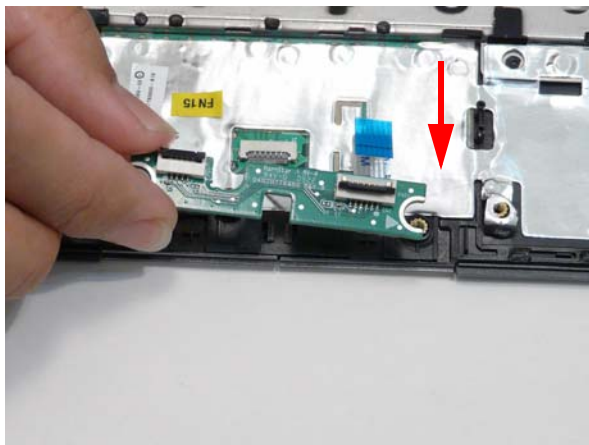

Screw List

Step	Screw	Quantity	Screw Type
Button Board Assembly	M2-0.4*2	2	

4. Connect the touch pad FCC to the button board.

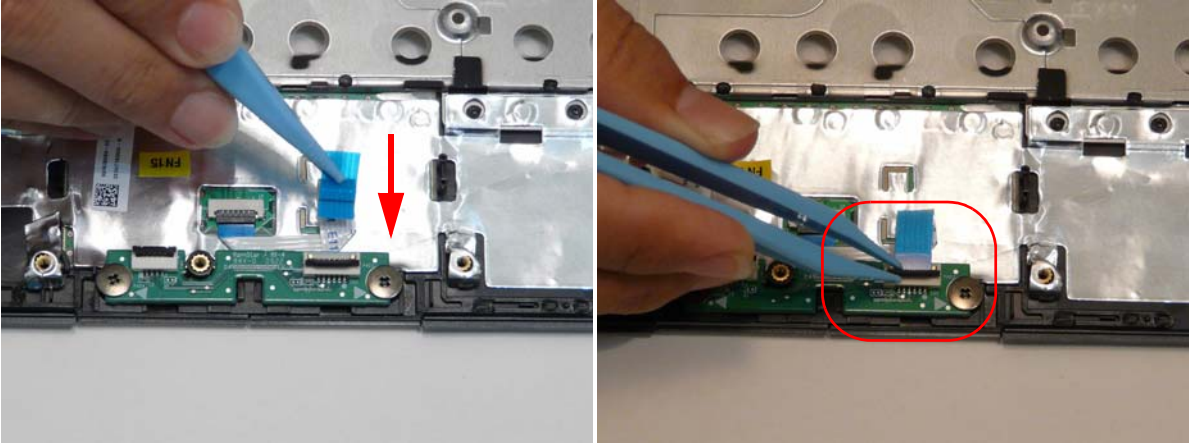

5. Bring the button board FCC through the upper cover.



6. Lay the button board FCC down carefully on the upper cover.

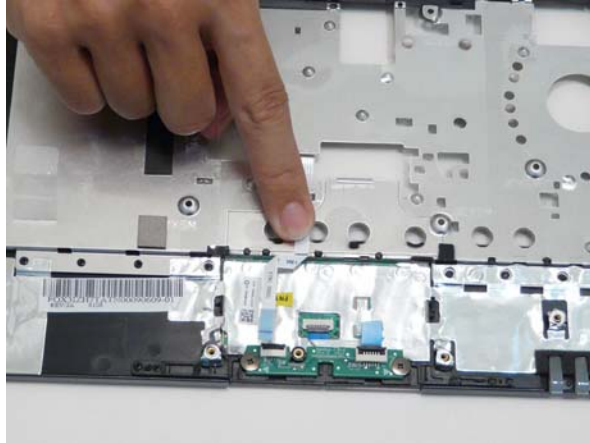

7. Connect the button board FCC to the button board.

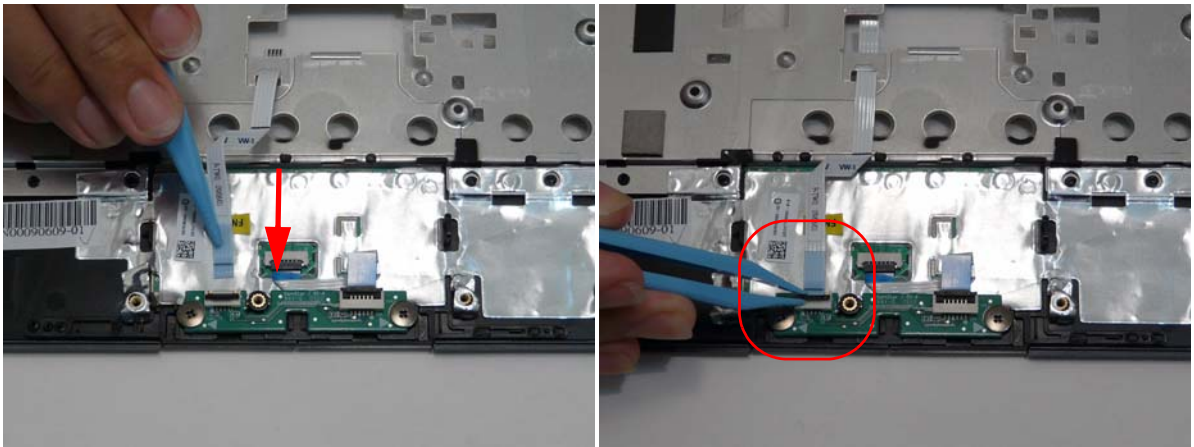

Replacing the Upper Cover

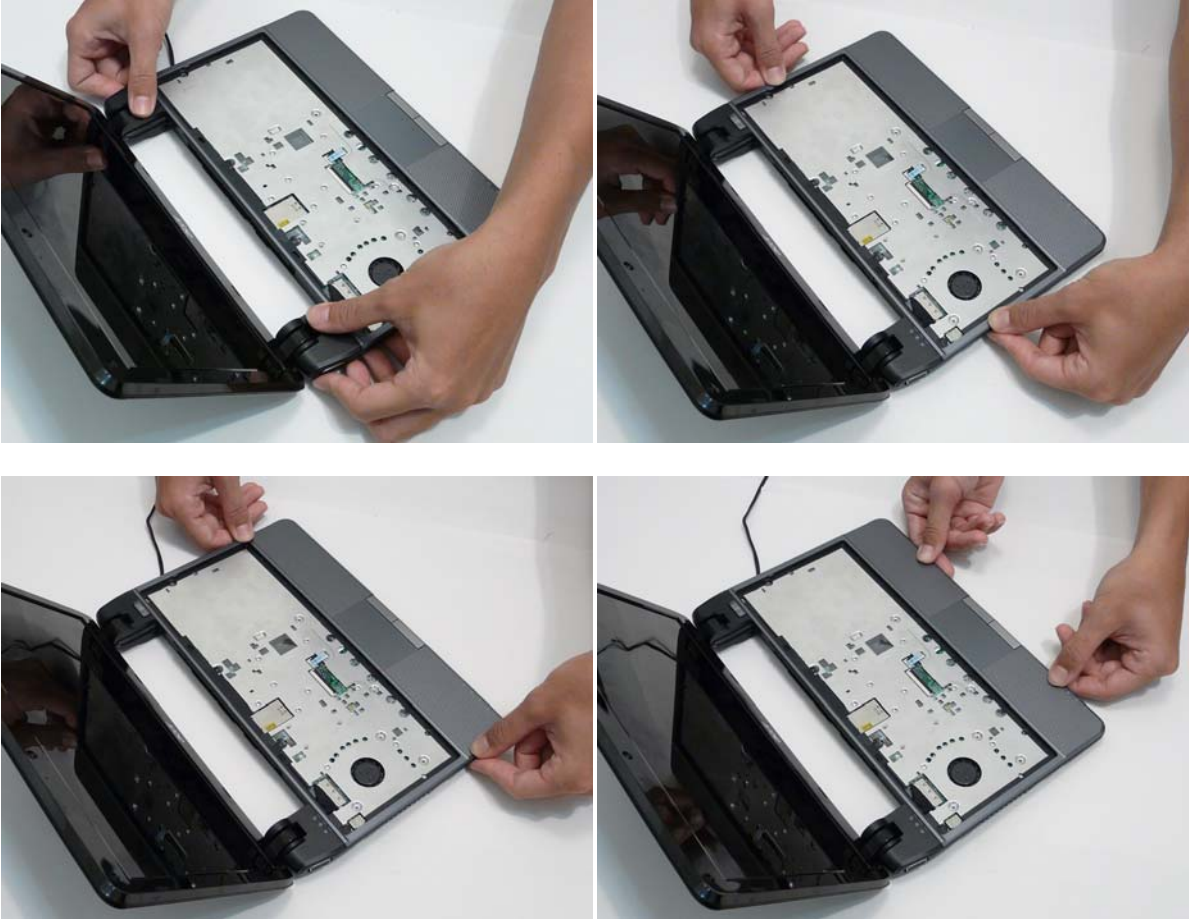

1. Place the upper cover onto the lower cover aligning the hinges first and then press down around the edges.

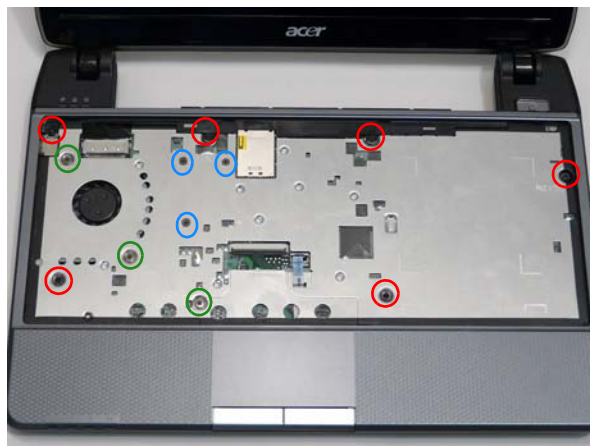

2. Replace the twelve screws.



Screw List

Step	Size	Quantity	Screw Type
Upper Cover Assembly	M2*2.5	3 (blue call out)	
	M2*3	3 (green call out)	
	M2*5	6 (red call out)	

3. Turn the computer over, put on the bottom cover and lay out the WLAN card and 3M module cables around and through the bottom cover.

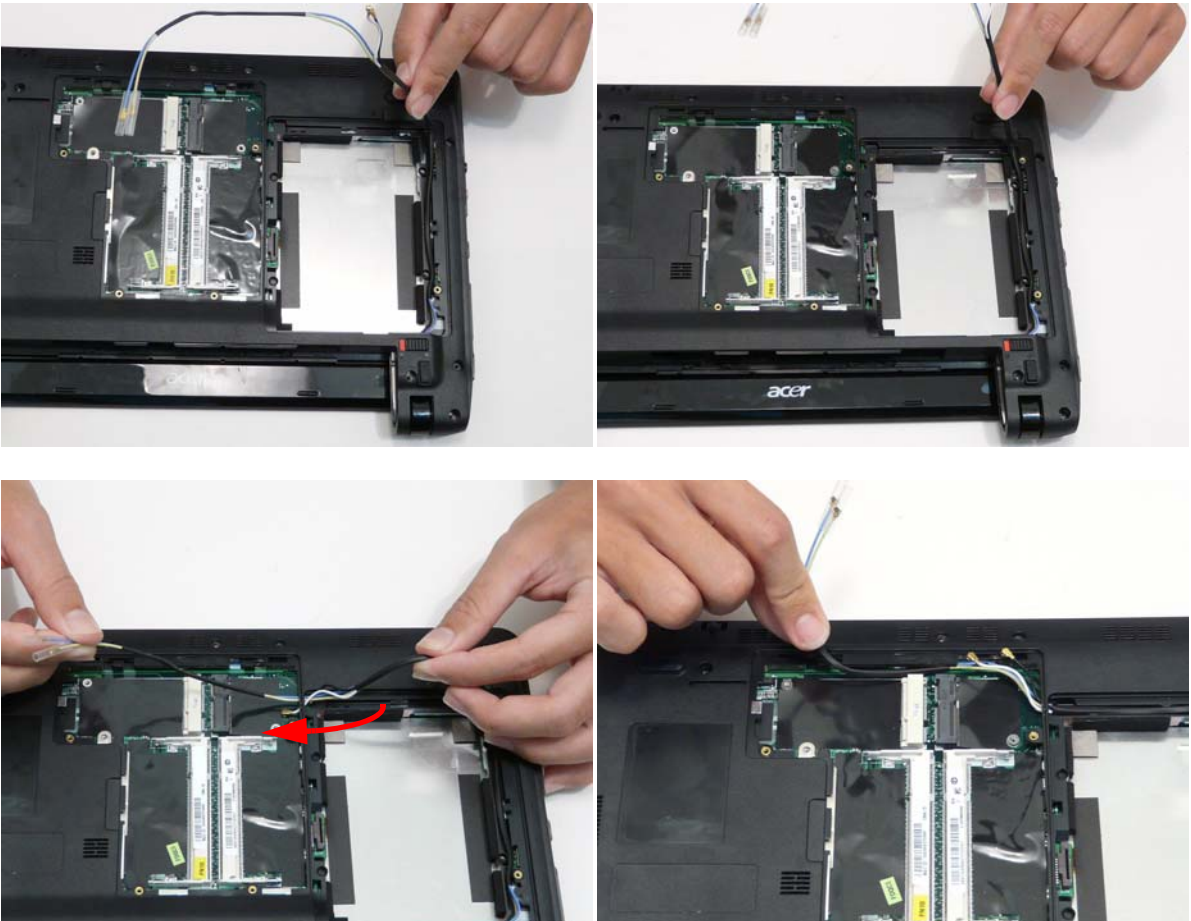

- Place adhesive tape over the 3M module cables.

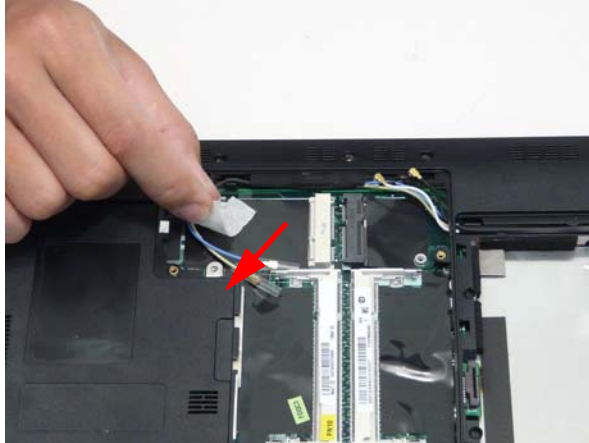

- Replace the bottom cover twelve screws.

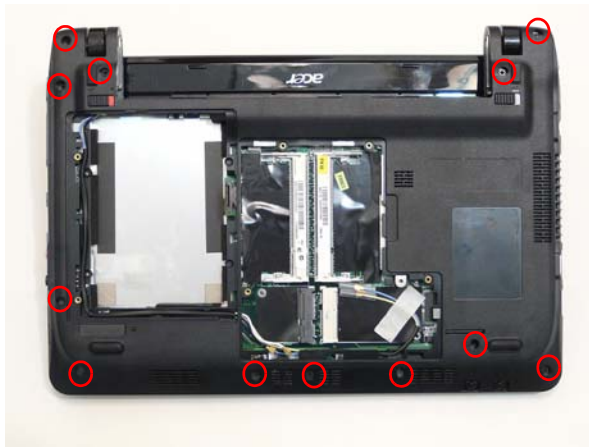

Screw List

Step	Size	Quantity	Screw Type
Upper Cover Assembly	M2*5	12	

- Turn the computer back over and connect the button board FCC to the main board.

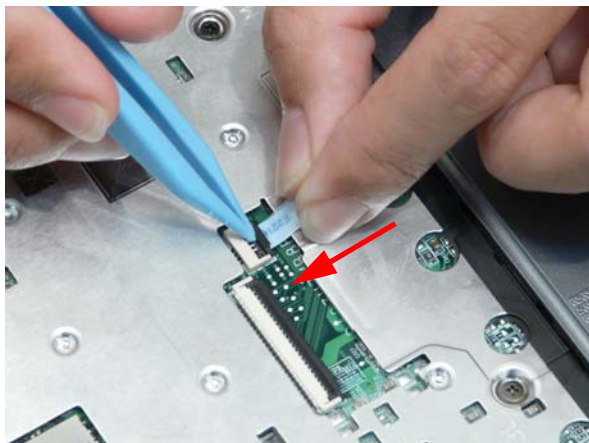

Replacing the Keyboard

1. Connect the FCC to the mainboard.

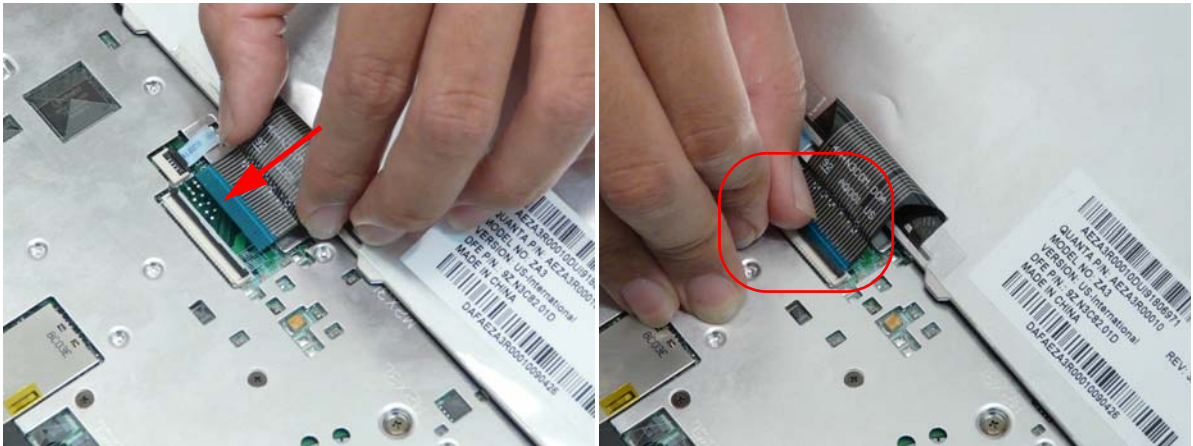

2. Turn the keyboard over and insert the bottom edge in.



3. Push down the top edge ensuring the four latches across the top are fully secured.



Replacing the Wireless LAN Module

1. Place the wireless LAN module into its connector.



2. Replace the one screw.



Screw List

Step	Size	Quantity	Screw Type
WLAN Assembly	M2*3	1	

3. Replace the connectors. The white (Aux) cable attaches to the connector marked **2** on the board. The black (Main) cable attaches to the connector marked **1** on the board.



Replacing the DIMM Module

1. Slide the DIMM module into the connector and press down till the locking springs click into place.

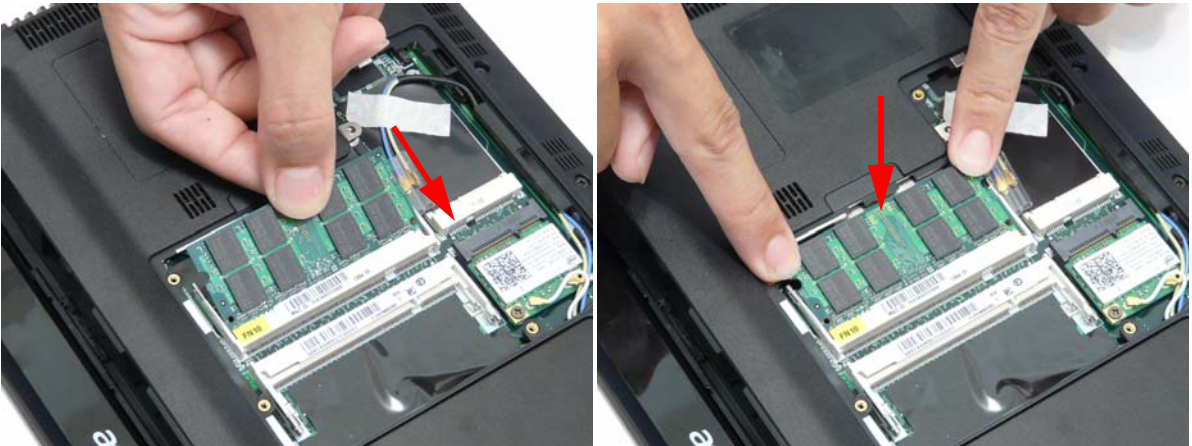

2. Repeat the process for the second DIMM module

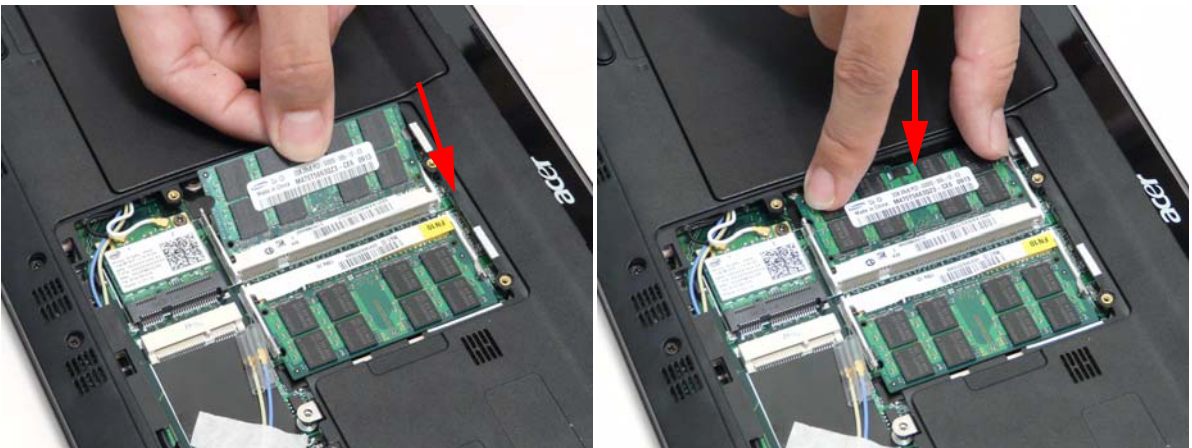

3. Place the DIMM module door down corner first.



-
4. Tighten the four captive screws.



Replacing the Hard Disk Drive

DISCLAIMER: The notebook sample in the following images shows an FFC. The actual model includes an FPC as pictured in the image on the right.



1. Connect the HDD FPC to the HDD.

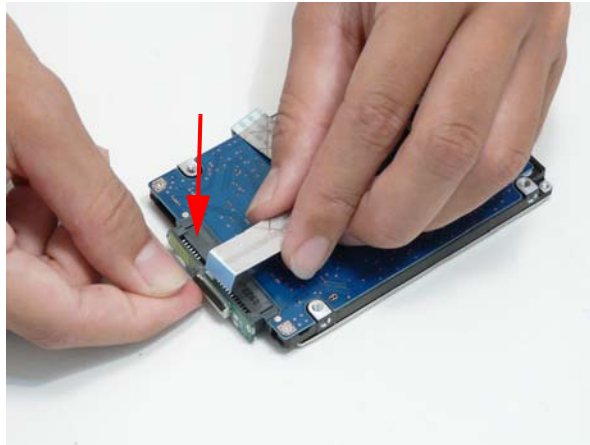

2. Lift up the clear plastic tab and place the HDD into its bay.



3. Connect the HDD FPC to the main board.



NOTE: The cable pictured in the above images may differ from the actual sample.

-
4. Place the HDD cover in from one corner.



5. Tighten the two captive screws.



Replacing the Battery

1. Slide the battery into position.



2. Close the locking latch.



Replace the Dummy Card

Push the dummy card into the slot until it clicks into place.



Troubleshooting

Common Problems

Use the following procedure as a guide for computer problems.

NOTE: The diagnostic tests are intended to test only Acer products. Non-Acer products, prototype cards, or modified options can give false errors and invalid system responses.

1. Obtain the failing symptoms in as much detail as possible.
2. Verify the symptoms by attempting to re-create the failure by running the diagnostic test or by repeating the same operation.
3. Use the following table with the verified symptom to determine which page to go to.

Symptoms (Verified)	Go To
Power On Issue	Page 132
No Display Issue	Page 133
LCD Failure	Page 135
Internal Keyboard Failure	Page 136
TouchPad Failure	Page 137
Internal Speaker Failure	Page 138
Internal Microphone Failure	Page 139
USB Failure	Page 141
Other Function Failure	Page 141

4. If the Issue is still not resolved, see "Online Support Information" on page 241.

Power On Issue

If the system doesn't power on, perform the following actions one at a time to correct the problem. Do not replace non-defective FRUs:

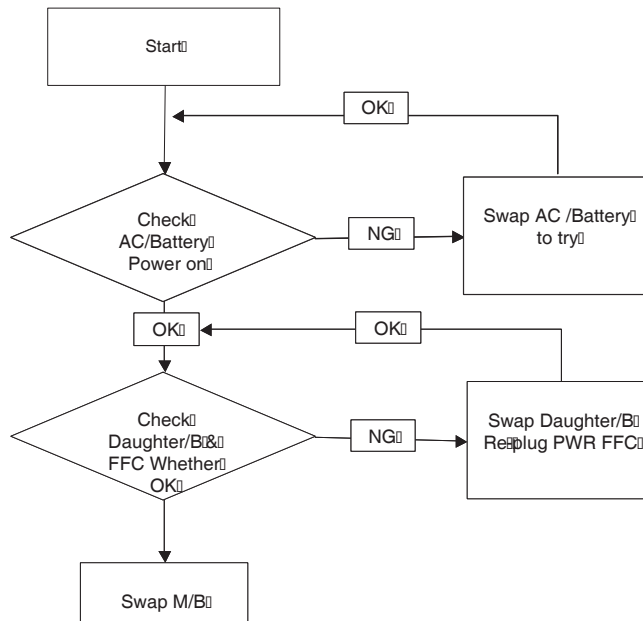

Computer Shuts down Intermittently

If the system powers off at intervals, perform the following actions one at a time to correct the problem.

1. Check the power cable is properly connected to the computer and the electrical outlet.
2. Remove any extension cables between the computer and the outlet.
3. Remove any surge protectors between the computer and the electrical outlet. Plug the computer directly into a known good electrical outlet.
4. Remove all external and non-essential hardware connected to the computer that are not necessary to boot the computer to the failure point.
5. Remove any recently installed software.
6. If the Issue is still not resolved, see "Online Support Information" on page 241.

No Display Issue

If the **Display** doesn't work, perform the following actions one at a time to correct the problem. Do not replace non-defective FRUs:

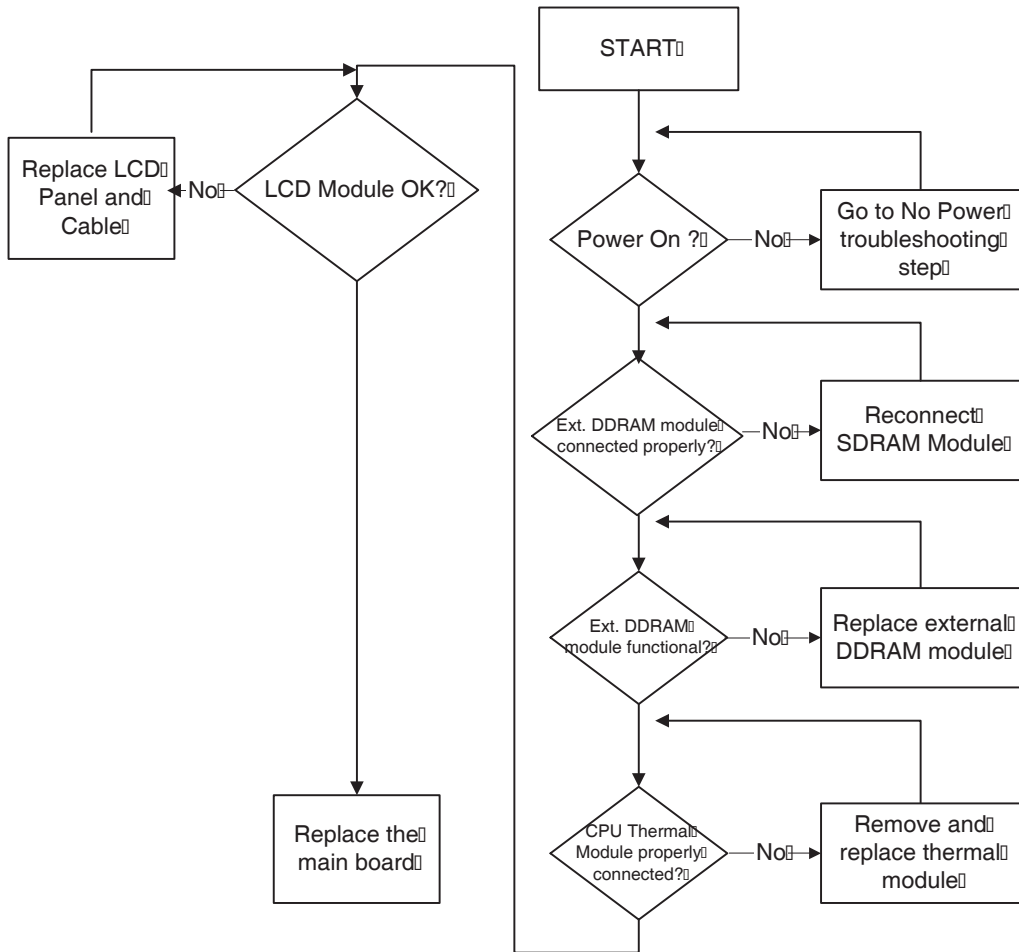

No POST or Video

If the POST or video doesn't display, perform the following actions one at a time to correct the problem.

1. Make sure that the internal display is selected. On this notebook model, switching between the internal display and the external display is done by pressing **Fn+F5**. Reference Product pages for specific model procedures.
2. Make sure the computer has power by checking at least one of the following occurs:
 - Fans start up
 - Status LEDs light up

If there is no power, see “Power On Issue” on page 132.

3. Drain any stored power by removing the power cable and battery and holding down the power button for 10 seconds. Reconnect the power and reboot the computer.
4. Connect an external monitor to the computer and switch between the internal display and the external display is by pressing **Fn+F5** (on this model).

If the POST or video appears on the external display, see “LCD Failure” on page 135.

5. Disconnect power and all external devices including port replicators or docking stations. Remove any memory cards and CD/DVD discs. Restart the computer.

If the computer boots correctly, add the devices one by one until the failure point is discovered.

6. Reseat the memory modules.
7. Remove the drives (see “Disassembly Process” on page 43).
8. If the Issue is still not resolved, see “Online Support Information” on page 241.

Abnormal Video Display

If video displays abnormally, perform the following actions one at a time to correct the problem.

1. Reboot the computer.
2. If permanent vertical/horizontal lines or dark spots display in the same location, the LCD is faulty and should be replaced. See “Disassembly Process” on page 43.
3. If extensive pixel damage is present (different colored spots in the same locations on the screen), the LCD is faulty and should be replaced. See “Disassembly Process” on page 43.
4. Adjust the brightness to its highest level. See the User Manual for instructions on adjusting settings.
NOTE: Ensure that the computer is not running on battery alone as this may reduce display brightness.

If the display is too dim at the highest brightness setting, the LCD is faulty and should be replaced. See “Disassembly Process” on page 43.

5. Check the display resolution is correctly configured:
 - a. Minimize or close all Windows.
 - b. If display size is only abnormal in an application, check the view settings and control/mouse wheel zoom feature in the application.
 - c. If desktop display resolution is not normal, right-click on the desktop and select **Personalize**→ **Display Settings**.
 - d. Click and drag the Resolution slider to the desired resolution.
 - e. Click **Apply** and check the display. Readjust if necessary.
6. Roll back the video driver to the previous version if updated.
7. Remove and reinstall the video driver.
8. Check the Device Manager to determine that:
 - The device is properly installed. There are no red Xs or yellow exclamation marks.
 - There are no device conflicts.
 - No hardware is listed under Other Devices.
9. If the Issue is still not resolved, see “Online Support Information” on page 241.
10. Run the Windows Memory Diagnostic from the operating system DVD and follow the onscreen prompts.
11. If the Issue is still not resolved, see “Online Support Information” on page 241.

Random Loss of BIOS Settings

If the computer is experiencing intermittent loss of BIOS information, perform the following actions one at a time to correct the problem.

1. If the computer is more than one year old, replace the CMOS battery.
2. Run a complete virus scan using up-to-date software to ensure the computer is virus free.
3. If the computer is experiencing HDD or ODD BIOS information loss, disconnect and reconnect the power and data cables between devices.

If the BIOS settings are still lost, replace the cables.

4. If HDD information is missing from the BIOS, the drive may be defective and should be replaced.
5. Replace the Motherboard.

6. If the Issue is still not resolved, see "Online Support Information" on page 241.

LCD Failure

If the **LCD** fails, perform the following actions one at a time to correct the problem. Do not replace non-defective FRUs:

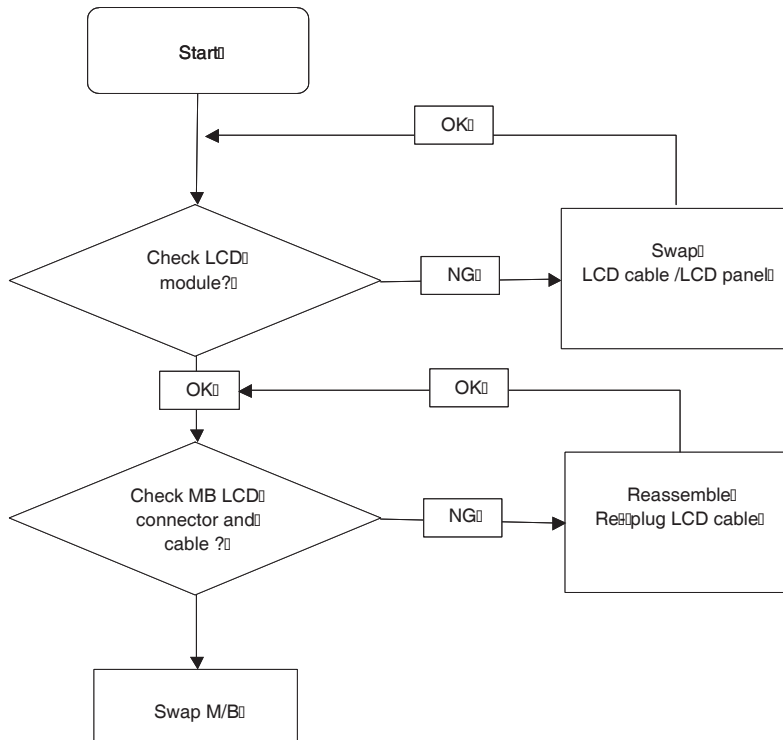

Built-In Keyboard Failure

If the built-in **Keyboard** fails, perform the following actions one at a time to correct the problem. Do not replace non-defective FRUs:

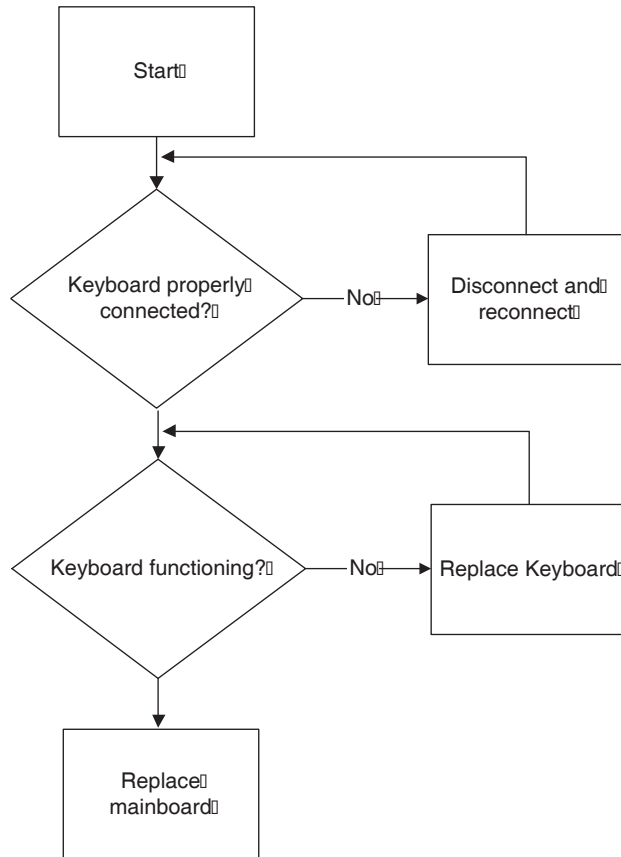

TouchPad Failure

If the **TouchPad** doesn't work, perform the following actions one at a time to correct the problem. Do not replace non-defective FRUs:

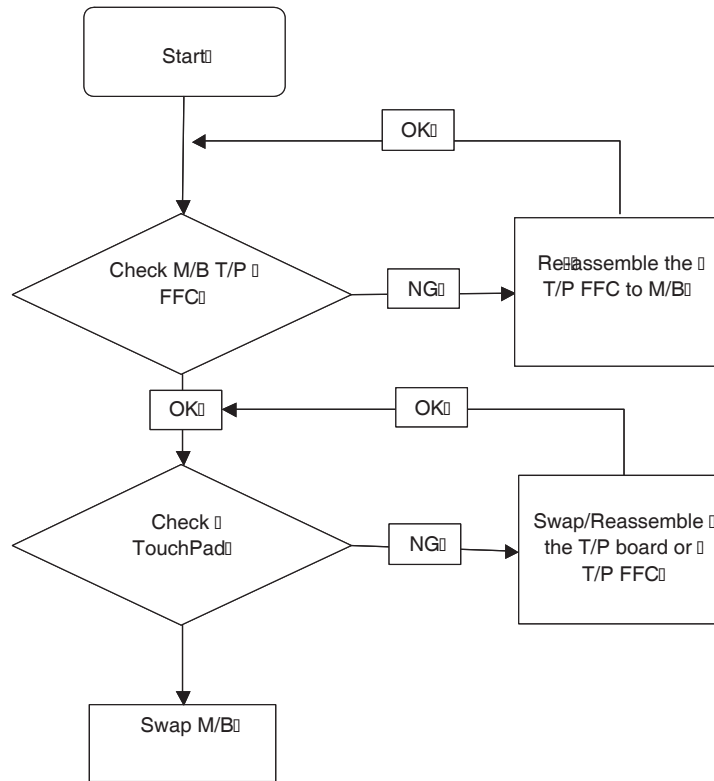

Internal Speaker Failure

If the internal **Speakers** fail, perform the following actions one at a time to correct the problem. Do not replace non-defective FRUs:

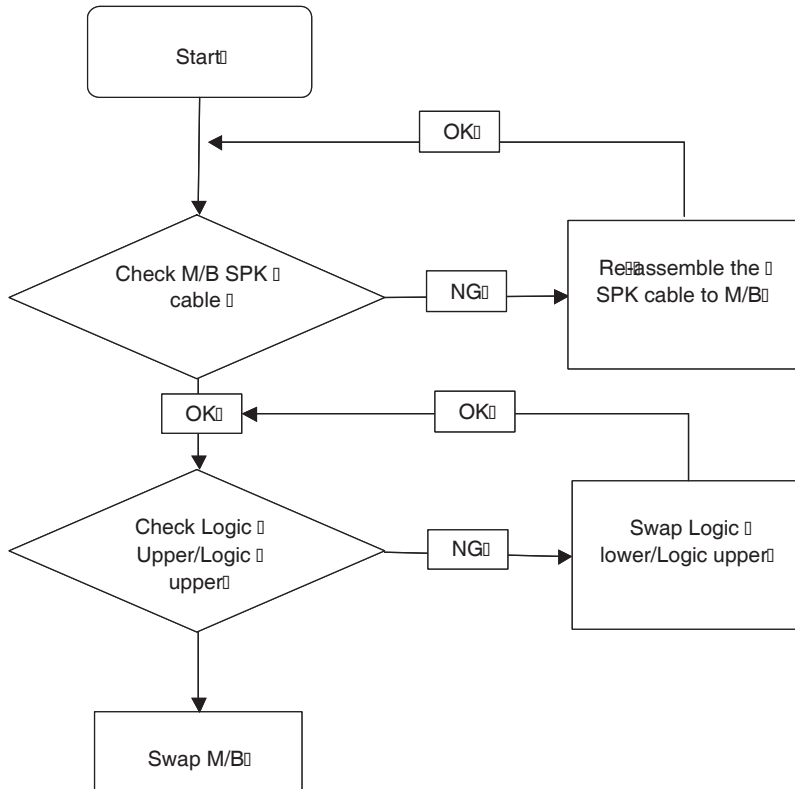

Sound Problems

If sound problems are experienced, perform the following actions one at a time to correct the problem.

1. Reboot the computer.
2. Navigate to **Start** → **Control Panel** → **System and Maintenance** → **System** → **Device Manager**. Check the Device Manager to determine that:
 - The device is properly installed.
 - There are no red Xs or yellow exclamation marks.
 - There are no device conflicts.
 - No hardware is listed under Other Devices.
3. Roll back the audio driver to the previous version, if updated recently.
4. Remove and reinstall the audio driver.
5. Ensure that all volume controls are set mid range:
 - a. Click the volume icon on the taskbar and drag the slider to 50. Ensure that the volume is not muted.
 - b. Click Mixer to verify that other audio applications are set to 50 and not muted.
6. Navigate to **Start** → **Control Panel** → **Hardware and Sound** → **Sound**. Ensure that Speakers are selected as the default audio device (green check mark).

NOTE: If Speakers does not show, right-click on the **Playback** tab and select **Show Disabled Devices** (clear by default).
7. Select Speakers and click **Configure** to start **Speaker Setup**. Follow the onscreen prompts to configure the speakers.

8. Remove and recently installed hardware or software.
9. Restore system and file settings from a known good date using **System Restore**.
If the issue is not fixed, repeat the preceding steps and select an earlier time and date.
10. Reinstall the Operating System.
11. If the Issue is still not resolved, see “Online Support Information” on page 241.

Internal Microphone Failure

If the internal **Microphone** fails, perform the following actions one at a time to correct the problem. Do not replace non-defective FRUs:

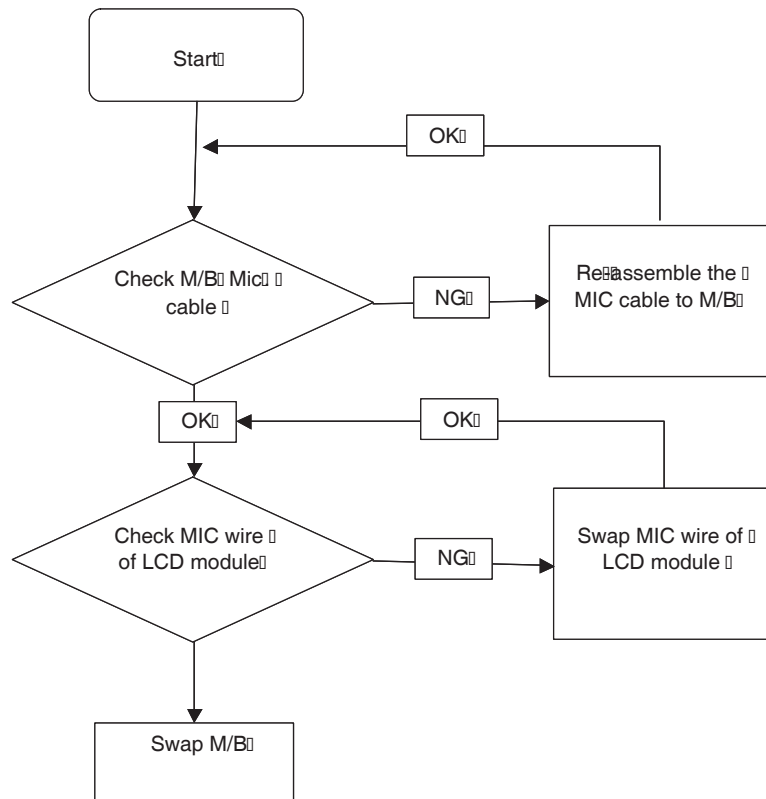

Microphone Problems

If internal or external **Microphones** do not operate correctly, perform the following actions one at a time to correct the problem.

1. Check that the microphone is enabled. Navigate to **Start** → **Control Panel** → **Hardware and Sound** → **Sound** and select the **Recording** tab.
2. Right-click on the **Recording** tab and select **Show Disabled Devices** (clear by default).
3. The microphone appears on the **Recording** tab.
4. Right-click on the microphone and select **Enable**.
5. Select the microphone then click **Properties**. Select the **Levels** tab.
6. Increase the volume to the maximum setting and click **OK**.
7. Test the microphone hardware:
 - a. Select the microphone and click **Configure**.
 - b. Select **Set up microphone**.

-
- c. Select the microphone type from the list and click **Next**.
 - d. Follow the onscreen prompts to complete the test.
8. If the Issue is still not resolved, see “Online Support Information” on page 241.

HDD Not Operating Correctly

If the **HDD** does not operate correctly, perform the following actions one at a time to correct the problem.

1. Disconnect all external devices.
2. Run a complete virus scan using up-to-date software to ensure the computer is virus free.
3. Run the Windows Vista Startup Repair Utility:
 - a. insert the Windows Vista Operating System DVD in the ODD and restart the computer.
 - b. When prompted, press any key to start to the operating system DVD.
 - c. The **Install Windows** screen displays. Click **Next**.
 - d. Select **Repair your computer**.
 - e. The **System Recovery Options** screen displays. Click **Next**.
 - f. Select the appropriate operating system, and click **Next**.

NOTE: Click **Load Drivers** if controller drives are required.

- g. Select **Startup Repair**.
- h. Startup Repair attempts to locate and resolve issues with the computer.
- i. When complete, click **Finish**.

If an issue is discovered, follow the onscreen information to resolve the problem.

4. Run the Windows Memory Diagnostic Tool. For more information see Windows Help and Support.
5. Restart the computer and press F2 to enter the BIOS Utility. Check the BIOS settings are correct and that CD/DVD drive is set as the first boot device on the Boot menu.
6. Ensure all cables and jumpers on the HDD and ODD are set correctly.
7. Remove any recently added hardware and associated software.
8. Run the Windows Disk Defragmenter. For more information see Windows Help and Support.
9. Run Windows Check Disk by entering **chkdsk /r** from a command prompt. For more information see Windows Help and Support.
10. Restore system and file settings from a known good date using **System Restore**.

If the issue is not fixed, repeat the preceding steps and select an earlier time and date.
11. Replace the HDD. See “Disassembly Process” on page 43.

USB Failure (Right up/down side)

If the rightside **USB** port fails, perform the following actions one at a time to correct the problem. Do not replace non-defective FRUs:

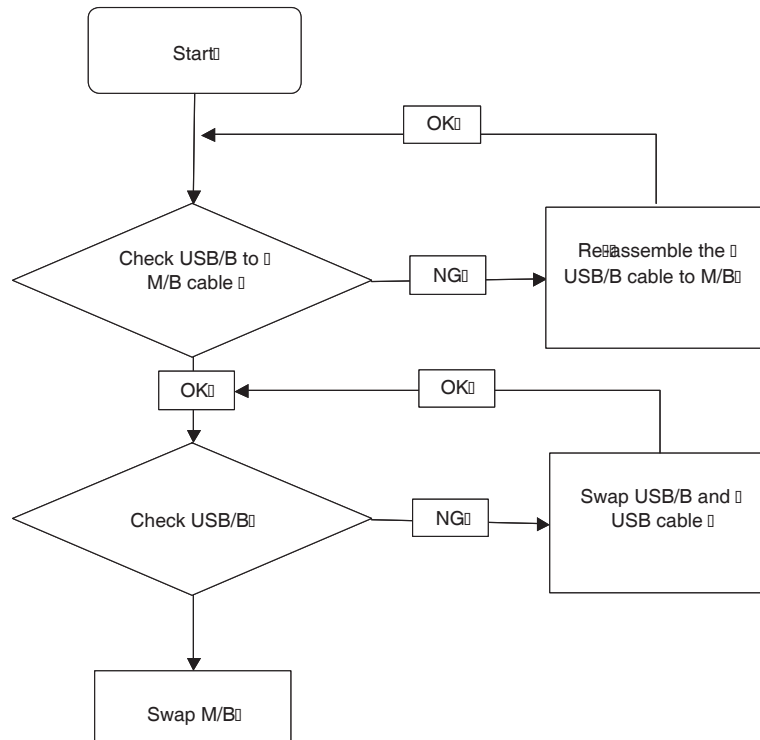

Other Failures

If the VGA board, LAN Port, external MIC or Speakers, PCI Express Card, 5-in-1 Card Reader or Volume Wheel fail, perform the following general steps to correct the problem. Do not replace non-defective FRUs:

1. Check whether the drive is OK.
2. Verify that the Test Fixture is ok.
3. Swap the mainboard and retest.

Intermittent Problems

Intermittent system hang problems can be caused by a variety of reasons that have nothing to do with a hardware defect, such as: cosmic radiation, electrostatic discharge, or software errors. FRU replacement should be considered only when a recurring problem exists.

When analyzing an intermittent problem, do the following:

1. Run the advanced diagnostic test for the system board in loop mode at least 10 times.
2. If no error is detected, do not replace any FRU.
3. If any error is detected, replace the FRU. Rerun the test to verify that there are no more errors.

Undetermined Problems

The diagnostic problems does not identify which adapter or device failed, which installed devices are incorrect, whether a short circuit is suspected, or whether the system is inoperative.

Follow these procedures to isolate the failing FRU (do not isolate non-defective FRU).

NOTE: Verify that all attached devices are supported by the computer.

NOTE: Verify that the power supply being used at the time of the failure is operating correctly. (See "Power On Issue" on page 132.):

1. Power-off the computer.
2. Visually check them for damage. If any problems are found, replace the FRU.
3. Remove or disconnect all of the following devices:
 - Non-Acer devices
 - Printer, mouse, and other external devices
 - Battery pack
 - Hard disk drive
 - DIMM
 - CD-ROM/Diskette drive Module
 - PC Cards
4. Power-on the computer.
5. Determine if the problem has changed.
6. If the problem does not recur, reconnect the removed devices one at a time until you find the failing FRU.
7. If the problem remains, replace the following FRU one at a time. Do not replace a non-defective FRU:
 - System board
 - LCD assembly

POST Code Reference Tables

These tables describe the POST codes and components of the POST process.

POST Routine Description	Code
PeiEventLog	01
OemServices	02
SioInit	03
MonoStatusCode	04
PentiumMCpuPeim	08
PlatformStage1	09
Variable	0A
IchInit	0B
PlatformStage2	0D
IchSmbusArpDisabled	0E
ClockGen	12
OpPresence	13
TcgPei	14
FindFv	15
DxeIpl	2F
LightMemoryInit	10
S3ResumeSoftSmi	11
Crc32SectionExtract	31
OemServices	A4
EventLog	A5
ScriptSave	32
AcpiS3Save	33
SmartTimer	34
JpegDecoder	35
PcxDecoder	36
PlatformBds	8A
MpCpu	37
LegacyMetronome	38
FtwLite	39
Runtime	3A
MonotonicCounter	3B
WatchDogTimer	3C
SecurityStub	3D
Cpulo	3E
Cf9Reset	3F
PcRtc	40
StatusCode	41
Variable	42
SmmVariable	CF
EmuVariable	43

POST Routine Description	Code
TcgDxe	A2
PhysicalPresence	A3
TpmDriver	AE
TcgSmm	AE
PhysicalPresenceReadyToBoot	AE
DataHubRecordPolicy	AD
Undi	86
SNP	90
BC	91
PxeDhcp4	92
Ebc	93
IsaBus	4D
IsaSerial	4E
Ps2Mouse	6D
IdeBus	4F
LightPciBus	50
UsbBot	6E
UsbCbi0	6F
UsbCbi1	70
UsbKb	71
UsbMassStorage	72
UsbMouse	74
Ehci	8F
Uhci	73
UsbBus	75
SmmBase	C2
SmmDisp	C5
SmmReloc	C4
SmmRuntime	C7
SmmThunk	C9
OemServices	D8
ChipsetInit	44
SmmAccess	C0
PciHostBridge	46
PciExpress	47
GmchMbi	CD
IchInit	48
IdeController	49
SataController	4A
IchSmbusLight	4B
SmmControl	C1
Ich7MSmmDispatcher	C8
IsaAcpiDriver	4C

POST Routine Description	Code
Fwh	52
SmmFwh	CE
PciHotPlug	54
BootOptionPolicy	51
SetupUtility	76
Platform	55
PlatformIde	56
Ppm	D9
Platform	CC
Ihisi	D0
SetupMouse	f9
Int15Microcode	D1
SmmPnp	D2
Smbios	57
MemorySubClass	58
MiscSubclassDriver	59
SysPassword	AB
PswdConsole	AC
HddPswdServiceBody	D7
HddPswdService	A6
HiiDatabase	80
OemSetupBrowser	82
Font(English)	7E
Font(French)	7F
Font(Chinese)	8D
UnicodeCollation	B1
ConPlatform	5A
ConSplitter	5D
GraphicsConsole	79
Terminal	7A
VgaClass	5E
SaveMemoryConfig	5B
AcpiSupport	5C
AcpiPlatform	53
DataHub	5F
DataHubStdErr	7B
GenericMemoryTest	61
Disklo	60
Fat	7C
Partition	7D
PciPlatform	6B
AlertStandardForma	45
PciSerial	A8

POST Routine Description	Code
AsfInit	A7
IdeRController	A9
Legacy8259	63
LegacyRegion	64
LegacyInterrupt	65
BiosKeyboard	66
BiosVideo	67
MonitorKey	68
LegacyBios	69
LegacyBiosPlatform	6A
LegacyMouse	77
SmmUsbLegacy	78
AmtbxInvoke	AA
OemBadgingSupport	83

Jumper and Connector Locations

Mainboard Top View

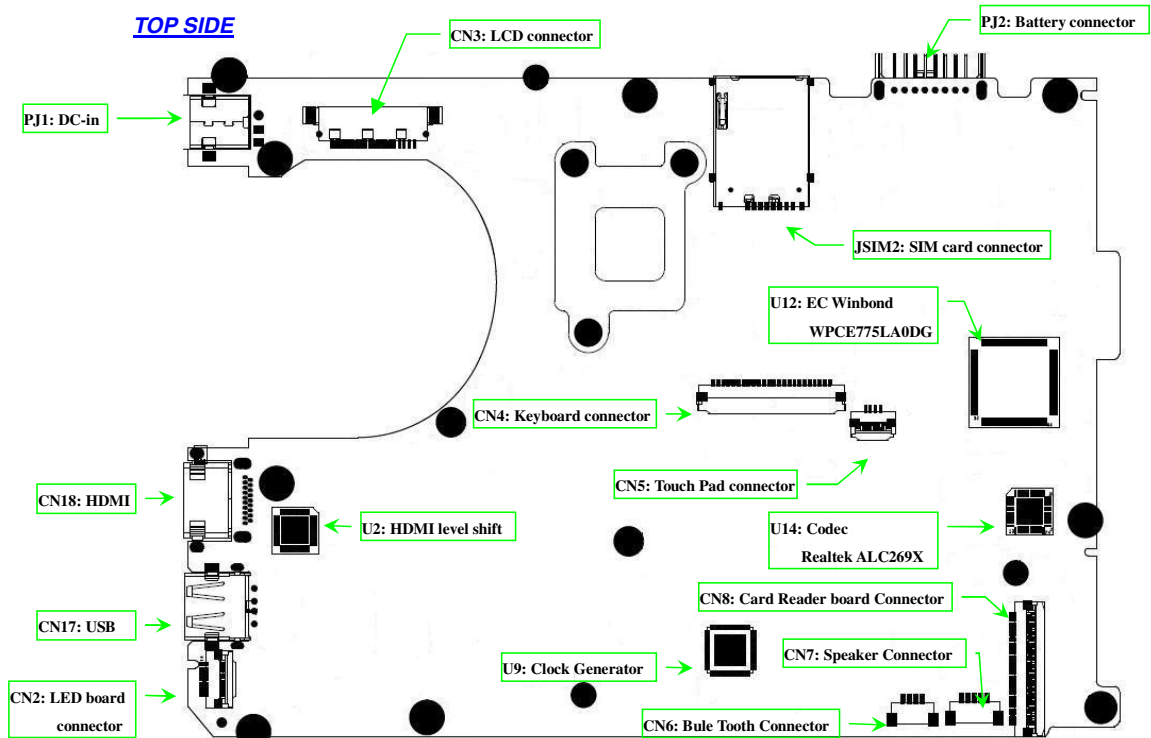

Item	Description	Item	Description
PJ1	DC-in	CN6	Bluetooth Connector
CN3	LCD connector	U9	Clock Generator
JSIM2	SIM card connector	CN2	LED board connector
PJ2	Battery connector	CN17	USB connector
U12	EC Winbond	CN18	HDMI
U14	Codec	U2	HDMI level shift
CN8	Card reader board connector	CN4	Keyboard connector
CN7	Speaker Connector	CN5	Touch Pad connector

Mainboard Bottom View

BOTTOM SIDE

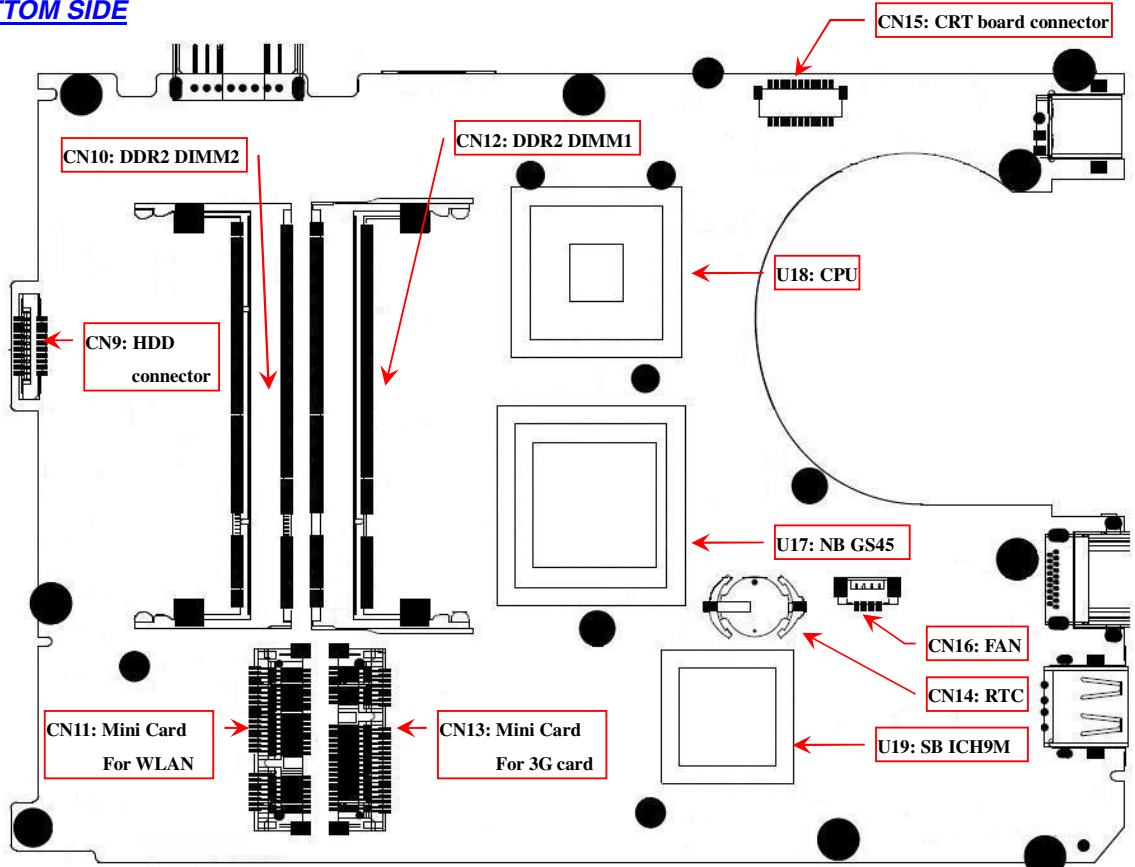

Item	Description	Item	Description
CN10	DDR2 DIMM2	CN14	RTC
CN12	DDR2 DIMM1	U19	SB ICH9M
U18	CPU	CN13	Mini Card
U17	NB GS45	CN11	Mini Card (WLAN)
CN16	Fan	CN9	HDD

Clearing Password Check and BIOS Recovery

This section provides a procedure for clearing the password and BIOS. The Hardware Open Gap on the main board clears the CMOS of all user settings and restores factory defaults.

Mainboard CMOS Discharge

Discharging the CMOS clears all user settings.

1. Disassemble the notebook and take out the Mainboard. See “Removing the Mainboard” on page 71.
2. Remove the RTC battery. See “Removing the RTC Battery” on page 75.



3. Turn the mainboard over and short the G2 pad.

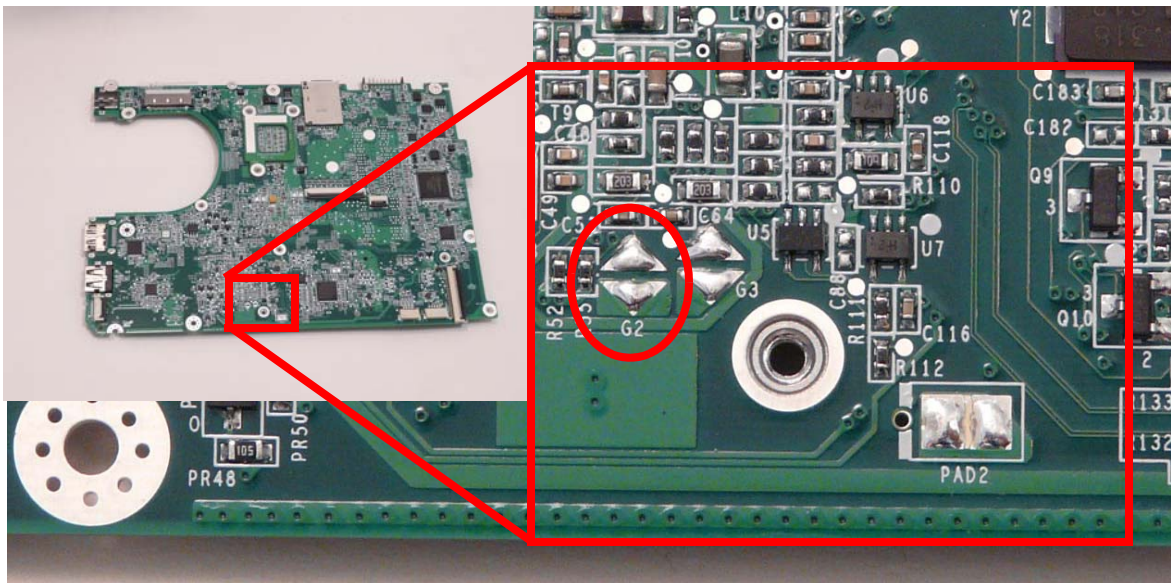

4. Reconnect the RTC battery and reassemble the unit.

BIOS Recovery by Crisis Disk

BIOS Recovery Boot Block

The BIOS Recovery Boot Block is a special block of BIOS. It is used to boot up the system with minimum BIOS initialization. Users can enable this feature to restore the BIOS firmware to the factory settings if a BIOS flash process fails.

BIOS Recovery Hotkey

The system provides a function hotkey: **Fn+Esc**, to enable the BIOS Recovery process when a system is powered on during BIOS POST. To use this function, it is strongly recommended to have the AC adapter and Battery present. If this function is enabled, the system will force the BIOS to enter a special BIOS block, called Boot Block.

Steps for BIOS Recovery from USB Storage

Before performing this procedure, prepare a Crisis USB key. The Crisis USB key can be made by executing the Crisis Disk program in a functioning system with a Windows XP or Vista OS.

IMPORTANT:The Crisis Disk program will overwrite all data on any drive that you use as a crisis disk.

Follow the steps below:

1. Modify the archive name from "zh7 bios" to "ZH7X64.fd"
2. Save ROM file (file name: **ZH7X64.fd**) to the root directory of the USB storage.
3. Plug the USB storage into a USB port.
4. Press **Fn + ESC** button then plug in AC.
The Power button flashes once.
5. Press **Power** button to initiate system CRISIS mode.
When CRISIS is complete, the system auto restarts with a workable BIOS.
6. Update the latest version BIOS for this machine by the regular BIOS flashing process.

FRU (Field Replaceable Unit) List

This chapter gives you the FRU (Field Replaceable Unit) listing in global configurations of the computer. Refer to this chapter whenever ordering for parts to repair or for RMA (Return Merchandise Authorization).

Please note that WHEN ORDERING FRU PARTS, you should check the most up-to-date information available on your regional web or channel. For whatever reasons a part number change is made, it will not be noted on the printed Service Guide. For ACER AUTHORIZED SERVICE PROVIDERS, your Acer office may have a DIFFERENT part number code from those given in the FRU list of this printed Service Guide. You MUST use the local FRU list provided by your regional Acer office to order FRU parts for repair and service of customer machines.

NOTE: To scrap or to return the defective parts, you should follow the local government ordinance or regulations on how to dispose it properly, or follow the rules set by your regional Acer office on how to return it.

Exploded Diagrams

Main Assembly

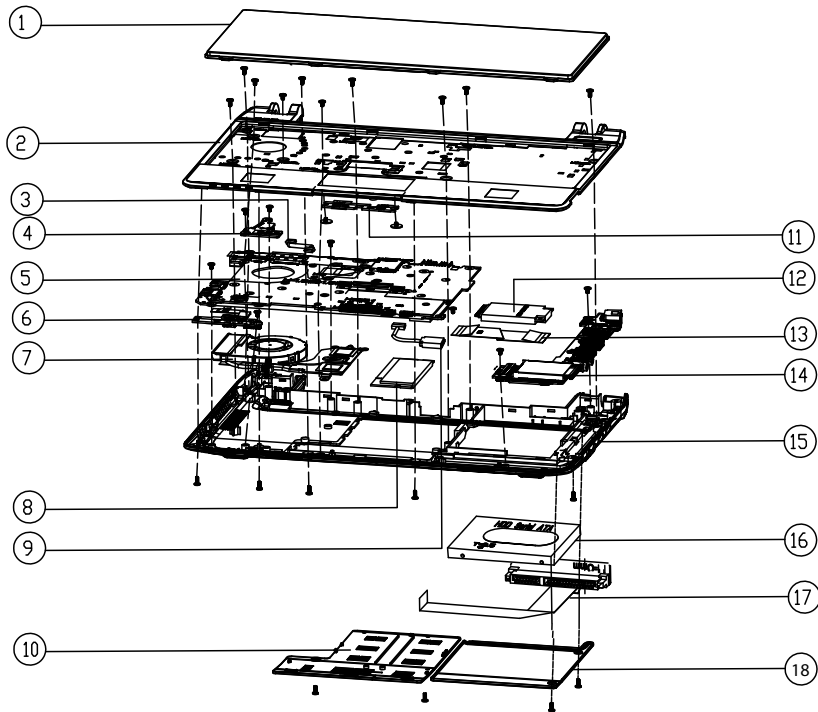

Item	Description	Part Number
1	K/B Module	2ZH70KBR000
2	Top Sub Assy	2IZH7TATN10
3	CRTCable Assy	DDOZH7TH000
4	CRT Board Assy	3SZH7CB0000
5	PCB Assy	21ZH7PA0090
6	LED Board Assy	3RZH7LB0000
7	Thermal Module Assy	3AZH7TATN10
8	RAM	2ZH7RM02000
9	Bluetooth Assy	27ZH7BTTN00
10	RAM Door Assy	3BZH7RDTN00
11	Touchpad Board Assy	33ZH7TB0000
12	WirelessLAN	27ZH7WL00040
13	Cardreader FFC Cable	DEFC0759004
14	LAN Board Assy	3TZH7LB0000
15	Base Assy	2JZJ7BATN00
16	HDD	2ZH7HDC2000
17	FPC Cable	50.SA107.006
18	HDD Door Assy	3AZH7HDDTN00

LCD Assembly

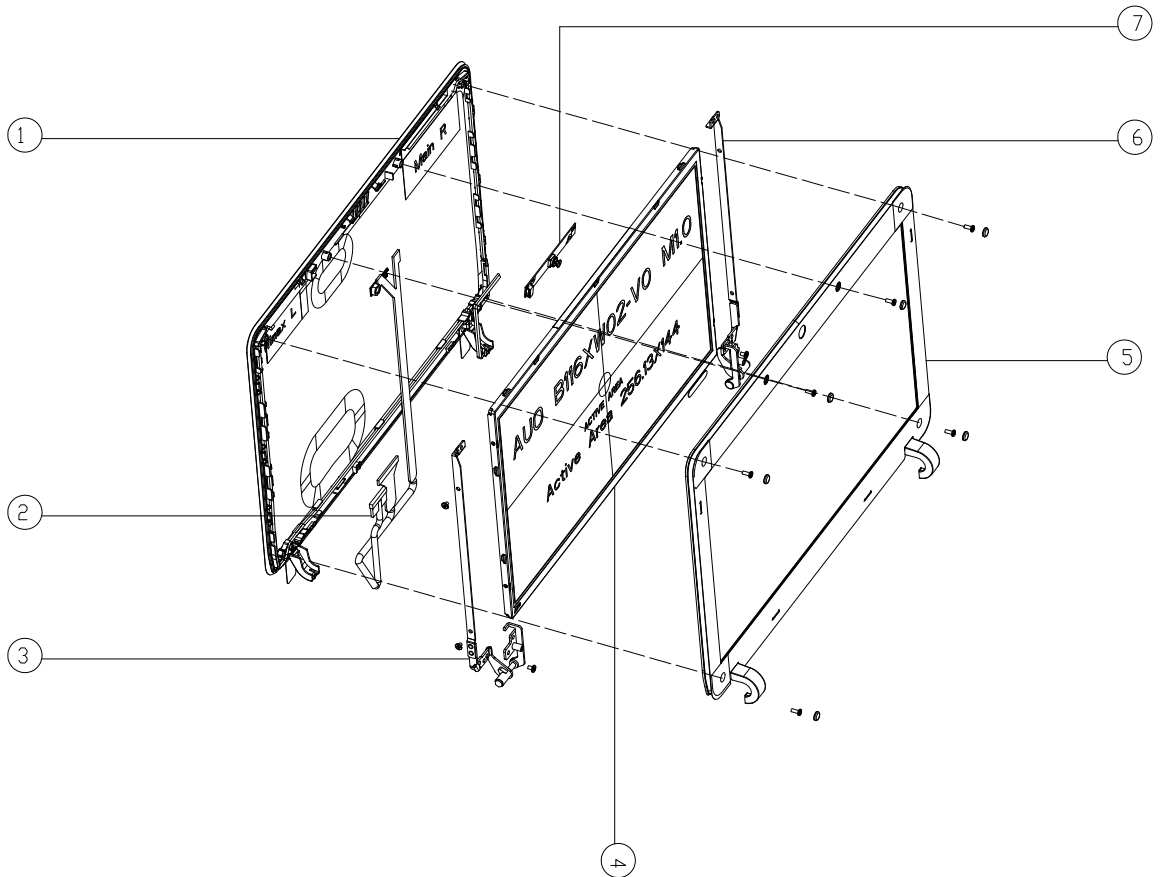

Camera



Item	Description	Part Number
1	LCD Cover	60.SA207.002
2	CableAssy	50.SA107.005
3	LCD Bracket_L	33.SA107.002
4	LCD Panel	LK.11605.001
5	LCD Bezel	60.SA107.005
6	LCD Bracket_R	33.SA107.001
7	Camera	57.S6507.003

FRU List

CATEGORY	PARTNAME	ACER P/N
ADAPTER		
	ADAPTER DELTA 30W 19V 1.7X5.5X11 BLACK ADP-30JH BA LF	AP.03001.001
	ADAPTER LITE-ON 30W 1.7X5.5X11 BLACK PA-1300-04AC LF	AP.03003.001
	ADAPTER HIPRO 30W 19V 1.7X5.5X11 BLACK HP-A0301R3 B1LF LF	AP.0300A.001
BATTERY		
	Battery SIMPLO UM-2009E Li-Ion 3S2P PANASONIC 6 cell 4400mAh Main COMMON ID:UM09E71	BT.00607.106
	Battery SIMPLO UM-2009E Li-Ion 3S2P SAMSUNG 6 cell 4400mAh Main COMMON ID:UM09E75	BT.00607.107
	Battery SANYO UM-2009E Li-Ion 3S2P SANYO 6 cell 5600mAh Main COMMON ID:UM09E36	BT.00603.096
	Battery SIMPLO UM-2009E Li-Ion 3S2P SAMSUNG 6 cell 5600mAh Main COMMON ID:UM09E70	BT.00607.102
	Battery SIMPLO UM-2009E Li-Ion 3S2P LGC 6 cell 5600mAh Main COMMON ID:UM09E78	BT.00607.103
BOARD		
	Huawei EM770W	LC.21300.008
	Qualcomm Gobi2000	LC.21300.011
	Foxconn Wireless LAN Atheros HB93 1x2 BGN (HM)	NI.23600.046
	Foxconn Wireless LAN Atheros HB95 BGN (HM)	NI.23600.047
	Lan Intel WLAN 512AG_HMWG Shirley Peak 5100 MM#897072	KI.SPH01.005
	Lan Intel WLAN 512AN_HMWG Shirley Peak 5100 MM#895373	KI.SPH01.003
	Lan Intel WLAN INT1000HGB	KI.CPH01.002
	Foxconn Bluetooth FOX BRM 2046 BT2.1	BH.21100.004
	LED BOARD	55.SA107.001
	CRT BOARD	55.SA107.002
	LAN BOARD	55.SA107.003

CATEGORY	PARTNAME	ACER P/N
	TP BOARD	55.SA107.005
Mainboard		
	MAINBOARD GS45 ICH9M CPU CM723B W/O RAM FOR 3G	MB.SAA06.001
	MAINBOARD GS45 ICH9M CPU CM723B W/O RAM FOR NON 3G	MB.SA706.001
	Mainboard JM11_MS Intel G45 LF CEL-M743 w/o 3G	MB.SA706.002
	Mainboard JM11_MS Intel G45 LF SU2300 w/o 3G	MB.SA706.003
	MAINBOARD GS45 ICH9M CPU SU3500B W/O RAM FOR 3G	MB.SA506.001
	MAINBOARD GS45 ICH9M CPU SU3500B W/O RAM FOR NON 3G	MB.SA106.001
CCD		
	Suyin Camera Rosa 2G, MODULE CN0316-S30C-OV06-1	57.S6507.001
	CAMERA CNF9011(CMOS,0.3M,VGA)	57.S6507.002
	CAMERA 09P2SF001(CMOS,0.3M,VGA)	57.S6507.003
CABLE		
	PWR CORD V943B30001218008 DANISH 3P	27.A03V7.006
	PWR CORD(ISR)1.8M 3PBLK FZ0I0008-038	27.TATV7.005
	PWR CORD V50CB3T3012180QD TW-110V,3P	27.A99V7.002
	POWER CORD(SWI)1.8M 3PBLACK FZ010008-011	27.A99V7.004
	POWER CORD(IT) 1.8M 3PBLACK FZ010008-008	27.A99V7.005
	POWER CORD(S.A) 1.8M 3BLACK FZ010008-006	27.T48V7.001
	POWER CORD US 3PIN ROHS	27.TAXV7.001
	POWER CORD(EU) 1.8M 3PBLACK FM010008-010	27.TATV7.001
	POWER CORD(UK) 1.8M 3PBLACK FP010008-013	27.TATV7.003
	POWER CORD BRAZIL IMETRO 3 PIN	27.S0607.001
	POWER CORD UK 3PIN	27.A03V7.004
	BLUETOOTH CABLE	50.SA107.001
	CRT CABLE	50.SA107.002
	FFC CABLE - CARD READER/B TO MB	50.SA107.003
	FFC CABLE - LED/B TO MB	50.SA107.004

CATEGORY	PARTNAME	ACER P/N
	LCD CABLE W/MIC FOR CCD	50.SA107.005
	FPC CABLE - HDD TO MB	50.SA107.006
CASE/COVER/BRACKET ASSEMBLY		
	UPPER CASE ASSY BLACK W/TP, FFC CABLE *2	60.SA207.001
	UPPER CASE ASSY RED W/TP, FFC CABLE *2	60.SA307.001
	UPPER CASE ASSY BLUE W/TP, FFC CABLE *2	60.SA107.001
	LOWER CASE ASSY BLACK W/SPEAKER FOR HDMI	60.SA107.002
	HDD COVER BLACK	42.SA107.001
	RAM COVER BLACK	42.SA107.002
	LCD COVER ASSY IMR BLACK W/ANTENNA	60.SA207.002
	LCD COVER ASSY IMR BLACK W/ 3G ANTENNA	60.SA507.001
	LCD COVER ASSY IMR RED W/ANTENNA	60.SA307.002
	LCD COVER ASSY IMR RED W/ 3G ANTENNA	60.SA607.001
	LCD COVER ASSY IMR BLUE W/ANTENNA	60.SA107.004
	LCD COVER ASSY IMR BLUE W/ 3G ANTENNA	60.SA407.001
	LCD BEZEL ASSY BLACK	60.SA107.005
	LCD BRACKET W/HINGE R	33.SA107.001

CATEGORY	PARTNAME	ACER P/N
	LCD BRACKET W/HINGE L	33.SA107.002
	SD DUMMY CARD BLACK	42.SA107.003
SATA HDD/HARD DISK DRIVE		
	HDD SEAGATE 2.5" 5400rpm 160GB ST9160314AS Wyatt SATA LF F/W:0001SDM1	KH.16001.042
	HDD TOSHIBA 2.5" 5400rpm 160GB MK1655GSX Libra SATA LF F/W: FG011J	KH.16004.006
	HDD HGST 2.5" 5400rpm 160GB Falcon B HTS543216L9SA00 SATA LF F/W:C40C	KH.16007.025
	HDD HGST 2.5" 5400rpm 160GB HTS545016B9A300 Panther B SATA LF F/W:C60F Disk imbalance criteria = 0.014g-cm	KH.16007.026
	HDD WD 2.5" 5400rpm 160GB WD1600BEVT-22ZCTO ML160 SATA LF F/W:11.01A11	KH.16008.022
	HDD SEAGATE 2.5" 5400rpm 250GB ST9250315AS Wyatt SATA LF F/W:0001SDM1	KH.25001.016
	HDD TOSHIBA 2.5" 5400rpm 250GB MK2555GSX Libra SATA LF F/W:FG001J	KH.25004.003
	HDD HGST 2.5" 5400rpm 250GB HTS545025B9A300 Panther B SATA LF F/W:C60F Disk imbalance criteria = 0.014g-cm	KH.25007.016
	HDD HGST 2.5" 5400rpm 250GB HTS543225L9A300 Falcon B SATA LF F/W:C40C Disk imbalance criteria = 0.014g-cm	KH.25007.017
	HDD WD 2.5" 5400rpm 250GB WD2500BEVT-22ZCT0 ML160 SATA LF F/W:11.01A11	KH.25008.021
	HDD SEAGATE 2.5" 5400rpm 320GB ST9320325AS Wyatt SATA LF F/W:0001SDM1	KH.32001.017
	HDD TOSHIBA 2.5" 5400rpm 320GB MK3255GSX Libra SATA LF F/W:FG011J	KH.32004.002
	HDD HGST 2.5" 5400rpm 320GB HTS545032B9A300 Panther B SATA LF F/W:C60F Disk imbalance criteria = 0.014g-cm	KH.32007.008
	HDD WD 2.5" 5400rpm 320GB WD3200BEVT-22ZCT0 ML160 SATA LF F/W:11.01A11	KH.32008.013
	HDD SEAGATE 2.5" 5400rpm 500GB ST9500325AS Wyatt SATA LF F/W:0001SDM1	KH.50001.011
	HDD TOSHIBA 2.5" 5400rpm 500GB MK5055GSX Libra SATA LF F/W:FG001J	KH.50004.001
HDD HGST 2.5" 5400rpm 500GB HTS545050B9A300 Panther B SATA LF F/W:C60F Disk imbalance criteria = 0.014g-cm	KH.50007.010	
HDD WD 2.5" 5400rpm 500GB WD5000BEVT-22ZAT0 ML250 SATA LF F/W:01.01A01	KH.50008.013	

CATEGORY	PARTNAME	ACER P/N
KEYBOARD		
	Keyboard ACER NT1T JM11 86KS Black Arabic Texture	KB.I110A.002
	Keyboard ACER NT1T JM11 87KS Black FR/Arabic Texture	KB.I110A.008
	Keyboard ACER NT1T JM11 87KS Black Brazilian Portuguese Texture	KB.I110A.004
	Keyboard ACER NT1T JM11 87KS Black Belgium Texture	KB.I110A.003
	Keyboard ACER NT1T JM11 87KS Black CZ/SK Texture	KB.I110A.005
	Keyboard ACER NT1T JM11 86KS Black Chinese Texture	KB.I110A.006
	Keyboard ACER NT1T JM11 87KS Black Danish Texture	KB.I110A.007
	Keyboard ACER NT1T JM11 87KS Black French Texture	KB.I110A.009
	Keyboard ACER NT1T JM11 87KS Black German Texture	KB.I110A.010
	Keyboard ACER NT1T JM11 86KS Black Greek Texture	KB.I110A.011
	Keyboard ACER NT1T JM11 87KS Black Hungarian Texture	KB.I110A.012
	Keyboard ACER NT1T JM11 87KS Black Italian Texture	KB.I110A.013
	Keyboard ACER NT1T JM11 91KS Black Japanese Texture	KB.I110A.014
	Keyboard ACER NT1T JM11 87KS Black Nordic Texture	KB.I110A.015
	Keyboard ACER NT1T JM11 87KS Black Norwegian Texture	KB.I110A.016
	Keyboard ACER NT1T JM11 87KS Black Portuguese Texture	KB.I110A.017
	Keyboard ACER NT1T JM11 86KS Black Russian Texture	KB.I110A.018
	Keyboard ACER NT1T JM11 87KS Black SLO/CRO Texture	KB.I110A.019
	Keyboard ACER NT1T JM11 87KS Black Spanish Texture	KB.I110A.020
	Keyboard ACER NT1T JM11 87KS Black Sweden Texture	KB.I110A.021
	Keyboard ACER NT1T JM11 87KS Black Swiss/G Texture	KB.I110A.022
	Keyboard ACER NT1T JM11 86KS Black Thailand Texture	KB.I110A.023
	Keyboard ACER NT1T JM11 87KS Black Turkish Texture	KB.I110A.024
	Keyboard ACER NT1T JM11 87KS Black UK Texture	KB.I110A.025
	Keyboard ACER NT1T JM11 86KS Black US International Texture	KB.I110A.026
	Keyboard ACER NT1T JM11 86KS Black US International w/ Hebrew Texture	KB.I110A.027
Keyboard ACER NT1T JM11 87KS Black US w/ Canadian French Texture	KB.I110A.028	

CATEGORY	PARTNAME	ACER P/N
LCD		
	LED LCD AUO 11.6" WXGA Glare B116XW02 V0 LF 200nit 8ms 500:1	LK.11605.001
	LED LCD CMO 11.6" WXGA Glare N116B6-L02 LF 200nit 10ms 500:1	LK.1160D.001
	LED LCD SAMSUNG 11.6" WXGA Glare LTN116AT01-A01 LF 200nit 8ms	LK.11606.001
	LED LCD LPL 11.6" WXGA Glare LP116WH1-TLA1 LF 200nit 8ms 500:1	LK.11608.001
	LED LCD AUO 11.6" WXGA Glare B116XW02 V0 1A (3G) LF 200nit 8ms 500:1	LK.11605.003
MEMORY		
	Memory NANYA SO-DIMM DDRII 667 1GB NT1GT64UH8D0FN-3C LF 64*16 0.07um	KN.1GB03.026
	Memory SAMSUNG SO-DIMM DDRII 667 1GB M470T2864QZ3-CE6 LF	KN.1GB0B.016
	Memory SAMSUNG SO-DIMM DDRII 667 1GB M470T2864EH3-CE6 LF 64*16 0.055um	KN.1GB0B.027
	Memory HYNIX SO-DIMM DDRII 667 1GB HYMP112S64CP6-Y5 LF	KN.1GB0G.012
	Memory NANYA SO-DIMM DDRII 667 2GB NT2GT64U8HD0BN-3C LF 128*8 0.07um	KN.2GB03.011
	Memory SAMSUNG SO-DIMM DDRII 667 2GB M470T5663QZ3-CE6 LF	KN.2GB0B.003
	Memory SAMSUNG SO-DIMM DDRII 667 2GB M470T5663EH3-CE6 LF 128*8 0.055um	KN.2GB0B.011
	Memory HYNIX SO-DIMM DDRII 667 2GB HYMP125S64CP8-Y5 LF	KN.2GB0G.004
HEATSINK		
	THERMAL MODULE UMA	60.SA107.006
SPEAKER		
	SPEAKER SET	23.SA107.001
MISCELLANEOUS		
	LCD BEZEL SCREW RUBBER	47.SA107.001
	LCD BEZEL RUBBER	47.SA107.002
	RUBBER FOOT - FRONT (LONG)	47.SA107.003
	RUBBER FOOT - REAR	47.SA107.004

Screw List

PARTNAME	ACER P/N
SCREW M2*3.0 I (BNI,NYLOK)IRON	86.SA107.001
SCREW M2.0X2.5-I(BNI)(NYLOK) IRON	86.SA107.002
SCREW M2*5-I(BZN)(NYLOK)	86.TG607.004
SCREW M2-0.4*2-I(BNI)(NYLOK)(7,0.6)IRON	86.W4107.002
SCREW M2.0*3-I(NI)(NYLOK)IRON	86.WF807.001
SCREW M3.0*3.5-I(NI)STEEL	86.SA107.003

Model Definition and Configuration

Aspire 1810T/1410

Model	RO	Country	Acer Part No	Description
AS1410-722G25n	AAP	Thailand	LX.SA90X.048	AS1410-722G25n EM VHP32ATTH1 MC UMACbb 1*2G/250/BT/6L2.2/5R/CB_bgn_0.3D_GEb_TH21
AS1410-721G16n	AAP	Thailand	LX.SA90X.047	AS1410-721G16n EM VHP32ATTH1 MC UMACbb 1*1G/160/BT/6L2.2/5R/CB_bgn_0.3D_GEb_TH21
AS1410-721G25n	AAP	Thailand	LX.SA90X.046	AS1410-721G25n EM VHP32ATTH1 MC UMACbb 1*1G/250/BT/6L2.2/5R/CB_bgn_0.3D_GEb_TH21
AS1410-721G16n	AAP	Thailand	LX.SA90Y.006	AS1410-721G16n EM VHB32ATTH1 MC UMACbb 1*1G/160/6L2.2/5R/CB_bgn_0.3D_GEb_TH42
AS1410-721G16n	AAP	Thailand	LX.SA90Y.005	AS1410-721G16n EM VHB32ATTH1 MC UMACbb 1*1G/160/6L2.2/5R/CB_bgn_0.3D_GEb_TH22
AS1410-721G16n	AAP	Thailand	LX.SA90Y.007	AS1410-721G16n EM VHB32ATTH1 MC UMACbb 1*1G/160/BT/6L2.2/5R/CB_bgn_0.3D_GEb_TH22
AS1410-721G16n	AAP	Philippines	LX.SA90Y.009	AS1410-721G16n EM VHB32ATPH1 MC UMACbb 1*1G/160/BT/6L2.2/5R/CB_bgn_0.3D_GEb_EN14
AS1410-721G16n	AAP	Thailand	LX.SA90Y.008	AS1410-721G16n EM VHB32ATTH1 MC UMACbb 1*1G/160/BT/6L2.2/5R/CB_bgn_0.3D_GEb_TH42
AS1410-721G16n	CHINA	China	LX.SA90Y.004	AS1410-721G16n VHB32ATCN1 MC UMACbb 1*1G/160/BT/6L2.2/5R/CB_bgn_0.3D_GEb_SC11
AS1410-721G16n	CHINA	Hong Kong	LX.SA90Y.003	AS1410-721G16n VHB32ATHK2 MC UMACbb 1*1G/160/BT/6L2.2/5R/CB_bgn_0.3D_GEb_ZH31
AS1410-722G25n	EMEA	Spain	LX.SA90X.026	AS1410-722G25n VHP32ATES1 MC UMACbb 1*2G/250/6L2.2/5R/CB_bgn_0.3D_GEb_ES22
AS1410-722G25n	EMEA	France	LX.SA90X.028	AS1410-722G25n VHP32ATFR1 MC UMACbb 1*2G/250/6L2.2/5R/CB_bgn_0.3D_GEb_FR23
AS1410-722G25n	EMEA	Belgium	LX.SA90X.030	AS1410-722G25n VHP32ATBE1 MC UMACbb 1*2G/250/6L2.2/5R/CB_bgn_0.3D_GEb_NL13
AS1410-722G25n	EMEA	Eastern Europe	LX.SA90X.041	AS1410-722G25n VHP32ATEU7 MC UMACbb 1*2G/250/6L2.2/5R/CB_bgn_0.3D_GEb_SL11
AS1410-722G25n	EMEA	Czech	LX.SA90X.024	AS1410-722G25n VHP32ATCZ2 MC UMACbb 1*2G/250/6L2.2/5R/CB_bgn_0.3D_GEb_SK13
AS1410-722G25n	EMEA	Sweden	LX.SA90X.040	AS1410-722G25n VHP32ATSE1 MC UMACbb 1*2G/250/6L2.2/5R/CB_bgn_0.3D_GEb_FI13

Model	RO	Country	Acer Part No	Description
AS1410-722G25n	EMEA	Austria	LX.SA90X.025	AS1410-722G25n VHP32ATAT1 MC UMACbb 1*2G/250/6L2.2/5R/CB_bgn_0.3D_GEb_DE11
AS1410-722G25i	EMEA	Russia	LX.SA90X.035	AS1410-722G25i VHP32ATRU1 MC UMACbb 1*2G/250/6L2.2/5R/CB_bg_0.3D_GEb_RU11
AS1410-722G25n	EMEA	Norway	LX.SA90X.034	AS1410-722G25n VHP32ATNO3 MC UMACbb 1*2G/250/6L2.2/5R/CB_bgn_0.3D_GEb_ENS4
AS1410-722G25n	EMEA	Norway	LX.SA90X.033	AS1410-722G25n VHP32ATNO1 MC UMACbb 1*2G/250/6L2.2/5R/CB_bgn_0.3D_GEb_NO12
AS1410-722G25n	EMEA	Luxembourg	LX.SA90X.032	AS1410-722G25n VHP32ATLU3 MC UMACbb 1*2G/250/6L2.2/5R/CB_bgn_0.3D_GEb_IT41
AS1410-722G25n	EMEA	Holland	LX.SA90X.031	AS1410-722G25n VHP32ATNL1 MC UMACbb 1*2G/250/6L2.2/5R/CB_bgn_0.3D_GEb_NL12
AS1410-722G25n	EMEA	Hungary	LX.SA90X.045	AS1410-722G25n VHP32ATHU1 MC UMACbb 1*2G/250/6L2.2/5R/CB_bgn_0.3D_GEb_HU13
AS1410-722G25n	EMEA	Latvia	LX.SA90X.044	AS1410-722G25n VHP32ATLV1 MC UMACbb 1*2G/250/6L2.2/5R/CB_bgn_0.3D_GEb_RU21
AS1410-722G25n	EMEA	Eastern Europe	LX.SA90X.043	AS1410-722G25n VHP32ATEU5 MC UMACbb 1*2G/250/6L2.2/5R/CB_bgn_0.3D_GEb_PL13
AS1410-722G25n	EMEA	Eastern Europe	LX.SA90X.042	AS1410-722G25n VHP32ATEU5 MC UMACbb 1*2G/250/6L2.2/5R/CB_bgn_0.3D_GEb_RO12
AS1410-722G25n	EMEA	Eastern Europe	LX.SA90X.023	AS1410-722G25n VHP32ATEU4 MC UMACbb 1*2G/250/6L2.2/5R/CB_bgn_0.3D_GEb_SV22
AS1410-722G25n	EMEA	Germany	LX.SA90X.029	AS1410-722G25n VHP32ATDE1 MC UMACbb 1*2G/250/6L2.2/5R/CB_bgn_0.3D_GEb_DE13
AS1410-722G25n	EMEA	Denmark	LX.SA90X.027	AS1410-722G25n VHP32ATDK2 MC UMACbb 1*2G/250/6L2.2/5R/CB_bgn_0.3D_GEb_ENS4
AS1410-722G25n	EMEA	South Africa	LX.SA90X.036	AS1410-722G25n EM VHP32ATZA2 MC UMACbb 1*2G/250/6L2.2/5R/CB_bgn_0.3D_GEb_EN16
AS1410-722G25n	EMEA	South Africa	LX.SA90X.037	AS1410-722G25n EM VHP32ATZA1 MC UMACbb 1*2G/250/6L2.2/5R/CB_bgn_0.3D_GEb_FR23
AS1410-722G25n	EMEA	Denmark	LX.SA90X.039	AS1410-722G25n VHP32ATDK1 MC UMACbb 1*2G/250/6L2.2/5R/CB_bgn_0.3D_GEb_NO13
AS1410-722G25n	EMEA	South Africa	LX.SA90X.038	AS1410-722G25n EM VHP32ATZA4 MC UMACbb 1*2G/250/6L2.2/5R/CB_bgn_0.3D_GEb_ENI1
AS1410-722G25n	EMEA	Cyprus	LX.SA90X.017	AS1410-722G25n VHP32ATCY1 MC UMACbb 1*2G/250/6L2.2/5R/CB_bgn_0.3D_GEb_EN11
AS1410-722G25n	EMEA	Algeria	LX.SA90X.011	AS1410-722G25n EM VHP32ATDZ1 MC UMACbb 1*2G/250/6L2.2/5R/CB_bgn_0.3D_GEb_ES81
AS1410-722G25n	EMEA	Portugal	LX.SA90X.019	AS1410-722G25n VHP32ATPT1 MC UMACbb 1*2G/250/6L2.2/5R/CB_bgn_0.3D_GEb_PT12

Model	RO	Country	Acer Part No	Description
AS1410-722G25n	EMEA	Finland	LX.SA90X.020	AS1410-722G25n VHP32ATF12 MC UMACbb 1*2G/250/6L2.2/5R/CB_bgn_0.3D_GEb_FI11
AS1410-722G25n	EMEA	Eastern Europe	LX.SA90X.021	AS1410-722G25n VHP32ATEU3 MC UMACbb 1*2G/250/6L2.2/5R/CB_bgn_0.3D_GEb_RU23
AS1410-722G25n	EMEA	Eastern Europe	LX.SA90X.022	AS1410-722G25n VHP32ATEU7 MC UMACbb 1*2G/250/6L2.2/5R/CB_bgn_0.3D_GEb_ENR2
AS1410-722G25n	EMEA	Poland	LX.SA90X.003	AS1410-722G25n VHP32ATPL1 MC UMACbb 1*2G/250/6L2.2/5R/CB_bgn_0.3D_GEb_PL11
AS1410-722G25n	EMEA	Middle East	LX.SA90X.006	AS1410-722G25n EM VHP32ATME2 MC UMACbb 1*2G/250/6L2.2/5R/CB_bgn_0.3D_GEb_AR23
AS1410-722G25n	EMEA	Middle East	LX.SA90X.018	AS1410-722G25n EM VHP32ATME3 MC UMACbb 1*2G/250/6L2.2/5R/CB_bgn_0.3D_GEb_FR23
AS1410-722G25n	EMEA	Middle East	LX.SA90X.007	AS1410-722G25n EM VHP32ATME2 MC UMACbb 1*2G/250/6L2.2/5R/CB_bgn_0.3D_GEb_AR13
AS1410-722G25n	EMEA	Middle East	LX.SA90X.016	AS1410-722G25n EM VHP32ATME4 MC UMACbb 1*2G/250/6L2.2/5R/CB_bgn_0.3D_GEb_RU61
AS1410-722G25n	EMEA	Middle East	LX.SA90X.015	AS1410-722G25n EM VHP32ATME4 MC UMACbb 1*2G/250/6L2.2/5R/CB_bgn_0.3D_GEb_EN11
AS1410-722G25n	EMEA	Middle East	LX.SA90X.014	AS1410-722G25n EM VHP32ATME2 MC UMACbb 1*2G/250/6L2.2/5R/CB_bgn_0.3D_GEb_EN15
AS1410-722G25n	EMEA	Middle East	LX.SA90X.013	AS1410-722G25n EM VHP32ATME6 MC UMACbb 1*2G/250/6L2.2/5R/CB_bgn_0.3D_GEb_EN15
AS1410-722G25n	EMEA	Middle East	LX.SA90X.012	AS1410-722G25n EM VHP32ATME9 MC UMACbb 1*2G/250/6L2.2/5R/CB_bgn_0.3D_GEb_FR22
AS1410-722G25n	EMEA	UK	LX.SA90X.001	AS1410-722G25n VHP32ATGB1 MC UMACbb 1*2G/250/6L2.2/5R/CB_bgn_0.3D_GEb_EN14
AS1410-722G25n	EMEA	Ukraine	LX.SA90X.005	AS1410-722G25n VHP32ATUK1 MC UMACbb 1*2G/250/6L2.2/5R/CB_bgn_0.3D_GEb_RU11
AS1410-722G25n	EMEA	Turkey	LX.SA90X.004	AS1410-722G25n EM VHP32ATTR1 MC UMACbb 1*2G/250/6L2.2/5R/CB_bgn_0.3D_GEb_TR33
AS1410-722G25n	EMEA	Switzerland	LX.SA90X.002	AS1410-722G25n VHP32ATCH1 MC UMACbb 1*2G/250/6L2.2/5R/CB_bgn_0.3D_GEb_IT42
AS1410-722G25n	EMEA	Italy	LX.SA90X.010	AS1410-722G25n VHP32ATIT1 MC UMACbb 1*2G/250/6L2.2/5R/CB_bgn_0.3D_GEb_IT12
AS1410-722G25n	EMEA	Greece	LX.SA90X.008	AS1410-722G25n VHP32ATGR1 MC UMACbb 1*2G/250/6L2.2/5R/CB_bgn_0.3D_GEb_EL32

Model	RO	Country	Acer Part No	Description
AS1410-722G25n	EMEA	Israel	LX.SA90X.009	AS1410-722G25n VHP32ATIL1 MC UMACbb 1*2G/250/6L2.2/5R/CB_bgn_0.3D_GEb_HE12
AS1410-722G16n	TWN	GCTWN	LX.SA90Y.001	AS1410-722G16n VHB32ATTW1 MC UMACbb 1*2G/160/BT/6L2.2/5R/CB_bgn_0.3D_BAG_GEb_TC11
AS1410-722G25n	TWN	GCTWN	LX.SA90Y.002	AS1410-722G25n VHB32ATTW1 MC UMACbb 1*2G/250/BT/6L2.2/5R/CB_bgn_0.3D_BAG_GEb_TC11
AS1410-721G16i	WW	GCTWN	S2.SA90Y.001	AS1410-721G16i VHB32AWW1 MC UMACbb 1*1G/160/BT/6L/5R/CB_bg_0.3D_GEb_ENX1
AS1410-72_br2G25n	PA	ACLA-Portuguese	LX.PJ902.001	AS1410-72_br2G25n EM W7HP32ATXC2 MC UMACbb_BR 1*2G/250_BR/6L2.8_BR/5R/cb_br_bgn_0.3D_BAG_GEb_XC21
AS1410-721G16n	AAP	Thailand	LX.SA70X.053	AS1410-721G16n EM VHP32ATTH1 MC UMACKk 1*1G/160/BT/6L2.2/5R/CB_bgn_0.3D_GEk_TH41
AS1410-722G25n	AAP	Thailand	LX.SA70X.051	AS1410-722G25n EM VHP32ATTH1 MC UMACKk 1*2G/250/BT/6L2.2/5R/CB_bgn_0.3D_GEk_TH41
AS1410-721G25n	AAP	Thailand	LX.SA70X.048	AS1410-721G25n EM VHP32ATTH1 MC UMACKk 1*1G/250/BT/6L2.2/5R/CB_bgn_0.3D_GEk_TH21
AS1410-721G25n	AAP	Thailand	LX.SA70X.049	AS1410-721G25n EM VHP32ATTH1 MC UMACKk 1*1G/250/BT/6L2.2/5R/CB_bgn_0.3D_GEk_TH41
AS1410-722G25n	AAP	Thailand	LX.SA70X.050	AS1410-722G25n EM VHP32ATTH1 MC UMACKk 1*2G/250/BT/6L2.2/5R/CB_bgn_0.3D_GEk_TH21
AS1410-721G16n	AAP	Thailand	LX.SA70X.052	AS1410-721G16n EM VHP32ATTH1 MC UMACKk 1*1G/160/BT/6L2.2/5R/CB_bgn_0.3D_GEk_TH21
AS1410-723G25n	EMEA	Norway	LX.SA70X.047	AS1410-723G25n VHP32ATNO3 MC UMACKk 2G+1G/250/6L2.2/5R/CB_bgn_0.3D_GEk_ENS4
AS1410-722G25n	CHINA	China	LX.SA70Y.007	AS1410-722G25n VHB32ATCN1 MC UMACKk 1*2G/250/BT/6L2.2/5R/CB_bgn_0.3D_GEk_SC11
AS1410-722G25n	CHINA	Hong Kong	LX.SA70Y.006	AS1410-722G25n VHB32ATHK2 MC UMACKk 1*2G/250/BT/6L2.2/5R/CB_bgn_0.3D_GEk_ZH31
AS1410-723G25n	EMEA	Norway	LX.SA70X.046	AS1410-723G25n VHP32ATNO1 MC UMACKk 2G+1G/250/6L2.2/5R/CB_bgn_0.3D_GEk_NO12
AS1410-722G25n	EMEA	South Africa	LX.SA70X.045	AS1410-722G25n EM VHP32ATZA2 MC UMACKk 1*2G/250/6L2.2/5R/CB_bgn_0.3D_GEk_EN16
AS1410-722G25n	EMEA	South Africa	LX.SA70X.044	AS1410-722G25n EM VHP32ATZA1 MC UMACKk 1*2G/250/6L2.2/5R/CB_bgn_0.3D_GEk_FR23
AS1410-722G25n	EMEA	Portugal	LX.SA70X.030	AS1410-722G25n VHP32ATPT1 MC UMACKk 1*2G/250/6L2.2/5R/CB_bgn_0.3D_GEk_PT12

Model	RO	Country	Acer Part No	Description
AS1410-722G25n	EMEA	Belgium	LX.SA70X.038	AS1410-722G25n VHP32ATBE1 MC UMACKk 1*2G/250/6L2.2/5R/CB_bgn_0.3D_GEk_NL13
AS1410-722G25n	EMEA	Austria	LX.SA70X.032	AS1410-722G25n VHP32ATAT1 MC UMACKk 1*2G/250/6L2.2/5R/CB_bgn_0.3D_GEk_DE11
AS1410-722G25i	EMEA	Russia	LX.SA70X.033	AS1410-722G25i VHP32ATRU1 MC UMACKk 1*2G/250/6L2.2/5R/CB_bg_0.3D_GEk_RU11
AS1410-722G25n	EMEA	Norway	LX.SA70X.034	AS1410-722G25n VHP32ATNO3 MC UMACKk 1*2G/250/6L2.2/5R/CB_bgn_0.3D_GEk_ENS4
AS1410-722G25n	EMEA	Norway	LX.SA70X.035	AS1410-722G25n VHP32ATNO1 MC UMACKk 1*2G/250/6L2.2/5R/CB_bgn_0.3D_GEk_NO12
AS1410-722G25n	EMEA	Luxembourg	LX.SA70X.036	AS1410-722G25n VHP32ATLU3 MC UMACKk 1*2G/250/6L2.2/5R/CB_bgn_0.3D_GEk_IT41
AS1410-722G25n	EMEA	Holland	LX.SA70X.037	AS1410-722G25n VHP32ATNL1 MC UMACKk 1*2G/250/6L2.2/5R/CB_bgn_0.3D_GEk_NL12
AS1410-722G25n	EMEA	Germany	LX.SA70X.039	AS1410-722G25n VHP32ATDE1 MC UMACKk 1*2G/250/6L2.2/5R/CB_bgn_0.3D_GEk_DE13
AS1410-722G25n	EMEA	Spain	LX.SA70X.031	AS1410-722G25n VHP32ATES1 MC UMACKk 1*2G/250/6L2.2/5R/CB_bgn_0.3D_GEk_ES22
AS1410-722G25n	EMEA	Denmark	LX.SA70X.042	AS1410-722G25n VHP32ATDK1 MC UMACKk 1*2G/250/6L2.2/5R/CB_bgn_0.3D_GEk_NO13
AS1410-722G25n	EMEA	Denmark	LX.SA70X.041	AS1410-722G25n VHP32ATDK2 MC UMACKk 1*2G/250/6L2.2/5R/CB_bgn_0.3D_GEk_ENS4
AS1410-722G25n	EMEA	France	LX.SA70X.040	AS1410-722G25n VHP32ATFR1 MC UMACKk 1*2G/250/6L2.2/5R/CB_bgn_0.3D_GEk_FR23
AS1410-722G25n	EMEA	South Africa	LX.SA70X.043	AS1410-722G25n EM VHP32ATZA4 MC UMACKk 1*2G/250/6L2.2/5R/CB_bgn_0.3D_GEk_ENI1
AS1410-722G25n	EMEA	Finland	LX.SA70X.028	AS1410-722G25n VHP32ATFI2 MC UMACKk 1*2G/250/6L2.2/5R/CB_bgn_0.3D_GEk_FI11
AS1410-722G25n	EMEA	Cyprus	LX.SA70X.019	AS1410-722G25n VHP32ATCY1 MC UMACKk 1*2G/250/6L2.2/5R/CB_bgn_0.3D_GEk_EN11
AS1410-722G25n	EMEA	Middle East	LX.SA70X.010	AS1410-722G25n EM VHP32ATME4 MC UMACKk 1*2G/250/6L2.2/5R/CB_bgn_0.3D_GEk_RU61
AS1410-722G25n	EMEA	Middle East	LX.SA70X.027	AS1410-722G25n EM VHP32ATME4 MC UMACKk 1*2G/250/6L2.2/5R/CB_bgn_0.3D_GEk_EN11
AS1410-722G25n	EMEA	Middle East	LX.SA70X.026	AS1410-722G25n EM VHP32ATME2 MC UMACKk 1*2G/250/6L2.2/5R/CB_bgn_0.3D_GEk_EN15
AS1410-722G25n	EMEA	Middle East	LX.SA70X.025	AS1410-722G25n EM VHP32ATME6 MC UMACKk 1*2G/250/6L2.2/5R/CB_bgn_0.3D_GEk_EN15
AS1410-722G25n	EMEA	Middle East	LX.SA70X.024	AS1410-722G25n EM VHP32ATME9 MC UMACKk 1*2G/250/6L2.2/5R/CB_bgn_0.3D_GEk_FR22

Model	RO	Country	Acer Part No	Description
AS1410-722G25n	EMEA	Algeria	LX.SA70X.023	AS1410-722G25n EM VHP32ATDZ1 MC UMACKk 1*2G/250/6L2.2/5R/CB_bgn_0.3D_GEk_ES81
AS1410-722G25n	EMEA	Italy	LX.SA70X.022	AS1410-722G25n VHP32ATIT1 MC UMACKk 1*2G/250/6L2.2/5R/CB_bgn_0.3D_GEk_IT12
AS1410-722G25n	EMEA	Israel	LX.SA70X.021	AS1410-722G25n VHP32ATIL1 MC UMACKk 1*2G/250/6L2.2/5R/CB_bgn_0.3D_GEk_HE12
AS1410-722G25n	EMEA	Greece	LX.SA70X.020	AS1410-722G25n VHP32ATGR1 MC UMACKk 1*2G/250/6L2.2/5R/CB_bgn_0.3D_GEk_EL32
AS1410-722G25n	EMEA	Sweden	LX.SA70X.009	AS1410-722G25n VHP32ATSE1 MC UMACKk 1*2G/250/6L2.2/5R/CB_bgn_0.3D_GEk_FI13
AS1410-722G25n	EMEA	UK	LX.SA70X.018	AS1410-722G25n VHP32ATGB1 MC UMACKk 1*2G/250/6L2.2/5R/CB_bgn_0.3D_GEk_EN14
AS1410-722G25n	EMEA	Ukraine	LX.SA70X.017	AS1410-722G25n VHP32ATUK1 MC UMACKk 1*2G/250/6L2.2/5R/CB_bgn_0.3D_GEk_RU11
AS1410-722G25n	EMEA	Turkey	LX.SA70X.016	AS1410-722G25n EM VHP32ATTR1 MC UMACKk 1*2G/250/6L2.2/5R/CB_bgn_0.3D_GEk_TR33
AS1410-722G25n	EMEA	Switzerland	LX.SA70X.015	AS1410-722G25n VHP32ATCH1 MC UMACKk 1*2G/250/6L2.2/5R/CB_bgn_0.3D_GEk_IT42
AS1410-722G25n	EMEA	Poland	LX.SA70X.014	AS1410-722G25n VHP32ATPL1 MC UMACKk 1*2G/250/6L2.2/5R/CB_bgn_0.3D_GEk_PL11
AS1410-722G25n	EMEA	Middle East	LX.SA70X.013	AS1410-722G25n EM VHP32ATME2 MC UMACKk 1*2G/250/6L2.2/5R/CB_bgn_0.3D_GEk_AR23
AS1410-722G25n	EMEA	Middle East	LX.SA70X.012	AS1410-722G25n EM VHP32ATME3 MC UMACKk 1*2G/250/6L2.2/5R/CB_bgn_0.3D_GEk_FR23
AS1410-722G25n	EMEA	Middle East	LX.SA70X.011	AS1410-722G25n EM VHP32ATME2 MC UMACKk 1*2G/250/6L2.2/5R/CB_bgn_0.3D_GEk_AR13
AS1410-722G25n	EMEA	Latvia	LX.SA70X.001	AS1410-722G25n VHP32ATLV1 MC UMACKk 1*2G/250/6L2.2/5R/CB_bgn_0.3D_GEk_RU21
AS1410-722G25n	EMEA	Eastern Europe	LX.SA70X.002	AS1410-722G25n VHP32ATEU3 MC UMACKk 1*2G/250/6L2.2/5R/CB_bgn_0.3D_GEk_RU23
AS1410-722G25n	EMEA	Eastern Europe	LX.SA70X.003	AS1410-722G25n VHP32ATEU5 MC UMACKk 1*2G/250/6L2.2/5R/CB_bgn_0.3D_GEk_PL13
AS1410-722G25n	EMEA	Eastern Europe	LX.SA70X.004	AS1410-722G25n VHP32ATEU7 MC UMACKk 1*2G/250/6L2.2/5R/CB_bgn_0.3D_GEk_ENR2
AS1410-722G25n	EMEA	Eastern Europe	LX.SA70X.005	AS1410-722G25n VHP32ATEU5 MC UMACKk 1*2G/250/6L2.2/5R/CB_bgn_0.3D_GEk_RO12
AS1410-722G25n	EMEA	Eastern Europe	LX.SA70X.006	AS1410-722G25n VHP32ATEU4 MC UMACKk 1*2G/250/6L2.2/5R/CB_bgn_0.3D_GEk_SV22
AS1410-722G25n	EMEA	Eastern Europe	LX.SA70X.007	AS1410-722G25n VHP32ATEU7 MC UMACKk 1*2G/250/6L2.2/5R/CB_bgn_0.3D_GEk_SL11
AS1410-722G25n	EMEA	Czech	LX.SA70X.008	AS1410-722G25n VHP32ATCZ2 MC UMACKk 1*2G/250/6L2.2/5R/CB_bgn_0.3D_GEk_SK13
AS1410-722G25n	EMEA	Hungary	LX.SA70X.029	AS1410-722G25n VHP32ATHU1 MC UMACKk 1*2G/250/6L2.2/5R/CB_bgn_0.3D_GEk_HU13

Model	RO	Country	Acer Part No	Description
AS1410-722G25n	TWN	GCTWN	LX.SA70Y.004	AS1410-722G25n VHB32ATTW1 MC UMACKk 1*2G/250/BT/6L2.2/5R/CB_bgn_0.3D_BAG_GEk_TC21
AS1410-722G25n	TWN	GCTWN	LX.SA70Y.005	AS1410-722G25n VHB32ATTW1 MC UMACKk 1*2G/250/BT/6L2.2/5R/CB_bgn_0.3D_BAG_GEk_TC11
AS1410-722G16n	TWN	GCTWN	LX.SA70Y.002	AS1410-722G16n VHB32ATTW1 MC UMACKk 1*2G/160/BT/6L2.2/5R/CB_bgn_0.3D_BAG_GEk_TC21
AS1410-722G25i	PA	USA	LX.SA70Y.003	AS1410-722G25i VHB32ATUS1 MC UMACKk 2*1G/250/6L/5R/CB_bg_0.3D_GEk_EN32
AS1410-723G25n	EMEA	Norway	LX.SA70Y.001	AS1410-723G25n VHB32ATNO1 MC UMACKk 2G+1G/250/6L/5R/CB_bgn_0.3D_GEk_NO12
AS1410-721G16n	AAP	Thailand	LX.SAB0X.053	AS1410-721G16n EM VHP32ATTH1 MC UMACrr 1*1G/160/BT/6L2.2/5R/CB_bgn_0.3D_GEk_TH41
AS1410-721G16n	AAP	Thailand	LX.SAB0X.052	AS1410-721G16n EM VHP32ATTH1 MC UMACrr 1*1G/160/BT/6L2.2/5R/CB_bgn_0.3D_GEk_TH21
AS1410-721G25n	AAP	Thailand	LX.SAB0X.050	AS1410-721G25n EM VHP32ATTH1 MC UMACrr 1*1G/250/BT/6L2.2/5R/CB_bgn_0.3D_GEk_TH21
AS1410-722G25n	AAP	Thailand	LX.SAB0X.049	AS1410-722G25n EM VHP32ATTH1 MC UMACrr 1*2G/250/BT/6L2.2/5R/CB_bgn_0.3D_GEk_TH21
AS1410-722G25n	AAP	Thailand	LX.SAB0X.048	AS1410-722G25n EM VHP32ATTH1 MC UMACrr 1*2G/250/BT/6L2.2/5R/CB_bgn_0.3D_GEk_TH41
AS1410-721G25n	AAP	Thailand	LX.SAB0X.051	AS1410-721G25n EM VHP32ATTH1 MC UMACrr 1*1G/250/BT/6L2.2/5R/CB_bgn_0.3D_GEk_TH41
AS1410-721G16n	AAP	Philippines	LX.SAB0Y.003	AS1410-721G16n EM VHB32ATPH1 MC UMACrr 1*1G/160/BT/6L2.2/5R/CB_bgn_0.3D_GEk_EN14
AS1410-721G16n	CHINA	China	LX.SAB0X.047	AS1410-721G16n VHP32ATCN1 MC UMACrr 1*1G/160/BT/6L2.2/5R/CB_bgn_0.3D_GEk_SC11
AS1410-721G16n	CHINA	Hong Kong	LX.SAB0X.046	AS1410-721G16n VHP32ATHK2 MC UMACrr 1*1G/160/BT/6L2.2/5R/CB_bgn_0.3D_GEk_ZH31
AS1410-722G25n	EMEA	Norway	LX.SAB0X.043	AS1410-722G25n VHP32ATNO1 MC UMACrr 1*2G/250/6L2.2/5R/CB_bgn_0.3D_GEk_NO12
AS1410-722G25n	EMEA	Norway	LX.SAB0X.044	AS1410-722G25n VHP32ATNO3 MC UMACrr 1*2G/250/6L2.2/5R/CB_bgn_0.3D_GEk_ENS4
AS1410-722G25n	EMEA	Austria	LX.SAB0X.042	AS1410-722G25n VHP32ATAT1 MC UMACrr 1*2G/250/6L2.2/5R/CB_bgn_0.3D_GEk_DE11
AS1410-722G25n	EMEA	Czech	LX.SAB0X.040	AS1410-722G25n VHP32ATCZ2 MC UMACrr 1*2G/250/6L2.2/5R/CB_bgn_0.3D_GEk_SK13
AS1410-722G25n	EMEA	Eastern Europe	LX.SAB0X.039	AS1410-722G25n VHP32ATEU7 MC UMACrr 1*2G/250/6L2.2/5R/CB_bgn_0.3D_GEk_SL11

Model	RO	Country	Acer Part No	Description
AS1410-722G25n	EMEA	Sweden	LX.SAB0X.04 1	AS1410-722G25n VHP32ATSE1 MC UMACrr 1*2G/250/6L2.2/5R/CB_bgn_0.3D_GEk_FI13
AS1410-722G25i	EMEA	Russia	LX.SAB0X.04 5	AS1410-722G25i VHP32ATRU1 MC UMACrr 1*2G/250/6L2.2/5R/CB_bg_0.3D_GEk_RU11
AS1410-722G25n	EMEA	Eastern Europe	LX.SAB0X.03 7	AS1410-722G25n VHP32ATEU7 MC UMACrr 1*2G/250/6L2.2/5R/ CB_bgn_0.3D_GEk_ENR2
AS1410-722G25n	EMEA	Eastern Europe	LX.SAB0X.03 8	AS1410-722G25n VHP32ATEU5 MC UMACrr 1*2G/250/6L2.2/5R/CB_bgn_0.3D_GEk_PL13
AS1410-722G25n	EMEA	Eastern Europe	LX.SAB0X.03 5	AS1410-722G25n VHP32ATEU4 MC UMACrr 1*2G/250/6L2.2/5R/CB_bgn_0.3D_GEk_SV22
AS1410-722G25n	EMEA	Eastern Europe	LX.SAB0X.03 2	AS1410-722G25n VHP32ATEU3 MC UMACrr 1*2G/250/6L2.2/5R/CB_bgn_0.3D_GEk_RU23
AS1410-722G25n	EMEA	Finland	LX.SAB0X.03 4	AS1410-722G25n VHP32ATFI2 MC UMACrr 1*2G/250/6L2.2/5R/CB_bgn_0.3D_GEk_FI11
AS1410-722G25n	EMEA	Portugal	LX.SAB0X.03 0	AS1410-722G25n VHP32ATPT1 MC UMACrr 1*2G/250/6L2.2/5R/CB_bgn_0.3D_GEk_PT12
AS1410-722G25n	EMEA	Spain	LX.SAB0X.02 9	AS1410-722G25n VHP32ATES1 MC UMACrr 1*2G/250/6L2.2/5R/CB_bgn_0.3D_GEk_ES22
AS1410-722G25n	EMEA	Hungary	LX.SAB0X.03 1	AS1410-722G25n VHP32ATHU1 MC UMACrr 1*2G/250/6L2.2/5R/CB_bgn_0.3D_GEk_HU13
AS1410-722G25n	EMEA	Latvia	LX.SAB0X.03 3	AS1410-722G25n VHP32ATLV1 MC UMACrr 1*2G/250/6L2.2/5R/CB_bgn_0.3D_GEk_RU21
AS1410-722G25n	EMEA	Eastern Europe	LX.SAB0X.03 6	AS1410-722G25n VHP32ATEU5 MC UMACrr 1*2G/250/6L2.2/5R/ CB_bgn_0.3D_GEk_RO12
AS1410-722G25n	EMEA	Cyprus	LX.SAB0X.02 5	AS1410-722G25n VHP32ATCY1 MC UMACrr 1*2G/250/6L2.2/5R/CB_bgn_0.3D_GEk_EN11
AS1410-722G25n	EMEA	Greece	LX.SAB0X.02 6	AS1410-722G25n VHP32ATGR1 MC UMACrr 1*2G/250/6L2.2/5R/CB_bgn_0.3D_GEk_EL32
AS1410-722G25n	EMEA	South Africa	LX.SAB0X.02 8	AS1410-722G25n EM VHP32ATZA1 MC UMACrr 1*2G/250/6L2.2/5R/ CB_bgn_0.3D_GEk_FR23
AS1410-722G25n	EMEA	Denmark	LX.SAB0X.02 3	AS1410-722G25n VHP32ATDK1 MC UMACrr 1*2G/250/6L2.2/5R/ CB_bgn_0.3D_GEk_NO13
AS1410-722G25n	EMEA	Denmark	LX.SAB0X.02 4	AS1410-722G25n VHP32ATDK2 MC UMACrr 1*2G/250/6L2.2/5R/ CB_bgn_0.3D_GEk_ENS4
AS1410-722G25n	EMEA	South Africa	LX.SAB0X.02 2	AS1410-722G25n EM VHP32ATZA4 MC UMACrr 1*2G/250/6L2.2/5R/ CB_bgn_0.3D_GEk_ENI1
AS1410-722G25n	EMEA	South Africa	LX.SAB0X.02 7	AS1410-722G25n EM VHP32ATZA2 MC UMACrr 1*2G/250/6L2.2/5R/ CB_bgn_0.3D_GEk_EN16
AS1410-722G25n	EMEA	France	LX.SAB0X.02 1	AS1410-722G25n VHP32ATFR1 MC UMACrr 1*2G/250/6L2.2/5R/CB_bgn_0.3D_GEk_FR23
AS1410-722G25n	EMEA	Germany	LX.SAB0X.02 0	AS1410-722G25n VHP32ATDE1 MC UMACrr 1*2G/250/6L2.2/5R/CB_bgn_0.3D_GEk_DE13
AS1410-722G25n	EMEA	Belgium	LX.SAB0X.01 9	AS1410-722G25n VHP32ATBE1 MC UMACrr 1*2G/250/6L2.2/5R/CB_bgn_0.3D_GEk_NL13

Model	RO	Country	Acer Part No	Description
AS1410-722G25n	EMEA	Israel	LX.SAB0X.01 4	AS1410-722G25n VHP32ATIL1 MC UMACrr 1*2G/250/6L2.2/5R/CB_bgn_0.3D_GEk_HE12
AS1410-722G25n	EMEA	Middle East	LX.SAB0X.01 2	AS1410-722G25n EM VHP32ATME6 MC UMACrr 1*2G/250/6L2.2/5R/ CB_bgn_0.3D_GEk_EN15
AS1410-722G25n	EMEA	Middle East	LX.SAB0X.01 1	AS1410-722G25n EM VHP32ATME2 MC UMACrr 1*2G/250/6L2.2/5R/ CB_bgn_0.3D_GEk_EN15
AS1410-722G25n	EMEA	Middle East	LX.SAB0X.01 3	AS1410-722G25n EM VHP32ATME9 MC UMACrr 1*2G/250/6L2.2/5R/ CB_bgn_0.3D_GEk_FR22
AS1410-722G25n	EMEA	Luxembourg	LX.SAB0X.01 7	AS1410-722G25n VHP32ATLU3 MC UMACrr 1*2G/250/6L2.2/5R/CB_bgn_0.3D_GEk_IT41
AS1410-722G25n	EMEA	Holland	LX.SAB0X.01 8	AS1410-722G25n VHP32ATNL1 MC UMACrr 1*2G/250/6L2.2/5R/CB_bgn_0.3D_GEk_NL12
AS1410-722G25n	EMEA	Italy	LX.SAB0X.01 5	AS1410-722G25n VHP32ATIT1 MC UMACrr 1*2G/250/6L2.2/5R/CB_bgn_0.3D_GEk_IT12
AS1410-722G25n	EMEA	Algeria	LX.SAB0X.01 6	AS1410-722G25n EM VHP32ATDZ1 MC UMACrr 1*2G/250/6L2.2/5R/ CB_bgn_0.3D_GEk_ES81
AS1410-722G25n	EMEA	Middle East	LX.SAB0X.00 7	AS1410-722G25n EM VHP32ATME4 MC UMACrr 1*2G/250/6L2.2/5R/ CB_bgn_0.3D_GEk_EN11
AS1410-722G25n	EMEA	Middle East	LX.SAB0X.00 9	AS1410-722G25n EM VHP32ATME2 MC UMACrr 1*2G/250/6L2.2/5R/ CB_bgn_0.3D_GEk_AR13
AS1410-722G25n	EMEA	Middle East	LX.SAB0X.00 4	AS1410-722G25n EM VHP32ATME2 MC UMACrr 1*2G/250/6L2.2/5R/ CB_bgn_0.3D_GEk_AR23
AS1410-722G25n	EMEA	Switzerland	LX.SAB0X.00 6	AS1410-722G25n VHP32ATCH1 MC UMACrr 1*2G/250/6L2.2/5R/CB_bgn_0.3D_GEk_IT42
AS1410-722G25n	EMEA	Ukraine	LX.SAB0X.00 2	AS1410-722G25n VHP32ATUK1 MC UMACrr 1*2G/250/6L2.2/5R/CB_bgn_0.3D_GEk_RU11
AS1410-722G25n	EMEA	UK	LX.SAB0X.00 1	AS1410-722G25n VHP32ATGB1 MC UMACrr 1*2G/250/6L2.2/5R/CB_bgn_0.3D_GEk_EN14
AS1410-722G25n	EMEA	Turkey	LX.SAB0X.00 3	AS1410-722G25n EM VHP32ATTR1 MC UMACrr 1*2G/250/6L2.2/5R/ CB_bgn_0.3D_GEk_TR33
AS1410-722G25n	EMEA	Poland	LX.SAB0X.00 5	AS1410-722G25n VHP32ATPL1 MC UMACrr 1*2G/250/6L2.2/5R/CB_bgn_0.3D_GEk_PL11
AS1410-722G25n	EMEA	Middle East	LX.SAB0X.01 0	AS1410-722G25n EM VHP32ATME3 MC UMACrr 1*2G/250/6L2.2/5R/ CB_bgn_0.3D_GEk_FR23
AS1410-722G25n	EMEA	Middle East	LX.SAB0X.00 8	AS1410-722G25n EM VHP32ATME4 MC UMACrr 1*2G/250/6L2.2/5R/ CB_bgn_0.3D_GEk_RU61
AS1410-722G16n	TWN	GCTWN	LX.SAB0Y.00 2	AS1410-722G16n VHB32ATTW1 MC UMACrr 1*2G/160/BT/6L2.2/5R/ CB_bgn_0.3D_BAG_GEk_TC11
AS1410-722G25n	TWN	GCTWN	LX.SAB0Y.00 1	AS1410-722G25n VHB32ATTW1 MC UMACrr 1*2G/250/BT/6L2.2/5R/ CB_bgn_0.3D_BAG_GEk_TC11

Model	RO	Country	Acer Part No	Description
AS1810T Z- 413G32n	EMEA	Switzerland	LX.PJ30X.040	AS1810TZ-413G32n VHP32ATCH1 MC UMACbb 2G+1G/320/6L2.8/5R/ CB_bgn_0.3D_GEb_IT42
AS1810T Z- 413G32n	EMEA	Germany	LX.PJ30X.037	AS1810TZ-413G32n VHP32ATDE1 MC UMACbb 2G+1G/320/6L2.8/5R/ CB_bgn_0.3D_GEb_DE13
AS1810T Z- 413G32i	EMEA	Russia	LX.PJ30X.033	AS1810TZ-413G32i VHP32ATRU1 MC UMACbb 2G+1G/320/6L2.8/5R/ CB_bg_0.3D_GEb_RU11
AS1810T Z- 413G32n	EMEA	Middle East	LX.PJ30X.031	AS1810TZ-413G32n EM VHP32ATME9 MC UMACbb 2G+1G/320/6L2.8/5R/ CB_bgn_0.3D_GEb_FR22
AS1810T Z- 413G32n	EMEA	Middle East	LX.PJ30X.029	AS1810TZ-413G32n EM VHP32ATME3 MC UMACbb 2G+1G/320/6L2.8/5R/ CB_bgn_0.3D_GEb_FR23
AS1810T Z- 413G32n	EMEA	Middle East	LX.PJ30X.027	AS1810TZ-413G32n EM VHP32ATME2 MC UMACbb 2G+1G/320/6L2.8/5R/ CB_bgn_0.3D_GEb_AR13
AS1810T Z- 413G32n	EMEA	South Africa	LX.PJ30X.025	AS1810TZ-413G32n EM VHP32ATZA1 MC UMACbb 2G+1G/320/6L2.8/5R/ CB_bgn_0.3D_GEb_FR23
AS1810T Z- 413G32n	EMEA	South Africa	LX.PJ30X.017	AS1810TZ-413G32n EM VHP32ATZA4 MC UMACbb 2G+1G/320/6L2.8/5R/ CB_bgn_0.3D_GEb_ENI1
AS1810T Z- 413G32n	EMEA	Israel	LX.PJ30X.018	AS1810TZ-413G32n VHP32ATIL1 MC UMACbb 2G+1G/320/6L2.8/5R/ CB_bgn_0.3D_GEb_HE12
AS1810T Z- 413G32n	EMEA	Ukraine	LX.PJ30X.046	AS1810TZ-413G32n VHP32ATUK1 MC UMACbb 2G+1G/320/6L2.8/5R/ CB_bgn_0.3D_GEb_RU11
AS1810T Z- 413G32n	EMEA	Austria	LX.PJ30X.019	AS1810TZ-413G32n VHP32ATAT1 MC UMACbb 2G+1G/320/6L2.8/5R/ CB_bgn_0.3D_GEb_DE11
AS1810T Z- 413G32n	EMEA	Finland	LX.PJ30X.020	AS1810TZ-413G32n VHP32ATFI2 MC UMACbb 2G+1G/320/6L2.8/5R/ CB_bgn_0.3D_GEb_FI11
AS1810T Z- 413G32n	EMEA	Middle East	LX.PJ30X.021	AS1810TZ-413G32n EM VHP32ATME6 MC UMACbb 2G+1G/320/6L2.8/5R/ CB_bgn_0.3D_GEb_EN15
AS1810T Z- 413G32n	EMEA	Spain	LX.PJ30X.022	AS1810TZ-413G32n VHP32ATES1 MC UMACbb 2G+1G/320/6L2.8/5R/ CB_bgn_0.3D_GEb_ES22
AS1810T Z- 413G32n	EMEA	Portugal	LX.PJ30X.023	AS1810TZ-413G32n VHP32ATPT1 MC UMACbb 2G+1G/320/6L2.8/5R/ CB_bgn_0.3D_GEb_PT12
AS1810T Z- 413G32n	EMEA	Middle East	LX.PJ30X.024	AS1810TZ-413G32n EM VHP32ATME4 MC UMACbb 2G+1G/320/6L2.8/5R/ CB_bgn_0.3D_GEb_EN11
AS1810T Z- 413G32n	EMEA	Eastern Europe	LX.PJ30X.005	AS1810TZ-413G32n VHP32ATEU7 MC UMACbb 2G+1G/320/6L2.8/5R/ CB_bgn_0.3D_GEb_ENR2

Model	RO	Country	Acer Part No	Description
AS1810T Z- 413G32n	EMEA	Eastern Europe	LX.PJ30X.006	AS1810TZ-413G32n VHP32ATEU5 MC UMACbb 2G+1G/320/6L2.8/5R/ CB_bgn_0.3D_GEb_RO12
AS1810T Z- 413G32n	EMEA	Turkey	LX.PJ30X.008	AS1810TZ-413G32n EM VHP32ATTR1 MC UMACbb 2G+1G/320/6L2.8/5R/ CB_bgn_0.3D_GEb_TR33
AS1810T Z- 413G32n	EMEA	Eastern Europe	LX.PJ30X.010	AS1810TZ-413G32n VHP32ATEU3 MC UMACbb 2G+1G/320/6L2.8/5R/ CB_bgn_0.3D_GEb_RU23
AS1810T Z- 413G32n	EMEA	Luxembour g	LX.PJ30X.011	AS1810TZ-413G32n VHP32ATLU3 MC UMACbb 2G+1G/320/6L2.8/5R/ CB_bgn_0.3D_GEb_IT41
AS1810T Z- 413G32n	EMEA	Sweden	LX.PJ30X.012	AS1810TZ-413G32n VHP32ATSE1 MC UMACbb 2G+1G/320/6L2.8/5R/ CB_bgn_0.3D_GEb_FI13
AS1810T Z- 413G32n	EMEA	Poland	LX.PJ30X.013	AS1810TZ-413G32n VHP32ATPL1 MC UMACbb 2G+1G/320/6L2.8/5R/ CB_bgn_0.3D_GEb_PL11
AS1810T Z- 413G32n	EMEA	Hungary	LX.PJ30X.015	AS1810TZ-413G32n VHP32ATHU1 MC UMACbb 2G+1G/320/6L2.8/5R/ CB_bgn_0.3D_GEb_HU13
AS1810T Z- 413G32n	EMEA	Middle East	LX.PJ30X.016	AS1810TZ-413G32n EM VHP32ATME4 MC UMACbb 2G+1G/320/6L2.8/5R/ CB_bgn_0.3D_GEb_RU61
AS1810T Z- 413G32n	EMEA	Serbia/ Macedonia	LX.PJ30X.043	AS1810TZ-413G32n EM VHP32ATCS1 MC UMACbb 2G+1G/320/6L2.8/5R/ CB_bgn_0.3D_GEb_SL11
AS1810T Z- 413G32n	EMEA	Czech	LX.PJ30X.044	AS1810TZ-413G32n VHP32ATCZ2 MC UMACbb 2G+1G/320/6L2.8/5R/ CB_bgn_0.3D_GEb_SK13
AS1810T Z- 413G32n	EMEA	Algeria	LX.PJ30X.002	AS1810TZ-413G32n EM VHP32ATDZ1 MC UMACbb 2G+1G/320/6L2.8/5R/ CB_bgn_0.3D_GEb_ES81
AS1810T Z- 413G32n	EMEA	Cyprus	LX.PJ30X.003	AS1810TZ-413G32n VHP32ATCY1 MC UMACbb 2G+1G/320/6L2.8/5R/ CB_bgn_0.3D_GEb_EN11
AS1810T Z- 413G32n	EMEA	Norway	LX.PJ30X.004	AS1810TZ-413G32n VHP32ATNO3 MC UMACbb 2G+1G/320/6L2.8/5R/ CB_bgn_0.3D_GEb_ENS4
AS1810T Z- 413G32n	EMEA	South Africa	LX.PJ30X.026	AS1810TZ-413G32n EM VHP32ATZA2 MC UMACbb 2G+1G/320/6L2.8/5R/ CB_bgn_0.3D_GEb_EN16
AS1810T Z- 413G32n	EMEA	Middle East	LX.PJ30X.028	AS1810TZ-413G32n EM VHP32ATME2 MC UMACbb 2G+1G/320/6L2.8/5R/ CB_bgn_0.3D_GEb_EN15
AS1810T Z- 413G32n	EMEA	Middle East	LX.PJ30X.030	AS1810TZ-413G32n EM VHP32ATME2 MC UMACbb 2G+1G/320/6L2.8/5R/ CB_bgn_0.3D_GEb_AR23
AS1810T Z- 413G32n	EMEA	Denmark	LX.PJ30X.032	AS1810TZ-413G32n VHP32ATDK1 MC UMACbb 2G+1G/320/6L2.8/5R/ CB_bgn_0.3D_GEb_NO13

Model	RO	Country	Acer Part No	Description
AS1810T Z- 413G32n	EMEA	Belgium	LX.PJ30X.036	AS1810TZ-413G32n VHP32ATBE1 MC UMACbb 2G+1G/320/6L2.8/5R/ CB_bgn_0.3D_GEb_NL13
AS1810T Z- 413G32n	EMEA	France	LX.PJ30X.038	AS1810TZ-413G32n VHP32ATFR1 MC UMACbb 2G+1G/320/6L2.8/5R/ CB_bgn_0.3D_GEb_FR23
AS1810T Z- 413G32n	EMEA	UK	LX.PJ30X.039	AS1810TZ-413G32n VHP32ATGB1 MC UMACbb 2G+1G/320/6L2.8/5R/ CB_bgn_0.3D_GEb_EN14
AS1810T Z- 413G32n	EMEA	Greece	LX.PJ30X.042	AS1810TZ-413G32n VHP32ATGR1 MC UMACbb 2G+1G/320/6L2.8/5R/ CB_bgn_0.3D_GEb_EL32
AS1810T Z- 413G32n	EMEA	Denmark	LX.PJ30X.001	AS1810TZ-413G32n VHP32ATDK2 MC UMACbb 2G+1G/320/6L2.8/5R/ CB_bgn_0.3D_GEb_ENS4
AS1810T Z- 413G32n	EMEA	Latvia	LX.PJ30X.045	AS1810TZ-413G32n VHP32ATLV1 MC UMACbb 2G+1G/320/6L2.8/5R/ CB_bgn_0.3D_GEb_RU21
AS1810T Z- 413G32n	EMEA	Eastern Europe	LX.PJ30X.007	AS1810TZ-413G32n VHP32ATEU5 MC UMACbb 2G+1G/320/6L2.8/5R/ CB_bgn_0.3D_GEb_PL13
AS1810T Z- 413G32n	EMEA	Eastern Europe	LX.PJ30X.009	AS1810TZ-413G32n VHP32ATEU4 MC UMACbb 2G+1G/320/6L2.8/5R/ CB_bgn_0.3D_GEb_SV22
AS1810T Z- 413G32n	EMEA	Eastern Europe	LX.PJ30X.014	AS1810TZ-413G32n VHP32ATEU7 MC UMACbb 2G+1G/320/6L2.8/5R/ CB_bgn_0.3D_GEb_SL11
AS1810T Z- 413G32n	EMEA	Norway	LX.PJ30X.034	AS1810TZ-413G32n VHP32ATNO1 MC UMACbb 2G+1G/320/6L2.8/5R/ CB_bgn_0.3D_GEb_NO12
AS1810T Z- 413G32n	EMEA	Italy	LX.PJ30X.041	AS1810TZ-413G32n VHP32ATIT1 MC UMACbb 2G+1G/320/6L2.8/5R/ CB_bgn_0.3D_GEb_IT12
AS1810T Z- 413G32n	EMEA	Holland	LX.PJ30X.035	AS1810TZ-413G32n VHP32ATNL1 MC UMACbb 2G+1G/320/6L2.8/5R/ CB_bgn_0.3D_GEb_NL12
AS1810T Z- 412G32n	AAP	Thailand	LX.PJ30X.050	AS1810TZ-412G32n EM VHP32ATTH1 MC UMACbb 1*2G/320/BT/6L2.8/5R/ CB_bgn_0.3D_BAG_GEb_TH41
AS1810T Z- 412G32n	AAP	Thailand	LX.PJ30X.049	AS1810TZ-412G32n EM VHP32ATTH1 MC UMACbb 1*2G/320/BT/6L2.8/5R/ CB_bgn_0.3D_BAG_GEb_TH21
AS1810T Z- 411G25n	CHINA	China	LX.PJ30X.048	AS1810TZ-411G25n VHP32ATCN1 MC UMACbb 1*1G/250/BT/6L2.8/5R/ CB_bgn_0.3D_BAG_GEb_SC11
AS1810T Z- 411G25n	CHINA	Hong Kong	LX.PJ30X.047	AS1810TZ-411G25n VHP32ATHK2 MC UMACbb 1*1G/250/BT/6L2.8/5R/ CB_bgn_0.3D_BAG_GEb_ZH31
AS1810T Z- 412G32n	AAP	Thailand	LX.PJ50X.050	AS1810TZ-412G32n EM VHP32ATTH1 MC UMACKk 1*2G/320/BT/6L2.8/5R/ CB_bgn_0.3D_ACER 11inch Netbook Bag Black_GEk_TH41

Model	RO	Country	Acer Part No	Description
AS1810T Z- 412G32n	AAP	Thailand	LX.PJ50X.049	AS1810TZ-412G32n EM VHP32ATTH1 MC UMACKk 1*2G/320/BT/6L2.8/5R/ CB_bgn_0.3D_ACER 11inch Netbook Bag Black_GEk_TH21
AS1810T Z- 413G32n	EMEA	France	LX.PJ50X.028	AS1810TZ-413G32n VHP32ATFR1 MC UMACKk 2G+1G/320/6L2.8/5R/ CB_bgn_0.3D_GEK_FR23
AS1810T Z- 413G32n	EMEA	Germany	LX.PJ50X.029	AS1810TZ-413G32n VHP32ATDE1 MC UMACKk 2G+1G/320/6L2.8/5R/ CB_bgn_0.3D_GEK_DE13
AS1810T Z- 413G32n	EMEA	Belgium	LX.PJ50X.030	AS1810TZ-413G32n VHP32ATBE1 MC UMACKk 2G+1G/320/6L2.8/5R/ CB_bgn_0.3D_GEK_NL13
AS1810T Z- 413G32n	EMEA	Holland	LX.PJ50X.031	AS1810TZ-413G32n VHP32ATNL1 MC UMACKk 2G+1G/320/6L2.8/5R/ CB_bgn_0.3D_GEK_NL12
AS1810T Z- 413G32i	EMEA	Russia	LX.PJ50X.046	AS1810TZ-413G32i VHP32ATRU1 MC UMACKk 2G+1G/320/6L2.8/5R/ CB_bg_0.3D_GEK_RU11
AS1810T Z- 413G32n	EMEA	Middle East	LX.PJ50X.034	AS1810TZ-413G32n EM VHP32ATME9 MC UMACKk 2G+1G/320/6L2.8/5R/ CB_bgn_0.3D_GEK_FR22
AS1810T Z- 413G32n	EMEA	Middle East	LX.PJ50X.020	AS1810TZ-413G32n EM VHP32ATME6 MC UMACKk 2G+1G/320/6L2.8/5R/ CB_bgn_0.3D_GEK_EN15
AS1810T Z- 413G32n	EMEA	Middle East	LX.PJ50X.022	AS1810TZ-413G32n EM VHP32ATME2 MC UMACKk 2G+1G/320/6L2.8/5R/ CB_bgn_0.3D_GEK_EN15
AS1810T Z- 413G32n	EMEA	South Africa	LX.PJ50X.024	AS1810TZ-413G32n EM VHP32ATZA2 MC UMACKk 2G+1G/320/6L2.8/5R/ CB_bgn_0.3D_GEK_EN16
AS1810T Z- 413G32n	EMEA	Hungary	LX.PJ50X.039	AS1810TZ-413G32n VHP32ATHU1 MC UMACKk 2G+1G/320/6L2.8/5R/ CB_bgn_0.3D_GEK_HU13
AS1810T Z- 413G32n	EMEA	Middle East	LX.PJ50X.038	AS1810TZ-413G32n EM VHP32ATME4 MC UMACKk 2G+1G/320/6L2.8/5R/ CB_bgn_0.3D_GEK_RU61
AS1810T Z- 413G32n	EMEA	South Africa	LX.PJ50X.037	AS1810TZ-413G32n EM VHP32ATZA4 MC UMACKk 2G+1G/320/6L2.8/5R/ CB_bgn_0.3D_GEK_ENI1
AS1810T Z- 413G32n	EMEA	Israel	LX.PJ50X.036	AS1810TZ-413G32n VHP32ATIL1 MC UMACKk 2G+1G/320/6L2.8/5R/ CB_bgn_0.3D_GEK_HE12
AS1810T Z- 413G32n	EMEA	Ukraine	LX.PJ50X.045	AS1810TZ-413G32n VHP32ATUK1 MC UMACKk 2G+1G/320/6L2.8/5R/ CB_bgn_0.3D_GEK_RU11
AS1810T Z- 413G32n	EMEA	Austria	LX.PJ50X.035	AS1810TZ-413G32n VHP32ATAT1 MC UMACKk 2G+1G/320/6L2.8/5R/ CB_bgn_0.3D_GEK_DE11
AS1810T Z- 413G32n	EMEA	Finland	LX.PJ50X.027	AS1810TZ-413G32n VHP32ATFI2 MC UMACKk 2G+1G/320/6L2.8/5R/ CB_bgn_0.3D_GEK_FI11

Model	RO	Country	Acer Part No	Description
AS1810T Z- 413G32n	EMEA	Middle East	LX.PJ50X.026	AS1810TZ-413G32n EM VHP32ATME4 MC UMACKk 2G+1G/320/6L2.8/5R/ CB_bgn_0.3D_GEK_EN11
AS1810T Z- 413G32n	EMEA	South Africa	LX.PJ50X.025	AS1810TZ-413G32n EM VHP32ATZA1 MC UMACKk 2G+1G/320/6L2.8/5R/ CB_bgn_0.3D_GEK_FR23
AS1810T Z- 413G32n	EMEA	Serbia/ Macedonia	LX.PJ50X.044	AS1810TZ-413G32n EM VHP32ATCS1 MC UMACKk 2G+1G/320/6L2.8/5R/ CB_bgn_0.3D_GEK_SL11
AS1810T Z- 413G32n	EMEA	Czech	LX.PJ50X.007	AS1810TZ-413G32n VHP32ATCZ2 MC UMACKk 2G+1G/320/6L2.8/5R/ CB_bgn_0.3D_GEK_SK13
AS1810T Z- 413G32n	EMEA	Latvia	LX.PJ50X.043	AS1810TZ-413G32n VHP32ATLV1 MC UMACKk 2G+1G/320/6L2.8/5R/ CB_bgn_0.3D_GEK_RU21
AS1810T Z- 413G32n	EMEA	Algeria	LX.PJ50X.008	AS1810TZ-413G32n EM VHP32ATDZ1 MC UMACKk 2G+1G/320/6L2.8/5R/ CB_bgn_0.3D_GEK_ES81
AS1810T Z- 413G32n	EMEA	Denmark	LX.PJ50X.042	AS1810TZ-413G32n VHP32ATDK2 MC UMACKk 2G+1G/320/6L2.8/5R/ CB_bgn_0.3D_GEK_ENS4
AS1810T Z- 413G32n	EMEA	Cyprus	LX.PJ50X.009	AS1810TZ-413G32n VHP32ATCY1 MC UMACKk 2G+1G/320/6L2.8/5R/ CB_bgn_0.3D_GEK_EN11
AS1810T Z- 413G32n	EMEA	Norway	LX.PJ50X.018	AS1810TZ-413G32n VHP32ATNO3 MC UMACKk 2G+1G/320/6L2.8/5R/ CB_bgn_0.3D_GEK_ENS4
AS1810T Z- 413G32n	EMEA	Eastern Europe	LX.PJ50X.017	AS1810TZ-413G32n VHP32ATEU7 MC UMACKk 2G+1G/320/6L2.8/5R/ CB_bgn_0.3D_GEK_ENR2
AS1810T Z- 413G32n	EMEA	Eastern Europe	LX.PJ50X.016	AS1810TZ-413G32n VHP32ATEU5 MC UMACKk 2G+1G/320/6L2.8/5R/ CB_bgn_0.3D_GEK_RO12
AS1810T Z- 413G32n	EMEA	UK	LX.PJ50X.001	AS1810TZ-413G32n VHP32ATGB1 MC UMACKk 2G+1G/320/6L2.8/5R/ CB_bgn_0.3D_GEK_EN14
AS1810T Z- 413G32n	EMEA	Switzerland	LX.PJ50X.002	AS1810TZ-413G32n VHP32ATCH1 MC UMACKk 2G+1G/320/6L2.8/5R/ CB_bgn_0.3D_GEK_IT42
AS1810T Z- 413G32n	EMEA	Italy	LX.PJ50X.005	AS1810TZ-413G32n VHP32ATIT1 MC UMACKk 2G+1G/320/6L2.8/5R/ CB_bgn_0.3D_GEK_IT12
AS1810T Z- 413G32n	EMEA	Greece	LX.PJ50X.003	AS1810TZ-413G32n VHP32ATGR1 MC UMACKk 2G+1G/320/6L2.8/5R/ CB_bgn_0.3D_GEK_EL32
AS1810T Z- 413G32n	EMEA	Spain	LX.PJ50X.004	AS1810TZ-413G32n VHP32ATES1 MC UMACKk 2G+1G/320/6L2.8/5R/ CB_bgn_0.3D_GEK_ES22
AS1810T Z- 413G32n	EMEA	Portugal	LX.PJ50X.006	AS1810TZ-413G32n VHP32ATPT1 MC UMACKk 2G+1G/320/6L2.8/5R/ CB_bgn_0.3D_GEK_PT12

Model	RO	Country	Acer Part No	Description
AS1810T Z- 413G32n	EMEA	Eastern Europe	LX.PJ50X.015	AS1810TZ-413G32n VHP32ATEU5 MC UMACKk 2G+1G/320/6L2.8/5R/ CB_bgn_0.3D_GEK_PL13
AS1810T Z- 413G32n	EMEA	Turkey	LX.PJ50X.014	AS1810TZ-413G32n EM VHP32ATTR1 MC UMACKk 2G+1G/320/6L2.8/5R/ CB_bgn_0.3D_GEK_TR33
AS1810T Z- 413G32n	EMEA	Eastern Europe	LX.PJ50X.013	AS1810TZ-413G32n VHP32ATEU4 MC UMACKk 2G+1G/320/6L2.8/5R/ CB_bgn_0.3D_GEK_SV22
AS1810T Z- 413G32n	EMEA	Eastern Europe	LX.PJ50X.012	AS1810TZ-413G32n VHP32ATEU3 MC UMACKk 2G+1G/320/6L2.8/5R/ CB_bgn_0.3D_GEK_RU23
AS1810T Z- 413G32n	EMEA	Luxembour g	LX.PJ50X.011	AS1810TZ-413G32n VHP32ATLU3 MC UMACKk 2G+1G/320/6L2.8/5R/ CB_bgn_0.3D_GEK_IT41
AS1810T Z- 413G32n	EMEA	Sweden	LX.PJ50X.010	AS1810TZ-413G32n VHP32ATSE1 MC UMACKk 2G+1G/320/6L2.8/5R/ CB_bgn_0.3D_GEK_FI13
AS1810T Z- 413G32n	EMEA	Poland	LX.PJ50X.041	AS1810TZ-413G32n VHP32ATPL1 MC UMACKk 2G+1G/320/6L2.8/5R/ CB_bgn_0.3D_GEK_PL11
AS1810T Z- 413G32n	EMEA	Eastern Europe	LX.PJ50X.040	AS1810TZ-413G32n VHP32ATEU7 MC UMACKk 2G+1G/320/6L2.8/5R/ CB_bgn_0.3D_GEK_SL11
AS1810T Z- 413G32n	EMEA	Middle East	LX.PJ50X.023	AS1810TZ-413G32n EM VHP32ATME2 MC UMACKk 2G+1G/320/6L2.8/5R/ CB_bgn_0.3D_GEK_AR13
AS1810T Z- 413G32n	EMEA	Middle East	LX.PJ50X.021	AS1810TZ-413G32n EM VHP32ATME3 MC UMACKk 2G+1G/320/6L2.8/5R/ CB_bgn_0.3D_GEK_FR23
AS1810T Z- 413G32n	EMEA	Middle East	LX.PJ50X.019	AS1810TZ-413G32n EM VHP32ATME2 MC UMACKk 2G+1G/320/6L2.8/5R/ CB_bgn_0.3D_GEK_AR23
AS1810T Z- 413G32n	EMEA	Denmark	LX.PJ50X.033	AS1810TZ-413G32n VHP32ATDK1 MC UMACKk 2G+1G/320/6L2.8/5R/ CB_bgn_0.3D_GEK_NO13
AS1810T Z- 413G32n	EMEA	Norway	LX.PJ50X.032	AS1810TZ-413G32n VHP32ATNO1 MC UMACKk 2G+1G/320/6L2.8/5R/ CB_bgn_0.3D_GEK_NO12
AS1810T Z- 412G25n	CHINA	China	LX.PJ50X.048	AS1810TZ-412G25n VHP32ATCN1 MC UMACKk 1*2G/250/BT/6L2.8/5R/ CB_bgn_0.3D_BAG_GEK_SC11
AS1810T Z- 412G25n	CHINA	Hong Kong	LX.PJ50X.047	AS1810TZ-412G25n VHP32ATHK2 MC UMACKk 1*2G/250/BT/6L2.8/5R/ CB_bgn_0.3D_BAG_GEK_ZH31
AS1810T Z- 412G32n	AAP	Thailand	LX.PJ40X.052	AS1810TZ-412G32n EM VHP32ATTH1 MC UMACrr 1*2G/320/BT/6L2.8/5R/ CB_bgn_0.3D_ACER 11inch Netbook Bag Black_GEK_TH41
AS1810T Z- 412G32n	AAP	Thailand	LX.PJ40X.051	AS1810TZ-412G32n EM VHP32ATTH1 MC UMACrr 1*2G/320/BT/6L2.8/5R/ CB_bgn_0.3D_ACER 11inch Netbook Bag Black_GEK_TH21

Model	RO	Country	Acer Part No	Description
AS1810T Z- 413G32n	EMEA	South Africa	LX.PJ40X.027	AS1810TZ-413G32n EM VHP32ATZA4 MC UMACrr 2G+1G/320/6L2.8/5R/ CB_bgn_0.3D_GEK_ENI1
AS1810T Z- 413G32n	EMEA	Norway	LX.PJ40X.012	AS1810TZ-413G32n VHP32ATNO1 MC UMACrr 2G+1G/320/6L2.8/5R/ CB_bgn_0.3D_GEK_NO12
AS1810T Z- 413G32n	EMEA	Latvia	LX.PJ40X.011	AS1810TZ-413G32n VHP32ATLV1 MC UMACrr 2G+1G/320/6L2.8/5R/ CB_bgn_0.3D_GEK_RU21
AS1810T Z- 413G32n	EMEA	Algeria	LX.PJ40X.010	AS1810TZ-413G32n EM VHP32ATDZ1 MC UMACrr 2G+1G/320/6L2.8/5R/ CB_bgn_0.3D_GEK_ES81
AS1810T Z- 413G32n	EMEA	Holland	LX.PJ40X.039	AS1810TZ-413G32n VHP32ATNL1 MC UMACrr 2G+1G/320/6L2.8/5R/ CB_bgn_0.3D_GEK_NL12
AS1810T Z- 413G32n	EMEA	Belgium	LX.PJ40X.038	AS1810TZ-413G32n VHP32ATBE1 MC UMACrr 2G+1G/320/6L2.8/5R/ CB_bgn_0.3D_GEK_NL13
AS1810T Z- 413G32n	EMEA	Germany	LX.PJ40X.037	AS1810TZ-413G32n VHP32ATDE1 MC UMACrr 2G+1G/320/6L2.8/5R/ CB_bgn_0.3D_GEK_DE13
AS1810T Z- 413G32n	EMEA	France	LX.PJ40X.036	AS1810TZ-413G32n VHP32ATFR1 MC UMACrr 2G+1G/320/6L2.8/5R/ CB_bgn_0.3D_GEK_FR23
AS1810T Z- 413G32n	EMEA	UK	LX.PJ40X.035	AS1810TZ-413G32n VHP32ATGB1 MC UMACrr 2G+1G/320/6L2.8/5R/ CB_bgn_0.3D_GEK_EN14
AS1810T Z- 413G32n	EMEA	Eastern Europe	LX.PJ40X.022	AS1810TZ-413G32n VHP32ATEU5 MC UMACrr 2G+1G/320/6L2.8/5R/ CB_bgn_0.3D_GEK_RO12
AS1810T Z- 413G32n	EMEA	Serbia/ Macedonia	LX.PJ40X.008	AS1810TZ-413G32n EM VHP32ATCS1 MC UMACrr 2G+1G/320/6L2.8/5R/ CB_bgn_0.3D_GEK_SL11
AS1810T Z- 413G32n	EMEA	Czech	LX.PJ40X.040	AS1810TZ-413G32n VHP32ATCZ2 MC UMACrr 2G+1G/320/6L2.8/5R/ CB_bgn_0.3D_GEK_SK13
AS1810T Z- 413G32n	EMEA	Middle East	LX.PJ40X.009	AS1810TZ-413G32n EM VHP32ATME2 MC UMACrr 2G+1G/320/6L2.8/5R/ CB_bgn_0.3D_GEK_EN15
AS1810T Z- 413G32n	EMEA	Middle East	LX.PJ40X.017	AS1810TZ-413G32n EM VHP32ATME3 MC UMACrr 2G+1G/320/6L2.8/5R/ CB_bgn_0.3D_GEK_FR23
AS1810T Z- 413G32n	EMEA	Middle East	LX.PJ40X.016	AS1810TZ-413G32n EM VHP32ATME6 MC UMACrr 2G+1G/320/6L2.8/5R/ CB_bgn_0.3D_GEK_EN15
AS1810T Z- 413G32n	EMEA	Middle East	LX.PJ40X.015	AS1810TZ-413G32n EM VHP32ATME2 MC UMACrr 2G+1G/320/6L2.8/5R/ CB_bgn_0.3D_GEK_AR23
AS1810T Z- 413G32n	EMEA	Middle East	LX.PJ40X.014	AS1810TZ-413G32n EM VHP32ATME9 MC UMACrr 2G+1G/320/6L2.8/5R/ CB_bgn_0.3D_GEK_FR22

Model	RO	Country	Acer Part No	Description
AS1810T Z- 413G32n	EMEA	Denmark	LX.PJ40X.013	AS1810TZ-413G32n VHP32ATDK1 MC UMACrr 2G+1G/320/6L2.8/5R/ CB_bgn_0.3D_GEK_NO13
AS1810T Z- 413G32i	EMEA	Russia	LX.PJ40X.048	AS1810TZ-413G32i VHP32ATRU1 MC UMACrr 2G+1G/320/6L2.8/5R/ CB_bg_0.3D_GEK_RU11
AS1810T Z- 413G32n	EMEA	Israel	LX.PJ40X.003	AS1810TZ-413G32n VHP32ATIL1 MC UMACrr 2G+1G/320/6L2.8/5R/ CB_bgn_0.3D_GEK_HE12
AS1810T Z- 413G32n	EMEA	Ukraine	LX.PJ40X.047	AS1810TZ-413G32n VHP32ATUK1 MC UMACrr 2G+1G/320/6L2.8/5R/ CB_bgn_0.3D_GEK_RU11
AS1810T Z- 413G32n	EMEA	Austria	LX.PJ40X.005	AS1810TZ-413G32n VHP32ATAT1 MC UMACrr 2G+1G/320/6L2.8/5R/ CB_bgn_0.3D_GEK_DE11
AS1810T Z- 413G32n	EMEA	Finland	LX.PJ40X.004	AS1810TZ-413G32n VHP32ATFI2 MC UMACrr 2G+1G/320/6L2.8/5R/ CB_bgn_0.3D_GEK_FI11
AS1810T Z- 413G32n	EMEA	Middle East	LX.PJ40X.006	AS1810TZ-413G32n EM VHP32ATME4 MC UMACrr 2G+1G/320/6L2.8/5R/ CB_bgn_0.3D_GEK_EN11
AS1810T Z- 413G32n	EMEA	South Africa	LX.PJ40X.042	AS1810TZ-413G32n EM VHP32ATZA1 MC UMACrr 2G+1G/320/6L2.8/5R/ CB_bgn_0.3D_GEK_FR23
AS1810T Z- 413G32n	EMEA	South Africa	LX.PJ40X.007	AS1810TZ-413G32n EM VHP32ATZA2 MC UMACrr 2G+1G/320/6L2.8/5R/ CB_bgn_0.3D_GEK_EN16
AS1810T Z- 413G32n	EMEA	Middle East	LX.PJ40X.041	AS1810TZ-413G32n EM VHP32ATME2 MC UMACrr 2G+1G/320/6L2.8/5R/ CB_bgn_0.3D_GEK_AR13
AS1810T Z- 413G32n	EMEA	Eastern Europe	LX.PJ40X.021	AS1810TZ-413G32n VHP32ATEU5 MC UMACrr 2G+1G/320/6L2.8/5R/ CB_bgn_0.3D_GEK_PL13
AS1810T Z- 413G32n	EMEA	Turkey	LX.PJ40X.020	AS1810TZ-413G32n EM VHP32ATTR1 MC UMACrr 2G+1G/320/6L2.8/5R/ CB_bgn_0.3D_GEK_TR33
AS1810T Z- 413G32n	EMEA	Eastern Europe	LX.PJ40X.019	AS1810TZ-413G32n VHP32ATEU4 MC UMACrr 2G+1G/320/6L2.8/5R/ CB_bgn_0.3D_GEK_SV22
AS1810T Z- 413G32n	EMEA	Eastern Europe	LX.PJ40X.018	AS1810TZ-413G32n VHP32ATEU3 MC UMACrr 2G+1G/320/6L2.8/5R/ CB_bgn_0.3D_GEK_RU23
AS1810T Z- 413G32n	EMEA	Luxembourg	LX.PJ40X.033	AS1810TZ-413G32n VHP32ATLU3 MC UMACrr 2G+1G/320/6L2.8/5R/ CB_bgn_0.3D_GEK_IT41
AS1810T Z- 413G32n	EMEA	Sweden	LX.PJ40X.032	AS1810TZ-413G32n VHP32ATSE1 MC UMACrr 2G+1G/320/6L2.8/5R/ CB_bgn_0.3D_GEK_FI13
AS1810T Z- 413G32n	EMEA	Poland	LX.PJ40X.031	AS1810TZ-413G32n VHP32ATPL1 MC UMACrr 2G+1G/320/6L2.8/5R/ CB_bgn_0.3D_GEK_PL11

Model	RO	Country	Acer Part No	Description
AS1810T Z- 413G32n	EMEA	Eastern Europe	LX.PJ40X.030	AS1810TZ-413G32n VHP32ATEU7 MC UMACrr 2G+1G/320/6L2.8/5R/ CB_bgn_0.3D_GEK_SL11
AS1810T Z- 413G32n	EMEA	Switzerland	LX.PJ40X.034	AS1810TZ-413G32n VHP32ATCH1 MC UMACrr 2G+1G/320/6L2.8/5R/ CB_bgn_0.3D_GEK_IT42
AS1810T Z- 413G32n	EMEA	Italy	LX.PJ40X.043	AS1810TZ-413G32n VHP32ATIT1 MC UMACrr 2G+1G/320/6L2.8/5R/ CB_bgn_0.3D_GEK_IT12
AS1810T Z- 413G32n	EMEA	Greece	LX.PJ40X.045	AS1810TZ-413G32n VHP32ATGR1 MC UMACrr 2G+1G/320/6L2.8/5R/ CB_bgn_0.3D_GEK_EL32
AS1810T Z- 413G32n	EMEA	Spain	LX.PJ40X.044	AS1810TZ-413G32n VHP32ATES1 MC UMACrr 2G+1G/320/6L2.8/5R/ CB_bgn_0.3D_GEK_ES22
AS1810T Z- 413G32n	EMEA	Portugal	LX.PJ40X.046	AS1810TZ-413G32n VHP32ATPT1 MC UMACrr 2G+1G/320/6L2.8/5R/ CB_bgn_0.3D_GEK_PT12
AS1810T Z- 413G32n	EMEA	Denmark	LX.PJ40X.026	AS1810TZ-413G32n VHP32ATDK2 MC UMACrr 2G+1G/320/6L2.8/5R/ CB_bgn_0.3D_GEK_ENS4
AS1810T Z- 413G32n	EMEA	Cyprus	LX.PJ40X.025	AS1810TZ-413G32n VHP32ATCY1 MC UMACrr 2G+1G/320/6L2.8/5R/ CB_bgn_0.3D_GEK_EN11
AS1810T Z- 413G32n	EMEA	Norway	LX.PJ40X.024	AS1810TZ-413G32n VHP32ATNO3 MC UMACrr 2G+1G/320/6L2.8/5R/ CB_bgn_0.3D_GEK_ENS4
AS1810T Z- 413G32n	EMEA	Eastern Europe	LX.PJ40X.023	AS1810TZ-413G32n VHP32ATEU7 MC UMACrr 2G+1G/320/6L2.8/5R/ CB_bgn_0.3D_GEK_ENR2
AS1810T Z- 413G32n	EMEA	Middle East	LX.PJ40X.028	AS1810TZ-413G32n EM VHP32ATME4 MC UMACrr 2G+1G/320/6L2.8/5R/ CB_bgn_0.3D_GEK_RU61
AS1810T Z- 413G32n	EMEA	Hungary	LX.PJ40X.029	AS1810TZ-413G32n VHP32ATHU1 MC UMACrr 2G+1G/320/6L2.8/5R/ CB_bgn_0.3D_GEK_HU13
AS1810T Z- 412G32n	CHINA	China	LX.PJ40X.050	AS1810TZ-412G32n VHP32ATCN1 MC UMACrr 1*2G/320/BT/6L2.8/5R/ CB_bgn_0.3D_BAG_GEK_SC11
AS1810T Z- 412G32n	CHINA	Hong Kong	LX.PJ40X.049	AS1810TZ-412G32n VHP32ATHK2 MC UMACrr 1*2G/320/BT/6L2.8/5R/ CB_bgn_0.3D_BAG_GEK_ZH31
AS1810T Z- 411G25n	AAP	Philippines	LX.PJ40X.002	AS1810TZ-411G25n EM VHP32ATPH1 MC UMACrr 1*1G/250/BT/6L2.8/5R/ CB_n2_0.3D_BAG_GEK_EN14
AS1810T Z- 412G25n	AAP	Philippines	LX.PJ40X.001	AS1810TZ-412G25n EM VHP32ATPH1 MC UMACrr 1*2G/250/BT/6L2.8/5R/ CB_n2_0.3D_BAG_GEK_EN14
AS1810T - 352G25n	WW	GCTWN	S2.SA10X.002	AS1810T-352G25n VHP32AWW1 MC UMACbb 2*1G/250/BT/6L2.8/5R/ CB_n2_0.3D_GEb_ENX1

Model	RO	Country	Acer Part No	Description
AS1810T - 352G25n	AAP	Philippines	LX.SA10X.017	AS1810T-352G25n EM VHP32ATPH1 MC UMACbb 1*2G/250/BT/6L2.8/5R/ CB_n2_0.3D_GEb_EN14
AS1810T - 351G25n	CHINA	China	LX.SA10X.016	AS1810T-351G25n VHP32ATCN1 MC UMACbb 1*1G/250/BT/6L2.8/5R/ CB_n2_0.3D_GEb_SC11
AS1810T - 351G25n	CHINA	Hong Kong	LX.SA10X.015	AS1810T-351G25n VHP32ATHK2 MC UMACbb 1*1G/250/BT/6L2.8/5R/ CB_n2_0.3D_GEb_ZH31
AS1810T - 354G32n	AAP	Thailand	LX.SA10X.014	AS1810T-354G32n EM VHP32ATTH1 MC UMACbb 2*2G/320/BT/6L2.8/5R/ CB_n2_0.3D_GEb_TH21
AS1810T - 354G32n	AAP	Thailand	LX.SA10X.013	AS1810T-354G32n EM VHP32ATTH1 MC UMACbb 2*2G/320/BT/6L2.8/5R/ CB_n2_0.3D_GEb_TH22
AS1810T - 352G25n	AAP	Vietnam	LX.SA10X.011	AS1810T-352G25n EM VHP32ATVN1 MC UMACbb 1*2G/250/BT/6L2.8/5R/ CB_n2_0.3D_GEb_EN12
AS1810T - 352G25n	AAP	Indonesia	LX.SA10X.012	AS1810T-352G25n EM VHP32ATID1 MC UMACbb 1*2G/250/BT/6L2.8/5R/ CB_n2_0.3D_GEb_ID24
AS1810T - 352G25n	TWN	GCTWN	LX.SA10X.007	AS1810T-352G25n VHP32ATTW1 MC UMACbb 1*2G/250/BT/6L2.8/5R/ CB_n2_0.3D_BAG_GEb_TC11
AS1810T - 352G32n	AAP	Singapore	LX.SA10X.010	AS1810T-352G32n VHP32ATSG1 MC UMACbb 1*2G/320/BT/6L2.8/5R/ CB_n2_0.3D_GEb_EN12
AS1810T - 352G25n	AAP	Japan	LX.SA10X.009	AS1810T-352G25n VHP32AJP1 MC UMACbb 1*2G/250/BT/6L2.8/5R/ CB_n2_0.3D_GEb_JA11_BE22
AS1810T - 352G25n	AAP	Japan	LX.SA10X.008	AS1810T-352G25n VHP32APJP1 MC UMACbb 1*2G/250/BT/6L2.8/5R/ CB_n2_0.3D_GEb_JA11_BE22F
AS1810T - 352G25n	AAP	Singapore	LX.SA10X.006	AS1810T-352G25n VHP32ATSG1 MC UMACbb 1*2G/250/BT/6L2.8/5R/ CB_n2_0.3D_GEb_EN12
AS1810T - 352G25n	AAP	India	LX.SA10X.005	AS1810T-352G25n VHP32ATIN1 MC UMACbb 1*2G/250/BT/6L2.8/5R/ CB_n2_0.3D_GEb_EN12
AS1810T - 352G32n	AAP	India	LX.SA10X.004	AS1810T-352G32n VHP32ATIN1 MC UMACbb 1*2G/320/BT/6L2.8/5R/ CB_n2_0.3D_GEb_EN12
AS1810T - 354G25n	AAP	Australia/ New Zealand	LX.SA10X.002	AS1810T-354G25n VHP32ATAU1 MC UMACbb 2*2G/250/BT/6L2.8/5R/ CB_n2_0.3D_GEb_EN12
AS1810T - 354G32n	AAP	Australia/ New Zealand	LX.SA10X.003	AS1810T-354G32n VHP32ATAU1 MC UMACbb 2*2G/320/BT/6L2.8/5R/ CB_n2_0.3D_GEb_EN12
AS1810T - 352G25n	AAP	Australia/ New Zealand	LX.SA10X.001	AS1810T-352G25n VHP32ATAU1 MC UMACbb 1*2G/250/BT/6L2.8/5R/ CB_n2_0.3D_GEb_EN12

Model	RO	Country	Acer Part No	Description
AS1810T - 353G25n	EMEA	Portugal	LX.SA20X.060	AS1810T-353G25n VHP32ATPT1 MC UMACKk 2G+1G/250/6L2.8/5R/ CB_n2_0.3D_GEK_PT12
AS1810T - 353G25n	EMEA	Spain	LX.SA20X.059	AS1810T-353G25n VHP32ATES1 MC UMACKk 2G+1G/250/6L2.8/5R/ CB_n2_0.3D_GEK_ES22
AS1810T - 353G25n	EMEA	Greece	LX.SA20X.058	AS1810T-353G25n VHP32ATGR1 MC UMACKk 2G+1G/250/6L2.8/5R/ CB_n2_0.3D_GEK_EL32
AS1810T - 353G25n	EMEA	Italy	LX.SA20X.057	AS1810T-353G25n VHP32ATIT1 MC UMACKk 2G+1G/250/6L2.8/5R/CB_n2_0.3D_GEK_IT12
AS1810T - 353G25n	EMEA	UK	LX.SA20X.055	AS1810T-353G25n VHP32ATGB1 MC UMACKk 2G+1G/250/6L2.8/5R/ CB_n2_0.3D_GEK_EN14
AS1810T - 353G25n	EMEA	Belgium	LX.SA20X.052	AS1810T-353G25n VHP32ATBE1 MC UMACKk 2G+1G/250/6L2.8/5R/ CB_n2_0.3D_GEK_NL13
AS1810T - 353G25n	EMEA	Germany	LX.SA20X.053	AS1810T-353G25n VHP32ATDE1 MC UMACKk 2G+1G/250/6L2.8/5R/ CB_n2_0.3D_GEK_DE13
AS1810T - 353G25n	EMEA	France	LX.SA20X.054	AS1810T-353G25n VHP32ATFR1 MC UMACKk 2G+1G/250/6L2.8/5R/ CB_n2_0.3D_GEK_FR23
AS1810T - 353G25n	EMEA	Switzerland	LX.SA20X.056	AS1810T-353G25n VHP32ATCH1 MC UMACKk 2G+1G/250/6L2.8/5R/ CB_n2_0.3D_GEK_IT42
AS1810T - 353G25n	EMEA	Holland	LX.SA20X.051	AS1810T-353G25n VHP32ATNL1 MC UMACKk 2G+1G/250/6L2.8/5R/ CB_n2_0.3D_GEK_NL12
AS1810T - 353G25n	EMEA	South Africa	LX.SA20X.034	AS1810T-353G25n EM VHP32ATZA4 MC UMACKk 2G+1G/250/6L2.8/5R/ CB_n2_0.3D_GEK_ENI1
AS1810T - 353G25n	EMEA	Israel	LX.SA20X.035	AS1810T-353G25n VHP32ATIL1 MC UMACKk 2G+1G/250/6L2.8/5R/ CB_n2_0.3D_GEK_HE12
AS1810T -353G25i	EMEA	Ukraine	LX.SA20X.036	AS1810T-353G25i VHP32ATUK1 MC UMACKk 2G+1G/250/6L2.8/5R/ CB_abg_0.3D_GEK_RU11
AS1810T - 353G25n	EMEA	Austria	LX.SA20X.037	AS1810T-353G25n VHP32ATAT1 MC UMACKk 2G+1G/250/6L2.8/5R/ CB_n2_0.3D_GEK_DE11
AS1810T - 353G25n	EMEA	Finland	LX.SA20X.038	AS1810T-353G25n VHP32ATFI2 MC UMACKk 2G+1G/250/6L2.8/5R/CB_n2_0.3D_GEK_FI11
AS1810T - 353G25n	EMEA	Middle East	LX.SA20X.039	AS1810T-353G25n EM VHP32ATME4 MC UMACKk 2G+1G/250/6L2.8/5R/ CB_n2_0.3D_GEK_EN11
AS1810T - 353G25n	EMEA	South Africa	LX.SA20X.040	AS1810T-353G25n EM VHP32ATZA1 MC UMACKk 2G+1G/250/6L2.8/5R/ CB_n2_0.3D_GEK_FR23

Model	RO	Country	Acer Part No	Description
AS1810T - 353G25n	EMEA	South Africa	LX.SA20X.041	AS1810T-353G25n EM VHP32ATZA2 MC UMACKk 2G+1G/250/6L2.8/5R/ CB_n2_0.3D_GEK_EN16
AS1810T - 353G25n	EMEA	Middle East	LX.SA20X.042	AS1810T-353G25n EM VHP32ATME2 MC UMACKk 2G+1G/250/6L2.8/5R/ CB_n2_0.3D_GEK_AR13
AS1810T - 353G25n	EMEA	Turkey	LX.SA20X.025	AS1810T-353G25n EM VHP32ATTR1 MC UMACKk 2G+1G/250/6L2.8/5R/ CB_n2_0.3D_GEK_TR33
AS1810T - 353G25n	EMEA	Eastern Europe	LX.SA20X.026	AS1810T-353G25n VHP32ATEU4 MC UMACKk 2G+1G/250/6L2.8/5R/ CB_n2_0.3D_GEK_SV22
AS1810T - 353G25n	EMEA	Eastern Europe	LX.SA20X.027	AS1810T-353G25n VHP32ATEU3 MC UMACKk 2G+1G/250/6L2.8/5R/ CB_n2_0.3D_GEK_RU23
AS1810T - 353G25n	EMEA	Luxembourg	LX.SA20X.028	AS1810T-353G25n VHP32ATLU3 MC UMACKk 2G+1G/250/6L2.8/5R/ CB_n2_0.3D_GEK_IT41
AS1810T - 353G25n	EMEA	Sweden	LX.SA20X.029	AS1810T-353G25n VHP32ATSE1 MC UMACKk 2G+1G/250/6L2.8/5R/ CB_n2_0.3D_GEK_FI13
AS1810T - 353G25n	EMEA	Poland	LX.SA20X.030	AS1810T-353G25n VHP32ATPL1 MC UMACKk 2G+1G/250/6L2.8/5R/ CB_n2_0.3D_GEK_PL11
AS1810T - 353G25n	EMEA	Eastern Europe	LX.SA20X.031	AS1810T-353G25n VHP32ATEU7 MC UMACKk 2G+1G/250/6L2.8/5R/ CB_n2_0.3D_GEK_SL11
AS1810T - 353G25n	EMEA	Hungary	LX.SA20X.032	AS1810T-353G25n VHP32ATHU1 MC UMACKk 2G+1G/250/6L2.8/5R/ CB_n2_0.3D_GEK_HU13
AS1810T - 353G25n	EMEA	Middle East	LX.SA20X.033	AS1810T-353G25n EM VHP32ATME4 MC UMACKk 2G+1G/250/6L2.8/5R/ CB_n2_0.3D_GEK_RU61
AS1810T - 353G25n	EMEA	Eastern Europe	LX.SA20X.023	AS1810T-353G25n VHP32ATEU5 MC UMACKk 2G+1G/250/6L2.8/5R/ CB_n2_0.3D_GEK_RO12
AS1810T - 353G25n	EMEA	Eastern Europe	LX.SA20X.024	AS1810T-353G25n VHP32ATEU5 MC UMACKk 2G+1G/250/6L2.8/5R/ CB_n2_0.3D_GEK_PL13
AS1810T - 353G25n	EMEA	Middle East	LX.SA20X.043	AS1810T-353G25n EM VHP32ATME2 MC UMACKk 2G+1G/250/6L2.8/5R/ CB_n2_0.3D_GEK_EN15
AS1810T - 353G25n	EMEA	Middle East	LX.SA20X.044	AS1810T-353G25n EM VHP32ATME3 MC UMACKk 2G+1G/250/6L2.8/5R/ CB_n2_0.3D_GEK_FR23
AS1810T - 353G25n	EMEA	Middle East	LX.SA20X.045	AS1810T-353G25n EM VHP32ATME6 MC UMACKk 2G+1G/250/6L2.8/5R/ CB_n2_0.3D_GEK_EN15
AS1810T - 353G25n	EMEA	Middle East	LX.SA20X.046	AS1810T-353G25n EM VHP32ATME2 MC UMACKk 2G+1G/250/6L2.8/5R/ CB_n2_0.3D_GEK_AR23

Model	RO	Country	Acer Part No	Description
AS1810T - 353G25n	EMEA	Middle East	LX.SA20X.047	AS1810T-353G25n EM VHP32ATME9 MC UMACKk 2G+1G/250/6L2.8/5R/ CB_n2_0.3D_GEK_FR22
AS1810T - 353G25n	EMEA	Denmark	LX.SA20X.048	AS1810T-353G25n VHP32ATDK1 MC UMACKk 2G+1G/250/6L2.8/5R/ CB_n2_0.3D_GEK_NO13
AS1810T -353G25i	EMEA	Russia	LX.SA20X.049	AS1810T-353G25i VHP32ATRU1 MC UMACKk 2G+1G/250/6L2.8/5R/ CB_abg_0.3D_GEK_RU11
AS1810T - 353G25n	EMEA	Norway	LX.SA20X.050	AS1810T-353G25n VHP32ATNO1 MC UMACKk 2G+1G/250/6L2.8/5R/ CB_n2_0.3D_GEK_NO12
AS1810T - 353G25n	EMEA	Eastern Europe	LX.SA20X.022	AS1810T-353G25n VHP32ATEU7 MC UMACKk 2G+1G/250/6L2.8/5R/ CB_n2_0.3D_GEK_ENR2
AS1810T - 353G25n	EMEA	Cyprus	LX.SA20X.021	AS1810T-353G25n VHP32ATCY1 MC UMACKk 2G+1G/250/6L2.8/5R/ CB_n2_0.3D_GEK_EN11
AS1810T - 353G25n	EMEA	Algeria	LX.SA20X.019	AS1810T-353G25n EM VHP32ATDZ1 MC UMACKk 2G+1G/250/6L2.8/5R/ CB_n2_0.3D_GEK_ES81
AS1810T - 353G25n	EMEA	Serbia/ Macedonia	LX.SA20X.016	AS1810T-353G25n EM VHP32ATCS1 MC UMACKk 2G+1G/250/6L2.8/5R/ CB_n2_0.3D_GEK_SL11
AS1810T - 353G25n	EMEA	Czech	LX.SA20X.017	AS1810T-353G25n VHP32ATCZ2 MC UMACKk 2G+1G/250/6L2.8/5R/ CB_n2_0.3D_GEK_SK13
AS1810T - 353G25n	EMEA	Latvia	LX.SA20X.018	AS1810T-353G25n VHP32ATLV1 MC UMACKk 2G+1G/250/6L2.8/5R/ CB_n2_0.3D_GEK_RU21
AS1810T - 353G25n	EMEA	Denmark	LX.SA20X.020	AS1810T-353G25n VHP32ATDK2 MC UMACKk 2G+1G/250/6L2.8/5R/ CB_n2_0.3D_GEK_ENS4
AS1810T - 352G25n	CHINA	China	LX.SA20X.015	AS1810T-352G25n VHP32ATCN1 MC UMACKk 1*2G/250/BT/6L2.8/5R/ CB_n2_0.3D_GEK_SC11
AS1810T - 352G25n	CHINA	Hong Kong	LX.SA20X.014	AS1810T-352G25n VHP32ATHK2 MC UMACKk 1*2G/250/BT/6L2.8/5R/ CB_n2_0.3D_GEK_ZH31
AS1810T - 354G25n	AAP	Australia/ New Zealand	LX.SA20X.013	AS1810T-354G25n VHP32ATAU1 MC UMACKk 2*2G/250/BT/6L2.8/5R/ CB_n2_0.3D_GEK_EN12
AS1810T - 354G32n	AAP	Thailand	LX.SA20X.012	AS1810T-354G32n EM VHP32ATTH1 MC UMACKk 2*2G/320/BT/6L2.8/5R/ CB_n2_0.3D_GEK_TH21
AS1810T - 354G32n	AAP	Thailand	LX.SA20X.011	AS1810T-354G32n EM VHP32ATTH1 MC UMACKk 2*2G/320/BT/6L2.8/5R/ CB_n2_0.3D_GEK_TH22
AS1810T - 352G25n	AAP	Indonesia	LX.SA20X.010	AS1810T-352G25n EM VHP32ATID1 MC UMACKk 1*2G/250/BT/6L2.8/5R/ CB_n2_0.3D_GEK_ID24

Model	RO	Country	Acer Part No	Description
AS1810T - 352G25n	AAP	Vietnam	LX.SA20X.009	AS1810T-352G25n EM VHP32ATVN1 MC UMACKk 1*2G/250/BT/6L2.8/5R/ CB_n2_0.3D_GEk_EN13
AS1810T - 352G25n	AAP	Singapore	LX.SA20X.008	AS1810T-352G25n VHP32ATSG1 MC UMACKk 1*2G/250/BT/6L2.8/5R/ CB_n2_0.3D_GEk_EN12
AS1810T - 352G32n	AAP	Singapore	LX.SA20X.007	AS1810T-352G32n VHP32ATSG1 MC UMACKk 1*2G/320/BT/6L2.8/5R/ CB_n2_0.3D_GEk_EN12
AS1810T - 352G25n	AAP	Japan	LX.SA20X.005	AS1810T-352G25n VHP32APJP1 MC UMACKk 1*2G/250/BT/6L2.8/5R/ CB_n2_0.3D_GEk_JA11_BK22F
AS1810T - 352G25n	AAP	Japan	LX.SA20X.006	AS1810T-352G25n VHP32AJP1 MC UMACKk 1*2G/250/BT/6L2.8/5R/ CB_n2_0.3D_GEk_JA11_BK22
AS1810T - 352G32n	AAP	Malaysia	LX.SA20X.004	AS1810T-352G32n EM VHP32ATMY1 MC UMACKk 1*2G/320/BT/6L2.8/5R/ CB_n2_0.3D_GEk_EN14
AS1810T - 352G25n	AAP	Australia/ New Zealand	LX.SA20X.001	AS1810T-352G25n VHP32ATAU1 MC UMACKk 1*2G/250/BT/6L2.8/5R/ CB_n2_0.3D_GEk_EN12
AS1810T - 352G25n	AAP	India	LX.SA20X.003	AS1810T-352G25n VHP32ATIN1 MC UMACKk 1*2G/250/BT/6L2.8/5R/ CB_n2_0.3D_GEk_EN12
AS1810T - 352G32n	AAP	India	LX.SA20X.002	AS1810T-352G32n VHP32ATIN1 MC UMACKk 1*2G/320/BT/6L2.8/5R/ CB_n2_0.3D_GEk_EN12
AS1810T - 352G25n	AAP	Philippines	LX.SA30X.013	AS1810T-352G25n EM VHP32ATPH1 MC UMACrr 1*2G/250/BT/6L2.8/5R/ CB_n2_0.3D_GEk_EN14
AS1810T - 352G32n	AAP	Singapore	LX.SA30X.010	AS1810T-352G32n VHP32ATSG1 MC UMACrr 1*2G/320/BT/6L2.8/5R/ CB_n2_0.3D_GEk_EN12
AS1810T - 352G32n	AAP	Thailand	LX.SA30X.009	AS1810T-352G32n EM VHP32ATTH1 MC UMACrr 1*2G/320/BT/6L2.8/5R/ CB_n2_0.3D_GEk_TH21
AS1810T - 352G32n	CHINA	China	LX.SA30X.012	AS1810T-352G32n VHP32ATCN1 MC UMACrr 1*2G/320/BT/6L2.8/5R/ CB_n2_0.3D_GEk_SC11
AS1810T - 352G32n	CHINA	Hong Kong	LX.SA30X.011	AS1810T-352G32n VHP32ATHK2 MC UMACrr 1*2G/320/BT/6L2.8/5R/ CB_n2_0.3D_GEk_ZH31
AS1810T - 354G32n	AAP	Thailand	LX.SA30X.008	AS1810T-354G32n EM VHP32ATTH1 MC UMACrr 2*2G/320/BT/6L2.8/5R/ CB_n2_0.3D_GEk_TH21
AS1810T - 354G32n	AAP	Thailand	LX.SA30X.007	AS1810T-354G32n EM VHP32ATTH1 MC UMACrr 2*2G/320/BT/6L2.8/5R/ CB_n2_0.3D_GEk_TH22
AS1810T - 352G25n	AAP	Indonesia	LX.SA30X.006	AS1810T-352G25n EM VHP32ATID1 MC UMACrr 1*2G/250/BT/6L2.8/5R/ CB_n2_0.3D_GEk_ID24

Model	RO	Country	Acer Part No	Description
AS1810T - 352G25n	AAP	Japan	LX.SA30X.005	AS1810T-352G25n VHP32AJP1 MC UMACrr 1*2G/250/BT/6L2.8/5R/ CB_n2_0.3D_GEK_JA11_RR22
AS1810T - 352G25n	AAP	Japan	LX.SA30X.004	AS1810T-352G25n VHP32APJP1 MC UMACrr 1*2G/250/BT/6L2.8/5R/ CB_n2_0.3D_GEK_JA11_RR22F
AS1810T - 353G32n	PA	USA	LX.SA30X.003	AS1810T-353G32n VHP32ATUS1 MC UMACrr 2G+1G/320/6L2.8/5R/ CB_n2_0.3D_GEK_EN32
AS1810T - 352G25n	AAP	India	LX.SA30X.002	AS1810T-352G25n VHP32ATIN1 MC UMACrr 1*2G/250/BT/6L2.8/5R/ CB_n2_0.3D_GEK_EN12
AS1810T - 352G32n	AAP	India	LX.SA30X.001	AS1810T-352G32n VHP32ATIN1 MC UMACrr 1*2G/320/BT/6L2.8/5R/ CB_n2_0.3D_GEK_EN12

Model	CPU	LCD	VGA Chip	Memory 1	HDD 1(GB)
AS1410- 722G25n	CM723B	NLED11.6WXGAG	UMA	SO2GBII6	N250GB5.4KS
AS1410- 721G16n	CM723B	NLED11.6WXGAG	UMA	SO1GBII6	N160GB5.4KS
AS1410- 721G25n	CM723B	NLED11.6WXGAG	UMA	SO1GBII6	N250GB5.4KS
AS1410- 721G16n	CM723B	NLED11.6WXGAG	UMA	SO1GBII6	N160GB5.4KS
AS1410- 721G16n	CM723B	NLED11.6WXGAG	UMA	SO1GBII6	N160GB5.4KS
AS1410- 721G16n	CM723B	NLED11.6WXGAG	UMA	SO1GBII6	N160GB5.4KS
AS1410- 721G16n	CM723B	NLED11.6WXGAG	UMA	SO1GBII6	N160GB5.4KS
AS1410- 721G16n	CM723B	NLED11.6WXGAG	UMA	SO1GBII6	N160GB5.4KS
AS1410- 721G16n	CM723B	NLED11.6WXGAG	UMA	SO1GBII6	N160GB5.4KS
AS1410- 721G16n	CM723B	NLED11.6WXGAG	UMA	SO1GBII6	N160GB5.4KS
AS1410- 722G25n	CM723B	NLED11.6WXGAG	UMA	SO2GBII6	N250GB5.4KS
AS1410- 722G25n	CM723B	NLED11.6WXGAG	UMA	SO2GBII6	N250GB5.4KS
AS1410- 722G25n	CM723B	NLED11.6WXGAG	UMA	SO2GBII6	N250GB5.4KS
AS1410- 722G25n	CM723B	NLED11.6WXGAG	UMA	SO2GBII6	N250GB5.4KS
AS1410- 722G25n	CM723B	NLED11.6WXGAG	UMA	SO2GBII6	N250GB5.4KS
AS1410- 722G25n	CM723B	NLED11.6WXGAG	UMA	SO2GBII6	N250GB5.4KS
AS1410- 722G25n	CM723B	NLED11.6WXGAG	UMA	SO2GBII6	N250GB5.4KS
AS1410- 722G25n	CM723B	NLED11.6WXGAG	UMA	SO2GBII6	N250GB5.4KS

Model	CPU	LCD	VGA Chip	Memory 1	HDD 1(GB)
AS1410-722G25i	CM723B	NLED11.6WXGAG	UMA	SO2GBII6	N250GB5.4KS
AS1410-722G25n	CM723B	NLED11.6WXGAG	UMA	SO2GBII6	N250GB5.4KS
AS1410-722G25n	CM723B	NLED11.6WXGAG	UMA	SO2GBII6	N250GB5.4KS
AS1410-722G25n	CM723B	NLED11.6WXGAG	UMA	SO2GBII6	N250GB5.4KS
AS1410-722G25n	CM723B	NLED11.6WXGAG	UMA	SO2GBII6	N250GB5.4KS
AS1410-722G25n	CM723B	NLED11.6WXGAG	UMA	SO2GBII6	N250GB5.4KS
AS1410-722G25n	CM723B	NLED11.6WXGAG	UMA	SO2GBII6	N250GB5.4KS
AS1410-722G25n	CM723B	NLED11.6WXGAG	UMA	SO2GBII6	N250GB5.4KS
AS1410-722G25n	CM723B	NLED11.6WXGAG	UMA	SO2GBII6	N250GB5.4KS
AS1410-722G25n	CM723B	NLED11.6WXGAG	UMA	SO2GBII6	N250GB5.4KS
AS1410-722G25n	CM723B	NLED11.6WXGAG	UMA	SO2GBII6	N250GB5.4KS
AS1410-722G25n	CM723B	NLED11.6WXGAG	UMA	SO2GBII6	N250GB5.4KS
AS1410-722G25n	CM723B	NLED11.6WXGAG	UMA	SO2GBII6	N250GB5.4KS
AS1410-722G25n	CM723B	NLED11.6WXGAG	UMA	SO2GBII6	N250GB5.4KS
AS1410-722G25n	CM723B	NLED11.6WXGAG	UMA	SO2GBII6	N250GB5.4KS
AS1410-722G25n	CM723B	NLED11.6WXGAG	UMA	SO2GBII6	N250GB5.4KS
AS1410-722G25n	CM723B	NLED11.6WXGAG	UMA	SO2GBII6	N250GB5.4KS
AS1410-722G25n	CM723B	NLED11.6WXGAG	UMA	SO2GBII6	N250GB5.4KS
AS1410-722G25n	CM723B	NLED11.6WXGAG	UMA	SO2GBII6	N250GB5.4KS
AS1410-722G25n	CM723B	NLED11.6WXGAG	UMA	SO2GBII6	N250GB5.4KS
AS1410-722G25n	CM723B	NLED11.6WXGAG	UMA	SO2GBII6	N250GB5.4KS
AS1410-722G25n	CM723B	NLED11.6WXGAG	UMA	SO2GBII6	N250GB5.4KS
AS1410-722G25n	CM723B	NLED11.6WXGAG	UMA	SO2GBII6	N250GB5.4KS

Model	CPU	LCD	VGA Chip	Memory 1	HDD 1(GB)
AS1410-722G25n	CM723B	NLED11.6WXGAG	UMA	SO2GBII6	N250GB5.4KS
AS1410-722G25n	CM723B	NLED11.6WXGAG	UMA	SO2GBII6	N250GB5.4KS
AS1410-722G25n	CM723B	NLED11.6WXGAG	UMA	SO2GBII6	N250GB5.4KS
AS1410-722G25n	CM723B	NLED11.6WXGAG	UMA	SO2GBII6	N250GB5.4KS
AS1410-722G25n	CM723B	NLED11.6WXGAG	UMA	SO2GBII6	N250GB5.4KS
AS1410-722G25n	CM723B	NLED11.6WXGAG	UMA	SO2GBII6	N250GB5.4KS
AS1410-722G25n	CM723B	NLED11.6WXGAG	UMA	SO2GBII6	N250GB5.4KS
AS1410-722G25n	CM723B	NLED11.6WXGAG	UMA	SO2GBII6	N250GB5.4KS
AS1410-722G25n	CM723B	NLED11.6WXGAG	UMA	SO2GBII6	N250GB5.4KS
AS1410-722G25n	CM723B	NLED11.6WXGAG	UMA	SO2GBII6	N250GB5.4KS
AS1410-722G25n	CM723B	NLED11.6WXGAG	UMA	SO2GBII6	N250GB5.4KS
AS1410-722G25n	CM723B	NLED11.6WXGAG	UMA	SO2GBII6	N250GB5.4KS
AS1410-722G16n	CM723B	NLED11.6WXGAG	UMA	SO2GBII6	N160GB5.4KS
AS1410-722G25n	CM723B	NLED11.6WXGAG	UMA	SO2GBII6	N250GB5.4KS
AS1410-721G16i	CM723B	NLED11.6WXGAG	UMA	SO1GBII6	N160GB5.4KS
AS1410-72_br2G25n	CM723B _BR	NLED11.6WXGAG _BR	UMA	SO2GBII8_ BR	N250GB5.4KS_BR
AS1410-721G16n	CM723B	NLED11.6WXGAG	UMA	SO1GBII6	N160GB5.4KS
AS1410-722G25n	CM723B	NLED11.6WXGAG	UMA	SO2GBII6	N250GB5.4KS
AS1410-721G25n	CM723B	NLED11.6WXGAG	UMA	SO1GBII6	N250GB5.4KS
AS1410-721G25n	CM723B	NLED11.6WXGAG	UMA	SO1GBII6	N250GB5.4KS
AS1410-722G25n	CM723B	NLED11.6WXGAG	UMA	SO2GBII6	N250GB5.4KS
AS1410-721G16n	CM723B	NLED11.6WXGAG	UMA	SO1GBII6	N160GB5.4KS
AS1410-723G25n	CM723B	NLED11.6WXGAG	UMA	SO2GBII6	N250GB5.4KS

Model	CPU	LCD	VGA Chip	Memory 1	HDD 1(GB)
AS1410-722G25n	CM723B	NLED11.6WVGAG	UMA	SO2GBII6	N250GB5.4KS
AS1410-722G25n	CM723B	NLED11.6WVGAG	UMA	SO2GBII6	N250GB5.4KS
AS1410-723G25n	CM723B	NLED11.6WVGAG	UMA	SO2GBII6	N250GB5.4KS
AS1410-722G25n	CM723B	NLED11.6WVGAG	UMA	SO2GBII6	N250GB5.4KS
AS1410-722G25n	CM723B	NLED11.6WVGAG	UMA	SO2GBII6	N250GB5.4KS
AS1410-722G25n	CM723B	NLED11.6WVGAG	UMA	SO2GBII6	N250GB5.4KS
AS1410-722G25n	CM723B	NLED11.6WVGAG	UMA	SO2GBII6	N250GB5.4KS
AS1410-722G25i	CM723B	NLED11.6WVGAG	UMA	SO2GBII6	N250GB5.4KS
AS1410-722G25n	CM723B	NLED11.6WVGAG	UMA	SO2GBII6	N250GB5.4KS
AS1410-722G25n	CM723B	NLED11.6WVGAG	UMA	SO2GBII6	N250GB5.4KS
AS1410-722G25n	CM723B	NLED11.6WVGAG	UMA	SO2GBII6	N250GB5.4KS
AS1410-722G25n	CM723B	NLED11.6WVGAG	UMA	SO2GBII6	N250GB5.4KS
AS1410-722G25n	CM723B	NLED11.6WVGAG	UMA	SO2GBII6	N250GB5.4KS
AS1410-722G25n	CM723B	NLED11.6WVGAG	UMA	SO2GBII6	N250GB5.4KS
AS1410-722G25n	CM723B	NLED11.6WVGAG	UMA	SO2GBII6	N250GB5.4KS
AS1410-722G25n	CM723B	NLED11.6WVGAG	UMA	SO2GBII6	N250GB5.4KS
AS1410-722G25n	CM723B	NLED11.6WVGAG	UMA	SO2GBII6	N250GB5.4KS
AS1410-722G25n	CM723B	NLED11.6WVGAG	UMA	SO2GBII6	N250GB5.4KS
AS1410-722G25n	CM723B	NLED11.6WVGAG	UMA	SO2GBII6	N250GB5.4KS
AS1410-722G25n	CM723B	NLED11.6WVGAG	UMA	SO2GBII6	N250GB5.4KS
AS1410-722G25n	CM723B	NLED11.6WVGAG	UMA	SO2GBII6	N250GB5.4KS
AS1410-722G25n	CM723B	NLED11.6WVGAG	UMA	SO2GBII6	N250GB5.4KS
AS1410-722G25n	CM723B	NLED11.6WVGAG	UMA	SO2GBII6	N250GB5.4KS

Model	CPU	LCD	VGA Chip	Memory 1	HDD 1(GB)
AS1410-722G16n	CM723B	NLED11.6WXGAG	UMA	SO2GBII6	N160GB5.4KS
AS1410-722G25i	CM723B	NLED11.6WXGAG	UMA	SO1GBII6	N250GB5.4KS
AS1410-723G25n	CM723B	NLED11.6WXGAG	UMA	SO2GBII6	N250GB5.4KS
AS1410-721G16n	CM723B	NLED11.6WXGAG	UMA	SO1GBII6	N160GB5.4KS
AS1410-721G16n	CM723B	NLED11.6WXGAG	UMA	SO1GBII6	N160GB5.4KS
AS1410-721G25n	CM723B	NLED11.6WXGAG	UMA	SO1GBII6	N250GB5.4KS
AS1410-722G25n	CM723B	NLED11.6WXGAG	UMA	SO2GBII6	N250GB5.4KS
AS1410-722G25n	CM723B	NLED11.6WXGAG	UMA	SO2GBII6	N250GB5.4KS
AS1410-721G25n	CM723B	NLED11.6WXGAG	UMA	SO1GBII6	N250GB5.4KS
AS1410-721G16n	CM723B	NLED11.6WXGAG	UMA	SO1GBII6	N160GB5.4KS
AS1410-721G16n	CM723B	NLED11.6WXGAG	UMA	SO1GBII6	N160GB5.4KS
AS1410-721G16n	CM723B	NLED11.6WXGAG	UMA	SO1GBII6	N160GB5.4KS
AS1410-722G25n	CM723B	NLED11.6WXGAG	UMA	SO2GBII6	N250GB5.4KS
AS1410-722G25n	CM723B	NLED11.6WXGAG	UMA	SO2GBII6	N250GB5.4KS
AS1410-722G25n	CM723B	NLED11.6WXGAG	UMA	SO2GBII6	N250GB5.4KS
AS1410-722G25n	CM723B	NLED11.6WXGAG	UMA	SO2GBII6	N250GB5.4KS
AS1410-722G25n	CM723B	NLED11.6WXGAG	UMA	SO2GBII6	N250GB5.4KS
AS1410-722G25n	CM723B	NLED11.6WXGAG	UMA	SO2GBII6	N250GB5.4KS
AS1410-722G25n	CM723B	NLED11.6WXGAG	UMA	SO2GBII6	N250GB5.4KS
AS1410-722G25n	CM723B	NLED11.6WXGAG	UMA	SO2GBII6	N250GB5.4KS
AS1410-722G25n	CM723B	NLED11.6WXGAG	UMA	SO2GBII6	N250GB5.4KS
AS1410-722G25n	CM723B	NLED11.6WXGAG	UMA	SO2GBII6	N250GB5.4KS
AS1410-722G25n	CM723B	NLED11.6WXGAG	UMA	SO2GBII6	N250GB5.4KS
AS1410-722G25n	CM723B	NLED11.6WXGAG	UMA	SO2GBII6	N250GB5.4KS
AS1410-722G25n	CM723B	NLED11.6WXGAG	UMA	SO2GBII6	N250GB5.4KS
AS1410-722G25n	CM723B	NLED11.6WXGAG	UMA	SO2GBII6	N250GB5.4KS
AS1410-722G25n	CM723B	NLED11.6WXGAG	UMA	SO2GBII6	N250GB5.4KS
AS1410-722G25n	CM723B	NLED11.6WXGAG	UMA	SO2GBII6	N250GB5.4KS
AS1410-722G25n	CM723B	NLED11.6WXGAG	UMA	SO2GBII6	N250GB5.4KS
AS1410-722G25n	CM723B	NLED11.6WXGAG	UMA	SO2GBII6	N250GB5.4KS
AS1410-722G25n	CM723B	NLED11.6WXGAG	UMA	SO2GBII6	N250GB5.4KS

Model	CPU	LCD	VGA Chip	Memory 1	HDD 1(GB)
AS1410-722G25n	CM723B	NLED11.6WGXGAG	UMA	SO2GBII6	N250GB5.4KS
AS1410-722G25n	CM723B	NLED11.6WGXGAG	UMA	SO2GBII6	N250GB5.4KS
AS1410-722G25n	CM723B	NLED11.6WGXGAG	UMA	SO2GBII6	N250GB5.4KS
AS1410-722G25n	CM723B	NLED11.6WGXGAG	UMA	SO2GBII6	N250GB5.4KS
AS1410-722G25n	CM723B	NLED11.6WGXGAG	UMA	SO2GBII6	N250GB5.4KS
AS1410-722G25n	CM723B	NLED11.6WGXGAG	UMA	SO2GBII6	N250GB5.4KS
AS1410-722G25n	CM723B	NLED11.6WGXGAG	UMA	SO2GBII6	N250GB5.4KS
AS1410-722G25n	CM723B	NLED11.6WGXGAG	UMA	SO2GBII6	N250GB5.4KS
AS1410-722G25n	CM723B	NLED11.6WGXGAG	UMA	SO2GBII6	N250GB5.4KS
AS1410-722G25n	CM723B	NLED11.6WGXGAG	UMA	SO2GBII6	N250GB5.4KS
AS1410-722G25n	CM723B	NLED11.6WGXGAG	UMA	SO2GBII6	N250GB5.4KS
AS1410-722G25n	CM723B	NLED11.6WGXGAG	UMA	SO2GBII6	N250GB5.4KS
AS1410-722G25n	CM723B	NLED11.6WGXGAG	UMA	SO2GBII6	N250GB5.4KS
AS1410-722G25n	CM723B	NLED11.6WGXGAG	UMA	SO2GBII6	N250GB5.4KS
AS1410-722G25n	CM723B	NLED11.6WGXGAG	UMA	SO2GBII6	N250GB5.4KS
AS1410-722G25n	CM723B	NLED11.6WGXGAG	UMA	SO2GBII6	N250GB5.4KS
AS1410-722G25n	CM723B	NLED11.6WGXGAG	UMA	SO2GBII6	N250GB5.4KS
AS1410-722G25n	CM723B	NLED11.6WGXGAG	UMA	SO2GBII6	N250GB5.4KS
AS1410-722G25n	CM723B	NLED11.6WGXGAG	UMA	SO2GBII6	N250GB5.4KS
AS1410-722G25n	CM723B	NLED11.6WGXGAG	UMA	SO2GBII6	N250GB5.4KS
AS1410-722G25n	CM723B	NLED11.6WGXGAG	UMA	SO2GBII6	N250GB5.4KS
AS1410-722G25n	CM723B	NLED11.6WGXGAG	UMA	SO2GBII6	N250GB5.4KS
AS1410-722G25n	CM723B	NLED11.6WGXGAG	UMA	SO2GBII6	N250GB5.4KS
AS1410-722G25n	CM723B	NLED11.6WGXGAG	UMA	SO2GBII6	N250GB5.4KS
AS1410-722G25n	CM723B	NLED11.6WGXGAG	UMA	SO2GBII6	N250GB5.4KS
AS1410-722G25n	CM723B	NLED11.6WGXGAG	UMA	SO2GBII6	N250GB5.4KS
AS1410-722G25n	CM723B	NLED11.6WGXGAG	UMA	SO2GBII6	N250GB5.4KS
AS1410-722G25n	CM723B	NLED11.6WGXGAG	UMA	SO2GBII6	N250GB5.4KS

Model	CPU	LCD	VGA Chip	Memory 1	HDD 1(GB)
AS1410-722G25n	CM723B	NLED11.6WXGAG	UMA	SO2GBII6	N250GB5.4KS
AS1410-722G25n	CM723B	NLED11.6WXGAG	UMA	SO2GBII6	N250GB5.4KS
AS1410-722G25n	CM723B	NLED11.6WXGAG	UMA	SO2GBII6	N250GB5.4KS
AS1410-722G25n	CM723B	NLED11.6WXGAG	UMA	SO2GBII6	N250GB5.4KS
AS1410-722G25n	CM723B	NLED11.6WXGAG	UMA	SO2GBII6	N250GB5.4KS
AS1410-722G25n	CM723B	NLED11.6WXGAG	UMA	SO2GBII6	N250GB5.4KS
AS1410-722G25n	CM723B	NLED11.6WXGAG	UMA	SO2GBII6	N250GB5.4KS
AS1410-722G16n	CM723B	NLED11.6WXGAG	UMA	SO2GBII6	N160GB5.4KS
AS1410-722G25n	CM723B	NLED11.6WXGAG	UMA	SO2GBII6	N250GB5.4KS
AS1810TZ-413G32n	PMDSU 4100B	NLED11.6WXGAG	UMA	SO2GBII6	N320GB5.4KS
AS1810TZ-413G32n	PMDSU 4100B	NLED11.6WXGAG	UMA	SO2GBII6	N320GB5.4KS
AS1810TZ-413G32i	PMDSU 4100B	NLED11.6WXGAG	UMA	SO2GBII6	N320GB5.4KS
AS1810TZ-413G32n	PMDSU 4100B	NLED11.6WXGAG	UMA	SO2GBII6	N320GB5.4KS
AS1810TZ-413G32n	PMDSU 4100B	NLED11.6WXGAG	UMA	SO2GBII6	N320GB5.4KS
AS1810TZ-413G32n	PMDSU 4100B	NLED11.6WXGAG	UMA	SO2GBII6	N320GB5.4KS
AS1810TZ-413G32n	PMDSU 4100B	NLED11.6WXGAG	UMA	SO2GBII6	N320GB5.4KS
AS1810TZ-413G32n	PMDSU 4100B	NLED11.6WXGAG	UMA	SO2GBII6	N320GB5.4KS
AS1810TZ-413G32n	PMDSU 4100B	NLED11.6WXGAG	UMA	SO2GBII6	N320GB5.4KS
AS1810TZ-413G32n	PMDSU 4100B	NLED11.6WXGAG	UMA	SO2GBII6	N320GB5.4KS
AS1810TZ-413G32n	PMDSU 4100B	NLED11.6WXGAG	UMA	SO2GBII6	N320GB5.4KS
AS1810TZ-413G32n	PMDSU 4100B	NLED11.6WXGAG	UMA	SO2GBII6	N320GB5.4KS
AS1810TZ-413G32n	PMDSU 4100B	NLED11.6WXGAG	UMA	SO2GBII6	N320GB5.4KS
AS1810TZ-413G32n	PMDSU 4100B	NLED11.6WXGAG	UMA	SO2GBII6	N320GB5.4KS
AS1810TZ-413G32n	PMDSU 4100B	NLED11.6WXGAG	UMA	SO2GBII6	N320GB5.4KS
AS1810TZ-413G32n	PMDSU 4100B	NLED11.6WXGAG	UMA	SO2GBII6	N320GB5.4KS
AS1810TZ-413G32n	PMDSU 4100B	NLED11.6WXGAG	UMA	SO2GBII6	N320GB5.4KS

Model	CPU	LCD	VGA Chip	Memory 1	HDD 1(GB)
AS1810TZ -413G32n	PMDSU 4100B	NLED11.6WXGAG	UMA	SO2GBII6	N320GB5.4KS
AS1810TZ -413G32n	PMDSU 4100B	NLED11.6WXGAG	UMA	SO2GBII6	N320GB5.4KS
AS1810TZ -413G32n	PMDSU 4100B	NLED11.6WXGAG	UMA	SO2GBII6	N320GB5.4KS
AS1810TZ -413G32n	PMDSU 4100B	NLED11.6WXGAG	UMA	SO2GBII6	N320GB5.4KS
AS1810TZ -413G32n	PMDSU 4100B	NLED11.6WXGAG	UMA	SO2GBII6	N320GB5.4KS
AS1810TZ -412G32n	PMDSU 4100B	NLED11.6WXGAG	UMA	SO2GBII6	N320GB5.4KS
AS1810TZ -412G32n	PMDSU 4100B	NLED11.6WXGAG	UMA	SO2GBII6	N320GB5.4KS
AS1810TZ -411G25n	PMDSU 4100B	NLED11.6WXGAG	UMA	SO1GBII6	N250GB5.4KS
AS1810TZ -411G25n	PMDSU 4100B	NLED11.6WXGAG	UMA	SO1GBII6	N250GB5.4KS
AS1810TZ -412G32n	PMDSU 4100B	NLED11.6WXGAG	UMA	SO2GBII6	N320GB5.4KS
AS1810TZ -412G32n	PMDSU 4100B	NLED11.6WXGAG	UMA	SO2GBII6	N320GB5.4KS
AS1810TZ -413G32n	PMDSU 4100B	NLED11.6WXGAG	UMA	SO2GBII6	N320GB5.4KS
AS1810TZ -413G32n	PMDSU 4100B	NLED11.6WXGAG	UMA	SO2GBII6	N320GB5.4KS
AS1810TZ -413G32n	PMDSU 4100B	NLED11.6WXGAG	UMA	SO2GBII6	N320GB5.4KS
AS1810TZ -413G32n	PMDSU 4100B	NLED11.6WXGAG	UMA	SO2GBII6	N320GB5.4KS
AS1810TZ -413G32n	PMDSU 4100B	NLED11.6WXGAG	UMA	SO2GBII6	N320GB5.4KS
AS1810TZ -413G32i	PMDSU 4100B	NLED11.6WXGAG	UMA	SO2GBII6	N320GB5.4KS
AS1810TZ -413G32n	PMDSU 4100B	NLED11.6WXGAG	UMA	SO2GBII6	N320GB5.4KS
AS1810TZ -413G32n	PMDSU 4100B	NLED11.6WXGAG	UMA	SO2GBII6	N320GB5.4KS
AS1810TZ -413G32n	PMDSU 4100B	NLED11.6WXGAG	UMA	SO2GBII6	N320GB5.4KS
AS1810TZ -413G32n	PMDSU 4100B	NLED11.6WXGAG	UMA	SO2GBII6	N320GB5.4KS
AS1810TZ -413G32n	PMDSU 4100B	NLED11.6WXGAG	UMA	SO2GBII6	N320GB5.4KS
AS1810TZ -413G32n	PMDSU 4100B	NLED11.6WXGAG	UMA	SO2GBII6	N320GB5.4KS
AS1810TZ -413G32n	PMDSU 4100B	NLED11.6WXGAG	UMA	SO2GBII6	N320GB5.4KS
AS1810TZ -413G32n	PMDSU 4100B	NLED11.6WXGAG	UMA	SO2GBII6	N320GB5.4KS
AS1810TZ -413G32n	PMDSU 4100B	NLED11.6WXGAG	UMA	SO2GBII6	N320GB5.4KS
AS1810TZ -413G32n	PMDSU 4100B	NLED11.6WXGAG	UMA	SO2GBII6	N320GB5.4KS

Model	CPU	LCD	VGA Chip	Memory 1	HDD 1(GB)
AS1810TZ -413G32n	PMDSU 4100B	NLED11.6WXGAG	UMA	SO2GBII6	N320GB5.4KS
AS1810TZ -413G32n	PMDSU 4100B	NLED11.6WXGAG	UMA	SO2GBII6	N320GB5.4KS
AS1810TZ -413G32n	PMDSU 4100B	NLED11.6WXGAG	UMA	SO2GBII6	N320GB5.4KS
AS1810TZ -413G32n	PMDSU 4100B	NLED11.6WXGAG	UMA	SO2GBII6	N320GB5.4KS
AS1810TZ -413G32n	PMDSU 4100B	NLED11.6WXGAG	UMA	SO2GBII6	N320GB5.4KS
AS1810TZ -413G32n	PMDSU 4100B	NLED11.6WXGAG	UMA	SO2GBII6	N320GB5.4KS
AS1810TZ -413G32n	PMDSU 4100B	NLED11.6WXGAG	UMA	SO2GBII6	N320GB5.4KS
AS1810TZ -412G25n	PMDSU 4100B	NLED11.6WXGAG	UMA	SO2GBII6	N250GB5.4KS
AS1810TZ -412G25n	PMDSU 4100B	NLED11.6WXGAG	UMA	SO2GBII6	N250GB5.4KS
AS1810TZ -412G32n	PMDSU 4100B	NLED11.6WXGAG	UMA	SO2GBII6	N320GB5.4KS
AS1810TZ -412G32n	PMDSU 4100B	NLED11.6WXGAG	UMA	SO2GBII6	N320GB5.4KS
AS1810TZ -413G32n	PMDSU 4100B	NLED11.6WXGAG	UMA	SO2GBII6	N320GB5.4KS
AS1810TZ -413G32n	PMDSU 4100B	NLED11.6WXGAG	UMA	SO2GBII6	N320GB5.4KS
AS1810TZ -413G32n	PMDSU 4100B	NLED11.6WXGAG	UMA	SO2GBII6	N320GB5.4KS
AS1810TZ -413G32n	PMDSU 4100B	NLED11.6WXGAG	UMA	SO2GBII6	N320GB5.4KS
AS1810TZ -413G32n	PMDSU 4100B	NLED11.6WXGAG	UMA	SO2GBII6	N320GB5.4KS
AS1810TZ -413G32n	PMDSU 4100B	NLED11.6WXGAG	UMA	SO2GBII6	N320GB5.4KS
AS1810TZ -413G32n	PMDSU 4100B	NLED11.6WXGAG	UMA	SO2GBII6	N320GB5.4KS
AS1810TZ -413G32n	PMDSU 4100B	NLED11.6WXGAG	UMA	SO2GBII6	N320GB5.4KS
AS1810TZ -413G32n	PMDSU 4100B	NLED11.6WXGAG	UMA	SO2GBII6	N320GB5.4KS
AS1810TZ -413G32n	PMDSU 4100B	NLED11.6WXGAG	UMA	SO2GBII6	N320GB5.4KS
AS1810TZ -413G32n	PMDSU 4100B	NLED11.6WXGAG	UMA	SO2GBII6	N320GB5.4KS
AS1810TZ -413G32n	PMDSU 4100B	NLED11.6WXGAG	UMA	SO2GBII6	N320GB5.4KS
AS1810TZ -413G32n	PMDSU 4100B	NLED11.6WXGAG	UMA	SO2GBII6	N320GB5.4KS
AS1810TZ -413G32n	PMDSU 4100B	NLED11.6WXGAG	UMA	SO2GBII6	N320GB5.4KS

Model	CPU	LCD	VGA Chip	Memory 1	HDD 1(GB)
AS1810TZ-413G32n	PMDSU 4100B	NLED11.6WXGAG	UMA	SO2GBII6	N320GB5.4KS
AS1810TZ-413G32n	PMDSU 4100B	NLED11.6WXGAG	UMA	SO2GBII6	N320GB5.4KS
AS1810TZ-413G32n	PMDSU 4100B	NLED11.6WXGAG	UMA	SO2GBII6	N320GB5.4KS
AS1810TZ-413G32n	PMDSU 4100B	NLED11.6WXGAG	UMA	SO2GBII6	N320GB5.4KS
AS1810TZ-413G32n	PMDSU 4100B	NLED11.6WXGAG	UMA	SO2GBII6	N320GB5.4KS
AS1810TZ-413G32n	PMDSU 4100B	NLED11.6WXGAG	UMA	SO2GBII6	N320GB5.4KS
AS1810TZ-413G32n	PMDSU 4100B	NLED11.6WXGAG	UMA	SO2GBII6	N320GB5.4KS
AS1810TZ-412G32n	PMDSU 4100B	NLED11.6WXGAG	UMA	SO2GBII6	N320GB5.4KS
AS1810TZ-412G32n	PMDSU 4100B	NLED11.6WXGAG	UMA	SO2GBII6	N320GB5.4KS
AS1810TZ-411G25n	PMDSU 4100B	NLED11.6WXGAG	UMA	SO1GBII6	N250GB5.4KS
AS1810TZ-412G25n	PMDSU 4100B	NLED11.6WXGAG	UMA	SO2GBII6	N250GB5.4KS
AS1810T-352G25n	C2SSU3 500B	NLED11.6WXGAG	UMA	SO1GBII6	N250GB5.4KS
AS1810T-352G25n	C2SSU3 500B	NLED11.6WXGAG	UMA	SO2GBII6	N250GB5.4KS
AS1810T-351G25n	C2SSU3 500B	NLED11.6WXGAG	UMA	SO1GBII6	N250GB5.4KS
AS1810T-351G25n	C2SSU3 500B	NLED11.6WXGAG	UMA	SO1GBII6	N250GB5.4KS
AS1810T-354G32n	C2SSU3 500B	NLED11.6WXGAG	UMA	SO2GBII6	N320GB5.4KS
AS1810T-354G32n	C2SSU3 500B	NLED11.6WXGAG	UMA	SO2GBII6	N320GB5.4KS
AS1810T-352G25n	C2SSU3 500B	NLED11.6WXGAG	UMA	SO2GBII6	N250GB5.4KS
AS1810T-352G25n	C2SSU3 500B	NLED11.6WXGAG	UMA	SO2GBII6	N250GB5.4KS
AS1810T-352G25n	C2SSU3 500B	NLED11.6WXGAG	UMA	SO2GBII6	N250GB5.4KS
AS1810T-352G25n	C2SSU3 500B	NLED11.6WXGAG	UMA	SO2GBII6	N250GB5.4KS
AS1810T-352G25n	C2SSU3 500B	NLED11.6WXGAG	UMA	SO2GBII6	N250GB5.4KS
AS1810T-352G25n	C2SSU3 500B	NLED11.6WXGAG	UMA	SO2GBII6	N250GB5.4KS
AS1810T-352G25n	C2SSU3 500B	NLED11.6WXGAG	UMA	SO2GBII6	N250GB5.4KS
AS1810T-352G25n	C2SSU3 500B	NLED11.6WXGAG	UMA	SO2GBII6	N250GB5.4KS
AS1810T-352G25n	C2SSU3 500B	NLED11.6WXGAG	UMA	SO2GBII6	N250GB5.4KS
AS1810T-352G25n	C2SSU3 500B	NLED11.6WXGAG	UMA	SO2GBII6	N250GB5.4KS
AS1810T-352G25n	C2SSU3 500B	NLED11.6WXGAG	UMA	SO2GBII6	N250GB5.4KS
AS1810T-352G25n	C2SSU3 500B	NLED11.6WXGAG	UMA	SO2GBII6	N250GB5.4KS

Model	CPU	LCD	VGA Chip	Memory 1	HDD 1(GB)
AS1810T-353G25n	C2SSU3 500B	NLED11.6WXGAG	UMA	SO2GBII6	N250GB5.4KS
AS1810T-353G25n	C2SSU3 500B	NLED11.6WXGAG	UMA	SO2GBII6	N250GB5.4KS
AS1810T-353G25n	C2SSU3 500B	NLED11.6WXGAG	UMA	SO2GBII6	N250GB5.4KS
AS1810T-353G25n	C2SSU3 500B	NLED11.6WXGAG	UMA	SO2GBII6	N250GB5.4KS
AS1810T-353G25n	C2SSU3 500B	NLED11.6WXGAG	UMA	SO2GBII6	N250GB5.4KS
AS1810T-353G25n	C2SSU3 500B	NLED11.6WXGAG	UMA	SO2GBII6	N250GB5.4KS
AS1810T-353G25n	C2SSU3 500B	NLED11.6WXGAG	UMA	SO2GBII6	N250GB5.4KS
AS1810T-353G25n	C2SSU3 500B	NLED11.6WXGAG	UMA	SO2GBII6	N250GB5.4KS
AS1810T-353G25n	C2SSU3 500B	NLED11.6WXGAG	UMA	SO2GBII6	N250GB5.4KS
AS1810T-353G25n	C2SSU3 500B	NLED11.6WXGAG	UMA	SO2GBII6	N250GB5.4KS
AS1810T-353G25n	C2SSU3 500B	NLED11.6WXGAG	UMA	SO2GBII6	N250GB5.4KS
AS1810T-353G25n	C2SSU3 500B	NLED11.6WXGAG	UMA	SO2GBII6	N250GB5.4KS
AS1810T-353G25n	C2SSU3 500B	NLED11.6WXGAG	UMA	SO2GBII6	N250GB5.4KS
AS1810T-353G25n	C2SSU3 500B	NLED11.6WXGAG	UMA	SO2GBII6	N250GB5.4KS
AS1810T-353G25n	C2SSU3 500B	NLED11.6WXGAG	UMA	SO2GBII6	N250GB5.4KS
AS1810T-353G25n	C2SSU3 500B	NLED11.6WXGAG	UMA	SO2GBII6	N250GB5.4KS
AS1810T-353G25n	C2SSU3 500B	NLED11.6WXGAG	UMA	SO2GBII6	N250GB5.4KS
AS1810T-353G25n	C2SSU3 500B	NLED11.6WXGAG	UMA	SO2GBII6	N250GB5.4KS
AS1810T-353G25n	C2SSU3 500B	NLED11.6WXGAG	UMA	SO2GBII6	N250GB5.4KS
AS1810T-353G25n	C2SSU3 500B	NLED11.6WXGAG	UMA	SO2GBII6	N250GB5.4KS
AS1810T-353G25i	C2SSU3 500B	NLED11.6WXGAG	UMA	SO2GBII6	N250GB5.4KS
AS1810T-353G25n	C2SSU3 500B	NLED11.6WXGAG	UMA	SO2GBII6	N250GB5.4KS
AS1810T-353G25n	C2SSU3 500B	NLED11.6WXGAG	UMA	SO2GBII6	N250GB5.4KS
AS1810T-353G25n	C2SSU3 500B	NLED11.6WXGAG	UMA	SO2GBII6	N250GB5.4KS
AS1810T-353G25n	C2SSU3 500B	NLED11.6WXGAG	UMA	SO2GBII6	N250GB5.4KS
AS1810T-353G25n	C2SSU3 500B	NLED11.6WXGAG	UMA	SO2GBII6	N250GB5.4KS
AS1810T-353G25n	C2SSU3 500B	NLED11.6WXGAG	UMA	SO2GBII6	N250GB5.4KS
AS1810T-353G25n	C2SSU3 500B	NLED11.6WXGAG	UMA	SO2GBII6	N250GB5.4KS
AS1810T-353G25n	C2SSU3 500B	NLED11.6WXGAG	UMA	SO2GBII6	N250GB5.4KS
AS1810T-353G25n	C2SSU3 500B	NLED11.6WXGAG	UMA	SO2GBII6	N250GB5.4KS
AS1810T-353G25n	C2SSU3 500B	NLED11.6WXGAG	UMA	SO2GBII6	N250GB5.4KS
AS1810T-352G25n	C2SSU3 500B	NLED11.6WXGAG	UMA	SO2GBII6	N250GB5.4KS

Model	CPU	LCD	VGA Chip	Memory 1	HDD 1(GB)
AS1810T-352G25n	C2SSU3 500B	NLED11.6WXGAG	UMA	SO2GBII6	N250GB5.4KS
AS1810T-354G25n	C2SSU3 500B	NLED11.6WXGAG	UMA	SO2GBII6	N250GB5.4KS
AS1810T-354G32n	C2SSU3 500B	NLED11.6WXGAG	UMA	SO2GBII6	N320GB5.4KS
AS1810T-354G32n	C2SSU3 500B	NLED11.6WXGAG	UMA	SO2GBII6	N320GB5.4KS
AS1810T-352G25n	C2SSU3 500B	NLED11.6WXGAG	UMA	SO2GBII6	N250GB5.4KS
AS1810T-352G25n	C2SSU3 500B	NLED11.6WXGAG	UMA	SO2GBII6	N250GB5.4KS
AS1810T-352G25n	C2SSU3 500B	NLED11.6WXGAG	UMA	SO2GBII6	N250GB5.4KS
AS1810T-352G25n	C2SSU3 500B	NLED11.6WXGAG	UMA	SO2GBII6	N250GB5.4KS
AS1810T-352G25n	C2SSU3 500B	NLED11.6WXGAG	UMA	SO2GBII6	N250GB5.4KS
AS1810T-352G25n	C2SSU3 500B	NLED11.6WXGAG	UMA	SO2GBII6	N250GB5.4KS
AS1810T-352G32n	C2SSU3 500B	NLED11.6WXGAG	UMA	SO2GBII6	N320GB5.4KS
AS1810T-352G25n	C2SSU3 500B	NLED11.6WXGAG	UMA	SO2GBII6	N250GB5.4KS
AS1810T-352G25n	C2SSU3 500B	NLED11.6WXGAG	UMA	SO2GBII6	N250GB5.4KS
AS1810T-352G32n	C2SSU3 500B	NLED11.6WXGAG	UMA	SO2GBII6	N320GB5.4KS
AS1810T-352G25n	C2SSU3 500B	NLED11.6WXGAG	UMA	SO2GBII6	N250GB5.4KS
AS1810T-352G25n	C2SSU3 500B	NLED11.6WXGAG	UMA	SO2GBII6	N250GB5.4KS
AS1810T-352G32n	C2SSU3 500B	NLED11.6WXGAG	UMA	SO2GBII6	N320GB5.4KS
AS1810T-352G32n	C2SSU3 500B	NLED11.6WXGAG	UMA	SO2GBII6	N320GB5.4KS
AS1810T-352G32n	C2SSU3 500B	NLED11.6WXGAG	UMA	SO2GBII6	N320GB5.4KS
AS1810T-352G32n	C2SSU3 500B	NLED11.6WXGAG	UMA	SO2GBII6	N320GB5.4KS
AS1810T-352G32n	C2SSU3 500B	NLED11.6WXGAG	UMA	SO2GBII6	N320GB5.4KS
AS1810T-354G32n	C2SSU3 500B	NLED11.6WXGAG	UMA	SO2GBII6	N320GB5.4KS
AS1810T-354G32n	C2SSU3 500B	NLED11.6WXGAG	UMA	SO2GBII6	N320GB5.4KS
AS1810T-352G25n	C2SSU3 500B	NLED11.6WXGAG	UMA	SO2GBII6	N250GB5.4KS
AS1810T-352G25n	C2SSU3 500B	NLED11.6WXGAG	UMA	SO2GBII6	N250GB5.4KS
AS1810T-352G25n	C2SSU3 500B	NLED11.6WXGAG	UMA	SO2GBII6	N250GB5.4KS
AS1810T-353G32n	C2SSU3 500B	NLED11.6WXGAG	UMA	SO2GBII6	N320GB5.4KS

Model	CPU	LCD	VGA Chip	Memory 1	HDD 1(GB)
AS1810T-352G25n	C2SSU3 500B	NLED11.6WXGAG	UMA	SO2GBII6	N250GB5.4KS
AS1810T-352G32n	C2SSU3 500B	NLED11.6WXGAG	UMA	SO2GBII6	N320GB5.4KS

Model	Extra SW1	Card Reader	Wireless LAN	Wireless LAN1	Blue tooth	Battery
AS1410-722G25n	McAfee	5 in 1-Build in	3rd WiFi 1x2 BGN	3rd WiFi 1x2 BGN	BT 2.1	6CELL2.2
AS1410-721G16n	McAfee	5 in 1-Build in	3rd WiFi 1x2 BGN	3rd WiFi 1x2 BGN	BT 2.1	6CELL2.2
AS1410-721G25n	McAfee	5 in 1-Build in	3rd WiFi 1x2 BGN	3rd WiFi 1x2 BGN	BT 2.1	6CELL2.2
AS1410-721G16n	McAfee	5 in 1-Build in	3rd WiFi 1x2 BGN	3rd WiFi 1x2 BGN	N	6CELL2.2
AS1410-721G16n	McAfee	5 in 1-Build in	3rd WiFi 1x2 BGN	3rd WiFi 1x2 BGN	N	6CELL2.2
AS1410-721G16n	McAfee	5 in 1-Build in	3rd WiFi 1x2 BGN	3rd WiFi 1x2 BGN	BT 2.1	6CELL2.2
AS1410-721G16n	McAfee	5 in 1-Build in	3rd WiFi 1x2 BGN	3rd WiFi 1x2 BGN	BT 2.1	6CELL2.2
AS1410-721G16n	McAfee	5 in 1-Build in	3rd WiFi 1x2 BGN	3rd WiFi 1x2 BGN	BT 2.1	6CELL2.2
AS1410-721G16n	McAfee	5 in 1-Build in	3rd WiFi 1x2 BGN	3rd WiFi 1x2 BGN	BT 2.1	6CELL2.2
AS1410-721G16n	McAfee	5 in 1-Build in	3rd WiFi 1x2 BGN	3rd WiFi 1x2 BGN	BT 2.1	6CELL2.2
AS1410-722G25n	McAfee	5 in 1-Build in	3rd WiFi 1x2 BGN	3rd WiFi 1x2 BGN	N	6CELL2.2
AS1410-722G25n	McAfee	5 in 1-Build in	3rd WiFi 1x2 BGN	3rd WiFi 1x2 BGN	N	6CELL2.2
AS1410-722G25n	McAfee	5 in 1-Build in	3rd WiFi 1x2 BGN	3rd WiFi 1x2 BGN	N	6CELL2.2
AS1410-722G25n	McAfee	5 in 1-Build in	3rd WiFi 1x2 BGN	3rd WiFi 1x2 BGN	N	6CELL2.2
AS1410-722G25n	McAfee	5 in 1-Build in	3rd WiFi 1x2 BGN	3rd WiFi 1x2 BGN	N	6CELL2.2
AS1410-722G25n	McAfee	5 in 1-Build in	3rd WiFi 1x2 BGN	3rd WiFi 1x2 BGN	N	6CELL2.2
AS1410-722G25n	McAfee	5 in 1-Build in	3rd WiFi 1x2 BGN	3rd WiFi 1x2 BGN	N	6CELL2.2
AS1410-722G25n	McAfee	5 in 1-Build in	3rd WiFi 1x2 BGN	3rd WiFi 1x2 BGN	N	6CELL2.2
AS1410-722G25n	McAfee	5 in 1-Build in	3rd WiFi 1x2 BGN	3rd WiFi 1x2 BGN	N	6CELL2.2
AS1410-722G25i	McAfee	5 in 1-Build in	3rd WiFi 1x2 BGN	3rd WiFi BG	N	6CELL2.2
AS1410-722G25n	McAfee	5 in 1-Build in	3rd WiFi 1x2 BGN	3rd WiFi 1x2 BGN	N	6CELL2.2
AS1410-722G25n	McAfee	5 in 1-Build in	3rd WiFi 1x2 BGN	3rd WiFi 1x2 BGN	N	6CELL2.2
AS1410-722G25n	McAfee	5 in 1-Build in	3rd WiFi 1x2 BGN	3rd WiFi 1x2 BGN	N	6CELL2.2

Model	Extra SW1	Card Reader	Wireless LAN	Wireless LAN1	Blue tooth	Battery
AS1410-722G25n	McAfee	5 in 1-Build in	3rd WiFi 1x2 BGN	3rd WiFi 1x2 BGN	N	6CELL2.2
AS1410-722G25n	McAfee	5 in 1-Build in	3rd WiFi 1x2 BGN	3rd WiFi 1x2 BGN	N	6CELL2.2
AS1410-722G25n	McAfee	5 in 1-Build in	3rd WiFi 1x2 BGN	3rd WiFi 1x2 BGN	N	6CELL2.2
AS1410-722G25n	McAfee	5 in 1-Build in	3rd WiFi 1x2 BGN	3rd WiFi 1x2 BGN	N	6CELL2.2
AS1410-722G25n	McAfee	5 in 1-Build in	3rd WiFi 1x2 BGN	3rd WiFi 1x2 BGN	N	6CELL2.2
AS1410-722G25n	McAfee	5 in 1-Build in	3rd WiFi 1x2 BGN	3rd WiFi 1x2 BGN	N	6CELL2.2
AS1410-722G25n	McAfee	5 in 1-Build in	3rd WiFi 1x2 BGN	3rd WiFi 1x2 BGN	N	6CELL2.2
AS1410-722G25n	McAfee	5 in 1-Build in	3rd WiFi 1x2 BGN	3rd WiFi 1x2 BGN	N	6CELL2.2
AS1410-722G25n	McAfee	5 in 1-Build in	3rd WiFi 1x2 BGN	3rd WiFi 1x2 BGN	N	6CELL2.2
AS1410-722G16n	McAfee	5 in 1-Build in	3rd WiFi 1x2 BGN	3rd WiFi 1x2 BGN	BT 2.1	6CELL2.2
AS1410-722G25n	McAfee	5 in 1-Build in	3rd WiFi 1x2 BGN	3rd WiFi 1x2 BGN	BT 2.1	6CELL2.2
AS1410-721G16i	McAfee	5 in 1-Build in	3rd WiFi BG	3rd WiFi BG	BT 2.1	6CELL2.2
AS1410-72_br2G25n	McAfee	5 in 1-Build in	3rd WiFi 1x2 BGN	3rd WiFi 1x2 BGN	N	6CELL2.8_BR
AS1410-721G16n	McAfee	5 in 1-Build in	3rd WiFi 1x2 BGN	3rd WiFi 1x2 BGN	BT 2.1	6CELL2.2
AS1410-722G25n	McAfee	5 in 1-Build in	3rd WiFi 1x2 BGN	3rd WiFi 1x2 BGN	BT 2.1	6CELL2.2
AS1410-721G25n	McAfee	5 in 1-Build in	3rd WiFi 1x2 BGN	3rd WiFi 1x2 BGN	BT 2.1	6CELL2.2
AS1410-721G25n	McAfee	5 in 1-Build in	3rd WiFi 1x2 BGN	3rd WiFi 1x2 BGN	BT 2.1	6CELL2.2
AS1410-722G25n	McAfee	5 in 1-Build in	3rd WiFi 1x2 BGN	3rd WiFi 1x2 BGN	BT 2.1	6CELL2.2
AS1410-721G16n	McAfee	5 in 1-Build in	3rd WiFi 1x2 BGN	3rd WiFi 1x2 BGN	BT 2.1	6CELL2.2
AS1410-723G25n	McAfee	5 in 1-Build in	3rd WiFi 1x2 BGN	3rd WiFi 1x2 BGN	N	6CELL2.2
AS1410-722G25n	McAfee	5 in 1-Build in	3rd WiFi 1x2 BGN	3rd WiFi 1x2 BGN	BT 2.1	6CELL2.2
AS1410-722G25n	McAfee	5 in 1-Build in	3rd WiFi 1x2 BGN	3rd WiFi 1x2 BGN	BT 2.1	6CELL2.2
AS1410-723G25n	McAfee	5 in 1-Build in	3rd WiFi 1x2 BGN	3rd WiFi 1x2 BGN	N	6CELL2.2

Model	Extra SW1	Card Reader	Wireless LAN	Wireless LAN1	Blue tooth	Battery
AS1410-722G25n	McAfee	5 in 1-Build in	3rd WiFi 1x2 BGN	3rd WiFi 1x2 BGN	N	6CELL2.2
AS1410-722G25n	McAfee	5 in 1-Build in	3rd WiFi 1x2 BGN	3rd WiFi 1x2 BGN	N	6CELL2.2
AS1410-722G25n	McAfee	5 in 1-Build in	3rd WiFi 1x2 BGN	3rd WiFi 1x2 BGN	N	6CELL2.2
AS1410-722G25n	McAfee	5 in 1-Build in	3rd WiFi 1x2 BGN	3rd WiFi 1x2 BGN	N	6CELL2.2
AS1410-722G25n	McAfee	5 in 1-Build in	3rd WiFi 1x2 BGN	3rd WiFi 1x2 BGN	N	6CELL2.2
AS1410-722G25n	McAfee	5 in 1-Build in	3rd WiFi 1x2 BGN	3rd WiFi 1x2 BGN	N	6CELL2.2
AS1410-722G25n	McAfee	5 in 1-Build in	3rd WiFi 1x2 BGN	3rd WiFi 1x2 BGN	N	6CELL2.2
AS1410-722G25n	McAfee	5 in 1-Build in	3rd WiFi 1x2 BGN	3rd WiFi 1x2 BGN	N	6CELL2.2
AS1410-722G25n	McAfee	5 in 1-Build in	3rd WiFi 1x2 BGN	3rd WiFi 1x2 BGN	N	6CELL2.2
AS1410-722G25n	McAfee	5 in 1-Build in	3rd WiFi 1x2 BGN	3rd WiFi 1x2 BGN	N	6CELL2.2
AS1410-722G25n	McAfee	5 in 1-Build in	3rd WiFi 1x2 BGN	3rd WiFi 1x2 BGN	N	6CELL2.2
AS1410-722G25n	McAfee	5 in 1-Build in	3rd WiFi 1x2 BGN	3rd WiFi 1x2 BGN	N	6CELL2.2
AS1410-722G25n	McAfee	5 in 1-Build in	3rd WiFi 1x2 BGN	3rd WiFi 1x2 BGN	N	6CELL2.2
AS1410-722G25n	McAfee	5 in 1-Build in	3rd WiFi 1x2 BGN	3rd WiFi 1x2 BGN	N	6CELL2.2
AS1410-722G25n	McAfee	5 in 1-Build in	3rd WiFi 1x2 BGN	3rd WiFi 1x2 BGN	N	6CELL2.2
AS1410-722G25n	McAfee	5 in 1-Build in	3rd WiFi 1x2 BGN	3rd WiFi 1x2 BGN	N	6CELL2.2
AS1410-722G25n	McAfee	5 in 1-Build in	3rd WiFi 1x2 BGN	3rd WiFi 1x2 BGN	N	6CELL2.2
AS1410-722G25n	McAfee	5 in 1-Build in	3rd WiFi 1x2 BGN	3rd WiFi 1x2 BGN	N	6CELL2.2
AS1410-722G25n	McAfee	5 in 1-Build in	3rd WiFi 1x2 BGN	3rd WiFi 1x2 BGN	N	6CELL2.2
AS1410-722G25n	McAfee	5 in 1-Build in	3rd WiFi 1x2 BGN	3rd WiFi 1x2 BGN	N	6CELL2.2
AS1410-722G25n	McAfee	5 in 1-Build in	3rd WiFi 1x2 BGN	3rd WiFi 1x2 BGN	N	6CELL2.2
AS1410-722G25n	McAfee	5 in 1-Build in	3rd WiFi 1x2 BGN	3rd WiFi 1x2 BGN	N	6CELL2.2
AS1410-722G25n	McAfee	5 in 1-Build in	3rd WiFi 1x2 BGN	3rd WiFi 1x2 BGN	N	6CELL2.2
AS1410-722G25n	McAfee	5 in 1-Build in	3rd WiFi 1x2 BGN	3rd WiFi 1x2 BGN	N	6CELL2.2
AS1410-722G25n	McAfee	5 in 1-Build in	3rd WiFi 1x2 BGN	3rd WiFi 1x2 BGN	BT 2.1	6CELL2.2
AS1410-722G25n	McAfee	5 in 1-Build in	3rd WiFi 1x2 BGN	3rd WiFi 1x2 BGN	BT 2.1	6CELL2.2
AS1410-722G16n	McAfee	5 in 1-Build in	3rd WiFi 1x2 BGN	3rd WiFi 1x2 BGN	BT 2.1	6CELL2.2

Model	Extra SW1	Card Reader	Wireless LAN	Wireless LAN1	Blue tooth	Battery
AS1810TZ-413G32n	McAfee	5 in 1-Build in	3rd WiFi 1x2 BGN	3rd WiFi 1x2 BGN	N	6CELL2.8
AS1810TZ-413G32n	McAfee	5 in 1-Build in	3rd WiFi 1x2 BGN	3rd WiFi 1x2 BGN	N	6CELL2.8
AS1810TZ-413G32n	McAfee	5 in 1-Build in	3rd WiFi 1x2 BGN	3rd WiFi 1x2 BGN	N	6CELL2.8
AS1810TZ-413G32n	McAfee	5 in 1-Build in	3rd WiFi 1x2 BGN	3rd WiFi 1x2 BGN	N	6CELL2.8
AS1810TZ-413G32n	McAfee	5 in 1-Build in	3rd WiFi 1x2 BGN	3rd WiFi 1x2 BGN	N	6CELL2.8
AS1810TZ-413G32n	McAfee	5 in 1-Build in	3rd WiFi 1x2 BGN	3rd WiFi 1x2 BGN	N	6CELL2.8
AS1810TZ-413G32n	McAfee	5 in 1-Build in	3rd WiFi 1x2 BGN	3rd WiFi 1x2 BGN	N	6CELL2.8
AS1810TZ-413G32n	McAfee	5 in 1-Build in	3rd WiFi 1x2 BGN	3rd WiFi 1x2 BGN	N	6CELL2.8
AS1810TZ-413G32n	McAfee	5 in 1-Build in	3rd WiFi 1x2 BGN	3rd WiFi 1x2 BGN	N	6CELL2.8
AS1810TZ-413G32n	McAfee	5 in 1-Build in	3rd WiFi 1x2 BGN	3rd WiFi 1x2 BGN	N	6CELL2.8
AS1810TZ-413G32n	McAfee	5 in 1-Build in	3rd WiFi 1x2 BGN	3rd WiFi 1x2 BGN	N	6CELL2.8
AS1810TZ-413G32n	McAfee	5 in 1-Build in	3rd WiFi 1x2 BGN	3rd WiFi 1x2 BGN	N	6CELL2.8
AS1810TZ-413G32n	McAfee	5 in 1-Build in	3rd WiFi 1x2 BGN	3rd WiFi 1x2 BGN	N	6CELL2.8
AS1810TZ-413G32n	McAfee	5 in 1-Build in	3rd WiFi 1x2 BGN	3rd WiFi 1x2 BGN	N	6CELL2.8
AS1810TZ-412G32n	McAfee	5 in 1-Build in	3rd WiFi 1x2 BGN	3rd WiFi 1x2 BGN	BT 2.1	6CELL2.8
AS1810TZ-412G32n	McAfee	5 in 1-Build in	3rd WiFi 1x2 BGN	3rd WiFi 1x2 BGN	BT 2.1	6CELL2.8
AS1810TZ-411G25n	McAfee	5 in 1-Build in	SP1x2HMW	SP1x2HMW	BT 2.1	6CELL2.8
AS1810TZ-412G25n	McAfee	5 in 1-Build in	SP1x2HMW	SP1x2HMW	BT 2.1	6CELL2.8
AS1810T-352G25n	McAfee	5 in 1-Build in	SP1x2HMW	SP1x2HMW	BT 2.1	6CELL2.8
AS1810T-352G25n	McAfee	5 in 1-Build in	SP1x2HMW	SP1x2HMW	BT 2.1	6CELL2.8
AS1810T-351G25n	McAfee	5 in 1-Build in	SP1x2HMW	SP1x2HMW	BT 2.1	6CELL2.8
AS1810T-351G25n	McAfee	5 in 1-Build in	SP1x2HMW	SP1x2HMW	BT 2.1	6CELL2.8
AS1810T-354G32n	McAfee	5 in 1-Build in	SP1x2HMW	SP1x2HMW	BT 2.1	6CELL2.8
AS1810T-354G32n	McAfee	5 in 1-Build in	SP1x2HMW	SP1x2HMW	BT 2.1	6CELL2.8

Model	Extra SW1	Card Reader	Wireless LAN	Wireless LAN1	Blue tooth	Battery
AS1810T-352G25n	McAfee	5 in 1-Build in	SP1x2HMW	SP1x2HMW	BT 2.1	6CELL2.8
AS1810T-352G32n	McAfee	5 in 1-Build in	SP1x2HMW	SP1x2HMW	BT 2.1	6CELL2.8
AS1810T-352G32n	McAfee	5 in 1-Build in	SP1x2HMW	SP1x2HMW	BT 2.1	6CELL2.8
AS1810T-352G32n	McAfee	5 in 1-Build in	SP1x2HMW	SP1x2HMW	BT 2.1	6CELL2.8
AS1810T-352G32n	McAfee	5 in 1-Build in	SP1x2HMW	SP1x2HMW	BT 2.1	6CELL2.8
AS1810T-354G32n	McAfee	5 in 1-Build in	SP1x2HMW	SP1x2HMW	BT 2.1	6CELL2.8
AS1810T-354G32n	McAfee	5 in 1-Build in	SP1x2HMW	SP1x2HMW	BT 2.1	6CELL2.8
AS1810T-352G25n	McAfee	5 in 1-Build in	SP1x2HMW	SP1x2HMW	BT 2.1	6CELL2.8
AS1810T-352G25n	McAfee	5 in 1-Build in	SP1x2HMW	SP1x2HMW	BT 2.1	6CELL2.8
AS1810T-352G25n	McAfee	5 in 1-Build in	SP1x2HMW	SP1x2HMW	BT 2.1	6CELL2.8
AS1810T-353G32n	McAfee	5 in 1-Build in	SP1x2HMW	SP1x2HMW	N	6CELL2.8
AS1810T-352G25n	McAfee	5 in 1-Build in	SP1x2HMW	SP1x2HMW	BT 2.1	6CELL2.8
AS1810T-352G32n	McAfee	5 in 1-Build in	SP1x2HMW	SP1x2HMW	BT 2.1	6CELL2.8

Aspire One 752

Model	RO	Country	Acer Part No	Description
AO752-72Db	WW	WW	S2.SB80D.001	AO752-72Db SNW7ST32SWW1 MC UMACbb 1*1G/160/3L2.2/5R/ CBSD_bgn_0.3D_BAG_GEb_ES61
AO752-72DGb	WW	WW	S2.SBE0D.001	AO752-72DGb SNW7ST32SWW1 MC UMAGCbb 1*1G/160/3L2.2/5R/ CBSD_bgn_0.3D_380_GEb_ES61
AO752-72DGk	WW	WW	S2.SBF0D.001	AO752-72DGk SNW7ST32SWW1 MC UMAGCkk 1*1G/160/3L2.2/5R/ CB_bgn_0.3D_380_GEk_ES61
AO752-72DGr	WW	WW	S2.SBG0D.001	AO752-72DGr SNW7ST32SWW1 MC UMAGCrr 1*1G/160/3L2.2/5R/ CB_bgn_0.3D_380_GEr_ES61
AO752-72DGw	WW	WW	S2.SBH0D.001	AO752-72DGw SNW7ST32SWW1 MC UMAGCws 1*1G/160/3L2.2/5R/ CB_bgn_0.3D_380_GEw_ES61
AO752-72Dk	WW	WW	S2.SB70D.001	AO752-72Dk SNW7ST32SWW1 MC UMACkk 1*1G/160/3L2.2/5R/ CBSD_bgn_0.3D_GEk_ES61
AO752-72Dr	WW	WW	S2.SB90D.001	AO752-72Dr SNW7ST32SWW1 MC UMACrr 1*1G/160/3L2.2/5R/ CBSD_bgn_0.3D_GEr_ES61
AO752-72Dw	WW	WW	S2.SBA0D.001	AO752-72Dw SNW7ST32SWW1 MC UMACws 1*1G/160/3L2.2/5R/ CB_bgn_0.3D_GEw_ES61
AO752-741b	CHIN A	China	LU.SB801.001	AO752-741b W7HB32SCSTCN1 MC UMACbb 1*2G/320/BT/3L2.2/5R/ CB_bgn_0.3D_BAG_GEb_SC11
AO752-741k	CHIN A	China	LU.SB701.001	AO752-741k W7HB32SCSTCN1 MC UMACkk 1*2G/250/BT/3L2.2/5R/ CB_bgn_0.3D_BAG_GEk_SC11
AO752-741rr	EMEA	Middle East	LU.SB901.003	AO752-741rr EM W7HB64EMSSME2 MC UMACrr 1*2G/160/6L2.2/5R/ CB_bgn_0.3D_BAG_GEr_ARA1
AO752-742b	TWN	GCTWN	LU.SB802.051	AO752-742b W7HP64STTW1 MC UMACbb 1*2G/250/BT/6L2.2/5R/ CB_bgn_0.3D_BAG_GEb_TC11
AO752-742bb	AAP	Australia/ New Zealand	LU.SB802.126	AO752-742bb W7HP64SSAU1 MC UMACbb 1*2G/250/BT/6L2.8/5R/ CB_bgn_0.3D_BAG_GEb_ES61
AO752-742bb	EMEA	Denmark	LU.SB802.125	AO752-742bb W7HP64SSDK2 MC UMACbb 1*2G/320/6L2.2/5R/ CB_bgn_0.3D_GEb_ENS1
AO752-742bb	TWN	GCTWN	LU.SB802.127	AO752-742bb W7HP64SSTW1 MC UMACbb 1*2G/250/BT/6L2.2/5R/ CB_bgn_0.3D_BAG_GEb_TC11
AO752-742r	TWN	GCTWN	LU.SB902.047	AO752-742r W7HP64STTW1 MC UMACrr 1*2G/250/BT/6L2.2/5R/ CB_bgn_0.3D_BAG_GEr_TC11
AO752-742rr	EMEA	Austria	LU.SB902.167	AO752-742rr W7HP64SSAT1 MC UMACrr 1*2G/250/6L2.2/5R/ CB_bgn_0.3D_GEr_DE61

Model	RO	Country	Acer Part No	Description
AO752-742rr	EMEA	Denmark	LU.SB902.166	AO752-742rr W7HP64SSDK2 MC UMACrr 1*2G/320/6L2.2/5R/ CB_bgn_0.3D_GEr_ENS1
AO752-742rr	TWN	GCTWN	LU.SB902.168	AO752-742rr W7HP64SSTW1 MC UMACrr 1*2G/250/BT/6L2.2/5R/ CB_bgn_0.3D_BAG_GEr_TC11
AO752-742w	TWN	GCTWN	LU.SBA02.047	AO752-742w W7HP64STTW1 MC UMACws 1*2G/250/BT/6L2.2/5R/ CB_bgn_0.3D_BAG_GEw_TC11
AO752-742ws	EMEA	Denmark	LU.SBA02.169	AO752-742ws W7HP64SSDK2 MC UMACws 1*2G/250/6L2.2/5R/ CBSD_bgn_0.3D_GEw_ENS1
AO752-742ws	EMEA	Denmark	LU.SBA02.170	AO752-742ws W7HP64SSDK2 MC UMACws 1*2G/320/6L2.2/5R/ CB_bgn_0.3D_GEw_ENS1
AO752-748bb	EMEA	Middle East	LU.SB808.031	AO752-748bb EM W7ST32EMSSME6 MC UMACbb 1*1G/160/BT/6L2.2/5R/ CB_bgn_0.3D_BAG_GEb_ES61
AO752-748bb	EMEA	Russia	LU.SB808.029	AO752-748bb W7ST32RUSSRU1 MC UMACbb 1*2G/250/6L2.2/5R/ CBSD_bg_0.3D_GEb_RU62
AO752-748bb	EMEA	Russia	LU.SB808.030	AO752-748bb W7ST32RUSSRU1 MC UMACbb 1*2G/250/BT/6L2.2/5R/ CB_bg_0.3D_BAG_GEb_RU62
AO752-748rr	EMEA	Middle East	LU.SB908.020	AO752-748rr EM W7ST32EMSSME2 MC UMACrr 1*1G/160/6L2.2/5R/ CB_bgn_0.3D_BAG_GEr_ARA1
AO752-748rr	EMEA	Middle East	LU.SB908.022	AO752-748rr EM W7ST32EMSSME6 MC UMACrr 1*1G/160/BT/6L2.2/5R/ CB_bgn_0.3D_BAG_GEr_ES61
AO752-748rr	EMEA	Russia	LU.SB908.018	AO752-748rr W7ST32RUSSRU1 MC UMACrr 1*2G/250/6L2.2/5R/ CBSD_bg_0.3D_GEr_RU62
AO752-748rr	EMEA	Russia	LU.SB908.019	AO752-748rr W7ST32RUSSRU1 MC UMACrr 1*1G/160/3L2.2/5R/ CB_bg_0.3D_GEr_RU62
AO752-748rr	EMEA	Russia	LU.SB908.021	AO752-748rr W7ST32RUSSRU1 MC UMACrr 1*2G/250/BT/6L2.2/5R/ CB_bg_0.3D_GEr_RU62
AO752-748ws	EMEA	Middle East	LU.SBA08.007	AO752-748ws EM W7ST32EMSSME6 MC UMACws 1*1G/160/BT/6L2.2/5R/ CB_bgn_0.3D_BAG_GEw_ES61
AO752-748ws	EMEA	Russia	LU.SBA08.005	AO752-748ws W7ST32RUSSRU1 MC UMACws 1*2G/250/6L2.2/5R/ CBSD_bg_0.3D_GEw_RU62
AO752-748ws	EMEA	Russia	LU.SBA08.006	AO752-748ws W7ST32RUSSRU1 MC UMACws 1*2G/250/BT/6L2.2/5R/ CB_bg_0.3D_GEw_RU62
AO752-74Cb	EMEA	Eastern Europe	LU.SB80C.003	AO752-74Cb LINPUSSEU5 UMACbb 1*2G/320/3L2.2/5R/ CB_bgn_0.3D_BAG_GEb_ENF1

Model	RO	Country	Acer Part No	Description
AO752-74Cbb	AAP	India	LU.SB80C.004	AO752-74Cbb LINPUSSIN1 UMACbb 1*2G/250/BT/6L2.2/5R/ CB_bgn_0.3D_BAG_GEb_ES61
AO752-74Cbb	AAP	India	LU.SB80C.005	AO752-74Cbb LINPUSSIN2 UMACbb 1*2G/320/BT/6L2.2/5R/ CB_bgn_0.3D_BAG_GEb_ES61
AO752-74Ck	CHIN A	China	LU.SB70C.008	AO752-74Ck LINPUSSCN1 UMACKk 1*1G/250/BT/3L2.2/5R/ CBSD_bgn_0.3D_BAG_GEk_TC21
AO752-74Ck	AAP	India	LU.SB70C.009	AO752-74Ck LINPUSSIN1 UMACKk 1*1G/160/BT/6L2.2/5R/ CB_bgn_0.3D_BAG_GEk_ES61
AO752-74Ckk	AAP	India	LU.SB70C.010	AO752-74Ckk LINPUSSIN1 UMACKk 1*2G/250/BT/6L2.2/5R/ CB_bgn_0.3D_BAG_GEk_ES61
AO752-74Ckk	AAP	India	LU.SB70C.017	AO752-74Ckk LINPUSSIN2 UMACKk 1*2G/320/BT/6L2.2/5R/ CB_bgn_0.3D_BAG_GEk_ES61
AO752-74Cr	CHIN A	China	LU.SB90C.002	AO752-74Cr LINPUSSCN1 UMACrr 1*2G/160/3L2.2/5R/ CB_bgn_0.3D_BAG_GEr_TC21
AO752-74Cr	AAP	India	LU.SB90C.003	AO752-74Cr LINPUSSIN1 UMACrr 1*1G/160/BT/6L2.2/5R/ CB_bgn_0.3D_BAG_GEr_ES61
AO752-74Crr	EMEA	Baltic	LU.SB90C.004	AO752-74Crr LINPUSSBC4 UMACrr 1*2G/250/6L2.2/5R/ CB_bgn_0.3D_GEr_LT21
AO752-74Crr	EMEA	Baltic	LU.SB90C.005	AO752-74Crr LINPUSSBC4 UMACrr 2G+1G/320/6L2.2/5R/ CB_bgn_0.3D_GEr_LT21
AO752-74Crr	AAP	India	LU.SB90C.006	AO752-74Crr LINPUSSIN1 UMACrr 1*2G/250/BT/6L2.2/5R/ CB_bgn_0.3D_BAG_GEr_ES61
AO752-74Cw	CHIN A	China	LU.SBA0C.003	AO752-74Cw LINPUSSCN1 UMACws 1*1G/250/BT/3L2.2/5R/ CBSD_bgn_0.3D_BAG_GEw_TC21
AO752-74Cw	CHIN A	China	LU.SBA0C.004	AO752-74Cw LINPUSSCN1 UMACws 1*1G/160/3L2.2/5R/ CBSD_bgn_0.3D_BAG_GEw_TC21
AO752-74Cw	EMEA	Eastern Europe	LU.SBA0C.002	AO752-74Cw LINPUSSEU5 UMACws 1*2G/320/6L2.2/5R/ CB_bgn_0.3D_GEw_ENF1
AO752-74Cw	AAP	India	LU.SBA0C.006	AO752-74Cw LINPUSSIN1 UMACws 1*1G/160/BT/6L2.2/5R/ CB_bgn_0.3D_BAG_GEw_ES61
AO752-74Cw	EMEA	Russia	LU.SBA0C.005	AO752-74Cw LINPUSSRU1 UMACws 1*2G/160/BT/6L2.2/5R/ CBSD_bg_0.3D_GEw_EN71
AO752-74Cws	EMEA	Denmark	LU.SBA0C.007	AO752-74Cws LINPUSSDK2 UMACws 1*2G/250/6L2.2/5R/ CB_bgn_0.3D_GEw_ES61

Model	RO	Country	Acer Part No	Description
AO752-74Cws	AAP	India	LU.SBA0C.008	AO752-74Cws LINPUSSIN1 UMACws 1*2G/250/BT/6L2.2/5R/ CB_bgn_0.3D_BAG_GEW_ES61
AO752-74Cws	AAP	India	LU.SBA0C.009	AO752-74Cws LINPUSSIN2 UMACws 1*2G/320/BT/6L2.2/5R/ CB_bgn_0.3D_BAG_GEW_ES61

Model	Country	Acer Part No	BOM Name	CPU
AO752-72Db	WW	S2.SB80D.001	AO752_UMACbb	CM723B
AO752-72DGb	WW	S2.SBE0D.001	AO752_UMAGCbb	CM723B
AO752-72DGk	WW	S2.SBF0D.001	AO752_UMAGCkk	CM723B
AO752-72DGr	WW	S2.SBG0D.001	AO752_UMAGCrr	CM723B
AO752-72DGw	WW	S2.SBH0D.001	AO752_UMAGCws	CM723B
AO752-72Dk	WW	S2.SB70D.001	AO752_UMACkk	CM723B
AO752-72Dr	WW	S2.SB90D.001	AO752_UMACrr	CM723B
AO752-72Dw	WW	S2.SBA0D.001	AO752_UMACws	CM723B
AO752-741b	China	LU.SB801.001	AO752_UMACbb	CM743B
AO752-741k	China	LU.SB701.001	AO752_UMACkk	CM743B
AO752-741rr	Middle East	LU.SB901.003	AO752_UMACrr	CM743B
AO752-742b	GCTWN	LU.SB802.051	AO752_UMACbb	CM743B
AO752-742bb	Australia/New Zealand	LU.SB802.126	AO752_UMACbb	CM743B
AO752-742bb	Denmark	LU.SB802.125	AO752_UMACbb	CM743B
AO752-742bb	GCTWN	LU.SB802.127	AO752_UMACbb	CM743B
AO752-742r	GCTWN	LU.SB902.047	AO752_UMACrr	CM743B
AO752-742rr	Austria	LU.SB902.167	AO752_UMACrr	CM743B
AO752-742rr	Denmark	LU.SB902.166	AO752_UMACrr	CM743B
AO752-742rr	GCTWN	LU.SB902.168	AO752_UMACrr	CM743B
AO752-742w	GCTWN	LU.SBA02.047	AO752_UMACws	CM743B
AO752-742ws	Denmark	LU.SBA02.169	AO752_UMACws	CM743B
AO752-742ws	Denmark	LU.SBA02.170	AO752_UMACws	CM743B
AO752-748bb	Middle East	LU.SB808.031	AO752_UMACbb	CM743B
AO752-748bb	Russia	LU.SB808.029	AO752_UMACbb	CM743B
AO752-748bb	Russia	LU.SB808.030	AO752_UMACbb	CM743B
AO752-748rr	Middle East	LU.SB908.020	AO752_UMACrr	CM743B
AO752-748rr	Middle East	LU.SB908.022	AO752_UMACrr	CM743B
AO752-748rr	Russia	LU.SB908.018	AO752_UMACrr	CM743B
AO752-748rr	Russia	LU.SB908.019	AO752_UMACrr	CM743B
AO752-748rr	Russia	LU.SB908.021	AO752_UMACrr	CM743B
AO752-748ws	Middle East	LU.SBA08.007	AO752_UMACws	CM743B
AO752-748ws	Russia	LU.SBA08.005	AO752_UMACws	CM743B
AO752-748ws	Russia	LU.SBA08.006	AO752_UMACws	CM743B
AO752-74Cb	Eastern Europe	LU.SB80C.003	AO752_UMACbb	CM743B
AO752-74Cbb	India	LU.SB80C.004	AO752_UMACbb	CM743B
AO752-74Cbb	India	LU.SB80C.005	AO752_UMACbb	CM743B

Model	Country	Acer Part No	BOM Name	CPU
AO752-74Ck	China	LU.SB70C.008	AO752_UMACKk	CM743B
AO752-74Ck	India	LU.SB70C.009	AO752_UMACKk	CM743B
AO752-74Ckk	India	LU.SB70C.010	AO752_UMACKk	CM743B
AO752-74Ckk	India	LU.SB70C.017	AO752_UMACKk	CM743B
AO752-74Cr	China	LU.SB90C.002	AO752_UMACrr	CM743B
AO752-74Cr	India	LU.SB90C.003	AO752_UMACrr	CM743B
AO752-74Crr	Baltic	LU.SB90C.004	AO752_UMACrr	CM743B
AO752-74Crr	Baltic	LU.SB90C.005	AO752_UMACrr	CM743B
AO752-74Crr	India	LU.SB90C.006	AO752_UMACrr	CM743B
AO752-74Cw	China	LU.SBA0C.003	AO752_UMACws	CM743B
AO752-74Cw	China	LU.SBA0C.004	AO752_UMACws	CM743B
AO752-74Cw	Eastern Europe	LU.SBA0C.002	AO752_UMACws	CM743B
AO752-74Cw	India	LU.SBA0C.006	AO752_UMACws	CM743B
AO752-74Cw	Russia	LU.SBA0C.005	AO752_UMACws	CM743B
AO752-74Cws	Denmark	LU.SBA0C.007	AO752_UMACws	CM743B
AO752-74Cws	India	LU.SBA0C.008	AO752_UMACws	CM743B
AO752-74Cws	India	LU.SBA0C.009	AO752_UMACws	CM743B

Model	Country	Acer Part No	LCD	Memory 1
AO752-72Db	WW	S2.SB80D.001	NLED11.6WSVGAG	SO1GBII6
AO752-72DGb	WW	S2.SBE0D.001	NLED11.6WSVGAG	SO1GBII6
AO752-72DGk	WW	S2.SBF0D.001	NLED11.6WXGAG	SO1GBII6
AO752-72DGGr	WW	S2.SBG0D.001	NLED11.6WXGAG	SO1GBII6
AO752-72DGw	WW	S2.SBH0D.001	NLED11.6WXGAG	SO1GBII6
AO752-72Dk	WW	S2.SB70D.001	NLED11.6WSVGAG	SO1GBII6
AO752-72Dr	WW	S2.SB90D.001	NLED11.6WSVGAG	SO1GBII6
AO752-72Dw	WW	S2.SBA0D.001	NLED11.6WXGAG	SO1GBII6
AO752-741b	China	LU.SB801.001	NLED11.6WXGAG	SO2GBII6
AO752-741k	China	LU.SB701.001	NLED11.6WXGAG	SO2GBII6
AO752-741rr	Middle East	LU.SB901.003	NLED11.6WXGAG	SO2GBII6
AO752-742b	GCTWN	LU.SB802.051	NLED11.6WXGAG	SO2GBII6
AO752-742bb	Australia/New Zealand	LU.SB802.126	NLED11.6WXGAG	SO2GBII6
AO752-742bb	Denmark	LU.SB802.125	NLED11.6WXGAG	SO2GBII6
AO752-742bb	GCTWN	LU.SB802.127	NLED11.6WXGAG	SO2GBII6
AO752-742r	GCTWN	LU.SB902.047	NLED11.6WXGAG	SO2GBII6
AO752-742rr	Austria	LU.SB902.167	NLED11.6WXGAG	SO2GBII6
AO752-742rr	Denmark	LU.SB902.166	NLED11.6WXGAG	SO2GBII6
AO752-742rr	GCTWN	LU.SB902.168	NLED11.6WXGAG	SO2GBII6
AO752-742w	GCTWN	LU.SBA02.047	NLED11.6WXGAG	SO2GBII6
AO752-742ws	Denmark	LU.SBA02.169	NLED11.6WSVGAG	SO2GBII6
AO752-742ws	Denmark	LU.SBA02.170	NLED11.6WXGAG	SO2GBII6
AO752-748bb	Middle East	LU.SB808.031	NLED11.6WXGAG	SO1GBII6
AO752-748bb	Russia	LU.SB808.029	NLED11.6WSVGAG	SO2GBII6

Model	Country	Acer Part No	LCD	Memory 1
AO752-748bb	Russia	LU.SB808.030	NLED11.6WXGAG	SO2GBII6
AO752-748rr	Middle East	LU.SB908.020	NLED11.6WXGAG	SO1GBII6
AO752-748rr	Middle East	LU.SB908.022	NLED11.6WXGAG	SO1GBII6
AO752-748rr	Russia	LU.SB908.018	NLED11.6WSVGAG	SO2GBII6
AO752-748rr	Russia	LU.SB908.019	NLED11.6WXGAG	SO1GBII6
AO752-748rr	Russia	LU.SB908.021	NLED11.6WXGAG	SO2GBII6
AO752-748ws	Middle East	LU.SBA08.007	NLED11.6WXGAG	SO1GBII6
AO752-748ws	Russia	LU.SBA08.005	NLED11.6WSVGAG	SO2GBII6
AO752-748ws	Russia	LU.SBA08.006	NLED11.6WXGAG	SO2GBII6
AO752-74Cb	Eastern Europe	LU.SB80C.003	NLED11.6WXGAG	SO2GBII6
AO752-74Cbb	India	LU.SB80C.004	NLED11.6WXGAG	SO2GBII6
AO752-74Cbb	India	LU.SB80C.005	NLED11.6WXGAG	SO2GBII6
AO752-74Ck	China	LU.SB70C.008	NLED11.6WSVGAG	SO1GBII6
AO752-74Ck	India	LU.SB70C.009	NLED11.6WXGAG	SO1GBII6
AO752-74Ckk	India	LU.SB70C.010	NLED11.6WXGAG	SO2GBII6
AO752-74Ckk	India	LU.SB70C.017	NLED11.6WXGAG	SO2GBII6
AO752-74Cr	China	LU.SB90C.002	NLED11.6WXGAG	SO2GBII6
AO752-74Cr	India	LU.SB90C.003	NLED11.6WXGAG	SO1GBII6
AO752-74Crr	Baltic	LU.SB90C.004	NLED11.6WXGAG	SO2GBII6
AO752-74Crr	Baltic	LU.SB90C.005	NLED11.6WXGAG	SO2GBII6
AO752-74Crr	India	LU.SB90C.006	NLED11.6WXGAG	SO2GBII6
AO752-74Cw	China	LU.SBA0C.003	NLED11.6WSVGAG	SO1GBII6
AO752-74Cw	China	LU.SBA0C.004	NLED11.6WSVGAG	SO1GBII6
AO752-74Cw	Eastern Europe	LU.SBA0C.002	NLED11.6WXGAG	SO2GBII6
AO752-74Cw	India	LU.SBA0C.006	NLED11.6WXGAG	SO1GBII6
AO752-74Cw	Russia	LU.SBA0C.005	NLED11.6WSVGAG	SO2GBII6
AO752-74Cws	Denmark	LU.SBA0C.007	NLED11.6WXGAG	SO2GBII6
AO752-74Cws	India	LU.SBA0C.008	NLED11.6WXGAG	SO2GBII6
AO752-74Cws	India	LU.SBA0C.009	NLED11.6WXGAG	SO2GBII6

Model	Country	Acer Part No	Memory 2	HDD 1(GB)
AO752-72Db	WW	S2.SB80D.001	N	N160GB5.4KS
AO752-72DGb	WW	S2.SBE0D.001	N	N160GB5.4KS
AO752-72DGk	WW	S2.SBF0D.001	N	N160GB5.4KS
AO752-72DGr	WW	S2.SBG0D.001	N	N160GB5.4KS
AO752-72DGw	WW	S2.SBH0D.001	N	N160GB5.4KS
AO752-72Dk	WW	S2.SB70D.001	N	N160GB5.4KS
AO752-72Dr	WW	S2.SB90D.001	N	N160GB5.4KS
AO752-72Dw	WW	S2.SBA0D.001	N	N160GB5.4KS
AO752-741b	China	LU.SB801.001	N	N320GB5.4KS
AO752-741k	China	LU.SB701.001	N	N250GB5.4KS
AO752-741rr	Middle East	LU.SB901.003	N	N160GB5.4KS
AO752-742b	GCTWN	LU.SB802.051	N	N250GB5.4KS

Model	Country	Acer Part No	Memory 2	HDD 1(GB)
AO752-742bb	Australia/New Zealand	LU.SB802.126	N	N250GB5.4KS
AO752-742bb	Denmark	LU.SB802.125	N	N320GB5.4KS
AO752-742bb	GCTWN	LU.SB802.127	N	N250GB5.4KS
AO752-742r	GCTWN	LU.SB902.047	N	N250GB5.4KS
AO752-742rr	Austria	LU.SB902.167	N	N250GB5.4KS
AO752-742rr	Denmark	LU.SB902.166	N	N320GB5.4KS
AO752-742rr	GCTWN	LU.SB902.168	N	N250GB5.4KS
AO752-742w	GCTWN	LU.SBA02.047	N	N250GB5.4KS
AO752-742ws	Denmark	LU.SBA02.169	N	N250GB5.4KS
AO752-742ws	Denmark	LU.SBA02.170	N	N320GB5.4KS
AO752-748bb	Middle East	LU.SB808.031	N	N160GB5.4KS
AO752-748bb	Russia	LU.SB808.029	N	N250GB5.4KS
AO752-748bb	Russia	LU.SB808.030	N	N250GB5.4KS
AO752-748rr	Middle East	LU.SB908.020	N	N160GB5.4KS
AO752-748rr	Middle East	LU.SB908.022	N	N160GB5.4KS
AO752-748rr	Russia	LU.SB908.018	N	N250GB5.4KS
AO752-748rr	Russia	LU.SB908.019	N	N160GB5.4KS
AO752-748rr	Russia	LU.SB908.021	N	N250GB5.4KS
AO752-748ws	Middle East	LU.SBA08.007	N	N160GB5.4KS
AO752-748ws	Russia	LU.SBA08.005	N	N250GB5.4KS
AO752-748ws	Russia	LU.SBA08.006	N	N250GB5.4KS
AO752-74Cb	Eastern Europe	LU.SB80C.003	N	N320GB5.4KS
AO752-74Cbb	India	LU.SB80C.004	N	N250GB5.4KS
AO752-74Cbb	India	LU.SB80C.005	N	N320GB5.4KS
AO752-74Ck	China	LU.SB70C.008	N	N250GB5.4KS
AO752-74Ck	India	LU.SB70C.009	N	N160GB5.4KS
AO752-74Ckk	India	LU.SB70C.010	N	N250GB5.4KS
AO752-74Ckk	India	LU.SB70C.017	N	N320GB5.4KS
AO752-74Cr	China	LU.SB90C.002	N	N160GB5.4KS
AO752-74Cr	India	LU.SB90C.003	N	N160GB5.4KS
AO752-74Crr	Baltic	LU.SB90C.004	N	N250GB5.4KS
AO752-74Crr	Baltic	LU.SB90C.005	SO1GBII6	N320GB5.4KS
AO752-74Crr	India	LU.SB90C.006	N	N250GB5.4KS
AO752-74Cw	China	LU.SBA0C.003	N	N250GB5.4KS
AO752-74Cw	China	LU.SBA0C.004	N	N160GB5.4KS
AO752-74Cw	Eastern Europe	LU.SBA0C.002	N	N320GB5.4KS
AO752-74Cw	India	LU.SBA0C.006	N	N160GB5.4KS
AO752-74Cw	Russia	LU.SBA0C.005	N	N160GB5.4KS
AO752-74Cws	Denmark	LU.SBA0C.007	N	N250GB5.4KS
AO752-74Cws	India	LU.SBA0C.008	N	N250GB5.4KS
AO752-74Cws	India	LU.SBA0C.009	N	N320GB5.4KS

Model	Country	Acer Part No	Wireless LAN1	Bluetooth
AO752-72Db	WW	S2.SB80D.001	3rd WiFi 1x2 BGN	N
AO752-72DGb	WW	S2.SBE0D.001	3rd WiFi 1x2 BGN	N
AO752-72DGk	WW	S2.SBF0D.001	3rd WiFi 1x2 BGN	N
AO752-72DGGr	WW	S2.SBG0D.001	3rd WiFi 1x2 BGN	N
AO752-72DGw	WW	S2.SBH0D.001	3rd WiFi 1x2 BGN	N
AO752-72Dk	WW	S2.SB70D.001	3rd WiFi 1x2 BGN	N
AO752-72Dr	WW	S2.SB90D.001	3rd WiFi 1x2 BGN	N
AO752-72Dw	WW	S2.SBA0D.001	3rd WiFi 1x2 BGN	N
AO752-741b	China	LU.SB801.001	INT1000H	BT 2.1
AO752-741k	China	LU.SB701.001	INT1000H	BT 2.1
AO752-741rr	Middle East	LU.SB901.003	INT1000H	N
AO752-742b	GCTWN	LU.SB802.051	INT1000H	BT 2.1
AO752-742bb	Australia/New Zealand	LU.SB802.126	INT1000H	BT 2.1
AO752-742bb	Denmark	LU.SB802.125	INT1000H	N
AO752-742bb	GCTWN	LU.SB802.127	INT1000H	BT 2.1
AO752-742r	GCTWN	LU.SB902.047	INT1000H	BT 2.1
AO752-742rr	Austria	LU.SB902.167	INT1000H	N
AO752-742rr	Denmark	LU.SB902.166	INT1000H	N
AO752-742rr	GCTWN	LU.SB902.168	INT1000H	BT 2.1
AO752-742w	GCTWN	LU.SBA02.047	INT1000H	BT 2.1
AO752-742ws	Denmark	LU.SBA02.169	INT1000H	N
AO752-742ws	Denmark	LU.SBA02.170	INT1000H	N
AO752-748bb	Middle East	LU.SB808.031	INT1000H	BT 2.1
AO752-748bb	Russia	LU.SB808.029	INT1000H_BG	N
AO752-748bb	Russia	LU.SB808.030	INT1000H_BG	BT 2.1
AO752-748rr	Middle East	LU.SB908.020	INT1000H	N
AO752-748rr	Middle East	LU.SB908.022	INT1000H	BT 2.1
AO752-748rr	Russia	LU.SB908.018	INT1000H_BG	N
AO752-748rr	Russia	LU.SB908.019	INT1000H_BG	N
AO752-748rr	Russia	LU.SB908.021	INT1000H_BG	BT 2.1
AO752-748ws	Middle East	LU.SBA08.007	INT1000H	BT 2.1
AO752-748ws	Russia	LU.SBA08.005	INT1000H_BG	N
AO752-748ws	Russia	LU.SBA08.006	INT1000H_BG	BT 2.1
AO752-74Cb	Eastern Europe	LU.SB80C.003	INT1000H	N
AO752-74Cbb	India	LU.SB80C.004	INT1000H	BT 2.1
AO752-74Cbb	India	LU.SB80C.005	INT1000H	BT 2.1
AO752-74Ck	China	LU.SB70C.008	INT1000H	BT 2.1
AO752-74Ck	India	LU.SB70C.009	INT1000H	BT 2.1
AO752-74Ckk	India	LU.SB70C.010	INT1000H	BT 2.1
AO752-74Ckk	India	LU.SB70C.017	INT1000H	BT 2.1
AO752-74Cr	China	LU.SB90C.002	INT1000H	N
AO752-74Cr	India	LU.SB90C.003	INT1000H	BT 2.1

Model	Country	Acer Part No	Wireless LAN1	Bluetooth
AO752-74Crr	Baltic	LU.SB90C.004	INT1000H	N
AO752-74Crr	Baltic	LU.SB90C.005	INT1000H	N
AO752-74Crr	India	LU.SB90C.006	INT1000H	BT 2.1
AO752-74Cw	China	LU.SBA0C.003	INT1000H	BT 2.1
AO752-74Cw	China	LU.SBA0C.004	INT1000H	N
AO752-74Cw	Eastern Europe	LU.SBA0C.002	INT1000H	N
AO752-74Cw	India	LU.SBA0C.006	INT1000H	BT 2.1
AO752-74Cw	Russia	LU.SBA0C.005	INT1000H_BG	BT 2.1
AO752-74Cws	Denmark	LU.SBA0C.007	INT1000H	N
AO752-74Cws	India	LU.SBA0C.008	INT1000H	BT 2.1
AO752-74Cws	India	LU.SBA0C.009	INT1000H	BT 2.1

Model	Country	Acer Part No	NB Chipset	SB Chipset
AO752-72Db	WW	S2.SB80D.001	GS45	ICH9M-SFFE
AO752-72DGb	WW	S2.SBE0D.001	GS45	ICH9M-SFFE
AO752-72DGk	WW	S2.SBF0D.001	GS45	ICH9M-SFFE
AO752-72DGGr	WW	S2.SBG0D.001	GS45	ICH9M-SFFE
AO752-72DGw	WW	S2.SBH0D.001	GS45	ICH9M-SFFE
AO752-72Dk	WW	S2.SB70D.001	GS45	ICH9M-SFFE
AO752-72Dr	WW	S2.SB90D.001	GS45	ICH9M-SFFE
AO752-72Dw	WW	S2.SBA0D.001	GS45	ICH9M-SFFE
AO752-741b	China	LU.SB801.001	GS45	ICH9M-SFFE
AO752-741k	China	LU.SB701.001	GS45	ICH9M-SFFE
AO752-741rr	Middle East	LU.SB901.003	GS45	ICH9M-SFFE
AO752-742b	GCTWN	LU.SB802.051	GS45	ICH9M-SFFE
AO752-742bb	Australia/New Zealand	LU.SB802.126	GS45	ICH9M-SFFE
AO752-742bb	Denmark	LU.SB802.125	GS45	ICH9M-SFFE
AO752-742bb	GCTWN	LU.SB802.127	GS45	ICH9M-SFFE
AO752-742r	GCTWN	LU.SB902.047	GS45	ICH9M-SFFE
AO752-742rr	Austria	LU.SB902.167	GS45	ICH9M-SFFE
AO752-742rr	Denmark	LU.SB902.166	GS45	ICH9M-SFFE
AO752-742rr	GCTWN	LU.SB902.168	GS45	ICH9M-SFFE
AO752-742w	GCTWN	LU.SBA02.047	GS45	ICH9M-SFFE
AO752-742ws	Denmark	LU.SBA02.169	GS45	ICH9M-SFFE
AO752-742ws	Denmark	LU.SBA02.170	GS45	ICH9M-SFFE
AO752-748bb	Middle East	LU.SB808.031	GS45	ICH9M-SFFE
AO752-748bb	Russia	LU.SB808.029	GS45	ICH9M-SFFE
AO752-748bb	Russia	LU.SB808.030	GS45	ICH9M-SFFE
AO752-748rr	Middle East	LU.SB908.020	GS45	ICH9M-SFFE
AO752-748rr	Middle East	LU.SB908.022	GS45	ICH9M-SFFE
AO752-748rr	Russia	LU.SB908.018	GS45	ICH9M-SFFE
AO752-748rr	Russia	LU.SB908.019	GS45	ICH9M-SFFE
AO752-748rr	Russia	LU.SB908.021	GS45	ICH9M-SFFE

Model	Country	Acer Part No	NB Chipset	SB Chipset
AO752-748ws	Middle East	LU.SBA08.007	GS45	ICH9M-SFFE
AO752-748ws	Russia	LU.SBA08.005	GS45	ICH9M-SFFE
AO752-748ws	Russia	LU.SBA08.006	GS45	ICH9M-SFFE
AO752-74Cb	Eastern Europe	LU.SB80C.003	GS45	ICH9M-SFFE
AO752-74Cbb	India	LU.SB80C.004	GS45	ICH9M-SFFE
AO752-74Cbb	India	LU.SB80C.005	GS45	ICH9M-SFFE
AO752-74Ck	China	LU.SB70C.008	GS45	ICH9M-SFFE
AO752-74Ck	India	LU.SB70C.009	GS45	ICH9M-SFFE
AO752-74Ckk	India	LU.SB70C.010	GS45	ICH9M-SFFE
AO752-74Ckk	India	LU.SB70C.017	GS45	ICH9M-SFFE
AO752-74Cr	China	LU.SB90C.002	GS45	ICH9M-SFFE
AO752-74Cr	India	LU.SB90C.003	GS45	ICH9M-SFFE
AO752-74Crr	Baltic	LU.SB90C.004	GS45	ICH9M-SFFE
AO752-74Crr	Baltic	LU.SB90C.005	GS45	ICH9M-SFFE
AO752-74Crr	India	LU.SB90C.006	GS45	ICH9M-SFFE
AO752-74Cw	China	LU.SBA0C.003	GS45	ICH9M-SFFE
AO752-74Cw	China	LU.SBA0C.004	GS45	ICH9M-SFFE
AO752-74Cw	Eastern Europe	LU.SBA0C.002	GS45	ICH9M-SFFE
AO752-74Cw	India	LU.SBA0C.006	GS45	ICH9M-SFFE
AO752-74Cw	Russia	LU.SBA0C.005	GS45	ICH9M-SFFE
AO752-74Cws	Denmark	LU.SBA0C.007	GS45	ICH9M-SFFE
AO752-74Cws	India	LU.SBA0C.008	GS45	ICH9M-SFFE
AO752-74Cws	India	LU.SBA0C.009	GS45	ICH9M-SFFE

Model	Country	Acer Part No	Battery
AO752-72Db	WW	S2.SB80D.001	3CELL2.2
AO752-72DGb	WW	S2.SBE0D.001	3CELL2.2
AO752-72DGk	WW	S2.SBF0D.001	3CELL2.2
AO752-72DGr	WW	S2.SBG0D.001	3CELL2.2
AO752-72DGw	WW	S2.SBH0D.001	3CELL2.2
AO752-72Dk	WW	S2.SB70D.001	3CELL2.2
AO752-72Dr	WW	S2.SB90D.001	3CELL2.2
AO752-72Dw	WW	S2.SBA0D.001	3CELL2.2
AO752-741b	China	LU.SB801.001	3CELL2.2
AO752-741k	China	LU.SB701.001	3CELL2.2
AO752-741rr	Middle East	LU.SB901.003	6CELL2.2
AO752-742b	GCTWN	LU.SB802.051	6CELL2.2
AO752-742bb	Australia/New Zealand	LU.SB802.126	6CELL2.8
AO752-742bb	Denmark	LU.SB802.125	6CELL2.2
AO752-742bb	GCTWN	LU.SB802.127	6CELL2.2
AO752-742r	GCTWN	LU.SB902.047	6CELL2.2
AO752-742rr	Austria	LU.SB902.167	6CELL2.2
AO752-742rr	Denmark	LU.SB902.166	6CELL2.2

Model	Country	Acer Part No	Battery
AO752-742rr	GCTWN	LU.SB902.168	6CELL2.2
AO752-742w	GCTWN	LU.SBA02.047	6CELL2.2
AO752-742ws	Denmark	LU.SBA02.169	6CELL2.2
AO752-742ws	Denmark	LU.SBA02.170	6CELL2.2
AO752-748bb	Middle East	LU.SB808.031	6CELL2.2
AO752-748bb	Russia	LU.SB808.029	6CELL2.2
AO752-748bb	Russia	LU.SB808.030	6CELL2.2
AO752-748rr	Middle East	LU.SB908.020	6CELL2.2
AO752-748rr	Middle East	LU.SB908.022	6CELL2.2
AO752-748rr	Russia	LU.SB908.018	6CELL2.2
AO752-748rr	Russia	LU.SB908.019	3CELL2.2
AO752-748rr	Russia	LU.SB908.021	6CELL2.2
AO752-748ws	Middle East	LU.SBA08.007	6CELL2.2
AO752-748ws	Russia	LU.SBA08.005	6CELL2.2
AO752-748ws	Russia	LU.SBA08.006	6CELL2.2
AO752-74Cb	Eastern Europe	LU.SB80C.003	3CELL2.2
AO752-74Cbb	India	LU.SB80C.004	6CELL2.2
AO752-74Cbb	India	LU.SB80C.005	6CELL2.2
AO752-74Ck	China	LU.SB70C.008	3CELL2.2
AO752-74Ck	India	LU.SB70C.009	6CELL2.2
AO752-74Ckk	India	LU.SB70C.010	6CELL2.2
AO752-74Ckk	India	LU.SB70C.017	6CELL2.2
AO752-74Cr	China	LU.SB90C.002	3CELL2.2
AO752-74Cr	India	LU.SB90C.003	6CELL2.2
AO752-74Crr	Baltic	LU.SB90C.004	6CELL2.2
AO752-74Crr	Baltic	LU.SB90C.005	6CELL2.2
AO752-74Crr	India	LU.SB90C.006	6CELL2.2
AO752-74Cw	China	LU.SBA0C.003	3CELL2.2
AO752-74Cw	China	LU.SBA0C.004	3CELL2.2
AO752-74Cw	Eastern Europe	LU.SBA0C.002	6CELL2.2
AO752-74Cw	India	LU.SBA0C.006	6CELL2.2
AO752-74Cw	Russia	LU.SBA0C.005	6CELL2.2
AO752-74Cws	Denmark	LU.SBA0C.007	6CELL2.2
AO752-74Cws	India	LU.SBA0C.008	6CELL2.2
AO752-74Cws	India	LU.SBA0C.009	6CELL2.2

Test Compatible Components

This computer's compatibility is tested and verified by Acer's internal testing department. All of its system functions are tested under Windows® XP Home, Windows® XP Pro environment.

Refer to the following lists for components, adapter cards, and peripherals which have passed these tests. Regarding configuration, combination and test procedures, please refer to the Aspire one series Compatibility Test Report released by the Acer Mobile System Testing Department

Aspire 1810T/1410

BRAND	Type	Description
3G		
Huawei	EM770W	Huawei EM770W
Qualcomm	Gobi2000	Qualcomm Gobi2000
Cover		
	Black IMR	Black IMR
	Blue IMR	Blue IMR
	Red IMR	Red IMR
Accessory		
ACER	ACER 11inch Netbook Bag Black	ACER Accessory ACER 11" Netbook Bag Black
Adapter		
DELTA	30W	Adapter DELTA 30W 19V 1.7x5.5x11 Black ADP-30JH BA LF
DELTA	65W_BR	Adapter DELTA 65W_BR 19V 1.7x5.5x11 Yellow ADP-65JH DB A, LV5 LED LF (Brazil)
HIPRO	30W	Adapter HIPRO 30W 19V 1.7x5.5x11 Black HP-A0301R3 B1LF LF
LITE-ON	30W	Adapter LITE-ON 30W 19V 1.7x5.5x11 Black PA-1300-04AC LF
LITE-ON	65W_BR	Adapter LITE-ON 65W_BR 19V 1.7x5.5x11 Yellow PA-1650-22AC LV5 LED LF (Brazil)
LITE-ON	65W_BR	Adapter LITE-ON 65W_BR 19V 1.7x5.5x11 Yellow PA-1650-22AB, LV5 LED LF (Brazil, by Palladium)
Audio Codec		
Realtek	ALC269X	Realtek Audio Codec ALC269X
B Cover		
	Mirror w/Camera	Mirror w/Camera
Battery		
PANASONIC	6CELL2.2	Battery PANASONIC UM-2009E Li-Ion 3S2P PANASONIC 6 cell 4400mAh Main COMMON ID:UM09E51
SANYO	6CELL2.2	Battery SANYO UM-2009E Li-Ion 3S2P SANYO 6 cell 4400mAh Main COMMON ID: UM09E31
SANYO	6CELL2.8	Battery SANYO UM-2009E Li-Ion 3S2P SANYO 6 cell 5600mAh Main COMMON ID:UM09E36
SANYO	6CELL2.8_BR	Battery SANYO UM-2009E Li-Ion 3S2P SANYO 6 cell 5600mAh Main COMMON ID:UM09E36, (Brazil)
SIMPLO	6CELL2.2	Battery SIMPLO UM-2009E Li-Ion 3S2P PANASONIC 6 cell 4400mAh Main COMMON ID:UM09E71
SIMPLO	6CELL2.2	Battery SIMPLO UM-2009E Li-Ion 3S2P PANASONIC 6 cell 4400mAh Main COMMON ID:UM09E71
SIMPLO	6CELL2.8	Battery SIMPLO UM-2009E Li-Ion 3S2P LGC 6 cell 5600mAh Main COMMON ID:UM09E78
SIMPLO	6CELL2.8	Battery SIMPLO UM-2009E Li-Ion 3S2P SAMSUNG 6 cell 5600mAh Main COMMON ID:UM09E70
SIMPLO	6CELL2.8_BR	Battery SIMPLO UM-2009E Li-Ion 3S2P SAMSUNG 6 cell 5600mAh Main COMMON ID:UM09E70, (Brazil)

BRAND	Type	Description
Camera		
Chicony	0.3M LDV	Chicony Camera Lilac_2G
Liteon	0.3M LDV	Liteon Camera Lily_2G
Suyin	0.3M LDV	Suyin Camera Rose_2G
Card Reader		
	5 in 1-Build in	5 in 1-Build in MS, MS Pro, SD, SC, XD
CPU		
INTEL	C2SSU3500B	CPU Intel Core2Solo SU3500 BGA 1.4G 3M 800 5.5W ULV
INTEL	CM723B	CPU Intel Celeron 723 BGA 1.2G 1M 800 10W R-0 ULV
INTEL	CM723B_BR	CPU Intel Celeron 723 BGA 1.2G 1M 800 10W R-0 ULV (Brazil)
INTEL	PMDSU4100B	CPU Intel Core2Dual SU4100 2M 800
HDD		
HGST	N160GB5.4KS	HDD HGST 2.5" 5400rpm 160GB Falcon B HTS543216L9SA00 SATA LF F/W:C40C
HGST	N160GB5.4KS	HDD HGST 2.5" 5400rpm 160GB Falcon B HTS543216L9SA00 SATA LF F/W:C40C
HGST	N250GB5.4KS	HDD HGST 2.5" 5400rpm 250GB HTS545025B9A300 Panther B SATA LF F/W:C60F Disk imbalance criteria = 0.014g-cm
HGST	N250GB5.4KS	HDD HGST 2.5" 5400rpm 250GB HTS545025B9A300 Panther B SATA LF F/W:C60F Disk imbalance criteria = 0.014g-cm
HGST	N250GB5.4KS_BR	HDD HGST 2.5" 5400rpm 250GB HTS545025B9A300 Panther B SATA LF F/W:C60F Disk imbalance criteria = 0.014g-cm (Brazil)
HGST	N320GB5.4KS	HDD HGST 2.5" 5400rpm 320GB HTS545032B9A300 Panther B SATA LF F/W:C60F Disk imbalance criteria = 0.014g-cm
SAMSUNG	N250GB5.4KS_BR	HDD SAMSUNG 2.5" 5400rpm 250GB M6, HM251JI/SRA SATA LF F/W:2SS00-01 (Brazil)
SAMSUNG	N250GB5.4KS_BR	HDD SAMSUNG 2.5" 5400rpm 250GB M7, HM250HISRA SATA LF F/W:2AC101-C4 (Brazil)
SEAGATE	N160GB5.4KS	HDD SEAGATE 2.5" 5400rpm 160GB ST9160314AS Wyatt SATA LF F/W:0001SDM1
SEAGATE	N250GB5.4KS	HDD SEAGATE 2.5" 5400rpm 250GB ST9250315AS Wyatt SATA LF F/W:0001SDM1
SEAGATE	N250GB5.4KS_BR	HDD SEAGATE 2.5" 5400rpm 250GB ST9250315AS Wyatt SATA LF F/W:0001SDM1 (Brazil)
SEAGATE	N320GB5.4KS	HDD SEAGATE 2.5" 5400rpm 320GB ST9320325AS Wyatt SATA LF F/W:0001SDM1
TOSHIBA	N160GB5.4KS	HDD TOSHIBA 2.5" 5400rpm 160GB MK1655GSX Libra SATA LF F/W: FG011J
TOSHIBA	N250GB5.4KS	HDD TOSHIBA 2.5" 5400rpm 250GB MK2555GSX Libra SATA LF F/W:FG001J
TOSHIBA	N320GB5.4KS	HDD TOSHIBA 2.5" 5400rpm 320GB MK3255GSX Libra SATA LF F/W:FG011J

BRAND	Type	Description
WD	N160GB5.4KS	HDD WD 2.5" 5400rpm 160GB WD1600BEVT-22ZCT0 ML160 SATA LF F/W:11.01A11
WD	N250GB5.4KS	HDD WD 2.5" 5400rpm 250GB WD2500BEVT-22ZCT0 ML160 SATA LF F/W:11.01A11
WD	N250GB5.4KS_BR	HDD WD 2.5" 5400rpm 250GB WD2500BEVT-22ZCT0 ML160 SATA LF F/W:11.01A11 (Brazil)
WD	N320GB5.4KS	HDD WD 2.5" 5400rpm 320GB WD3200BEVT-22ZCT0 ML160 SATA LF F/W:11.01A11
Keyboard		
ACER	NT1T	Keyboard ACER NT-1T JV11 Internal 11 Standard Black NONE Texture
LAN		
Atheros	AR8131L	Atheros AR8131L
LCD		
AUO	NLED11.6WXGAG	LED LCD AUO 11.6" WXGA Glare B116XW02 V0 LF 200nit 8ms 500:1
AUO	NLED11.6WXGAG	LED LCD AUO 11.6" WXGA Glare B116XW02 V0 LF 200nit 8ms 500:1
AUO	NLED11.6WXGAG	LED LCD AUO 11.6" WXGA Glare B116XW02 V0 LF 200nit 8ms 500:1
AUO	NLED11.6WXGAG_B R	LED LCD AUO 11.6" WXGA Glare B116XW02 V0 1A (3G) LF 200nit 8ms 500:1 (Brazil)
CMO	NLED11.6WXGAG	LED LCD CMO 11.6" WXGA Glare N116B6-L02 C2 LF 200nit 10ms 500:1
CMO	NLED11.6WXGAG_B R	LED LCD CMO 11.6" WXGA Glare N116B6-L02 C2 LF 200nit 10ms 500:1 (Brazil)
LPL	NLED11.6WXGAG	LED LCD LPL 11.6" WXGA Glare LP116WH1-TLA1 LF 200nit 8ms 500:1
SAMSUNG	NLED11.6WXGAG	LED LCD SAMSUNG 11.6" WXGA Glare LTN116AT01-A01 LF 200nit 8ms
MEM		
HYNIX	SO1GBII6	Memory HYNIX SO-DIMM DDRII 667 1GB HYMP112S64CP6-Y5 LF
HYNIX	SO2GBII6	Memory HYNIX SO-DIMM DDRII 667 2GB HYMP125S64CP8-Y5 LF
NANYA	SO1GBII6	Memory NANYA SO-DIMM DDRII 667 1GB NT1GT64UH8D0FN-3C LF 64*16 0.07um
NANYA	SO1GBII8_BR	Memory NANYA SO-DIMM DDRII 800 1GB NT1GT64UH8D0FN-AD LF 64*16 0.07um (Brazil)
NANYA	SO2GBII6	Memory NANYA SO-DIMM DDRII 667 2GB NT2GT64U8HD0BN-3C LF 128*8 0.07um
NANYA	SO2GBII8_BR	Memory NANYA SO-DIMM DDRII 800 2GB NT2GT64U8HD0BN-AD LF 128*8 0.07um (Brazil)
SAMSUNG	SO1GBII6	Memory SAMSUNG SO-DIMM DDRII 667 1GB M470T2864QZ3-CE6 LF
SAMSUNG	SO1GBII6	Memory SAMSUNG SO-DIMM DDRII 667 1GB M470T2864QZ3-CE6 LF
SAMSUNG	SO1GBII8_BR	Memory SAMSUNG SO-DIMM DDRII 800 1GB M470T2864EH3-CF7 LF 64*16 0.055um (Brazil)

BRAND	Type	Description
SAMSUNG	SO2GBII6	Memory SAMSUNG SO-DIMM DDRII 667 2GB M470T5663QZ3-CE6 LF
SAMSUNG	SO2GBII6	Memory SAMSUNG SO-DIMM DDRII 667 2GB M470T5663EH3-CE6 LF 128*8 0.055um
SAMSUNG	SO2GBII8	Memory SAMSUNG SO-DIMM DDRII 800 2GB M470T5663EH3-CF7 LF 128*8 0.055um
SAMSUNG	SO2GBII8_BR	Memory SAMSUNG SO-DIMM DDRII 800 2GB M470T5663EH3-CF7 LF 128*8 0.055um (Brazel)
NB Chipset		
INTEL	GS45	NB Chipset Intel CS GS45NB
SB Chipset		
INTEL	ICH9M-SFFE	SB Chipset Intel CS AM82801IUX MM#898134
Software		
	McAfee	Antivirus application McAfee
VGA Chips		
None	UMA	UMA (Intel)
WiFi Antenna		
WNC	PIFA	PIFA
WirelessLAN		
Foxconn	3rd WiFi 1x2 BGN	Foxconn Wireless LAN Atheros HB93 1x2 BGN (HM)
INTEL	INT1000H	Lan Intel WLAN 112BN.HMVG MM#903341
INTEL	SP1x2HABG	Lan Intel WLAN 512AG_HMVG Shirley Peak 5100 MM#897072
INTEL	SP1x2HMW	Lan Intel WLAN 512AN_HMVG Shirley Peak 5100 MM#895373

Aspire One 752

Vendor	Type	Description
3G		
60016072 QUALCOMM	Gobi1000-AT&T	Qualcomm Gobi1000-AT&T
60016072 QUALCOMM	Gobi2000	Qualcomm Gobi2000
60016072 QUALCOMM	UNDP-1	3G UNDP-1
Adapter		
10001023 LITE-ON	65W_BR	Adapter LITE-ON 65W_BR 19V 1.7x5.5x11 Yellow PA-1650-22AC LV5 LED LF (Brazil)
10001023 LITE-ON	65W_BR	Adapter LITE-ON 65W_BR 19V 1.7x5.5x11 Yellow PA-1650-22AB, LV5 LED LF (Brazil, by Palladium)
60002015 HIPRO	30W	Adapter HIPRO 30W 19V 1.7x5.5x11 Black HP-A0301R3 B1LF LF
60002015 HIPRO	30W	Adapter HIPRO 30W 19V 1.7x5.5x11 Black HP-A0301R3 B1LF (Rev.03, w/Korean safety logo) LF
60003544 LITE-ON OPT	30W	Adapter LITE-ON 30W 19V 1.7x5.5x11 Black PA-1300-04AC LF
Audio Codec		
10004786 REALTEK	ALC269X	Realtek Audio Codec ALC269X
Battery		
60001535 PANASONIC	3CELL2.2	Battery PANASONIC UM-2009EW Li-Ion 3S1P PANASONIC 3 cell 2200mAh Main COMMON ID:UM09E52 , white
60001535 PANASONIC	6CELL2.2	Battery PANASONIC UM-2009E Li-Ion 3S2P PANASONIC 6 cell 4400mAh Main COMMON ID:UM09E51
60001535 PANASONIC	6CELL2.2	Battery PANASONIC UM-2009EW Li-Ion 3S2P PANASONIC 6 cell 4400mAh Main COMMON ID:UM09E51, white
60001535 PANASONIC	6CELL2.9	Battery PANASONIC UM-2009E Li-Ion 3S2P PANASONIC 6 cell 5800mAh Main COMMON ID:UM09E56
60001535 PANASONIC	6CELL2.9	Battery PANASONIC UM-2009EW Li-Ion 3S2P PANASONIC 6 cell 5800mAh Main COMMON ID:UM09E56 , white
60001921 SANYO	3CELL2.2	Battery SANYO UM-2009E Li-Ion 3S1P SANYO 3 cell 2200mAh Main COMMON ID : UM09E32
60001921 SANYO	3CELL2.2	Battery SANYO UM-2009EW Li-Ion 3S1P SANYO 3 cell 2200mAh Main COMMON ID: UM09E32 , white
60001921 SANYO	6CELL2.2	Battery SANYO UM-2009E Li-Ion 3S2P SANYO 6 cell 4400mAh Main COMMON ID: UM09E31
60001921 SANYO	6CELL2.2	Battery SANYO UM-2009EW Li-Ion 3S2P SANYO 6 cell 4400mAh Main COMMON ID:UM09E31 , white color
60002162 SIMPLO	3CELL2.2	Battery SIMPLO UM-2009E Li-Ion 3S1P PANASONIC 3 cell 2200mAh Main COMMON ID:UM09E72

Vendor	Type	Description
60002162 SIMPLO	3CELL2.2	Battery SIMPLO UM-2009E Li-Ion 3S1P SAMSUNG 3 cell 2200mAh Main COMMON ID:UM09E7B
60002162 SIMPLO	3CELL2.2	Battery SIMPLO UM-2009EW Li-Ion 3S1P PANASONIC 3 cell 2200mAh Main COMMON ID:UM09E72 , white
60002162 SIMPLO	6CELL2.2	Battery SIMPLO UM-2009E Li-Ion 3S2P PANASONIC 6 cell 4400mAh Main COMMON ID:UM09E71
CPU		
10001067 INTEL	C2DSU7300B	CPU Intel Core2Dual SU7300 3M 800 R-0
10001067 INTEL	C2SSU3500B	CPU Intel Core2Solo SU3500 BGA 1.4G 3M 800 5.5W ULV
10001067 INTEL	CM723B	CPU Intel Celeron 723 BGA 1.2G 1M 800 10W R-0 ULV
10001067 INTEL	CM723B_BR	CPU Intel Celeron 723 BGA 1.2G 1M 800 10W R-0 ULV (Brazil)
10001067 INTEL	CM743B	CPU Intel Celeron 743 BGA 1M 800
10001067 INTEL	CMSU2300B	CPU Intel Celeron SU2300 BGA 1.2G 1M 800 10W R-0
10001067 INTEL	CMSU2300B_BR	CPU Intel Celeron SU2300 BGA 1.2G 1M 800 10W R-0 (Brazil)
10001067 INTEL	PMDSU4100B	CPU Intel Core2Dual SU4100 2M 800
HDD		
60001922 TOSHIBA DIGI	N250GB5.4KS	HDD TOSHIBA 2.5" 5400rpm 250GB MK2555GSX Libra SATA LF F/W:FG001J
60001994 WD	N160GB5.4KS	HDD WD 2.5" 5400rpm 160GB WD1600BEVT-22ZCT0 ML160 SATA LF F/W:11.01A11
60001994 WD	N250GB5.4KS	HDD WD 2.5" 5400rpm 250GB WD2500BEVT-22ZCT0 ML160 SATA LF F/W:11.01A11
60001994 WD	N250GB5.4KS	HDD WD 2.5" 5400rpm 250GB WD2500BEVT-22A23T0, WD, ML320S SATA 8MB LF F/W:01.01A01.
60001994 WD	N250GB5.4KS_BR	HDD WD 2.5" 5400rpm 250GB WD2500BEVT-22ZCT0 ML160 SATA LF F/W:11.01A11 (Brazil)
60001994 WD	N320GB5.4KS	HDD WD 2.5" 5400rpm 320GB WD3200BEVT-22ZCT0 ML160 SATA LF F/W:11.01A11
60001994 WD	N500GB5.4KS	HDD WD 2.5" 5400rpm 500GB WD5000BEVT-22ZAT0 ML250 SATA 8MB LF F/W:01.01A01
60002005 HGST SG	N250GB5.4KS	HDD HGST 2.5" 5400rpm 250GB HTS545025B9A300 Panther B SATA LF F/W:C60F Disk imbalance criteria = 0.014g-cm
60002005 HGST SG	N250GB5.4KS	HDD HGST 2.5" 5400rpm 250GB HTS543225L9A300 Falcon B SATA LF F/W:C40C Disk imbalance criteria = 0.014g-cm
60002005 HGST SG	N250GB5.4KS_BR	HDD HGST 2.5" 5400rpm 250GB HTS545025B9A300 Panther B SATA LF F/W:C60F Disk imbalance criteria = 0.014g-cm (Brazil)
60002005 HGST SG	N320GB5.4KS	HDD HGST 2.5" 5400rpm 320GB HTS545032B9A300 Panther B SATA LF F/W:C60F Disk imbalance criteria = 0.014g-cm
60002005 HGST SG	N320GB5.4KS	HDD HGST 2.5" 5400rpm 320GB HTS543232L9A300 Falcon B SATA LF F/W:C40C Disk imbalance criteria = 0.014g-cm

Vendor	Type	Description
60002005 HGST SG	N500GB5.4KS	HDD HGST 2.5" 5400rpm 500GB HTS545050B9A300 Panther B SATA LF F/W:C60F Disk imbalance criteria = 0.014g-cm
60002036 SEAGATE	N160GB5.4KS	HDD SEAGATE 2.5" 5400rpm 160GB ST9160314AS Wyatt SATA LF F/W:0001SDM1
60002036 SEAGATE	N250GB5.4KS_BR	HDD SEAGATE 2.5" 5400rpm 250GB ST9250315AS Wyatt SATA LF F/W:0001SDM1 (Brazil)
60002215 SAMSUNG	N250GB5.4KS_BR	HDD SAMSUNG 2.5" 5400rpm 250GB M6, HM251JI SATA LF F/W:2SS00-01 (Brazil)
LCD		
10001038 CMO	NLED11.6WXGAG	LED LCD CMO 11.6" WXGA Glare N116B6-L02 LF 200nit 10ms 500:1
10001038 CMO	NLED11.6WXGAG	LED LCD CMO 11.6" WXGA Glare N116B6-L02 C2 LF 200nit 10ms 500:1
60002215 SAMSUNG	NLED11.6WXGAG	LED LCD SAMSUNG 11.6" WXGA Glare LTN116AT01-A01 LF 200nit 8ms
60003089 LG	NLED11.6WXGAG	LED LCD LPL 11.6" WXGA Glare LP116WH1-TLA1 LF 200nit 8ms 500:1
60003316 AUO	NLED11.6WSVGAG	LED LCD AUO 11.6" WSVGAG Glare B116AW02 V0 LF 200nit 16ms 500:1
60003316 AUO	NLED11.6WXGAG	LED LCD AUO 11.6" WXGA Glare B116XW02 V0 1A (3G) LF 200nit 8ms 500:1
60003316 AUO	NLED11.6WXGAG_BR	LED LCD AUO 11.6" WXGA Glare B116XW02 V0 1A (3G) LF 200nit 8ms 500:1 (Brazil)
MEM		
60001928 TRANSCEND	SO1GBII8	Memory TRANSCEND SO-DIMM DDRII 800 1GB JM800QSU-1G LF 128*8 0.065um
60001928 TRANSCEND	SO2GBII8	Memory TRANSCEND SO-DIMM DDRII 800 2GB JM800QSU-2G LF 128*8 0.065um
60001993 NANYA	SO1GBII6	Memory NANYA SO-DIMM DDRII 667 1GB NT1GT64UH8D0FN-3C LF 64*16 0.07um
60002000 UNIFOSA	SO1GBII8	Memory UNIFOSA SO-DIMM DDRII 800 1GB GU331G0ALEPR612C6F1 LF 128*8 0.065um
60002000 UNIFOSA	SO2GBII8	Memory UNIFOSA SO-DIMM DDRII 800 2GB GU332G0ALEPR8H2C6F1 LF 128*8 0.065um
60002045 HYNIX	SO1GBII6	Memory HYNIX SO-DIMM DDRII 667 1GB HYMP112S64CP6-Y5 LF 64*16 0.065um
60002045 HYNIX	SO2GBII6	Memory HYNIX SO-DIMM DDRII 667 2GB HYMP125S64CP8-Y5 LF 128*8 0.065um
60002215 SAMSUNG	SO1GBII6	Memory SAMSUNG SO-DIMM DDRII 667 1GB M470T2864QZ3-CE6 LF 64*16 0.065um
60002215 SAMSUNG	SO1GBII6	Memory SAMSUNG SO-DIMM DDRII 667 1GB M470T2864EH3-CE6 LF 64*16 0.055um
60002215 SAMSUNG	SO2GBII6	Memory SAMSUNG SO-DIMM DDRII 667 2GB M470T5663EH3-CE6 LF 128*8 0.055um
60002215 SAMSUNG	SO2GBII8	Memory SAMSUNG SO-DIMM DDRII 800 2GB M470T5663EH3-CF7 LF 128*8 0.055um
60002215 SAMSUNG	SO2GBII8_BR	Memory SAMSUNG SO-DIMM DDRII 800 2GB M470T5663EH3-CF7 LF 128*8 0.055um (Brazil)

Vendor	Type	Description
60004668 ELPIDA	SO1GBII8	Memory ELPIDA SO-DIMM DDRII 800 1GB EBE10UE8AFSA-8G-F LF 128*8 0.065um
60004668 ELPIDA	SO2GBII8	Memory ELPIDA SO-DIMM DDRII 800 2GB EBE21UE8AFSA-8G-F LF 128*8 0.065um
F0000434 SMART	SO1GBII8_BR	Memory SMART SO-DIMM DDRII 800 1GB SH564283FG8NWKFSEG LF 128*8 0.055um
F0000434 SMART	SO2GBII8_BR	Memory SMART SO-DIMM DDRII 800 2GB SH564568FG8NWKFSEG LF 128*8 0.055um (Brazil)
VGA Chip		
10001067 INTEL	UMA	UMA (Intel)
VRAM		
9999995 ONE TIME VENDER	N	N no VRAM
Wireless LAN		
10001067 INTEL	EP1x2HABG	WiMax Intel WLAN 512AGXHRUG WiMax/WiFi Link 5150 ABG HMC MM#901692
10001067 INTEL	INT1000H	Lan Intel WLAN 112BN.HMWG MM#903341
10001067 INTEL	INT1000H_BG	Lan Intel WLAN INT1000HBG
10001067 INTEL	INT1000H_BR	Lan Intel WLAN 112BN.HMWG MM#903341 (Brazil)
10001067 INTEL	SP1x2HABG	Lan Intel WLAN 512AG_HMWG Shirley Peak 5100 MM#897072
10001067 INTEL	SP1x2HMW	Lan Intel WLAN 512AN_HMWG Shirley Peak 5100 MM#895373

Online Support Information

This section describes online technical support services available to help you repair your Acer Systems.

If you are a distributor, dealer, ASP or TPM, please refer your technical queries to your local Acer branch office. Acer Branch Offices and Regional Business Units may access our website. However some information sources will require a user i.d. and password. These can be obtained directly from Acer CSD Taiwan.

Acer's Website offers you convenient and valuable support resources whenever you need them.

In the Technical Information section you can download information on all of Acer's Notebook, Desktop and Server models including:

- Service guides for all models
- User's manuals
- Training materials
- Bios updates
- Software utilities
- Spare parts lists
- TABs (Technical Announcement Bulletin)

For these purposes, we have included an Acrobat File to facilitate the problem-free downloading of our technical material.

Also contained on this website are:

- Detailed information on Acer's International Traveler's Warranty (ITW)
- Returned material authorization procedures
- An overview of all the support services we offer, accompanied by a list of telephone, fax and email contacts for all your technical queries.

We are always looking for ways to optimize and improve our services, so if you have any suggestions or comments, please do not hesitate to communicate these to us.

A

- Antennas
 - Removing 87, 90

B

- Battery Pack
 - Removing 45
- BIOS
 - ROM type 19
 - vendor 19
 - Version 19
- BIOS Utility 25–33
 - Advanced 28
 - Boot 31
 - Exit 32
 - Navigating 25
 - Power 31
 - Save and Exit 32
 - Security 28
 - System Security 32
- brightness
 - hotkeys 13
- Button Board
 - Removing 61

C

- Camera Board
 - Removing 82, 97
- caps lock
 - on indicator 9
- Common Problems 132
- CRT Cable
 - Removing 71

D

- DIMM Module
 - Removing 50
- Display 4
- display
 - hotkeys 13

E

- Euro Key 14
- External Module Disassembly

Flowchart 44

F

- Features 1
- FLASH Utility 33
- Flash Utility 33
- FRU (Field Replaceable Unit) List 151

H

- Hard Disk Drive Module
 - Removing 47
- Hibernation mode
 - hotkey 13
- Hot Keys 11

I

- Indicators 9
- Intermittent Problems 142
- Internal Microphone Failure 139
- Internal Speaker Failure 138

J

- Jumper and Connector Locations 147

K

- Keyboard
 - Removing 56
- Keyboard Failure 136

L

- LCD Bezel
 - Removing 79, 98
- LCD Brackets
 - Removing 86
- LCD Cable
 - Removing 86
- LCD Failure 135
- LCD Module
 - Removing 113
- LCD Module Disassembly
 - Flowchart 78
- LCD Panel

Removing 83, 95

M

Main Unit Disassembly

Flowchart 54

Mainboard

Removing 71

media access

on indicator 9

Memory Check 132

Microphone

Removing 83, 95

Model Definition 161

N

No Display Issue 133

num lock

on indicator 9

O

ODD Failure 141

Online Support Information 241

P

Panel 5

left 5

PC Card 9

Power On Failure 132

S

Speaker Module

Removing 68

speakers

hotkey 13

System

Block Diagram 4

T

Test Compatible Components 231

Thermal Module

Removing 74

Touch Pad Failure 137

Troubleshooting

Built-in KB Failure 136

Internal Microphone 139

Internal Speakers 138

LCD Failure 135

No Display 133

ODD 141

Other Failures 141

Power On 132

Touch Pad 137

USB 141

U

Undetermined Problems 142

Upper Cover

Removing 58

USB Failure (Rightside) 141

utility

BIOS 25–33

V

volume

hotkeys 13

W

Windows 2000 Environment Test 232

WLAN Board

Removing 52

Free Manuals Download Website

<http://myh66.com>

<http://usermanuals.us>

<http://www.somanuals.com>

<http://www.4manuals.cc>

<http://www.manual-lib.com>

<http://www.404manual.com>

<http://www.luxmanual.com>

<http://aubethermostatmanual.com>

Golf course search by state

<http://golfingnear.com>

Email search by domain

<http://emailbydomain.com>

Auto manuals search

<http://auto.somanuals.com>

TV manuals search

<http://tv.somanuals.com>