

Acer Aspire 1710 Series

User's Guide

Copyright © 2004
All Rights Reserved

Acer Aspire 1710 Series Notebook Computer User's Guide
Original Issue: February 2004

Changes may be made periodically to the information in this publication without obligation to notify any person of such revision or changes. Such changes will be incorporated in new editions of this manual or supplementary documents and publications. This company makes no representations or warranties, either expressed or implied, with respect to the contents hereof and specifically disclaims the implied warranties of merchantability or fitness for a particular purpose.

Record the model number, serial number, purchase date, and place of purchase information in the space provided below. The serial number and model number are recorded on the label affixed to your computer. All correspondence concerning your unit should include the serial number, model number, and purchase information.

No part of this publication may be reproduced, stored in a retrieval system, or transmitted, in any form or by any means, electronic, mechanical, photocopy, recording, or otherwise, without the prior written permission of Acer Incorporated.

Acer Aspire 1710 Series Notebook Computer

Model Number : _____

Serial Number: _____

Purchase Date: _____

Place of Purchase: _____

All trademarks and registered trademarks are the properties of their respective companies.

Contents

First things first	vii
Your guides	vii
Basic care and tips for using your computer	vii
Getting familiar with your computer	1
A tour of your computer	3
Opened front view	3
Closed front view	5
Left view	6
Right view	7
Rear view	8
Bottom view	9
Features	10
Display	12
Indicators	13
Keyboard	15
Special keys	15
Keyboard ergonomics	19
Touchpad	20
Touchpad basics	20
Launch keys	22
Storage	23
Ejecting the optical drive tray	23
Emergency ejection of the optical drive tray	24
Connectivity options	25
Ethernet and LAN	25
Fax/data modem	25
Audio	27
Audio DJ	28
Securing your computer	30
Security slot	30
Passwords	31
Operating on battery power	33
Battery pack (optional)	35
Battery pack characteristics	35
Installing and removing the battery pack	36
Charging the battery	38
Checking the battery level	38
Optimizing battery life	38
Battery-low warning	39
Power management	40

Peripherals and options	41
External display devices	43
External keyboard	44
External keypad	44
External pointing device	44
Printer	45
Audio devices	45
Expansion devices	46
PC Card	46
USB devices	47
Miscellaneous options	48
Installing new components	49
Opening the case	49
CPU upgrade	50
Hard disk upgrade	51
Memory upgrade	52
Moving with your computer	55
Disconnecting from the desktop	57
Moving around	58
Preparing the computer	58
What to bring to short meetings	58
What to bring to long meetings	58
Taking the computer home	59
Preparing the computer	59
What to bring with you	59
Special considerations	59
Setting up a home office	60
Traveling with the computer	61
Preparing the computer	61
What to take with you	61
Special considerations	61
Traveling internationally with your computer	62
Preparing the computer	62
What to take with you	62
Special considerations	62
Software	63
System software	65
Launch Manager	65
BIOS setup utility	66

Troubleshooting	67
Frequently asked questions	69
Appendix A Specifications	73
Appendix B Regulation & safety notices	79
Index	93

First things first

Your guides

A set of guides is provided to help you set up and use your Aspire computer.:



The *Just for starters...* poster shows you how to set up your computer.



This *User's Guide* provides clear and concise information on using your computer productively. You are advised to read it thoroughly and keep it handy for future reference.

For more information on our products, services, and support, please visit our web site www.global.acer.com.

Basic care and tips for using your computer

Turning your computer on and off

To turn on your computer, open the lid and press the power button above the keyboard.

To turn the power off, you can do any of the following:

- Click on the Start button in Windows, and then select Shut Down on the popup menu.
- Push the power button.

To use this method, you must first click on the Power Management icon in Windows Control Panel, and then check that the power button is set to shut down the computer when pressed. See Windows Help for more information.



Note: If you are unable to shut down the computer in the usual way, press and hold the power switch for more than four seconds. You should then wait at least two seconds before turning the computer on again.

Taking care of your computer

Your computer will serve you well if you take care of it.

- Do not expose the computer to direct sunlight. Do not place it near sources of heat, such as a radiator.
- Do not expose the computer to temperatures below 0°C (32°F), or above 50°C (122°F).
- Do not expose the computer to magnetic fields.
- Do not expose the computer to rain or moisture.
- Do not spill water or any liquid on the computer.
- Do not subject the computer to heavy shock or vibration.
- Do not expose the computer to dust or dirt.
- Do not place objects on top of the computer.
- Do not slam the lid shut. Close the computer gently.
- Do not place the computer on unstable or uneven surfaces.

Taking care of your AC adapter

It is important that you look after your AC adapter.

- Do not connect the adapter to any other device.
- Do not step on the power cord or place heavy objects on it. Route the power cord away from areas where people might walk on it or trip over it.
- Do not pull on the power cord when disconnecting from the mains power socket. Grasp and pull the plug instead.
- The total ampere ratings of equipment plugged into a power strip should not exceed the ampere rating for that power strip.

Taking care of your battery pack (optional)

It is also important that you look after your computer's battery pack.

- Use the correct battery model for your computer. Do not use other kinds of batteries.
- Turn the power off before removing or replacing the battery.
- Do not tamper with the battery. Keep the battery away from children.
- Dispose of batteries according to local regulations. Recycle if possible.

Cleaning and servicing

When cleaning your computer, it is important that you follow these steps:

- 1 Turn off the computer and remove the battery.
- 2 Disconnect the AC adapter.
- 3 Clean with a soft cloth moistened with a little water. Do not use liquid or aerosol cleaners.

Refer to the chapter entitled "Frequently asked questions" on page 69 if any of the following occurs:

- You drop the computer or damage the case.
- You spill liquid on the computer.
- The computer does not operate normally.

Getting familiar with your computer

Your Aspire 1710 series computer combines solid performance, versatility, multimedia capabilities and portability with a stylish design. Increase your productivity by working wherever you are.

This chapter provides an in-depth "tour" of your computer's features.

A tour of your computer

After setting up your new Aspire computer, as illustrated in the *Just for starters...* poster, take a few minutes to explore the unit.

Opened front view



#	Item	Description
1	Display	Large liquid crystal display (LCD) provides visual output.
2	Power button	Turns the computer on and off.
3	Keyboard	Full-size keyboard for inputting typed data.
4	Touchpad	Touch sensitive pad that functions like a computer mouse.

#	Item	Description
5	Click buttons & scroll key	Right and left buttons that provide the same functions as the buttons on a computer mouse. The scroll key scrolls the contents of a window up and down.
6	Audio DJ controls and indicator	Button and indicators for the Audio DJ function. For more information, see "Audio" on page 27.
7	Palm rest	Provides a comfortable platform for your hands when typing on the keyboard.
8	Launch keys	1 switch button for wired/wireless LAN, or Bluetooth (optional) 1 e-mail launch button 1 launch button for Internet browser 2 programmable buttons
9	Status indicators	Light emitting diodes (LEDs) that show the status of the computer and its components.



Note: This wireless communication button works for models with 802.11g & 802.11a/g wireless LAN only.

Closed front view



#	Item	Description
1	Speakers	Left and right speakers deliver stereo audio output.
2	Wireless communication indicator	Lights when the Wireless LAN, or Bluetooth, capability is enabled.
3	Power indicator	Lights when the computer is on.



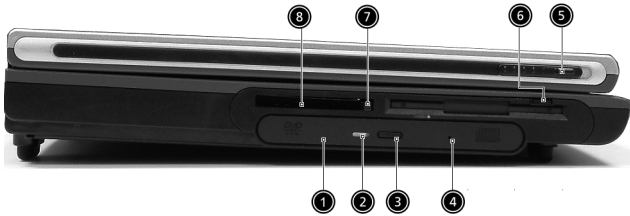

Left view



#	Item	Description
1	Optical drive	Depending on your model, the optical drive is one of the following: <ul style="list-style-type: none"> • DVD/CD-RW combo drive for reading CDs and DVDs, and writing to CD-Rs and CD-RWs. • DVD Dual
2	Optical disc read indicator	Light emitting diode (LED) that indicates when an optical disc is being read.
3	Optical drive eject button	Press the eject button to remove a disc from the optical drive.
4	Optical drive emergency eject hole	Used to eject an optical disc when the computer is turned off.
5	Left latch	Locks and releases the lid (one on the right and one on the left).
6	Floppy drive/Card reader	Accepts a 3.5 inch floppy disk, or a 6-in-1 card reader (optional).
7	PC card eject button	Press the eject button to remove a PC card from the PC card slot.
8	PC card slot	The slot supports a standard Type II PC card (PCMCIA and CardBus).







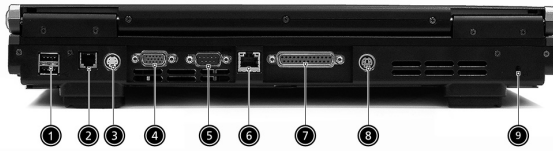

Right view



#	Item	Description
1	Right latch	Locks and releases the lid (one on the right and one on the left).
2	Speaker/Headphone-out jack 	Connects to audio line-out devices (e.g., speakers, headphones).
3	Line-in/Mic-in jack 	Accepts audio line-in devices (e.g., audio CD player, stereo walkman). Selection is through the OS Windows mixer.
4	IEEE 1394 port 	Connects to an IEEE 1394 device.
5	IEEE 1394 port 	Connects to an IEEE 1394 device.
6	Two USB ports 	Connects USB 2.0 devices.
7	DC-in jack	Connects the AC adapter.

Rear view



#	Item	Description
1	Two USB ports 	Connects USB 2.0 devices.
2	Modem jack 	Connects the built-in fax/data modem to a phone line.
3	S-video 	Connects to a television or display device with S-video input.
4	External display port 	Connects an external (VGA) display devices monitor.
5	COM port	Connects to other serial interface devices.
6	Network jack 	Connects to an Ethernet 10/100/1000-based network.
7	Parallel port 	Connects a parallel device, such as a printer.
8	PS2 port 	Connects to a PS2 mouse.
9	Kensington lock slot 	Attaches a security connector.

Bottom view

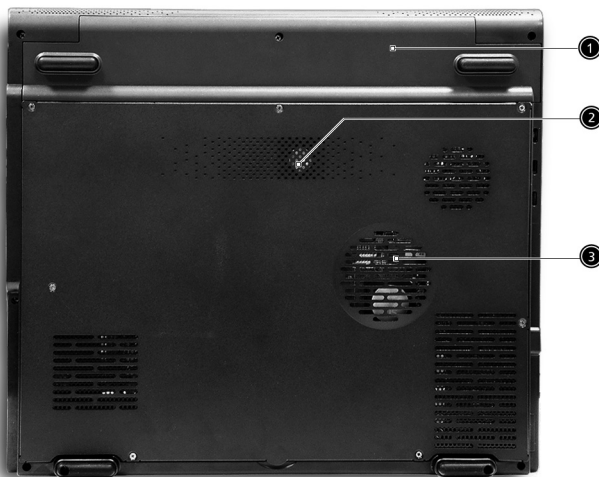

#	Item	Description
1	Battery cover	Protects the battery bay.
2	Sub-woofer	Enhances the audio quality.
3	Ventilation slots	Enable the computer to stay cool, even after prolonged use.

Features

Performance

- Intel® Pentium® 4 FSB 800 processor
- L2 cache 1MB
- Intel 865G with ICH-5, support 800MHz Front Side Bus , dual channel and HTT support
- 80 GB or higher-capacity Desktop 5400rpm, 7200rpm HDD
- Microsoft® Windows® XP Home/Pro operating system
- Optional 6-in-1 Multimedia memory card reader module

Multimedia

- DVD/CD-RW combo
- DVD Dual drive
- Audio input and output jacks
- Optional 6-in-1 Multimedia memory card reader module
- Hardware 3D graphic engine
- Two stereo speakers + one sub-woofer
- 17" Desktop SXGA LCD, 1280x1024, 16M colors

Connectivity

- Modem: Software Modem V.92 56Kbps (MDC)
- 10/100/1000 Mbps Gigabit Ethernet LAN
- Optional Mini-PCI 802.11g or 802.11 a/g
- One switch to enable or disable wireless function
- Keyboard and pointing device
- Four universal serial bus (USB) ports 2.0
- Two IEEE 1394 ports
- Bluetooth ready (manufacturing option)

Human-centric design and ergonomics

- All-in-one design (incorporating hard drive, optical drive and floppy disk drive)
- Rugged and space saving
- Full-size desktop keyboard
- No need to turn on the system for playing CD or MP3
- Large & comfortable palm rest area with well-positioned touchpad

Expansion

- PC card slot enabling a range of add-on options
- Upgradeable CPU, hard disk and memory modules

Display

The 17" display panel provides a large viewing area for maximum efficiency and ease-of-use. The liquid crystal display (LCD) supports SXGA resolution with 16 million colors at 1280 x 1024 .

Video performance

Your Aspire 1710 series computer features an accelerated graphics port (AGP) video system with Intel 865G embedded VGA engine and 64MB UMA RAM, and nVIDIA NV-34M/NV-36M series (64MB/128MB AGP card) as an option. This provides a robust solution, while enabling high quality video output.

Simultaneous display

Your computer's large display, combined with its multimedia capabilities, makes it ideally suited to delivering presentations.

You can also connect an external monitor or projector, and then choose to use the computer's LCD panel only, the external device only, or the LCD panel and external device simultaneously.



Simultaneous display allows you to manage a presentation on your computer, while your audience watches the monitor or projector screen.



Indicators

Your computer provides an array of five indicators located above the keyboard, in addition to two indicators positioned at the top right hand corner of the LCD panel. These indicators show the status of the computer and its components.





The five indicators located above the keyboard provide the following status information:

#	Description
1	 Hard disk drive activity
2	 Battery charge: Green--the AC adapter is connected and the battery is fully charged. Amber--the AC adapter is connected and the battery is charging. Off--the AC adapter is not connected, or the battery is not installed.

#	Description
3	 Caps Lock activity
4	 Num Lock activity Note: The keypad lock must be turned on to use the embedded numeric keypad.
5	 Scroll Lock activity

The two indicators located at the front of the unit provide the following status information:

#	Description
1	 Power mode: Steady green--the computer is on (even if the display is turned off). Steady orange--the computer is in standby mode. Off--the computer is turned off, or in the hibernation mode.
2	 InviLink indicator: Indicates status of wireless or Bluetooth (optional) communications. Orange--WLAN Blue--Bluetooth

Keyboard

The keyboard features full-size keys with an embedded keypad, separate cursor control keys, two Windows keys, and twelve function keys (hot keys).

Special keys

Lock keys











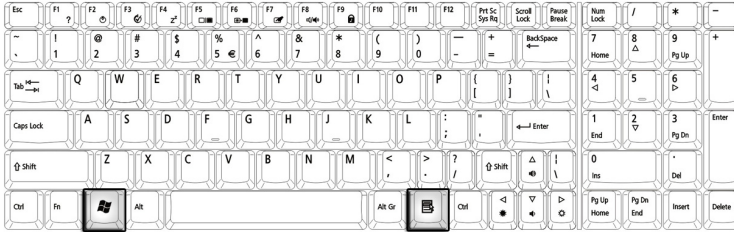

The computer features three lock keys, each with its own status indicator light.

Lock Key	Description
Caps Lock	When Caps Lock is on, all alphabetic characters are typed in uppercase. Toggle on and off by pressing the Caps Lock key on the left side of the keyboard.
Num Lock	When Num Lock is on, the embedded numeric keypad can be used. Toggle on and off by pressing the Num Lock Key.
Scroll Lock	When Scroll Lock is on, the screen toggles up or down one line at a time when the up and down cursor control keys are pressed. Note: Scroll Lock doesn't work in all applications. Toggle on and off by pressing the Scroll Lock Key.

Windows keys

The keyboard features two keys that provide Windows-specific functions.



Key	Description
<p>Windows key</p> 	<p>Pressed alone, this key has the same effect as clicking on the Windows Start button; it launches the Start menu. It can also be used with other keys to provide a variety of functions:</p> <ul style="list-style-type: none">  + Tab activates the next Task bar button.  + E opens the My Computer window.  + F1 opens Help and Support.  + F opens the Find: All Files dialog box.  + M minimizes all windows. Shift +  + M undoes the minimize all windows ( + M) action.  + R opens the Run dialog box.
Application key	This key has the same effect as clicking the right mouse button; it opens the application's context menu.

Hotkeys

Using the Fn key with another key creates a hot key, providing a quick and convenient method for controlling various functions.

To use a hot key, first hold down the Fn key. Next, press the second key in the combination. Finally, release both keys.



Your computer provides the following hot keys:

HotKey		Function
Fn + F1	Hot key help	Displays the help file.
Fn + F2	Device Manager	Accesses Windows Device Manager.
Fn + F3	Power scheme toggle	Selects suitable power scheme to the system.
Fn + F4	Sleep	Puts the computer in Sleep Mode, which can be defined via the advanced section of the Power Management Properties in the Windows Control Panel.
Fn + F5	Display toggle	Switches display output between the system LCD, an external monitor and both the system LCD and external monitor. Note: UMA sku should use Ctrl+Alt+F1 Intel international hot key, when LCD monitor is hot plugged.

HotKey		Function
Fn + F6	Screen blank	Turns the LCD backlight off to save power; press any key to resume.
Fn + F7	Touchpad on/off	Turns the internal touchpad on and off.
Fn + F8	Speaker on/off	Turns the speakers on and off.
Fn + F9	Audio DJ on/off	Turns the Audio DJ function on and off within Windows.
Fn + →	Brightness up	Increases the screen brightness.
Fn + ←	Brightness down	Decreases the screen brightness.
Fn + ↑	Volume up	Increases the volume.
Fn + ↓	Volume down	Decreases the volume.
Fn + Pg Up	Home	Moves the cursor to the beginning of a sentence.
Fn + Pg Dn	End	Moves the cursor to the end of a sentence.

Euro key

Your computer supports the new Euro currency character. First, hold down the Alt Gr key, and then press the Euro key.



Keyboard ergonomics

The wide palm rest area provides a comfortable platform for your hands when typing on the keyboard. The ergonomic design enables you to adopt a relaxed, yet very efficient, typing style.

Touchpad

The built-in touchpad is a PS/2- compatible pointing device that senses movement on its surface. The cursor responds to your finger movements on the touchpad. In addition, the two click buttons provide the same functionality as a computer mouse, while the scroll key enables easy up and down scrolling in documents and web pages.

The touchpad is located in the middle of the palm rest area, providing maximum comfort and efficiency.



Touchpad basics

Use the touchpad as follows:

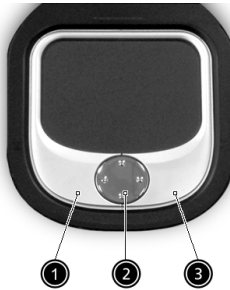

- Slide your finger over the surface of the touchpad to control the movement of the cursor. Tap the touchpad to perform selection and execution functions.
- Press the left (1) and right (3) click buttons to perform selection and execution functions, just as you would use the buttons on a computer mouse.

- Use the scroll key (2) to scroll through long documents and web pages. Press the top of the key to scroll up, and the bottom to scroll down.

Function	Left Button	Right Button	Tap
Execute	Click twice quickly.		Tap twice quickly.
Select	Click once.		Tap once.
Drag	Click and hold. Then, slide your finger across the touchpad to drag the cursor over the selection.		Tap twice quickly. On the second tap, slide your finger across the touchpad to drag the cursor over the selection.
Access content menu		Click once.	



.....

Note: Keep your fingers, as well as the surface of the touchpad, clean and dry. The touchpad is sensitive to your finger movements: the lighter your touch, the better the response. Tapping hard will not increase the touchpad's responsiveness.

Launch keys

Located at the top of the keyboard are five buttons. These buttons are called launch keys. They are designated as key 1, key 2, key 3, key 4 and key 5. By default, key 1 is used to launch wireless LAN, key 2 is used to launch the E-mail application, and key 3 is used to launch the Internet browser. Keys 4 and 5 start the Launch Manager application. All five launch keys can be set by the user. To set the launch keys, run the Acer Launch Manager.



Launch key	Default application
InviLink button 	Enables or disables wireless or Bluetooth (optional) connectivity.
E-mail	Launches your E-mail application.
Web browser	Launches your Internet browser.
P1	User-programmable
P2	User-programmable

Storage

Your computer's all-in-one design offers a variety of data storage options:

- The high capacity Enhanced-IDE hard disk drive.
The hard drive is upgradeable, enabling you to increase your storage capacity in the future. Consult your dealer if you need to upgrade.
- The high speed optical drive.
Depending on your model, you have a DVD/CD-RW combo drive or DVD dual drive. The optical drive provides increased storage capacity, as well as offering a host of multimedia possibilities.

See the section entitled, "A tour of your computer," for the locations of these drives.

Ejecting the optical drive tray

To eject the optical drive tray:

- With the computer turned on, press the optical drive eject button.
- The tray will be released, and partially pop open.
- Gently pull the tray out to its limit.



To load an optical disc:

- Place a CD or DVD on the open tray. Align the disc's center hole with the tray's spindle.
- Gently push down on the disc until it clicks in place on the spindle.
- Gently push in the tray until it clicks closed.

Emergency ejection of the optical drive tray

If you need to eject the optical drive tray when the computer is turned off, push a straightened paper clip into the optical drive emergency eject hole. The tray will be released, and partially pop open.



Connectivity options

Your computer has built-in connectivity options, enabling you to hook up to a network or communicate over a phone line.

Ethernet and LAN

The integrated network feature allows you to connect your computer to an Ethernet-based (10/100/1000 Mbps) network.

To use the network feature, plug an Ethernet cable into your computer's network jack, and then connect the other end to a network jack or hub on your network.



See Windows Help for information on setting up a network connection.

Fax/data modem

Your computer features a software modem (V.92 56Kbps), enabling you to communicate over a phone line. This means that you can connect to the Internet via a dialup account with an ISP, log in to your network from a remote location, or send faxes.



.....
Warning: Your modem is not compatible with digital phone lines. Plugging the computer into a digital phone system will damage the modem.

To use the fax/data modem, plug a phone cable into your computer's modem jack, and then connect the other end to a telephone jack.



Audio

Your computer includes an integrated stereo audio system. Built-in stereo speakers and a sub woofer are located at the front of the unit.



Volume is adjusted using software, such as Volume Control in Windows, or any other application that provides a volume adjustment control.

Two audio ports on the right side of the computer enable external devices to be connected. See "A tour of your computer" on page 3 for the location of the audio ports. For information on connecting external devices, See "Audio devices" on page 45.

Audio DJ

Audio DJ offers all the convenience of an audio CD/MP3 player, enabling you to play your favorite music CDs or "My MP3" folder from the HDD even when your computer is in power-off mode.

Operate Audio DJ as follows:

- Press "Play" button to turn on the audio function.
- Press both "Volume Up" & "Volume Down" buttons at the same time to select the "My MP3" folder from HDD.
- Press the Stop/Eject button, and then load a CD into the CD/DVD drive. Push the drawer to close it.
- Press the Play/Pause button to start playing the CD or the selected MP3.
- Use the other buttons to control the playback of the CD or MP3.
- Audio DJ can be shut down by:
 - pressing the system power button, or
 - pressing the Stop/Eject button to end playback; when inactive for 5 minutes, the system will power down automatically

Audio DJ features the following control buttons

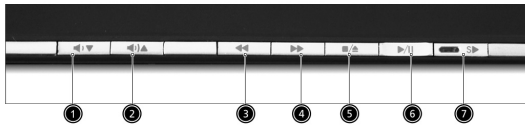

No.	Description
1	Volume Down
2	Volume Up
3	Previous Track
4	Next Track
5	Stop/Eject
6	Play/Pause
7	Shuffle On/Shuffle Off

Securing your computer

Your computer features hardware and software security solutions, in the form of a slot for a Kensington lock and a password facility.

Security slot

A slot for a Kensington slot enables you to physically protect your computer from theft. Use this feature as follows:

- Wrap a security lock cable around a heavy or immovable object, such as a drawer handle on a file cabinet, or a table leg.
- Insert the lock into the slot on the computer, turn it 90°, and then lock it in place.



Passwords

You can protect your computer from unauthorized access by setting Windows password protection. The user must enter the password before beginning a Windows session.

- First, open User Accounts in Windows Control Panel and select your account.
- Click Create a Password, and then set your desired password.
- Click Performance and Maintenance, Power Options in Control Panel.
- On the Advanced tab, select the option to prompt for a password when your computer resumes from stand by.

To cancel password protection, reset the password with a blank password.

Operating on battery power

Your Aspire 1710 series computer operates on battery or AC power.

This chapter provides information for operating on battery power, as well as information on how your computer manages and saves power.

Battery pack (optional)

Your computer uses a re-chargeable 12-cell Li-ion 2.2Ah battery pack.

Battery pack characteristics

The battery pack has the following characteristics:

- Employs current battery technology standards.
- Delivers a battery-low warning.

A Li-ion battery can be recharged at any time.

The battery is recharged whenever you connect the computer to the mains power supply. Your computer supports charge-in-use, enabling you to recharge the battery while you continue to operate the computer. However, recharging with the computer turned off results in a significantly faster charge time.

The battery will come in handy when you travel or during a power failure. It is advisable to have an extra fully charged battery pack available as backup. Contact your dealer for details on ordering a spare battery pack.

Maximizing the battery's life

Like all other batteries, your computer's battery will degrade over time. This means that the battery's performance will diminish with time and use. To maximize your battery's life, you are advised to adhere to the recommendations set out below.

Conditioning a new battery pack

Before you use a battery pack for the first time, there is a "conditioning" process that you should follow:

- 1 Insert the new battery in the computer. Do not turn the computer on.
- 2 Connect the AC adapter and fully charge the battery.
- 3 Disconnect the AC adapter.
- 4 Turn on the computer and operate using battery power.
- 5 Fully deplete the battery until the battery-low warning appears.

6 Reconnect the AC adapter and fully charge the battery again.

Follow these steps again until the battery has been charged and discharged three times.

Use this conditioning process for all new batteries, or if a battery hasn't been used for a long time. If the computer is to be stored for more than two weeks, you are advised to remove the battery pack from the unit.



Warning: Do not expose battery packs to temperatures below 0°C (32°F) or above 60°C (140°F). Extreme temperatures may adversely affect the battery pack.

By following the battery conditioning process you condition your battery to accept the maximum possible charge. Failure to follow this procedure will prevent you from obtaining the maximum battery charge, and will also shorten the effective life span of the battery.

In addition, the useful life span of the battery is adversely affected by the following usage patterns:

- Using the computer on constant AC power with the battery inserted. If you want to use constant AC power, you are advised to remove the battery pack after it is fully charged.
- Not discharging and recharging the battery to its extremes, as described above.
- Frequent use; the more you use the battery, the faster it will reach the end of its effective life. A standard computer battery has a life span of about 500 charges.

Installing and removing the battery pack



Important! Before removing the battery from the unit, connect the AC adapter if you want to continue using your computer. Otherwise, turn off the computer first.

To install a battery pack:

Please refer to "Opening the case" on page 49 before you proceed to next step.



- 1 Loosen the screws on the battery cover and remove it from the battery bay.
- 2 Align the battery to the battery bay and tighten the screws.

To remove a battery pack:

- 1 Refer to "Opening the case" on page 49.
- 2 Loosen the battery screws.
- 3 Pull the battery from the battery bay.

Charging the battery

To charge the battery, first make sure that it is correctly installed in the battery bay. Plug the AC adapter into the computer, and connect to a mains power outlet. You can continue to operate your computer on AC power while your battery is charging. However, charging the battery with the computer turned off results in a significantly faster charge time.



Note: You are advised to charge the battery before retiring for the day. Allowing the battery to charge overnight before traveling enables you to start the next day with a fully charged battery.

Checking the battery level

The Windows Power Meter indicates the current battery level. Rest the cursor over the battery/power icon on the task bar to see the battery's present charge level.

Optimizing battery life

Optimizing battery life helps you get the most out of battery operation, prolonging the charge/recharge cycle and improving recharging efficiency. You are advised to follow the suggestions set out below:

- Purchase an extra battery pack.
- Use AC power whenever possible, reserving your battery for on-the-go use.
- Eject a PC card if it is not being used, as it will continue to draw power.
- Store the battery pack in a cool, dry place. The recommended temperature is 10°C to 30°C. Higher temperatures cause the battery to self-discharge faster.
- Excessive recharging decreases the battery life.
- Look after your AC adapter and battery. See, "Taking care of your AC adapter".

Battery-low warning

When using battery power pay attention to the Windows Power Meter.



Warning: Connect the AC adapter as soon as possible after the battery-low warning appears. Data will be lost if the battery to become fully depleted and the computer shuts down.

When the battery-low warning appears, the recommended course of action depends on your situation:

Situation	Recommended Action
The AC adapter and a power outlet are available.	<ol style="list-style-type: none"> 1. Plug the AC adapter into the computer, and then connect to the mains power supply. 2. Save all necessary files. 3. Resume work. <p>Turn off the computer if you want to recharge the battery rapidly.</p>
An extra fully charged battery pack is available.	<ol style="list-style-type: none"> 1. Save all necessary files. 2. Close all applications. 3. Shut down the operating system to turn off the computer. 4. Replace the battery pack. 5. Turn on the computer and resume work.
The AC adapter or a power outlet is unavailable. You have no spare battery pack.	<ol style="list-style-type: none"> 1. Save all necessary files. 2. Close all applications. 3. Shut down the operating system to turn off the computer.

Power management

Your computer features a built-in power management unit that constantly monitors system activity. System activity refers to any activity involving one or more of the following devices: keyboard, touchpad/mouse, floppy disk drive, hard disk drive, optical drive, peripherals connected to the computer. If no activity is detected for a period of time (the settings are controlled in Windows Power Management), the computer turns off some, or all, of these devices in order to conserve power.

Your computer employs a power management scheme that supports ACPI (Advanced Configuration and Power Interface), enabling maximum power conservation without compromising system performance. ACPI allows Windows to control the amount of power given to each device attached to the computer. In this way, Windows handles all power-saving chores for your computer. Refer to Windows Help for more information.

Peripherals and options

Your Aspire 1710 series an expandable desktop replacement.

This chapter provides information on connecting peripherals to expand your system and upgrading key components to enhance system performance and keep your computer in step with the latest technology.

You are advised to consult your dealer for information on peripherals. In addition, make sure that you read the manuals and other documentation provided with new hardware.

External display devices

You can connect an external (VGA) monitor or projector to your computer's external display port. See the section entitled "Display" for information on using the computer's simultaneous display and multi-display features.

Use the Fn + F5 hot key to toggle the display setting between the computer's LCD panel and the external display device. See "Hotkeys" for more information.



.....
Note: UMA sku should use Ctrl+Alt+F1 Intel international hot key, when LCD monitor is hot plugged.

External input devices

You can connect a variety of input devices to your computer's USB ports, providing increased functionality and greater ease-of-use. In addition, the USB ports can be used to connect many other peripheral devices, such as digital cameras, printers and scanners. See "Expansion devices" for more information on connecting USB devices.



External keyboard

Your computer features a full-size keyboard. However, if you prefer, you can connect an external keyboard to one of your computer's USB ports. This enables you to enjoy the comfort and added features of a full-size desktop system keyboard when inputting typed data on your computer.

External keypad

Your computer features an embedded keypad that, when combined with the Num Lock feature, enables you to easily input typed numeric data. Alternatively, you can connect a 17-key numeric keypad to one of your computer's USB ports. This enables you to enjoy the benefits of a numeric keypad while leaving your keyboard configured for text entry.

External pointing device

Your computer features a sensitive touchpad pointing device with two click buttons and a scroll key. However, if you prefer to use a conventional mouse or other pointing device, you can connect it to one of your computer's USB ports.

Printer

Your computer supports both parallel and USB printers.

Refer to the printer's manual for information on:

- Setting up the hardware
- Installing the necessary drivers in Windows
- Operating instructions

To use a USB printer, simply connect the device to one of your computer's USB ports, and then wait for Windows to find the new hardware.

To connect a parallel printer, first shut down the operating system. Connect the printer to the parallel port, and then restart the computer. Wait for Windows to find the new hardware.

Audio devices

Your computer offers built-in stereo speakers. See the section entitled "Audio" for more information on these features. However, in addition to the integrated devices, the two audio ports on the right side of the unit enable you to connect external audio input and output devices.

You can plug an external microphone into your computer's microphone-in jack. This offers the convenience of greater freedom of movement, as well as improved audio input quality.

Connect headphones to the headphone jack for private listening and improved audio output quality.

Expansion devices

PC Card

Your computer features a PC card slot that supports a standard Type II PC card (PCMCIA or CardBus). This greatly increases your computer's usability and expandability. A variety of PC cards are available, such as flash memory, fax/data modem, LAN, and SCSI cards. Consult your dealer for information on PC card options for your computer.



.....
Note: Refer to the documentation provided with your PC card for details about installation and use.

To insert a PC card:

- 1 Align the card with your computer's PC card slot. Make sure that the edge with the connectors is facing the slot, and that the card is the right (label) side up. Most cards are marked with an arrow to help you insert them correctly.
- 2 Slide the card into the slot, and then push gently until the card connects.
- 3 If necessary, connect the card's cable to the jack on the outer edge of the card.
- 4 Windows will automatically detect the card's presence.



To remove a PC card:

- 1 Close any applications using the PC card.
- 2 Double click on the PC card icon on the task bar, and then select the option to safely remove the card. Wait for the message telling you that it is now safe to remove the card.
- 3 Press the PC card eject button to partially eject the card from the slot.
- 4 Remove the card from the slot.

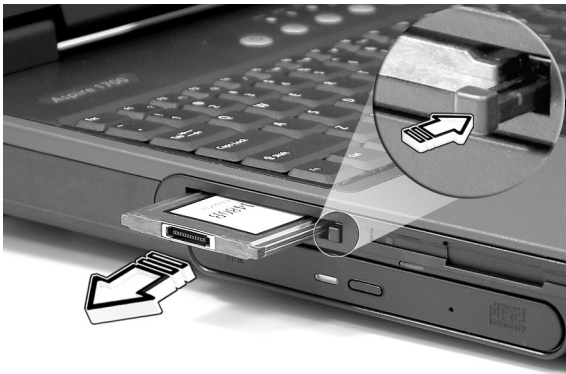

USB devices

Your computer features four USB (Universal Serial Bus) ports for connecting a range of USB peripherals. See "External display devices" and "Printer" for information on connecting a USB keyboard, keypad, mouse or printer. Other common USB devices include digital cameras, scanners, and external storage devices.

USB is plug and play, which means that you can connect and start using a USB device without having to restart your computer. You can also disconnect the device at any time.

A further advantage of USB is the ability to use USB hubs. This means that several devices can share a USB port simultaneously.

Miscellaneous options

Battery pack

It is a good idea to have a battery, especially when you travel with your computer. This greatly increases your productive range when you are on the move.

AC adapter

Having a spare AC adapter allows you to keep one in two different places. For example, you could have one AC adapter at home and another at work. This means that you don't have to carry an AC adapter when traveling between your two base locations.

Installing new components

Make sure you only use components that are compatible with your Aspire computer. Consult your dealer regarding compatibility of new components before you purchase them.

To ensure proper installation, refer to the documentation provided with new components before you start to add or replace components. Possible upgrade options include the following:

- Replace the HDD with a higher capacity model.
- Install additional memory.
- CPU upgrade.
- Replace the CD drive with the optical drives.

Opening the case

Before you open the case, turn your computer off and unplug the power cord from the wall outlet or the battery.

- a) Turn the computer over to access the panel on the bottom of the unit. Loosen the seven screws on the bottom panel.
- b) Lift the bottom panel off.

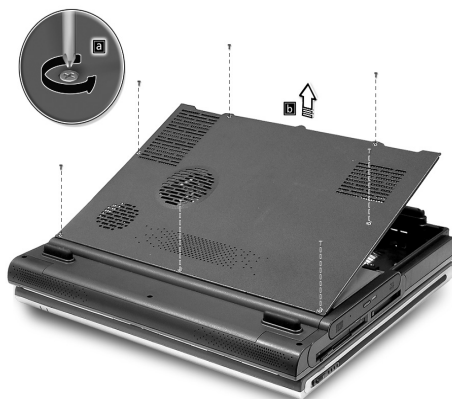

CPU upgrade



Caution! A microprocessor and heat sink may be hot if the system has been running. Also, there may be sharp pins and edges on some board and chassis parts. Contact should be made with care. Consider wearing protective gloves.

After removing the bottom panel:

- a) Loosen the four screws in the air baffle/heat sink assembly.

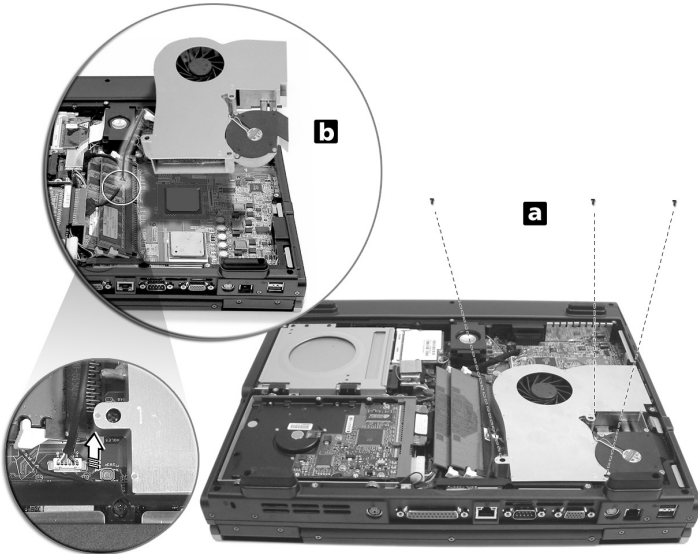

- b) Unplug the air baffle power connector from the system main board and remove the air baffle/heat sink assembly to expose the CPU socket.

To install a new processor

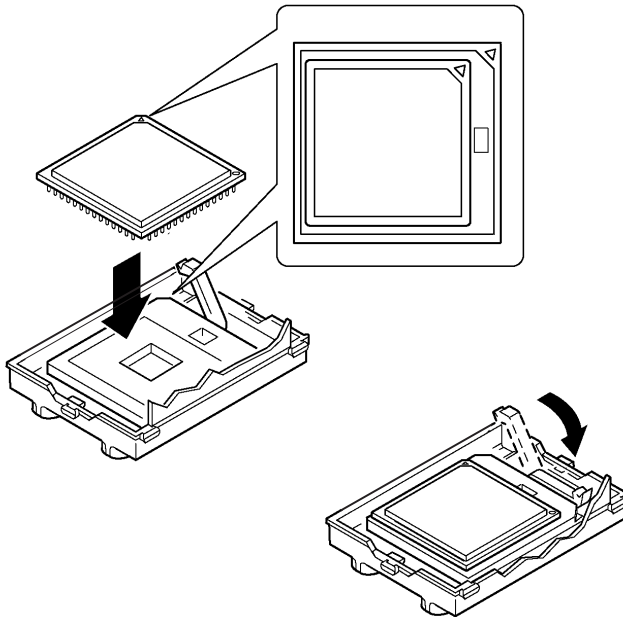

- 1 Raise the locking bar on the socket.
- 2 Align the processor with the socket.
- 3 Orient the processor so that the triangle on the corner of the processor aligns with the triangle on the corner of the socket.
- 4 Insert the processor into the socket.



.....
Caution: Do not force the processor into the socket.

Hard disk upgrade

It is possible to replace your hard disk with a higher capacity drive when you need more storage space. Your computer uses a 3.5 inch Enhanced-IDE hard disk. Consult your dealer if you need to perform a hard disk upgrade.

Refer to "Opening the case" on page 49.

- a) Remove the four screws that hold the hard disk.
- b) Lift up the hard disk, and detach the power and hard disk cables from the hard disk.
- c) Detach the hard disk from the main board.

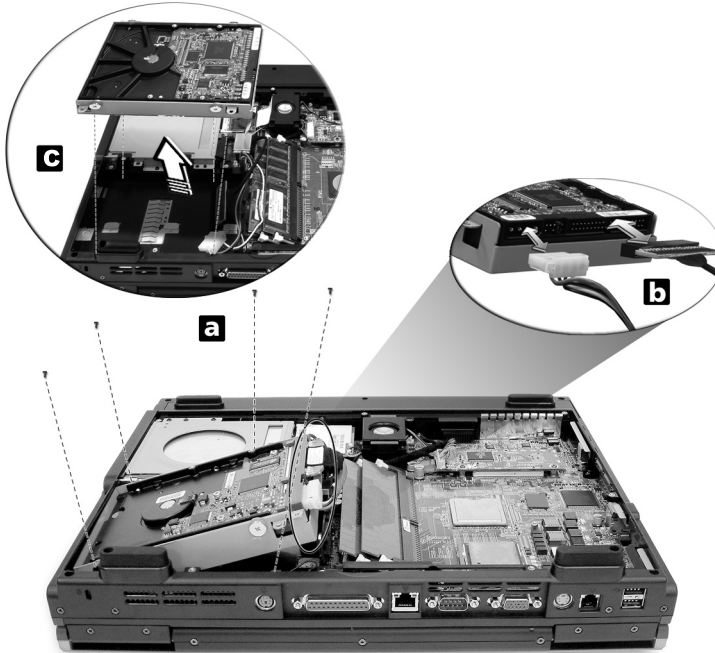

Memory upgrade

Your computer features two memory slots that accept DT DDR 333/400 DIMMs (Dual Inline Memory Modules). The memory slots support 256-MB, 512-MB and 1GB DDR SDRAM.

The memory slots are easily accessible, allowing you to upgrade your computer's memory.

To install memory:

Refer to **“Opening the case”** on page 49 and locate the **DDR DIMM socket on the main board.**

a) Align the DDR DIMM with the socket and press the DDR DIMM into the socket.

b) Press the holding clips on both sides of the DDR DIMM socket inward to lock the DDR DIMM.



Your computer automatically detects the amount of memory installed.

Run the BIOS utility to view the new value for total system memory and make a note of it.

Moving with your computer

Your Aspire 1710 series computer is ideal for taking with you when you move around.

This chapter provides tips on things to consider when traveling with your computer.

Disconnecting from the desktop

Before moving with your computer, you must turn it off and disconnect all peripherals:

- 1 Save your work and close all applications.
- 2 Shut down Windows to turn off your computer.
- 3 Unplug the AC adapter from the mains outlet, and then disconnect it from the computer.
- 4 Disconnect any external devices, such as a keyboard, mouse, or printer, that are attached to your computer.
- 5 If you are using a security lock cable, disconnect the lock from the computer.
- 6 Pack your computer in a strong, waterproof bag or case.

Moving around

Sometimes you might need to move your computer a short distance. For example, you might need to move from your office desk to a meeting room. In these situations, you don't have to shut down the operating system.

Preparing the computer

First, disconnect any peripherals that you don't want to take with you. Next close the lid, placing your computer in Standby mode. You can now safely carry it around the building with you.

When you are ready to use your computer again, open the lid and then press the power button to bring it out of Standby mode.

What to bring to short meetings

If your battery is fully charged, you probably won't need to take anything else with you to the meeting.

What to bring to long meetings

For longer meetings, take along the AC adapter. You can use mains power throughout the meeting, or you can run down your battery first, and then connect the AC adapter after receiving the battery-low warning.

If the meeting room does not have an available power outlet, reduce your computer's power consumption by putting it in Standby mode during long periods of inactivity. It is advisable to take along a spare battery if you have one.

Taking the computer home

When you move between your office and home you will need to prepare your computer for the short trip.

Preparing the computer

After disconnecting your computer from the desktop (see "Disconnecting from the desktop"), prepare the unit as follows:

- 1 Remove all media from the drives. Loaded media can damage the drive heads during transit.
- 2 Pack the computer in a protective case that is padded to guard against knocks. Make sure that the unit cannot slide around inside the case.



Caution: Avoid packing items next to the top of the computer, as this could result in damage to the screen.

What to bring with you

If you don't have spare items at home, it is advisable to take along the AC adapter and this User's Guide.

Special considerations

To protect your computer in transit, it is advisable to pay attention to the following:

- Minimize the effect of temperature changes. Keep your computer with you instead of placing it in storage holds.
- Avoid leaving your computer in a hot car.
- Changes in temperature and humidity can cause condensation to form in your computer. Before turning the computer on, allow it to return to room temperature, and then check the screen for signs of condensation. If the temperature change is greater than 10°C (18°F), allow the computer to come to room temperature slowly by placing it in a room with a temperature between the outside and room temperatures.

Setting up a home office

If you frequently work on your computer at home, as well as at work, it may be worthwhile purchasing a second AC adapter. This will allow you to travel lighter, as you can keep an AC adapter in each location.

You might also find it worthwhile keeping a second set of peripherals at home, such as a keyboard, keypad, mouse and printer.

Traveling with the computer

Sometimes you might need to make longer trips with your computer.

Preparing the computer

Prepare the computer as you would for moving between your office and home. It is advisable to make sure that the battery is fully charged. If you are traveling by air, you might be required to turn on the computer during security checks.

What to take with you

It is advisable to take the following items with you:

- AC adapter
- Spare, fully charged battery packs
- Additional printer driver files (if you plan to use another printer)
- Phone and network cables (if you plan to use the computer's modem and network connections)

Special considerations

In addition to the considerations for taking your computer home, keep the following in mind:

- Always take your computer as carry-on luggage.
- If possible, have your computer manually inspected at security checks. Although the computer can pass safely through security X-ray machines, you should never expose it to a metal detector.
- If carried separately, avoid exposing floppy disks to hand-held metal detectors.

Traveling internationally with your computer

Occasionally you might need to travel between countries with your computer.

Preparing the computer

Prepare the computer as you would for normal travel. Remember to take special precautions for air travel (see "Traveling with the computer" on page 61).

What to take with you

It is advisable to take the following items with you:

- AC adapter
- Power cords that are appropriate for the countries you plan to visit
- Spare, fully charged battery packs
- Additional printer driver files, if you plan to use another printer.
- Phone and network cables (if you plan to use the computer's modem and network connections). Check that your modem is suitable for the telephone system in the countries you plan to visit. You might have to use a PC card modem in some locations.

Special considerations

In addition to the considerations for normal travel with your computer, keep the following in mind when traveling internationally:

- Check that your power cord is suitable for the local power supply. If necessary, purchase a power cord that meets local requirements. Avoid using converter kits.
- If you plan to connect over a phone line, check that the computer's modem and your phone cord are suitable for the local phone system. If necessary, purchase a PC card modem that meets local requirements.
- If carried separately, avoid exposing floppy disks to hand-held metal detectors.

Software

Your Aspire 1710 series computer includes system utilities.

This chapter provides information on the important software that comes with your computer.

System software

Your computer comes preloaded with the following software:

- Microsoft® Windows® operating system
- Hardware BIOS setup utility
- System utilities, drivers and application software



Note: To run software applications in Windows, first click on the Start button. Next, select the appropriate folder, and then click on the application icon. To learn about the software and utility, make use of the online help provided by the software.

Launch Manager

Launch Manager allows you to set the four launch keys located above the keyboard. See “Launch keys” on page 22 for the location of the launch keys.

You can access the Launch Manager by clicking on Start, All Programs, and then Launch Manager to start the application.

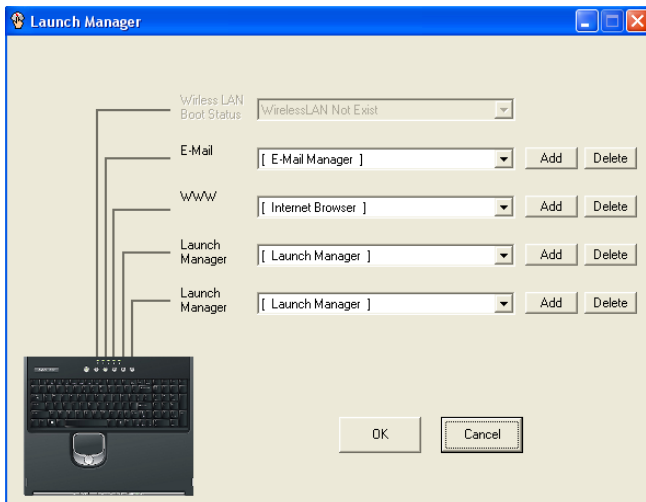

BIOS setup utility

The BIOS Utility is a hardware configuration program built into your computer's BIOS (basic input/output system).

Your computer is already properly configured and optimized, and you do not need to run this utility. However, if you encounter configuration problem, you may need to run it.

To activate the BIOS Utility, press F2 during the POST (Power-On-Self-Test) while the Aspire logo is being displayed.



Troubleshooting

This chapter instructs you on how to deal with common system problems. Please read it before calling a technician.

Solutions to more serious problems may require opening the computer. Do not attempt to open and service the computer by yourself. Contact your dealer or an authorized service center for assistance.

Frequently asked questions

This section suggests solutions to commonly encountered problems.

I press the power switch, but my computer does not start or boot-up.

Look at the Power status indicator:

- If it is not lit, no power is being delivered to the computer. Check the following:
 - If you are running on battery power, the battery may be low and unable to power the computer. Connect the AC adapter to recharge the battery pack.
 - If you are running on mains power, make sure that the AC adapter is properly plugged in to the computer and to the power outlet.
- If it is lit, check the following:
 - Make sure that there is not a non-bootable (non-system) diskette in the floppy disk drive. If so, remove the diskette or replace it with a system diskette, and then press Ctrl-Alt-Del to restart the system.
 - The operating system files may be damaged or missing. Insert the Windows startup disk, and then press Ctrl-Alt-Del to restart the system. Windows will diagnose your system and make necessary fixes.

Nothing appears on the screen.

The computer's power management system automatically blanks the screen to save power. Press any key to turn the display back on.

If pressing a key does not turn the display back on, check the following:

- The brightness level might be too low. Press Fn + → hot key to increase the screen brightness level.
- The display device might be set to an external monitor. Press the Fn + ← hot key to toggle the display setting.
- The system may be in standby mode. Try pressing the power switch to resume.

The image is not full-screen.

Make sure that the resolution is set to a resolution your system supports:

- Right click on your Windows desktop and select Properties to bring up the Display Properties dialog box. Alternatively, click on the Display icon in Control Panel.
- Click on the Settings tab to check the resolution setting. Resolutions lower than the specified resolution result in a display that is less than full-screen.

There is no audio coming from my computer.

Check the following:

- The volume may be muted. In Windows, look at the volume control icon on the taskbar. If it is crossed-out, click on the icon and deselect the Mute option.
- The volume level may be too low. In Windows, click on the volume control icon on the taskbar, and then use the slider control to increase the volume level.
- If headphones are connected to the headphone jack on the computer, your computer's built-in speakers will be turned off.

My external microphone does not work.

Check the following:

- Make sure that the external microphone is properly plugged into the microphone-in jack on the computer.
- Make sure that the volume is not muted or set too low (see the problem, "There is no audio coming from my computer").

I can't eject the optical drive tray with my computer turned off.

The computer needs to be turned on for the optical drive eject button to function. If you need to eject the optical drive tray when the computer is turned off, push a straightened paper clip into the optical drive emergency eject hole. See "Emergency ejection of the optical drive tray" on page 24 for more information.

The keyboard does not respond.

Try attaching an external USB keyboard to one of your computer's USB ports. If it works, the internal keyboard might have become disconnected. Contact your dealer or an authorized service center.

The floppy disk drive cannot read a diskette.

Check the following:

- Make sure that the diskette is properly inserted in the floppy disk drive.
- Make sure that the diskette is formatted.
- Try to read a second diskette. If this works, then the first diskette might have a problem.
- If the diskette is not the cause of the problem, then the drive head might be dirty. Clean it using a drive head cleaning kit.

The optical drive cannot read a disc.

Check the following:

- Make sure that the disc is supported by the drive. If your computer has a CD-ROM drive, it can read CDs but cannot read DVDs. If your computer has a DVD drive, it can read CDs and DVDs.
- When placing a disc in the drive tray, make sure that it is secure on the spindle of the drive tray.
- Make sure that the disc is free from scratches or smudges. If the disc is dirty, clean it using a disc cleaning kit.
- If the disc is OK, the drive head might be dirty. Clean it using a drive head cleaning kit.

The printer does not work.

Check the following:

- Make sure that the printer is connected to a power outlet and it is turned on.
- Check that the cable is properly connected to the appropriate ports on both the computer and the printer.
- If you are using a printer connected to your computer's parallel port, restart the computer. Windows needs to find the new hardware and install the necessary drivers.

I want to set up my location to use the internal modem.

Follow these steps:

- Click on Start, and then click on Control Panel.
- Double-click on Phone and Modem Options.
- In the Dialling Rules tab, begin setting up your location.

Refer to Windows Help for more information.

When the battery is 95-99% full, it won't charge to 100% capacity.

To preserve the life of the battery, the system only lets you charge the battery when its capacity falls below 95%. It is recommended that you run down the battery, and then fully recharge it.

Appendix A

Specifications

This appendix lists the general specifications of your computer.

Microprocessor

- Intel® Pentium® 4 2.6G ~ 3.4G or higher processor

Memory

- Desktop 256-MB/512-MB/1-GB DDR SDRAM, upgradeable to 2-GB with 2 slots
- Two user-upgradeable 184-pin industry-standard DIMM slots (DDR-333/400)
- 4MB Flash ROM BIOS

Data storage

- One internal floppy disk drive (3.5", 1.44 MB) (optional)
- One E-IDE hard disk (Desktop 3.5", UltraDMA-100) (optional)
- One internal optical drive
- One 6 in 1 Multimedia memory card reader (optional)

Display and video

- 17" Desktop liquid-crystal display (LCD) at 1280 x 1024 Super Graphics Array (SXGA) resolution
- Simultaneous LCD and CRT display
- Dual independent display support
- Hardware 3D graphic engine

Audio

- 16-bit stereo audio (AC'97)
- Two built-in stereo speakers
- Audio ports for microphone-in and headphones

Keyboard and pointing device

- 103-/105-/107-/109-key Windows keyboard
- Ergonomically-centered touchpad pointing device

I/O ports

- One type II PC Card slot (PCMCIA and CardBus)
- One RJ-11 modem jack (V.92, 56K)
- One RJ-45 network jack (Gigabit Ethernet)
- One DC-in jack
- One parallel port (ECP/EPP)
- One external monitor port
- Two IEEE 1394 ports
- One PS/2 port
- One microphone-in jack (3.5 mm mini jack)
- One headphone jack (3.5 mm mini jack)
- Four Universal Serial Bus (USB) ports

Weight and dimensions

- 17"-display model:
 - 6.4 kg with combo drive
 - 7.1 kg with combo drive and battery
 - 378(W) x 320(D) x 55(H) mm

Environment

- Temperature:
 - Operating: 5°C ~ 35°C
 - Non-operating: -20°C ~ 65°C
- Humidity (non-condensing):
 - Operating: 20% ~ 80% RH
 - Non-operating: 10% ~ 90% RH

Operating system

- Microsoft® Windows® XP Home/Pro

Power

- 12-cell Li-ion smart battery pack (optional)
- 180-Watt AC adapter, auto sensing 100~240V AC, 50~60Hz

Options

- 256-MB/512-MB/1-GB DDR SDRAM memory upgrade module
- Additional AC adapter
- Additional battery pack

Appendix B

Regulation & safety notices

This appendix lists the general notices for your computer.

Energy Star Guidelines Compliance

As an Energy Star Partner, Acer Inc. has determined that this product meets the Energy Star guidelines for energy efficiency.

FCC notice

This device has been tested and found to comply with the limits for a Class B digital device pursuant to Part 15 of the FCC Rules. These limits are designed to provide reasonable protection against harmful interference in a residential installation. This device generates, uses, and can radiate radio frequency energy and, if not installed and used in accordance with the instructions, may cause harmful interference to radio communications.

However, there is no guarantee that interference will not occur in a particular installation. If this device does cause harmful interference to radio or television reception, which can be determined by turning the device off and on, the user is encouraged to try to correct the interference by one or more of the following measures:

- Reorient or relocate the receiving antenna.
- Increase the separation between the device and receiver.
- Connect the device into an outlet on a circuit different from that to which the receiver is connected.
- Consult the dealer or an experienced radio/television technician for help.

Notice: Shielded cables

All connections to other computing devices must be made using shielded cables to maintain compliance with FCC regulations.

Notice: Peripheral devices

Only peripherals (input/output devices, terminals, printers, etc.) certified to comply with the Class B limits may be attached to this equipment. Operation with non-certified peripherals is likely to result in interference to radio and TV reception.

Caution

Changes or modifications not expressly approved by the manufacturer could void the user's authority, which is granted by the Federal Communications Commission, to operate this computer.

Operation conditions

This device complies with Part 15 of the FCC Rules. Operation is subject to the following two conditions: (1) this device may not cause harmful interference, and (2) this device must accept any interference received, including interference that may cause undesired operation.

Notice: Canadian users

This Class B digital apparatus meets all requirements of the Canadian Interference-Causing Equipment Regulations.

Remarque à l'intention des utilisateurs canadiens

Cet appareil numérique de la classe B respecte toutes les exigences du Règlement sur le matériel brouilleur du Canada.

Declaration of Conformity for EU countries

Hereby, Acer, declares that this Aspire 1710 series is in compliance with the essential requirements and other relevant provisions of Directive 1999/5/EC. (Please visit www.acer.com/about/certificates/nb for complete documents.)

Modem notices

Notice for USA

This equipment complies with Part 68 of the FCC rules. Located on the bottom side of the modem is a label that contains, among other information, the FCC Registration Number and Ringer Equivalence Number (REN) for this equipment. Upon request, you must provide this information to your telephone company.

If your telephone equipment causes harm to the telephone network, the telephone company may discontinue your service temporarily. If possible, they will notify you in advance. But, if advance notice is not

practical, you will be notified as soon as possible. You will also be informed of your right to file a complaint with the FCC.

Your telephone company may make changes in its facilities, equipment, operations, or procedures that could affect the proper functioning of your equipment. If they do, you will be notified in advance to give you an opportunity to maintain uninterrupted telephone service.

If this equipment should fail to operate properly, disconnect the equipment from the phone line to determine if it is causing the problem. If the problem is with the equipment, discontinue use and contact your dealer or vendor.



CAUTION: To reduce the risk of fire, use only No. 26 AWG or larger UL Listed or CSA Certified Telecommunication Line Cord.

TBR 21

This equipment has been approved [Council Decision 98/482/EC - "TBR 21"] for single terminal connection to the Public Switched Telephone Network (PSTN). However, due to differences between the individual PSTNs provided in different countries, the approval does not, of itself, give an unconditional assurance of successful operation on every PSTN termination point. In the event of problems, you should contact your equipment supplier in the first instance.

List of Applicable Countries

EU member states as of April 2003 are: Belgium, Denmark, Germany, Greece, Spain, France, Ireland, Italy, Luxembourg, the Netherlands, Austria, Portugal, Finland, Sweden, and the United Kingdom. Usage allowed in the countries of European Union, as well as Norway, Switzerland, Iceland and Liechtenstein. This device must be used in strict accordance with the regulations and constraints in the country of use. For further information, please contact local office in the country of use.

Notice for Australia

For safety reasons, only connect headsets with a telecommunications compliance label. This includes customer equipment previously labelled permitted or certified.

Important safety instructions

Read these instructions carefully. Save them for future reference.

- 1 Follow all warnings and instructions marked on the product.
- 2 Unplug this product from the wall outlet before cleaning. Do not use liquid cleaners or aerosol cleaners. Use a damp cloth for cleaning.
- 3 Do not use this product near water.
- 4 Do not place this product on an unstable cart, stand, or table. The product may fall, causing serious damage to the product.
- 5 Slots and openings are provided for ventilation; to ensure reliable operation of the product and to protect it from overheating. These openings must not be blocked or covered. The openings should never be blocked by placing the product on a bed, sofa, rug, or other similar surface. This product should never be placed near or over a radiator or heat register, or in a built-in installation unless proper ventilation is provided.
- 6 This product should be operated from the type of power indicated on the marking label. If you are not sure of the type of power available, consult your dealer or local power company.
- 7 Do not allow anything to rest on the power cord. Do not locate this product where persons will walk on the cord.
- 8 If an extension cord is used with this product, make sure that the total ampere rating of the equipment plugged into the extension cord does not exceed the extension cord ampere rating. Also, make sure that the total rating of all products plugged into the wall outlet does not exceed the fuse rating.
- 9 Never push objects of any kind into this product through cabinet slots as they may touch dangerous voltage points or short out parts that could result in a fire or electric shock. Never spill liquid of any kind on the product.
- 10 Do not attempt to service this product yourself, as opening or removing covers may expose you to dangerous voltage points or other risks. Refer all servicing to qualified service personnel.
- 11 Unplug this product from the wall outlet and refer servicing to qualified service personnel under the following conditions:
 - a When the power cord or plug is damaged or frayed.
 - b If liquid has been spilled into the product.

- c If the product has been exposed to rain or water.
 - d If the product does not operate normally when the operating instructions are followed. Adjust only those controls that are covered by the operating instructions since improper adjustment of other controls may result in damage and will often require extensive work by a qualified technician to restore the product to normal condition.
 - e If the product has been dropped or the case has been damaged.
 - f If the product exhibits a distinct change in performance, indicating a need for service.
- 12 The Aspire 1710 series uses the lithium battery, model SQU-207. Replace the battery with the same type as the product's battery we recommend. Use of another battery may present a risk of fire or explosion.
- 13 **Warning!** Batteries may explode if not handled properly. Do not disassemble or dispose of them in fire. Keep them away from children and dispose of used batteries promptly.
- 14 Use only the proper type of power supply cord set (provided in your accessories box) for this unit. It should be a detachable type: UL listed/CSA certified, type SPT-2, rated 7A 125V minimum, VDE approved or its equivalent. Maximum length is 15 feet (4.6 meters).
- 15 Always disconnect all telephone lines from the wall outlet before serving or disassembling this equipment.
- 16 Avoid using a telephone (other than a cordless type) during an electrical storm. There may be a remote risk of electric shock from lightning.

Laser compliance statement

The CD or DVD drive used with this computer is a laser product. The CD or DVD drive's classification label (shown below) is located on the drive.

CLASS 1 LASER PRODUCT

CAUTION: INVISIBLE LASER RADIATION WHEN OPEN. AVOID EXPOSURE TO BEAM.

APPAREIL A LASER DE CLASSE 1 PRODUIT

LASERATTENTION: RADIATION DU FAISCEAU LASER INVISIBLE EN CAS D'OUVERTURE. EVITER TOUTE EXPOSITION AUX RAYONS.

LUOKAN 1 LASERLAITE LASER KLASSE 1

VORSICHT: UNSICHTBARE LASERSTRAHLUNG, WENN ABDECKUNG GEÖFFNET NICHT DEM STRAHLL AUSSETZEN

PRODUCTO LÁSER DE LA CLASE I

ADVERTENCIA: RADIACIÓN LÁSER INVISIBLE AL SER ABIERTO. EVITE EXPONERSE A LOS RAYOS.

ADVARSEL: LASERSTRÅLING VEDÅBNING SE IKKE IND I STRÅLEN.

VARO! LAVATTAESSA OLET ALTTINA LASERSÄTEILYLLE.

VARNING: LASERSTRÅLNING NÅR DENNA DEL ÅR ÖPPNAD ÅLÅ TUIJOTA SÄTEESEENSTIRRA EJ IN I STRÅLEN

VARNING: LASERSTRÅLNING NAR DENNA DEL ÅR ÖPPNADSTIRRA EJ IN I STRÅLEN

ADVARSEL: LASERSTRÅLING NAR DEKSEL ÅPNESSTIRR IKKE INN I STRÅLEN

LCD pixel statement

The LCD unit is produced with high-precision manufacturing techniques. Nevertheless, some pixels may occasionally misfire or appear as black or red dots. This has no effect on the recorded image and does not constitute a malfunction.

Macrovision copyright protection notice

This product incorporates copyright protection technology that is protected by method claims of certain U.S. patents and other intellectual property rights owned by Macrovision Corporation and other rights owners. Use of this copyright protection technology must be authorized by Macrovision Corporation, and is intended for home and other limited viewing uses only unless otherwise authorized by Macrovision Corporation. Reverse engineering or disassembly is prohibited.

Apparatus Claims of U.S. Patent Nos. 4,631,603, 4,577,216, 4,819,098, and 4,907,093 licensed for limited viewing uses only.

Radio Device Regulatory Notice

Note: Below regulatory information is for models with wireless LAN and/or Bluetooth™ only.

General

This product complies with the radio frequency and safety standards of any country or region in which it has been approved for wireless use.

Depending on configurations, this product may or may not contain wireless radio devices (such as wireless LAN and/or Bluetooth™ modules). Below information is for products with such devices.

European Union (EU)

This device complies with the essential requirements of the European Council Directives listed below:

73/23/EEC Low Voltage Directive

- EN 60950

89/336/EEC Electromagnetic Compatibility (EMC) Directive

- EN 55022
- EN 55024
- EN 61000-3-2/-3

99/5/EC Radio & Telecommunications Terminal Equipment (R&TTE) Directive

- Art.3.1a) EN 60950
- Art.3.1b) EN 301 489 -1/-17
- Art.3.2) EN 300 328-2
- Art.3.2) EN 301 893 (applied to 5GHz device only)

 (for 2.4 GHz)  (for 5 GHz)

* The applicable number varies according to the different Notified Body ID No. applied to the wireless module installed in this product. These numbers are subject to change without notice.

List of Applicable Countries

EU member states as of April 2003 are: Belgium, Denmark, Germany, Greece, Spain, France, Ireland, Italy, Luxembourg, the Netherlands, Austria, Portugal, Finland, Sweden, and the United Kingdom. Usage allowed in the countries of European Union, as well as Norway, Switzerland, Iceland and Liechtenstein. This device must be used in strict accordance with the regulations and constraints in the country of use. For further information, please contact local office in the country of use.

The FCC RF safety requirement

The radiated output power of Wireless LAN Mini-PCI Card and Bluetooth card is far below the FCC radio frequency exposure limits. Nevertheless, the Aspire 1710 series shall be used in such a manner that the potential for human contact during normal operation is minimized as follows.

- 1 Users are requested to follow the RF safety instructions on wireless option devices that are included in the user's manual of each RF option device.



.....
Caution: To comply with FCC RF exposure compliance requirements, a separation distance of at least 20 cm (8 inches) must be maintained between the antenna for the integrated Wireless LAN Mini-PCI Card built in to the screen section and all persons.

Diversity antenna positions

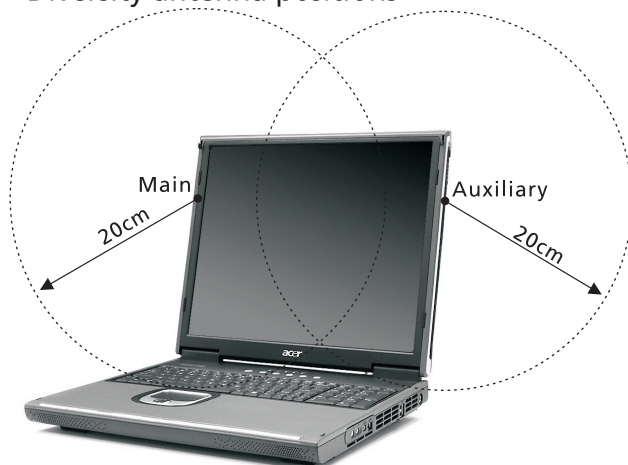

Note: Acer Dual-Band 11a/g Wireless Mini PCI Adapter implements transmission diversity function. The function does not emit radio frequencies simultaneously from both antennas. One of the antennas is selected automatically or manually (by users) to have good quality of radiocommunication.

- 2 This device is restricted to indoor use due to its operation in the 5.15 to 5.25 GHz frequency range. FCC requires this product to be used indoors for the frequency range 5.15 to 5.25 GHz to reduce the potential for harmful interference to co-channel Mobile Satellite systems.
- 3 High power radar are allocated as primary users of the 5.25 to 5.35 GHz and 5.65 to 5.85 GHz bands. These radar stations can cause interference with and/or damage this device.
- 4 An improper installation or unauthorized use may cause harmful interference to radio communications. Also any tampering of the internal antenna will void the FCC certification and your warranty.

5 Acer Integrated Bluetooth with 56K Modem.

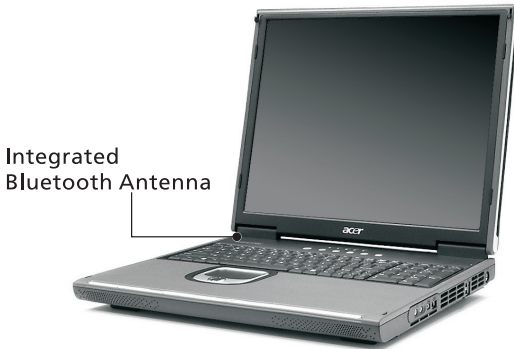

Note: The antenna of Acer Integrated Bluetooth with 56K Modem is located on the upper left-hand side, above the keyboard. Transmitted energy from the Bluetooth device is very low compared to other RF devices. Therefore, a 20 cm separation from the Bluetooth antenna is not required.

Canada - Low power license-exempt radiocommunication devices (RSS-210)

a. Common information

Operation is subject to the following two conditions:

1. This device may not cause interference, and
2. this device must accept any interference, including interference that may cause undesired operation of the device.

b. Operation in 2.4 GHz band

To prevent radio interference to the licensed service, this device is intended to be operated indoors and installed outdoors is subject to licensing.

c. Operation in 5 GHz band

- The device for the band 5150-5250 MHz is only for indoor usage to reduce potential for harmful interference to co-channel Mobile Satellite systems.
- High power radars are allocated as primary users (meaning they

have priority) of 5250-5350 MHz and 5650-5850 MHz and these radars could cause interference and/or damage to LELAN (Licence-Exempt Local Area Network) devices.

Exposure of humans to RF fields (RSS-102)

Aspire 1710 series employs low gain integral antennas that do not emit RF field in excess of Health Canada limits for the general population; consult Safety Code 6, obtainable from Health Canada's Web site at www.hc-sc.gc.ca/rpb.



Acer Incorporated
 8F, 88, Sec. 1, Hsin Tai Wu Rd., Hsichih
 Taipei Hsien 221, Taiwan, R.O.C.
 Tel : 886-2-2696-1234
 Fax : 886-2-2696-3535
 www.acer.com

Declaration of Conformity

We,

Acer Inc.
 8F, 88, Sec. 1, Hsin Tai Wu Rd., Hsichih,
 Taipei Hsien 221, Taiwan, R. O. C.

Contact Person: Mr. Easy Lai
 Tel: 886-2-8691-3089 Fax: 886-2-8691-3000
 E-mail: easy_lai@acer.com.tw

Hereby declare that:

Product: Notebook PC
 Trade Name: Acer
 Model Number: Aspire 1710; DT3
 SKU Number: Aspire 1710xx ("x" = 0~9, a ~ z, or A ~ Z)

Is in compliance with the essential requirements and other relevant provisions of the following EC directives.

Reference No.	Title
89/336/EEC	Electromagnetic Compatibility (EMC directive)
73/23/EEC	Low Voltage Directive (LVD)
1999/5/EC	Radio & Telecommunications Terminal Equipment Directive (R&TTE)

The product specified above was tested conforming to the applicable Rules under the most accurate measurement standards possible, and that all the necessary steps have been taken and are in force to assure that production units of the same product will continue comply with the requirements.

Easy Lai

 Easy Lai/ Director
 Qualification Center
 Product Assurance, Acer Inc.

2003/12/22

 Date

**Federal Communications Commission
Declaration of Conformity**

This device complies with Part 15 of the FCC Rules. Operation is subject to the following two conditions: (1) this device may not cause harmful interference, and (2) this device must accept any interference received, including interference that may cause undesired operation.

The following local Manufacturer/Importer is responsible for this declaration:

Product Name:	Notebook Personal Computer
Model:	Aspire 1710; DT3
Name of Responsible Party:	Acer America Corporation
Address of Responsible Party:	2641 Orchard Parkway, San Jose CA 95134, U. S. A.
Contact Person:	Young Kim
Phone No.:	408-922-2909
Fax No.:	408-922-2606

Index

A

- ACPI 40
- audio 27
 - connecting externally 45
 - controlling volume 27
 - troubleshooting 70

B

- battery bay 9
- battery pack
 - battery-low warning 39
 - caring for ix
 - characteristics 35
 - charging 38
 - checking charge level 38
 - installing 37
 - low conditions 39
 - maximizing life 35
 - optimizing 38
 - removing 38
 - using the first time 35
- BIOS Setup Utility 66
 - entering 66
- brightness
 - hotkeys 17, 18

C

- caps lock 15
 - on indicator 13, 14
- care
 - battery pack ix
 - computer viii
- CD
 - troubleshooting 71
- charging
 - checking level 38
- cleaning
 - computer ix
- computer
 - bringing to meetings 58
 - caring for viii
 - cleaning ix
 - disconnecting 57
 - features 10

- moving around 58
- security 30
- setting up a home office 60
- taking home 59
- traveling internationally 62
- traveling on local trips 61
- turning off vii

connections

- audio 45
- external display devices 43
- external input devices 43
- keyboard, external 44
- keypad, external 44
- mouse 44
- printer 45
- USB 47
- connectivity options 25
 - Ethernet 25

D

- display 12
 - hotkeys 17
 - performance 12
 - simultaneous 12
 - troubleshooting 69, 70
- DVD
 - troubleshooting 71

E

- Ethernet connection 25

F

- FAQ. See frequently-asked questions
- floppy drive
 - troubleshooting 71
- frequently-asked questions 69
- front view 3, 5

G

- guide vii

H

- hard disk 23
 - upgrading 51
- help vii
- hotkeys 17

K

- keyboard 15
 - connecting externally 44

- hotkeys 17
- lock keys 15
- troubleshooting 71
- Windows keys 16
- keypad
 - connecting externally 44

L

- launch keys 22
- left view 5

M

- memory
 - installing 53
 - upgrading 52
- microphone
 - troubleshooting 70
- modem
 - setting location 72
- mouse
 - connecting externally 44
- mute
 - hotkeys 18

N

- notice
 - DVD copyright protection 86
- num lock 15
 - on indicator 14

O

- optical drive 23
- options
 - hard disk upgrade 51
 - memory upgrade 52
 - PC Cards 46
 - spare AC adapter 48
 - spare battery 48

P

- palm rest 19
- password 31
- PC Card
 - inserting 46
 - removing 47
- ports
 - external display 8
 - parallel 8
 - USB 7, 8

- power management 40
- printer
 - connecting 45
 - troubleshooting 71
- problems 69
 - audio 70
 - CD 71
 - diskette 71
 - display 69, 70
 - DVD 71
 - floppy drive 71
 - keyboard 71
 - printer 71
 - startup 69

R

- rear view 8
- right view 7

S

- safety
 - CD or DVD 85
 - FCC notice 81
 - general instructions 83
 - modem notices 82
- scroll lock
 - on indicator 14
- security
 - password 31
 - slot 30
- service
 - when to call ix
- software
 - bundled 65
- speakers
 - troubleshooting 70
- status indicators 13
- status LCD 13
- storage 23
 - hard disk 23
 - optical drive 23

T

- touchpad 20
 - using 20
- travel
 - international flights 62
 - local trips 61

U

USB

connecting 47

utility

BIOS Setup 66

V

volume

adjusting 27

W

Windows keys 16

Free Manuals Download Website

<http://myh66.com>

<http://usermanuals.us>

<http://www.somanuals.com>

<http://www.4manuals.cc>

<http://www.manual-lib.com>

<http://www.404manual.com>

<http://www.luxmanual.com>

<http://aubethermostatmanual.com>

Golf course search by state

<http://golfingnear.com>

Email search by domain

<http://emailbydomain.com>

Auto manuals search

<http://auto.somanuals.com>

TV manuals search

<http://tv.somanuals.com>