

Acer Aspire 2020 Series

User's Guide

Copyright © 2004
All Rights Reserved

Acer Aspire 2020 Series Notebook Computer User's Guide
Original Issue: March 2004

Changes may be made periodically to the information in this publication without obligation to notify any person of such revision or changes. Such changes will be incorporated in new editions of this manual or supplementary documents and publications. This company makes no representations or warranties, either expressed or implied, with respect to the contents herein and specifically disclaims the implied warranties of merchantability or fitness for a particular purpose.

Record the model number, serial number, purchase date, and place of purchase information in the space provided below. The serial number and model number are recorded on the label affixed to your computer. All correspondence concerning your unit should include the serial number, model number, and purchase information.

No part of this publication may be reproduced, stored in a retrieval system, or transmitted, in any form or by any means, electronic, mechanical, photocopy, recording, or otherwise, without the prior written permission of Acer Incorporated.

Acer Aspire 2020 Series Notebook computer

Model Number : _____

Serial Number: _____

Purchase Date: _____

Place of Purchase: _____

All trademarks and registered trademarks are the properties of their respective companies.

First things first

Your guides

A set of guides is provided to help you set up and use your Aspire computer.



The *Just for starters...* poster shows you how to set up your computer.



This *User's Guide* provides clear and concise information on using your computer productively. You are advised to read it thoroughly and keep it handy for future reference.

For more information on our products, services, and support, please visit our web site: www.acer.com.

Basic care and tips for using your computer

Turning your computer on and off

To turn on your computer, open the lid and press the power button above the keyboard. See "A tour of your computer" on page 3 for the location of the power button.

To turn the power off, you can do any of the following:

- Click on the Start button in Windows, and then select **Shut Down** on the popup menu.
- Push the power button.

To use this method, you must change the **Power Management** settings in Control Panel. See Windows Help for more information.



Note: If the operating system freezes, or locks up, press and hold the power button for more than four seconds.

Taking care of your computer

Your computer will serve you well if you take care of it.

- Do not expose the computer to direct sunlight. Do not place it near sources of heat, such as a radiator.
- Do not expose the computer to temperatures below 0°C (32°F), or above 50°C (122°F).
- Do not expose the computer to magnetic fields.
- Do not expose the computer to rain or moisture.
- Do not spill water or any liquid on the computer.
- Do not subject the computer to heavy shock or vibration.
- Do not expose the computer to dust or dirt.
- Do not place objects on top of the computer.
- Do not slam the lid shut. Close the computer gently.
- Do not place the computer on unstable or uneven surfaces.

Taking care of your AC adapter

It is important that you look after your AC adapter.

- Do not connect the adapter to any other device.
- Do not step on the power cord or place heavy objects on it. Route the power cord away from areas where people might walk on it or trip over it.
- Do not pull on the power cord when disconnecting from a power strip or wall outlet. Grasp and pull the plug instead.
- The total ampere rating for all equipment plugged into a power strip should not exceed the ampere rating of the power strip.

Taking care of your battery pack

It is also important that you look after your computer's battery pack.

- Use the correct battery model for your computer. Do not use other kinds of batteries.
- Turn the power off before removing or replacing the battery.
- Do not tamper with the battery. Keep the battery away from children.
- Dispose of batteries according to local regulations. Recycle if possible.

Cleaning and servicing

When cleaning your computer, it is important that you follow these steps:

- Turn off the computer and remove the battery.
- Disconnect the AC adapter.
- Clean with a soft cloth moistened with a little water. Do not use liquid or aerosol cleaners.

Refer to the chapter entitled "Frequently asked questions" on page 75 if any of the following occurs:

- You drop the computer or damage the case.
- You spill liquid on the computer.
- The computer does not operate normally.

Contents

First things first	iii
Your guides	iii
Basic care and tips for using your computer	iii
Turning your computer on and off	iii
Taking care of your computer	iv
Taking care of your AC adapter	iv
Taking care of your battery pack	v
Cleaning and servicing	v
Getting familiar with your computer	1
A tour of your computer	3
Open view	4
Front view	6
Top view	7
Left view	8
Right view	9
Rear view	10
Bottom view	11
Features	12
Display	13
Indicators	14
Keyboard	16
Lock keys	16
Embedded numeric keypad	17
Windows keys	18
Function keys	19
Euro key	20
Touchpad	21
Touchpad basics	21
Launch keys	23
Storage	24
Ejecting an optical disc	24
Connectivity options	26
Ethernet and LAN	26
Fax/data modem	26
Audio	28
Aspire Media Console	29
Securing your computer	30
Security slot	30
Passwords	30

Operating on battery power	31
Battery pack	33
Battery pack characteristics	33
Maximizing battery life	33
Installing and removing the battery pack	34
Charging the battery	35
Checking the battery level	35
Optimizing battery life	35
Battery-low warning	36
Power management	37
Peripherals and options	39
External display devices	41
External input devices	41
External keyboard	41
External keypad	41
External pointing device	41
USB devices	42
IEEE 1394 Port	43
Printer	44
Audio devices	44
Expansion devices	45
PC Card	45
Key component upgrades	47
Memory upgrade	47
Installing memory	47
Hard disk upgrade	48
Moving with your computer	49
Disconnecting from the desktop	51
Moving around	51
Taking the computer home	52
Setting up a home office	52
Traveling with with computer	53
Traveling internationally with your computer	54
Software	55
System software	57
Launch Manager	57
Aspire Arcade	58
Instant-on Arcade	58
Features and Benefits	58

Cinema	58
Album	59
Music	59
Windows Arcade	61
Arcade Hot keys	62
Finding and playing content	63
Advanced Settings	63
Arcade controls	64
Navigation controls	64
Player controls	64
Cinema	65
DVD settings	65
Album	67
Video	69
Playing a video file	69
Editing a video file	69
Music	70
Burner	70
Copy - backup your CD/DVD collection	70
Audio - create your own greatest hits CDs	70
Data - store files simply and easily	71
Video - your world in pictures	71
BIOS Setup Utility	72
Troubleshooting	73
Frequently asked questions	75
Appendix A Specifications	79
Appendix B Notices	85
Index	99

Getting familiar with
your computer

Your Aspire notebook computer combines solid performance, versatility, multimedia capabilities and portability with stylish design. Increase your productivity by working wherever you are.

This chapter provides an in-depth "tour" of your computer's features.

A tour of your computer

After setting up your new Aspire notebook computer, as illustrated in the Just for starters... poster, take a few minutes to explore your sytem.

Open view

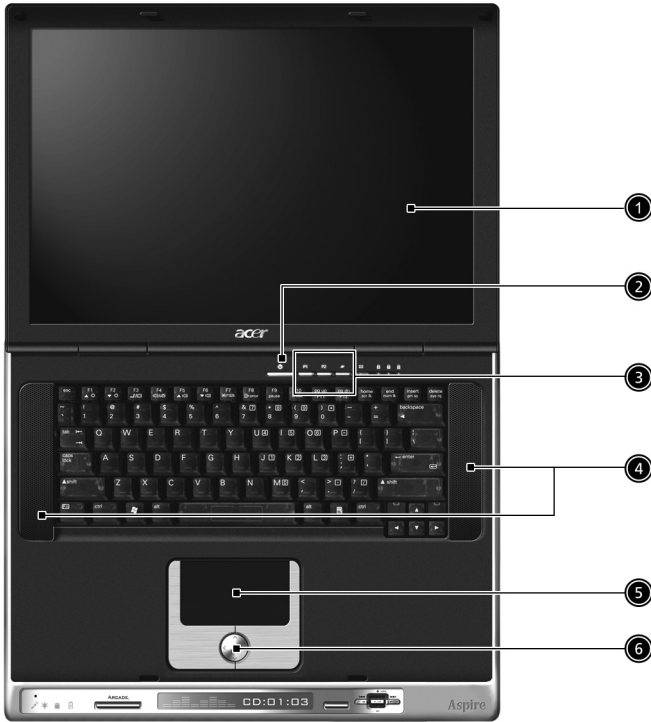



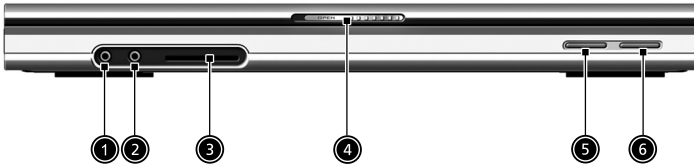

#	Item	Description
1	Screen	Wide screen display provides visual output.
2	Power Button	Turns the computer on or off.
3	Launch keys	Buttons that can be programmed to start frequently used applications.
4	Stereo Speakers	Produce stereo sound

#	Item	Description
5	Touchpad	Touch sensitive pad that functions like a computer mouse.
6	Click buttons and 4-way scroll key	Right and left buttons that provide the same functions as the buttons on a computer mouse. The scroll key scrolls the contents of a window up and down, as well as right and left.

Front view



#	Item	Description
1	Headphone-in jack 	Connects headphones for S/PDIF audio output
2	Microphone-in jack 	Connects an external microphone for audio input
3	4 in 1 Card Reader	Supports: <ul style="list-style-type: none"> • MemoryStick • MultiMediaCard • SecureDigital • SmartMedia
4	Latch	Locks and releases the lid
5	Bluetooth Button 	Enables Bluetooth functionality (manufacturing option)
6	Wireless Button 	Enables Wireless connectivity (manufacturing option)

Top view



#	Item	Description
1	Built-in Microphone	For recording audio on the computer
2	Status Indicator	LEDs that turn on and off to show system status.
3	Arcade button	Multimedia button
4	Console display	Media status display
5	Stop	Stop the Arcade application
6	Media Controls	Multimedia Button

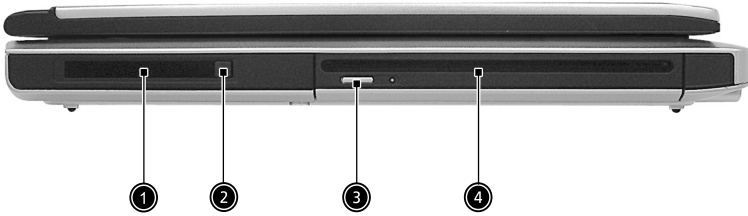

Left view



#	Item	Description
1	PC card slot 	Type II PC card supports PCMCIA or CardBus.
2	PC card eject button	Press the eject button to remove a PC card from the PC card slot.
3	Eject button	Ejects optical disc
4	Slot-loading Optical	Support an optical disc.

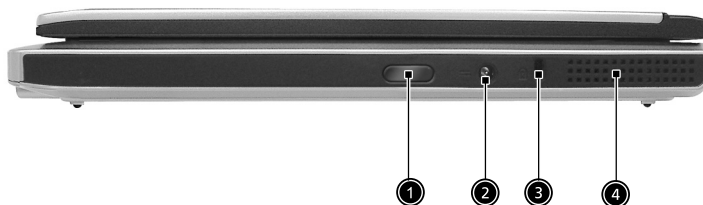





Right view

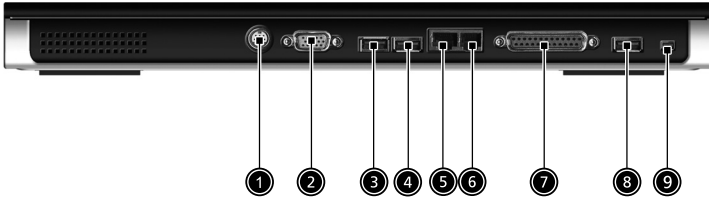

#	Item	Description
1	Infrared port 	Interfaces with infrared devices (e.g. infrared printer, IR-aware computer, etc...)
2	DC-in jack 	Connect the AC power adapter
3	Kensington lock slot	For attaching a security device.
4	Ventilation slot	Enables the computer to stay cool, even after prolonged use.

Rear view



#	Item	Description
1	S-video out port 	Connects to a television or display device supporting S-video input.
2	External display port 	Connects an external (VGA) monitor.
3 4 8	USB ports 	USB 2.0 ports
5	Network jack 	Connects the computer to an Ethernet network.
6	Modem jack 	Connects the built-in fax/data modem to a phone line.
7	Parallel port 	Connects a parallel device, such as a printer.
9	IEEE 1394 port 	Connects IEEE 1394 devices.

Bottom view

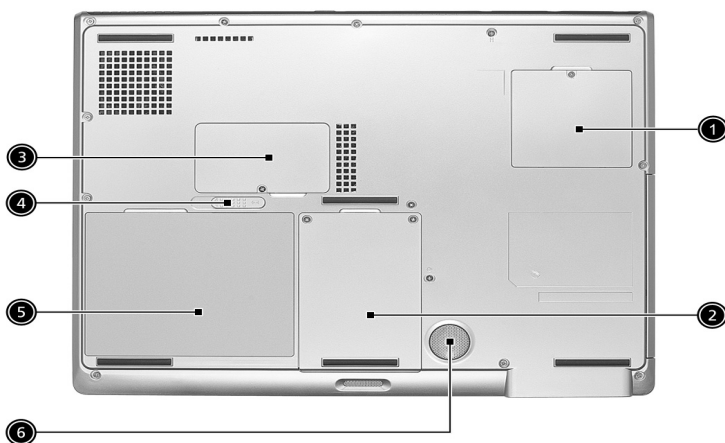

#	Item	Description
1	Mini-PCI Slot	Slot for adding mini-PCI cards
2	Hard disk bay	Removable cover provides access to the computer's hard drive.
3	Memory compartment	Removable cover provides access to the memory slots for upgrading the computer's memory.
4	Battery release latch	Unlatches the battery to remove the battery pack.
5	Battery pack	The computer's removable battery.
6	Sub-Woofer	Outputs low/mid range audio

Features

Performance

- Intel® Pentium® M Processor at 1.4 GHz or higher
- 2 memory slots supporting 333 MHz DDR, upgradeable to 2GB
- 30GB and up Enhanced-IDE hard disk drive

Multimedia

- Built-in optical drive (Slot-loading DVD Super-Multi Drive)
- 15.4" TFT Color LCD, 1280x800 (WXGA) panel
- 2.1 channel stereo speaker system
- Audio input and S/PDIF (for digital audio enjoyment) output jacks

Connectivity

- Integrated 100/1000 Mbps Ethernet connection
- Built-in 56Kbps fax/data modem
- Three universal serial bus (USB 2.0) ports
- One IEEE 1394 port
- 802.11b/g Wireless LAN and Bluetooth (manufacturing options)

Human-centric design

- Rugged, portable construction
- Stylish appearance
- Standard 85 key keyboard with four programmable launch keys
- Comfortable palm rest area with well-positioned touchpad

Expansion

- PC card slot enables a range of add-on options
- Upgradeable hard disk and memory modules

Display





- The 15.4" display panel provides a large viewing area for maximum efficiency and ease-of-use.
- ATI Radeon 9700 with 128MB DDR VGA Memory
- Supports simultaneous display on external LCD or CRT
- S-video for output to a television or display device that supports S-video input
- One LED console display for multimedia status
- DualView™ support

Indicators





Your computer provides three indicators located above the keyboard, in addition to five indicators positioned at the front of the palm rest area. These indicators show the status of the computer and its components.



The three indicators located above the keyboard provide the following status information:

Icon	Description
Caps Lock 	Caps Lock active
NumLk 	Num Lock active  Note: The keypad lock must be turned on to use the embedded numeric keypad.
ScrLk 	Scroll Lock active

The five indicators located at the front of the unit provide the following status information:

Icon	Function	Description
	Power mode	<ul style="list-style-type: none"> Steady green -- power on Orange -- standby mode Flashing orange -- hibernation mode
	Hard Disc activity indicator	<ul style="list-style-type: none"> Lights to Indicate when the hard disc drive is reading or writing data.
	Battery state	<ul style="list-style-type: none"> Blue -- fully charged Orange -- being charged Flashing orange -- low on power
	Bluetooth mode	Lights to indicate that Bluetooth is enabled (manufacturing option).
	Wireless LAN mode	Lights to Indicate status of wireless LAN is enabled (manufacturing option).

Keyboard

The keyboard features full-size keys with an embedded keypad, separate cursor control keys, two Windows keys, and 13 function keys.

Lock keys

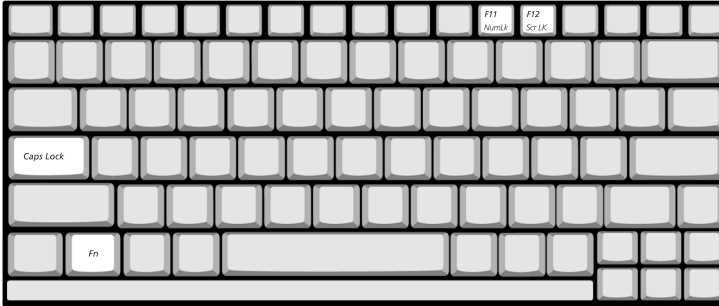

The computer features three lock keys, each with its own status indicator light.

Lock Key	Description
Caps Lock	When Caps Lock is on, all alphabetic characters are typed in uppercase. Toggle on/off by pressing the Caps Lock key on the left side of the keyboard.
Num Lock	When Num Lock is on, the embedded numeric keypad can be used. Toggle on/off by pressing the Fn + F11 key combination.
Scroll Lock	When Scroll Lock is on, the screen moves up or down one line at a time when the up and down cursor control keys are pressed.



Note: Scroll Lock doesn't work in all applications. Toggle on and off by pressing the **Fn + F12** keys combination.

Embedded numeric keypad

The embedded keypad functions like a desktop numeric keypad. It is indicated by small blue numbers and characters on the applicable keys, as shown below.

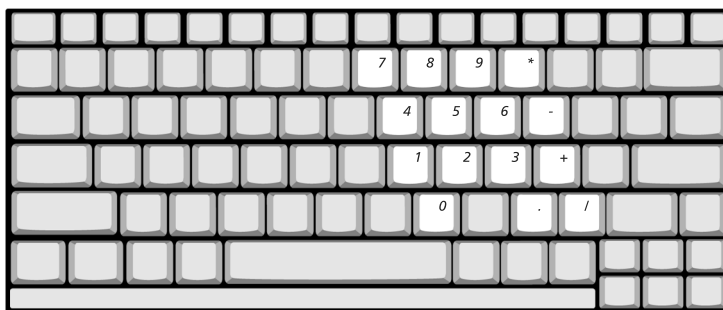

To use the embedded numeric keys, toggle the NumLk on by pressing the **Fn + F11** keys simultaneously.







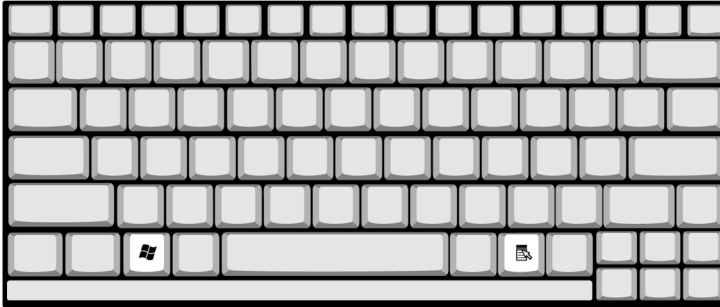

With the embedded keypad turned on, the following actions are possible:

Desired Access	Num lock On	Num lock Off
Number keys on embedded keypad	Type numbers using embedded keypad in the normal way.	
Cursor control keys on embedded keypad	Hold down the Shift key while using the cursor keys on the embedded keypad.	Hold Fn key while using cursor-control keys.
Main keyboard keys	Hold down the Fn key while typing letters using the embedded keypad keys. Simultaneously press the Shift key for capital letters.	Type letters in the normal way.

Windows keys

The keyboard features two keys that provide Windows-specific functions.



Key	Description
Windows key 	Pressed alone, this key has the same effect as clicking on the Windows Start button; it launches the Start menu. It can also be used with other keys to provide a variety of functions: <ul style="list-style-type: none">  + Tab activates the next Taskbar button  + E opens the My Computer window  + F1 opens Help and Support  + F opens the Find: All Files dialog box  + M minimizes all windows Shift +  + M undoes minimize  + R opens the Run dialog box
Application key 	This key has the same effect as clicking the right mouse button to open an application's context menu.

Function keys

Using the **Fn** key with another key creates a hot key, providing a quick and convenient method for controlling various functions.

To use a hot key, first hold down the **Fn** key. Next, press the second key in the combination. Finally, release both keys.



Your computer provides the following hot keys:

HotKey	Function	Description
Fn + F1	Hot key help	Displays help on hot keys.
Fn + F2	Setup	Accesses the computer's configuration utility.
Fn + F3	Power management scheme toggle	Switches the power management scheme used by the computer (function available if supported by operating system). See "Power management" on page 37.
Fn + F4	Sleep	Puts the computer in Sleep mode. See "Power management" on page 37.
Fn + F5	Display toggle	Switches display output between the display screen, external monitor (if connected) or both the display screen and external monitor.

HotKey	Function	Description
Fn + F6	Screen blank	Turns the display backlight off to save power. Press any key to return.
Fn + F7	Touchpad toggle	Turns the internal touchpad on and off.
Fn + F8	Speaker toggle	Turns the speakers on and off.
Fn + Sub-woofer key	Sub-woofer	Turns the sub woofer on and off
Fn + ↑	Volume up	Increases the speaker volume.
Fn + ↓	Volume down	Decreases the speaker volume.
Fn + →	Brightness up	Increases the screen brightness.
Fn + ←	Brightness down	Decreases the screen brightness.

Euro key

Your computer supports the new Euro currency character. First, hold down the **Alt Gr** key, and then press the **Euro** key.

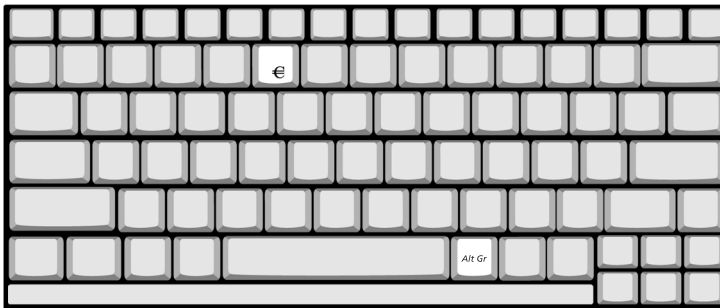

Touchpad

The built-in touchpad is a PS/2- compatible pointing device that senses movement on its surface. The cursor responds to your finger movements on the touchpad. The two click buttons function like mouse buttons. The scroll key enables up and down and side to side scrolling in documents and web pages.

The touchpad is located in the middle of the palm rest area, providing maximum comfort and efficiency.



Touchpad basics

Use the touchpad as follows:

- Slide your finger over the surface of the touchpad to control the movement of the cursor. Tap the touchpad to perform selection and execution functions.



- Press the left **(1)** and right **(3)** click buttons as you would use the buttons on a computer mouse.
- Use the scroll key **(2)** to scroll through long documents and web pages. Press the top of the key to scroll up, and the bottom to scroll down; left to scroll left, and right to scroll right.

Function	Left Button	Right Button	4-Way Scroll Key	Tap
Execute	Click twice quickly			Tap twice quickly
Select	Click once			Tap once
Drag	Click and hold. Then, slide your finger across the touchpad to drag the cursor over the selection.			Tap twice quickly. On the second tap, slide your finger across the touchpad to drag the cursor over the selection.
Access content menu		Click once		
Scroll			Click and hold to scroll up/down/left/right	



Note: Keep your fingers, as well as the surface of the touchpad, clean and dry. The touchpad is sensitive to your finger movements: the lighter your touch, the better the response. Tapping hard will not increase the touchpad's responsiveness.

Launch keys

Located at the top of the keyboard are four buttons next to the power button. These buttons are called launch keys. They are designated as key 1, key 2, key 3 and key 4, from right to left. By default, key 1 is used to launch the E-mail application and key 2 is used to launch the Internet browser. Keys 3 and 4 start the Launch Manager application and can be programmed to provide quick access to frequently used applications. To set the launch keys, run the Acer Launch Manager.



Launch key	Default application
E-mail	Launches your E-mail application
Web browser	Launches your Internet browser
P2	User-programmable
P1	User-programmable

Storage

Your computer's all-in-one design offers a variety of data storage options:

- High capacity Enhanced-IDE hard disk drive.

The hard drive is upgradeable, enabling you to increase your storage capacity in the future. Consult your dealer if you need to upgrade.

- High speed optical drive.

Depending on the model you purchased, you have a Slot-loading DVD/CD-RW combo drive or DVD-RW drive. The optical drive provides increased storage capacity, as well as offering a host of multimedia possibilities.



Note: Refer to "A tour of your computer" on page 3 for the location of the drives.

Ejecting an optical disc

To eject an optical disc

- With the computer turned on, press the optical drive eject button.



To load an optical disc

- With the computer turned on, insert the disc into the drive slot until you feel the drive catch the disc and take it the rest of the way in.
- The disc may need to be inserted nearly all the way in before the drive takes it in rest of way.

Connectivity options

Your computer has built-in connectivity options, enabling you to hook up to a network or communicate over a phone line.

Ethernet and LAN

The integrated network feature allows you to connect your computer to an Gigabit LAN (100/1000Mbps) network.

To use the network feature, plug an Ethernet cable into your computer's network jack, and then connect the other end to a network jack or hub on your network.



See Windows Help for information on setting up a network connection.

Fax/data modem

Your computer features a built-in fax/data modem, enabling you to communicate over a phone line. This means that you can connect to the Internet via a dialup account with an ISP, log in to your network from a remote location, or send faxes.



.....
Warning: Your modem is not compatible with digital phone lines. Plugging the computer into a digital phone system will damage the modem.

To use the fax/data modem, plug a phone cable into your computer's modem jack, and then connect the other end to a telephone jack.

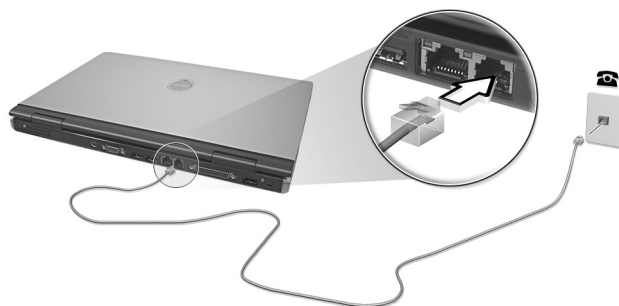

Audio

Your computer includes an integrated stereo audio system.

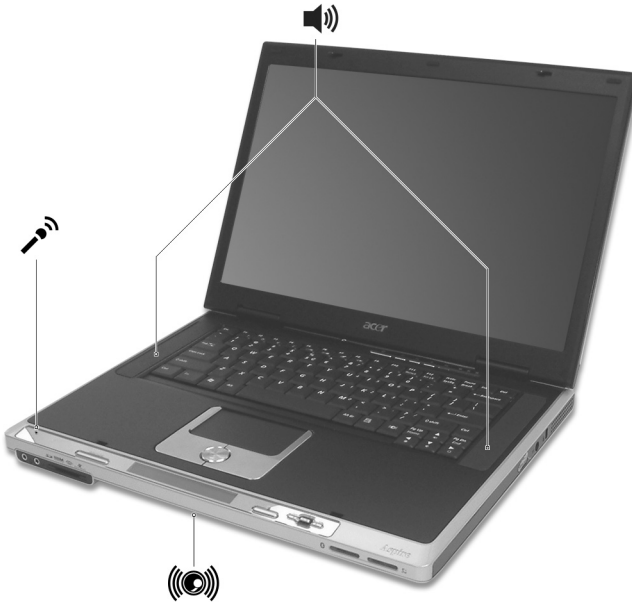

The built in sub-woofer provides tight and precise bass performance for low frequency audio.



Note: When an external device (headphones or a microphone) is connected, the system speakers will be disabled.

Aspire Media Console



The Acer Aspire 2020 notebook computer features a convenient Media Console that includes (from left to right):

- the Arcade button for instant-on multimedia
- a blue LED console display for system information such as:
 - Arcade mode
 - media type/status
 - battery status
 - clock
 - personalized greetings
- media controls for on-screen menu navigation and media playback

When running Arcade in Windows, a convenient on-screen navigation bar is displayed. Use the computer's built in touchpad to access the onscreen controls.

When the system is off, press the "Arcade" button to access the "Aspire Arcade" application without starting Windows. Press the "Arcade" button four seconds to quit the application and power down the system.

When the system is on and running Windows, press the "Arcade" button to enable the "Aspire Arcade" application.

Press the stop button to stop CD or DVD playback.

The Media Control buttons can adjust volume, select play mode and perform other media features.

Securing your computer

Your computer features hardware and software security solutions, in the form of a slot for a Kensington lock and system password functionality.

Security slot

A slot for a Kensington lock enables you to physically protect your computer from theft. Use this feature as follows:

- Wrap a security lock cable around a heavy or immovable object, such as a drawer handle on a file cabinet, or a table leg.
- Insert the lock into the slot on the computer, turn it 90°, and then lock it in place.



Passwords

You can protect your computer from unauthorized access by setting Windows password protection. The user must enter the password before beginning a Windows session.

- First, open **User Accounts** in Windows **Control Panel** and select your account.
- Click **Create a Password**, and then set your desired password.
- Click **Performance and Maintenance, Power Options** in **Control Panel**.
- On the **Advanced** tab, select the option to prompt for password when computer resumes from standby.
- To cancel password protection, reset the password with a blank password.

Operating on
battery power

Your Aspire 2020 series notebook computer operates on battery or AC power.

This chapter provides information for operating on battery power, as well as information on how your computer manages and saves power.

Battery pack

The computer uses a battery pack that gives you long use between charges.

Battery pack characteristics

The battery pack has the following characteristics:

- Employs current battery technology standards.
- Delivers a battery-low warning.

The battery is recharged whenever you connect the computer to an external power supply. Your computer supports charge-in-use, enabling you to recharge the battery while you continue to operate the computer. However, recharging with the computer turned off results in a significantly faster charge time.

The battery will come in handy when you travel or during a power failure. It is advisable to have an extra fully charged battery pack available as backup. Contact your dealer for details on ordering a spare battery pack.

Maximizing battery life

Like all other batteries, your computer's battery will degrade over time. This means that the battery's performance will diminish with time and use. To maximize your battery's life, you are advised to adhere to the recommendations set out below.

Conditioning a new battery pack

Before you use a battery pack for the first time, there is a "conditioning" process that you should follow:

- 1 Insert the new battery without turning the computer on.
- 2 Connect the AC adapter and fully charge the battery.
- 3 Disconnect the AC adapter.
- 4 Turn on the computer and operate using battery power.
- 5 Fully deplete the battery until the battery-low warning appears.
- 6 Reconnect the AC adapter and fully charge the battery again.

Follow these steps again until the battery has been charged and discharged three times.

Use this conditioning process for all new batteries, or if a battery hasn't been used for a long time. If the computer is to be stored for more than two weeks, you are advised to remove the battery pack from the unit.



.....

Warning: Do not expose battery packs to temperatures below 0°C (32°F) or above 60°C (140°F). Extreme temperatures may adversely affect the battery pack.

By following the battery conditioning process you condition your battery to accept the maximum possible charge. Failure to follow this procedure will prevent you from obtaining the maximum battery charge, and will also shorten the effective lifespan of the battery.

In addition, the useful lifespan of the battery is adversely affected by the following usage patterns:

- Using the computer on constant AC power with the battery inserted. If you want to use constant AC power, you are advised to remove the battery pack after it is fully charged.
- Not discharging and recharging the battery to its extremes, as described above.
- Frequent use; the more you use the battery, the faster it will reach the end of its effective life. A standard computer battery has a life span of about 500 charges.

Installing and removing the battery pack



.....

Important! Before removing the battery from the unit, connect the AC adapter if you want to continue using your computer. Otherwise, turn off the computer first.

To install a battery pack

- 1 Align the battery with the open battery bay; make sure that the end with the contacts will enter first, and that the top surface of the battery is facing up.
- 2 Slide the battery into the battery bay and gently push until the battery locks in place.

To remove a battery pack

- 1 Slide the battery release latch to release the battery.
- 2 Pull the battery from the battery bay.

Charging the battery

To charge the battery, first make sure that it is correctly installed in the battery bay. Plug the AC adapter into the computer, and connect to a mains power outlet. You can continue to operate your computer on AC power while your battery is charging. However, charging the battery with the computer turned off results in a significantly faster charge time.



Note: You are advised to charge the battery before retiring for the day. Allowing the battery to charge overnight before traveling enables you to start the next day with a fully charged battery.

Checking the battery level

The Windows Power Meter indicates the current battery level. Rest the cursor over the battery/power icon on the taskbar to see the battery's present charge level.

Optimizing battery life

Optimizing battery life helps you get the most out of battery operation, prolonging the charge/recharge cycle and improving recharging efficiency. You are advised to follow the suggestions set out below:

- Purchase an extra battery pack.
- Use AC power whenever possible, reserving your battery for on-the-go use.
- Eject PC cards when not in use.
- Store the battery pack in a cool, dry place. The recommended temperature is 10°C to 30°C. Higher temperatures cause the battery to self-discharge faster.
- Excessive recharging decreases the battery life.

Battery-low warning

When using battery power pay attention to the Windows Power Meter.



Warning: Connect the AC adapter as soon as possible after the battery-low warning appears. Data will be lost if the battery is fully depleted causing the computer to shut down.

When the battery-low warning appears, the recommended course of action depends on your situation:

Situation	Recommended Action
An AC adapter and a power outlet are available.	<ol style="list-style-type: none"> 1. Plug the AC adapter into the computer, and then connect to an external power supply. 2. Save all necessary files. 3. Resume work. <p>Turn off the computer if you want to recharge the battery rapidly.</p>
An extra fully charged battery pack is available.	<ol style="list-style-type: none"> 1. Save all necessary files. 2. Close all applications. 3. Shut down the operating system to turn off the computer. 4. Replace the battery pack. 5. Turn on the computer and resume work.
An AC adapter or a power outlet is unavailable. You have no spare battery pack.	<ol style="list-style-type: none"> 1. Save all necessary files. 2. Close all applications. 3. Shut down the operating system to turn off the computer.

Power management

Your computer features built-in power management features that constantly monitor system activity. System activity refers to any activity involving one or more of the following devices: keyboard, touchpad/mouse, hard disk drive, optical drive, peripherals connected to the computer, and video memory. If no activity is detected for a period of time (the settings are controlled in Windows Power Management), the computer turns off some, or all, of these devices in order to conserve power.

Your computer employs a power management scheme that supports ACPI (Advanced Configuration and Power Interface), enabling maximum power conservation without compromising system performance. ACPI allows Windows to control the amount of power given to each device attached to the computer. In this way, Windows handles all power-saving chores for your computer. Refer to Windows Help for more information.

Peripherals and options

Your Aspire 2020 series notebook computer offers good expansion capabilities.

This chapter provides information on connecting peripherals to expand your system. It also describes how to upgrade key components to enhance system performance and keep your computer in step with the latest technology.

You are advised to consult your dealer for information on peripherals. In addition, make sure that you read the manuals and other documentation provided with new hardware.

External display devices

You can connect an external (VGA) monitor or projector to your computer's external display port. Use the **Fn + F5** key combination to toggle the display setting between the computer's LCD panel and an external display device. See "Function keys" on page 19 for more information.

External input devices

You can connect a variety of input devices to your computer's USB ports, providing increased functionality and greater ease-of-use. In addition, the USB ports can be used to connect many other peripheral devices, such as digital cameras, printers and scanners. See "Expansion devices" on page 45 for more information on connecting USB devices.

External keyboard

Your computer features a full-size keyboard. However, if you prefer, you can connect an external keyboard to one of your computer's USB ports. This enables you to enjoy the comfort and added features of a full-size desktop system keyboard when entering typed data on your notebook computer.

External keypad

Your computer features an embedded keypad that, when combined with the Num Lock feature, enables you to easily input numeric data. Alternatively, you can connect a 17-key numeric keypad to one of your computer's USB ports. This enables you to enjoy the benefits of a numeric keypad without interfering with your use of the computer's keyboard for typing text.

External pointing device

Your computer features a sensitive touchpad pointing device with two click buttons and a scroll key. However, if you prefer to use a conventional mouse or other pointing device, you can connect it to one of your computer's USB ports.

USB devices

Your computer features three USB (Universal Serial Bus) 2.0 ports for connecting a range of USB peripherals. See “External input devices” on page 41 and “Printer” on page 44 for information on connecting a USB keyboard, keypad, mouse or printer. Other common USB devices include digital cameras, scanners, and external storage devices.



USB is plug and play, which means you can connect and start using a USB device without having to restart your computer. You can also disconnect the device at any time.

An added advantage of USB is the ability to use USB hubs. This means that several devices can share a USB port simultaneously.

IEEE 1394 Port

The computer's IEEE 1394 port allows you to connect to an IEEE 1394 supported device like a digital video camera.



See the documentation provided with your IEEE 1394 enable device for more information.

Printer

Your computer supports both parallel and USB printers.

Refer to the printer's manual for information on:

- Setting up the hardware
- Installing the necessary drivers in Windows
- Operating instructions

To use a USB printer, simply connect the device to one of your computer's USB ports, and then wait for Windows to detect the new hardware.

To connect a parallel printer, first shut down the operating system. Connect the printer to the parallel port, and then restart the computer. Wait for Windows to detect the new hardware.

Audio devices

Your notebook computer offers built-in stereo speakers and a sub-woofer. See the section entitled "Audio" on page 28 for more information. In addition to the integrated devices, the two audio ports on the front of the unit enable you to connect external audio input and output devices.

You can plug an external microphone into your computer's microphone-in jack. This offers the convenience of greater freedom of movement, as well as improved audio input quality.

Connect headphones to the headphone jack for private listening and improved audio output quality.

Expansion devices

PC Card

Your computer features a PC card slot that supports a standard Type II PC card (PCMCIA or CardBus). This greatly increases your computer's usability and expandability. A variety of PC cards are available, such as flash memory, fax/data modem, LAN, and SCSI cards. Consult your dealer for information on PC card options.



.....
Note: Refer to the PC card documentation for details on how to install and use the card.

To insert a PC card

- 1 Align the card with your computer's PC card slot. Make sure that the edge with the connectors is facing the slot, and that the card is the right side up. Many cards are marked with an arrow to help you insert them correctly.
- 2 Slide the card into the slot, and push gently until the card connects.
- 3 If necessary, connect the card's cable to the jack on the outer edge of the card.
- 4 Your computer's operation system will automatically detect the card's presence.



To remove a PC card

- 1 Close the applications (if any) using the PC card.
- 2 Double click on the PC card icon on the taskbar, and then select the option to safely remove the card. Wait for the message telling you that it is now safe to remove the card.
- 3 Press the PC card eject button (a) to partially eject the card.
- 4 Pull the card from the slot (b).

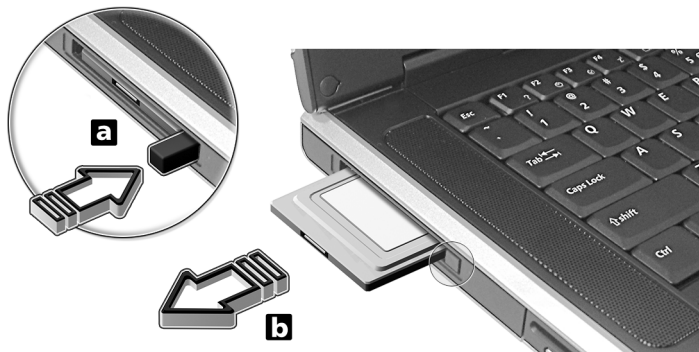

Key component upgrades

Your computer is designed to deliver solid performance. However, in time, you might find that your applications demand even more computing power. For this reason, you are able to upgrade key components.



Note: Contact your authorized dealer if you decide to perform a key component upgrade.

Memory upgrade

Memory is expandable to 2GB, employing 256/512 MB or 1 GB industry standard soDIMMs (Small Outline Dual Inline Memory Modules). The computer supports DDR (Double Data Rate) SDRAM.

There are two memory slots on your computer, one of which is occupied by standard memory. You can upgrade memory by installing a memory module into the other available slot.

Installing memory

- 1 Turn off the computer. Make sure that the AC adapter is disconnected, and then remove the battery pack.
- 2 Turn the computer over to access the memory compartment on the bottom of the unit. Remove the screw from the memory compartment cover (a), and then lift the cover off (b) .

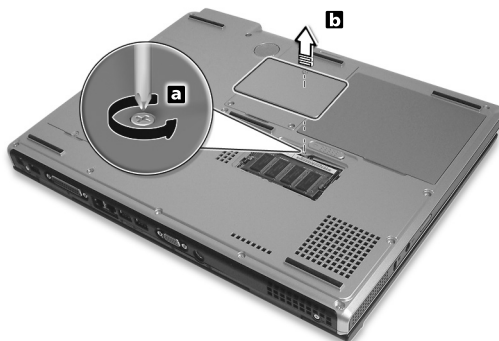

- 3 Insert the memory module diagonally in the slot (a), and then press down gently until it clicks in place (b).

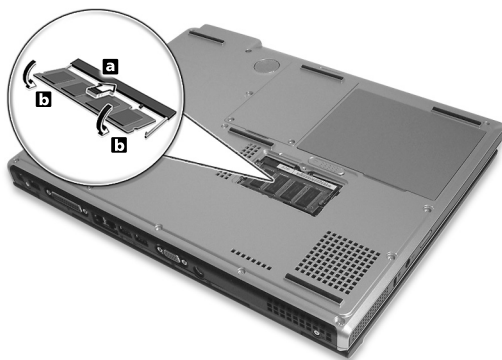

- 4 Replace the memory compartment cover, and fasten the screw. The computer automatically detects the new module and reconfigures the system memory.

Hard disk upgrade

It is possible to replace your hard disk with a higher capacity drive when you need more storage space. Your computer uses a 9.5mm 2.5-inch Enhanced-IDE hard disk. Consult your dealer if you need to perform a hard disk upgrade.

Moving with your computer

Your Aspire 2020 series notebook computer is ideal for taking with you when you move around.

This chapter provides tips on things to consider when traveling with your computer.

Disconnecting from the desktop

Before moving with your computer, you must turn it off and disconnect all peripherals:

- 1 Save your work and close all applications.
- 2 Shut down Windows to turn off your computer.
- 3 Unplug the AC adapter and disconnect it from the computer.
- 4 Disconnect any external devices, such as a keyboard, mouse, or printer, that are attached to your computer.
- 5 If you are using a security lock cable, disconnect the lock from the computer.
- 6 Pack your computer in a strong, waterproof bag or case.

Moving around

Sometimes you might need to move your computer a short distance. For example, you might need to move from your office desk to a meeting room. In these situations, you don't have to shut down the operating system.

Preparing the computer

First, disconnect any peripherals that you don't want to take with you. Next close the lid, placing your computer in Standby mode. You can now safely carry it around with you.

When you are ready to use your computer again, open the lid and then press the power button to bring it out of Standby mode.

What to bring to short meetings

If your battery is fully charged, you probably won't need to take anything else with you to the meeting.

What to bring to long meetings

For longer meetings, take along the AC adapter. You can use AC power or run down your battery first, and then connect the AC adapter after receiving the battery-low warning.

If the meeting room does not have an available power outlet, reduce your computer's power consumption by putting it in Standby mode during long periods of inactivity. It is advisable to take along a spare battery if you have one.

Taking the computer home

When you move between your office and home you will need to prepare your computer for the short trip.

Preparing the computer

After disconnecting your computer from the desktop, prepare the unit as follows:

- 1 Remove all media from the drives. Loaded media can damage the drive heads during transit.
- 2 Pack the computer in a protective case that is padded to guard against knocks. Make sure that the unit cannot slide around inside the case.



.....
Caution: Avoid packing items next to the top of the computer, as this could result in damage to the screen.

What to bring with you

If you don't have spare items at home, it is advisable to take along the AC adapter and this User's Guide.

Special considerations

To protect your computer in transit, it is advisable to pay attention to the following:

- Minimize the effect of temperature changes. Keep your computer with you instead of placing it in storage holds.
- Avoid leaving your computer in a hot car.
- Changes in temperature and humidity can cause condensation to form in your computer. Before turning the computer on, allow it to return to room temperature, and then check the screen for signs of condensation. If the temperature change is greater than 10°C (18°F), allow the computer to come to room temperature slowly by placing it in a room with a temperature between the outside and room temperatures.

Setting up a home office

If you frequently work on your computer at home, as well as at work, it may be worthwhile purchasing a second AC adapter. This will allow you to travel lighter, as you can keep an AC adapter in each location.

You might also find it worthwhile keeping a second set of peripherals at home, such as a keyboard, keypad, mouse and printer.

Traveling with with computer

Sometimes you might need to make longer trips with your computer.

Preparing the computer

Prepare the computer as you would for moving between your office and home. It is advisable to make sure that the battery is fully charged. If you are traveling by air, you might be required to turn on the computer during security checks.

What to take with you

It is advisable to take the following items with you:

- AC adapter
- Spare, fully charged battery packs
- Additional printer driver files (if you plan to use another printer)
- Phone and network cables (if you plan to use the computer's modem and network connections)

Special considerations

In addition to the considerations for taking your computer home, keep the following in mind:

- Always take your computer as carry-on luggage.
- If possible, have your computer manually inspected at security checks. Although the computer can pass safely through security X-ray machines, you should never expose it to a metal detector.
- If carried separately, avoid exposing floppy disks to hand-held metal detectors.

Traveling internationally with your computer

Occasionally you might need to travel between countries with your computer.

Preparing the computer

Prepare the computer as you would for normal travel. Remember to take special precautions for air travel.

What to take with you

It is advisable to take the following items with you:

- AC adapter
- Power cords that are appropriate for the countries you plan to visit
- Spare, fully charged battery packs
- Additional printer driver files (if you plan to use another printer)
- Phone and network cables (if you plan to use the computer's modem and network connections)



.....

Caution! Check that your modem is suitable for the telephone system in the countries you plan to visit. You may have to use a PC card modem in some locations.

Special considerations

In addition to the considerations for normal travel with your computer, keep the following in mind when traveling internationally:

- Check that your power cord is suitable for the local power supply. If necessary, purchase a power cord that meets local requirements. Avoid using converter kits.
- If you plan to connect over a phone line, check that the computer's modem and your phone cord are suitable for the local phone system. If necessary, purchase a PC card modem that meets local requirements.
- If carried separately, avoid exposing floppy disks to hand-held metal detectors.

Software

Your Aspire 2020 series notebook computer includes system utilities.

This chapter provides information on the important software that comes with your computer.

System software

Your computer comes preloaded with the following software:

- Microsoft Windows operating system
- Hardware BIOS setup utility
- System utilities, drivers and application software



Note: To run software applications in Windows, first click on the Start button. Next, select the appropriate folder, and then click on the application icon. To learn about the software and utility, make use of the online help provided by the software.

Launch Manager

Launch Manager allows you to set the four launch keys located above the keyboard. See "Launch keys" on page 23 for the location of the launch keys.

You can access the Launch Manager by clicking on Start, All Programs, and then Launch Manager, or by pressing an unassigned launch key.

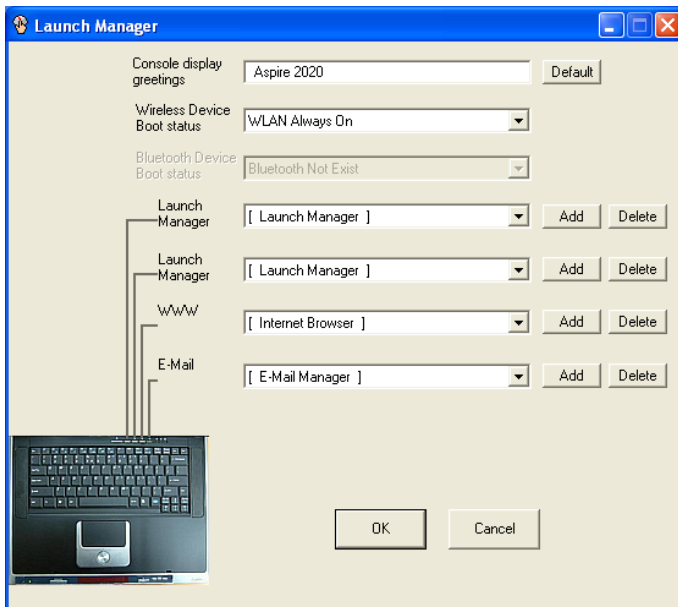

Aspire Arcade

Instant-on Arcade

Instant-on Arcade is state-of-the-art software, integrating the best digital media in one convenient and easy to use application. The Arcade includes Cinema, Album and Music modes.

With a press of the Aspire Media Console's Arcade button you can enjoy your multimedia collection without waiting for the Windows operating system to boot up. This saves time, optimises system loading, and reduces power consumption.

Features and Benefits

Cinema

You can play movies from DVDs and VCDs with the Cinema feature of Aspire Arcade. This player has the features and controls of a typical living room DVD player.

When you insert a disc into the DVD drive, the movie begins playing automatically.

Media Controls features, such as play, stop, return to menu, jump to previous/next chapter, and rewind/fast forward, let users have total control over their viewing and set-up preferences

Resume Playback:

Users can continue DVD playback from where it was stopped or from beginning.

Advanced DVD viewing options:

The Language settings control the audio and visual language output of DVDs/VCDs.

Subtitle selects the default subtitle language for DVDs when available.

Closed caption turns on the closed captions on DVDs. This function displays captions encoded in the video signal that describe on screen action and dialogue for the hearing impaired.

Audio selects the default language for DVD titles.

Album

Aspire Arcade lets you view digital photos individually or as a slideshow, from any available drive on your computer. Click the Album button on the Home page to show the Album main page.

To view a slideshow, open the folder containing the pictures you wish to view - then click the Play slideshow button. The slideshow is played full-screen.

To rotate a picture in full-screen, click the Rotate right or Rotate left buttons.

You can also view a single picture by clicking on it. This opens the picture full-screen.

Slideshow settings:

To change slideshow settings click the Settings button on the Album page.

The Slide duration setting determines how long each slide is shown before automatically advancing to the next picture in the slideshow.

The Transition effects setting sets the style of transition used between pictures.

Click the Restore to factory settings button to return your settings to their default values.

Music

Comes with various interface controls for playing CD or MP3 files. Users can shuffle playback and repeat music tracks.

Offers various navigation features, including play, stop, rewind/fast forward, and volume control.

The songs in the folder are shown in the content area, while the left side has controls for Play, Random, and Repeat all.

In instant-on mode, the computer screen remains off to save power.

File type compatibility

Mode	Supported	Not Supported
Audio		DTS Liner PCM
Cinema	DVD/VCD	DVD navigator SVCD
Music	MP3, CD audio	DVD audio format
Album	JPEG(Only)	GIF, TIF, EPS, PSD
Others		USB external drive TV out IEEE 1394 port PCMCIA LAN/Modem/IR /Printer/ Bluetooth/ Wireless LAN



Note: The track pad is not functional under Instant-on Arcade. Nor are any power management features available under instant-on Arcade.

Windows Arcade

Aspire Arcade is an integrated player for music, photos, DVD movies, and videos. To watch or listen, click a content button (e.g. Music, Video, etc...) on the Arcade home page.



Cinema - watch DVDs or VCDs

Album - view photos stored on your hard drive or any removable media

Video - watch and/or edit video clips

Music - listen to music files in a variety of formats

Burner - create CDs and/or DVDs to share or archive data

Advanced Settings - adjust Aspire Arcade according to your preferences



.....

Note: While watching videos, DVDs, or slide shows your screensaver and power-saving features are unavailable. These functions are enabled when you listen to music.

Arcade Hot keys

When running in the Windows environment, the key combinations listed below are available to control and fine-tune the features and settings of Aspire Arcade.

Hot key	Function
Fn+F1	On- line help menu
Fn+F3	Battery info
Fn+F5	Display toggle
Fn+F6	Screen blank
Fn+F8	Speaker toggle
Fn + Subwoofer key	Turns the sub woofer on and off
Fn + ↑	Volume up Increases the speaker volume.
Fn + ↓	Volume down Decreases the speaker volume
Fn + →	Brightness up Increases the screen brightness
Fn + ←	Brightness down Decreases the screen brightness
↑	Volume up
↓	Volume down
→	Next Chapter
←	Previous Chapter

Finding and playing content

Clicking a button on the Arcade home page opens the corresponding feature's home page. The content pages have buttons on the left and a content browsing area on the right. If a button shows one of several choices, such as sort order, the current setting is shown by a brightly coloured ball on the left side.

To pick content, click an item in the content area. When there is more than one CD or DVD drive, all drives will be shown. Pictures and videos are shown as files (with thumbnails) and organized into folders.

To browse a folder, click to open it. To go back up to the folder above it, click the **Up one level** button. If there is more content than will fit on a page, use the buttons at the lower right to scroll through the pages.

Advanced Settings

There are settings in the Aspire Arcade that allow you to fine tune its performance to your machine and your personal preferences. The Settings page is reached by the **Advanced Settings** button on the Home page.

Use the "Screen ratio" setting to choose between standard (4:3) or widescreen (16:9) display.

The "Enable subwoofer" option boosts the bass portion of the audio output.



.....

Note: If your speakers are not capable of outputting low frequency signals, it is recommended that you do not select this option in order to avoid damaging your speakers.

"Audio output" should be set to "Stereo" if you are listening to speakers, or "Virtual surround sound" if you are using headphones.

Click **About Aspire Arcade** to open a page with version and copyright information.

Click **Restore to factory settings** to return the Aspire Arcade settings to their default values.

Arcade controls

When watching video clips, movies, or slideshows as full-screen visual content two pop-up control panels are shown when you move the mouse. They automatically disappear after several seconds. The “Navigation controls” panel appears at the top and the “Player controls” panel appears at the bottom of the screen.

Navigation controls

To return to the Arcade home page, click the **Home** button in the upper left corner of the window. To go up one folder level while searching for content, click **Up one level**. To return to a previous screen, click **Return**. The buttons in the upper right (Minimize, Maximize, and Close) have standard PC behaviours.

To quit Aspire Arcade, click the **Close** button in the upper right corner of the window. You can also click **To PC**.

Player controls

At the bottom of the window, the player controls - used for video, slideshows, movies and music - are shown. The group on the left provides standard playback controls (play, pause, stop, etc...). The group on the right controls volume (mute and volume up/down).



.....
Note: when playing DVDs, there are additional controls added to the right of the volume controls. These are discussed in more detail in the Cinema section of this guide.

Cinema

If your computer came with a DVD drive, you can play movies from DVDs and Video CDs (VCDs) with the Cinema function of Aspire Arcade. This player has the features and controls of a typical living room DVD player.

When you insert a disc into the DVD drive, the movie begins playing automatically. To control the movie, the pop-up player control panel appears at the bottom of the window when you move the mouse.

If more than one optical drive contains a playable disc, click the **Cinema** button on the Home page to open the Cinema content page - then select the disc from the list on the right you'd like to watch.

When viewing DVDs, the following special controls are added to the pop-up panel:

- DVD Menu
- Subtitle
- Language
- Angle

The currently playing disc will be shown in the area above the list of drives. This page is also displayed when you press the "Stop" button during a movie. The buttons on the left side allow you to resume the movie from the point it was stopped, restart the movie from the beginning, jump to the DVD menu, eject the disc, or go to the DVD Settings page.

DVD settings

There are two types of DVD settings - "Video" and "Language." Click the appropriate button to open its settings page.

Video

The Video settings control the video output of DVDs/VCDs.

"Use hardware acceleration" takes advantage of the special processing power in some graphics cards to reduce CPU loading when playing back DVDs and some video files. If you have problems with video quality, try turning this option "Off."

Select an output type:

- **4:3 Standard** or **16:9 Widescreen** according to your display preferences

- The **Letterbox** option displays complete widescreen movie content in its original aspect ratio and adds black bars at the top and bottom of the screen.
- The **Pan & Scan** feature is for DVD titles with a widescreen aspect ratio.
- **Cinema vision** is a nonlinear video stretching technology that produces minimal distortion in the centre of the picture.
- **Stretch** stretches the video display to the size of the display screen.

The “Colour profile” option allows you to select from a list of colour configurations to change the overall colour of the video content during playback. “Original” uses the colour scheme of the disc you are watching, while “Vivid,” “Bright,” and “Theatre” add enhanced colour to the video display.

“Clear vision” is a video enhancement technology that detects video content and dynamically adjusts the brightness/contrast/saturation levels so that you do not need to change the colour settings if the movie you are watching contains scenes that are overly dark or too bright.

Click **Restore to factory settings** to return the settings to their default values.

Language

The Language settings control the audio and subtitle output of DVDs/VCDs.

“Subtitle” selects the default subtitle language for DVDs when available. The factory setting is “Off.”

“Closed caption” turns on the closed captions on DVDs. This function displays captions encoded in the video signal that describe on screen action and dialogue for the hearing impaired. the factory setting is “Off.”

“Audio” selects the default language for DVD titles.

Album

Aspire Arcade lets you view digital photos individually or as a slide-show, from any available drive on your computer. Click **Album** button on the Arcade Home page to show the Album main page.



The content area on the right shows both individual pictures and folders. Click on a folder to open it.

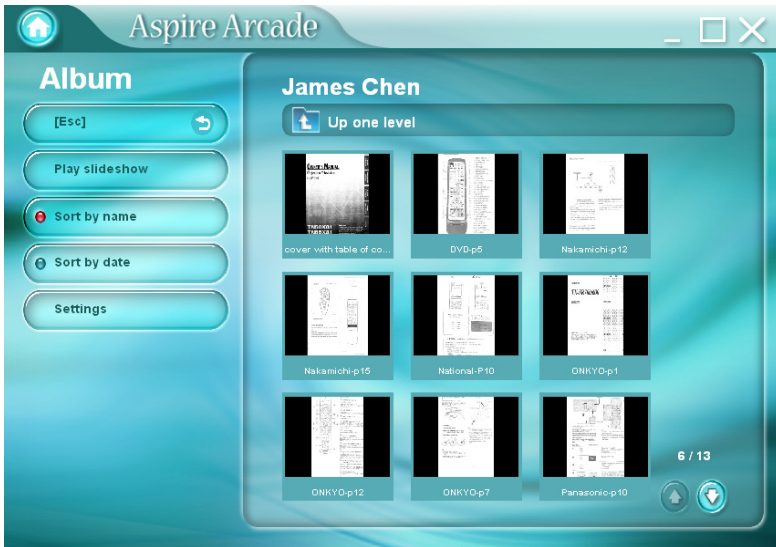

To view a slideshow, open the folder containing the pictures you wish to view - then click **Play slideshow**. The slideshow is played full-screen. Use the pop-up control panel to control the slideshow.

To rotate a picture in full-screen, click **Rotate right** or **Rotate left**.

You can also view a single picture by clicking on it. This opens the picture full-screen.

Slideshow settings

To change slideshow settings click the **Settings** button on the Album page.

The "Slide duration" setting determines how long each slide is shown before automatically advancing to the next picture in the slideshow.

The "Transition effects" setting sets the style of transition used between pictures.

To add background music to a slideshow, set the "Play music during slideshow" option to "Yes." The select music page asks you to choose music from your personal music library.

Click **Restore to factory settings** to return your settings to their default values.

Video

To open the Video function, click **Video** on the Arcade Home page, to open the Video Home page.



Note: The Video feature is designed for video file playback of MPEG1, MPEG2 (if a DVD drive is installed), AVI, WMV, and ASF formats. If you want to watch a DVD or VCD use the Cinema function.

Two options are shown on the Video page - "Video Play" or "Video Edit."

Playing a video file

Click **Video Play** to watch video files. The Video page shows the video files in the content area on the right side. They are organized by folders and a thumbnail image shows the first frame of the video.

To play a video file, click on it. the video will play full-screen. The pop-up control panel will appear at the bottom of the screen when you move the mouse. To return to the Video page, click "Stop."

Editing a video file

Click the **Video Edit** to open the PowerDirector program.

PowerDirector is a digital video editing program that can help you create professional looking movies - complete with music, special effects and transition effects. PowerDirector provides home users with a simple tool to help them do something a little more creative with their home videos. You don't have to be a video professional to enjoy using PowerDirector.

The digital movie production process involves a combination of artistry and technology, beginning with raw video footage and ending with a movie.

Before you edit your movie using PowerDirector, you must first create (or gather) it's component parts - video clips, photos, and music.

When you have your raw footage on hand, you can use PowerDirector to perform the following tasks:

- acquire video and audio content
- trim video and audio content to desired length
- add a special effect to a video clip

- adjust the sharpness, contrast, and/or color of a video clip
- add transition effects between video clips
- preview your production
- burn your production to a VCD or DVD

For help with editing video, refer to PowerDirector's online help system.

Music

For convenient access to your music collection, click the **Music** on the Arcade Home page, to open the Music Home page.

Select the folder that contains the music you want to listen to. Click "Play" to listen to the entire CD from the beginning, or select the song that you want to hear from the list in the content area.

The songs in the folder are shown in the content area, while the left side has controls for "Play", "Random", and "Repeat all." The Visualize option allows you to watch computer generated visualizations while you listen to music. When playing music, the control panel at the bottom of the page makes it easy to adjust the volume and control playback.

To rip music from a CD, click **Rip CD**. In the page that opens, select the songs you would like to rip (or click "Select"/"Clear all") - then click "Rip now".

Burner

NTI CD/DVD-Maker simplifies today's digital lifestyle by providing an easy and complete solution for recording data, audio, photos or video. Now you can burn and share anything on CD/DVD - your music just the way you like it, your photos, your videos. Even copy your critical data faster and easier than ever before.

Copy - backup your CD/DVD collection

Make backup copies of (non-copy protected) CDs in just a few clicks of your mouse. Copy non-copy protected DVDs too!

Audio - create your own greatest hits CDs

Create better sounding music in a snap. Burn your favourite songs to CD so you can listen to them on any CD player. Convert songs from your music collection to MP3 and other popular audio formats.

Even create MP3 CDs with over 100 of your favourite songs and listen to them on you PC or MP3 CD player.

Data - store files simply and easily

Copy your computer's hard drive files for easy recovery in the event of a crash. archiving your data on CD/DVD eliminates the need for extra hard drives.

Video - your world in pictures

Turn digital photos into a Slideshow VCD with background music that can be played by most DVD players. Bring new life to your video clips and share any event with your friends and family for playback on most DVD players. You can even add customized menus to Video CDs and Super Video CDs.

For Specific details about each of these options, consult the User's Guide or click the **Help** button to open NTI CD/DVD-Maker's help menu.

File type compatibility

Mode	Supported	Not Supported
Cinema	DVD/ SVCD VCD/MiniDVD	DTS Liner PCM TruSurroundXT SRS DVD audio
Video	ASF/WMV/AVI MPEG1/2 DivX (requires codec)	DVD navigator SVCD M2V, MOV, Flash
Album	BMP, JPG, PNG	GIF, TIF, PSD, ICO
Music	MP3, WMA, WAV, CDA(Audio CD)	DVD audio, SACD



Note: Auto media detection will only function under main menu.

BIOS Setup Utility

The BIOS (basic input/output system) contains important information used to configure the hardware and system software settings. Your computer reads the BIOS when it first starts up, before it loads the operating system.

Your computer's BIOS includes a built-in setup utility called Insyde Software SCU (system configuration utility). It can be started shortly after you turn the computer on, by pressing the **F2** key during POST.



The BIOS setup utility displays summary information on your computer, its devices, processor and memory.

Your computer is already configured for optimal performance, so you should not need to run this utility. However, you may need to change the BIOS settings if you encounter configuration problems in the future. Refer to "Frequently asked questions" on page 75.

Troubleshooting

This chapter instructs you on how to deal with common system problems. Please read it before calling a technician.

Solutions to more serious problems may require opening the computer. Do not attempt to open and service the computer by yourself. Contact your dealer or an authorized service center for assistance.

Frequently asked questions

This section suggests solutions to commonly encountered problems.

I press the power button, but my computer does not start or boot-up.

Look at the Power status indicator:

- If it is not lit, no power is being delivered to the computer. Check the following:
 - If you are running on battery power, the battery may be low and unable to power the computer. Connect the AC adapter to recharge the battery pack.
 - If you are running on AC power, make sure that the AC adapter is properly plugged in to the computer and to the power outlet.

Nothing appears on the screen.

The computer's power management system automatically blanks the screen to save power. Press any key to turn the display back on.

If pressing a key does not turn the display back on, check the following:

- The brightness level might be too low. Press **Fn** + → hot key to increase the screen brightness level.
- The display device might be set to an external monitor. Press the **Fn** + **F5** key combination to toggle the display setting.
- The system may be in standby mode. Try pressing the power button to resume.

The image is not full-screen.

Make sure that the resolution is set to a resolution your system supports:

- Right click on your Windows desktop and select Properties to bring up the Display Properties dialog box. Or, click on the Display icon in Control Panel.
- Click on the Settings tab to check the resolution setting.

There is no audio coming from my computer.

Check the following:

- The volume may be muted. In Windows, look at the volume control icon on the taskbar. If it is crossed-out, click on the icon and deselect the Mute option.
- The volume level may be too low. In Windows, click on the volume control icon on the taskbar, and then use the slider control to increase the volume level.
- If headphones are connected to the headphone jack on the computer, your computer's built-in speakers will be turned off.

My external microphone does not work.

Check the following:

- Make sure that the external microphone is properly plugged into the microphone-in jack on the computer.
- Make sure that the volume is not muted or set too low.

The keyboard does not respond.

Try attaching an external USB keyboard to one of your computer's USB ports. If it works, the internal keyboard might have become disconnected. Contact your dealer or an authorized service center.

The optical drive cannot read a disc.

Check the following:

- Make sure that the disc is supported by the drive. If your computer has a DVD drive, it can read CDs and DVDs.
- Make sure that the disc is free of scratches or smudges. If the disc is dirty, clean it using a disc cleaning kit.
- If the disc is OK, the drive head might be dirty. Clean it using a drive head cleaning kit.

The printer does not work.

Check the following:

- Make sure that the printer is connected to a power outlet and is turned on.
- Check that the cable is properly connected to the ports on both the computer and the printer.
- If you are using a printer connected to your computer's parallel port, restart the computer. Windows needs to find the new hardware and install the necessary drivers.

I want to set up my location to use the internal modem.

Follow these steps:

- Click on **Start**, and then click on **Control Panel**.
- Double-click on **Phone and Modem Options**.
- In the **Dialing Rules** tab, begin setting up your location.

Refer to Windows Help for more information.

When the battery is 95 - 99% full, it won't charge to 100% capacity.

- To preserve the life of the battery, the system only lets you charge the battery when its capacity falls below 95%. It is recommended that you run down the battery, and then fully recharge it.

Appendix A

Specifications

This appendix lists the general specifications of your computer.

Microprocessor

- Intel® Pentium® M Processor at 1.4 GHz or higher

Memory

- DDR333 256MB/2GB(Max)
- Dual 200-pin soDIMM sockets
- PC2100 / PC2700 DDR SDRAM (Double Date Rate-Synchronous Dynamic Random Access Memory) support
- 512 KB flash ROM BIOS; shadow RAM support

Data storage

- 4-in-1 card reader
- 9.5mm 30GB and up Enhanced-IDE hard disk drive
- One internal optical drive

Display and Video

- 15.4" 16:10 Thin-Film Transistor (TFT) displaying at 1280 x 800(WXGA),16.7M Colors
- ATI Radeon 9700 with 128MB DDR VGA Memory
- Simultaneous LCD and CRT display support
- DualView™ support
- S-video for output to a television or display device that support S-video input
- One 1x16 LCM for multimedia feature and status message showing

Audio

- 2.1 Channel Speaker (with subwoofer)
- MS-Sound compatible
- Audio ports for microphone-in and headphones

Keyboard and pointing device

- 85/86-key Windows keyboard
- Ergonomically-centered touchpad pointing device

I/O ports

- One type II PC Card slot (PCMCIA and CardBus)
- One IEEE 1394 port
- One RJ-11 modem jack (V.92, 56K)
- One RJ-45 network jack (GigabitLAN 100/1000)
- One DC-in jack
- One parallel port
- One S-video port (NTSC/PAL)
- One external monitor port
- One microphone-/line-in jack
- One headphone-/speaker-/line out jack
- Infrared (FIR) port
- Three USB 2.0 ports
- 4 in 1 Card Reader (MS/MMC/SD/SM)

Weight and dimensions

- 15.4"-display model:
 - 3.0 kg (6.6 lbs)
 - 360(W) x 273(D) x 28 ~ 33.49(H) mm
 - (14.2" x 10.7" x 1.1" ~ 1.32")

Environment

- Temperature:
 - Operating: 5°C ~ 35°C
 - Non-operating: -20°C ~ 65°C
- Humidity (non-condensing):
 - Operating: 20% ~ 80% RH
 - Non-operating: 20% ~ 80% RH

Operating system

- Microsoft Windows XP

Power

- 8-cell Li-Ion battery pack
- 65W AC adapter

Options

- Additional AC adapter
- Additional Li-Ion battery pack
- Additional SODIMMs (256/512MB/1GB)

Appendix B

Notices

This appendix lists the general notices for your computer.

Energy Star Guidelines Compliance

As an Energy Star Partner, Acer Inc. has determined that this product meets the Energy Star guidelines for energy efficiency.

FCC notice

This device has been tested and found to comply with the limits for a Class B digital device pursuant to Part 15 of the FCC Rules. These limits are designed to provide reasonable protection against harmful interference in a residential installation. This device generates, uses, and can radiate radio frequency energy and, if not installed and used in accordance with the instructions, may cause harmful interference to radio communications.

However, there is no guarantee that interference will not occur in a particular installation. If this device does cause harmful interference to radio or television reception, which can be determined by turning the device off and on, the user is encouraged to try to correct the interference by one or more of the following measures:

- Reorient or relocate the receiving antenna.
- Increase the separation between the device and receiver.
- Connect the device into an outlet on a circuit different from that to which the receiver is connected.
- Consult the dealer or an experienced radio/television technician for help.

Notice: Shielded cables

All connections to other computing devices must be made using shielded cables to maintain compliance with FCC regulations.

Notice: Peripheral devices

Only peripherals (input/output devices, terminals, printers, etc.) certified to comply with the Class B limits may be attached to this equipment. Operation with non-certified peripherals is likely to result in interference to radio and TV reception.

Caution

Changes or modifications not expressly approved by the manufacturer could void the user's authority, which is granted by the Federal Communications Commission, to operate this computer.

Operation conditions

This device complies with Part 15 of the FCC Rules. Operation is subject to the following two conditions: (1) this device may not cause harmful interference, and (2) this device must accept any interference received, including interference that may cause undesired operation.

Notice: Canadian users

This Class B digital apparatus complies with Canadian ICES-003.

Remarque à l'intention des utilisateurs canadiens

Cet appareil numérique de la classe B est conforme à la norme NMB-003 du Canada.

Declaration of Conformity for EU countries

Hereby, Acer, declares that this Aspire notebook computer is in compliance with the essential requirements and other relevant provisions of Directive 1999/5/EC. (Please visit www.acer.com/about/certificates/nb for complete documents.)

Modem notices

Notice for USA

This equipment complies with Part 68 of the FCC rules. Located on the bottom side of the modem is a label that contains, among other information, the FCC Registration Number and Ringer Equivalence Number (REN) for this equipment. Upon request, you must provide this information to your telephone company.

If your telephone equipment causes harm to the telephone network, the telephone company may discontinue your service temporarily. If possible, they will notify you in advance. But, if advance notice is not practical, you will be notified as soon as possible. You will also be informed of your right to file a complaint with the FCC.

Your telephone company may make changes in its facilities, equipment, operations, or procedures that could affect the proper functioning of your equipment. If they do, you will be notified in advance to give you an opportunity to maintain uninterrupted telephone service.

If this equipment should fail to operate properly, disconnect the equipment from the phone line to determine if it is causing the problem. If

the problem is with the equipment, discontinue use and contact your dealer or vendor.



Caution: To reduce the risk of fire, use only No. 26 AWG or larger UL Listed or CSA Certified Telecommunication Line Cord.

TBR 21

This equipment has been approved [Council Decision 98/482/EC - "TBR 21"] for single terminal connection to the Public Switched Telephone Network (PSTN). However, due to differences between the individual PSTNs provided in different countries, the approval does not, of itself, give an unconditional assurance of successful operation on every PSTN termination point. In the event of problems, you should contact your equipment supplier in the first instance.

List of Applicable Countries

EU member states as of April 2003 are: Belgium, Denmark, Germany, Greece, Spain, France, Ireland, Italy, Luxembourg, the Netherlands, Austria, Portugal, Finland, Sweden, and the United Kingdom. Usage allowed in the countries of European Union, as well as Norway, Switzerland, Iceland and Liechtenstein. This device must be used in strict accordance with the regulations and constraints in the country of use. For further information, please contact local office in the country of use.

Notice for Australia

For safety reasons, only connect headsets with a telecommunications compliance label. This includes customer equipment previously labelled permitted or certified.

Notice for New Zealand

For Modem with approval number PTC 211/03/008

- 1 The grant of a Telepermit for any item of terminal equipment indicates only that Telecom has accepted that the item complies with minimum conditions for connection to its network. It indicates no endorsement of the product by Telecom, nor does it provide any sort of warranty. Above all, it provides no assurance that any item will work correctly in all respects with another item of Telepermitted equipment of a different make or model, nor does it imply that any product is compatible with all of Telecom's network services.
- 2 This equipment is not capable, under all operating conditions, of correct operation at the higher speeds for which it is designed. Telecom will accept no responsibility should difficulties arise in such circumstances.
- 3 Some parameters required for compliance with Telecom's Telepermit requirements are dependent on the equipment (PC) associated with this device. The associated equipment shall be set to operate within the following limits for compliance with Telecom's Specifications:
 - a There shall be no more than 10 call attempts to the same number within any 30 minute period for any single manual call initiation, and
 - b The equipment shall go on-hook for a period of not less than 30 seconds between the end of one attempt and the beginning of the next call attempt.
- 4 Some parameters required for compliance with Telecom's Telepermit requirements are dependent on the equipment (PC) associated with this device. In order to operate within the limits for compliance with Telecom's specifications, the associated equipment shall be set to ensure that automatic calls to different numbers are spaced such that there is not less than 5 seconds between the end of one call attempt and the beginning of another.
- 5 This equipment shall not be set up to make automatic calls to Telecom's 111 Emergency Service.

For Modem with approval number PTC 211/01/030

- 1 The grant of a Telepermit for any item of terminal equipment indicates only that Telecom has accepted that the item complies with minimum conditions for connection to its network. It indicates no endorsement of the product by Telecom, nor does it provide any sort of warranty. Above all, it provides no assurance that any item will work correctly in all respects with another item of Telepermitted equipment of a different make or model, nor does it imply that any product is compatible with all of Telecom's network services.
- 2 This equipment is not capable, under all operating conditions, of correct operation at the higher speeds for which it is designed. Telecom will accept no responsibility should difficulties arise in such circumstances.
- 3 This device is equipped with pulse dialing while the Telecom standard is DTMF tone dialing. There is no guarantee that Telecom lines will always continue to support pulse dialing.
- 4 Use of pulse dialing, when this equipment is connected to the same line as other equipment, may give rise to bell tinkle or noise and may also cause a false answer condition. Should such problems occur, the user should NOT contact the telecom Fault Service.
- 5 This equipment may not provide for the effective hand-over of a call to another device connected to the same line.
- 6 Under power failure conditions this appliance may not operate. Please ensure that a separate telephone, not dependent on local power, is available for emergency use.
- 7 Some parameters required for compliance with Telecom's Telepermit requirements are dependent on the equipment (PC) associated with this device. The associated equipment shall be set to operate within the following limits for compliance with Telecom's specifications, the associated equipment shall be set to ensure that calls are answered between 3 and 30 seconds of receipt of ringing.
- 8 This equipment shall not be set up to make automatic calls to Telecom's 111 Emergency Service.

Important safety instructions

Read these instructions carefully. Save them for future reference.

- 1 Follow all warnings and instructions marked on the product.
- 2 Unplug this product from the wall outlet before cleaning. Do not use liquid cleaners or aerosol cleaners. Use a damp cloth for cleaning.
- 3 Do not use this product near water.
- 4 Do not place this product on an unstable cart, stand, or table. The product may fall, causing serious damage to the product.
- 5 Slots and openings are provided for ventilation; to ensure reliable operation of the product and to protect it from overheating. These openings must not be blocked or covered. The openings should never be blocked by placing the product on a bed, sofa, rug, or other similar surface. This product should never be placed near or over a radiator or heat register, or in a built-in installation unless proper ventilation is provided.
- 6 This product should be operated from the type of power indicated on the marking label. If you are not sure of the type of power available, consult your dealer or local power company.
- 7 Do not allow anything to rest on the power cord. Do not locate this product where persons will walk on the cord.
- 8 If an extension cord is used with this product, make sure that the total ampere rating of the equipment plugged into the extension cord does not exceed the extension cord ampere rating. Also, make sure that the total rating of all products plugged into the wall outlet does not exceed the fuse rating.
- 9 Never push objects of any kind into this product through cabinet slots as they may touch dangerous voltage points or short out parts that could result in a fire or electric shock. Never spill liquid of any kind on the product.
- 10 Do not attempt to service this product yourself, as opening or removing covers may expose you to dangerous voltage points or other risks. Refer all servicing to qualified service personnel.
- 11 Unplug this product from the wall outlet and refer servicing to qualified service personnel under the following conditions:
 - a When the power cord or plug is damaged or frayed.
 - b If liquid has been spilled into the product.
 - c If the product has been exposed to rain or water.

- d If the product does not operate normally when the operating instructions are followed. Adjust only those controls that are covered by the operating instructions since improper adjustment of other controls may result in damage and will often require extensive work by a qualified technician to restore the product to normal condition.
 - e If the product has been dropped or the case has been damaged.
 - f If the product exhibits a distinct change in performance, indicating a need for service.
- 12 This Aspire Notebook Computer uses a lithium battery. Replace the battery with the same type recommended in the product specification list. Use of another battery may present a risk of fire or explosion.
 - 13 **Warning!** Batteries may explode if not handled properly. Do not disassemble or dispose of them in fire. Keep them away from children and dispose of used batteries promptly.
 - 14 Use only the proper type of power supply cord set (provided in your accessories box) for this unit. It should be a detachable type: UL listed/CSA certified, type SPT-2, rated 7A 125V minimum, VDE approved or its equivalent. Maximum length is 15 feet (4.6 meters).
 - 15 Always disconnect all telephone lines from the wall outlet before servicing or disassembling this equipment.
 - 16 Avoid using a telephone (other than a cordless type) during an electrical storm. There may be a remote risk of electric shock from lightning.

Laser compliance statement

The CD or DVD drive used with this computer is a laser product. The CD or DVD drive's classification label (shown below) is located on the drive.

CLASS 1 LASER PRODUCT

CAUTION: INVISIBLE LASER RADIATION WHEN OPEN. AVOID EXPOSURE TO BEAM.

APPAREIL A LASER DE CLASSE 1 PRODUIT

LASERATTENTION: RADIATION DU FAISCEAU LASER INVISIBLE EN CAS D'OUVERTURE. EVITER TOUTE EXPOSITION AUX RAYONS.

LUOKAN 1 LASERLAITE LASER KLASSE 1

VORSICHT: UNSICHTBARE LASERSTRAHLUNG, WENN ABDECKUNG GEÖFFNET NICHT DEM STRAHL AUSSETZEN

PRODUCTO LÁSER DE LA CLASE I

ADVERTENCIA: RADIACIÓN LÁSER INVISIBLE AL SER ABIERTO. EVITE EXPONERSE A LOS RAYOS.

ADVARSEL: LASERSTRÅLING VEDÅBNING SE IKKE IND I STRÅLEN.

VARO! LAVATTAESSA OLET ALTTINA LASERSÄTEILYLLE.

VARNING: LASERSTRÅLNING NÅR DENNA DEL ÅR ÖPPNAD ÅLÅ TUIJOTA SÄTEESEENSTIRRA EJ IN I STRÅLEN

VARNING: LASERSTRÅLNING NAR DENNA DEL ÅR ÖPPNADSTIRRA EJ IN I STRÅLEN

ADVARSEL: LASERSTRÅLING NAR DEKSEL ÅPNESSTIRR IKKE INN I STRÅLEN

LCD pixel statement

The LCD unit is produced with high-precision manufacturing techniques. Nevertheless, some pixels may occasionally misfire or appear as black or red dots. This has no effect on the recorded image and does not constitute a malfunction.

Macrovision copyright protection notice

This product incorporates copyright protection technology that is protected by method claims of certain U.S. patents and other intellectual property rights owned by Macrovision Corporation and other rights owners. Use of this copyright protection technology must be authorized by Macrovision Corporation, and is intended for home and other limited viewing uses only unless otherwise authorized by Macrovision Corporation. Reverse engineering or disassembly is prohibited.

Apparatus Claims of U.S. Patent Nos. 4,631,603, 4,577,216, 4,819,098, 4,907,093, and 6,516,132 licensed for limited viewing uses only.

Radio Device Regulatory Notice

Note: Below regulatory information is for models with wireless LAN and/or Bluetooth™ only.

General

This product complies with the radio frequency and safety standards of any country or region in which it has been approved for wireless use.

Depending on configurations, this product may or may not contain wireless radio devices (such as wireless LAN and/or Bluetooth™ modules). Below information is for products with such devices.

European Union (EU)

This device complies with the essential requirements of the European Council Directives listed below:

73/23/EEC Low Voltage Directive

- EN 60950

89/336/EEC Electromagnetic Compatibility (EMC) Directive

- EN 55022
- EN 55024
- EN 61000-3-2/-3

99/5/EC Radio & Telecommunications Terminal Equipment (R&TTE) Directive

- Art.3.1a) EN 60950
- Art.3.1b) EN 301 489 -1/-17
- Art.3.2) EN 300 328-2

 (for 2.4 GHz device)

Note: The applicable number varies according to the different Notified Body ID No. applied to the wireless module installed in this product. These numbers are subject to change without notice.

List of Applicable Countries

EU member states as of April 2003 are: Belgium, Denmark, Germany, Greece, Spain, France, Ireland, Italy, Luxembourg, the Netherlands, Austria, Portugal, Finland, Sweden, and the United Kingdom. Usage allowed in the countries of European Union, as well as Norway, Switzerland, Iceland and Liechtenstein. This device must be used in strict accordance with the regulations and constraints in the country of use. For further information, please contact local office in the country of use.

The FCC RF safety requirement

The radiated output power of Wireless LAN Mini-PCI Card and Blue-tooth Card is far below the FCC radio frequency exposure limits. Nevertheless, this Aspire Notebook Computer shall be used in such a manner that the potential for human contact during normal operation is minimized as follows.

- 1 Users are requested to follow the RF safety instructions on wireless option devices that are included in the user's guide of each RF option device.



.....

Note: Acer Dual-Band 11b/g Wireless Mini PCI Adapter implements transmission diversity function. The function does not emit radio frequencies simultaneously from both antennas. One of the antennas is selected automatically or manually (by users) to have good quality of radiocommunication.

- 2 An improper installation or unauthorized use may cause harmful interference to radio communications. Also any tampering of the internal antenna will void the FCC certification and your warranty.

Canada - Low power license-exempt radiocommunication devices (RSS-210)

Common information

Operation is subject to the following two conditions:

- 1 This device may not cause interference.
- 2 This device must accept any interference, including interference that may cause undesired operation of the device.

Operation in 2.4 GHz band

To prevent radio interference to the licensed service, this device is intended to be operated indoors and installed outdoors is subject to licensing.

Exposure of humans to RF fields (RSS-102)

Aspire Notebook Computers employ low-gain integral antennas that do not emit RF field in excess of Health Canada limits for the general population; consult Safety Code 6, obtainable from Health Canada's Web site at www.hc-sc.gc.ca/rpb.

Federal Communications Commission Declaration of Conformity

This device complies with Part 15 of the FCC Rules. Operation is subject to the following two conditions: (1) this device may not cause harmful interference, and (2) this device must accept any interference received, including interference that may cause undesired operation.

The following local Manufacturer/Importer is responsible for this declaration:

Product:	Notebook Personal Computer
Model Number:	CL32
Machine Type:	Aspire 2020
SKU Number:	Aspire 202xxx ('x' = 0~9, a ~ z, or A ~ Z)
Name of Responsible Party:	Acer America Corporation
Address of Responsible Party:	2641 Orchard Parkway, San Jose CA 95134, U. S. A.
Contact Person:	Mr. Young Kim
Phone No.:	408-922-2909
Fax No.:	408-922-2606



Acer Incorporated
8F, 88, Sec. 1, Hsin Tai Wu Rd., Hsichih
Taipei Hsien 221, Taiwan, R.O.C.

Tel : 886-2-2696-1234
Fax : 886-2-2696-3535
www.acer.com



Declaration of Conformity for CE marking

We,
Acer Inc.
8F, 88, Sec. 1, Hsin Tai Wu Rd., Hsichih,
Taipei Hsien 221, Taiwan, R. O. C.

Contact Person: Mr. Easy Lai
Tel: 886-2-8691-3089 Fax: 886-2-8691-3000
E-mail: easy_lai@acer.com.tw

Hereby declare that:

Product: Notebook PC
Trade Name: Acer
Model Number: CL32
Machine Type: Aspire 2020
SKU Number: Aspire 202xxx
(*x* = 0~9, a ~ z, or A ~ Z)

Is in compliance with the essential requirements and other relevant provisions of the following EC directives.

Reference No.	Title
89/336/EEC	Electromagnetic Compatibility (EMC directive)
73/23/EEC	Low Voltage Directive (LVD)
1999/5/EC	Radio & Telecommunications Terminal Equipment Directive (R&TTE)

The product specified above was tested conforming to the applicable Rules under the most accurate measurement standards possible, and that all the necessary steps have been taken and are in force to assure that production units of the same product will continue to comply with the requirements.

Easy Lai

Easy Lai / Director
Qualification Center
Product Assurance, Acer Inc.

2004/3/5

Date

Index

A

- ACPI 37
- audio 28, 29
 - connecting externally 44
 - troubleshooting 76–??

B

- battery pack
 - battery-low warning 36
 - caring for v
 - characteristics 33
 - charging 35
 - checking charge level 35
 - installing 34
 - low conditions 36
 - maximizing life 33
 - optimizing 35
 - removing 35
 - using the first time 33
- BIOS Setup Utility 72–??
 - entering 72

C

- care
 - battery pack v
 - computer iv

CD

- troubleshooting 76

charging

- checking level 35

cleaning

- computer v

computer

- bringing to meetings 51
- caring for iv
- cleaning v
- disconnecting 51
- features 12
- moving around 51
- security 30
- setting up a home office 52
- taking home 52
- traveling internationally 54
- traveling on local trips 53
- turning off iii

connections

- audio 44
- external display devices 41
- external input devices 41
- keyboard, external 41
- keypad, external 41
- mouse 41
- printer 44
- USB 42

connectivity options 26

- Ethernet 26

D

- display 13
 - troubleshooting 75

DVD

- troubleshooting 76

E

- Ethernet connection 26

F

- FAQ. See frequently-asked questions
- frequently-asked questions 75
- front view 4

H

- hard disk 24
 - upgrading 48

K

- Keyboard 16
 - Lock keys 16

keyboard

- connecting externally 41
- embedded numeric keypad 17
- troubleshooting 76
- Windows keys 18

keypad

- connecting externally 41

L

- launch keys 23

M

memory

- installing 47– 48
- upgrading 47

microphone

- troubleshooting 76

- modem
 - setting location 77
- mouse
 - connecting externally 41
- N
- notice
 - DVD copyright protection 94
- numeric keypad
 - embedded 17
- O
- optical drive 24
- options
 - hard disk upgrade 48
 - memory upgrade 47
 - PC Cards 45
- P
- password 30
- PC Card
 - inserting 45
 - removing 46
- power management 37
- printer
 - connecting 44
 - troubleshooting 76
- problems 75
 - audio 76-??
 - CD 76
 - display 75
 - DVD 76
 - keyboard 76
 - printer 76
 - startup 75
- R
- right view 6, 9
- S
- safety
 - CD or DVD 93
 - FCC notice 87
 - general instructions 92
 - modem notices 88
- security
 - password 30
 - slot 30
- service
 - when to call v
- software
 - bundled 57
- speakers
 - troubleshooting 76
- storage 24
 - hard disk 24
 - optical drive 24
- T
- Touchpad 21
- touchpad 21
 - using 21- 22
- travel
 - international flights 54
 - local trips 53
- U
- USB
 - connecting 42
- utility
 - BIOS Setup 72-??
- W
- Windows 61
- Windows keys 18

Free Manuals Download Website

<http://myh66.com>

<http://usermanuals.us>

<http://www.somanuals.com>

<http://www.4manuals.cc>

<http://www.manual-lib.com>

<http://www.404manual.com>

<http://www.luxmanual.com>

<http://aubethermostatmanual.com>

Golf course search by state

<http://golfingnear.com>

Email search by domain

<http://emailbydomain.com>

Auto manuals search

<http://auto.somanuals.com>

TV manuals search

<http://tv.somanuals.com>