

Acer TravelMate 290E Series

Service Guide

Service guide files and updates are available on the ACER/CSD web; for more information, please refer to <http://csd.acer.com.tw>

PART NO.: VD.T40V5.001

PRINTED IN TAIWAN

Revision History

Please refer to the table below for the updates made on TravelMate 290E service guide.

Date	Chapter	Updates

Copyright

Copyright © 2003 by Acer Incorporated. All rights reserved. No part of this publication may be reproduced, transmitted, transcribed, stored in a retrieval system, or translated into any language or computer language, in any form or by any means, electronic, mechanical, magnetic, optical, chemical, manual or otherwise, without the prior written permission of Acer Incorporated.

Disclaimer

The information in this guide is subject to change without notice.

Acer Incorporated makes no representations or warranties, either expressed or implied, with respect to the contents hereof and specifically disclaims any warranties of merchantability or fitness for any particular purpose. Any Acer Incorporated software described in this manual is sold or licensed "as is". Should the programs prove defective following their purchase, the buyer (and not Acer Incorporated, its distributor, or its dealer) assumes the entire cost of all necessary servicing, repair, and any incidental or consequential damages resulting from any defect in the software.

Acer is a registered trademark of Acer Corporation.

Intel is a registered trademark of Intel Corporation.

Pentium and Pentium II/III are trademarks of Intel Corporation.

Other brand and product names are trademarks and/or registered trademarks of their respective holders.

Conventions

The following conventions are used in this manual:

SCREEN MESSAGES	Denotes actual messages that appear on screen.
NOTE	Gives bits and pieces of additional information related to the current topic.
WARNING	Alerts you to any damage that might result from doing or not doing specific actions.
CAUTION	Gives precautionary measures to avoid possible hardware or software problems.
IMPORTANT	Reminds you to do specific actions relevant to the accomplishment of procedures.

Preface

Before using this information and the product it supports, please read the following general information.

1. This Service Guide provides you with all technical information relating to the BASIC CONFIGURATION decided for Acer's "global" product offering. To better fit local market requirements and enhance product competitiveness, your regional office MAY have decided to extend the functionality of a machine (e.g. add-on card, modem, or extra memory capability). These LOCALIZED FEATURES will NOT be covered in this generic service guide. In such cases, please contact your regional offices or the responsible personnel/channel to provide you with further technical details.
2. Please note WHEN ORDERING FRU PARTS, that you should check the most up-to-date information available on your regional web or channel. If, for whatever reason, a part number change is made, it will not be noted in the printed Service Guide. For ACER-AUTHORIZED SERVICE PROVIDERS, your Acer office may have a DIFFERENT part number code to those given in the FRU list of this printed Service Guide. You MUST use the list provided by your regional Acer office to order FRU parts for repair and service of customer machines.

Chapter 1	System Specifications	1
	Features	1
	System Block Diagram	3
	Board Layout	4
	Top View	4
	Bottom View	5
	Outlook View	6
	Front Open View	6
	Front View	7
	Left Panel	8
	Right Panel	9
	Rear Panel	10
	Bottom Panel	11
	Indicators	12
	Lock Keys	14
	Embedded Numeric Keypad	15
	Windows Keys	16
	Hot Keys	17
	The Euro Symbol	18
	Launch Keys	19
	Touchpad	20
	Touchpad Basics	20
	Hardware Specifications and Configurations	21
Chapter 2	System Utilities	33
	BIOS Setup Utility	33
	Navigating the BIOS Utility	33
	Main	34
	Advanced	35
	Security	38
	Boot	40
	Exit	41
	BIOS Flash Utility	42
Chapter 3	Machine Disassembly and Replacement	43
	General Information	44
	Before You Begin	44
	Disassembly Procedure Flowchart	45
	Removing ODD Module, Memory and HDD Module	48
	Removing the ODD Module	48
	Removing the Memory	48
	Removing the HDD Module	48
	Removing the Keyboard/LCD Module	49
	Removing the Keyboard	49
	Removing the LCD module	49
	Disassembling the Main Unit	51
	Disassembling the LCD Module	57
	Disassembling the External Modules	59
	Disassembling the HDD Module	59
	Disassembling the Optical Disk Drive Module/Combo Drive Module	59
Chapter 4	Troubleshooting	61
	System Check Procedures	62
	External Diskette Drive Check	62

Table of Contents

External CD-ROM/DVD-ROM Drive Check	62
Keyboard or Auxiliary Input Device Check	63
Memory Check	63
Power System Check	63
Touchpad Check	65
Display Check	65
Sound Check	66
Insyde MobilePro BIOS POST Beep Code and POST Messages	67
Index of Symptom-to-FRU Error Message	69
Intermittent Problems	72
Undetermined Problems	73
Chapter 5 Jumper and Connector Locations	75
Top View	75
SW1 Settings (Lid switch)	76
SW3 Settings(Kill Switch)	76
Bottom View	77
Chapter 6 FRU (Field Replaceable Unit) List	79
TravelMate 290E Series	94
Appendix A Model Definition and Configuration	94
Appendix B Test Compatible Components	95
Microsoft® Windows® XP Home Environment Test	96
Microsoft® Windows® XP Pro Environment Test	99
Appendix C Online Support Information	103
Index	105

System Specifications

Features

This computer was designed with the user in mind. Here are just a few of its many features:

Performance

- Intel® Celeron® M processor at 1.2 ~ 1.5 GHz or higher, or Intel® Pentium® M Processor at 1.3 ~ 1.7 GHz or higher
- Intel 852GM Chipset
- Memory upgradeable up to 2GB with 2 slots
- Internal removable optical drive (AcerMedia bay)
- High-capacity, Enhanced-IDE hard disk
- Li-Ion main battery pack
- Power management system with ACPI (Advanced Configuration Power Interface)

Display

- 14.1" or 15.0" Thin-Film Transistor (TFT) displaying at 1024x768 XGA resolution or 15.0" Thin-Film Transistor (TFT) displaying at 1400x1050 SXGA+ resolution
- 3D graphics engine
- Simultaneous LCD and CRT display support
- S-video for output to a television or display device that supports S-video input
- Dual display capability

Multimedia

- 16-bit high-fidelity AC'97 Codec stereo audio
- Built-in dual speakers
- High-speed optical drive (AcerMedia bay)

Connectivity

- High-speed fax/data modem port
- Ethernet/Fast Ethernet port
- Fast infrared wireless communication
- Three USB 2.0 (Universal Serial Bus) ports (Two in rear and one on left)
- InviLink 802.11b/g wireless LAN (manufacturing optional)
- Bluetooth ready (manufacturing optional)

Expansion

- One type II CardBus PC Card slot
- Upgradeable memory

I/O Ports

- One type II CardBus PC Card slot
- One RJ-45 jack (Ethernet 10/100)
- One RJ-11 phone jack (V.92)

-
- One DC-in jack for AC adapter
 - One parallel port
 - One VGA port for external monitor
 - One speaker/headphone-out jack (3.5mm mini jack)
 - One microphone-in jack
 - Three USB 2.0 ports (Two in rear and one on left)
 - One FIR port (IrDA)

Board Layout

Top View

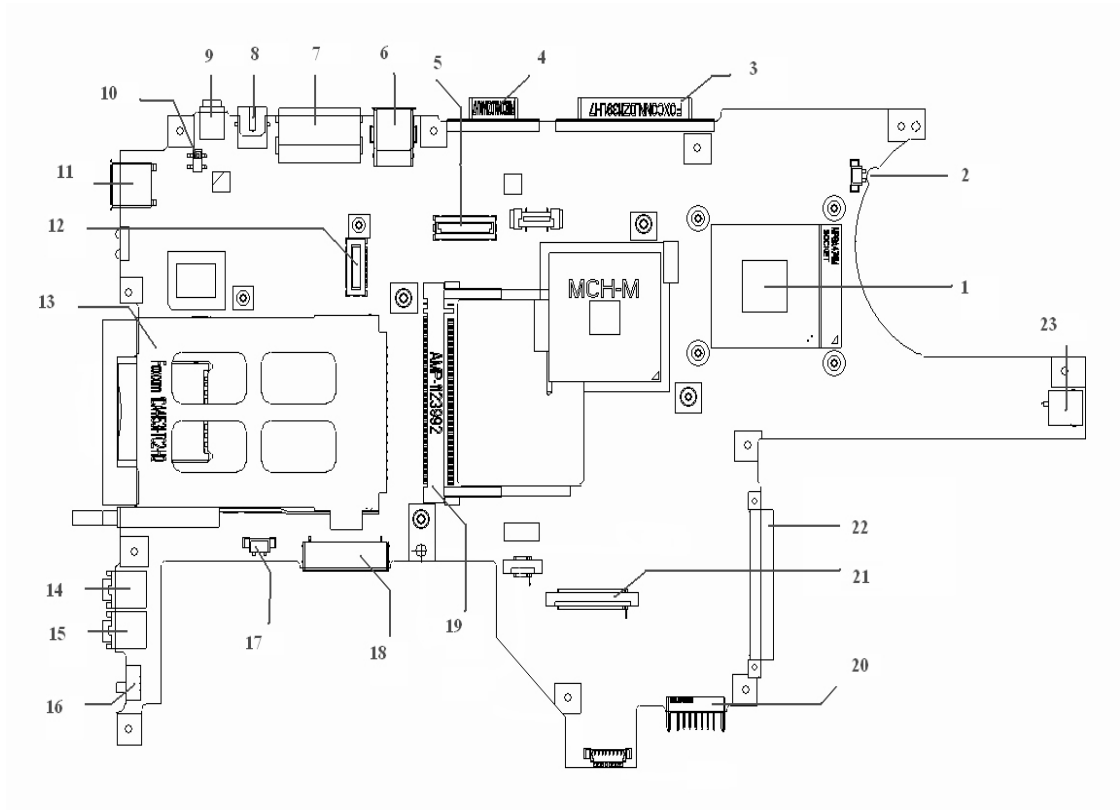

1-JP12	CPU Socket	14-JP20	MIC in Jack
2-JP7	FAN Connector	15-JP23	Headphone out Jack
3-JP2	Parallel Port	16-SW3	Wireless Kill Switch
4-JP1	CRT Connector	17-JP18	Speakers Connector
5-JP10	LCD Connector	18-JP17	Module Connector
6-JP6	USB Connectors (*2)	19-JP13	Mini PCI Connector
7-JP5	RJ11/RJ45 Connectors	20-PJP9	Battery Connector
10-SW1	Lid Switch	21-JP21	Keyboard Connector
11-JP8	USB Connector	22-JP22	HDD Connector
12-JP11	MDC/MBC Connector	23-PCN1	DC-In Jack
13-JP15	PCMCIA Connector		

Bottom View

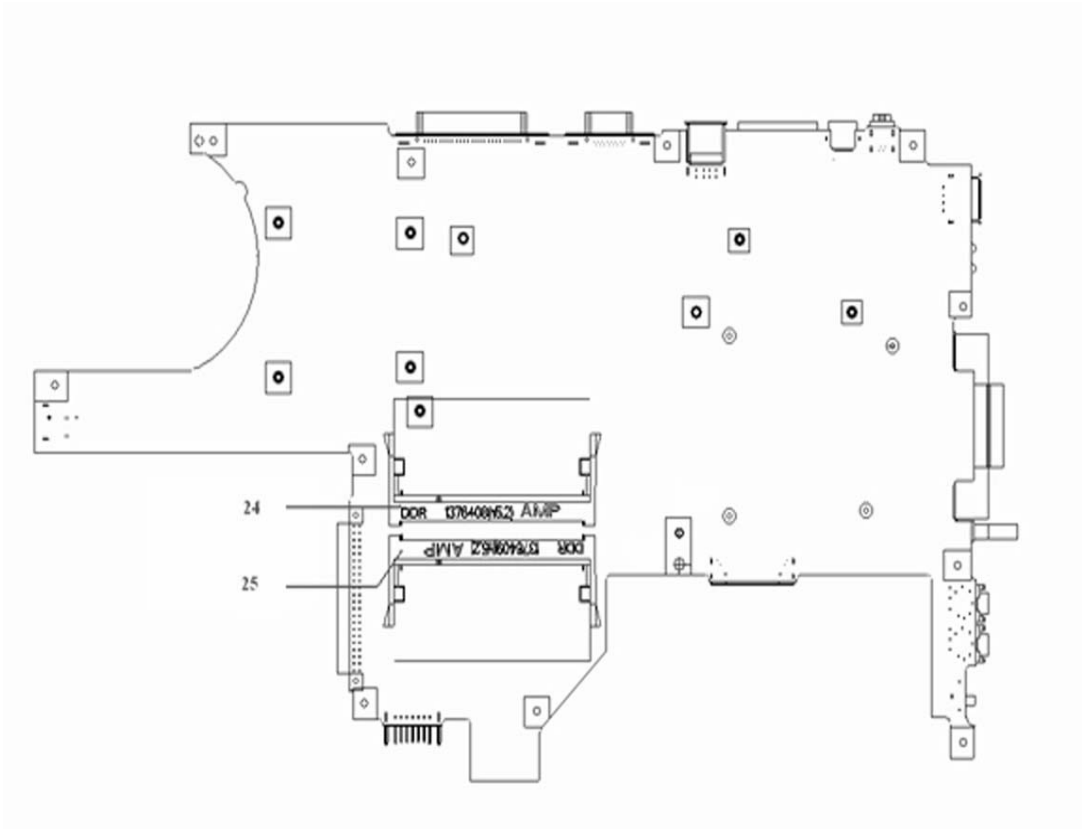

24-JP25 SO-DIMM Socket

25-JP26 SO-DIMM Socket

Outlook View

A general introduction of ports allow you to connect peripheral devices, as you would with a desktop PC.

Front Open View

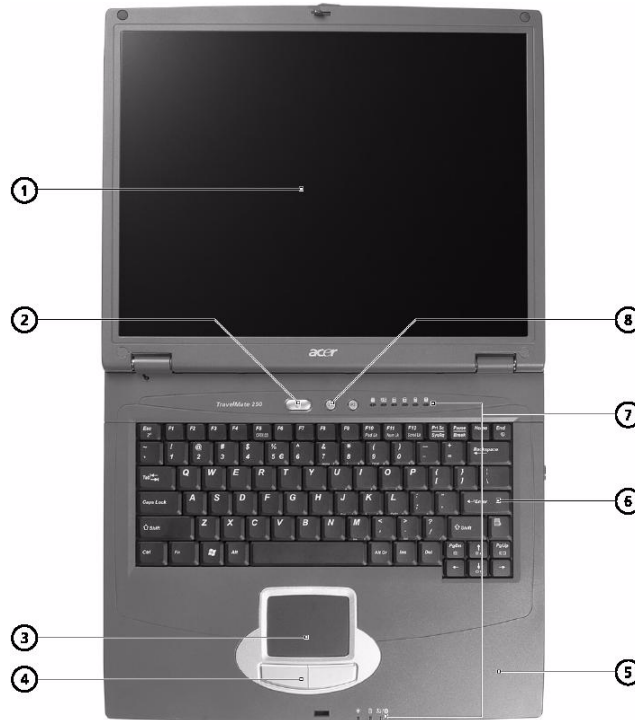

#	Icon	Item	Description
1		Display screen	Also called LCD (liquid-crystal display), displays computer output.
2		Power Button	Turns on the computer power.
3		Touchpad	Touch-sensitive pointing device which functions like a computer mouse.
4		Click buttons (left and right)	The left and right buttons function like the left and right mouse buttons; the center button serves as a 4-way scroll button.
5		Palmrest	Comfortable support area for your hands when you use the computer.
6		Keyboard	Inputs data into your computer.
7		Status indicators	LEDs (light-emitting diode) that turn on and off to show the status of the computer, its functions and components.
8		Launch keys	Two special keys for frequently used programs.



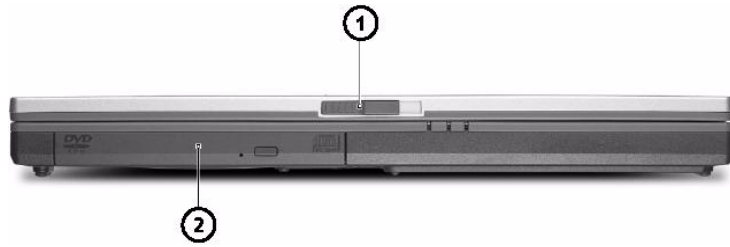



Front View

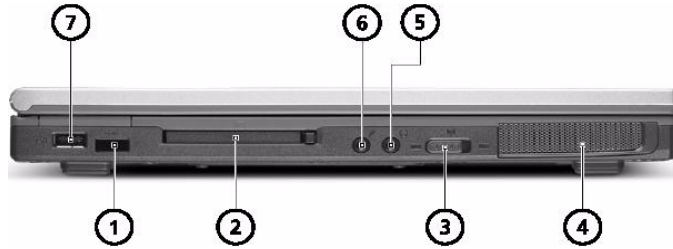

#	Icon	Item	Description
1		Latch	Latch for opening and closing the computer.
2		AcerMedia bay	For hot-swappable modules including 24x CD-ROM, 8x DVD-ROM, or 24/10/8/24x DVD/CD-RW combo or 2x DVD-RW.



Left Panel



#	Icon	Item	Description
1		Infrared port	Interfaces with infrared devices (e.g., infrared printer, IR-aware computer).
2		PC card slot	Accepts one Type II 16-bit PC card or 32-bit CardBus PC card.
3		Wireless communication switch	Enables and disables wireless communication devices.
4		Stereo speaker	Outputs sound.
5		Headphone/Speaker/Line-out jack	Connects to headphones or other line-out audio devices (speakers).
6		Microphone/Line-in jack	Accepts input from external microphone, or other audio line-in devices (e.g., audio CD player, stereo walkman and etc.).
7		One USB 2.0 port	Connects to Universal Serial Bus devices (e.g., USB mouse, USB camera).

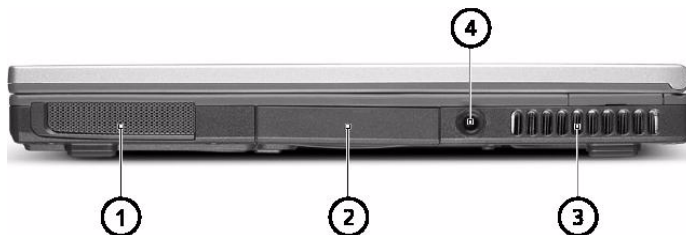





Right Panel

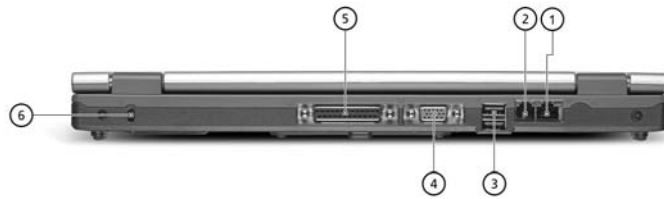

#	Icon	Item	Description
1		Stereo speaker	Outputs sound.
2		HDD	Houses the computer hard disk.
3		Ventilation slot	Enables the computer to stay cool, even after prolonged use.
4		DC-in jack	Connects the AC adapter.

Rear Panel



#	Icon	Item	Description
1		Ethernet port	Connects to an Ethernet 10/100-based network.
2		Modem port	Connects to a phone line.
3		Two USB 2.0 ports	Connects to Universal Serial Bus devices (e.g., USB mouse, USB camera).
4		External display port	Connects to a display device (e.g., external monitor, LCD projector).
5		Parallel port	Connects to a parallel device (e.g., parallel printer).
6		Security keylock	Connects to a Kensington-compatible computer security lock.

Bottom Panel

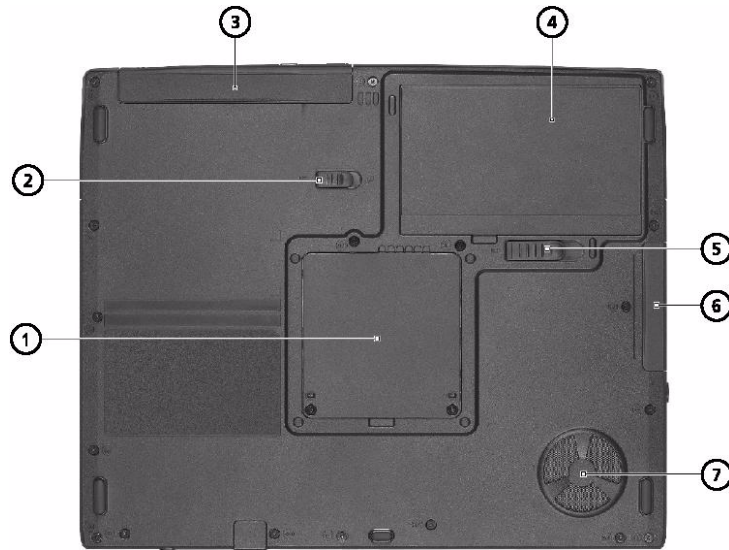









#	Icon	Item	Description
1		Memory compartment	Houses the computer's main memory.
2		AcerMedia bay release latch	Unlatches the AcerMedia drive for removing the optical drive.
3		AcerMedia bay	Houses an AcerMedia drive module.
4		Battery bay	Houses the computer's battery pack.
5		Battery release latch	Unlatches the battery to remove the battery pack.
6		Hard disk bay	Houses the computer's hard disk (secured by a screw).
7		Cooling fan	Helps keep the computer cool. Note: Don't cover or obstruct the opening of the fan.

Indicators

The computer has six easy-to-read status icons below the display screen.



The status LCD displays icons that show the status of the computer and its components.

Icon	Function	Description
	HDD	Lights when Hard Disk Drive is activated.
	ODD	Lights when Optical Disk Drive is activated.
	Scroll lock	Lights when Scroll Lock is activated.
	Caps lock	Lights when Caps Lock is activated.
	Pad lock (cursor)	Lights when Pad lock is activated.
	Num lock	Lights when Num Lock is activated.
	Wireless/Bluetooth indicator	Orange indicators that wireless LAN is enables; blue indicators that Bluetooth (optional) is enabled Lights when the Wireless LAN or Bluetooth capabilities are enabled.
	Power	Lights green when the power is on. Flashes when the computer is in standby mode.
	Battery	Lights green. Flashes when the battery is being charged or low capacity.



-
1. **Charging:** Flashing 1 sec. and off 3 sec.
 2. **Low capacity (about 10%):** Flashing 0.25 sec. and off 0.25 sec.
 3. **Critically low capacity (about 3%):** Flashing 0.1 sec. and off 0.1 sec.
 4. **Fully charged:** Stead on

NOTE: If the user plugs in the wrong power adapter (less than 60 watts), the indicator of system and battery status flash 0.5 sec. and off 0.5 sec. simultaneously. And a beeping sound occurs for 2 sec. if the speakers are on. Using the original adapter is strongly recommended.

Lock Keys

The keyboard has four lock keys which you can toggle on and off.



Lock Key	Description
Caps Lock	When Caps Lock is on, all alphabetic characters typed are in uppercase.
Pad lock (Fn-F10)	When Pad Lock is on, the embedded keypad is enabled. In this mode the keypad is cursor function.
Num lock (Fn-F11)	When Num Lock is on, the embedded keypad is in numeric mode. The keys function as a calculator (complete with the arithmetic operators +, -, *, and /). Use this mode when you need to do a lot of numeric data entry. A better solution would be to connect an external keypad.
Scroll lock (Fn-F12)	When Scroll Lock is on, the screen moves one line up or down when you press  and  respectively. Scroll Lock does not work with some applications.

Embedded Numeric Keypad

The embedded numeric keypad functions like a desktop numeric keypad. It is indicated by small characters located on the right hand side of the keycaps.











Desired Access	Num Lock On	Num Lock Off
Number keys on embedded keypad	Type numbers in a normal manner.	
Main keyboard keys	Hold <Fn> while typing letters on embedded keypad.	Type the letters in a normal manner.

Windows Keys

The keyboard has two keys that perform Windows-specific functions.









Key	Icon	Description
Windows logo key		Start button. Combinations with this key perform special functions. Below are a few examples:  + Tab (Activates next taskbar button)  + E (Explores My Computer)  + F (Finds Document)  + M (Minimizes All)  +  + M (Undoes Minimize All)  + R (Displays the Run... dialog box)
Application key		Opens a context menu (same as a right-click).

Hot Keys

The computer uses hotkey or key combinations to access most of the computer's controls like screen brightness and volume output.

To activate hot keys, press and hold the **Fn** key before pressing the other key in the hot key combination.



Hot Key	Icon	Function	Description
Fn-Esc		Sleep	Puts the computer in Sleep mode.
Fn-F5		Display toggle	Switches display output between the display screen, external monitor (if connected) and both the display screen and external monitor.
Fn-End		Speaker toggle	Turns the speakers on and off.
Fn-PgUp		Volume up	Increases the speaker volume.
Fn-PgDn		Volume down	Decreases the speaker volume.
Fn-F10		Brightness up	Increases the screen brightness.
Fn-F9		Brightness down	Decreases the screen brightness

The Euro Symbol

If your keyboard layout is set to United States-International or United Kingdom or if you have a keyboard with a European layout, you can type the Euro symbol on your keyboard.



NOTE: For US keyboard users: The keyboard layout is set when you first set up Windows. For the Euro symbol to work, the keyboard layout has to be set to United States-International.

To verify the keyboard type in Windows 2000 and Windows Millennium Edition, follow the steps below:

1. Click on **Start, Settings, Control Panel**.
2. Double-click on **Keyboard**.
3. Click on the **Language** tab.
4. Verify that keyboard layout used for "En English (United States)" is set to United States-International. If not, select and click on **Properties**; then select **United States-International** and click on **OK**.
5. Click on **OK**.

To verify the keyboard type in Windows XP, follow the steps below:

1. Click on **Start, Control Panel**.
2. Double-click on **Regional and Language Options**.
3. Click on the **Language** tab and click on **Details**.
4. Verify that the keyboard layout used for "En English (United States)" is set to United States-International. If not, select and click on **ADD**; then select **United States-International** and click on **OK**.
5. Click on **OK**.

To type the Euro symbol:

1. Locate the Euro symbol on your keyboard.
2. Open a text editor or word processor.
3. Hold **Alt Gr** and press the Euro symbol.

NOTE: Some fonts and software do not support the Euro symbol. Please refer to www.microsoft.com/typography/faq/faq12.htm for more information.

Launch Keys

Located at the top of keyboard are three buttons. The left-most button is the power button. To the right of the power button are the two launch keys. They are designated as the programmable buttons (P1 and P2).



Launch Key	Default application
P1	User-programmable
P2	User-programmable

Touchpad

The built-in touchpad is a pointing device that senses movement on its surface. This means the cursor responds as you move your finger on the surface of the touchpad. The central location on the palmrest provides optimum comfort and support.



Touchpad Basics

The following items teach you how to use the touchpad:



- ❑ Move your finger across the touchpad to move the cursor.
- ❑ Press the left and right buttons located on the edge of the touchpad to do selection and execution functions. These two buttons are similar to the left and right buttons on a mouse. Tapping on the touchpad produces similar results.

Function	Left Button	Right Button	Tap
Execute	Click twice quickly		Tap twice (at the same speed as double-clicking the mouse button)
Select	Click once		Tap once
Drag	Click and hold, then use finger to drag the cursor on the touchpad		Tap twice (at the same speed as double-clicking a mouse button) then hold finger to the touchpad on the second tap to drag the cursor
Access context menu		Click once	

NOTE: Keep your fingers dry and clean when using the touchpad. Also keep the touchpad dry and clean. The touchpad is sensitive to finger movements. Hence, the lighter the touch, the better the response. Tapping harder will not increase the touchpad's responsiveness.

Hardware Specifications and Configurations

Processor

Item	Specification
CPU type	Intel® Celeron® M Processor at 1.2~1.5 GHz or higher, or Intel® Pentium® M Processor at 1.3~1.7 GHz
CPU package	µ FCBGA package
CPU core voltage	Intel® Pentium® M Processor supports automatic selection of power supply voltage
CPU I/O voltage	1.05V

BIOS

Item	Specification
BIOS vendor	Insyde
BIOS Version	Insyde MobilePRO BIOS 4.0
BIOS ROM type	Flash ROM
BIOS ROM size	512KB
BIOS package	32 lead of PLCC
Supported protocols	ACPI 1.0b, PC Card 95, SM BIOS 2.3, EPP/IEEE 1284, ECP/IEEE 1284 1.7 & 1.9, PCI 2.2, PnP 1.0a, DMI 2.0, USB, VGA BIOS, CD-ROM bootable
BIOS password control	Set by setup manual

Second Level Cache

Item	Specification
Cache controller	Built-in CPU
Cache size	Intel(R) Celeron(R) M Processor 512KB Intel(R) Pentium(R) M Processor 1M
1st level cache control	Always enabled
2nd level cache control	Always enabled
Cache scheme control	Fixed in write-through

System Memory

Item	Specification
Memory controller	Intel 852GM
Memory size	128MB/256MB/512MB/1024MB(1GB)
DIMM socket number	2 sockets
Supports memory size per socket	1024MB
Supports maximum memory size	2GB (by two 1024MB SO-DIMM module)
Supports DIMM type	DDR Synchronous DRAM
Supports DIMM Speed	200/266 MHz
Supports DIMM voltage	2.5V
Supports DIMM package	200-pin SO-DIMM
Memory module combinations	You can install memory modules in any combinations as long as they match the above specifications.

Memory Combinations

Slot 1	Slot 2	Total Memory
0MB	128MB	128MB
0MB	256MB	256MB
0MB	512MB	512MB
0MB	1024MB	1024MB
128MB	0MB	128MB
128MB	128MB	256MB
128MB	256MB	384MB
128MB	512MB	640MB
128MB	1024MB	1152MB
256MB	0MB	256MB
256MB	128MB	384MB
256MB	256MB	512MB
256MB	512MB	768MB
256MB	1024MB	1280MB
512MB	0MB	512MB
512MB	128MB	640MB
512MB	256MB	768MB
512MB	512MB	1024MB
512MB	1024MB	1536MB
1024MB	0MB	1024MB
1024MB	128MB	1152MB
1024MB	256MB	1280MB
1024MB	512MB	1536MB
1024MB	1024MB	2048MB(2G)

NOTE: Above table lists some system memory configurations. You may combine DIMMs with various capacities to form other combinations.

LAN Interface

Item	Specification
Supports LAN protocol	10/100 Mbps
LAN connector type	RJ45
LAN connector location	Rear side

Modem/Bluetooth Interface

Item	Specification
Data modem data baud rate (bps)	56K
Supports modem/bluetooth protocol	V.92 for MDC / Bluetooth 1.1 standard for BT modem
Modem connector type	RJ11
Modem connector location	Rear side

Hard Disc Drive Interface(1)

Item	Specification							
Vendor & Model Name	Toshiba 20G MK2023 GAS	Toshiba 30G MK3021 GAS	Toshiba 40G MK4021 GAS	Toshiba 60G MK6021 GAS	Hitachi 20G IC25N02 0-ATMR04	Hitachi 30G IC25N03 0-ATMR04	Hitachi 40G IC25N04 0-ATMR04	Hitachi 60G IC25N06 0-ATMR04
Capacity (MB)	20000	30000	40000	60000	20000	30000	40000	60000
Bytes per sector	512	512	512	512	512	512	512	512
Data heads	2	2	3	4	1	2	2	3
Drive Format								
Disks	1	1	2	2	1	1	1	2
Spindle speed (RPM)	4200 RPM	4200 RPM	4200 RPM	4200 RPM	4200 RPM	4200 RPM	4200 RPM	4200 RPM
Performance Specifications								
Buffer size	2048KB	2048KB	2048KB	2048KB	2048KB	2048KB	2048KB	2048KB
Interface	ATA-5	ATA-5	ATA-5	ATA-5	ATA-5	ATA-5	ATA-5	ATA-5
Max. media transfer rate (disk-buffer, Mbytes/s)	164.6~257.1	154.3~298.0	154.3~298.0	154.3~298.0	350	350	350	350
Data transfer rate (host-buffer, Mbytes/s)	100 MB/Sec. Ultra DMA mode-5	100 MB/Sec. Ultra DMA mode-5	100 MB/Sec. Ultra DMA mode-5	100 MB/Sec. Ultra DMA mode-5	100 MB/Sec. Ultra DMA mode-5	100 MB/Sec. Ultra DMA mode-5	100 MB/Sec. Ultra DMA mode-5	100 MB/Sec. Ultra DMA mode-5
DC Power Requirements								
Voltage tolerance	5V(DC) +/- 5%	5V(DC) +/- 5%	5V(DC) +/- 5%	5V(DC) +/- 5%	5V(DC) +/- 5%	5V(DC) +/- 5%	5V(DC) +/- 5%	5V(DC) +/- 5%

Hard Disc Drive Interface(2)

Item	Specification			
Vendor & Model Name	Seagate 40G Neptune ST94011A (5400rpm) f/w code 3.05	HGST 40G MORAGA HTS548040M9AT 00	HGST 60G MORAGA HTS548060M9AT 00	Toshiba 60G Triton MK6022GAX
Capacity (MB)	40000	40000	60000	60000
Bytes per sector	512	512	512	512
Data heads	2	2	3	4
Drive Format				
Disks	1	1	2	2
Spindle speed (RPM)	5400RPM	5400RPM	5400RPM	5400RPM
Performance Specifications				
Buffer size	8MB	8MB	8MB	16384KB

Hard Disc Drive Interface(2)

Item	Specification			
Interface	Ultra ATA/100 IDE/ATAP	ATA-6	ATA-6	ATA-5
Data transfer rate (host~buffer, Mbytes/s)	100 MB/Sec. Ultra DMA mode- 5	100 MB/Sec. Ultra DMA mode- 5	100 MB/Sec. Ultra DMA mode- 5	100 MB/Sec. Ultra DMA mode- 5
DC Power Requirements				
Voltage tolerance	5V(DC) +/- 5%	5V(DC) +/- 5%	5V(DC) +/- 5%	5V(DC) +/- 5%

DVD-ROM Interface

Item	Specification	
Vendor & model name	Toshiba (SR-C2612)	
Performance Specification	With CD Diskette	With DVD Diskette
Transfer rate (KB/sec)	(Mode1) 4X-5.7X PCAV 600-855KByte/s 10.3X-24X CAV 1552-3600KByte/s (Mode2) 4X-5.7X PACV 684.4-975.3KBytes/s 10.3X-24X CAV 1769-4104KByte/s	3.3X-8X CAV 4463-10820KByte/s
Data Buffer Capacity	192 KBytes	
Interface	IDE/ATAPI	
Applicable disc format	DVD: DVD-ROM (DVD-5, DVD-9, DVD-10, DVD-18),DVD-R (read, single border), DVD-RW(read) DVD-RAM (read, Version2.1), DVD-RAM (read, Version 1.0) CD: CD-Audio, CD+(E)G, CD-MIDI, CD-TEXT, CD-ROM, CD-ROM XA, CD-I, CD-I Bridge (Photo-CD, Video-CD) Multisession CD (Photo-CD, CD-EXTRA, CD-R, CD-RW), CD-R (read), CD-RW (read)	
Loading mechanism	Load: Manual Release: (a) Electrical Release (Release Button) (b) Release by ATAPI command (c) Emergency Release	
Power Requirement		
Input Voltage	+5 V +/- 5 % (Operating) +/- 8 % (Start up)	
Input Voltage	+5 V +/- 0.25V	

Audio Interface

Item	Specification
Audio Controller	Realtek ALC202 AC97 Codec
Audio onboard or optional	Built-in
Mono or Stereo	Stereo
Resolution	20 bit stereo Digital to Analog converter 18 bit stereo Analog to Digital converter
Compatibility	AC97 2.2 & WHQL spec.
Mixed sound source	CD
Sampling rate	48 KHz
Internal microphone	No
Internal speaker / Quantity	Yes / 2

Video Interface

Item	Specification
Video vendor	Intel
Video name	Intel 852GM
Chip voltage	Core/1.2V
Supports ZV (Zoomed Video) port	No

Parallel Port

Item	Specification
Parallel port controller	SMC LP47N217
Number of parallel port	One
Location	Rear side
Connector type	25-pin D-type connector, in female type
Parallel port function control	Enable/Disable/Auto (BIOS or operating system chooses configuration) by BIOS setup Note: Depending on your operating system, disabling an unused device may help free system resources for other devices.
Supports ECP/EPP/Bi-directional (PS/2 compatible)	Yes (set by BIOS setup) Note: When Mode is selected as EPP mode, "3BCh" will not be available.
Optional ECP DMA channel (in BIOS setup)	DMA channel 1
Optional parallel port I/O address (in BIOS setup)	378h, 278h
Optional parallel port IRQ (in BIOS setup)	IRQ7, IRQ5

USB Port

Item	Specification
USB compliancy level	2.0
OHCI	USB 2.0
Number of USB port	3
Location	Two on rear and one on left
Serial port function control	Enable/Disable by BIOS setup

PCMCIA Port

Item	Specification
PCMCIA controller	ENE CB1410 CardBus
Supports card type	Type II
Number of slots	One type-II
Access location	Left panel
Supports ZV (Zoomed Video) port	No ZV support
Supports 32 bit CardBus	Yes

System Board Major Chips

Item	Controller
System core logic	Intel 852GM and ICH4-M
Super I/O controller	SMC LP47N217
Audio controller	Realtek ALC202 Codec
Video controller	Intel 852GM
Hard disk drive controller	ICH4-M
Keyboard controller	ENE KB910
RTC	ICH4-M

Keyboard

Item	Specification
Keyboard controller	ENE KB910
Keyboard vendor & model name	Standard keyboard w/o launch button embedded
Total number of keypads	85/US, 86/UK keys with 101/102 key emulation
Windows logo key	Yes
Internal & external keyboard work simultaneously	Yes

Battery

Item	Specification
Vendor & model name	Sony/Samsung
Battery Type	Li-ion
Pack capacity	31Wh / 63Wh
Cell voltage	3.7V/cell
Number of battery cell	4 / 8
Package configuration	Pin 1: BATT+: Battery positive power pin
	Pin 2: 6C/8C
	Pin 3: B/I: Enable Li-ion battery output, connect to 1k Ω resistor to GND in system.
	Pin 4: TS: connect 10K Ω ohm Thermistor to GND
	Pin 5: EC_SMD1: SMBus DATA
	Pin 6: EC_SMC1: SMBus CLOCK
	Pin 7: GND: battery ground power pin
Package voltage	14.8V

LCD Inverter Specification

This inverter is designed to light up the CCFL of LCD for TravelMate 290E series notebook. It should be supported the following LCD panels.

No.	Supplier	Model	Type
1	AU	B141XN04	TFT, 14.1" XGA
2	CMO	N141X6-L01	TFT, 14.1" XGA
3	CPT	CLAA141XF01	TFT, 14.1" XGA
4	Toppoly	TD141TGCB1	TFT, 14.1" XGA
5	AU	B150XG02-V1	TFT 15.0" XGA

LCD Inverter Specification

This inverter is designed to light up the CCFL of LCD for TravelMate 290E series notebook. It should be supported the following LCD panels.

No.	Supplier	Model	Type
6	Hitachi	TX38D81VC1CAB	TFT, 15.0 XGA
7	LG	LP150X08-A3	TFT 15.0" XGA
8	Hannstar	HSD150PX17-A	TFT, 15.0" XGA

There are two control signals that come from system to control lamp brightness. One signal is named DAC_BRIG, which limits current to meet LCD lamp current specification. Another one is named PWM, which adjusts lamp brightness. This inverter brightness is adjusted by PWM burst mode. The PWM burst mode is that turning on and off the lamp at rate of 150Hz. The effective brightness is a function of the duty cycle.

Features

1. Wide range 9V to 21V input voltage.
2. Brightness adjustment by PWM duty mode.
3. Close loop controls lamp current.

Electrical Characteristics

No	Parameter	Symbol	Min.	Typ.	Max.	Unit	Comment
1	Input voltage	NV_PWR	9	14.8	21	V	7.5V (continuous) can work *Note 1
2	Input current	lin	--	0.33	--	A	
3	Lamp current	IL	3.0	--	6.8	mA	DAC=0V *Note 2
4	Lamp current	IL	2.7	--	6.3	mA	DAC=1V
4	Frequency	F	45	55	65	KHz	* Note 3
5	Output power	Pout	--	--	4.5	W	
6	Efficiency	η	80%	--	--	--	
7	Starting voltage	Vs	1600	--	---	V	At 0°C
8	Starting time	Tvs	1	--	1.5	Sec	
9	Dispoff#		2.8	3.3	3.6	V	Backlight on/off signal
			0	0.5	0.8	V	Low level
10	Limited lamp maximum current	DAC-BRIG	0		3.3	V	*Note 2
11	PWM signal *Note 4	INV_PWM	142	150	158	Hz	PWM signal frequency
			3.0	3.3	3.6	V	PWM signal amplitude
			30	--	100	%	Duty = $\frac{T_{on}}{Period}$
12	Lamp current over-shoot	I zero-PK	--	--	10	%	Line transient (10.8V to 21V/100us) and turn on transient
13	Current Waveform factor	$\frac{I_p}{I_{rms}}$	1.27	$\sqrt{2}$	1.56	Multiple	$\frac{I_{-p}}{I_{rms}}$ or $I_{rms} * 10$
14	Unbalance Rate	$\frac{I_p - I_{-p} }{I_{rms}}$	-10%	0	+10%	Multiple	
15	Turn off current (Hight side)	IHI	--	--	0	A	PWM=30%
15	Turn off voltage (Low side)	Voff	--	--	150Vp-p	V	PWM=30%

No	Parameter	Symbol	Min.	Typ.	Max.	Unit	Comment
16	Voltage Rise time (Low side)	Trise	--	--	300us	us	PWM=30%
17	Voltage fall time (Low side)	Tfall	--	--	300us	us	PWM=30%

NOTE:

*1. The inverter can work in 7.5V input voltage (continuous), but 7.5V electronic characteristic will not be care.

*2. Limited lamp maximum current by DAC_BRIG signal:

When DAC_BRIG voltage is 0V and INV_PWM enables (100%), lamp has max. current.

When DAC_BRIG voltage is 3.3V and INV_PWM enables (100%), lamp has min. current.

When add 1V DAC, the 100% Lamp current will decrease 0.5mA.

DAC_BRIG signal comes from system chipset with internal resistance of 3K Ω

*3. Inverter operating frequency should be within specification (45~65kHz) at max. and min. brightness load.

*4. INV_PWM enable implies INV_PWM signal is High level (On duty cycle is 100%). It is a square wave of 150Hz to adjust backlight brightness that is a function of PWM duty cycle. Backlight brightness is maximum value under INV_PWM at 100% and brightness is minimum under INV_PWM at 30%.

*5. The system interface signals belong to 3.3V.

*6. Please make sure open lamp output voltage should be within starting voltage specification.

*7. Inverter should pass human body safety test.

*8. Inverter should be no smoking by any component open/short test.

*9. Transformer voltage stress should not be over 85% under any condition.

(turn on overshoot transient and line transient.)

*10. Audio noise should be less than 36dB at 10cm distance.

Electrical specification

No	Symbol	Min.	Typ.	Max.	Unit	Comment
1	V oper*	--	650	--	Vrms	Lamp operating voltage (650+/-50)
	II	6.2	6.5	6.8	mArms	DAC_BRIG: 0 V, PWM: 100%
	II	3.0	3.3	3.6	mArms	DAC_BRIG: 0 V, PWM:30%
	II	5.7	6.0	6.3	mArms	DAC_BRIG: 0V, PWM:100%
	II	2.7	3.0	3.3	mArms	DAC_BRIG: 1V, PWM:30%
	F	45	55	65	kHz	
	η	80%	--	--	--	

Thermal

All components on inverter board should follow below rules:

1. Component using conditions (component stress) must be within component specification including voltage rating, current rating, temperature etc.

2. Component temperature should follow below:

$\Delta T \leq 30$ degree C, at 25, 35 degree C.

Component temperature should be less than 70 degree C inside system at 35 degree C.

LCD

Item	Specification							
Vendor & model name	CPT CLAA14 1XF01	AU B141XN 04 / B150XG 02-V1 / B150XG 01-V2	Hitachi TX38D8 1VC-1CAB	LG LP150X 08-A3	Sanyo TM150X G-02L11	Hannstar HSD150 PX17-A	CMO N141X6-L01	Toppoly TD141T-GCB1
Mechanical Specifications								
LCD display area (diagonal, inch)	14.1	14.1/ 15.0	15.0	15.0	15.0	15.0	14.1	14.1
Display technology	TFT	TFT	TFT	TFT	TFT	TFT	TFT	TFT
Resolution	XGA (1024* 768)	XGA (1024* 768)	XGA (1024* 768)	XGA (1024* 768)	XGA (1024* 768)	XGA (1024* 768)	XGA (1024* 768)	XGA (1024* 768)
Supports colors	262K	262K	262K	262K	262K	262K	262K	262K
Optical Specification								
Contrast ratio	300	100	175 (Min.) 250 (Typ.)					
Response time (msec)	Rising: 24 (Typ.) 15 (Max.) Falling: 11 (Typ.) 30 (Max.)	Rising: 30 (Typ.) 50 (Max.) Falling: 30 (Typ.) 50 (Max.)	Rising: 10 (Typ.) 20 (Max.) Falling: 20 (Typ.) 30 (Max.)					
Limuinance, white, 5P (cd/m ²)	180 (5 points average)	180 (5 points average)	150 (5 points average)					
Brightness control	key-board hotkey	key-board hotkey	key-board hotkey	key-board hotkey	key-board hotkey	key-board hotkey	key-board hotkey	key-board hotkey
Contrast control	No	No	No	No	No	No	No	No
Suspend/ Standby control	Yes	Yes	Yes	Yes	Yes	Yes	Yes	Yes
Electrical Specification								
Supply voltage for LCD display (V)	3.3	3.3	3.3	3.3	3.3	3.3	3.3	3.3

LCD

Item	Specification							
Supply voltage for LCD backlight (Vrms)	690	690	690	690	690	690	690	690

AC Adapter

Item	Specification
Vendor & model name	LITEON 65W, 3 PIN, PA-1650-02CA LITEON 65W, 3 PIN, PA-1650-02CR DELTA 65W, 3 PIN, ADP-65DB
Input Requirements	
Maximum input current (A, @100Vac, full load)	1.7Amax@100Vac 0.9Amax@ 240Vac
Nominal frequency (Hz)	47 - 63
Frequency variation range (Hz)	47 - 63
Nominal voltages (Vrms)	90 - 264
Inrush current	The maximum inrush current will be less than 50A and 100A when the adapter is connected to 115Vac(60Hz) and 240Vac(50Hz) respectively.
Efficiency	High efficiency 86% minimum, at 100~240Vac AC input, full load, warm-up condition.
Output Ratings (CV mode)	
DC output voltage	Offers constant voltage 19.0V output source with 65W max output power capacity.
Noise + Ripple	380mvp-pmax (20MHz bandwidth) for resistor load
Output current	0 A (min.) 3.16A (max.)
Output Ratings (CC mode)	
DC output voltage	18.0 ~ 20.0
Constant output	3.3A
Dynamic Output Characteristics	
Start-up time	3 sec. (@115 Vac and 230Vac full load)
Hold up time	5ms min. (@115 Vac input, full load)
Over Voltage Protection (OVP)	27V
Short circuit protection	Output can be shorted without damage, and auto recovery
Electrostatic discharge (ESD)	15kV (at air discharge) 8kV (at contact discharge)
Dielectric Withstand Voltage	
Primary to secondary	4242 Vdc for 1 second
Leakage current	60uA at 254Vac
Regulatory Requirements	1. FCC class B requirements (USA) 2. VDE class B requirements (German) 3. VCCI classII requirements (Japan)

Power Management

ACPI Mode	Power Management
Mech. Off (G3)	All devices in the system are turned off completely.
Soft Off (G2/S5)	OS initiated shutdown. All devices in the system are turned off completely.

Power Management

ACPI Mode	Power Management
Working (G0/S0)	Individual devices such as the CPU and hard disk may be power managed in this state.
Sleeping State (S3)	CPU Power Down VGA Power Down PCMCIA Suspend Audio Power Down Hard Disk Power Down Super I/O Power Down
Sleeping State (S4)	Also called Hibernate state. System saves all system states and data onto the disk prior to power off the whole system.

Environmental Requirements

Item	Specification
Temperature	
Operating	+5 ~ +35°C
Non-operating	-20 ~ +65°C
Non-operating	-20 ~ +65°C (storage package)
Humidity	
Operating	20% to 80% without condensation
Non-operating	20% to 80% RH, non-condensing (unpacked)
Non-operating	20% to 80% RH, non-condensing (storage package)
Vibration	
Operating (unpacked)	5 ~ 500Hz: 0.9G
Non-operating (unpacked)	5 ~ 500Hz: 1.3G

Mechanical Specification

Item	Specification
Dimensions	333.6mm (W) x 276.3mm (D) x 32mm (H) for 14.1/15.0 inch model
Weight	6.15lb (2.79kg) for 14.1 inch model 6.26lb (2.84kg) for 15.0 inch model
I/O Ports	One type II CardBus slots, One RJ-11 modem jack, One RJ-45 network jack, One DC-in jack for AC adapter, One ECP/EPP-compliant parallel port, One external monitor port, One headphone/speaker/line-out jack (3.5mm mini jack), One microphone/line-in jack (3.5mm mini jack), Three Universal Serial Bus (USB) ports,
Material	Recycle plastic PC+ABS
Indicators	Power, Battery charge, HDD, ODD, Wireless/Bluetooth communication, Caps lock, Pad lock, Num lock and Scroll lock indicators
Switch	Power switch Lid switch User define switch 1, 2 Wireless ON/OFF switch

System Utilities

BIOS Setup Utility

The BIOS Setup Utility is a hardware configuration program built into your computer's BIOS (Basic Input/Output System).

Your computer is already properly configured and optimized, and you do not need to run this utility. However, if you encounter configuration problems, you may need to run Setup. Please also refer to Chapter 4 Troubleshooting when problem arises.

To activate the BIOS Utility, press **F2** during POST (when "Press <F2> to enter Setup" message is prompted on the bottom of screen).

```

Insyde Software SCU                               May 25, 2003  4:34:00  PM
Main Advanced Security Boot Exit

  Devices
  Product Name = DCL51
  Manufacture Name = Compal
  System BIOS Version = V0.10
  UGA BIOS Version = 2973

  Internal Hard Disk = IC25N060ATMR04-0
  HDD Serial Number = RM3G003K0GDBAJ
  DVD/CD-Rom Drive = SAMSUNG CD-ROM SM-124

  Serial#: 1234asdf
  Asset Tag#: 1233245Tasdfgjafjldk
  UUID: 4358967dfjgoruetiozxc1kjbv

  System
  CPU = Intel(R) Pentium(R) M
  CPU Speed = 1300MHz

  Memory
  Base Memory = 640 KB
  Extended = 239 MB
  UGA Memory = 16 MB

  Setup system date,time.Enable boot logo and get system information.
  
```

Navigating the BIOS Utility

There are five menu options: Main, Advanced, Security, Boot and Exit.

Follow these instructions:

- To choose a menu, use the cursor left/right keys (**←** **→**).
- To choose a parameter, use the cursor up/down keys (**↑** **↓**).
- To change the value of a parameter, press **F5** or **F6**.
- Press **ESC** while you are in any of the menu options to go to the Exit menu.
- In any menu, you can load default settings by pressing **F9**. You can also press **F10** to save any changes made and exit the BIOS Setup Utility.

NOTE: You can change the value of a parameter if it is enclosed in square brackets. Navigation keys for a particular menu are shown on the bottom of the screen. Help for parameters are found in the Item Specific Help part of the screen. Read this carefully when making changes to parameter values.

Main

This menu provides you the information of the system.

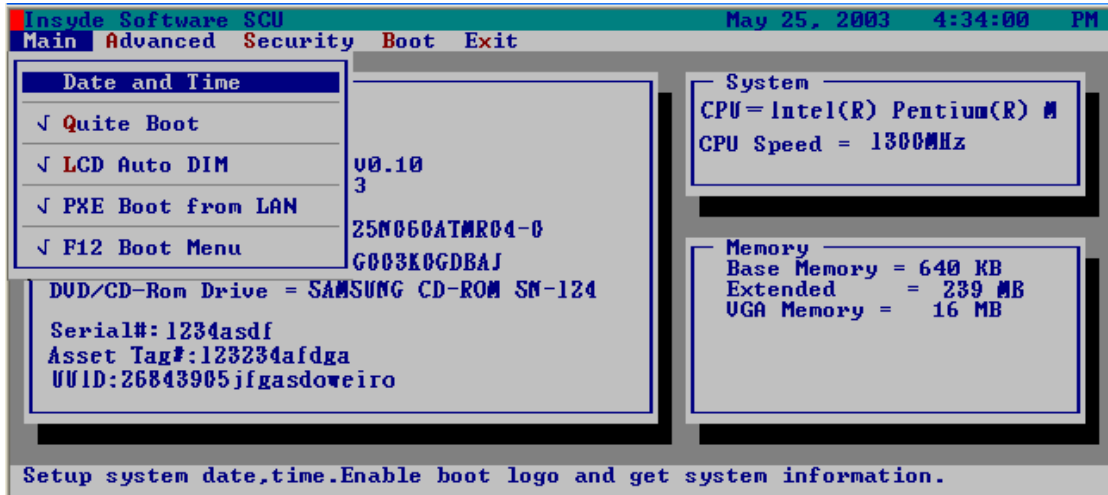

Parameter	Description
System BIOS Version	Displays system BIOS version
VGA BIOS Version	Displays VGA BIOS version
Serial #	Displays the serial number of the unit.
UUID Number	UUID=16bytes. This will be visible only when there is an internal LAN device present.
System Memory	This field reports the memory size of system base memory. The size is fixed to 640KB.
Extended Memory	This field reports the memory size of the extended memory in the system. Extended Memory size=Total memory size
CPU Speed	CPU Speed= Max speed
System Time and System Date	Sets the system time and date.
Quiet Boot Mode	Control whether Customer Logo and Summary Screen are displayed or not.
LCD Auto DIM	Enabled: LCD brightness will automatically lower to save more power when AC is not present. Disabled: LCD brightness will NOT automatically lower to save more power when AC is not present.
PXE Boot from LAN	Enables "PXE Boot from LAN" function at DOS.
F12 Boot Menu	This field decides whether the OEM POST screen will have the following message: "Press <F12> Change Boot Device" or not during user's quiet boot.

Advanced

The Advanced screen contains parameters involving your hardware devices. It also provides advanced settings of the system.

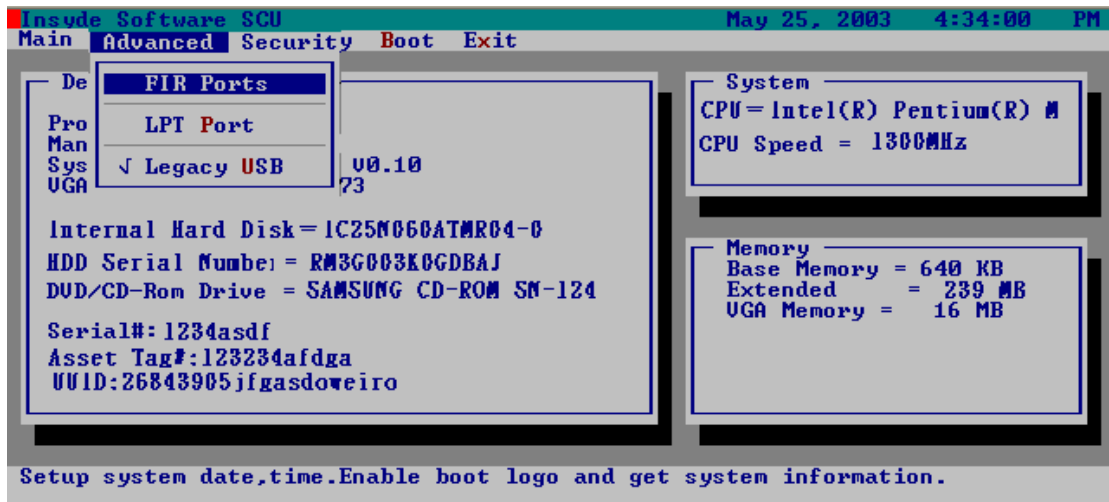

FIR Ports

Configure the system's Infrared port using options: **Disabled** and Enabled.

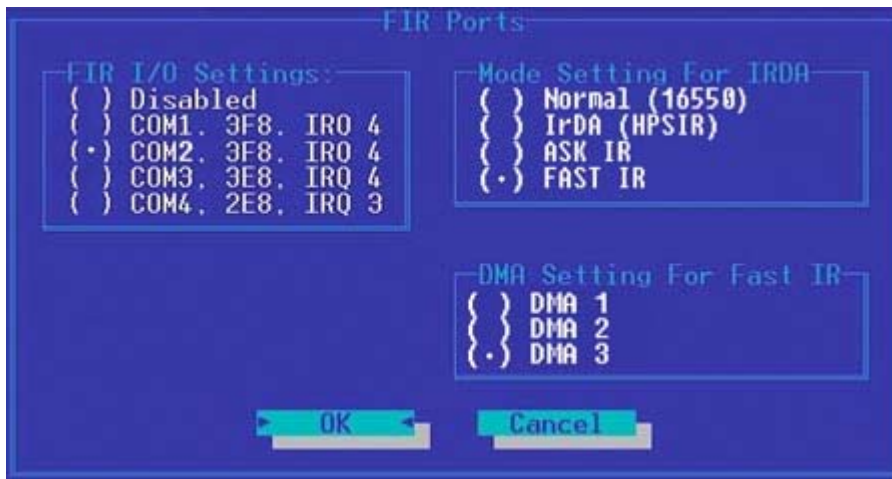

The table below describes the parameters in the screen. Settings in **boldface** are the default and suggested parameter settings.

	Description	Option
FIR I/O Settings	Sets the base I/O address and IRQ for Infrared port.	COM1, 3F8, IRQ4/ COM2, 2F8, IRQ3 / COM3, 3E8, IRQ4/ COM4, 2E8, IRQ3

	Description	Option
DMA Setting for Fast IR	Sets a DMA channel for the printer to operate in ECP mode. This parameter is enabled only if Mode is set to ECP.	DMA1, DMA2, DMA3 ,
Mode Setting		Normak (16550), IrDA (HPSIR), ASK IR, FAST IR

LPT Port

Configure the system's parallel port using options: **Disabled** and Enabled.

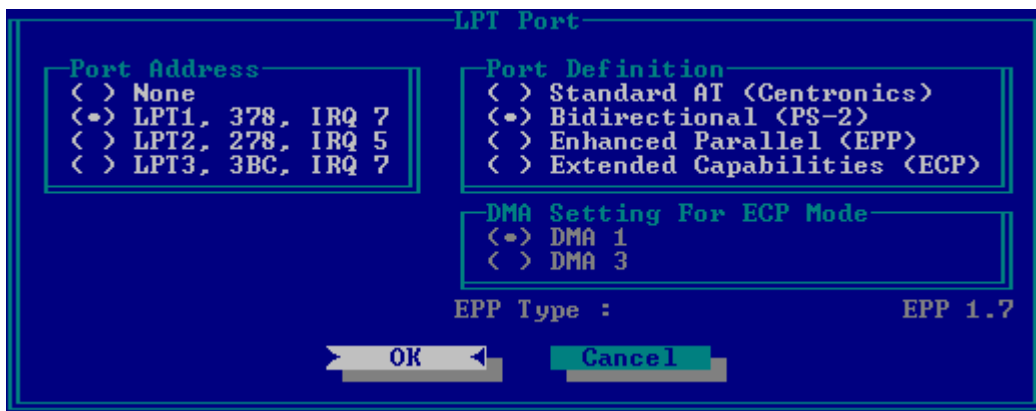

The table below describes the parameters in the screen. Settings in **boldface** are the default and suggested parameter settings.

	Description	Option
Port Definition	Sets the mode for the parallel port. Standard AT: Normal mode (AT compatible) Bi-directional: Bi-directional mod (PS/2 compatible) Enhanced Parallel (EPP): EPP mode Extended Compabilities (ECP): ECP mode (requires DMA channel)	Standard AT (Centronics), Bidirectional (PS-2) , Enhanced Parallel (EPP), Extended Capabilities
Port Address	Sets the base I/O address for the parallel port. When Mode is selected as EPP mode, "3BC" will not be available.	None/ LPT1, 378, IRQ7 / LPT2, 278, IRQ5/ LPT3, 3BC, IRQ7
Mode Setting	If ECP mode has been selected, then DMA default is DMA1.	DMA1, DAM3

Legacy USB Support

Disabled: Disable support for Legacy Universal Serial Bus.

Enabled: Enable support for Legacy Universal Serial Bus.



Security

The Security screen contains parameters that help safeguard and protect your computer from unauthorized use.

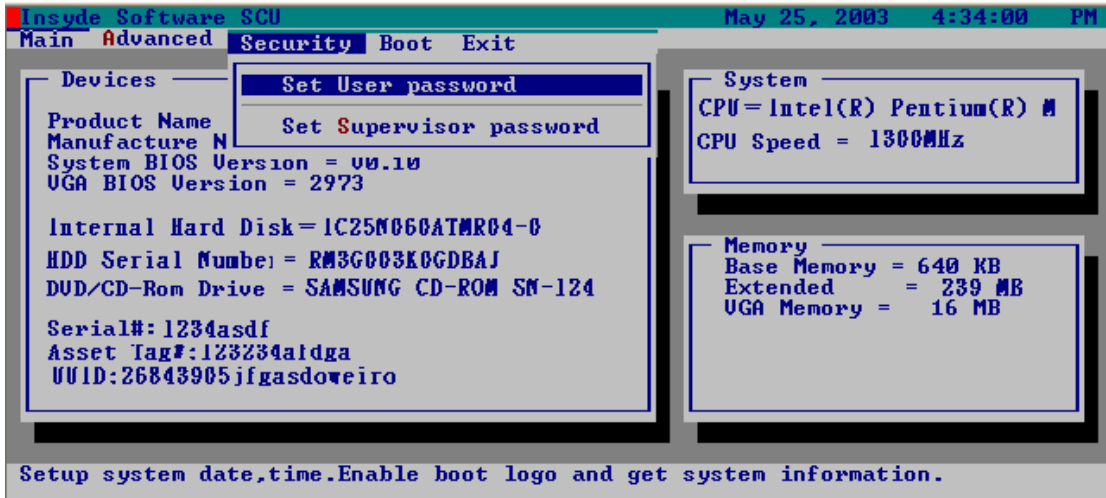

The table below describes the parameters in this screen. Settings in **boldface** are the default and suggested parameter settings.

Set Supervisor/User Password

If password on boot is required, the password must be set otherwise it cannot be enabled.

The formats of the password are as follows:

Length 10 characters

Characters Alphanumeric keys only. The shift status i.e. Ctrl, Shift, Alt and Capital are ignored.



Parameter	Description	Option
Set User Password	Press Enter to set the user password. When set, this password protects the BIOS Setup Utility from unauthorized access.	

Parameter	Description	Option
Set Supervisor Password	Press Enter to set the administrator password. When set, this password protects the BIOS Setup Utility from unauthorized access.	
Password on Boot	Allows the user to specify whether or not a password is required to boot.	Disabled or Enabled

NOTE: When you are prompted to enter a password, you have three tries before the system halts. Don't forget your password. If you forget your password, you may have to return your notebook computer to your dealer to reset it.

Boot

This menu allows the user to decide the order of boot devices to load the operating system. Bootable devices includes the distette drive in module bay, the onboard hard disk drive and the CD-ROM in module bay.

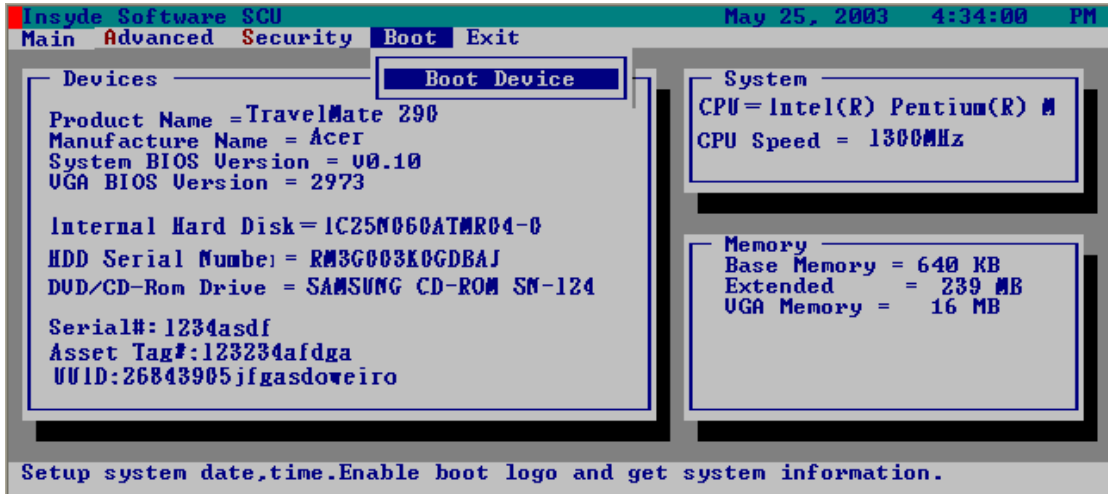

Please select the order of the boot devices.



Exit

The Exit screen contains parameters that help safeguard and protect your computer from unauthorized use.

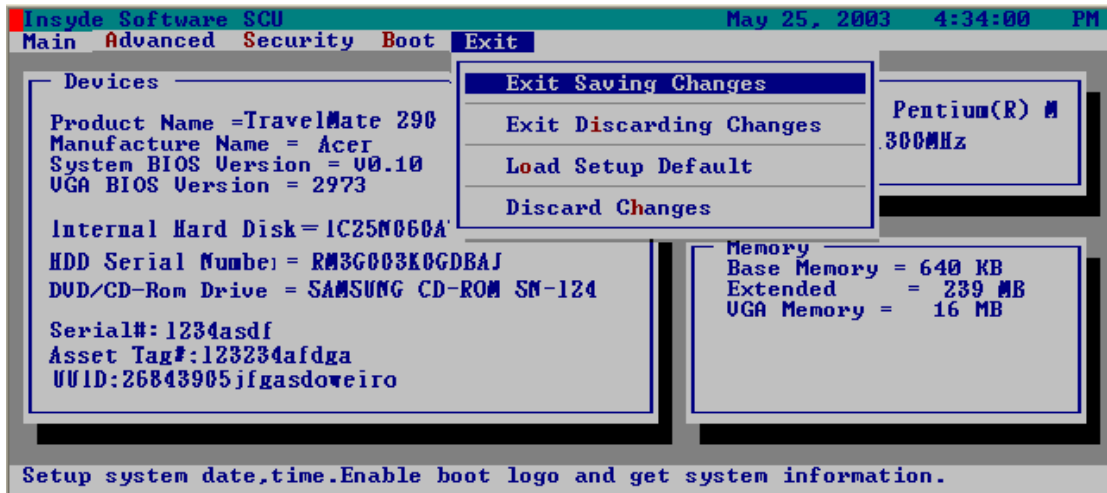

The table below describes the parameters in this screen.

Parameter	Description
Exit Saving Changes	Allows the user to save changes to CMOS and reboot the system.
Exit Discarding Changes	Allows the user Discards changes made and exits System Setup.
Load Setup Default	Loads default settings for all parameters (same as).
Discard Changes	Allows the user to discard previous changes in CMOS Setup.

BIOS Flash Utility

The BIOS flash memory update is required for the following conditions:

- New versions of system programs
- New features or options
- Restore a BIOS when it becomes corrupted.

Use the Flash utility to update the system BIOS flash ROM.

NOTE: If you do not have a crisis recovery diskette at hand, then you should create a **Crisis Recovery Diskette** before you use the Flash utility.

NOTE: Do not install memory-related drivers (XMS, EMS, DPMS) when you use the Flash utilities.

NOTE: Please use the AC adaptor power supply when you run the Flash utility. If the battery pack does not contain enough power to finish BIOS flash, you may not boot the system because the BIOS is not completely loaded.

Follow the steps below to run the Flash.

1. Prepare a bootable diskette.
2. Copy the Flash utilities to the bootable diskette.
3. Then boot the system from the bootable diskette. The Flash utility has auto-execution function.

Machine Disassembly and Replacement

This chapter contains step-by-step procedures on how to disassemble the notebook computer for maintenance and troubleshooting.

To disassemble the computer, you need the following tools:

- Wrist grounding strap and conductive mat for preventing electrostatic discharge
- Plastic flat head screw driver
- Plastic tweezers
- Philips screw driver
- Any plastic tool can take off the middle cover

NOTE: The screws for the different components vary in size. During the disassembly process, group the screws with the corresponding components to avoid mismatch when putting back the components. When you remove the stripe cover, please be careful not to scrape the cover.

General Information

Before You Begin

Before proceeding with the disassembly procedure, make sure that you do the following:

1. Turn off the power to the system and all peripherals.
2. Unplug the AC adapter and all power and signal cables from the system.
3. Remove the battery pack.

NOTE: TravelMate 290E series product uses mylar or tape to fasten the FFC/FPC/connectors/cable, you may need to tear the tape or mylar before you disconnect different FFC/FPC/connectors.

Disassembly Procedure Flowchart

The flowchart on the succeeding page gives you a graphic representation on the entire disassembly sequence and instructs you on the components that need to be removed during servicing. For example, if you want to remove the system board, you must first remove the keyboard, then disassemble the inside assembly frame in that order.

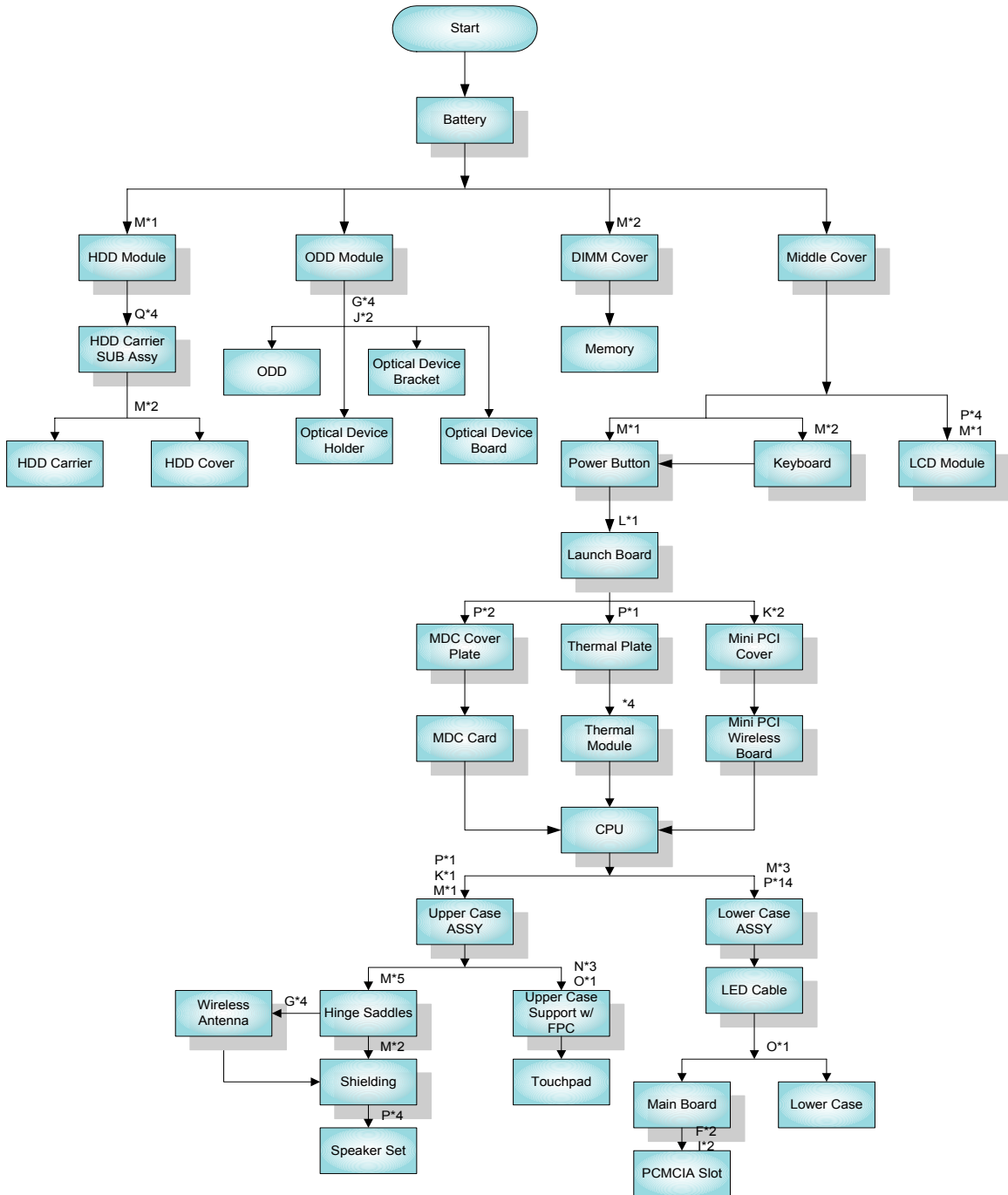

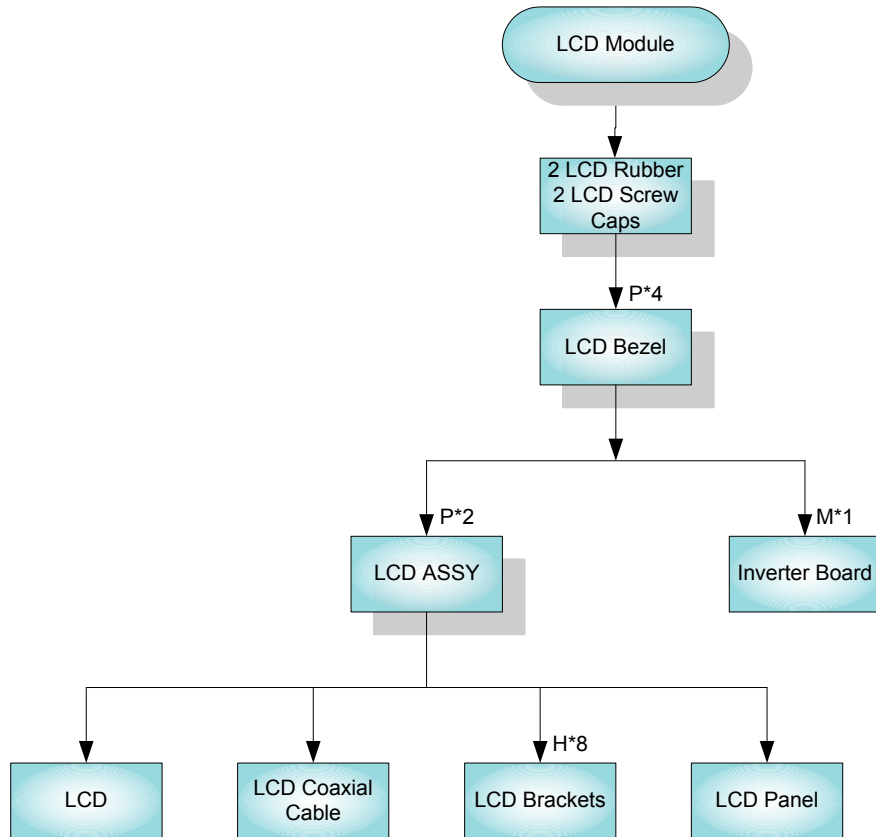

Screw List

Item	Description
A	SCREW BTP M1,7 x 3.5ZS
B	SCREW BTP M2 x 4 ZS
C	SCREW D-SUB NUT
D	SCREW M1.7 x 2.5ZS
E	SCREW M2 x 6 (B) & NI
F	SCREW M2 x 10 (B)
G	SCREW M2 x 2.3 (NL)
H	SCREW M2 x 3 (NL)
I	SCREW M2 x 4 (B)
J	SCREW M2 x 6 (NL)
K	SCREW M2.5 x 1.1 (NL)
L	SCREW M2.5 x 15 (NL)
M	SCREW M2.5 x 3 (NL)
N	SCREW M2.5 x 3 (NL) -up
O	SCREW M2.5 x 4 (NL)
P	SCREW M2.5 x 6 (NL)
Q	SCREW M3 x 4 (NL)

Removing the Battery Pack

1. Slide the battery latch.
2. Then remove the battery.



Removing ODD Module, Memory and HDD Module

Removing the ODD Module

1. Slide the optical drive latch.
2. Then remove the optical drive.



Removing the Memory

1. Unscrew the two screws that secure the DIMM cover.
2. Remove the DIMM cover.
3. Pop out the memory then remove it.



Removing the HDD Module

1. Remove the screw that secures HDD module.
2. Take off the HDD module from the main unit.



Removing the Keyboard/LCD Module

Removing the Keyboard

1. Use a plastic flat head screw driver or any plastic tool to detach the middle cover carefully.
2. Then remove the middle cover from the main unit.



3. Remove the two screws holding the keyboard.
4. Turn the keyboard over as the picture shows.
5. Disconnect the keyboard cable then remove the keyboard.



Removing the LCD module

1. Remove the middle cover. See step 1 and step 2 on “Removing the Keyboard” section.
2. Remove one screw as the picture shows.
3. Then disconnect the LCD coaxial cable.



4. Remove the six screws on the rear and the bottom panel; three on each side.
5. Then detach the entire LCD module.



Disassembling the Main Unit

1. See "Removing the Keyboard/LCD Module" on page 49
2. Disconnect the touchpad FPC.
3. Remove the screw that fastens the power button.
4. Then take off the power button.



5. Remove the screw holding the launch board.
6. Take off the launch board.
7. Then remove the screw that secures the thermal plate.



8. Take off the thermal plate.
9. Remove the two screws that fasten the MDC cover plate then remove it.
10. Disconnect the MDC card connector.

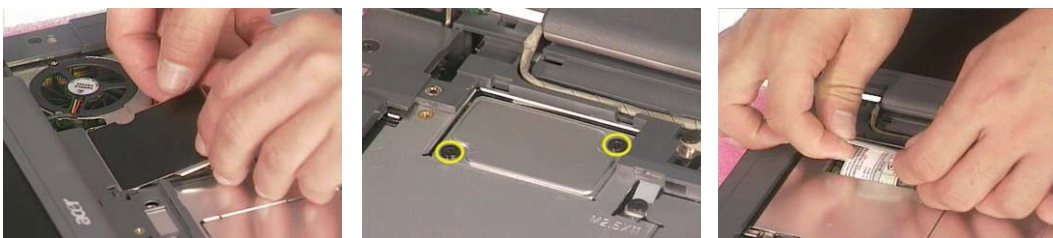

11. Disconnect the modem card cable.
12. Disconnect the fan cable.
13. Remove the four screws according to the order as shown.

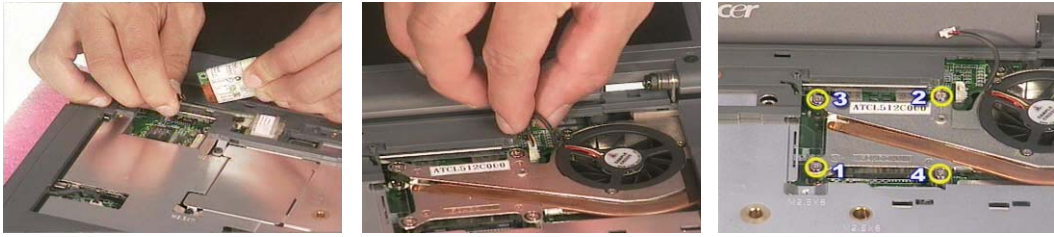

14. Remove the thermal module from the main unit.
15. Release the CPU lock.
16. Remove the CPU from the main unit carefully.

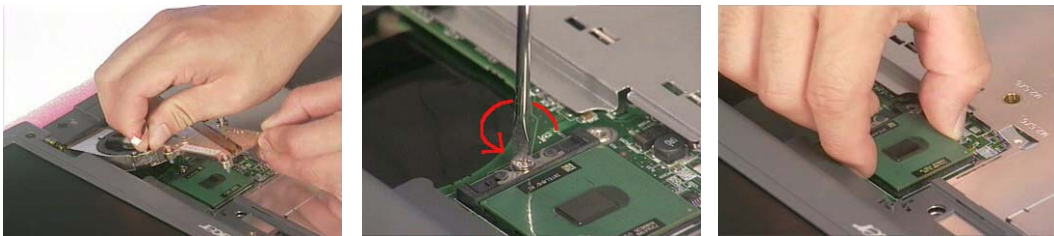

17. Disconnect the speaker cable.
18. Remove the two screws holding the mini PCI cover.
19. Then remove the mini PCI cover.

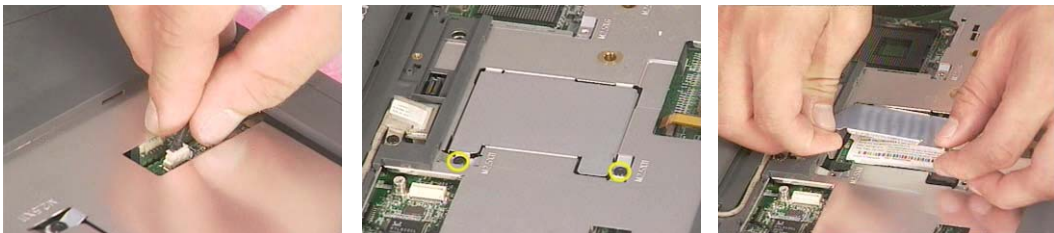

20. Disconnect the wireless LAN antennae.
21. Pop out the wireless LAN card then remove it.

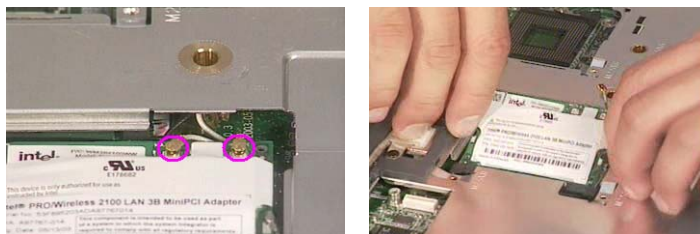

22. To detach the upper case assembly from the lower case assembly, first remove the three screws as shown.

23. Remove the 15 screws on the bottom panel.
24. Then detach the upper case assembly.



25. Tear off the capton fastening the touchpad FPC.
26. Disconnect the touchpad FPC.

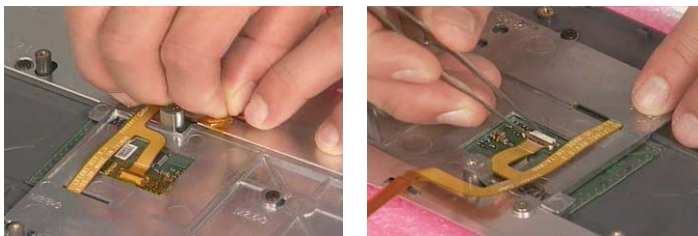

27. Remove the four screws that secure the touchpad support bracket.
28. Then remove the touchpad support bracket.
29. Remove the touchpad.



30. Tear off all capton holding wireless LAN antenna.
31. Take out the wireless antenna from the small fastening hooks.

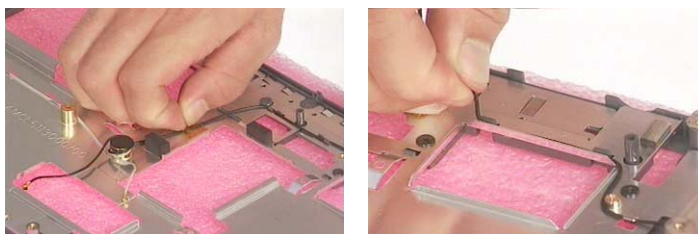

32. Remove the two screws that fasten the wireless antenna.
33. Then take out the wireless antenna.



34. Remove the screw holding the left hinge saddle.
35. Then remove the screw holding the right hinge saddle.



36. Remove the gasket protecting the wireless antenna.
37. Remove the two screws fastening the wireless antenna to the hinge saddle.
38. Then remove the wireless antenna from the upper case.



39. Remove the two screws fastening the left speaker.
40. Place the left speaker as shown.
41. Then take off the left hinge saddle.



42. Remove the gasket.
43. Then remove the screw that secures the hinge saddle.

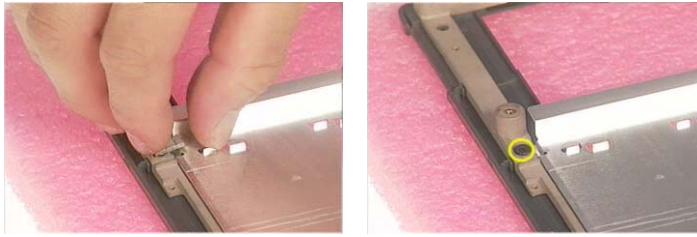

44. Remove the two screws holding the right speaker.
45. Place the right speaker as shown.
46. Then remove the right hinge saddle.



47. Remove the five screws that secure the shielding to the upper case.
48. Tear off the tape on the right and the left side.
49. Then remove the shielding.



50. Tear off the tape holding the speaker set.
51. Remove the speaker set from the upper case.



52. Remove the screw that secures the main board to the lower case.
53. Disconnect the touchpad FPC. Please push the lower case outwards as shown.

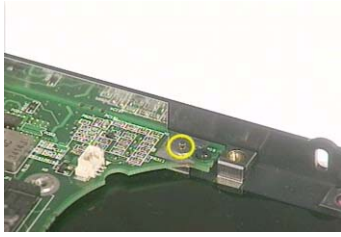

54. Remove the four screws that fasten the PCMCIA slot.

55. Detach the PCMCIA slot from the main board.

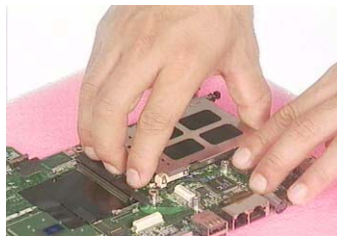
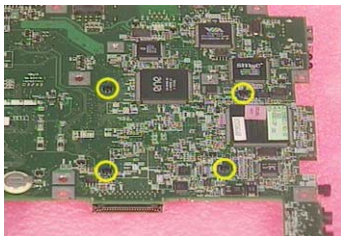

Disassembling the LCD Module

1. Remove the two LCD rubber feet and the two screw caps.
2. Remove the four screws that fasten the LCD bezel.
3. Detach the LCD bezel carefully.



4. Tear off the tape fastening the inverter connector.
5. Tear off the tape fastening the inverter cable.

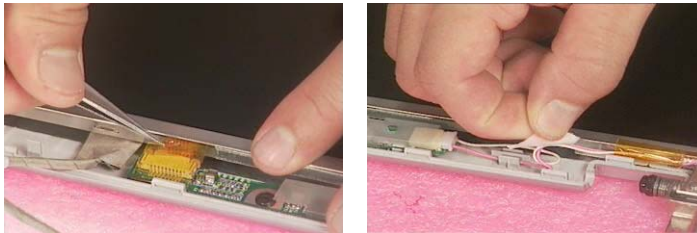

6. Remove the screw holding the LCD inverter board.
7. Disconnect the high voltage cable and the inverter board.
8. Disconnect the inverter board connector.



9. Remove the two screws holding the LCD; one on each side.
10. Then remove the LCD from the LCD panel.



-
11. Remove the eight screws that fasten the right and the left LCD brackets; four on each side.
 12. Then remove the LCD brackets on both side.

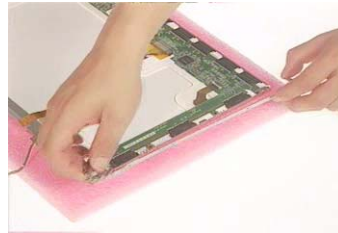

13. Tear off the capton that secure the LCD coaxial cable.
14. Disconnect the LCD coaxial cable.

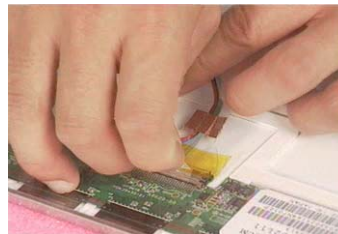
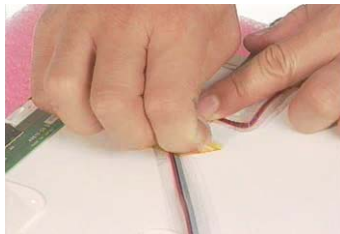

Disassembling the External Modules

Disassembling the HDD Module

1. Remove the two screws holding the HDD carrier on one side.
2. Then remove another two screws fastening the HDD carrier on the other side.

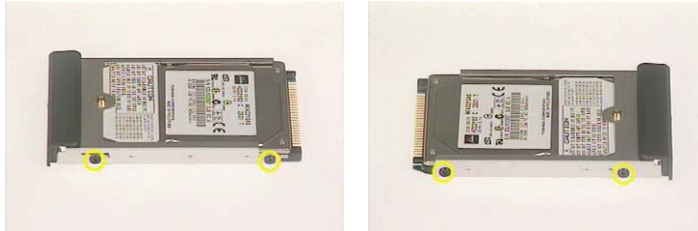

3. Remove the HDD carrier.
4. Remove the two screws holding the HDD cover.
5. Detach the HDD cover.



Disassembling the Optical Disk Drive Module/Combo Drive Module

1. Remove the two screws holding the optical device holder.
2. Remove another two screws that fasten the optical device holder on the other side.
3. Then remove the last two screws that secure the holder.

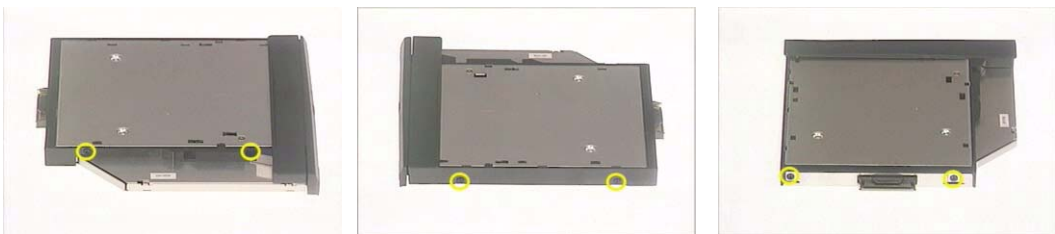

4. Take the optical disc drive from the optical device holder.
5. Remove the optical device bracket.
6. Then remove the optical device board.

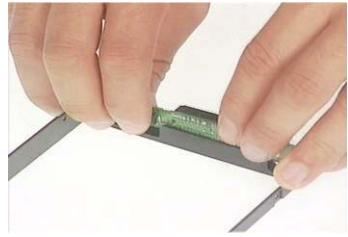
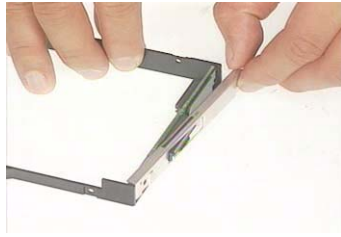

Troubleshooting

Use the following procedure as a guide for computer problems.

NOTE: The diagnostic tests are intended to test this model (TravelMate 290E series). Non-Acer products, prototype cards, or modified options can give false errors and invalid system responses.

1. Obtain the failed symptoms in as much detail as possible.
2. Verify the symptoms by attempting to re-create the failure by running the diagnostic test or by repeating the same operation.
3. If any problem occurs, you can perform visual inspection before you follow this chapter's instructions. You can check the following:
 - power cords are properly connected and secured;
 - there are no obvious shorts or opens;
 - there are no obviously burned or heated components;
 - all components appear normal.
4. After you perform visual inspection you can also verify the following:
 - ask the user if a password is registered and, if it is, ask him or her to enter the password.
 - verify with the customer that Windows XP is installed on the hard disk. Operating systems that were not preinstalled by Acer can cause malfunction.
 - make sure all optional equipment is removed from the computer.
 - make sure the floppy disk is empty.
5. Use the following table with the verified symptom to determine which page to go to.

Symptoms (Verified)	Go To
Power failure. (The power indicator does not go on or stay on.)	"Power System Check" on page 63.
POST does not complete. No beep or error codes are indicated.	"Insyde MobilePro BIOS POST Beep Code and POST Messages" on page 67 "Undetermined Problems" on page 73
POST detects an error and displayed messages on screen.	"Insyde MobilePro BIOS POST Beep Code and POST Messages" on page 67
Other symptoms (i.e. LCD display problems or others).	"Insyde MobilePro BIOS POST Beep Code and POST Messages" on page 67
Symptoms cannot be re-created (intermittent problems).	Use the customer-reported symptoms and go to "Insyde MobilePro BIOS POST Beep Code and POST Messages" on page 67 "Intermittent Problems" on page 72 "Undetermined Problems" on page 73

System Check Procedures

External Diskette Drive Check

Do the following steps to isolate the problem to a controller, driver, or diskette. A write-enabled, diagnostic diskette is required.

NOTE: Make sure that the diskette does not have more than one label attached to it. Multiple labels can cause damage to the drive or cause the drive to fail.

Do the following to select the test device.

1. The FDD heads can become dirty over time, affecting their performance. Use an FDD cleaning kit to clean the heads. If the FDD still does not function properly after cleaning, go to next step.
2. Boot from diagnostic program.
3. If an error occurs with the internal diskette drive, reconnect the diskette connector on the main board.

If the error still remains:

1. Reconnect the external diskette drive module.
2. Replace the external diskette drive module.
3. Replace the main board.

External CD-ROM/DVD-ROM Drive Check

Do the following to isolate the problem to a controller, drive, or CD-ROM/DVD-ROM. Make sure that the CD-ROM does not have any label attached to it. The label can cause damage to the drive or can cause the drive to fail.

Do the following to select the test device:

1. Insert an audio CD into the CD/DVD drive. If the CD/DVD drive can read the data from the audio CD. The drive does not have problem, then go to next step. If the CD/DVD LED on the front panel does not emit light as it read the data from the audio CD, then go to next step. However, if the CD/DVD drive can not read data from the audio CD, you may need to clean the CD/DVD drive with a CD/DVD drive cleaning disk.
2. Make sure that the appropriate driver has been installed on the computer for the CD/DVD drive.
3. Boot from the diagnostics diskette and start the diagnostics program
4. See if CD-ROM Test is passed when the program runs to CD-ROM/DVD-ROM Test.
5. Follow the instructions in the message window.

If an error occurs, reconnect the connector on the main board. If the error still remains:

1. Reconnect the CD-ROM/DVD-ROM module.
2. Replace the CD-ROM/DVD-ROM module.
3. Replace the main board.

Keyboard or Auxiliary Input Device Check

Remove the external keyboard if the internal keyboard is to be tested.

If the internal keyboard does not work or an unexpected character appears, make sure that the flexible cable extending from the keyboard is correctly seated in the connector on the main board.

If the keyboard cable connection is correct, run the Keyboard Test.

If the tests detect a keyboard problem, do the following one at a time to correct the problem. Do not replace a non-defective FRU:

1. Reconnect the keyboard cables.
2. Replace the keyboard.
3. Replace the main board.

The following auxiliary input devices are supported by this computer:

- Embedded Numeric Keypad
- External keyboard

If any of these devices do not work, reconnect the cable connector and repeat the failing operation.

Memory Check

Memory errors might stop system operations, show error messages on the screen, or hang the system. Currently, we do not provide memory test program. However, if you need to check memory but have no testing program or diagnostic utility at hand, please go to <http://www.passmark.com> to download the shareware "BurnIn Test V.3.0". You may test the memory with this program under Window XP environment.

NOTE: Make sure that the DIMM is fully installed into the connector. A loose connection can cause an error.

Power System Check

To verify the symptom of the problem, power on the computer using each of the following power sources:

1. Remove the battery pack.
2. Connect the power adapter and check that power is supplied.
3. Disconnect the power adapter and install the charged battery pack; then check that power is supplied by the battery pack.

If you suspect a power problem, see the appropriate power supply check in the following list:

- "Check the Power Adapter" on page 64
- "Check the Battery Pack" on page 65

Check the Power Adapter

Unplug the power adapter cable from the computer and measure the output voltage at the plug of the power adapter cable. See the following figure

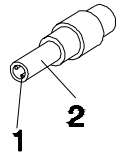

Pin 1: 19V
Pin 2: 0V, Ground

1. If the voltage is not correct, replace the power adapter.
2. If the voltage is within the range, do the following:
 - Replace the main board.
 - If the problem is not corrected, see “Undetermined Problems” on page 73.
 - If the voltage is not correct, go to the next step.

NOTE: An audible noise from the power adapter does not always indicate a defect.

3. If the DC-IN indicator does not light up, check the power cord of the power adapter for correct continuity and installation.
4. If the operational charge does not work, see “Check the Power Adapter” on page 64.

Check the Battery Pack

To check the battery pack, do the following:

From Software:

1. Check out the Power Options in control Panel
2. In Power Meter, confirm that if the parameters shown in the screen for Current Power Source and Total Battery Power Remaining are correct.
3. Repeat the steps 1 and 2, for both battery and adapter.
4. This helps you identify first the problem is on recharging or discharging.

From Hardware:

1. Power off the computer.
2. Remove the battery pack and measure the voltage between battery terminals 1(+) and 6(ground).
3. If the voltage is still less than 7.5 Vdc after recharging, replace the battery.
4. If the voltage is within the normal range, run the diagnostic program.

To check the battery charge operation, use a discharged battery pack or a battery pack that has less than 50% of the total power remaining when installed in the computer.

If the battery status indicator does not light up, remove the battery pack and let it return to room temperature. Re-install the battery pack.

If the charge indicator still does not emit, replace the battery pack. If the charge indicator still does not light up, replace the DC/DC charger board.

Touchpad Check

If the touchpad doesn't work, do the following actions one at a time to correct the problem. Do not replace a non-defective FRU:

1. After rebooting, run Touch pad/PS2 Mode Driver.
2. Run utility with the PS/2 mouse function and check if the mouse is working.
3. If the PS/2 mouse does not work, then check if the main board to switch board FPC is connected well.
4. If the main board to switch board FPC is connected well, then check if the touch pad FPC connects to the main board properly.
5. If there is still an error after you have connected the touch pad FPC to the main board properly, then replace the touch pad or touch pad FPC. The touch pad or touch pad FPC may be damaged.
6. Replace switch board.
7. If the touch pad still does not work, then replace the FPC on Track Pad PCB.

After you use the touchpad, the pointer drifts on the screen for a short time. This self-acting pointer movement can occur when a slight, steady pressure is applied to the touchpad pointer. This symptom is not a hardware problem. No service actions are necessary if the pointer movement stops in a short period of time.

Display Check

1. Connect an external display to the computer's external monitor port, the boot the computer. The computer can automatically detect the external display. Press Fn+  to switch to the external display.
2. If the external display works fine, the internal LCD may be damaged. Then perform the following steps:

Make sure the DDRRAM module is seated properly. Then run the display test again. If the problem still exists, go to next step.

Replace the inverter board, then run the display test program again. If the problem still occurs, go on next step.

Replace the LCD module with a new one then run the display test again. If the problem still happens, continue next step.

Replace LCD/FL cable with a new one then execute the display diagnostic again. If the problem

still occurs, continue next step.

Replace the CPU with another of the same specifications. If the problems still occurs, go to next step.

The main board may be damaged. Replace main board.

3. If the external monitor has the same problem as the internal monitor, the main board may be damaged. Please insert the diagnostic disk and run the display test program and go through the sub-steps under step 2.

Sound Check

To determine if the computer's built-in speakers are functioning properly, perform the following steps. Before you start the steps below, adjust the speaker volume to an appropriate level.

1. Try different audio sources. For example, employ audio CD and digital music file to determine whether the fault is in the speaker system or not. If not all sources have sound problem, the problem is in the source devices. If all have the same problem, continue next step.
2. Connect a set of earphone or external speakers. If these devices work fine, go to next step. If not, then the main board may be defective or damaged. Replace the main board.
3. Follow the disassembling steps in Chapter 3. Ensure the speaker cable is firmly connected to the main board. If the speaker is still a malfunction, go on next step.
4. If the speakers do not sound properly, the speakers may be defective or damaged. Replace the speakers. If the problem still occurs, then replace the main board.

Insyde MobilePro BIOS POST Beep Code and POST Messages

The POST error message index lists the error message and their possible causes. The most likely cause is listed first.

NOTE: Perform the FRU replacement or actions in the sequence shown in FRU/Action column, if the FRU replacement does not solve the problem, put the original part back in the computer. Do not replace a non-defective FRU.

This index can also help you determine the next possible FRU to be replaced when servicing a computer.

If the symptom is not listed, see “Undetermined Problems” on page 73.

The following lists the error messages that the BIOS displays on the screen and the error symptoms classified by function.

NOTE: Most of the error messages occur during POST. Some of them display information about a hardware device, e.g., the amount of memory installed. Others may indicate a problem with a device, such as the way it has been configured.

NOTE: If the system fails after you make changes in the BIOS Setup Utility menus, reset the computer, enter Setup and install Setup defaults or correct the error.

Beep Code	Message	Description
short, short, short; short, short, long	“FAULTY DMA PAGE REGISTERS”	DMA page registers do not function properly.
short, short, short; short, long, short	“FAULTY REFRESH CIRCUIT”	RAM refresh circuit does not function properly.
short, short, short; short, long, long	“ROM CHECKSUM INCORRECT”	BIOS ROM checksum failed.
short, short, short; long, short, short	“CMOS RAM TEST FAILED”	CMOS RAM test failed.
short, short, short; long, short, long	“DMA CONTROLLER FAULTY”	DMA controller does not work properly.
short, short, short; long, long short	“INTERRUPT CONTROLLER FAILED”	The interrupt controller does not work properly.
short, short, short; long, long, long	N/A	Keyboard controller failed to respond with the self-test command.
short, short, long; short, short, short	N/A	No video device found.
short, short, long; short, short, long	N/A	No RAM installed.
N/A	“KEYBOARD CONTROLLER FAILURE”	Keyboard controller failed during system inquiry about connected devices.
N/A	“KEYBOARD FAILURE”	The keyboard fails to respond or no keyboard is connected.
N/A	“CMOS FAILURE - RUN SCU”	CMOS data error, probably due to battery power loss.
N/A	“CMOS CHECKSUM INVALID - RUN SCU”	CMOS checksum error.
N/A	“RAM ERROR AT LOCATION xxxxxx: WROTE: xxxx READ: xxxx”	The RAM failed during memory test at the indicated location.
N/A	“PARITY ERROR AT UNKNOWN LOCATION”	Parity error during memory test at unknown location.
N/A	“PARITY ERROR AT LOCATION XXXXXX”	Parity error during memory test at the indicated location.

Beep Code	Message	Description
N/A	"NO INTERRUPTS FROM TIMER 0"	Timer 0 of the clock timer controller does not generate system interrupts correctly.
N/A	"UNEXPECTED AMOUNT OF MEMORY - RUN SCU"	The system memory size does not match with the CMOS record.
N/A	"CLOCK NOT TICKING CORRECTLY"	The system clock does not working correctly.
N/A	"TIME/DATA CORRUPT - RUN SCU"	The time/date information in CMOS is invalid.
N/A	"MACHINE IS LOCKED - TURN KEY"	The keyboard operation is locked.
N/A	"BOOT SECTOR 0 HAS CHANGED"	The boot sector of the hard disk has been changed, probably because of a virus attack.
N/A	Suspend-to-Disk partition MISSING!"	No Suspend-to-Disk partition found.
N/A	"Hard Disk ERROR!"	Access to the Suspend-to-Disk partition failed.
N/A	"Suspend-to-Disk partition signature NOT FOUND!"	No Suspend-to-Disk partition signature found.
N/A	"Suspend-to-Disk partition size TOO SMALL!"	The capacity of the Suspend-to-Disk partition is not enough.
N/A	"MEMORY SIZE HAS CHANGED -- REBOOTING"	The memory size has changed after previous Suspend-to-Disk operation.

Index of Symptom-to-FRU Error Message

LCD-Related Symptoms

Symptom / Error	Action in Sequence
LCD backlight doesn't work LCD is too dark LCD brightness cannot be adjusted LCD contrast cannot be adjusted	Enter BIOS Utility to execute "Load Setup Defaults" on Exit screen, then reboot system. Reconnect the LCD connectors. Keyboard (if contrast and brightness function key doesn't work). LCD cable LCD inverter LCD Main board
Unreadable LCD screen Missing pels in characters Abnormal screen Wrong color displayed	Reconnect the LCD connector LCD cable LCD inverter LCD Main board
LCD has extra horizontal or vertical lines displayed.	LCD inverter LCD cable LCD Main board

Indicator-Related Symptoms

Symptom / Error	Action in Sequence
Indicator incorrectly remains off or on, but system runs correctly	Reconnect the inverter board Inverter board Main board

Power-Related Symptoms

Symptom / Error	Action in Sequence
Power shuts down during operation	Power source (battery pack and power adapter). See "Power System Check" on page 63. Battery pack Power adapter Hard drive & battery connection board Main board
The system doesn't power-on.	Power source (battery pack and power adapter). See "Power System Check" on page 63". Battery pack Power adapter Hard drive & battery connection board Main board
The system doesn't power-off.	Power source (battery pack and power adapter). See "Power System Check" on page 63. Hold and press the power switch for more than 4 seconds. Main board
Battery can't be charged	See "Check the Power Adapter" on page 64. Battery pack Main board

PCMCIA-Related Symptoms

Symptom / Error	Action in Sequence
System cannot detect the PC Card (PCMCIA)	PCMCIA slot assembly Main board
PCMCIA slot pin is damaged.	PCMCIA slot assembly

Memory-Related Symptoms

Symptom / Error	Action in Sequence
Memory count (size) appears different from actual size.	DIMM Main board

Speaker-Related Symptoms

Symptom / Error	Action in Sequence
In Windows, multimedia programs, no sound comes from the computer.	See "Sound Check" on page 66 Audio driver Speaker Main board
Internal speakers make noise or emit no sound.	See "Sound Check" on page 66 Speaker Main board

Power Management-Related Symptoms

Symptom / Error	Action in Sequence
The system will not enter hibernation	Keyboard (if control is from the keyboard) Hard disk drive Main board
The system doesn't enter hibernation mode and four short beeps every minute.	Press Fn+F4 and see if the computer enters hibernation mode. Touchpad Keyboard Hard disk connection board Hard disk drive Main board
The system doesn't enter standby mode after closing the LCD	LCD cover switch Main board
The system doesn't resume from hibernation mode.	Hard disk connection board Hard disk drive Main board
The system doesn't resume from standby mode after opening the LCD.	LCD cover switch Main board
Battery fuel gauge in Windows doesn't go higher than 90%.	Remove battery pack and let it cool for 2 hours. Refresh battery (continue use battery until power off, then charge battery). Battery pack Main board
System hangs intermittently.	Reconnect hard disk drives. Hard disk drive connector Main board

Peripheral-Related Symptoms

Symptom / Error	Action in Sequence
System configuration does not match the installed devices.	Enter BIOS Setup Utility to execute "Load Setup defaults", then reboot system. Reconnect hard disk/CD-ROM/diskette drives.
External display does not work correctly.	See if there is an error beep. If there is an error beep, then change main board. Power off. Then check if RAM CPU BIOS are well-connected. Press Fn+F5 three times slowly LCD FPC LCD inverter LCD
USB does not work correctly	USB device cable is firmly connected into the USB ports. Test one USB port each time. USB socket is firmly secured to the main board. Main board
Print problems.	Ensure the "Parallel Port" in the "System Devices" of BIOS Setup Utility is set to Enabled. Onboard Devices Configuration Run parallel port test Printer driver Printer cable Printer Main board

Keyboard/Touchpad-Related Symptoms

Symptom / Error	Action in Sequence
Keyboard (one or more keys) does not work.	Reconnect the keyboard cable. Keyboard Main board
Touchpad does not work.	Reconnect touch pad cable. Modem port is secured to the main board Touch pad FPC Audio/Touch pad board Main board

Modem-Related Symptoms

Symptom / Error	Action in Sequence
Internal modem does not work correctly.	Ensure the telephone cable is firmly plugged into the telephone wall socket and the modem port of the computer. Modem phone port is secured to the main board. modem combo board Main board

NOTE: If you cannot find a symptom or an error in this list and the problem remains, see "Undetermined Problems" on page 73.

Intermittent Problems

Intermittent system hang problems can be caused by a variety of reasons that have nothing to do with a hardware defect, such as: cosmic radiation, electrostatic discharge, or software errors. FRU replacement should be considered only when a recurring problem exists.

When analyzing an intermittent problem, do the following:

1. Run the diagnostic test for several times to isolate the problem.
2. If no error is detected, do not replace any FRU.
3. If any error is detected, replace the FRU. Rerun the test to verify that there are no more errors.

If an error is detected by the main battery test, see “Check the Power Adapter” on page 64

If an error is detected by the display test, see “Index of Symptom-to-FRU Error Message” on page 69 .

If an error is detected by the floppy disk drive test, see “External Diskette Drive Check” on page 62.

If an error is detected by the keyboard test, see “Keyboard or Auxiliary Input Device Check” on page 63.

Undetermined Problems

The diagnostic problems does not identify which adapter or device failed, which installed devices are incorrect, whether a short circuit is suspected, or whether the system is inoperative.

Follow these procedures to isolate the failing FRU (do not isolate non-defective FRU).

NOTE: Verify that all attached devices are supported by the computer.

NOTE: Verify that the power supply being used at the time of the failure is operating correctly. (See "Power System Check" on page 63):

1. Power-off the computer.
2. Visually check them for damage. If any problems are found, replace the FRU.
3. Remove or disconnect all of the following devices:
 - Non-Acer devices
 - Printer, mouse, and other external devices
 - Battery pack
 - Hard disk drive
 - DIMM
 - CD-ROM/Diskette drive Module
 - PC Cards
4. Power-on the computer.
5. Determine if the problem has changed.
6. If the problem does not recur, reconnect the removed devices one at a time until you find the failing FRU.
7. If the problem remains, replace the following FRU one at a time. Do not replace a non-defective FRU:
 - Main board
 - LCD assembly

Jumper and Connector Locations

Top View

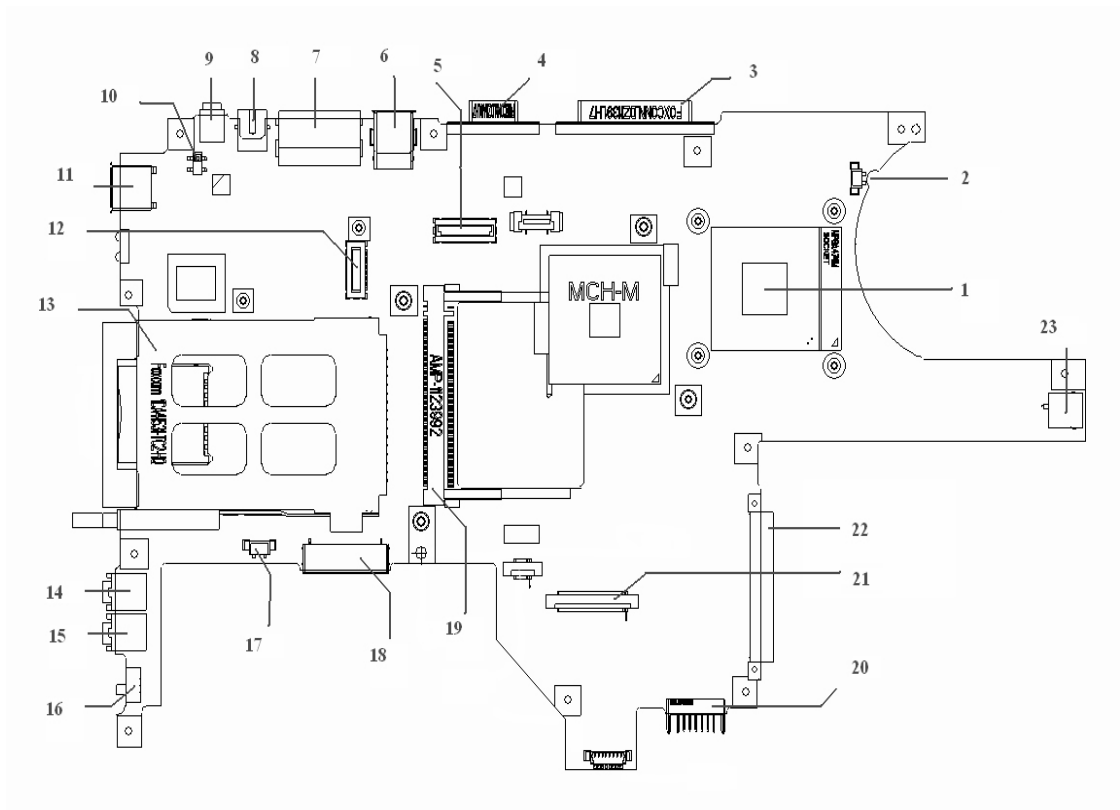

NOTE: TM290E does not have S-video port and IEEE 1394 port, therefore, No. 8 S-Video Connector and No. 9 IEEE 1394 Connector will not appear on the motherboard.

1-JP12	CPU Socket	14-JP20	MIC in Jack
2-JP7	FAN Connector	15-JP23	Headphone out Jack
3-JP2	Parallel Port	16-SW3	Wireless Kill Switch
4-JP1	CRT Connector	17-JP18	Speakers Connector
5-JP10	LCD Connector	18-JP17	Module Connector
6-JP6	USB Connector (x2)	19-JP13	Mini PCI Connector
7-JP5	RJ11/RJ45 Connector	20-PJP9	Battery Connector
10-SW1	Lid Switch	21-JPJ21	Keyboard Connector
11-JP8	USB Connector	22-JP22	HDD Connector
12-JP11	MDC/MBC Connector	23-PCN1	DC-In Jack
13-JP15	PCMCIA Connector		

SW1 Settings (Lid switch)

	Setting
Function 1	NONE
Function 2	LCD BACKLIGHT OFF
Function 3	STAND BY
Function 4	HIBERNATE

SW3 Settings(Kill Switch)

	Setting
On	Wireless On Bluetooth On
Off	Wireless Off Bluetooth Off

Bottom View

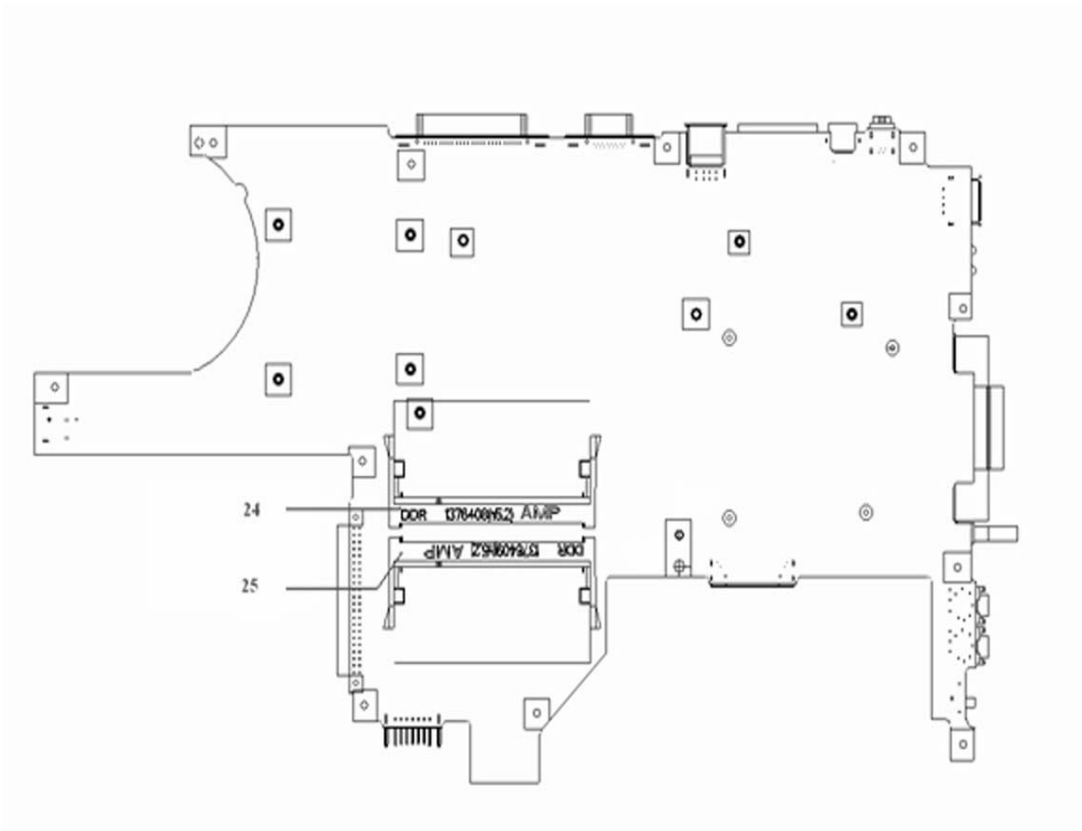

- 24-JP25 So-DIMM Socket
- 25-JP26 So-DIMM Socket

FRU (Field Replaceable Unit) List

This chapter gives you the FRU (Field Replaceable Unit) listing in global configurations of TravelMate 290E series products. Refer to this chapter whenever ordering for parts to repair or for RMA (Return Merchandise Authorization).

Please note that WHEN ORDERING FRU PARTS, you should check the most up-to-date information available on your regional web or channel. For whatever reasons a part number change is made, it will not be noted on the printed Service Guide. For ACER AUTHORIZED SERVICE PROVIDERS, your Acer office may have a DIFFERENT part number code from those given in the FRU list of this printed Service Guide. You MUST use the local FRU list provided by your regional Acer office to order FRU parts for repair and service of customer machines.

NOTE: To scrap or to return the defective parts, you should follow the local government ordinance or regulations on how to dispose it properly, or follow the rules set by your regional Acer office on how to return it.

Exploded Diagram

THE SYSTEM

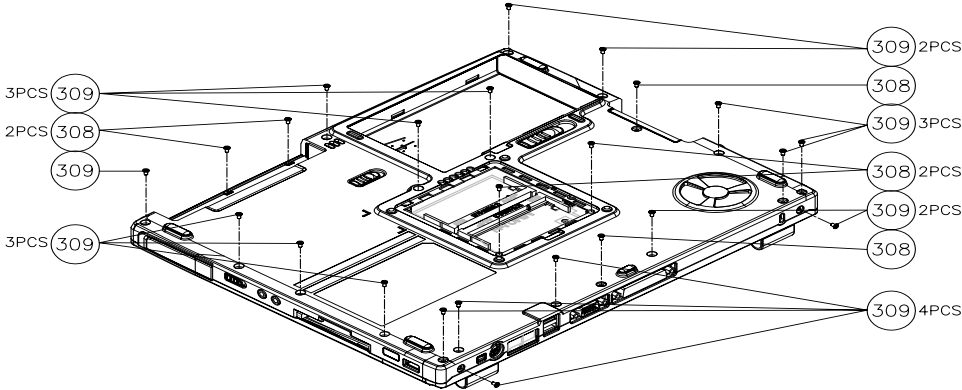
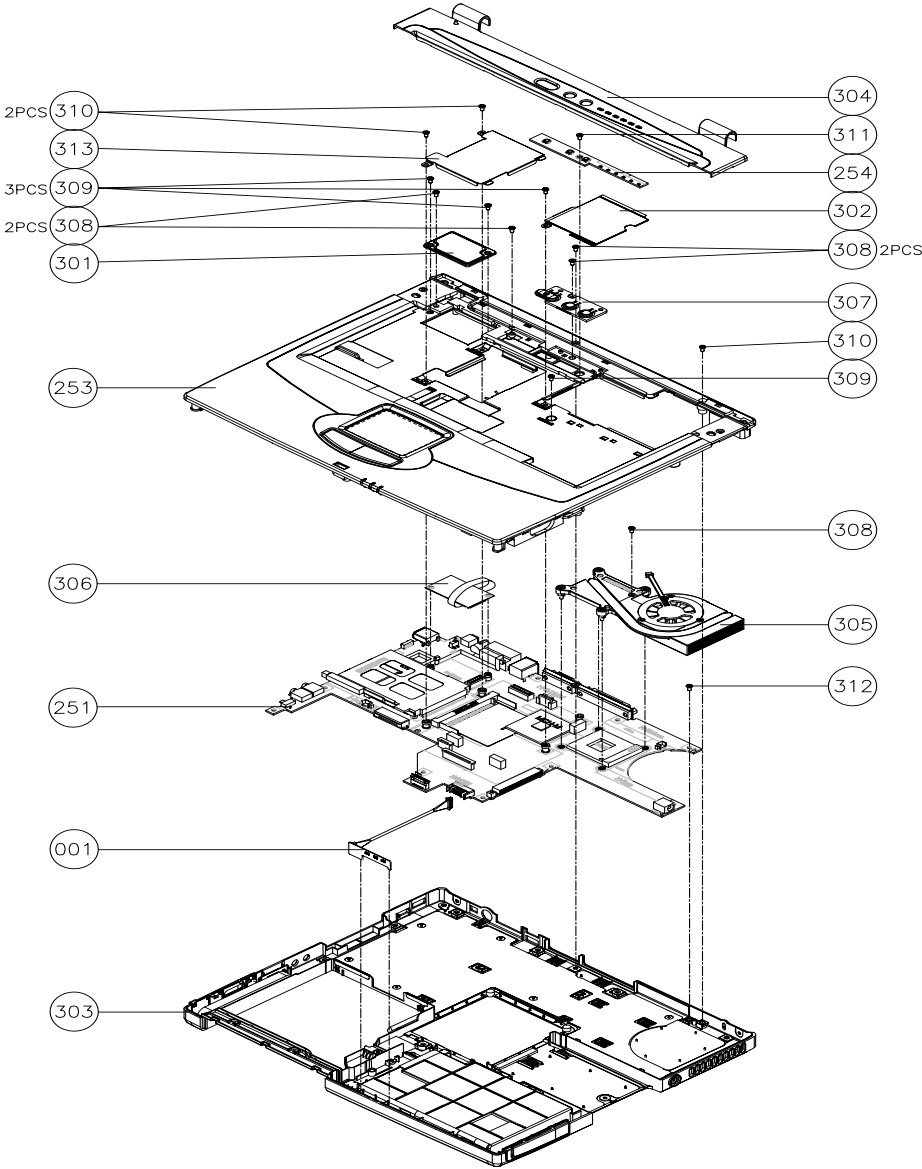

LOGIC UPPER ASSY

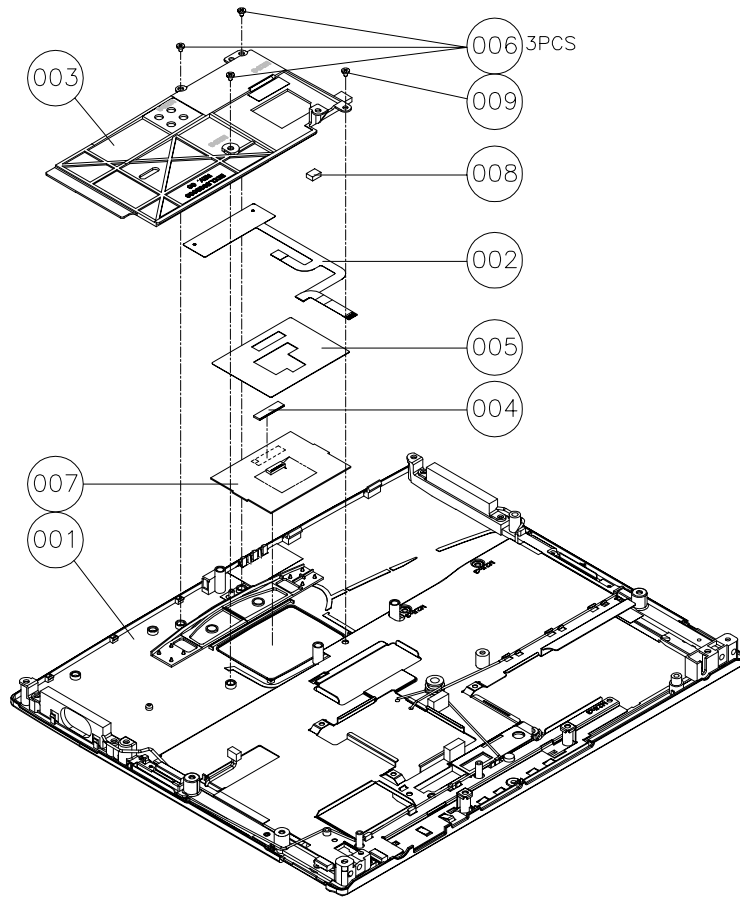

LCD 14.1"

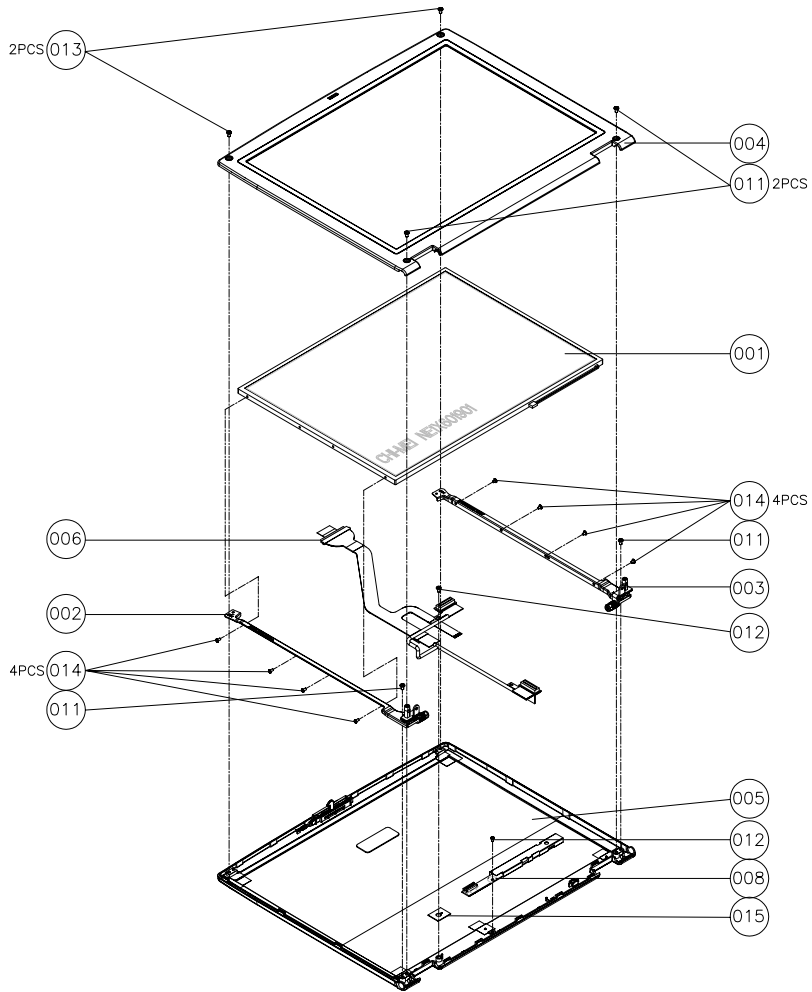

LCD 15"

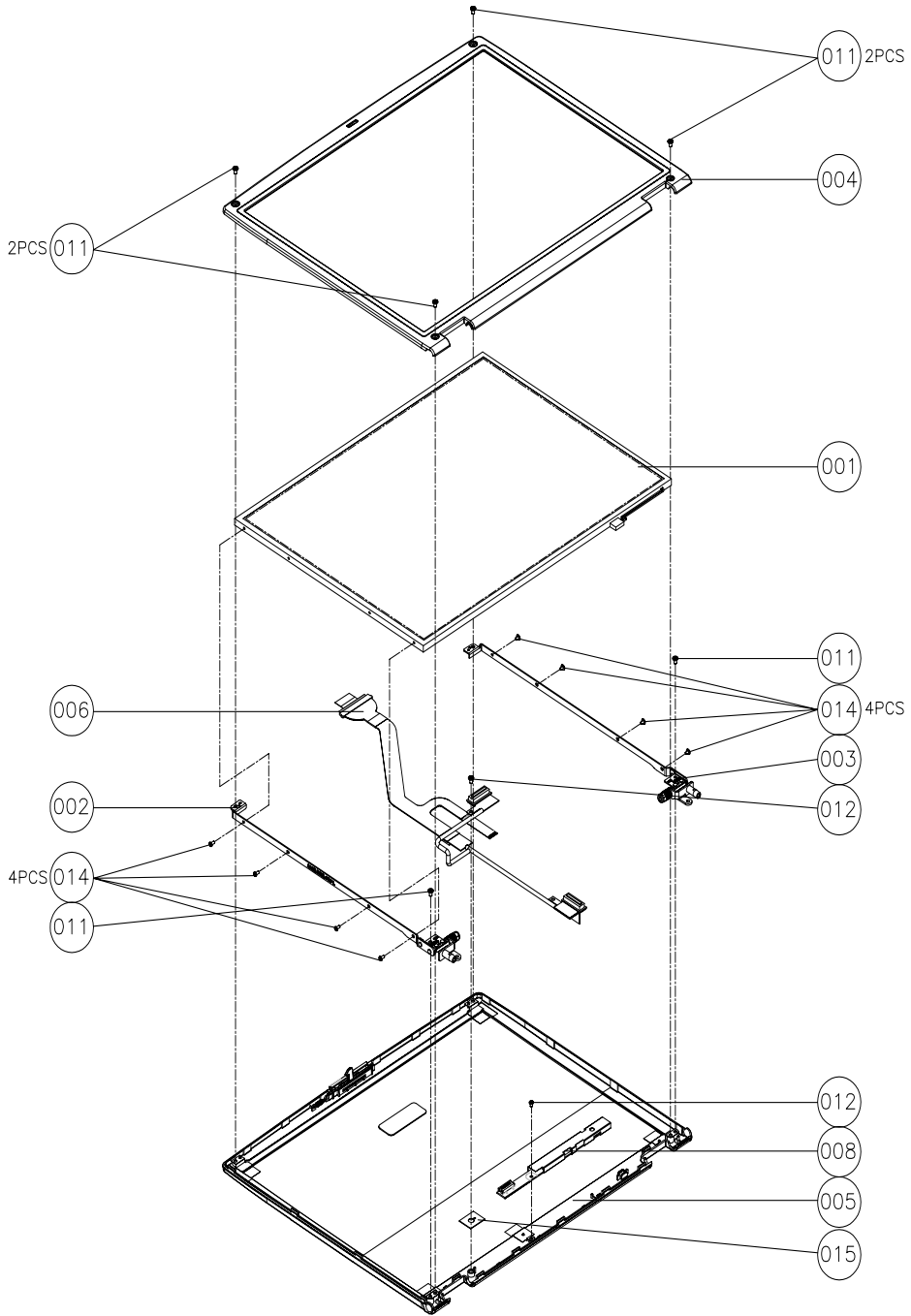

OPTICAL DISC DRIVE MODULE AND COMBO DRIVE MODULE

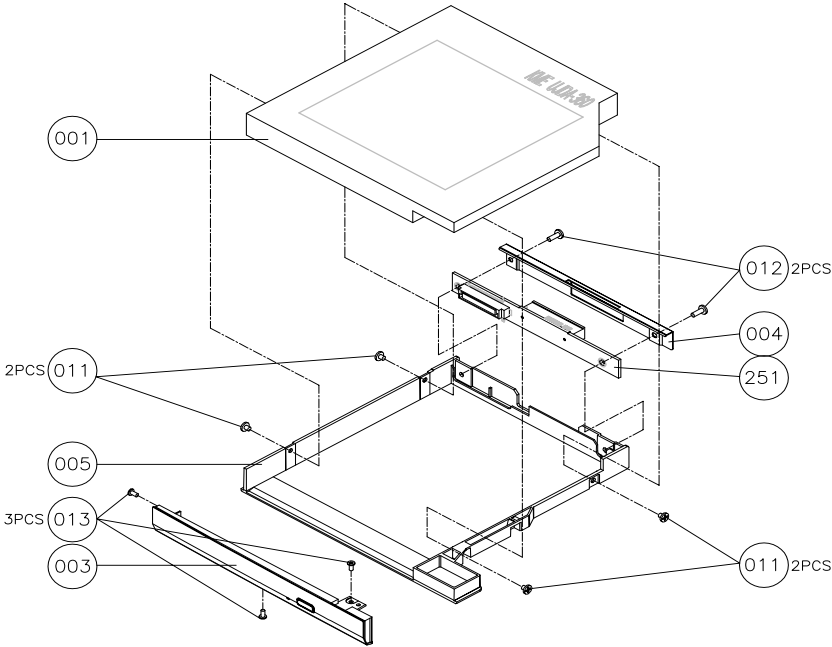

HDD ASSY

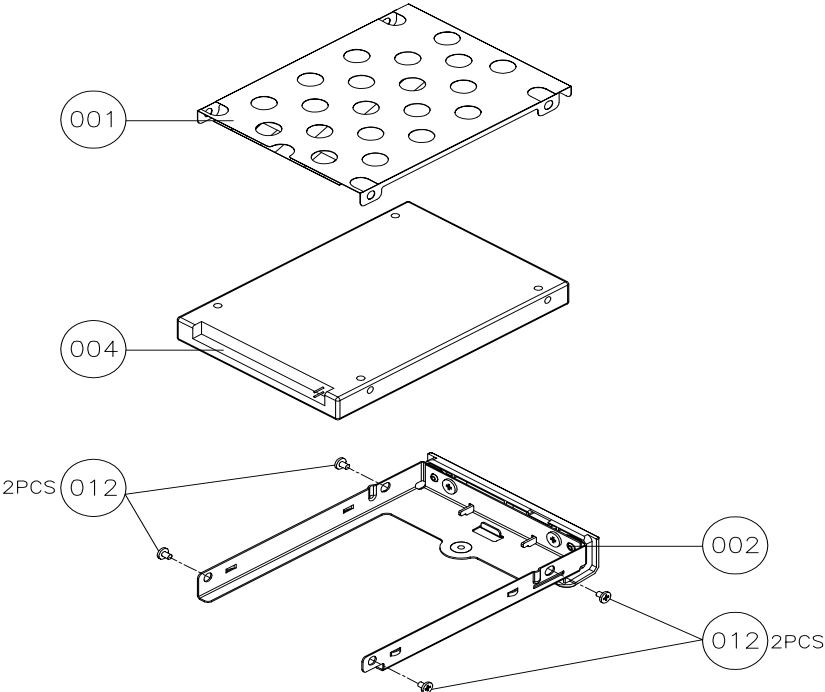

Picture	No.	Partname And Description	Part Number
Adapter			
	NS	ADAPTER - LITEON 65W, 3 PIN, PA-1650-02CA	AP.T3503.001
		ADAPTER - LITEON 65W, 3 PIN, PA-1650-02CR	AP.06503.002
		ADAPTER - DELTA 65W, 3 PIN, ADP-65DB	AP.T2101.001
Battery			
	NS	BATTERY SONY LI-ION 8 CELLS 4300mAH, US18650G5	BT.T3504.001
		BATTERY SAMSUNG LI-ION 8 CELLS 4300mAH, ICR18650-22	BT.T3506.001
		BATTERY SONY LI-ION 4 CELLS 2150mAH, US18650G5	BT.T3504.002
Boards			
	306-THE SYSTEM	MDC CARD, AMBIT, T60M283 W/CISPR	54.T35V5.001
	NS	MINI PCI WIRELESS BOARD (802.11g), WNC , 91.RM813.001	54.T40V5.001
	254-THE SYSTEM	LAUNCH BOARD	55.T35V5.001
Cables			
		TOUCHPAD BOARD FFC CABLE WITH BOARD	50.T40V5.001
	001-THE SYSTEM	LED CABLE	50.T35V5.002
	NS	MODEM CABLE	50.T35V5.003

Picture	No.	Partname And Description	Part Number
	NS	POWER CORD US (3Pin)	27.T35V5.001
		POWER CORD EC (3Pin)	27.T35V5.002
		POWER CORD Aus (3Pin)	27.T35V5.003
		POWER CORD UK (3Pin)	27.T35V5.004
		POWER CORD SWISS (3Pin)	27.T35V5.005
		POWER CORD CHINA (3Pin)	27.T35V5.006
		POWER CORD ITALIAN (3Pin)	27.T35V5.007
		POWER CORD DEMARK (3Pin)	27.T35V5.008
Case/Cover/Bracket Assembly			
	304-THE SYSTEM	MIDDLE COVER W/NAME PLATE	42.T40V5.001
	303-THE SYSTEM	LOWER CASE W/O TV OUT & 1394	60.T40V5.001
	NS	DIMM COVER	42.T35V5.002
	253-THE SYSTEM	UPPER CASE W/SPEAKERS	60.T40V5.002
	003-LOGIC UPPER ASSY	TOUCHPAD SUPPORT BRACKET NOTE: This item does not include FPC, yet the image here is with FPC.	33.T40V5.001
	307-THE SYSTEM	POWER BUTTON	42.T35V5.003

Picture	No.	Partname And Description	Part Number
	313-THE SYSTEM	MINI PCI COVER	42.T35V5.022
	301-THE SYSTEM	MDC COVER PLATE	42.T35V5.005
	302-THE SYSTEM	THERMAL PLATE	42.T35V5.007
COMMUNICATION MODULE			
	NS	ANTENNA SET	50.T35V5.015
CPU			
	NS	INTEL BANIAS-CELERON 1.2G 512K (PGA)	KC.BC001.12G
		INTEL BANIAS-CELERON 1.3G 512K (PGA)	KC.BC001.13G
HDD/ Hard Disk Drive			
	004-HDD ASSY	HDD 20GB 2.5 IN. 4200RPM TOSHIBA NEPTUNEV20 MK2023GAS	KH.02004.001
		HDD 20G 2.5 IN. 4200RPM HGST MORAGA IC25N020ATMR04-0 08K0632 F/W:AD0A	KH.02007.006
		HDD 30G 2.5 IN. 4200RPM HGST MORAGA IC25N020ATMR04-0 08K0910 F/W:AD0A	KH.03007.005
		HDD 30GB/2.5 IN./4200RPM/TOSHIBA NEPTUNE MK3021GAS	KH.33004.001
		HDD 30G 2.5 IN. 4200RPM FJV MHT2030AT	KH.03006.004
		HDD 40GB 2.5 IN. 4200RPM HGST MORAGA IC25N040ATMR04-0 08K0633 FW AD0A	KH.04007.009
		HDD 40GB/2.5 IN./4200RPM/TOSHIBA NEPTUNE MK4021GAS	KH.34004.001
		HDD 40G 2.5 IN. 5400RPM SEAGATE NEPTUNE ST94011A (5400rpm) F/W CODE 3.05	KH.04001.009
		HDD 40G 2.5 IN. 5400RPM HGST MORAGA HTS548040M9AT00	KH.04007.005

Picture	No.	Partname And Description	Part Number
		HDD 60G 2.5 IN. 4200RPM HGST MORAGA IC25N060ATMR04-0 08K0634 F/W :AD0A	KH.06007.006
		HDD 60GB/2.5 IN./5400RPM/TOSHIBA TRITON MK6022GAX	KH.06004.001
		HDD 60GB/2.5 IN./4200RPM/TOSHIBA NEPTUNE MK6021GAS	KH.36004.001
		HDD 60GB 2.5 IN. 5400RPM HGST MORAGA HTS548060M9AT00 08K0638	KH.06007.003
	001-HDD ASSY	HDD ESD PLATE ASSY	33.T35V5.004
	002-HDD ASSY	HDD CARRIER SUB ASSY	60.T35V5.009
Keyboard			
	NS	KEYBOARD ZIPPY ARABIC	KB.T350C.018
		KEYBOARD BELGIUM	KB.T350C.009
		KEYBOARD BRAZILIAN PORTUGUESE	KB.T350C.019
		KEYBOARD CANADIAN FRENCH	KB.T350C.020
		KEYBOARD CHINESE	KB.T350C.001
		KEYBOARD CZECH	KB.T350C.012
		KEYBOARD DANISH	KB.T350C.017
		KEYBOARD FRENCH	KB.T350C.007
		KEYBOARD GERMAN	KB.T350C.004
		KEYBOARD HUNGAIAN	KB.T350C.013
		KEYBOARD ZIPPY ITALIAN	KB.T350C.006
		KEYBOARD NORWAY	KB.T350C.016
		KEYBOARD PORTUGUESE	KB.T350C.011
		KEYBOARD RUSSIAN	KB.T350C.014
		KEYBOARD SPANISH	KB.T350C.010
		KEYBOARD SWEDEN	KB.T350C.015
		KEYBOARD SWISS/G	KB.T350C.008
		KEYBOARD THAI	KB.T350C.003
		KEYBOARD TURKISH	KB.T350C.022
		KEYBOARD UK	KB.T350C.005
		KEYBOARD US INTERNATIONAL	KB.T350C.002
		KEYBOARD GREEK	KB.T350C.021
LCD			

Picture	No.	Partname And Description	Part Number
	LCD 14.1 AND LCD 15.0	ASSY LCD MODULE 14.1" XGA AU (B141XN04 V.25AXXX)	6M.T40V5.011
		ASSY LCD MODULE 14.1" XGA CMO (N141X6-L01)	6M.T40V5.012
		ASSY LCD MODULE 14" XGA TOPPOLY (TD141TGCB1)	6M.T40V5.013
		ASSY LCD MODULE 15" AU (B150XG02-V1)	6M.T40V5.014
		ASSY LCD MODULE 15" AU (B150XG01-V2)	6M.T40V5.015
		ASSY LCD MODULE 15" HITACHI (TX38D81VC1CAB) REV.B	6M.T40V5.016
		ASSY LCD MODULE 15" LG (LP150X08-A5)	6M.T40V5.017
		ASSY LCD MODULE 15" AU (B150PG01)	6M.T40V5.018
		ASSY LCD MODULE 14.1" XGA AU (B141XN04 V.25AXXX) W/WIRELESS	6M.T40V5.021
		ASSY LCD MODULE 14.1" XGA CMO (N141X6-L01) W/WIRELESS	6M.T40V5.022
		ASSY LCD MODULE 14" XGA TOPPOLY (TD141TGCB1) W/WIRELESS	6M.T40V5.023
		ASSY LCD MODULE 15" AU (B150XG02-V1) W/WIRELESS	6M.T40V5.024
		ASSY LCD MODULE 15" AU (B150XG01-V2) W/WIRELESS	6M.T40V5.025
		ASSY LCD MODULE 15" HITACHI (TX38D81VC1CAB) REV.B W/WIRELESS	6M.T40V5.026
		ASSY LCD MODULE 15" LG (LP150X08-A5) NEW W/WIRELESS	6M.T40V5.027
		ASSY LCD MODULE 15" AU (B150PG01) W/WIRELESS	6M.T40V5.028
	001-LCD 14.1 AND LCD 15.0	LCD 14.1" XGA AU (B141XN04 V.25AXXX)	LK.14105.005
		LCD 14.1" XGA CMO (N141X6-L01)	LK.1410D.001
		LCD 14" XGA TOPPOLY (TD141TGCB1)	LK.1410I.001
		LCD 15" XGA AU (B150XG02-V1)	LK.15005.004
		LCD 15" XGA AU (B150XG01-V2)	LK.15005.001
		LCD 15" XGA HITACHI (TX38D81VC1CAB) REV.B	LK.15004.006
		LCD 15" XGA LG (LP150X08-A5)	LK.15008.012
		LCD 15" SXGA AU (B150PG01)	LK.15005.002
		LCD 14.1" XGA AU (B141XN04 V.25AXXX)	LK.14105.005
		LCD 14.1" XGA CMO (N141X6-L01)	LK.1410D.001
		LCD 14" XGA TOPPOLY (TD141TGCB1)	LK.1410I.001
		LCD 15" XGA AU (B150XG02-V1)	LK.15005.004

Picture	No.	Partname And Description	Part Number
		LCD 15" XGA AU (B150XG01-V2)	LK.15005.001
		LCD 15" XGA HITACHI (TX38D81VC1CAB) REV.B	LK.15004.006
		LCD 15" XGA LG (LP150X08-A5)	LK.15008.012
		LCD 15" SXGA AU (B150PG01)	LK.15005.002
	008-LCD 14.1 AND LCD 15.0	LCD INVERTER	19.T40V5.001
	005-LCD 14.1 AND LCD 15.0	LCD PANEL WITH LOGO (W/ANTENNA)	60.T35V5.013
	004-LCD 14.1 AND LCD 15.0	LCD BEZEL -14"	60.T35V5.006
		LCD BEZEL -15"	60.T35V5.007
	003-LCD 14.1 AND LCD 15.0	LCD BRACKET L14"	33.T35V5.006
		LCD BRACKET L15"	33.T35V5.008
	002-LCD 14.1 AND LCD 15.0	LCD BRACKET R14"	33.T35V5.007
		LCD BRACKET R15"	33.T35V5.009
	006-LCD 14.1 AND LCD 15.0	LCD WIRE CABLE - 14.1" AU	50.T40V5.002
		LCD WIRE CABLE - 14.1" CMO	50.T40V5.003
		LCD WIRE CABLE - 14" TOPPOLY	50.T40V5.004
		LCD WIRE CABLE - 15" AU	50.T40V5.005
		LCD WIRE CABLE - 15" HITACHI	50.T40V5.006
		LCD WIRE CABLE - 15" LG	50.T40V5.007
		LCD COAXIAL CABLE - 15" AU	50.T40V5.008
	NS	LCD RUBBER	47.T35V5.001
	NS	LCD SCREW PAD-LOW	47.T35V5.002
Main Board			

Picture	No.	Partname And Description	Part Number
	251-THE SYSTEM	MAINBOARD W/ PCMCIA SLOT, W/O TV OUT, 1394	LB.T4002.001
	THE SYSTEM	PCMCIA SLOT	22.T35V5.001
HEATSINK			
	305-THE SYSTEM	THERMAL MODULE	60.T40V5.003
Memory			
	NS	MEMORY DDR333 256MB INFINEON HYS64D32020GD-6-B (.14u)	KN.25602.009
		MEMORY DDR333 512MB INFINEON HYS64D64020GBDL-6-B (.14u)	KN.51202.007
		MEMORY DDR333 128MB INFINEON HYS64D16000GDL-6-B (.14u)	KN.12802.006
		MEMORY DDR333 256MB MICRON MT8VDDT3264HDG-335C3 (.13u)	KN.25604.009
		MEMORY DDR333 128MB NANYA NT128D64SH4BBGM-6K (.14u)	KN.12803.008
		MEMORY DDR333 256MB NANYA NT256D64SH8BAGM-6K (.14u)	KN.25603.009
Optical Drive			
	ODD MODULE AND COMBO DRIVE MODULE	CD-ROM MODULE 24X QSI SCR-242	6M.T35V5.002
		CD-ROM MODULE 24X TEAC CD-224E-C85	6M.T35V5.003
		DVD-ROM MODULE 8X QSI SDR-083	6M.T35V5.004
		DVD-ROM MODULE 8X TOSHIBA SD-C2612	6M.T40V5.001
		DVD/CDRW COMBO MODULE 24X LITEON LSC024082K	6M.T35V5.006
		DVD/CDRW COMBO MODULE 24X QSI SBW-242C	6M.T40V5.002
		DVD/CDRW COMBO MODULE 24X KME UJDA750	6M.T35V5.008
		DVD-DUAL MODULE 4X - HLDS GWA-4040N	6M.T40V5.003
		DVD-DUAL MODULE 4X- TOSHIBA SD-R6372	6M.T40V5.004
		DVD-SUPER MULTI MODULE - PANASONIC UJ-820B	6M.T40V5.005

Picture	No.	Partname And Description	Part Number
	001-ODD MODULE AND COMBO DRIVE MODULE	CD-ROM DRIVE 24X QSI SCR-242	KD.24X03.001
		CD-ROM DRIVE 24X TEAC CD-224E-C85	KD.24X06.002
		DVD-ROM DRIVE 8X QSI SDR-083	KV.08X03.001
		DVD-ROM DRIVE 8X TOSHIBA SD-C2612	TBD
		DVD/CDRW COMBO DRIVE 24X LITEON LSC024082K	KO.T2109.001
		DVD/CDRW COMBO DRIVE 24X QSI SBW- 242C	TBD
		DVD/CDRW COMBO DRIVE 24X KME UJDA750	KO.24X06.002
		DVD-DUAL DRIVE 4X - HLDS GWA-4040N	KU.0040D.004
		DVD-DUAL DRIVE 4X- TOSHIBA SD-R6372	KU.00401.001
		DVD-SUPER MULTI DRIVE - PANASONIC UJ- 820B	KU.00407.002
		CD-ROM BEZEL FOR QSI	42.T35V5.009
		CD-ROM BEZEL FOR TEAC	42.T35V5.010
		DVD-ROM BEZEL FOR QSI	42.T35V5.011
		DVD-ROM BEZEL FOR TOSHIBA	42.T35V5.012
		DVD/CDRW COMBO BEZEL FOR LITEON	42.T35V5.013
		DVD/CDRW COMBO BEZEL FOR QSI	42.T35V5.014
		DVD/CDRW COMBO BEZEL FOR KME	42.T35V5.015
		DVD-DUAL BEZEL FOR HLDS	42.T40V5.002
		DVD-DUAL BEZEL FOR TOSHIBA	42.T40V5.003
		DVD-SUPER MULTI BEZEL FOR PANASONIC	42.T40V5.004
	005-ODD MODULE AND COMBO DRIVE MODULE	OPTICAL DEVICE HOLDER	60.T35V5.004
	004-ODD MODULE AND COMBO DRIVE MODULE	OPTICAL DEVICE BRACKET	33.T35V5.003
	251-ODD MODULE AND COMBO DRIVE MODULE	OPTICAL DEVICE BOARD	55.T35V5.002
MISCELLANEOUS			
	NS	RUBBER FOOT	47.T35V5.003

Picture	No.	Partname And Description	Part Number
	NS	RUBBER FOOT(SMALL)	47.T35V5.004
	NS	LCD LATCH W/SPRING	6K.T35V5.002
POINTING DEVICE			
	007-LOGIC UPPER ASSY	TOUCHPAD	56.T35V5.001
Speaker			
	NS	SPEAKER R & L	6K.T35V5.001
Screws			
	NS	SCREW BTP M1,7 x 3.5ZS	86.T35V5.001
	NS	SCREW BTP M2 x 4 ZS	86.T35V5.002
	NS	SCREW D-SUB NUT	86.T35V5.003
	NS	SCREW M1.7 x 2.5ZS	86.T35V5.004
	NS	SCREW M2 x 6 (B) & NI	86.T35V5.005
	NS	SCREW M2 x 10 (B)	86.T35V5.006
	NS	SCREW M2 x 2.3 (NL)	86.T35V5.007
	NS	SCREW M2 x 3 (NL)	86.T35V5.008
	NS	SCREW M2 x 4 (B)	86.T35V5.009
	NS	SCREW M2 x 6 (NL)	86.T35V5.010
	NS	SCREW M2.5 x 1.1 (NL)	86.T35V5.011
	NS	SCREW M2.5 x 15 (NL)	86.T35V5.012
	NS	SCREW M2.5 x 3 (NL)	86.T35V5.013
	NS	SCREW M2.5 x 3 (NL) -up	86.T35V5.014
	NS	SCREW M2.5 x 4 (NL)	86.T35V5.015
	NS	SCREW M2.5 x 6 (NL)	86.T35V5.016
	NS	SCREW M3 x 4 (NL)	86.T35V5.017

Model Definition and Configuration

TravelMate 290 Series

Model Number	CPU	LCD	ODD	Memory	HDD (GB)	WLAN
292EXC/ 292EFXC	ICP-M1.3G	14.1 XGA	24x CDRW+DVD	1x256M	30GB	N
292EXCi	ICP-M1.3G	14.1 XGA	24x CDRW+DVD	1x 256M	30GB	11.b
292ELCi	ICP-M1.3G	15.0 XGA	24x CDRW+DVD	1x256M	30GB	11.b
292ELMi	ICP-M1.3G	15.0 XGA	2x DVD-Dual	1x256M	30GB	11b
292EFX	ICP-M1.3G	14.1 XGA	24xCD-ROM	1x256M	30GB	N
292EFXCi	ICP-M1.3G	14.1 XGA	24x CDRW+DVD	1x256M	30GB	11b

Test Compatible Components

This computer's compatibility is tested and verified by Acer's internal testing department. All of its system functions are tested under Windows® XP Home, Windows® XP Pro environment.

Refer to the following lists for components, adapter cards, and peripherals which have passed these tests. Regarding configuration, combination and test procedures, please refer to the TravelMate 290E series Compatibility Test Report released by the Acer Mobile System Testing Department.

Microsoft® Windows® XP Home Environment Test

Item	Specifications
Display	ViewSonic 17PS Philips Brilliance 107 Multiscan G200
Modem	3Com 56K Voice Fax Modem
I/O Peripheral	
IO - Printer	ESPON Epson Color 740 HP Laster Jet 2100 (R) HP LasterJet 5P (IR) HP DeskJet 500C HP DeskJet 3820
I/O - Mouse (PS/2)	Microsoft IntelliMouse TrackBall Microsoft Serial-Mouse Microsoft IntelliMouse 1.1 A Microsoft IntelliMouse Explorer (optical) Microsoft IntelliPoint (wireless) Logitech Mouse-Man Logitech Home mouse Logitech TrackMan Marble FX Logitech Cordless Mouse Pro (wireless) Logitech TrackMan Live (wireless) Logitech Cordless Mouse Man Wheel Lotitech M-S48a Logitech Mouse-Man (MCV-46)
I/O - Mouse (USB)	Microsoft IntelliMouse Explorer(Optical) Microsoft Wireless IntelliMouse Explorer Microsoft IntelliMouse Explorer 3.0 Microsoft TrackBall Explorer Loeitech M-UA34 Logitech Mouse-Man (MCV-46) Logitech Cordless Mouse Man Optical Logitech Mini Optical Mouse Logitech Mouse Man Traveler Logitech Cordless Optical Track Man Logitech MouseMan Dual Optical BTC Optic Mouse
I/O - Mouse (COM)	Microsoft IntelliPoint (Wireless) Microsoft Home mouse Microsoft Serial-Mouse Logitech Cordless Mouse Man Wheel Logitech M-M43 Logitech TrackMan Portable Mouse
I/O - Keyboard (PS/2)	Microsoft MS Windows 95 Microsoft Natural Microsoft Natural Pro
I/O - Keyboard (USB)	Chicony USB Keyboard Logitech Logitech Cordless Keyboard/Mouse Microsoft Natural Microsoft Natural Pro

Item	Specifications
I/O - Speaker (USB)	Philips DS350 Speaker Panasonic EAB-MPC57USB
I/O - Speaker (SPDIF)	Creative Desktop Theater 5.1 YAMAHA YAMAHA TSS-1
I/O - Joystick	Toshiba
I/O - SCSI	IBM SCS 1.5G HDD Plextor SCSI CD-R Plextor SCSI CD-ROM Roich SCSI CD-RW
I/O - USB (Camera)	Kodak DVC300 Intel PC Camera Pro Pack Ricoh ROC 5300 Logitech Quick Cam Pro 3000
I/O - USB (HUB)	BELKIN Express Bus HUB D-LINK HUB D-Link Ethernet Adapter Skywell Magic TopLAN Ethernet Adapter Adapter Xhub+
I/O - Scanner	Logitech Page Scan Pro Pack NEC Full Color Image Scanner Mustek Scanner 1200sp
I/O - 1394 Device	FUJITSU DYNA MO 640 Sony DCR-RTV20 Digital Camera VST FireWire Hand Drive
I/O - 802.11b Device	3Com Wireless AP (3CRW737A) Cisco Cisco Wireless AP (AIR-PCM340) Toshiba BT Modem
PCMCIA Card	
LAN Card	3Com Ethernet III Card (3C589B) 3Com 10/100 Lan CardBus with XJACK connector (3CXFE575CT) 3Com 10/100 Lan CardBus (3CCFE575BT) 3Com 32bit CardBus 10/100 BASE-TX (3C575-TX) 3Com TokenLink Velocity 16/4 3Com 10/100 CardBus with XJACK Connector (3CXFE575BT) 3Com Megahertz 10/100 Lan CardBus (3CCFE575CT) 3Com Fast Ethernet 10/100 BASE-TX (3CCFE575CT-D) ActionTec Data Link 56K PC Card Fax Modem (MDV9012-01) IBM Ethernet Card IBM Token Ring Card TDK Network Flyer CardBus 100BaseTX/10BaseT (LAK-CB100AX) TDK LAN Flyer (LAK-CB100AX) USRobotics Megahertz 128M ISDN Xircom 32bit CardBus Ethernet 10/100 (CBE-100) Xircom CreditCard Ethernet 10/100 (CEB3B-100TX) LINKSYS Ethernet Card
Modem Card	3Com Megahertz 56K Modem (XJ2560) 3Com 56K Global Modem PC Card (3CCM156B) 3Com WinModem PC Card with XJACK Connector (3CXM356) 3Com U.S.Robotics 56KWinmodem(Model:3013) DELL Data/Fax Modem 2400/9600bps(24/96) DELL Data/Fax Modem 14400/14400bps(14.4)

Item	Specifications
	DELL Data/Fax Modem 28.8Kbps/14.4Kbps(V.34XJ) EXP Fax/Data modem 9600/2400 Robotics WorldPort 14400 Fax/Data modem USRobotics Megahertz 56K Modem (XJ5560) USRobotics Upgradeable 33.6K Modem (SP1336) Xircom RealPort Modem56 (RM56V1) Xircom 32bit CardBus Modem56 WinGlobal (CBM56WG) New Media 33.6 Netsurfer 56K+Fax Gold Card Multi-Function Card BLASTER Modem 56K Flash56 PCMCIA(D15610)
Combo Card	3Com Ethernet III LAN+33.6K Modem (3C562C/3C563C) 3Com Ethernet III LAN+33.6K Modem (3C562D/3C563D) 3Com 10/100 Lan+56K Modem (3CCFEM556) 3Com 10/100 CardBus Lan+56K Modem (3CCFEM656B) Olicom GoCard Ethernet+33.6K Modem Xircom CreditCard Ethernet+33.6K Modem Xircom CreditCard Ethernet 10/100 + Modem56 Xircom RealPort Card Ethernet 10/100+56K Modem(RBEM56G-100) Xircom Ethernet 10/100+Modem 56K (RBEM56G-100)
SCSI Card	Adaptec SlimSCSI 36bit (1480A) CardBus UltraSCSI Adaptec SlimSCSI 16 bits (1460B)
Storage Card	Fujitsu SRAM Card Pretec MPEG-I Card Margi MPEG-II Card Pretec 8M/16M Flash Card Kingston Flash Card 64MB Feiya Smart Media Flash Memory Card To PCMCIA (32MB) Feiya Compact Flash Card (32MB) Iomega CliK! PC Card 40MB Toshiba Microdriver 2G HDD Toshiba Microdriver 5G HDD IBM Microdriver 1G Panasonic Secure Digital 8/16/32/64/128/256/512M Toshiba Secure Digital 8/16/32/64/128M Toshiba SmartMedia 2/4/8/16/32/64/128/2 5V/4 5V Samsung SmartMedia 8/16/32/64/128 SanDisk Secure Digital 16/128M
Wireless LAN/Bluetooth Card	Cisco AIR PCM-340 wireless lan card 3Com Airconnect 3CRWE 737A wireless lan card Toshiba Bluetooth PCMCIA Card Orinoco Wireless PC Card (GOLD) Dell TureMobile 1170 AP SMC EZ Connect 802.11a Wireless Cardbus adapter (SMC2735W) Intel PRO/Wireless 5000 CardBus LAN Adapter (WCB5000AM)
USB 2.0 PCMCIA Card	Adaptec USB2.0 Connect CardBus Card (AUA-1420)
Other	Socket Serial I/O Card DELL Audio Card DELL IEEE-1394a PC Card for PC System Toshiba PC Card Fingerprint Reader Nokia Nokia PCMCIA Phonecard

Microsoft® Windows® XP Pro Environment Test

Item	Specifications
Display	ViewSonic 17PS Philips Brilliance 107 Multiscan G200
Modem	3Com 56K Voice Fax Modem
I/O Peripheral	
IO - Printer	ESPON Epson Color 740 HP Laster Jet 2100 (R) HP LasterJet 5P (IR) HP DeskJet 500C HP DeskJet 3820
I/O - Mouse (PS/2)	Microsoft IntelliMouse TrackBall Microsoft Serial-Mouse Microsoft IntelliMouse 1.1 A Microsoft IntelliMouse Explorer (optical) Microsoft IntelliPoint (wireless) Logitech Mouse-Man Logitech Home mouse Logitech TrackMan Marble FX Logitech Cordless Mouse Pro (wireless) Logitech TrackMan Live (wireless) Logitech Cordless Mouse Man Wheel Lotitech M-S48a Logitech Mouse-Man (MCV-46)
I/O - Mouse (USB)	Microsoft IntelliMouse Explorer(Optical) Microsoft Wireless IntelliMouse Explorer Microsoft IntelliMouse Explorer 3.0 Microsoft TrackBall Explorer Loeitech M-UA34 Logitech Mouse-Man (MCV-46) Logitech Cordless Mouse Man Optical Logitech Mini Optical Mouse Logitech Mouse Man Traveler Logitech Cordless Optical Track Man Logitech MouseMan Dual Optical BTC Optic Mouse
I/O - Mouse (COM)	Microsoft IntelliPoint (Wireless) Microsoft Home mouse Microsoft Serial-Mouse Logitech Cordless Mouse Man Wheel Logitech M-M43 Logitech TrackMan Portable Mouse
I/O - Keyboard (PS/2)	Microsoft MS Windows 95 Microsoft Natural Microsoft Natural Pro
I/O - Keyboard (USB)	Chicony USB Keyboard Logitech Logitech Cordless Keyboard/Mouse Microsoft Natural Microsoft Natural Pro

Item	Specifications
I/O - Speaker (USB)	Philips DS350 Speaker Panasonic EAB-MPC57USB
I/O - Speaker (SPDIF)	Creative Desktop Theater 5.1 YAMAHA YAMAHA TSS-1
I/O - Joystick	Toshiba
I/O - SCSI	IBM SCS 1.5G HDD Plextor SCSI CD-R Plextor SCSI CD-ROM Roich SCSI CD-RW
I/O - USB (Camera)	Kodak DVC300 Intel PC Camera Pro Pack Ricoh ROC 5300 Logitech Quick Cam Pro 3000
I/O - USB (HUB)	BELKIN Express Bus HUB D-LINK HUB D-Link Ethernet Adapter Skywell Magic TopLAN Ethernet Adapter Adapter Xhub+
I/O - Scanner	Logitech Page Scan Pro Pack NEC Full Color Image Scanner Mustek Scanner 1200sp
I/O - 1394 Device	FUJITSU DYNA MO 640 Sony DCR-RTV20 Digital Camera VST FireWire Hand Drive
I/O - 802.11b Device	3Com Wireless AP (3CRW737A) Cisco Cisco Wireless AP (AIR-PCM340) Toshiba BT Modem
PCMCIA Card	
LAN Card	3Com Ethernet III Card (3C589B) 3Com 10/100 Lan CardBus with XJACK connector (3CXFE575CT) 3Com 10/100 Lan CardBus (3CCFE575BT) 3Com 32bit CardBus 10/100 BASE-TX (3C575-TX) 3Com TokenLink Velocity 16/4 3Com 10/100 CardBus with XJACK Connector (3CXFE575BT) 3Com Megahertz 10/100 Lan CardBus (3CCFE575CT) 3Com Fast Ethernet 10/100 BASE-TX (3CCFE575CT-D) ActionTec Data Link 56K PC Card Fax Modem (MDV9012-01) IBM Ethernet Card IBM Token Ring Card TDK Network Flyer CardBus 100BaseTX/10BaseT (LAK-CB100AX) TDK LAN Flyer (LAK-CB100AX) USRobotics Megahertz 128M ISDN Xircom 32bit CardBus Ethernet 10/100 (CBE-100) Xircom CreditCard Ethernet 10/100 (CEB3B-100TX) LINKSYS Ethernet Card
Modem Card	3Com Megahertz 56K Modem (XJ2560) 3Com 56K Global Modem PC Card (3CCM156B) 3Com WinModem PC Card with XJACK Connector (3CXM356) 3Com U.S.Robotics 56KWinmodem(Model:3013) DELL Data/Fax Modem 2400/9600bps(24/96) DELL Data/Fax Modem 14400/14400bps(14.4)

Item	Specifications
	DELL Data/Fax Modem 28.8Kbps/14.4Kbps(V.34XJ) EXP Fax/Data modem 9600/2400 Robotics WorldPort 14400 Fax/Data modem USRobotics Megahertz 56K Modem (XJ5560) USRobotics Upgradeable 33.6K Modem (SP1336) Xircom RealPort Modem56 (RM56V1) Xircom 32bit CardBus Modem56 WinGlobal (CBM56WG) New Media 33.6 Netsurfer 56K+Fax Gold Card Multi-Function Card BLASTER Modem 56K Flash56 PCMCIA(D15610)
Combo Card	3Com Ethernet III LAN+33.6K Modem (3C562C/3C563C) 3Com Ethernet III LAN+33.6K Modem (3C562D/3C563D) 3Com 10/100 Lan+56K Modem (3CCFEM556) 3Com 10/100 CardBus Lan+56K Modem (3CCFEM656B) Olicom GoCard Ethernet+33.6K Modem Xircom CreditCard Ethernet+33.6K Modem Xircom CreditCard Ethernet 10/100 + Modem56 Xircom RealPort Card Ethernet 10/100+56K Modem(RBEM56G-100) Xircom Ethernet 10/100+Modem 56K (RBEM56G-100)
SCSI Card	Adaptec SlimSCSI 36bit (1480A) CardBus UltraSCSI Adaptec SlimSCSI 16 bits (1460B)
Storage Card	Fujitsu SRAM Card Pretec MPEG-I Card Margi MPEG-II Card Pretec 8M/16M Flash Card Kingston Flash Card 64MB Feiya Smart Media Flash Memory Card To PCMCIA (32MB) Feiya Compact Flash Card (32MB) Iomega CliK! PC Card 40MB Toshiba Microdriver 2G HDD Toshiba Microdriver 5G HDD IBM Microdriver 1G Panasonic Secure Digital 8/16/32/64/128/256/512M Toshiba Secure Digital 8/16/32/64/128M Toshiba SmartMedia 2/4/8/16/32/64/128/2 5V/4 5V Samsung SmartMedia 8/16/32/64/128 SanDisk Secure Digital 16/128M
Wireless LAN/Bluetooth Card	Cisco AIR PCM-340 wireless lan card 3Com Airconnect 3CRWE 737A wireless lan card Toshiba Bluetooth PCMCIA Card Orinoco Wireless PC Card (GOLD) Dell TureMobile 1170 AP SMC EZ Connect 802.11a Wireless Cardbus adapter (SMC2735W) Intel PRO/Wireless 5000 CardBus LAN Adapter (WCB5000AM)
USB 2.0 PCMCIA Card	Adaptec USB2.0 Connect CardBus Card (AUA-1420)
Other	Socket Serial I/O Card DELL Audio Card DELL IEEE-1394a PC Card for PC System Toshiba PC Card Fingerprint Reader Nokia Nokia PCMCIA Phonecard

Online Support Information

This section describes online technical support services available to help you repair your Acer Systems.

If you are a distributor, dealer, ASP or TPM, please refer your technical queries to your local Acer branch office. Acer Branch Offices may access our website. However some information sources will require a user i.d. and password. These can be obtained directly from Acer CSD Taiwan.

Acer's Website offers you convenient and valuable support resources whenever you need them.

In the Technical Information section you can download information on all of Acer's Notebook, Desktop and Server models including:

- Service guides for all models
- User's manuals
- Training materials
- Bios updates
- Software utilities
- Spare parts lists
- TABs (Technical Announcement Bulletin)

For these purposes, we have included an Acrobat File to facilitate the problem-free downloading of our technical material.

Also contained on this website are:

- Detailed information on Acer's International Traveler's Warranty (ITW)
- Returned material authorization procedures
- An overview of all the support services we offer, accompanied by a list of telephone, fax and email contacts for all your technical queries.

We are always looking for ways to optimize and improve our services, so if you have any suggestions or comments, please do not hesitate to communicate these to us.

A

AC Adapter 31
AFLASH Utility 42

B

Battery Pack 47
BIOS Setup Utility 33
BIOS Utility 33
Basic System Settings 35
Navigating 33
Startup Configuration 38
System Information 34
System Security 34, 41

D

DIMM
external 48
removing 48
Disassembly
Battery Pack 46
CD-ROM/DVD-ROM Module 51
Floppy Disk Drive 57
Machine 43
Procedure Flowchart 45

E

Error Symptom-to-Spare Part Index 67
External CD-ROM Drive Check 62

F

Features 1
Flash Utility 42
Floppy Disk
removing the 57
FRU (Field Replaceable Unit) List 79

I

Intermittent Problems 72

J

Jumper and Connector Locations 75
Top View 75
Bottom View 77

K

Keyboard or Auxiliary Input Device Check 63

M

Machine Disassembly 43
Memory Check 63
Model Definition 94
Modem Combo Card
external 49

O

Online Support Information 103

P

Panel
Bottom 11
Power System Check
Battery Pack 65
Power Adapter 64, 65

R

RMA 79

S

System Check Procedures 62
System Diagnostic Diskette 42
System Utilities 33
System Utility Diskette 42

T

Temperature 32
Test Compatible Components 95
Touchpad Check 65
Troubleshooting 61

U

Undetermined Problems 73
utility
BIOS 33

W

Windows 2000 Environment Test 96

Free Manuals Download Website

<http://myh66.com>

<http://usermanuals.us>

<http://www.somanuals.com>

<http://www.4manuals.cc>

<http://www.manual-lib.com>

<http://www.404manual.com>

<http://www.luxmanual.com>

<http://aubethermostatmanual.com>

Golf course search by state

<http://golfingnear.com>

Email search by domain

<http://emailbydomain.com>

Auto manuals search

<http://auto.somanuals.com>

TV manuals search

<http://tv.somanuals.com>