



**Extensa 500 Series
Notebook Computer**

User's Guide

Copyright © 1998 Acer Incorporated
All Rights Reserved — Printed in Taiwan

Extensa 500 Series Notebook Computer User's Guide
Part No.: 49.45B01.001
Original Issue: June 1998
First Revision: July 1998
Second Revision: August 1998

Changes may be made periodically to the information in this publication without obligation to notify any person of such revision or changes. Such changes will be incorporated in new editions of this manual. This company makes no representations or warranties, either expressed or implied, with respect to the contents hereof and specifically disclaims the implied warranties of merchantability or fitness for a particular purpose.

Record the serial number, purchase date, and model number in the space provided below. The serial number and model number are recorded on the label affixed to the underside of the computer. All correspondence concerning your unit should include the serial number, model number, and date of purchase.

No part of this publication may be reproduced, stored in a retrieval system, or transmitted, in any form or by any means, electronic, mechanical, photocopy, recording, or otherwise, without the prior written permission of Acer Incorporated.

Extensa Notebook Computer

Model _____ Serial No. _____
Purchase Date _____

Extensa is a trademark and a product of Acer Inc., developed with Texas Instruments Inc. All other trademarks and registered trademarks are the property of their respective companies. Microsoft, MS-DOS, and Windows are registered trademarks of Microsoft Corporation.

Table of Contents

Notices	v
Preface	xiii
Connecting the Computer	xiv
Getting Help Online	xvi
Support Information	xvii
Care and Maintenance	xviii
Chapter 1 Getting Familiar with your Computer	1
Features	2
Display	4
Indicators	6
Keyboard	8
Touchpad	14
Storage	16
Ports	18
Audio	23
Securing your Computer	26
Chapter 2 Operating on Battery Power	29
Battery Pack	30
Power Management	36
Chapter 3 Peripherals and Options	41
External Monitor	42
External Keyboard	43
External Keypad	44
External Pointing Device	45
Printer	47
Audio Devices	48
Port Replicator	49
PC Cards	50
USB Devices	51
Miscellaneous Options	52
Key Component Upgrades	54
Chapter 4 Moving with your Computer	57
Disconnecting from the Desktop	58
Moving Around	59
Taking the Computer Home	60
Traveling with the Computer	62

Table of Contents

Traveling Internationally with the Computer	63
Chapter 5 Software	65
System Software	66
Sleep Manager.	67
Notebook Manager	74
BIOS Utility.	84
Chapter 6 Troubleshooting	95
Frequently-Asked Questions	96
Error Messages	101
Appendix A Specifications	105
Index.	109

FCC Notice

This device has been tested and found to comply with the limits for a Class B digital device pursuant to Part 15 of the FCC Rules. These limits are designed to provide reasonable protection against harmful interference in a residential installation. This device generates, uses, and can radiate radio frequency energy and, if not installed and used in accordance with the instructions, may cause harmful interference to radio communications.

However, there is no guarantee that interference will not occur in a particular installation. If this device does cause harmful interference to radio or television reception, which can be determined by turning the device off and on, the user is encouraged to try to correct the interference by one or more of the following measures:

1. Reorient or relocate the receiving antenna
2. Increase the separation between the device and receiver
3. Connect the device into an outlet on a circuit different from that to which the receiver is connected
4. Consult the dealer or an experienced radio/television technician for help

Notice: Shield Cables

All connections to other computing devices must be made using shielded cables to maintain compliance with FCC regulations.

Notice: Peripheral Devices

Only peripherals (input/output devices, terminals, printers, etc.) certified to comply with the Class B limits may be attached to this equipment. Operation with non-certified peripherals is likely to result in interference to radio and TV reception.

Notices

Caution

Changes or modifications not expressly approved by the manufacturer could void the user's authority, which is granted by the Federal Communications Commission, to operate this computer.

Use Conditions

This part complies with Part 15 of the FCC Rules. Operation is subject to the following two conditions: (1) this device may not cause harmful interference, and (2) this device must accept any interference received, including interference that may cause undesired operation.

Notice: Canadian Users

This Class B digital apparatus meets all requirements of the Canadian Interference-Causing Equipment Regulations.

Remarque à l'intention des utilisateurs canadiens

Cet appareil numérique de la classe B respecte toutes les exigences du Règlement sur le matériel brouilleur du Canada.

Important Safety Instructions

- 1.** Read these instructions carefully. Save these instructions for future reference.
- 2.** Follow all warnings and instructions marked on the product.
- 3.** Unplug this product from the wall outlet before cleaning. Do not use liquid cleaners or aerosol cleaners. Use a damp cloth for cleaning.
- 4.** Do not use this product near water.
- 5.** Do not place this product on an unstable cart, stand, or table. The product may fall, causing serious damage to the product.
- 6.** Slots and openings in the cabinet and the back or bottom are provided for ventilation; to ensure reliable operation of the product and to protect it from overheating, these openings must not be blocked or covered. The openings should never be blocked by placing the product on a bed, sofa, rug, or other similar surface. This product should never be placed near or over a radiator or heat register, or in a built-in installation unless proper ventilation is provided.
- 7.** This product should be operated from the type of power indicated on the marking label. If you are not sure of the type of power available, consult your dealer or local power company.
- 8.** Do not allow anything to rest on the power cord. Do not locate this product where persons will walk on the cord.
- 9.** If an extension cord is used with this product, make sure that the total ampere rating of the equipment plugged into the extension cord does not exceed the extension cord ampere rating. Also, make sure that the total rating of all products plugged into the wall outlet does not exceed the fuse rating.

Notices

- 10.** Never push objects of any kind into this product through cabinet slots as they may touch dangerous voltage points or short out parts that could result in a fire or electric shock. Never spill liquid of any kind on the product.
- 11.** Do not attempt to service this product yourself, as opening or removing covers may expose you to dangerous voltage points or other risks. Refer all servicing to qualified service personnel.
- 12.** Unplug this product from the wall outlet and refer servicing to qualified service personnel under the following conditions:
 - a.** When the power cord or plug is damaged or frayed
 - b.** If liquid has been spilled into the product
 - c.** If the product has been exposed to rain or water
 - d.** If the product does not operate normally when the operating instructions are followed. Adjust only those controls that are covered by the operating instructions since improper adjustment of other controls may result in damage and will often require extensive work by a qualified technician to restore the product to normal condition.
 - e.** If the product has been dropped or the cabinet has been damaged
 - f.** If the product exhibits a distinct change in performance, indicating a need for service.
- 13.** Replace the battery with the same type as the product's battery we recommend. Use of another battery may present a risk of fire or explosion. Refer battery replacement to a qualified serviceman.
- 14.** Warning! Batteries may explode if not handled properly. Do not disassemble or dispose of them in fire. Keep them away from children and dispose of used batteries promptly.

Notices

- 15.** Use only the proper type of power supply cord set (provided in your accessories box) for this unit. It should be a detachable type: UL listed/CSA certified, type SPT-2, rated 7A 125V minimum, VDE approved or its equivalent. Maximum length is 15 feet (4.6 meters).

Notices

Laser Compliance Statement

The CD-ROM drive in this computer is a laser product. The CD-ROM drive's classification label (shown below) is located on the drive.

CLASS 1 LASER PRODUCT

CAUTION: INVISIBLE LASER RADIATION WHEN OPEN.
AVOID EXPOSURE TO BEAM.

APPAREIL A LASER DE CLASSE 1 PRODUIT

LASERATTENTION: RADIATION DU FAISCEAU LASER
INVISIBLE EN CAS D'OUVERTURE. EVITER TOUTE
EXPOSITION AUX RAYONS.

LUOKAN 1 LASERLAITE LASER KLASSE 1

VORSICHT: UNSICHTBARE LASERSTRAHLUNG, WENN
ABDECKUNG GEÖFFNET NICHT DEM STRAHL
AUSSETZEN

PRODUCTO LÁSER DE LA CLASE I

ADVERTENCIA: RADIACIÓN LÁSER INVISIBLE AL SER
ABIERTO. EVITE EXPONERSE A LOS RAYOS.

ADVARSEL: LASERSTRÅLING VEDÅBNING SE IKKE IND I
STRÅLEN.

VARO! LAVATTAESSA OLET ALTTINA LASERSÄTEILYLLE.

WARNING: LASERSTRÅLNING NÅR DENNA DEL ÄR
ÖPPNAD ÄLÅ TUIJOTA SÄTEESEENSTIRRA EJ IN I
STRÅLEN

WARNING: LASERSTRÅLNING NAR DENNA DEL ÄR
ÖPPNADSTIRRA EJ IN I STRÅLEN

ADVARSEL: LASERSTRÅLING NAR DEKSEL ÅPNESSTIRR
IKKE INN I STRÅLEN

Lithium Battery Statement

The following statement refers to the internal lithium battery that powers the computer's clock.

CAUTION

Danger of explosion if battery is incorrectly replaced. Replace only with the same or equivalent type recommended by the manufacturer. Discard used batteries according to the manufacturer's instructions.

ADVARSEL!

Lithiumbatteri - Eksplosionsfare ved fejlagtig håndtering. Udskiftning må kun ske med batteri af samme fabrikat og type. Léver det brugte batteri tilbage til leverandøren.

ADVARSEL

Eksplosjonsfare ved feilaktig skifte av batteri. Benytt samme batteritype eller en tilsvarende type anbefalt av apparatfabrikanten. Brukte batterier kasseres i henhold til fabrikantens instruksjoner.

WARNING

Explosionsfara vid felaktigt batteribyte. Använd samma batterityp eller en ekvivalent typ som rekommenderas av apparattillverkaren. Kassera använt batteri enligt fabrikantens instruktion.

VAROITUS

Päristo voi räjähtää, jos se on virheellisesti asennettu. Vaihda paristo ainoastaan laitevalmistajan suosittelemaan tyyppiin. Hävitä käytetty paristo valmistajan ohjeiden mukaisesti.

VORSICHT!

Explosionsgefahr bei unsachgemäßen Austausch der Batterie Ersatz nur durch denselben oder einem vom Hersteller empfohlenem ähnlichen Typ. Entsorgung gebrauchter Batterien nach Angaben des Herstellers.

Notices

Year 2000 Compliance Statement

The Extensa 500 series notebook computer is Year 2000-compliant and carries the “NSTL Hardware Tested Year 2000 Compliant” logo. This model has been tested both by Acer’s internal test labs and NSTL using NSTL’s YMARK2000 certification test. These tests certify that this model will successfully make the year 2000 transition.



For more details, check the Acer Year 2000 Resource Center at <http://www.acer.com/year2000>

This manual describes features of the Extensa 500 Series notebook computers. The Extensa series computers incorporate such features as CardBus, 16-bit stereo audio, internal pointing device, Universal Serial Bus, and all-in-one media storage. The Extensa 500 Series also has unique compact disc (CD) player control features.

This manual should answer most of the questions you have about the day-to-day operation of your Extensa notebook computer.

Use the Just for Starters... instructions that came with your computer to get your computer running for the first time.

You should also take advantage of the online help files that are available with almost all of the programs shipped with your computer.

We hope you enjoy your Extensa computer. With proper care, your computer will provide you with years of productive service.

Connecting the Computer

Connecting the computer is as easy as 1-2-3.

1. Insert the battery pack into the battery compartment, then slide the battery compartment cover in place.

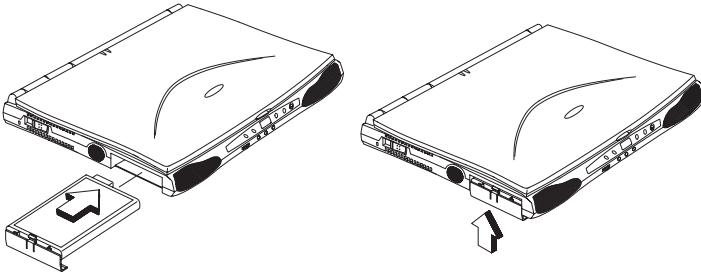

Note: When using a battery pack for the first time, fully recharge the battery, then disconnect the adapter to use up the battery before recharging again. Perform this action twice to condition the battery pack.

2. Connect one end of the AC adapter to the DC-in port on the computer's rear panel and the other end to a properly grounded power outlet.

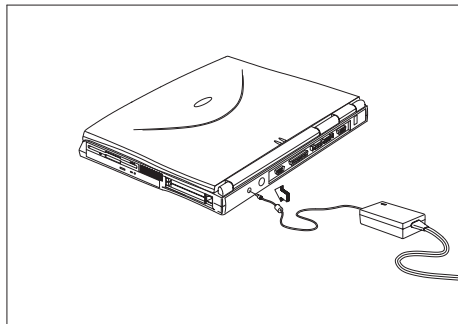

3. Slide the display cover latch to the left to open the display. Slide the power switch towards the rear of the computer then release it to turn on the power. The POST (Power On Self-Test) routine executes and Windows begins loading.

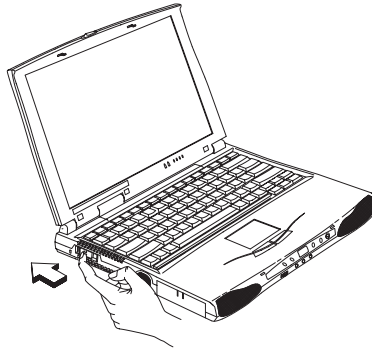

Note: To turn off the power, slide and hold the power switch for more than four seconds. If you are using Windows 98, we recommend that you use the Shutdown command to turn off the computer. If you turn off the computer and want to turn it on again, wait at least two seconds before powering up.

Preface

Getting Help Online

This user's guide provides clear and concise information about the computer, so read it thoroughly. To provide you with help when traveling, the computer also has a comprehensive online help.

Accessing Online Help

Follow these steps to access the online documentation:

1. Press the Windows logo button or click on the **Start** button.
2. Select **Programs**.
3. Click on **Extensa Online**.

The online help is easy to navigate with hypertext and hypergraphics. Clear illustrations help describe notebook operation as well.

Getting Online

If you are connected to the Internet and have World Wide Web access, visit our home page (<http://www.acer.com/>) and get the latest information about our products.

Support Information

Your computer is backed by an International Traveler's Warranty (ITW) that gives you security and peace of mind when traveling. Our worldwide network of service centers are there to give you a helping hand.

An ITW passport comes with your computer. This passport contains all you need to know about the ITW program. A list of available, authorized service centers are in this handy booklet. Read this passport thoroughly.



Note: Always have your ITW passport on hand, especially when you travel to receive the benefits from our support centers. Place your proof-of-purchase in the flap located inside the front cover of the ITW passport.

If the country you are traveling in does not have an Acer-authorized ITW service site, you can still get in contact with our offices worldwide.

For technical assistance and support in the United States and Canada, you can call 1-800-816-2237. You can also contact a local dealer or distributor in the country you are traveling in for assistance.

To view support information, follow these steps:

1. Click on **Start, Settings..., Control Panel**.
 2. Double-click on **System**.
 3. Click on **Support Information**.
-



Note: If you are connected to the Internet and have World Wide Web access, visit our home page (<http://www.acer.com/>) and get an updated list of our worldwide offices, as well as information about our products.

Care and Maintenance

Taking Care of Your Computer

Your computer will serve you well if you take care of it.

- Do not expose the computer to direct sunlight. Do not place near sources of heat, such as a radiator.
- Do not expose the computer to temperatures below 0°C (32°F) or above 50°C (122°F).
- Do not subject the computer to magnetic fields.
- Do not expose the computer to rain or moisture.
- Do not spill water or any liquid on the computer.
- Do not subject the computer to heavy shock and vibration.
- Do not expose the computer to dust and dirt.
- Never place objects on top of the computer to avoid damaging the computer.
- Never place the computer on uneven surfaces.

Taking Care of your AC Adapter

Here are some ways to take care of your AC adapter:

- Do not connect the adapter to any other device.
- Do not step on the power cord or place heavy objects on top of it. Carefully route the power cord and any cables away from personal traffic.
- When unplugging the power cord, do not pull on the cord itself but pull on the plug.

- The total ampere ratings of the equipment plugged in should not exceed the ampere rating of the cord if you are using an extension cord. Also, the total current rating of all equipment plugged into a single wall outlet should not exceed the fuse rating.

Taking Care of your Battery Pack

Here are some ways to take care of your battery pack:

- Use only batteries of the same kind as replacements. Turn the power off before removing or replacing batteries.
- Do not tamper with batteries. Keep them away from children.
- Dispose of used batteries according to local regulations. Recycle if at all possible.

Cleaning and Servicing

When cleaning the computer, follow these steps:

- 1.** Power off the computer and remove the battery pack.
- 2.** Disconnect the AC adapter.
- 3.** Use a soft cloth moistened with water. Do not use liquid or aerosol cleaners.

Contact your dealer or see your service technician if any of the following occurs:

- The computer has been dropped or the body has been damaged.
- Liquid has been spilled into the product.
- The computer does not operate normally.

Getting Familiar with your Computer

This computer combines high-performance, versatility, power management features and multimedia capabilities with a unique style and ergonomic design. Work with unmatched productivity and reliability with your new power computing partner.

This chapter gives an in-depth "tour" of the computer's many features.

Contents

Features	2
Display	4
Indicators	6
Keyboard	8
Special Keys	8
Lock Keys	8
Embedded Numeric Keypad	9
Windows 98 Keys	10
Hot Keys	11
Keyboard Ergonomics	13
Touchpad	14
Touchpad Basics	14
Storage	16
Hard Disk	16
Floppy Drive	16
CD-ROM Drive	17
Ports	18
Front Ports	18
Rear Ports	19
Universal Serial Bus	20
Right Ports	20
Fax/Data Modem	22
PC Card Slots	20
Audio	23
Securing your Computer	26
Security Notch	26
Passwords	26

Features

Features

This computer was designed with the user in mind. Here are just a few of its many features:

Performance

- Intel Pentium® processor with MMX™ technology
- 64-bit main memory and external (L2) cache memory
- Large LCD display and PCI local bus video with 128-bit graphics acceleration
- Internal CD-ROM drive
- Internal 3.5-inch floppy drive
- High-capacity, Enhanced-IDE hard disk
- Nickel metal-hydride battery pack
- Power management system with standby and hibernation power saving modes

Multimedia

- 16-bit high-fidelity stereo audio with 3-D sound and wavetable synthesizer
- Built-in dual speakers
- Compact disc player control feature
- Ultra-slim, high-speed CD-ROM drive

Connectivity

- High-speed fax/data modem port (available in select countries)
- USB (Universal Serial Bus) port

Human-centric Design and Ergonomics

- Lightweight and slim
- Sleek, smooth and stylish design
- Full-sized keyboard
- Wide and curved palm rest
- Ergonomically-centered touchpad pointing device
- Compact disc player control

Expansion

- CardBus PC card (formerly PCMCIA) slots (two type II/I or one type III) with ZV (Zoomed Video) port support
- Mini docking station option for one-step connect/disconnect from peripherals
- Upgradeable memory and hard disk

Display

Display

The large graphics display offers excellent viewing, display quality and desktop performance graphics. The computer supports two different display configurations — High Performance Addressing (HPA) or Thin-Film Transistor (TFT).

Video Performance

PCI local bus video with 128-bit graphics acceleration and 2MB Extended Data Out (EDO) video RAM boost video performance.

Simultaneous Display

The computer's large display and multimedia capabilities are great for giving presentations. If you prefer, you can also connect an external monitor when giving presentations. This computer supports simultaneous LCD and CRT display. Simultaneous display allows you to control the presentation from your computer and at the same time face your audience. You can also connect other output display devices such as LCD projection panels for large-audience presentations.

Power Management

The power management system incorporates an "automatic LCD dim" feature that automatically dims the LCD when the computer is powered by a battery pack to conserve battery power. See "Power Management" on page 36 for more information on power management features.

Opening and Closing the Display

To open the display, slide the display cover latch to the left and lift up the cover. Then tilt it to a comfortable viewing position. The computer employs a microswitch that turns off the display (and enters standby mode) to conserve power when you close the display cover, and turns it back on when you open the display cover.



Note: *If an external monitor is connected, the computer turns off the display (but does not enter standby mode) when you close the display cover.*

To close the display cover, fold it down gently until the display cover latch clicks into place.



Caution: *To avoid damaging the display, do not slam it when you close it. Also, do not place any object on top of the computer when the display is closed.*



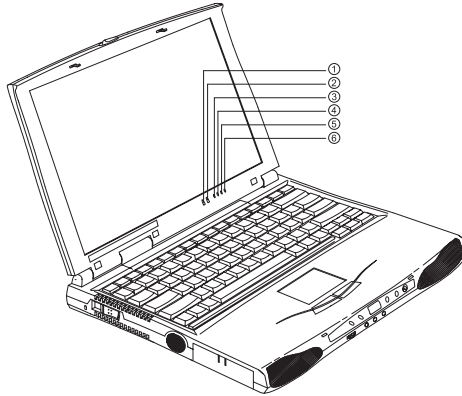

Indicators

Indicators



The computer has six easy-to-read status indicators (LEDs) under the display screen.



The Power and Standby indicators are visible even when you close the display cover so you can see the status of the computer while the cover is closed.

#	Icon	Function	Description
1		Power	Lights when the computer is on. Blinks when a battery-low condition occurs.
2		Standby	Lights when the computer enters Standby mode.
3		Media Activity	Lights when the floppy drive, hard disk or CD-ROM drive) is active.
4		Battery Charge	Lights when the battery is being charged.

Indicators

#	Icon	Function	Description
5		Caps Lock	Lights when Caps Lock is activated
6		Num Lock	Lights when Numeric Lock is activated

Keyboard

Keyboard

The keyboard has full-sized keys and an embedded keypad, separate cursor keys, two Windows 98 keys and twelve function keys.

Special Keys

Lock Keys

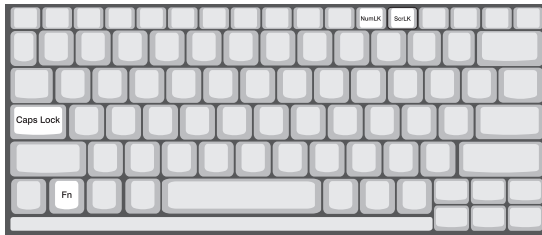

The keyboard has three lock keys which you can toggle on and off.

Lock Key	Description
Caps Lock	When Caps Lock is on, all alphabetic characters typed are in uppercase.
Num Lock (Fn-F11)	When Num Lock is on, the embedded keypad is in numeric mode. The keys function as a calculator (complete with the arithmetic operators +, -, *, and /). Use this mode when you need to do a lot of numeric data entry. A better solution would be to connect an external keypad.
Scroll Lock (Fn-F12)	When Scroll Lock is on, the screen moves one line up or down when you press ↑ or ↓ respectively. Scroll Lock does not work with some applications.

Embedded Numeric Keypad



The embedded numeric keypad functions like a desktop numeric keypad. It is indicated by small characters located on the upper right corner of the keycaps. To simplify the keyboard legend, cursor-control key symbols are not printed on the keys.

Desired Access	Num Lock On	Num Lock Off
Number keys on embedded keypad	Type numbers in a normal manner.	
Cursor-control keys on embedded keypad	Hold Shift while using cursor-control keys.	Hold Fn while using cursor-control keys.
Main keyboard keys	Hold Fn while typing letters on embedded keypad.	Type the letters in a normal manner.



Note: If an external keyboard or keypad is connected to the computer, the numlock feature automatically shifts from the internal keyboard to the external keyboard or keypad.

Keyboard

Windows 98 Keys



The keyboard has two keys that perform Windows 98-specific functions.

Key	Description
Windows logo key	Start button. Combinations with this key performs special functions. Below are a few examples: <ul style="list-style-type: none">⊞ + Tab (Activate next Taskbar button)⊞ + E (Explore My Computer)⊞ + F (Find Document)⊞ + M (Minimize All)Shift + ⊞ + M (Undo Minimize All)⊞ + R (Display Run dialog box)
Application key	Opens the application's context menu (same as right-click).



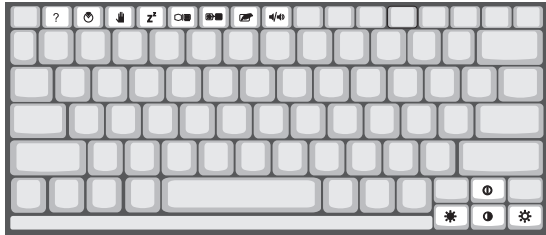



Hot Keys





The computer employs hot keys or key combinations to access most of the computer's controls like screen contrast and brightness, volume output and the BIOS setup utility.

Hot Key	Icon	Function	Description
Fn-F1	?	Hot key help	Displays a list of the hotkeys and their functions.
Fn-F2		Setup	Accesses the notebook configuration utility. See "Notebook Manager" on page 74.
Fn-F3		Standby	Puts the computer in Standby mode. Press any key to return. See "Standby Mode" on page 37 to learn more about Standby mode.

Keyboard

Hot Key	Icon	Function	Description
Fn-F4		Hibernation	<p>Puts the computer in Hibernation mode (if Sleep Manager, the hibernation utility, is installed, valid and enabled). Press the power switch to resume.</p> <p>Otherwise, the computer issues a warning beep and continues operation. See "Hibernation Mode" on page 38 for more about Hibernation mode.</p>
Fn-F5		Display toggle	Switches display output between the display screen, external monitor (if connected) and both the display screen and external monitor.
Fn-F6		Screen blank	Turns the display screen backlight off to save power. Press any key to return.
Fn-F7		Touchpad on/off	<p>Turns the internal touchpad on and off.</p> <p>When you connect an external PS/2 mouse, the computer automatically disables the touchpad.</p>
Fn-F8		Speaker on/off	Turns the speakers on and off; mutes the sound.
Fn-↑		Contrast up	Increases the screen contrast (available only for models with HPA displays).

Keyboard

Hot Key	Icon	Function	Description
Fn-↓		Contrast down	Decreases the screen contrast (available only for models with HPA displays).
Fn-→		Brightness up	Increases the screen brightness.
Fn-←		Brightness down	Decreases the screen brightness.

Activating Hot Keys

When activating hot keys, press and hold the first key **Fn** before pressing the other key in the hot key combination.

Keyboard Ergonomics

Located below the keyboard, the wide and curved palm rest is ergonomically designed to provide you with a very comfortable place to rest your hands while you type.

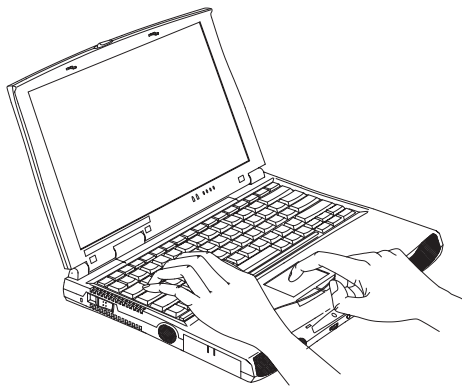

Touchpad

Touchpad

The built-in touchpad is a PS/2-compatible pointing device that senses movement on its surface. This means the cursor responds as you move your finger on the surface of the touchpad. The central location on the palm rest provides optimum comfort and support.

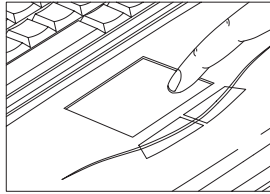

Note: When you connect an external PS/2 mouse, the computer automatically disables the internal touchpad.

Touchpad Basics

The following items teach you how to use the touchpad:

- Move your finger across the touchpad to move the cursor.
- Press the left and right buttons located on the edge of the touchpad to do selection and execution functions. These two buttons are similar to the left and right buttons on a mouse. Tapping on the touchpad produces similar results.

Touchpad

Function	Left Button	Right Button	Tap
Executes	Click twice quickly		Tap twice (at the same speed as double-clicking the mouse button)
Selects	Click once		Tap once
Drags	Click and hold, then use finger to drag the cursor on the touchpad		Tap twice (at the same speed as double-clicking the mouse button) and hold finger to the touchpad on the second tap to drag the cursor
Accesses context menu		Click once	



Note: Keep your fingers dry and clean when using the touchpad. Also keep the touchpad dry and clean. The touchpad is sensitive to finger movements. Hence, the lighter the touch, the better the response. Tapping too hard will not increase the touchpad's responsiveness.

Storage

Storage

This computer supplies you with all-in-one media storage:

- High-capacity Enhanced-IDE hard disk
- Standard ultra-slim internal 3.5-inch floppy drive
- High-speed ultra-slim CD-ROM drive

Hard Disk

The hard disk can be upgraded when you need more storage space. Consult your dealer for details.

Floppy Drive

The ultra-slim internal floppy drive reads and writes on standard 3.5-inch diskettes.

Ejecting a Floppy Disk

Press the floppy disk eject button to eject a floppy disk from the floppy drive.

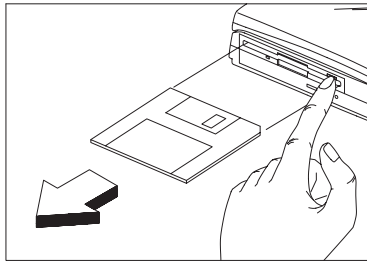

CD-ROM Drive

A high-speed CD-ROM drive gives you portable multimedia access.

Ejecting the CD-ROM Tray

To eject the CD-ROM drive tray when the computer is turned on, press the CD-ROM eject button.

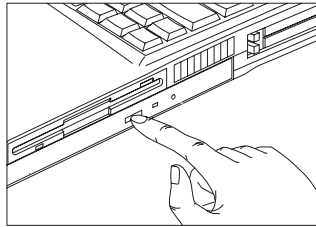

Note: When power is off, you can eject the CD-ROM drive tray using the emergency eject hole (see page 98). You can also eject the CD-ROM drive tray when using the compact disc player control feature (see page 24).

Ports

Ports

Ports allow you to connect peripheral devices to your computer as you would with a desktop PC.



Note: See Chapter 3 on how to connect external devices to the computer.

Front Ports



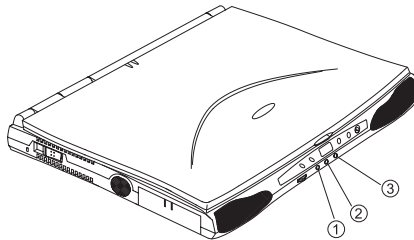



The front panel contains ports for external audio connections.

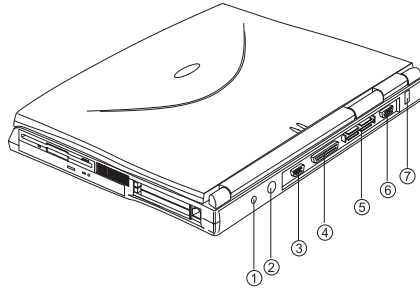

#	Icon	Port	Connects to...
1		Speaker-out jack	Speakers or headphones
2		Audio line-in jack	Audio line-in device with a 3.5mm minijack (e.g., audio CD player, stereo walkman)
3		Microphone-in jack	3.5mm minijack condenser microphone

Rear Ports



#	Icon	Port	Connects to...
1		DC-in jack	AC adapter and power outlet
2		PS/2 port	PS/2-compatible device (e.g., PS/2 keyboard/mouse/keypad)
3		Serial port	Serial device (e.g., serial mouse)
4		Parallel port	Parallel device (e.g., parallel printer)
5		Port replicator connector	Port replicator
6		External monitor port	Display monitor (up to 1024x768 resolution, 64K-colors)
7		USB port	USB device (e.g., USB mouse)



Ports

Universal Serial Bus

The Universal Serial Bus (USB) port is a high-speed serial bus which allows you to connect and daisy-chain USB peripherals without taking up precious system resources.

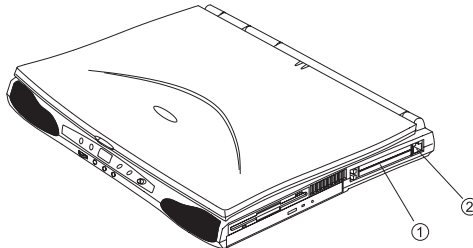
Right Ports



#	Icon	Port	Connects to...
1		PC Card slots	16-bit PC Cards and 32-bit CardBus PC Cards (ZV-support)
2		Modem jack	Phone line (only for models with an internal fax modem)

PC Card Slots

There are two type II/I or one type III CardBus PC Card slots found on the right panel of the computer. These slots accept credit-card-sized cards that enhance the usability and expandability of the computer.

PC Cards (formerly PCMCIA) are add-on cards for portable computers, giving you expansion possibilities long afforded by desktop PCs. Popular type II cards include flash memory, SRAM, fax/data modem, LAN and SCSI cards. Common type III cards are 1.8-inch ATA drives and cellular modems. CardBus improves on the 16-bit PC card technology by expanding the data path to 32 bits.

ZV (Zoomed Video) port support allows your computer to support hardware MPEG in the form of a ZV PC card.



Note: Refer to your card's manual for details on how to install and use the card and its functions.

Inserting a Card

Insert the card into the desired slot and make the proper connections (e.g., network cable), if necessary. See your card manual for details.

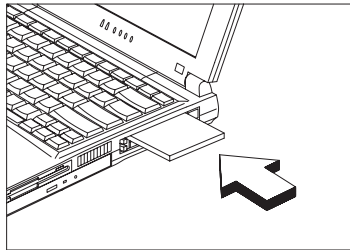

For type III cards, insert the card into the lower slot. For ZV cards, insert the card into the upper slot.

Ejecting a Card

Before ejecting a PC card:

- Exit the application using the card.
- Left-click on the PC card icon on the taskbar and stop the card operation.

Ports

Press the slot eject button once to pop it out; then press again to eject the PC Card.

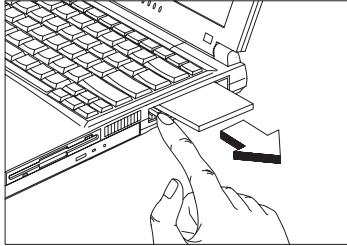

Fax/Data Modem

The computer has a built-in fax/data modem (available in select countries).



Caution: This modem port is not compatible with digital phone lines. Plugging this modem into a digital phone line will damage the modem.

To use the fax/data modem port, connect a phone cable from the modem port to a telephone jack.

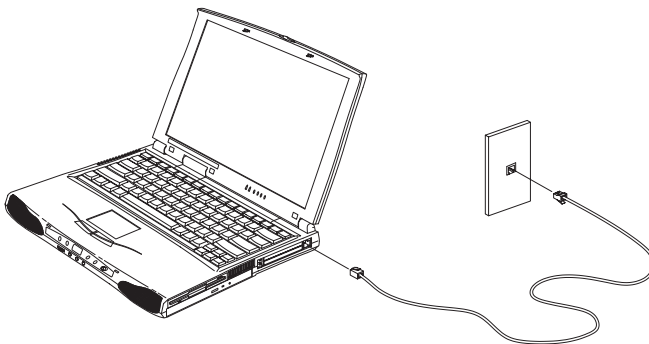

Start your communications software program. See your communications manual for instructions.

Audio

The standard computer configuration includes 16-bit high-fidelity stereo audio with further enhancements that include 3D sound for true audio immersion. Front dual speakers direct sound towards you to further enhance sound output. A sensitive microphone is located above the display screen.

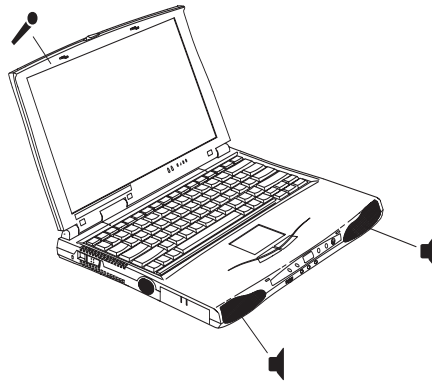

Besides the built-in speakers, there are audio ports on the front panel of the computer. See “Audio Devices” on page 48 for more information on connecting external audio devices.

Audio

Playing Audio CDs

This computer allows you to play audio (music) compact discs without turning on the computer. Front panel controls provide smooth and easy operation.

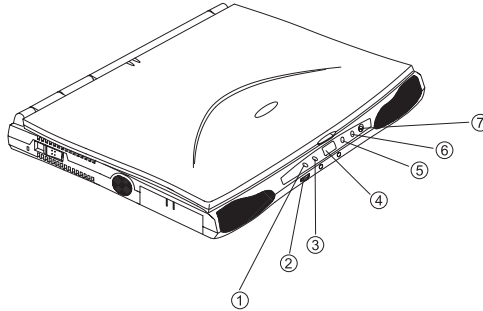

#	Function	Description
1	Previous Track	Jumps to the previous track in the audio CD
2	Volume Control	Adjusts the volume level
3	Next Track	Jumps to the next track in the audio CD
4	Status LCD	Displays the current track number; displays "--" if no audio CD is in the CD-ROM drive
5	Play/Pause	Plays/pauses the audio CD
6	Stop/Eject	Stops playing the audio CD. When CD playback is stopped, press again to eject the CD-ROM drive tray.
7	Power	Turns the audio CD player on and off (works only when the computer is off).

To play audio CDs without turning on the computer, follow these steps:

- 1.** Slide the power switch and release it to turn on the audio CD player. The status LCD turns on.
- 2.** Press the CD eject button to eject the CD-ROM drive tray.
- 3.** Firmly place an audio compact disc on the CD-ROM drive tray spindle until you hear it click in place.
- 4.** Close the CD-ROM drive tray.
- 5.** Use the front panel buttons to play the CD.
- 6.** Use the volume control knob to adjust the volume level. Turn the knob to the right to increase the volume; turn it to the left to decrease the volume.

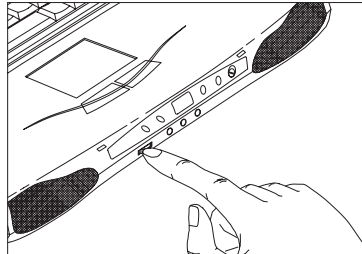

Securing your Computer

Securing your Computer

Security features include hardware and software locks — a security notch and a two-level password scheme.

Security Notch

A security notch located on the rear panel of the computer lets you connect a Kensington-compatible key-based computer security lock.

Wrap a computer security lock cable around an immovable object such as a table or locked drawer handle. Insert the lock into the notch and turn the key to secure the lock.

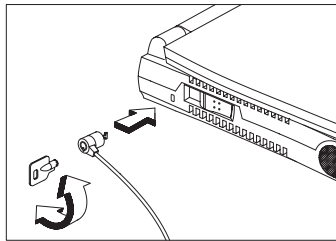

Passwords

A two-level password scheme protects your computer from unauthorized access. When set, no one can access the computer without entering the correct password.

There are two types of passwords you can set:

- Setup Password secures your computer against unauthorized entry to and use of the BIOS Utility.
- Power-On Password secures your computer against unauthorized use.

Securing your Computer

See “BIOS Utility” on page 84 for details.



Important: Do not forget your password! If you forget your password, you need to contact your dealer.

Setting a Password

You can set the password using:

- Notebook Manager -- go to page 78.
- BIOS Utility -- go to page 91.

Operating on Battery Power

The computer operates on AC or battery power. This chapter contains the information you need to know to operate the computer on battery power. It also includes information on how your computer manages and saves power.

Contents

Battery Pack	30
Battery Pack Characteristics	30
Installing and Removing the Battery Pack	31
Charging the Battery	32
Charging Modes	32
Checking the Battery Level	33
Using the Windows Battery Meter	33
Optimizing Battery Life	33
Battery-low Warning	34
Power Management	36
Power Management Modes	36
Display Standby Mode	36
Hard Disk Standby Mode	37
Peripheral Standby Modes	37
Standby Mode	37
Hibernation Mode	38
Advanced Power Management	40

Battery Pack

Battery Pack

The computer uses a battery pack that gives you long use between charges.

Battery Pack Characteristics

The battery pack has the following characteristics:

Employs Current Battery Technology Standards

The computer uses a Nickel-Metal Hydride battery pack which does not have the memory effect problem of Nickel Cadmium (NiCd) batteries.

Battery-low Warning

When the battery charge level becomes low, the computer gives off warning beeps and the status indicator flashes at regular intervals. This tells you that the battery power is critically low (and you should save your work). You can correct this situation by recharging the battery pack.

Whenever possible, use the AC adapter. The battery will come in handy when you travel or during a power failure. It is advisable to have an extra fully-charged battery pack available as backup.

Using a Battery Pack for the First Time

When using a battery pack for the first time, follow these steps:

- 1.** Disable the Battery Low Suspend parameter in Setup or uncheck the Enable sleep upon battery low in the Power Management screen of Notebook Manager. See page 93 and page 78 respectively.
- 2.** Connect the AC adapter to a power source and to the computer and fully recharge the battery

Battery Pack

3. Disconnect the adapter to use up the battery before recharging again.

You only need to do this once or twice with a new battery or with a battery that's been stored without being used for a long time. If the computer is to be stored for more than two weeks, we suggest you remove the battery pack. Battery power from a fully charged battery pack depletes in roughly a day with the computer in Standby mode, a month in Hibernation mode or when power is off.



Warning! Do not expose battery packs to temperatures below 0°C (32°F) or above 60°C (140°F). This may adversely affect the battery pack.

Installing and Removing the Battery Pack



Important! Before removing the battery pack, make sure that you have an AC adapter connected to the computer; otherwise turn off the computer.

To install a battery pack, slide it into the battery compartment, then latch the battery compartment cover.

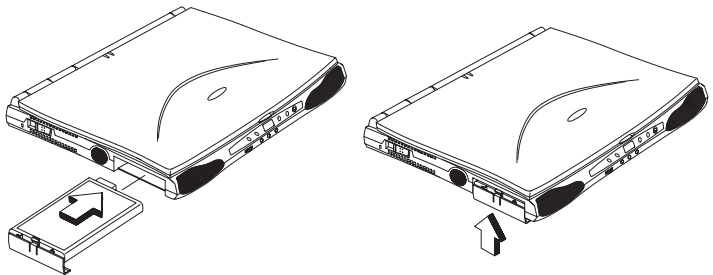

Reverse the steps to remove the battery pack.

Battery Pack

Charging the Battery

To charge the battery, place the battery pack inside the battery bay and plug the AC adapter into the computer and an electrical outlet.

Charging Modes

The adapter has three charging modes:

Rapid mode

The computer uses rapid charging when power is turned off and a powered AC adapter is connected to it. In rapid mode, a fully depleted battery gets fully charged in approximately two hours.

Charge-in-use mode

When the computer is in use with the AC adapter plugged in, the computer also charges the battery pack if installed. This mode will take longer to fully charge a battery than rapid mode. In charge-in-use mode, a fully depleted battery gets fully charged in approximately three to four hours.

Trickle mode

When the battery is fully charged, the adapter changes to trickle mode to maintain the battery charge level. This prevents the battery from draining while the computer is in use.



Note: We suggest that you charge the battery pack before retiring for the day, letting it charge overnight before traveling. This ensures a fully charged battery for use the next day.

Checking the Battery Level

The computer features battery-low warning signals that are both audible and visible. When the battery pack is low, the computer emits warning beeps and the battery indicator flashes at regular intervals. Also, you can check the battery charge level using the Windows battery gauge.

Using the Windows Battery Meter

The Windows battery meter indicates the present battery level. Simply rest your cursor on the battery gauge (or AC plug) icon on the taskbar to see the present charge level of your battery.

Optimizing Battery Life

This section helps you get the most out of battery operation. Optimizing battery life prolongs the charge/recharge cycle and improves recharge efficiency. Follow these suggestions to optimize and maximize battery power:

- Purchase an extra battery pack.
- Use Sleep Manager to reserve hard disk space for the Hibernation function. See "Sleep Manager" on page 67.
- Use the AC adapter whenever possible so that the battery is reserved for on-the-go computing.
- Keep the battery pack in the computer powered by the AC adapter. The constant trickle charge maintains the battery level to eliminate the battery self-discharge effect. The charge-in-use function also charges the battery pack.
- Disable the parallel and serial ports if no devices are connected to these ports. You can do this through the Setup Utility. See "Startup Configuration" on page 87.
- Eject the PC card from the card slot when not in use, since the PC card draws extra power.

Battery Pack

- ❑ Store the battery pack in a cool, dry place. The recommended storage temperature for battery packs ranges from 10 to 30 degrees C. The higher the storage temperature, the faster the battery pack self-discharges.
- ❑ The batteries can be recharged about 300 times when used as directed. Excessive recharging decreases battery life.
- ❑ Take care of your battery pack and AC adapter. See “Care and Maintenance” on page xviii of the preface.

Battery-low Warning

You never have to worry about battery power as long as you are using the AC adapter. However, when you operate the computer on battery power, pay extra attention to the warning beeps and the power indicator on the display panel.

The following signals indicate a battery-low condition:

- ❑ The buzzer generates four short beeps every minute, if you enabled the Battery-low Warning Beep parameter in Setup.
- ❑ The power indicator flashes at regular intervals until battery power is depleted.

When you receive a battery-low warning, you have around two minutes to save your work. If you do not connect the AC adapter within this period, the computer automatically enters Hibernation mode if the Battery Low Suspend parameter in Setup is enabled and the following conditions exist:

- ❑ The Hibernation file created by Sleep Manager is present and valid. See “Sleep Manager” on page 67.
- ❑ There is enough battery power left to save system information onto the hard disk.

Battery Pack

Otherwise, the computer enters Standby mode.



Warning: Connect the AC adapter to the computer as soon as possible. Data is lost when computer power is cut off during Standby mode.

The following table shows the recommended course of action to take when you encounter a battery-low condition.

Situation	Recommended Action
AC adapter and power outlet available	<ol style="list-style-type: none">1. Connect the AC adapter to the computer.2. Save all necessary files.3. Resume work. Power off the computer if you wish to recharge the battery rapidly.
An extra fully-charged battery pack available	<ol style="list-style-type: none">1. Save all necessary files.2. Exit the application.3. Power off the computer.4. Replace the battery pack.5. Power on the computer and resume work. or <ol style="list-style-type: none">1. Save all necessary files.2. Enter Hibernation mode (press Fn-F4).3. Install the extra battery pack.4. Resume from Hibernation mode.
AC adapter or power outlet not available	<ol style="list-style-type: none">1. Save all necessary files.2. Exit the application.3. Power off the computer. or <ol style="list-style-type: none">1. Save all necessary files.2. Enter Hibernation mode (press Fn-F4).

Power Management

Power Management

This computer has a built-in power management unit that monitors system activity. System activity refers to any activity involving one or more of the following devices: keyboard, mouse, floppy drive, hard disk, peripherals connected to the serial and parallel ports, and video memory. If no activity is detected for a period of time (called an inactivity time-out), the computer stops some or all of these devices in order to conserve energy.

Power management methods used by most computers are timer-based. You set inactivity time-out values for the display, hard disk, and other devices. The computer then "sleeps" when these time-outs elapse. The problem with this is that no two users are alike. Each of us has his or her own habits when using the computer, which makes timer-based power management ineffective.

This computer manages its power according to the way you use your computer. This means the computer delivers maximum power when you need it, and saves power when you don't need the maximum — all without your intervention. There are no timers to set, because the power management system figures out everything for you.



Note: We recommend you enable power management to prolong your battery life.

Power Management Modes

Display Standby Mode

Screen activity is determined by the keyboard, the built-in touchpad, and an external PS/2 pointing device. If these devices are idle for the period determined by the computer's power management system, the display shuts off until you press a key or move the touchpad or external mouse.

Power Management

"Automatic Dim" Feature

The computer has a unique "automatic dim" power-saving feature. When the computer is using AC power and you disconnect the AC adapter from the computer, it automatically dims the LCD backlight to save power. If you reconnect AC power to the computer, it automatically adjusts the LCD backlight to a brighter level.

Hard Disk Standby Mode

The hard disk enters standby mode when there are no disk read/write operations within the period of time determined by the power management system. In this state, the power supplied to the hard disk is reduced to a minimum. The hard disk returns to normal once the computer accesses it.

Peripheral Standby Modes

The peripheral connections in your computer also power down to save power if there is no activity within the period of time specified by the computer's power management system for these devices. These include audio, serial ports, floppy drive and parallel port.

Standby Mode

The computer consumes very low power in Standby mode. Data remain intact in the system memory until the battery is drained.

There is one necessary condition for the computer to enter Standby mode:

- Heuristic Power Management Mode must be set to [ENABLED].

There are four ways to enter Standby mode:

- Pressing the Standby hot key **Fn-F3**
- If the waiting time determined by the computer's power

Power Management

management system elapses without any system activity

- Closing the display cover
- When the computer is about to enter Hibernation mode (e.g., during a battery low condition), but the Hibernation file is invalid or not present



Note: *If the computer does not enter Standby mode after pressing the Standby hot key, it means the operating system will not allow the computer to enter the power-saving mode.*

The following signals indicate that the computer is in Standby mode:

- The Standby indicator lights



Warning: *Unstored data is lost when you turn off the computer power in Standby mode or when the battery is drained.*

To leave Standby mode and return to normal mode:

- Press any key
- Move the active pointing device (internal or external, PS/2 or serial)
- Have the Resume Timer set and let it be matched
- Open the display cover
- Experience an incoming PC card modem event

Hibernation Mode

In Hibernation mode, all power shuts off (the computer does not consume any power). The computer saves all system information onto the hard disk before it enters Hibernation mode. Once you turn on the power, the computer restores this information and resumes where you left off upon leaving Hibernation mode.

Power Management

There are two necessary conditions for the computer to enter Hibernation mode:

- ❑ The Hibernation file created by Sleep Manager must be present and valid. See “Sleep Manager” on page 67.
- ❑ Heuristic Power Management Mode must be set to [ENABLED].

In this situation, there are four ways to enter Hibernation mode:

- ❑ Pressing the Hibernation hot key **Fn-F4**
- ❑ If the waiting time determined by the computer's power management system elapses without any system activity
- ❑ If a battery low condition occurs and the Battery Low Suspend parameter in Setup is set to [ENABLED].
- ❑ Invoked by the operating system power saving modes



Note: *If the computer beeps but does not enter Hibernation mode after pressing the Hibernation hot key, it means the operating system will not allow the computer to enter the power-saving mode.*

To exit Hibernation mode, press the power switch. The computer also resumes from Hibernation mode if the resume timer is set and matched.



Warning: *Do not change any devices (such as add memory) when the computer is in Hibernation mode.*

Power Management

Advanced Power Management

This computer supports the Windows APM standard designed to further reduce power consumption. APM is a power-management approach defined jointly by Microsoft and Intel. An increasing number of software packages support APM to take advantage of its power-saving features and allows greater system availability without degrading performance.

For more information about APM under Windows, refer to your Windows user's manual.

Peripherals and Options

Your computer offers excellent expansion capabilities with its built-in ports and connectors. This chapter describes how to connect peripherals and hardware options that help you use your computer with ease. When connecting peripherals, read the manual included with the peripheral for operating instructions. You can purchase most of these and other options directly from Acer.

This chapter also includes sections on how to upgrade key components. Key component upgradeability helps keep your computer in step with the latest technology.

Contents

External Monitor	42
External Keyboard	43
External Keypad	44
External Pointing Device	45
External PS/2 Mouse	45
External Serial Mouse	46
Printer	47
Audio Devices	48
Port Replicator	49
PC Cards	50
USB Devices	51
Miscellaneous Options	52
Additional Power Packs	52
Battery Pack	52
AC Adapter	52
Cables	52
PS/2 Y-Bridge Cable	52
File Transfer Cable	53
Key Component Upgrades	54
Memory Upgrade	54
Memory Configurations	54
Installing Memory	55
Hard Disk Upgrade	56

External Monitor

External Monitor

To show graphical effects on a larger display, connect an external monitor to the CRT port. Read the monitor manual for additional instructions.

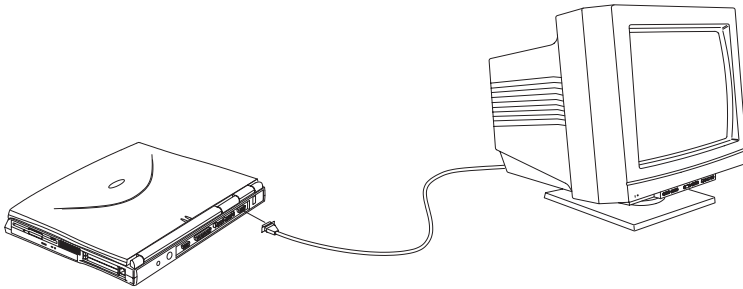

Note: If an external monitor is not connected, closing the display cover puts the computer into standby mode.

External Keyboard

This computer has a keyboard with full-sized keys and an embedded keypad. If you feel more comfortable using a desktop keyboard, you can install a PS/2-compatible external keyboard.

To connect an external keyboard, plug the external keyboard into the PS/2 connector.

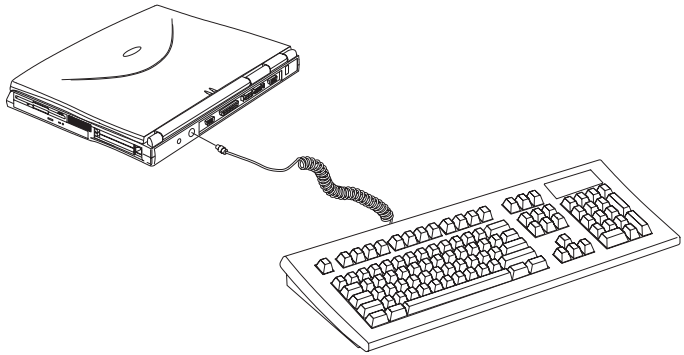

External Keypad

External Keypad

You can also use a 17-key numeric keypad for number-sensitive data entry applications. To connect the keypad, plug the keypad connector into the PS/2 port.

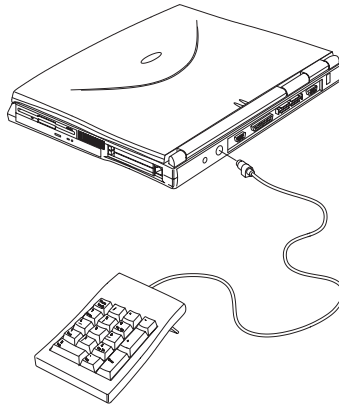

External Pointing Device

External Pointing Device

This computer accepts either a PS/2-compatible or serial mouse or similar pointing device.



Note: When using an external mouse, you may choose to disable the internal touchpad by pressing Fn-F7.

External PS/2 Mouse

The built-in touchpad works alternately with an external PS/2 mouse which is hot-pluggable. To use a PS/2-compatible mouse, simply plug it into the PS/2 port.

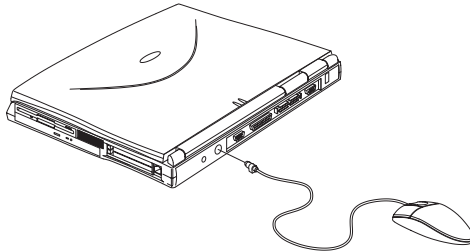

External Pointing Device

External Serial Mouse

If you use a serial mouse, plug it into the serial port.

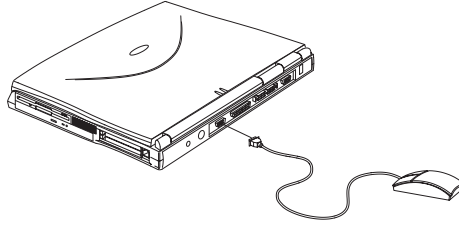

To enable the serial mouse, use the Add New Hardware tool in the Windows 95 or Windows 98 Control Panel.

Printer

This computer supports both serial and parallel printers. For a serial printer, plug the printer cable into the serial port. For a parallel printer, plug the printer cable into the parallel port. See your printer manual for operating instructions.

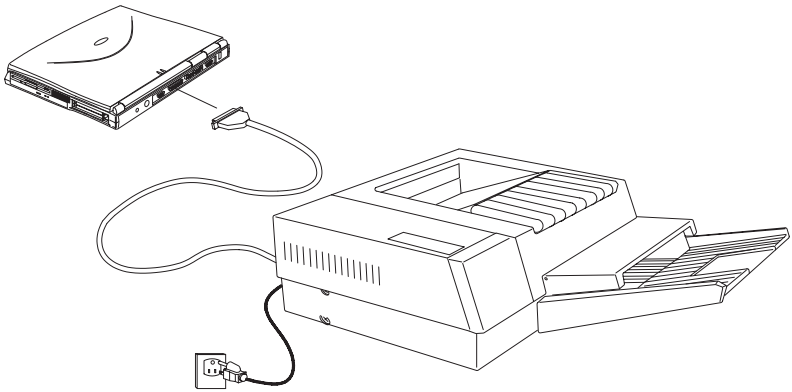

Note: If the printer does not function, enter Setup and verify that the parallel port is enabled. See "Startup Configuration" on page 87 for assistance.

Audio Devices

Audio Devices

Audio devices are easy to connect with the audio ports accessible from the front of the computer. You can plug in an external microphone to the microphone-in jack, or audio line-in device to the audio line-in jack. Amplified speakers or headphones connect to the speaker/headphone-out jack.

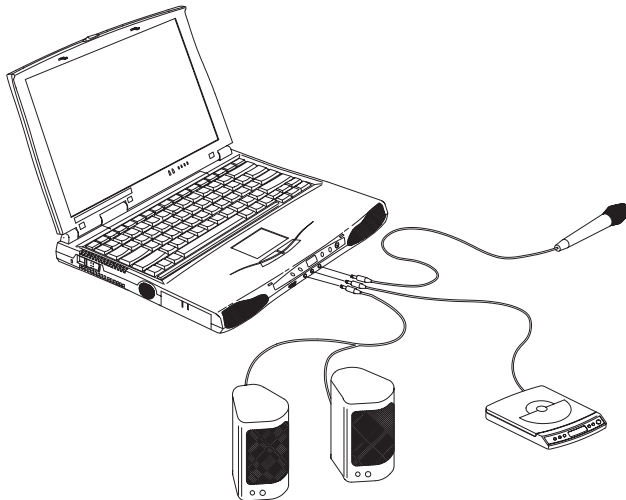

Port Replicator

For one-step connection and disconnection from your peripherals, use the optional full-featured port replicator. This port replicator includes all the ports on your computer and adds a few more.

With the port replicator, you can easily use external devices such as an external monitor, a printer, a keyboard, a mouse with your computer without connecting and disconnecting these devices to your computer. You only need to connect these devices to the port replicator, then “dock” your computer to the port replicator to make use of these devices.

Refer to the easy-to-use quick reference and installation guide that comes with the port replicator option.

PC Cards

PC Cards

The computer has two CardBus PC card slots that accommodate two type I/II or one type III PC card(s). Please consult your dealer for PC card options available that you can purchase for your computer.

USB Devices

The computer has a USB (Universal Serial Bus) port that allows you to connect peripherals without occupying too many resources. Common USB devices include the mouse and keyboard.

Most USB devices also include a built-in USB port connector which allows you to daisy-chain other USB devices.

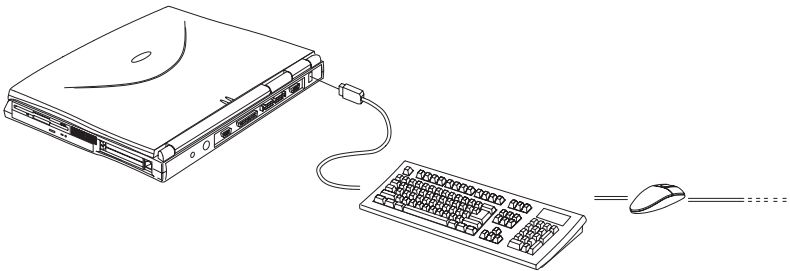

Miscellaneous Options

Miscellaneous Options

Additional Power Packs

You can order spare batteries and an AC adapter.

Battery Pack

It is good practice to have a spare battery around, especially when you travel. The NiMH battery, coupled with heuristic power management features, supplies you with more power on-the-go.

AC Adapter

The compact AC adapter charges your battery pack and supplies power to your computer. You can order a spare AC adapter so you do not need to carry it from the office to your home or destination.

Cables

PS/2 Y-Bridge Cable

The PS/2 Y-bridge cable allows you to connect two PS/2 devices, mouse and keyboard, to your computer simultaneously.



Note: *The keyboard must be connected to the connector marked keyboard and the mouse must be connected to the connector marked mouse.*

Miscellaneous Options

Connect the single connector end of the Y-bridge cable to the computer's PS/2 port and the double connector ends to the two PS/2 devices.

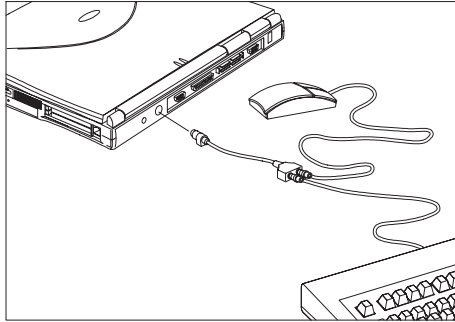

File Transfer Cable

Besides using the infrared port, you can also transfer files between computers using a file transfer cable. Connect the file transfer cable between the parallel ports of the two computers and use your file transfer utility to perform the transfer.

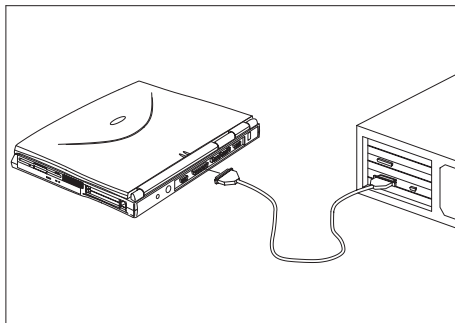

Key Component Upgrades

Key Component Upgrades

Your computer delivers superior power and performance. However, some users and the applications they use may demand more. This computer allows you to upgrade key components when you need increased performance.



Note: Contact your authorized dealer if you decide to perform a key component upgrade.

Memory Upgrade

Memory is upgradeable from 16 to 128 MB, employing 16-/32-/64-MB 64-bit soDIMMs (Small Outline Dual Inline Memory Modules).

Memory Configurations

The following table lists the possible memory configurations:



Important! DIMMs in both slots should be of the same type. Do not mix different DIMM types, EDO and SDRAM, together.

Slot 1	Slot 2	Total Memory
0 MB	16 MB	16 MB
0 MB	32 MB	32 MB
0 MB	64 MB	64 MB
16 MB	0 MB	16 MB
16 MB	16 MB	32 MB
16 MB	32 MB	48 MB

Key Component Upgrades

Slot 1	Slot 2	Total Memory
16 MB	64 MB	80 MB
32 MB	0 MB	32 MB
32 MB	16 MB	48 MB
32 MB	32 MB	64 MB
32 MB	64 MB	96 MB
64 MB	0 MB	64 MB
64 MB	16 MB	80 MB
64 MB	32 MB	96 MB
64 MB	64 MB	128 MB

Installing Memory

Follow these steps to install memory:

1. Turn off the computer, unplug the AC adapter (if connected) and remove the battery pack. Then turn the computer over to access its base.
2. Remove the screws from the memory door; then lift up and remove the memory door.
3. Insert the memory module diagonally into the slot, then gently press down until it clicks into place.

Key Component Upgrades

4. Replace the memory door and secure it with the screw.

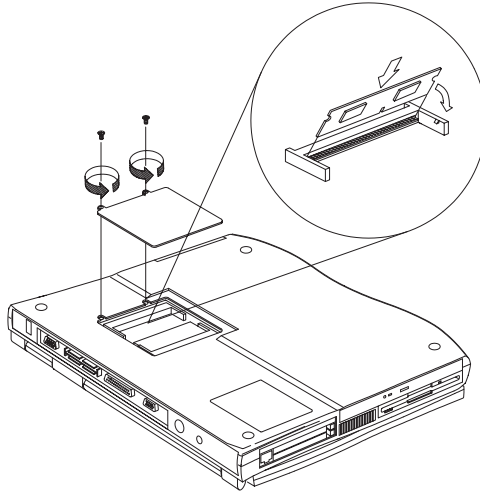

The computer automatically detects and reconfigures the total memory size.

Hard Disk Upgrade

You can upgrade your hard disk with a higher capacity drive when you need more storage space. The computer uses a 12.7mm or 9.5mm 2.5-inch Enhanced-IDE hard disk. Please consult your dealer if you need to upgrade your hard disk.

Moving with your Computer

This chapter gives you tips and hints on things to consider when moving around or traveling with your computer.

Contents

Disconnecting from the Desktop	58
Moving Around	59
Preparing the Computer	59
What To Bring to Short Meetings	59
What To Bring to Long Meetings	59
Taking the Computer Home	60
Preparing the Computer	60
What To Bring with You	60
Special Considerations	60
Setting Up a Home Office	61
Traveling with the Computer	62
Preparing the Computer	62
What To Bring with You	62
Special Considerations	62
Traveling Internationally with the Computer	63
Preparing the Computer	63
What To Bring with You	63
Special Considerations	63

Disconnecting from the Desktop

Disconnecting from the Desktop

Follow these steps to disconnect your computer from external accessories:

1. Save your work in progress.
2. Shut down the operating system.
3. Turn off the computer.
4. Disconnect the cord from the AC adapter.
5. Disconnect the keyboard, pointing device, printer, external monitor, and other external devices.

If your external devices are connected to the optional port replicator, disconnect the notebook from the port replicator. You do not need to disconnect the external devices from the port replicator.

6. Disconnect the Kensington lock if you are using one to secure the computer.

Moving Around

when you are just moving within short distances, for example, from your office desk to a meeting room

Preparing the Computer

Before moving the computer, close and latch the display cover to place it in standby mode. You can now safely take the computer anywhere you go within the building.

To bring the computer out of standby mode, open the display.

What To Bring to Short Meetings

A fully charged battery runs the computer for 2-3 hours under most circumstances. If your meeting is shorter than that, you probably do not need to bring anything with you other than the computer.

What To Bring to Long Meetings

If your meeting will last longer than 3 hours or if your battery is not fully charged, you may want to bring the AC adapter with you to plug in your computer in the meeting room.

If the meeting room does not have an electrical outlet, reduce the drain on the battery by putting the computer in standby mode. Press Fn-F3 or close the display cover whenever you are not actively using the computer. Then tap any key or open the display to resume.

Taking the Computer Home

Taking the Computer Home

when you are moving from your office to your home or vice versa

Preparing the Computer

After disconnecting the computer from your desktop, follow these steps to prepare the computer for the trip home:

1. Remove all media from the drives. Failure to remove the media can damage the drive head.
2. Pack the computer in a protective case that can prevent the computer from sliding around and cushion it if it should fall.



Caution: Avoid packing items next to the top cover of the computer. Pressure against the top cover can damage the screen

What To Bring with You

Unless you already have some items at home, bring the following items with you:

- AC adapter and power cord
- The printed user's manual

Special Considerations

Follow these guidelines to protect your computer while traveling to and from work:

- Minimize the effect of temperature changes by keeping the computer with you.

Taking the Computer Home

- ❑ If you need to stop for an extended period of time and cannot bring the computer with you, leave the computer in the trunk of the car to avoid exposing the computer to excessive heat.
- ❑ Changes in temperature and humidity can cause condensation. Allow the computer to return to room temperature, and inspect the screen for condensation before turning on the computer. If the temperature change is greater than 18°F (10°C), allow the computer to come to room temperature slowly. If possible, leave the computer for 30 minutes in an environment with a temperature between outside and room temperature.

Setting Up a Home Office

If you frequently work on your computer at home, it may be worthwhile purchasing a second AC adapter for use at home. With a second AC adapter, you can avoid transporting the extra weight to and from home.

If you use your computer at home for significant periods of time, you might also want to add an external keyboard, monitor, or mouse.

Traveling with the Computer

Traveling with the Computer

when you are moving within a larger distance, for instance, from your office building to a client's office building or traveling locally

Preparing the Computer

Prepare the computer as if you were taking it home. Be sure the battery in the computer is charged. Airport security may require you to turn on your computer when bringing it into the gate area.

What To Bring with You

Bring the following items with you:

- AC adapter
- Spare, fully-charged battery packs
- Additional printer driver files if you plan to use another printer

Special Considerations

In addition to the guidelines for taking the computer home, follow these guidelines to protect your computer while traveling:

- Always take the computer as carry-on luggage.
- If possible, have the computer inspected by hand. The computer can safely pass through security X-ray machines, but never expose the computer to a metal detector.
- Avoid exposing floppy disks to hand-held metal detectors.

Traveling Internationally with the Computer

Traveling Internationally with the Computer

when you are moving from country to country

Preparing the Computer

Prepare the computer as you would normally prepare it for traveling.

What To Bring with You

Bring the following items with you.

- AC adapter
- Power cords that are appropriate to the country to which you are traveling
- Spare, fully-charged battery packs
- Additional printer driver files if you plan to use another printer
- Proof of purchase, in case you need to show it to customs officials
- International Traveler's Warranty passport

Special Considerations

Follow the same special considerations as when traveling with the computer. In addition, these tips are useful when traveling internationally.

- When traveling in another country, check that the local AC voltage and the AC adapter power cord specifications are compatible. If not, purchase a power cord that is compatible with the local AC voltage (e.g., power rating). Do not use converter kits sold for appliances to power the computer.

Traveling Internationally with the Computer

- If you are using the modem, check if the modem and connector is compatible with the telecom system of the country you are traveling in.

This chapter discusses the important system utilities bundled with your computer.

Contents

System Software	66
Sleep Manager	67
Accessing the Sleep Manager.	68
Sleep Manager Functions	70
Create	70
Remove	72
Minimize	72
Exit	72
Notebook Manager	74
Information Viewer	75
POST	76
Boot Sequence	77
Password	78
Setting the Power-On Password.	79
Setting the Setup Password	80
Power Management	81
Display Device.	82
BIOS Utility	84
Navigating the BIOS Utility	84
Basic System Settings	85
Startup Configuration	87
Onboard Devices Configuration.	89
System Security	90
Setting a Password	91
Changing a Password	92
Removing a Password	92
Power Management	93
Load Default Settings	94

System Software

System Software

The computer comes preloaded with the following software:

- Windows 98 operating system
 - DMI (Desktop Management Interface)-compliant hardware BIOS utility
 - LDCM (LANDesk Client Manager) support
 - System utilities, drivers and application software
-



Note: To access Windows 98 software applications, click on the Start button and select the application folder. Then click on the application icon to run the selected application. To learn about the software and utility, make use of the online help provided by the software.

Sleep Manager

Most notebook computers feature built-in power-saving functions. This computer has two power management modes, standby and hibernation.

While standby puts your computer into a light sleep state, hibernation shuts off all power after saving the current state of your computer. The next time you slide the power switch, the computer resumes from where you left off.

Sleep Manager allows your computer to perform this function.



Note: See “Power Management” on page 36 to understand how your computer saves and manages power.

Sleep Manager is a utility that works with your computer’s BIOS and Windows APM (Advanced Power Management) to manage the hibernation operation. This includes:

- creating the hibernation file which contains the current state of the computer
- checking if the hibernation file is valid
- saving and loading the contents of the hibernation file when entering to and resuming from hibernation

The hibernation file resides in a contiguous area on your hard disk.

Sleep Manager can automatically create, recover, and reallocate space for the hibernation file. If the system memory size was changed or the hibernation file on the hard disk was corrupted, Sleep Manager reallocates the hard disk space for you automatically.

Sleep Manager

Accessing the Sleep Manager

There are two ways to bring up the Sleep Manager.

On the Taskbar

The computer automatically loads Sleep Manager every time you start Windows 98. Sleep Manager resides in the background and the Sleep Manager status icon appears on the taskbar.

Double-click on the Sleep Manager status icon () if enabled to bring up the main Sleep Manager program.

The Sleep Manager icon may or may not appear on the taskbar. A checkbox in the Sleep Manager main screen determines whether to enable or disable the icon on the taskbar.

This icon shows the current status of the hibernation feature. The icon changes to tell you if the feature is valid or not. Resting your cursor on the icon also shows the status.

Start menu

1. Click on the **Start** button.
2. Select **Programs**.
3. Select **Sleep Manager**.
4. Select the **Sleep Manager** program.

The Sleep Manager displays below:

Sleep Manager



Item	Description
Buttons	Click to access the Sleep Manager functions
Current Setting	Displays the drive and size of the current reserved space created by Sleep Manager.
On Board Information	Displays the different areas of system memory and their respective sizes. These system resources need to be stored before the computer can enter hibernation mode, so that the computer can resume successfully. These resources are the contents of: Onboard memory (DRAM or dynamic memory), Video RAM (VRAM or video memory), SMRAM (static memory), and Others. The total size of these resources shows as the recommended size in the dialog box.
Recommended Size	Displays the minimum size of the contiguous space you need for the hibernation feature. The actual size may be a little bit more due to file system alignment.

Sleep Manager

Item	Description
Enable Indicator on the Taskbar	When this checkbox is checked, the Sleep Manager status appears on the taskbar. Double-click on the Sleep Manager status icon on the taskbar to bring up the main program, or simply rest your cursor on the icon to display the current status.

Sleep Manager Functions

Create

Sleep Manager automatically finds a contiguous area on your hard disk and creates the hibernation file in this space. You can also perform this function by clicking on the **Create** button. When you click on the **Create** button, a dialog box pops up:

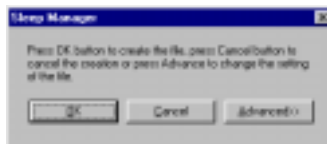

Select **OK** to automatically create the hibernation file. Sleep Manager displays the recommend size based on onboard system information. You can also choose **Advance>>>** to manually set the space settings and size. The advanced screen shows below.

Sleep Manager



Sleep Manager automatically checks the system configuration and displays the recommended size. The drive where the space will be created is defined by the system and will be the first available logical drive which has the requested contiguous free disk space on it. The recommended size is the minimum size needed to save the current system status.

If the program cannot find the required space on the hard disk during the space creation process, it shows a message box to inform the user.

Not Enough Space for Allocation

This is an error message that may appear when Sleep Manager is creating the hibernation file. There are several different reasons that may cause this error.

One reason is that the size of the free disk space on your hard disk is less than the required size. For example, if the onboard memory is 32MB and the video memory is 2MB, the total free disk space required will be around 34MB. If the total free disk space is less than this, the user has to free up space on his hard disk.

Sleep Manager

Another possible reason is that the hard disk has enough free space, but this free space exists as small fragments. The free disk space that Sleep Manager requires needs to be contiguous. To solve this problem, use tools such as Disk Defragmenter (Windows) to compact these free disk spaces. Then run Sleep Manager again to create the file.

One other factor that causes the error is when disk compression utilities are used. Sleep Manager can work with most compression software. However, Sleep Manager can only create the space on a host drive. A host drive stores original file information and cannot be compressed. The free space on the host drive is usually very small, so the compression software needs to be run again to enlarge the size of the host (uncompressed) drive for Sleep Manager.

Remove

If you want to use or take back the reserved space, click on the **Remove** button. This will disable the hibernation feature. Instead, the computer will only be able to enter standby mode.

Minimize

Minimize Sleep Manager by selecting the **Minimize** button. If the Enable indicator on taskbar box is checked, Sleep Manager will switch to the background by locating itself on the taskbar. You can pop-up Sleep Manager again by double-clicking on this icon.

Exit

Exit Sleep Manager by selecting the **Exit** button. Sleep Manager will quit and disable the capability of auto-adjusting the reserved space size. Exiting Sleep Manager is **NOT** recommended.

Sleep Manager



Note: Do not deactivate (remove or exit) or uninstall Sleep Manager. Do not remove or delete the hibernation file. Hibernation will not work without Sleep Manager and the hibernation file.

Notebook Manager

Notebook Manager

The computer has a built-in system setup program called Notebook Manager. The Windows 98-based Notebook Manager allows you to set passwords, the startup sequence of the drives and power management settings. It also shows current hardware configurations.



Note: Certain hot key functions are disabled when you access the notebook manager, because these functions are also found in the notebook manager.

To start the Notebook Manager, press **Fn-F2** or follow these steps:

1. Click on Start, Programs, then Notebook Manager.
 2. Select the Notebook Manager application to run the program.
-



Note: Changes made to most settings in the Notebook Manager take effect the next time the computer restarts. If you make changes in the Power Management and Display Device screens, these changes take effect immediately.

Notebook Manager consists of six sections:

- Information Viewer
- POST
- Boot Sequence
- Password
- Power Management
- Display Device

To select a section, click on the tab of the section you want to view.

Notebook Manager

Information Viewer

Information Viewer summarizes and lists information about the specifications and settings of the different components of your computer.



Note: Items in this table may differ slightly from the ones onscreen.

Item	Description
CPU	Brand, type and clock speed of the CPU (Central Processing Unit)
Total Memory	Total amount of main memory (in megabytes)
Video RAM	Total amount of video memory (in megabytes)
Hard Disk	Size of hard disk (in megabytes)
CD-ROM	Detects presence of the CD-ROM drive
Serial Port 1	Resource settings of serial port 1

Notebook Manager

Item	Description
Parallel Port	Resource settings of the parallel port
Internal Cache	Detects presence and total amount of internal cache memory (in kilobytes)
External Cache	Detects presence and total amount of external cache memory (in kilobytes)
TouchPad	Detects the presence and setting of the internal pointing device
Pointing Device	Type(s) of the pointing device(s) detected, internal and external

POST

POST defines how the computer behaves during the Power On Self-Test routines.



This screen includes the following settings:

- Enable memory test during POST.** Select to enable memory test at system startup.

Notebook Manager

- Enabled Silent Boot. Select to hide POST startup messages, instead displaying the Extensa computer logo.

Boot Sequence

Boot Sequence defines the boot sequence to follow when your computer boots up.



This screen includes the following settings:

- Set CD-ROM as a bootable device. Enable to tell the computer to search for a bootable CD-ROM in the CD-ROM drive and boot from there before following the boot sequence setting.
- Sequence. Specifies the boot sequence or order to follow. Options include:
 - Drive A then C. The computer searches for a bootable diskette in the floppy drive. If no bootable diskette is found, the computer boots from the hard disk.
 - Drive A. The computer searches for a bootable diskette in the floppy drive and boots from there.

Notebook Manager

- Drive C. The computer boots from the hard disk even if a bootable diskette is in the floppy drive.
- Drive C then A. The computer boots from the hard disk. If it cannot boot from the hard disk, it searches for a bootable diskette in the floppy drive and boot from there.

Make your selection and click on **Apply** to accept.

Password

Password is used to set, modify or delete the password(s) for your computer.



There are two passwords used in the system:

- Power-On Password. The power-on password prevents unauthorized access to the computer during system startup and at resume from standby/hibernation modes or an elapsed system resume timer.
- Setup Password. The setup password prevents unauthorized access to the computer's BIOS Utility.

Setting the Power-On Password

To set the Power Password, follow these steps:

1. Click on the Change Power-On Password button. The following dialog box displays:



2. Click on the Enable Power-On Password checkbox.
3. Click in the New Password textbox and type in up to seven alphanumeric characters (A-Z, a-z, 0-9) which you want to be your Power-On Password.
4. Click in the Confirm Password textbox and retype the password.
5. Click on **OK** to accept.



Note: To change a password, follow the same steps used to set a password. To remove a password, follow the same steps used to set a password but leave both fields blank.

Notebook Manager

Setting the Setup Password

To set the Setup Password, follow these steps:

1. Click on the Change Setup Password button.

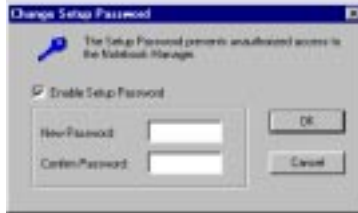

2. Click on the Enable Setup Password checkbox.
3. Click in the New Password textbox and type in up to seven alphanumeric characters (A-Z, a-z, 0-9) which you want to be your Setup Password.
4. Click in the Confirm Password textbox and retype the password.
5. Click on **OK** to accept.



Note: To change a password, follow the same steps used to set a password. To remove a password, follow the same steps used to set a password but leave both fields blank.

Power Management

Power Management is used to set various settings related to power management.



This includes the following power-saving-related features:

- Enable Heuristic Power Management. Select to enable heuristic power management. See “Power Management Modes” on page 36 for more information on heuristic power management. (This option is available only for Windows 95.)
- Enabled display always on. Select to leave your display always turned on, useful when you need to make presentations on your computer. We recommend you disable this feature to save battery power. (This option is available only for Windows 95.)
- Enable hotkey beep. Select to enable the computer to give off beeps when a hot key (or key combination) is pressed.
- Enable battery low warning beep. Select to allow the computer to give off warning beeps when the computer runs low on battery.

Notebook Manager

- Enable sleep upon battery low. Select to allow the computer to enter standby or hibernation mode when the computer runs low on battery.
- Enable system resume timer. Select to allow the computer to wake-up from standby mode if the resume timer is set and matched.
- System Resume Timer. (When Enable system resume timer is selected) click on the button to set the System Resume Timer.

Display Device

Display Device is used to control various settings related to display device(s), such as the display brightness/contrast levels.



Notebook Manager

The items in this screen include:

- Boot Display Device. Sets the default display device on boot-up.
- Switching Display Device. Sets the current display device.



Note: Make sure an external monitor is connected before External monitor is selected.

- Brightness for LCD Panel/Contrast for LCD Panel. Click and drag to set the LCD screen brightness and contrast levels.



Note: TFT active-matrix LCDs have fixed and optimized contrast levels.

Click on the radio button of the desired item, then click on **Apply** to accept. To modify the brightness and/or contrast levels, click and hold the slider control and move to the right to increase, move to the left to decrease the setting. You can also click on the item, and use the cursor keys to set the desired level.

BIOS Utility

BIOS Utility

The BIOS Utility is a hardware configuration program built into your computer's BIOS (Basic Input/Output System).

Your computer is already properly configured and optimized, and you do not need to run this utility. However, if you encounter configuration problems, you may need to run Setup. Please also refer to Chapter 6, Troubleshooting when a problem arises.

To activate the BIOS Utility, press **F2** during POST (while the Extensa logo is being displayed).

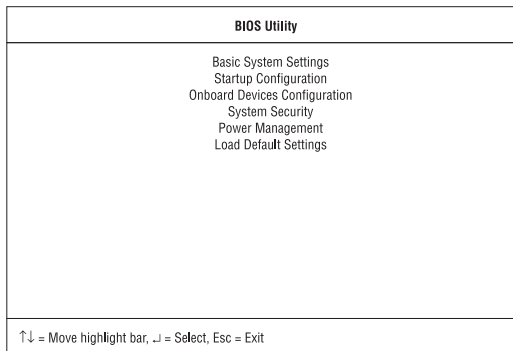

Navigating the BIOS Utility

There are six menu options: Basic System Settings, Startup Configuration, Onboard Devices Configuration, System Security, Power Management and Load Default Settings.

To enter a menu, highlight the item using the ↑↓ keys; then press **Enter**.

Within a menu, navigate through the BIOS Utility by following these instructions:

- Press the cursor up/down keys ↑↓ to move between parameters.

- ❑ Press the cursor left/right keys →← to change the value of a parameter.
- ❑ Press **Esc** while you are in any of the menu options to return to the main menu.



Note: You can change the value of a parameter if it is enclosed in square brackets.

Note: Navigation keys for a particular menu are shown on the bottom of the screen.

Basic System Settings

The Basic System Settings screen contains parameters involving basic computer settings and hardware information.

Basic System Settings					Page 1/1
Date -----	[Tue Jun 2 1998]				
Time -----	[17:49:00]				
Floppy Drive A -----	[1.44MB 3.5-inch]				
Hard Disk -----	[Auto]	Cylinder	Head	Sector	Size(MB)
		6304	16	63	3102
↑↓ = Move highlight bar, ←→ = Change setting, F1 = Help					

BIOS Utility

The following table describes the parameters in this screen. Settings in boldface are the default and suggested parameter settings.

Parameter	Description
Date	Sets the system date. Format: DDD MMM DD YYYY (day-of-the-week month day year)
Time	Sets the system time. Format: HH:MM:SS (hour:minute:second)
Floppy Drive A	Shows the floppy disk drive type (1.44MB 3.5-inch).
Hard Disk	Sets the hard disk type. Options: Auto , User or None. When set to Auto, the computer automatically detects the hard disk information (cylinders, heads, sectors/tracks and maximum capacity). When set to User, you need to input these information manually.



Note: We suggest you set Hard Disk to [Auto] for hassle-free and correct detection of the hard disk.

Startup Configuration

The Startup Configuration screen contains parameters that are related to computer startup.

Startup Configuration		Page 1/1
Boot Display -----	[Both]	
Memory Test -----	[Disabled]	
Silent Boot -----	[Enabled]	
System Boot Drive -----	[Drive A Then C]	
Boot from CD-ROM -----	[Enabled]	
Operating System -----	[Windows 95/98]	
USB Function Support -----	[Disabled]	

↑↓ = Move highlight bar, ←→ = Change setting, F1 = Help

The following table describes the parameters in this screen. Settings in boldface are the default and suggested parameter settings.

Parameter	Description
Boot Display	Sets the display on boot-up. When set to Auto, the computer automatically determines the display device. If an external display device (e.g., monitor) is connected, it becomes the boot display; otherwise, the computer LCD is the boot display. When set to Both, the computer outputs to both the computer LCD and an external display device if one is connected. Options: Auto or Both
Memory Test	Enables or disabled memory test on boot-up. Options: Disabled or Enabled

BIOS Utility

Parameter	Description
Silent Boot	When enabled, hides the computer startup messages on boot-up (the Extensa logo displays) Options: Enabled or Disabled
System Boot Drive	Specifies the boot sequence (the order of drives that the computer will attempt to boot from). For example, when set to Drive A Then C, the computer attempts to boot from the floppy drive. If no bootable floppy disk is in drive A, the computer boots from the hard disk. Options: Drive A Then C , Drive A, Drive C, Drive C Then A
Boot from CD-ROM	Enables boot-up from the CD-ROM drive. When enabled, the computer attempts to boot from the CD-ROM drive (looks for a bootable CD-ROM) before following the boot sequence specified in the System Boot Drive parameter. Options: Enabled or Disabled
Operating System	Specifies the operating system installed in the computer. This parameter helps determine certain hardware settings for optimal computer operation. Options: Windows 95/98 or Windows NT
USB Function Support	Enables or disables the USB (Universal Serial Bus) function. Options: Disabled or Enabled

Onboard Devices Configuration

The Onboard Devices Configuration screen contains parameters settings for your hardware connection devices.

Onboard Devices Configuration		Page 1/1
Serial Port	[Enabled]	
Base Address	[3F8h]	
IRQ	[4]	
Parallel Port	[Enabled]	
Base Address	[378h]	
IRQ	[7]	
Operation Mode	[Bi-directional]	
ECP DMA Channel	[-]	

↑↓ = Move highlight bar, ←→ = Change setting, F1 = Help



Caution: The parameters in this screen are for advanced users only. You do not need to change the values in this screen because these values are already optimized.

The following table describes the parameters in this screen. Settings in boldface are the default and suggested parameter settings.

Parameter	Description
Serial Port	Enables or disabled the serial port. Options: Enabled or Disabled
Base Address	Sets the I/O address of the serial port. Options: 3F8h , 2F8h, 3E8h or 2E8h
IRQ	Sets the interrupt request of the serial port. Options: 4 or 11

BIOS Utility

Parameter	Description
Parallel Port	Enables or disables the parallel port. Options: Enabled or Disabled
Base Address	Sets the I/O address of the parallel port. Options: 378h , 278h or 3BC h
IRQ	Sets the interrupt request of the parallel port. Options: 7 or 5
Operation Mode	Sets the operation mode of the parallel port. Options: Bi-directional , ECP or Standard
ECP DMA Channel	Sets a DMA channel for the printer to operate in ECP mode. This parameter is enabled only if Operation Mode is set to ECP. Options: 1 or 3

System Security

The System Security screen contains parameters that help safeguard and protect your computer from unauthorized use.

System Security		Page 1/1
Disk Drive Control		
Diskette Drive -----	[Normal]	
Hard Disk Drive -----	[Normal]	
Setup Password -----	[None]	
Power-on Password -----	[None]	
↑↓ = Move highlight bar, ←→ = Change setting, F1 = Help		

The following table describes the parameters in this screen. Settings in boldface are the default and suggested parameter settings.

Parameter	Description
Disk Drive Control (Diskette Drive)	Determines the level of operation of the floppy drive. Options: Normal or Disabled
Disk Drive Control (Hard Disk Drive)	Determines the level of operation of the hard disk. Options: Normal or Disabled
Setup Password	When set, this password protects the this BIOS Utility from unauthorized entry. Options: None or Present
Power-on Password	When set, this password protects the computer from unauthorized entry during boot-up or resume from hibernation mode. Options: None or Present

Setting a Password

Follow these steps:

1. Use the ↑ and ↓ keys to highlight a password parameter (Setup or Power-on) and press the **Enter** key. The password box appears:

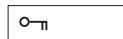

2. Type a password. The password may consist of up to seven characters (A-Z, a-z, 0-9).

BIOS Utility



Important: Be very careful when typing your password because the characters do not appear on the screen.

3. Press **Enter**. The retype password box appears.



4. Retype the password to verify your first entry and press **Enter**.

After setting the password, the computer automatically sets the chosen password parameter to Present.

5. Press **Esc** to return to the main menu.
6. Press **Esc**. The following dialog box appears.

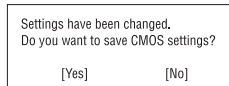

7. Select **Yes** and press **Enter** to save the password and exit the BIOS Utility.

Changing a Password

To change a password, follow the same steps used to set a password.

Removing a Password

To remove a password, use the **↑** and **↓** keys to highlight a password parameter and press the **←** or **→** key.

Power Management

The Power Management screen contains parameters that are related to power-saving and power management.

Power Management		Page 1/1
Heuristic Power Management Mode	[Enabled]	
Display Always On	[Disabled]	
Hotkey Beep	[Enabled]	
System Resume Timer Mode	[Disabled]	
System Resume Date	[--:--]	
System Resume Time	[-:-:-]	
Battery-low Warning Beep	[Enabled]	
Sleep Upon Battery-low	[Enabled]	

↑↓ = Move highlight bar, ←→ = Change setting, F1 = Help

The following table describes the parameters in this screen. Settings in boldface are the default and suggested parameter settings.

Parameter	Description
Heuristic Power Management Mode	Enables or disables heuristic power management (Windows 95 only). See "Power Management" on page 36 for more information on power management modes. Options: Enabled or Disabled
Display Always On	When enabled, the computer display is always on (Windows 95 only). You may want to set this if you are making a presentation on your computer. Options: Disabled or Enabled
Hotkey Beep	When enabled, the computer gives off a beep when a hot key (key combination is pressed). See "Hot Keys" on page 11 for details on hot keys. Options: Enabled or Disabled

BIOS Utility

Parameter	Description
System Resume Timer Mode	When enabled and the system resume date and time are valid, the computer resumes (wakes up) at the set time and date. Options: Disabled or Enabled
System Resume Date	Sets the date the computer resumes at if System Resume Timer Mode is enabled. Format: MM DD, YYYY (month day, year)
System Resume Time	Sets the time the computer resumes at if System Resume Time Mode is enabled. Format: HH:MM:SS (hour:minute:second)
Battery-Low Warning Beep	Enables or disables warning beeps during a battery-low condition. Options: Enabled or Disabled
Sleep on Battery-low	Enables or disables the hibernation function during a battery-low condition. When the computer is running very low on battery power, the computer will enter hibernation mode if Sleep Manager is installed and the hibernation file is valid. See "Sleep Manager" on page 67. Options: Enabled or Disabled

Load Default Settings

When you select this menu item, the following dialog box displays:

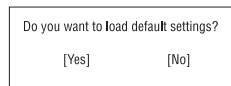

To load factory-default settings for all the parameters, select **Yes** and press **Enter**. Otherwise, select **No** and press **Enter**.

Troubleshooting

This chapter instructs you on how to deal with common system problems. Read it before calling a technician if a problem occurs. Solutions to more serious problems require opening up the computer. Do not attempt to open the computer by yourself. Contact your dealer or an authorized service center for assistance.

Contents

Frequently-Asked Questions	96
Error Messages	101

Frequently-Asked Questions

Frequently-Asked Questions

This is a list of possible situations that may arise during the use of your computer, and gives easy answers and solutions to these questions.

I slid the power switch and opened the display, but the computer does not start or boot-up.

Look at the Power indicator:

- If it is not lit, no power is being applied to the computer. Check the following:
 - If you are running on battery power, it may be low and unable to power the computer. Connect the AC adapter to recharge the battery pack.
 - Make sure the AC adapter is plugged in properly to the computer and to the power outlet.
- If it is lit, check the following:
 - If the Standby indicator is lit, the computer is in standby mode. Press any key or tap on the touchpad to resume.
 - Is a non-bootable (non-system) diskette in the floppy drive? Remove or replace it with a system diskette and press Ctrl-Alt-Del to restart the system.

The operating system files may be damaged or missing. Insert the startup disk you created during Windows 98 setup into the floppy drive and press Ctrl-Alt-Del to restart the system. This will diagnose your system and make necessary fixes.

Nothing appears on the screen.

The computer's power management system automatically blanks the screen to save power. Press any key to turn the display back on.

Frequently-Asked Questions

If pressing a key does not turn the display back on, two things might be the cause:

- The contrast and/or brightness level might be too low. Press Fn-↑ and Fn-↓ to adjust the contrast level (only for models with HPA LCDs). Press Fn-← and Fn-→ to adjust the brightness level.
- The display device might be set to an external monitor. Press the display toggle hot key Fn-F6 to toggle the display back to the computer.

Image is not full-screen.

Make sure the resolution is set to 800x600. Right-click on your Windows 98 desktop and select Properties to bring up the Display Properties dialog box. Then click on the Settings tab to make sure the resolution is set to the appropriate resolution. Resolutions lower than the specified resolution is not full-screen on the computer or on an external monitor.

No audio from the computer.

Check the following:

- The volume may be muted. In Windows 98, look at the volume control icon on the taskbar. If it is crossed-out, click on the icon and deselect the Mute option.
- The speakers may be turned off. Press Fn-F8 to turn the speakers on (this hot key also turns the speakers off).
- The volume level may be too low. In Windows 98, look at the volume control icon on the taskbar. Click on the icon and adjust the level. You can also use the volume control knob on the front panel of the computer to adjust the volume.

Frequently-Asked Questions

If headphones, earphones or external speakers are connected to the line-out port on the computer's front panel, the internal speakers automatically turn off.

External microphone or audio line-in device does not work.

Check the following:

- Make sure the external microphone is connected to the microphone-in jack and/or the audio line-in device is connected to the audio line-in jack on the computer's front panel.
- If you cannot hear playback, the speakers may be muted.

I want to eject the CD-ROM tray without turning on the power. I cannot eject the CD-ROM drive tray.

There is a mechanical eject button on the CD-ROM drive. Simply insert the tip of a pen or paperclip and push to eject the CD-ROM tray.

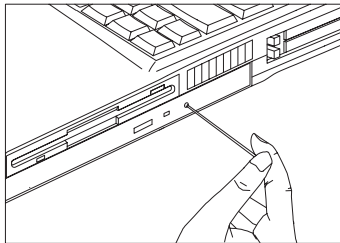

You can also turn on your CD-ROM drive without turning on the power. See "Playing Audio CDs" on page 24 for details.

Frequently-Asked Questions

The keyboard does not respond.

Try attaching an external keyboard to the PS/2 connector on the computer's rear. If it works, contact your dealer or an authorized service center as the internal keyboard cable may be loose.

The serial mouse does not work.

Check the following:

- Make sure that the serial cable is plugged securely into the serial port.
- During POST, press **F2** to access the Setup Utility. Go to the Advanced screen and verify that the serial port is enabled. See "Startup Configuration" on page 87 for details.

I prefer using an external keyboard and mouse, but both have PS/2 connectors and there is only one PS/2 port on the computer.

To connect two PS/2-type devices to the computer, you need to use a PS/2 Y-bridge connector. See "PS/2 Y-Bridge Cable" on page 52 for details.

The printer does not work.

Check the following:

- Make sure that the printer is connected to a power outlet and it is turned on.
- Make sure the printer cable is connected securely to the computer's parallel port and the corresponding port on the printer.
- During POST, press **F2** to access the Setup Utility. Go to the Advanced screen and verify that the parallel port is enabled. See "Startup Configuration" on page 87 for details.

Frequently-Asked Questions

I want to set up my location to use the internal modem.

To properly use your communications software (e.g., HyperTerminal), you need to set up your location:

- 1.** Open the Windows 98 Control Panel and double-click on the Modems icon.
- 2.** Click on Dialing Properties and begin setting up your location.

Refer to the Windows 98 manual.

Error Messages

If you receive an error message, note the message and take the corrective action. The following table lists the error messages in alphabetical order together with the recommended course of action.

Error Messages	Corrective Action
CMOS Battery Bad	Contact your dealer or an authorized service center.
CMOS Checksum Error	Contact your dealer or an authorized service center.
Disk Boot Failure	Insert a system (bootable) diskette in the floppy drive (A:), then press Enter to reboot.
Diskette Drive Controller Error or No Controller Present	Contact your dealer or an authorized service center.
Diskette Drive Error	Contact your dealer or an authorized service center.
Diskette Drive Type Mismatch	Press F2 (during POST) to enter the Setup Utility; then press Esc to exit and reconfigure the computer.
Equipment Configuration Error	Press F2 (during POST) to enter the Setup Utility; then press Esc to exit and reconfigure the computer.
Hard Disk 0 Error	Contact your dealer or an authorized service center.
Hard Disk 0 Extended Type Error	Contact your dealer or an authorized service center.
I/O Parity Error	Contact your dealer or an authorized service center.

Error Messages

Error Messages	Corrective Action
Insert system diskette and press <Enter> key to reboot	Insert a system (bootable) diskette in the floppy drive (A:), then press Enter to reboot.
Keyboard Error or No Keyboard Connected	Contact your dealer or an authorized service center.
Keyboard Interface Error	Contact your dealer or an authorized service center.
Memory Size Mismatch	Press F2 (during POST) to enter the Setup Utility; then press Esc to exit and reconfigure the computer.
Missing operating system	Follow these steps: <ol style="list-style-type: none">1. Press F2 (during POST) to enter the Setup Utility.2. Enter the Hard Disk 0 submenu and correct the Hard Disk 0 type. See the specification label attached to hard disk drive. We suggest you set the Hard Disk 0 type to [Auto] for hard disk drive auto-detection.3. Exit the Setup Utility (saving the changes).
Non-system disk or disk error. Replace and strike any key when ready	Insert a system (bootable) diskette in the floppy drive (A:), then press Enter to reboot.
Pointing Device Error	Contact your dealer or an authorized service center.
Pointing Device Interface Error	Contact your dealer or an authorized service center.
Protected Mode Test Fail	Contact your dealer or an authorized service center.

Error Messages

Error Messages	Corrective Action
RAM BIOS Bad	Contact your dealer or an authorized service center.
RAM Parity Error	Contact your dealer or an authorized service center.
Real-Time Clock Error	Press F2 (during POST) to reconfigure the computer.
Video RAM BIOS Bad	Contact your dealer or an authorized service center.

If you still encounter problems after going through the corrective measures, please contact your dealer or an authorized service center for assistance. Some problems may be solved using the BIOS Setup Utility. See “BIOS Utility” on page 84.

Specifications

This appendix lists the general specifications of your computer.

Microprocessor

TCP (Tape Carrier Package) daughterboard module with:

- Intel Pentium® processor with MMX™ technology
- Integrated 512KB Level 2 cache memory

Memory

- 16MB main memory expandable to 128 MB
- Two 144-pin soDIMM sockets (SDRAM - Synchronous Dynamic Random Access Memory)
- 64-bit dual memory banks
- 256KB Flash ROM BIOS

Data Storage

- One 2.5-inch, 12.7mm removable hard disk
- One 3.5-inch internal floppy drive
- One 5.25-inch internal CD-ROM drive

Display and Video

- 12.1-inch fast-response, high-contrast true-color High Performance Addressing (HPA) LCD, or 12.1-inch high-color Thin Film Transistor (TFT) LCD
- 800x600 SVGA resolution
- Integrated 128-bit graphics accelerator (PCI) and 2MB EDO video memory
- Simultaneous LCD and CRT display

Specifications

Audio

- 16-bit stereo audio
- 3-dimensional sound with built-in wavetable synthesizer
- Dual speakers
- Sound Blaster Pro- and Windows Sound System-compatible
- Separate audio ports for line-out, line-in and microphone-in devices

Keyboard and Pointing Device

- 85-/86-/89-key Windows 95/Windows 98 keyboard
- Ergonomically-centered touchpad pointing device

I/O Ports

- Two type II/I or one type III CardBus socket(s)
- One RJ-11 phone jack
- One DC-in jack (AC adapter)
- One RS-232 serial port (UART16550-compatible)
- One parallel port (ECP-compliant)
- One external monitor port (DDC 2.0-compliant)
- One keyboard/mouse port (PS/2-compatible)
- One port replicator connector
- One speaker-/headphone-out jack
- One audio line-in jack
- One microphone-in jack
- One USB port

Specifications

Weight and Dimensions

- 3.1 kg (6.9 lb)
- 308 x 257 x 44.5 mm (12.12 x 10.11 x 1.75 in)

Temperature

- Operating: 10°C ~ 35°C
- Non-operating: -20°C ~ 60°C

Humidity (non-condensing)

- Operating: 20% ~ 80% RH
- Non-operating: 20% ~ 80% RH

System

- Windows 98 operating system
- DMI-compliant
- LDCM support

Battery Pack

- 34-WattHour Nickel Metal-Hydride battery pack
- Smart battery management technology
- 2-hour rapid charge/3~4-hour charge-in-use

AC Adapter

- 45-Watt
- Auto sensing 100~240Vac, 50~60Hz

Specifications

Options

- 16-/32-/64-MB SDRAM memory upgrade module
- Higher-capacity hard disk drive
- PS/2 Y-cable
- Full-function port replicator
- Additional AC adapter and battery pack

A

- AC adapter
 - caring for, xviii
 - connecting, xiv
- Advanced Power Management, 40
- APM. See Advanced Power Management
- audio, 23
 - connecting externally, 48
 - controlling volume, 25
 - troubleshooting, 97-98
- audio CD
 - playing, 25

B

- battery
 - installing, xiv
- battery pack
 - battery-low warning, 34
 - caring for, xix
 - characteristics, 30
 - charging, 32
 - charging indicator, 6
 - charging modes, 32
 - checking charge level, 33
 - installing, 31
 - low conditions, 35
 - optimizing, 33
 - removing, 31
 - using the first time, 30
- BIOS Utility, 84-94
 - Basic System Settings menu, 85
 - entering, 84
 - Load Default Settings menu, 94
 - navigating, 84

- Onboard Devices
 - Configuration menu, 89
 - Power Management menu, 93
 - Startup Configuration menu, 87
 - System Security menu, 90

- boot order
 - setting in Notebook Manager, 77
- brightness
 - hot keys, 13
 - setting in Notebook Manager, 83

C

- caps lock, 8
 - on indicator, 7
- care
 - AC adapter, xviii
 - battery pack, xix
 - computer, xviii
- CD-ROM
 - ejecting, 17
 - ejecting manually, 98
 - troubleshooting, 98
- charging
 - checking level, 33
 - modes, 32
- cleaning
 - computer, xix
- computer
 - bringing to meetings, 59
 - caring for, xviii
 - cleaning, xix
 - connecting, xiv
 - disconnecting, 58

Index

- features, 2
- information, 75
- moving around, 59
- on indicator, 6
- power management, 36
- security, 26
- setting up a home office, 61
- taking home, 60
- traveling
 - internationally, 63
- traveling on local trips, 62
- troubleshooting, 95
- turning on, xv
- connections
 - AC adapter, xiv
 - audio, 48
 - computer, xiv
 - file transfer cable, 53
 - keyboard, external, 43
 - keypad, external, 44
 - monitor, 42
 - mouse, 45
 - mouse, PS/2, 45
 - mouse, serial, 46
 - printer, 47
 - PS/2 y-bridge cable, 52
 - USB, 51
- contrast
 - hot keys, 12
 - setting in Notebook Manager, 83
- D**
- date
 - setting in BIOS Utility, 86
- diskette
 - ejecting, 16
- diskette drive, 16
- display, 4
 - auto-dim feature, 37
 - hot keys, 12
 - opening and closing, 5
 - performance, 4
 - power management, 4, 36
 - setting boot device in BIOS Utility, 87
 - setting boot device in Notebook Manager, 83
 - setting in Notebook Manager, 82
 - simultaneous, 4
 - switching device in Notebook Manager, 83
 - troubleshooting, 96, 97
- E**
- error messages, 101
- F**
- FAQ. See frequently-asked questions
- file transfer cable
 - connecting, 53
- floppy disk
 - ejecting, 16
- floppy drive, 16
- frequently-asked questions, 96
- H**
- hard disk, 16
 - power management, 37
 - upgrading, 56
- help
 - Internet home page, xvi
 - online manual, xvi

technical support, xvii
Heuristic Power
 Management, 36
Hibernation mode, 38-39
 conditions, 39
 entering, 39
 hot key, 12
 resuming from, 39
 utility, 67
hot keys, 11
HPM. See Heuristic Power
 Management

I

indicator lights, 6
ITW. See warranty

K

keyboard, 8
 connecting externally, 43
 embedded numeric
 keypad, 9
 hot keys, 11
 lock keys, 8
 troubleshooting, 99
 Windows 98 keys, 10
keypad
 connecting externally, 44

L

LEDs, 6

M

media access
 on indicator, 6
media bay, 17
memory

 installing, 55-56
 size configurations, 54
 upgrading, 54
messages
 error, 101
microphone
 troubleshooting, 98
modem, 22
monitor
 connecting, 42
mouse
 connecting externally, 45
 troubleshooting, 99

N

Notebook Manager, 74-83
 Boot Sequence, 77
 Display Device, 82
 hot key, 11
 Information Viewer, 75
 Password, 78
 Power Management, 81
 starting, 74
num lock, 8
 on indicator, 7
numeric keypad
 embedded, 9

O

options
 cables, 52
 hard disk upgrade, 56
 memory upgrade, 54
 PC Cards, 50
 port replicator, 49
 spare AC adapter, 52
 spare battery, 52

Index

P

- palm rest, 13
- parallel port
 - setting in BIOS Utility, 90
- password, 26
 - changing in BIOS Utility, 92
 - checking during boot, 91
 - checking during resume, 91
 - removing in BIOS Utility, 92
 - setting in BIOS Utility, 91
 - setting in Notebook Manager, 79-80
 - types, 26
- PC Card, 20
 - ejecting, 21
 - inserting, 21
- peripherals
 - power management, 37
- ports, 18
 - rear, 19
 - right, 20
- power
 - managing in BIOS Utility, 93
 - managing in Notebook Manager, 81
 - turning on, xv
- power management
 - advanced, 40
 - heuristic, 36
- power management modes
 - display standby mode, 36
 - hard disk standby mode, 37
 - Hibernation mode, 38-39
 - peripheral standby

- modes, 37
- Standby mode, 37-38
- printer
 - connecting, 47
 - troubleshooting, 99
- problems, 96
 - audio, 97-98
 - CD-ROM, 98
 - display, 96, 97
 - keyboard, 99
 - printer, 99
 - serial mouse, 99
 - startup, 96
 - troubleshooting, 95
- PS/2 mouse
 - connecting, 45
- PS/2 y-bridge cable
 - connecting, 52

Q

- questions
 - multiple PS/2 devices, 99
 - setting location for modem use, 100

S

- safety
 - CD-ROM drive, x
 - FCC notice, v
 - general instructions, vii
 - lithium battery, xi
- security
 - keylock, 26
 - passwords, 26
- serial mouse
 - connecting, 46
- serial port
 - setting in BIOS Utility, 89

service
 when to call, xix
Sleep Manager, 67
software
 bundled, 66
speakers
 hot key, 12
 troubleshooting, 97
specifications, 105
Standby mode, 37-38
 condition, 37
 entering, 37
 hot key, 11
 resuming from, 38
 signals, 38
 status indicator, 6
status indicators, 6
storage, 16
 floppy drive, 16
 hard disk, 16
support
 information, xvii

T

time
 setting in BIOS Utility, 86
touchpad, 14
 hot key, 12
 using, 14-15
travel
 international flights, 63
 local trips, 62
troubleshooting, 95

U

Universal Serial Bus, 20
USB
 connecting, 51

USB. See Universal Serial Bus
utility
 BIOS Setup, 84-94
 Notebook Manager, 74-83
 Sleep Manager, 67

V

volume
 adjusting, 25

W

warranty
 International Traveler's
 Warranty, xvii
Windows 98 keys, 10

Free Manuals Download Website

<http://myh66.com>

<http://usermanuals.us>

<http://www.somanuals.com>

<http://www.4manuals.cc>

<http://www.manual-lib.com>

<http://www.404manual.com>

<http://www.luxmanual.com>

<http://aubethermostatmanual.com>

Golf course search by state

<http://golfingnear.com>

Email search by domain

<http://emailbydomain.com>

Auto manuals search

<http://auto.somanuals.com>

TV manuals search

<http://tv.somanuals.com>