

Aspire M1620
Veriton M262
Service Guide

Service guide files and updates are available on the AIPG/CSD web; for more information please refer to <http://csd.acer.com.tw>

PRINTED IN TAIWAN

Revision History

Please refer to the table below for the updates made on Aspire M1620 VeritonM262 service guide.

Date	Chapter	Updates

Copyright

Copyright © 2007 by Acer Incorporated. All rights reserved. No part of this publication may be reproduced, transmitted, transcribed, stored in a retrieval system, or translated into any language or computer language, in any form or by any means, electronic, mechanical, magnetic, optical, chemical, manual or otherwise, without the prior written permission of Acer Incorporated.

Disclaimer

The information in this guide is subject to change without notice.

Acer Incorporated makes no representations or warranties, either expressed or implied, with respect to the contents hereof and specifically disclaims any warranties of merchantability or fitness for any particular purpose. Any Acer Incorporated software described in this manual is sold or licensed "as is". Should the programs prove defective following their purchase, the buyer (and not Acer Incorporated, its distributor, or its dealer) assumes the entire cost of all necessary servicing, repair, and any incidental or consequential damages resulting from any defect in the software.

Acer is a registered trademark of Acer Corporation.

Intel is a registered trademark of Intel Corporation.

Pentium 4 and Celeron are trademarks of Intel Corporation.

Other brand and product names are trademarks and/or registered trademarks of their respective holders.

Conventions

The following conventions are used in this manual:

SCREEN MESSAGES	Denotes actual messages that appear on screen.
NOTE	Gives bits and pieces of additional information related to the current topic.
WARNING	Alerts you to any damage that might result from doing or not doing specific actions.
CAUTION	Gives precautionary measures to avoid possible hardware or software problems.
IMPORTANT	Remind you to do specific actions relevant to the accomplishment of procedures.

Preface

Before using this information and the product it supports, please read the following general information.

1. This Service Guide provides you with all technical information relating to the BASIC CONFIGURATION decided for Acer's "global" product offering. To better fit local market requirements and enhance product competitiveness, your regional office MAY have decided to extend the functionality of a machine (e.g. add-on card, modem, or extra memory capability). These LOCALIZED FEATURES will NOT be covered in this generic service guide. In such cases, please contact your regional offices or the responsible personnel/channel to provide you with further technical details.
2. Please note WHEN ORDERING FRU PARTS, that you should check the most up-to-date information available on your regional web or channel. If, for whatever reason, a part number change is made, it will not be noted in the printed Service Guide. For ACER-AUTHORIZED SERVICE PROVIDERS, your Acer office may have a DIFFERENT part number code to those given in the FRU list of this printed Service Guide. You MUST use the list provided by your regional Acer office to order FRU parts for repair and service of customer machines.

Chapter 1 System Specifications 1

Features.....	1
Main board Placement.....	10
Block Diagram.....	11
AspireM1620 Front Panel.....	12
Aspire M1620 Rear Panel.....	13
VeritonM262 Front Panel.....	14
VeritonM262 Rear Panel.....	15
Hardware Specifications and Configurations.....	16
Power Management Function (ACPI support function).....	22

Chapter 2 System Utilities 23

Entering Setup.....	24
Product Information.....	26
Standard CMOS Features.....	27
Advanced BIOS Features.....	30
Integrated Peripherals.....	34
Power Management.....	41
PnP/PCI Configuration.....	44
PC Health Status.....	46
Frequency/Voltage Control.....	47
Load Default Settings.....	49
Set Supervisor/User Password.....	50
Save & Exit Setup.....	52
Exit Without Saving.....	53

Chapter 3 Machine Disassembly and Replacement 54

General Information.....	55
Disassembly Procedure.....	56
AspireM1620 Disassembly Procedure.....	57
VeritonM262 Disassembly procedure.....	63

Chapter 4 Troubleshooting 73

Chapter 5 Jumper and Connector Information 74

Jumper Setting.....	74
---------------------	----

Chapter 6 FRU (Field Replaceable Unit) List 83

Exploded Diagram.....	84
Parts.....	86

System Specifications

Features

Operating System

- Microsoft Windows Vista (Home Basic, Home Premium, Business)

Processor

- Socket Type: Intel® Socket T LGA 775 pin
- Processor Type:
 - Support 105W CPU, Intel® Core 2 Quad, Core 2 Extreme, Core 2 Duo, Pentium® D, Pentium® 4, Celeron D processors , Socket T (LGA775) Intel® i7000 series field

Chipset

- North Bridge: 945G/GC
- South Bridge: ICH7

PCB

- Form Factor: ATX
- Dimension/Layer: 9.6"x 8.8"

Memory

- Memory Type: DDRII 400/533/667
- Support single channel 64 bit mode with maximum memory size
up to 4GB
- DIMM Slot: 2
- Memory Max: 128Mb/256Mb/512Mb/1Gb devices technologies
- Capacity: Up to 128MB per DIMM with maximum memory size
up to 4 GB

Graphics

- Intel 945G/GC on die graphic solution
- DVMT 4.0 technology support

-
- Enhanced 3D and Clear Video technology support
 - Dual View function support (by Intel ADD2/MEC card)
 - 1 D-sub VGA port on rear

PCI

- PCI Express Slot Type: x16
- PCI Express x16 Slot Quantity: 1
- Support ADD2/MEC card
- PCI Express Slot Type: x1
- PCI Express x1 Slot Quantity: 1
- PCI Slot
- PCI Slot Quantity: 2

FDD

- Slot Quantity: 1
- Design Criteria:

-
- Should support 1.44MB/3 mode 3.5" Devices

SATA

- Slot Type: SATA slot
- Slot Quantity: 4
- Storage Type support:
 - HDD/CD-ROM/CD-RW/DVD-ROM/DVD-RW/DVD+RW/
DVD Dual/DVD
SuperMultiPlus/Blu-Ray ODD

Audio

- Audio Type: HD audio codec
- Audio Channel: 7.1 channel
- Audio Controller /Codec: ALC883, colay with ALC888
- Support S/PDIF: S/PDIF-out header (1~~4~~)

LAN

- MAC Controller: ICH7
- Realtek RTL8100C, Colay with 8110SC (10M/100M/1000M

LAN)

- PHY: Intel Nineveh RTL8110SC PCI-E Giga LAN

USB

- Controller Type: Intel ICH7
- Ports Quantity: 8
 - 4 back panel ports
 - On-board: 2x5 header x2
 - Connector Pin: standard Intel FPIO pin definition (2x5)
- Data transfer rate support:
 - USB 2.0/1.1

1394

- Controller: Intel ICH7
- 1 on board header
- 1 6-pin 1394 port on rear port

BIOS

- BIOS Type: Phoenix Award or AMI Kernel with Acer skin BIOS
- 4Mb Flash BIOS
- Note:
 - Boot ROM should be included (PXE function should be built in with default and RPL function is optional by service BIOS)
- Compliant with latest ASF 2.0 spec
- Compliant with latest SMT 2.0 spec
- Compliant with latest Intel Virtualization Technology spec

I/O Connector

- Controller: Super I/O ITE IT8718F with hardware monitor

Rear I/O Connector

- 1 Parallel port,
- 1 serial port
- 1 D-Sub VGA port
- 1 RJ45 LAN port
- 4 USB ports
- 7.1 channel phone jack (6 audio jacks)
- 1 6-pin 1394 port

On-board connectors

- 1 LGA 775 CPU socket
- 2 DDR2 memory sockets
- 1 PCI Express x16 slot

-
- 1 PCI Express x 1 slot
 - 2 PCI slots
 - 1 FDD slot
 - 4 SATA2 connectors
 - 3 25 pin Intel FPIO specification USB pin connectors (follow Intel FPIO standard Specification)
 - 1 25 pin Intel FPIO spec. Microphone In/ Headphone Out pin connectors
 - 1 serial port 25 pin connector (2nd serial port)
 - 1 HD audio digital header
 - 4 pin CPU Fan connector
 - 3 pin System FAN connector with linear circuit
 - 24pin + 4pin ATX interface PS3/PS2 SPS connector
 - 1 27 pin front panel IO header

-
- 1 Jumper for clear CMOS
 - Color management for on board connectors (please refer to Acer spec)
 - Header for CIR & IR blaster function (Check ITE Solution)

Power Supply

- PSP Type: 250W/300W

Main board Placement

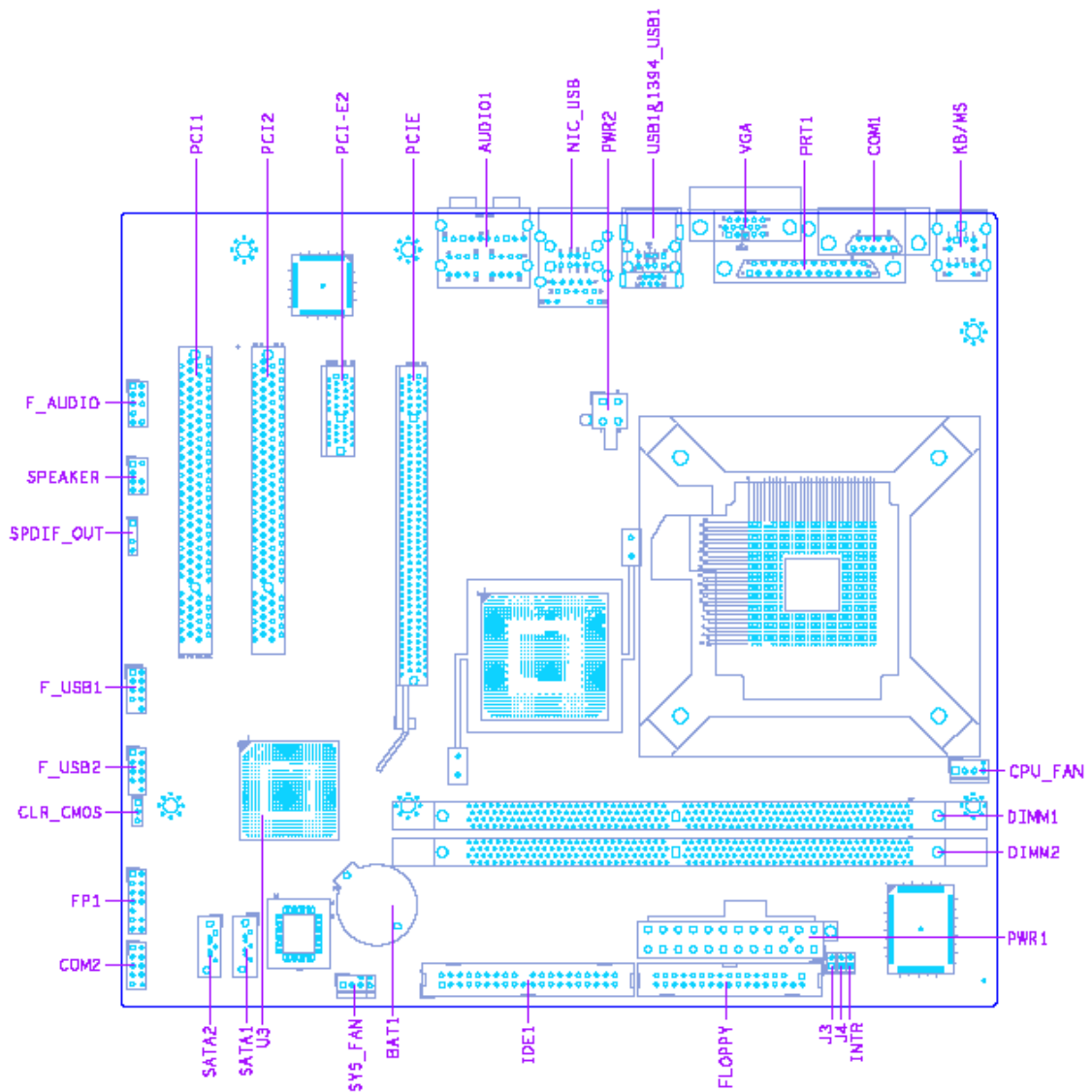

Block Diagram

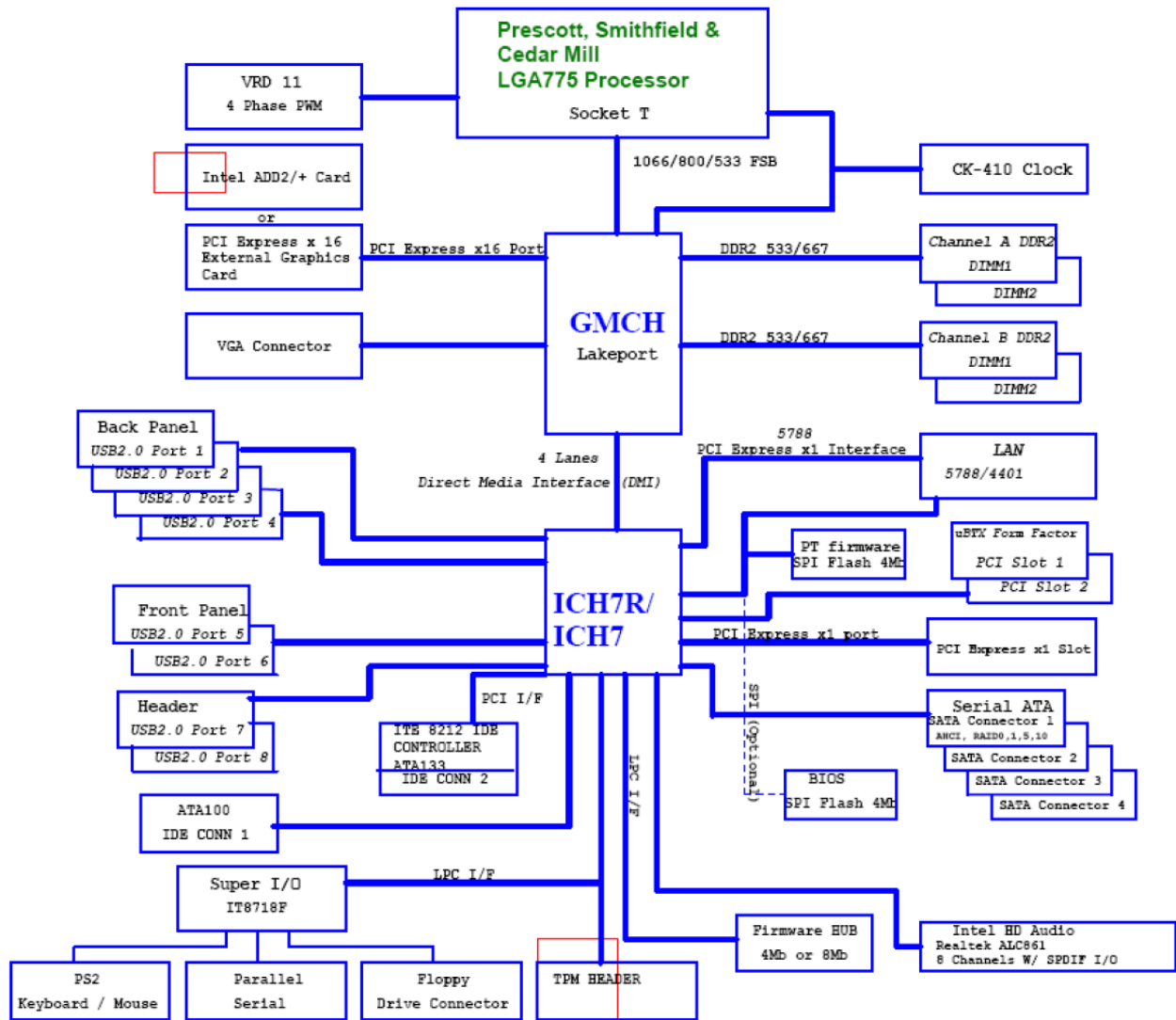

Aspire M1620 Front Panel

The computer's front panel consists of the following:

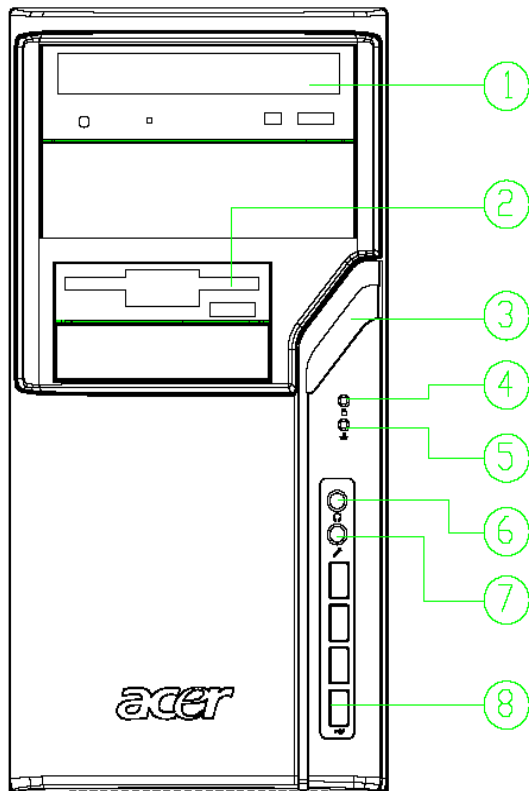

AM10	
LABEL	DESCRIPTION
1	OPTICAL DEVICE
2	3.5" DEVICE
3	POWER BUTTON
4	HDD LED
5	LAN LED
6	SPEAKER OUT
7	MIC PHONE
8	USB PORT

Aspire M5620 Rear Panel

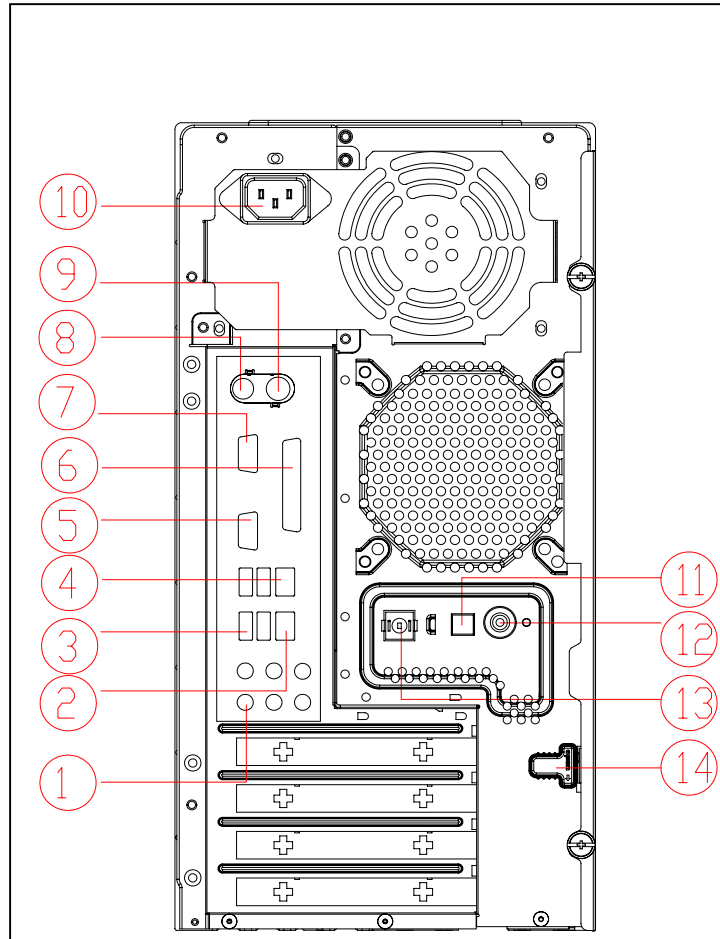

Item	Description	Item	Description
1	6 AUDIO JACKS	8	PS2 KEYBOARD
2	LAN PORT	9	PS2 MOUSE
3	USB PORTS	10	POWER CORD PORT
4	1394 PORT	11	SPDIF BRACKET
5	CRT/LCD PORT	12	SPDIF PORT
6	PARALLEL PORT	13	RECOVERY SWITCH HOLDER
7	COM PORT	14	LOCK HANDLE

VeritonM262 Front Panel

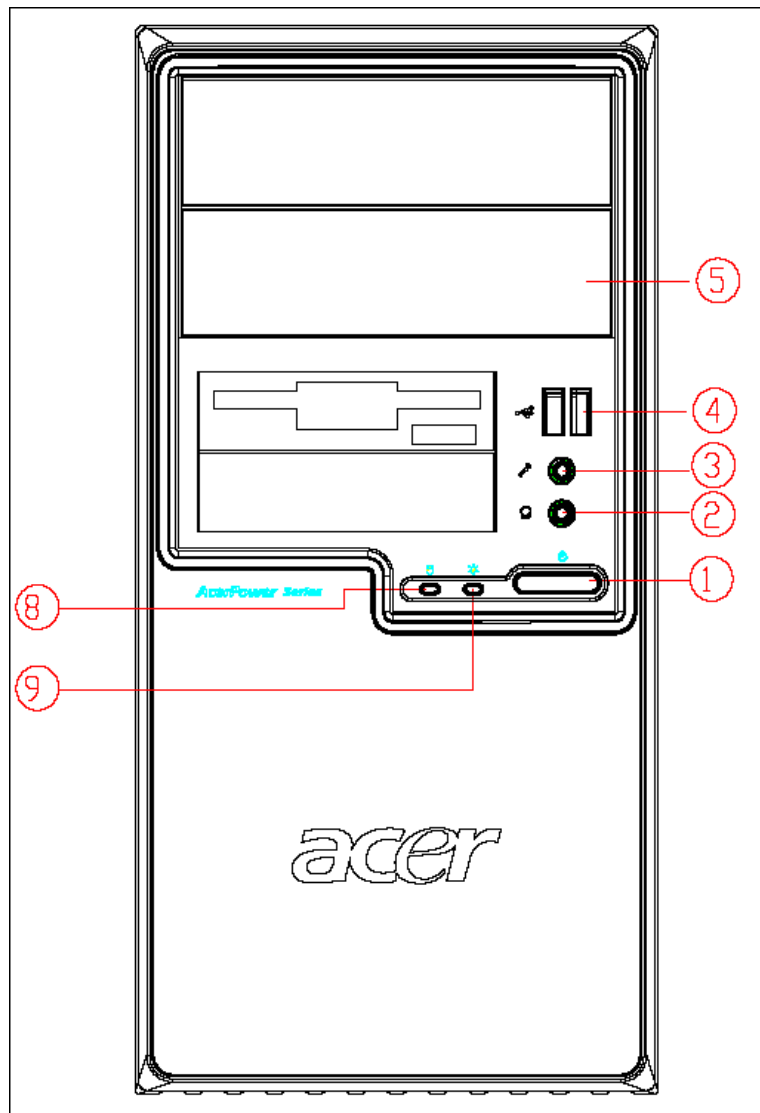

Label	Description
1	Power-Button
2	Speaker-out/Line-out Port
3	Microphone-in out (Front)
4	USB Ports
5	Optical drive
8	HDD LED
9	Power LED

VeritonM262 Rear Panel

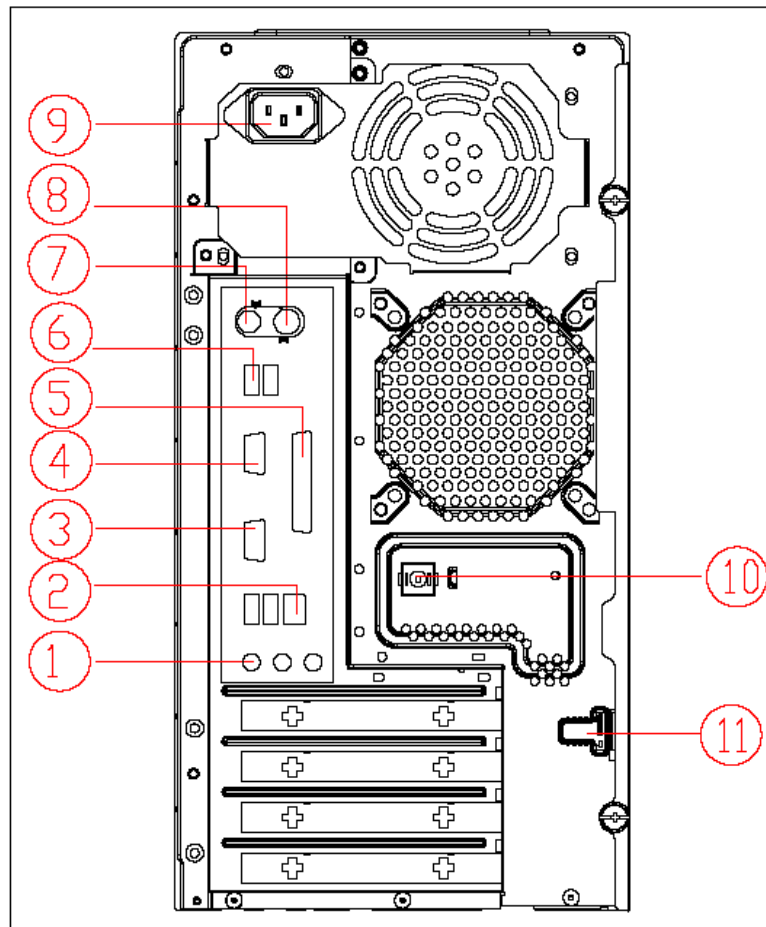

Item	Description	Item	Description
1	3 audio jacks	7	PS/2 keyboard
2	RJ45 port	8	PS/2 mouse
3	CRT/LCD port	9	Power cord Port
4	Serial port	10	Recovery Switch Holder
5	Parallel port	11	Lock Handle
6	USB PORTS		

Power Management Function (ACPI support function)

Device Standby Mode

- Independent power management timer for hard disk drive devices (0-15 minutes, time step=1 minute).
- Hard disk drive goes into Standby mode (for ATA standard interface).
- Disable V-sync to control the VESA DPMS monitor.
- Resume method: device activated (Keyboard for DOS, keyboard & mouse for Windows).
- Resume recovery time: 3-5 sec.

Global Standby Mode

- Global power management timer (2-120 minutes, time step=10 minute).
- Hard disk drive goes into Standby mode (for ATA standard interface).
- Disable H-sync and V-sync signals to control the VESA DPMS monitor.
- Resume method: Return to original state by pushing external switch button, modem ring in, keyboard and mouse for APM mode.
- Resume recovery time: 7-10 sec.

Suspend Mode

- Independent power management timer (2-120 minutes, time step=10 minutes) or pushing external switch button.
- CPU goes into SMM.
- CPU asserts STPCLK# and goes into the Stop Grant State.
- LED on the panel turns amber colour.
- Hard disk drive goes into SLEEP mode (for ATA standard interface).
- Disable H-sync and V-sync signals to control the VESA DPMS monitor.
- Ultra I/O and VGA chip go into power saving mode.
- Resume method: Return to original state by pushing external switch button, modem ring in, keyboard and mouse for APM mode.
- Return to original state by pushing external switch button, modem ring in and USB keyboard for ACPI mode.

ACPI

- ACPI specification 1.0b.
- S0, S1, S3 and S5 sleep state support.
- On board device power management support.
- On board device configuration support.

System Utilities

The manufacturer or the dealer already configures most systems. There is no need to run Setup when starting the computer unless you get a Run Setup message.

The Setup program loads configuration values into the battery-backed nonvolatile memory called CMOS RAM.

This memory area is not part of the system RAM.

NOTE: If you repeatedly receive Run Setup messages, the battery may be bad/flat. In this case, the system cannot retain configuration values in CMOS.

Before you run Setup, make sure that you have saved all open files. The system reboots immediately after you exit Setup.

Entering Setup

Power on the computer and the system will start POST (Power On Self Test) process. When the message of “Press DEL to enter SETUP” appears on the screen, press the key of [Delete] to enter the setup menu.

NOTE: If the message disappears before you respond and you still wish to enter Setup, restart the system by turning it OFF and On. You may also restart the system by simultaneously pressing [Ctrl+ Alt+ Delete].

The Setup Utility main menu then appears:

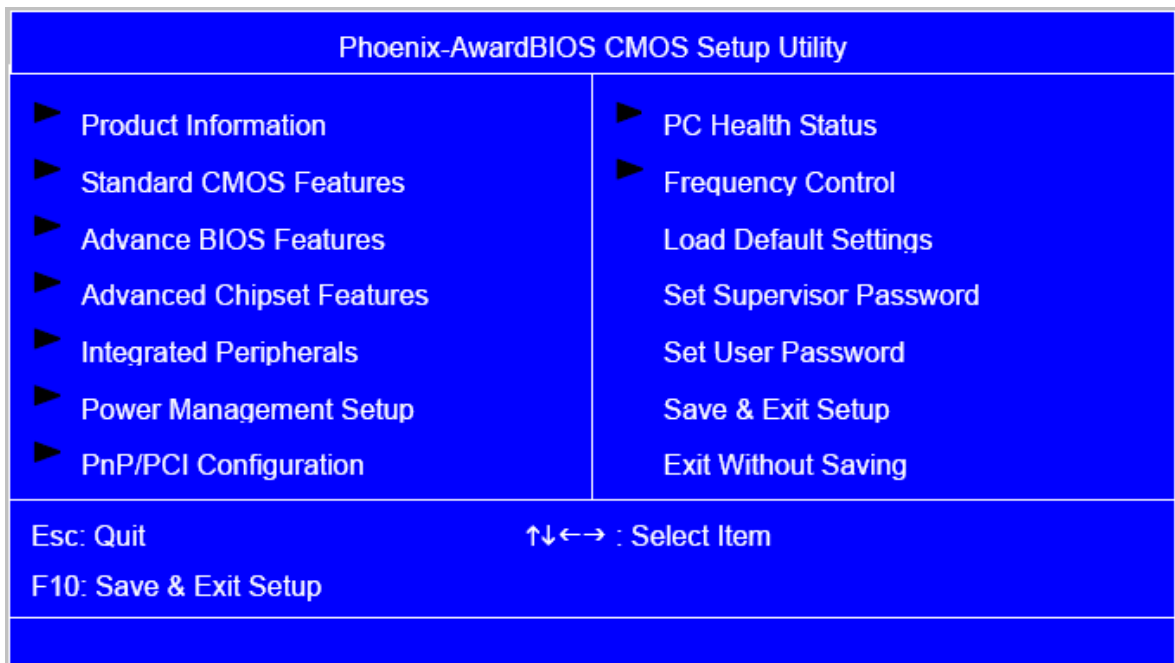

The items in the main menu are explained below:

Parameter	Description
Production Information	This page shows the relevant information of the main board
Standard CMOS Features	This setup page includes all the items in standard compatible BIOS
Advance BIOS Features	This setup page includes all the items of Award special enhanced features
Advance Chipset Features	This setup page includes all advanced chipset features
Integrated Peripherals	This setup page includes all onboard peripherals
Power Management Setup	This setup page includes all the items of Green function features
PnP/PCI Configuration	This setup page includes all configurations of PCI & PnP ISA resources
PC Health Status	This setup page is the System auto detect Temperature, voltage, and fan speed
Load Optimized Defaults	Load Optimized Settings Default Settings indicates the value of the system parameters which the system would be in best performance configuration
Set Supervisor Password	Change, set or disable password. It allows you to limit access to the system and Setup, or just to Setup
Set User Password	Change, set or disable password. It allows you to limit access to the System
Save & Exit Setup	Save CMOS value settings to CMOS and exit setup
Exit Without Saving	Abandon all CMOS value changes and exit setup

Product Information

The screen below appears if you select Product Information from the main menu: The Product Information menu contains general data about the system, such as the product name, serial number, BIOS version, etc. This information is necessary for troubleshooting (maybe required when asking for technical support).

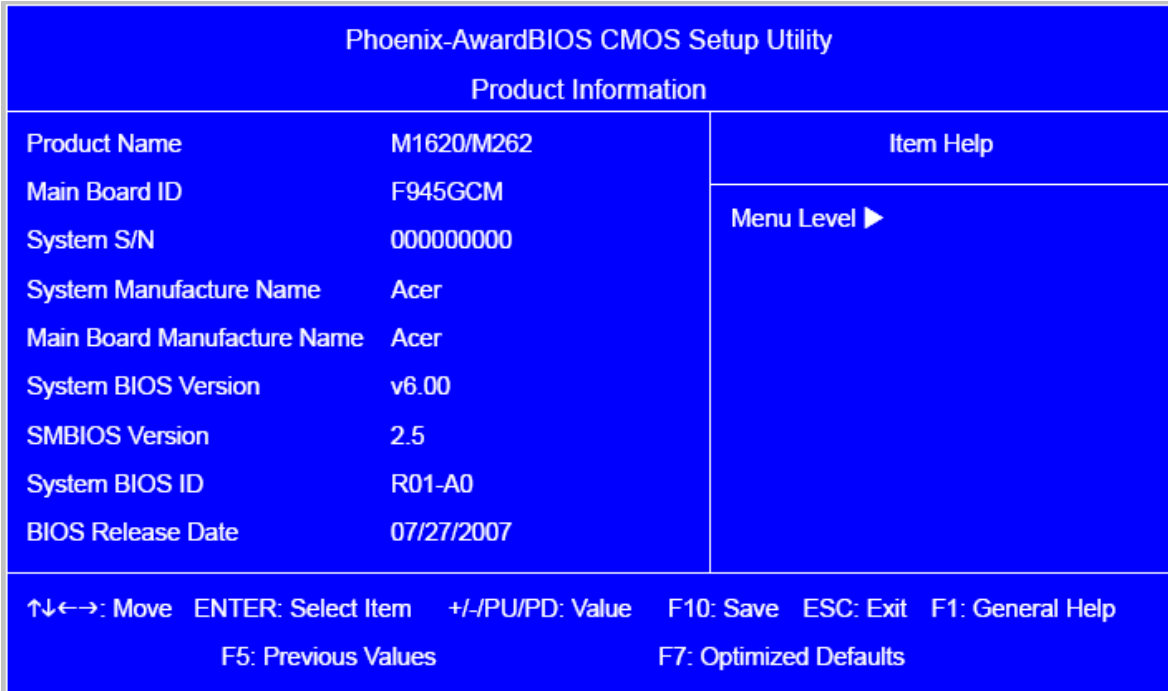

The screenshot shows the Phoenix-Award BIOS CMOS Setup Utility interface. The title bar reads "Phoenix-AwardBIOS CMOS Setup Utility" and the menu title is "Product Information". The main display area is a table with two columns: the left column lists system parameters and their values, and the right column is labeled "Item Help" and currently shows "Menu Level ▶". At the bottom, a status bar provides navigation instructions: "↑↓←→: Move ENTER: Select Item +/-/PU/PD: Value F10: Save ESC: Exit F1: General Help F5: Previous Values F7: Optimized Defaults".

Phoenix-AwardBIOS CMOS Setup Utility	
Product Information	
Product Name	M1620/M262
Main Board ID	F945GCM
System S/N	000000000
System Manufacture Name	Acer
Main Board Manufacture Name	Acer
System BIOS Version	v6.00
SMBIOS Version	2.5
System BIOS ID	R01-A0
BIOS Release Date	07/27/2007

↑↓←→: Move ENTER: Select Item +/-/PU/PD: Value F10: Save ESC: Exit F1: General Help
F5: Previous Values F7: Optimized Defaults

The following table describes the parameters found in this menu:

Parameter	Description
Production Name	This item lists the product name
System S/N	This item lists the system serial number
Main Board ID	This item lists the main board ID
Main Board S/N	This item lists the main board serial number
System BIOS Version	This item lists the system BIOS version
SMBIOS Version	This item lists the system SMBIOS version
System BIOS ID	This item lists the system BIOS ID
BIOS Release Date	This item lists the BIOS release date

Standard CMOS Setup

Select standard CMOS features from the main menu to configure some basic parameters in your system the following screen shows the standard CMOS features menu:

Phoenix-AwardBIOS CMOS Setup Utility		
Standard CMOS Features		
Day- Date (MM:DD:YY)	Fri, Aug 3 2007	Item Help
System Time	11:54:33	
Base Memory Size	640K	
Extended Memory Size	456704K	Menu Level ▶
Total Memory Size	457344	
▶ IDE Channel 0 Master	[None]	Change the day, month, year and the century
▶ IDE Channel 0 Slave	[None]	
▶ IDE Channel 1 Master	[None]	
▶ IDE Channel 1 Slave	[ST3250820AS]	
▶ IDE Channel 2 Slave	[MATSHITAUJ-845D]	
▶ IDE Channel 3 Slave	[None]	
▶ IDE Channel 4 Slave	[None]	
▶ IDE Channel 5 Slave	[None]	
Video Setting	[EGA/VGA]	
Halt on Setting	[All, But Keyboard]	

↑↓←→: Move ENTER: Select Item +/-/PU/PD: Value F10: Save ESC: Exit F1: General Help
F5: Previous Values F7: Optimized Defaults

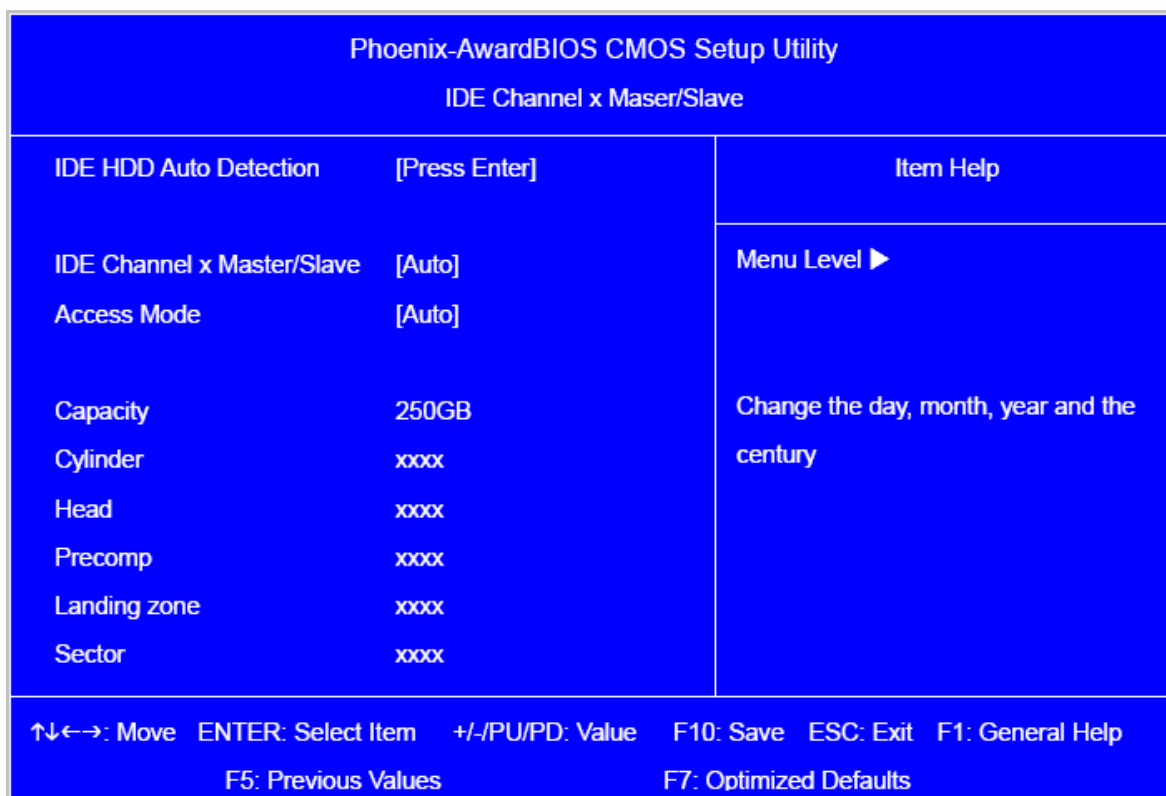

The following table describes the parameters found in this menu.

Parameter	Description	Options
Date	To set the date following the weekday-month-date-year format	Week: From [Sun.] to [Sat.], determined by BIOS and is display only Day: from [1] to [31] (or the maximum allowed in the month. Year: from 1999 to 2099
System Time	To set the time following the hour-minute-second format	The items format is [hour] [minute][second]. The time is calculated base on the 24-hour timer clock.
Base Memory Size	640 K for system base memory	

Parameter	Description	Options
Extended Memory Size	The BIOS determines how much extended memory is present during the POST. This is the amount of memory located above 1MB in the memory address map of CPU	
Total Memory Size	Total memory size for the system	
IDE Channel X Master IDE Channel X Slave	Hard disk drive connected to channel X master or slave port. To enter the IDE Master or Slave setup, press [Enter]. The IDE CD-ROM is always automatically detected	[Enter] for detection options [Auto]: BIOS automatically detects IDE devices during POST (default) [None]: No IDE devices are used and the system will skip the automatic detection step and allow for faster system start up [Manual]: Manually input the correct settings [Access Mode]: To set the access mode for the hard drive. The four options are: CHS/LBA/Large/Auto (default: Auto) Cylinder: Number of cylinders Head: Number of heads Precomp: Write precomp Landing Zone: Landing Zone Sector: Number of sectors
Video Setting	Select the type of primary video subsystem	
Halt on	This item enables use to select the situation if the BIOS stops the POST process and the notification	All Errors No Errors All, But Keyboard All, But Diskette All, But Disk/Key

Advanced Setup

The following screen shows the Advanced Setup:

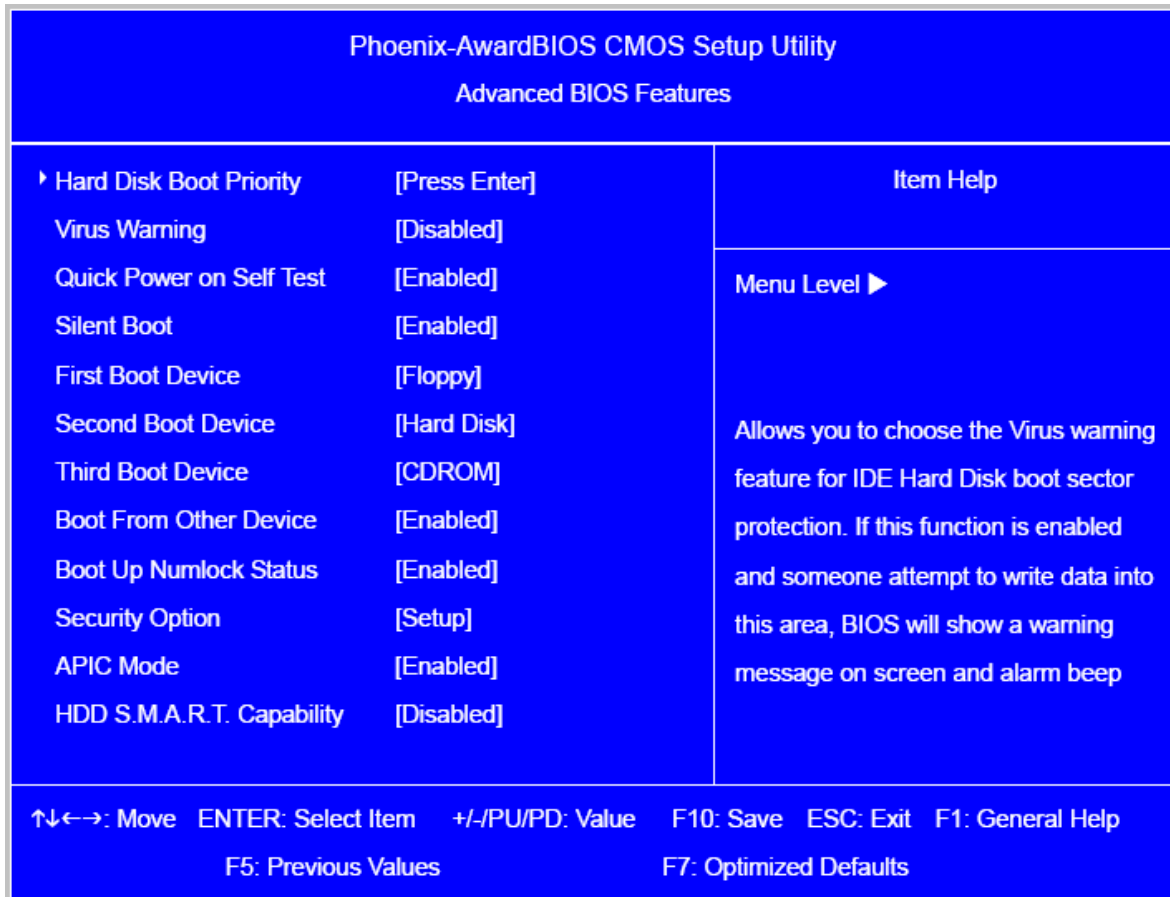

The following table describes the parameters found in this menu.

Parameter	Description	Options
Hard Disk Boot Priority	This features displays the Hard Disk Boot Device priority from high to low and allows users to set the Hard Disk Boot Device Priority. Press [Enter] to enter the setting screen. Use wory to select a device, then press <+> to move it up, or <-> to move it down the list. Press <ESC> to exit.	[Press Enter]

Parameter	Description	Options
Virus Warning	This feature allows you to enable the VIRUS warning function for IDE Hard Disk boot sector protection. If this function is enabled and there is someone attempts to write data to this area, BIOS will show a warning message on screen and the alarm will beep.	[Enabled], [Disabled]
Quick Power On Self Test	This feature allows the system to skip certain tests while booting. When this function is enabled, it will decrease the time needed to boot the system, which means to quick power on self-test function.	[Enabled], [Disabled]
Silent Boot	This feature allows you to enable or disable if the screen logo to display or not during POST	[Enabled], [Disabled]
First/Second/Third Boot Device	The item allows you to see the sequence of boot device where BIOS attempts to load the disk operation system.	[Floppy], [LS120], [Hard Disk], [CD-ROM], [ZIP], [USB-FDD], [USB-ZIP], [USB-CDROM], [USB-HDD], [LAN], [Disabled]
Boot From Other Devices	This item allows user to enable or disable to boot from other device	[Enabled], [Disabled]
Boot Up NumLock Status	This item allows user to enable or disable to set keyboard is number keys or arrow keys	[Enabled], [Disabled]
Security Option	This category allows you to limit access to the system and Setup, or just to Setup.	[System], [Setup]
APIC Mode	This option is used to set up enable or disable the APCI function	[Enabled], [Disabled]
HDD S.M.A.R.T Capability	S.M.A.R.T. which allows your hard disk to report any read/write errors and issue a warning when LDCM installed	[Enabled], [Disabled]

Advanced Chipset Setup

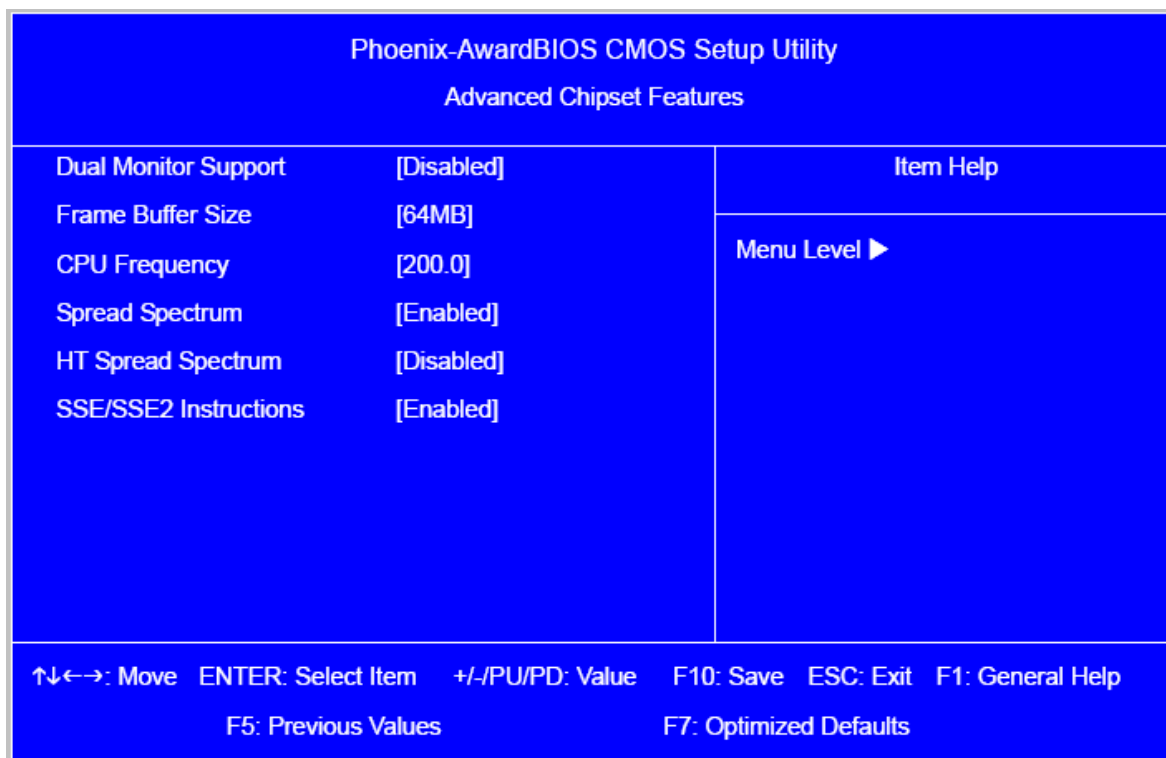

The following table describes the parameters found in this menu.

Parameter	Description	Options
Dual Monitor Support	This category allows you to enable or disable dual monitor support function	[Enabled], [Disabled]
Frame Buffer Size	This field displays how much frame buffer size of the system.	
CPU Frequency	This field allows you to determine CPU frequency of the system.	

Parameter	Description	Options
Spread Spectrum	When the system clock generator pulses, the extreme values of the pulse generate excess EMI. Enabling pulse spectrum spread modulation changes the extreme values from spikes to flat curves, thus reducing EMI. This benefit may in some case be outweighed by problems with timing-critical devices, such as a clock-sensitive SCSI device.	[Enabled], [Disabled]
HT Spread Spectrum	Enables or Disables HT Spread Spectrum. HT is Hyper Transport between CPU and North Bridge.	[Enabled], [Disabled]
SSE/SSE2 Instructions	This feature controls the availability of the processor's SSE and SSE2 instruction sets. When enabled, the processor's SSE and SSE2 instruction sets are enabled. Software applications can make use of those instructions to better process large amounts of data quickly. When disabled, the processor's SSE and SSE2 instruction sets are disabled. Software applications will not be able to use those instructions to process multiple data elements simultaneously. However, the processor's MMX instruction set will still be available for use. It is highly recommended that you leave this BIOS feature at the default setting.	[Enabled], [Disabled]

Integrated Peripherals

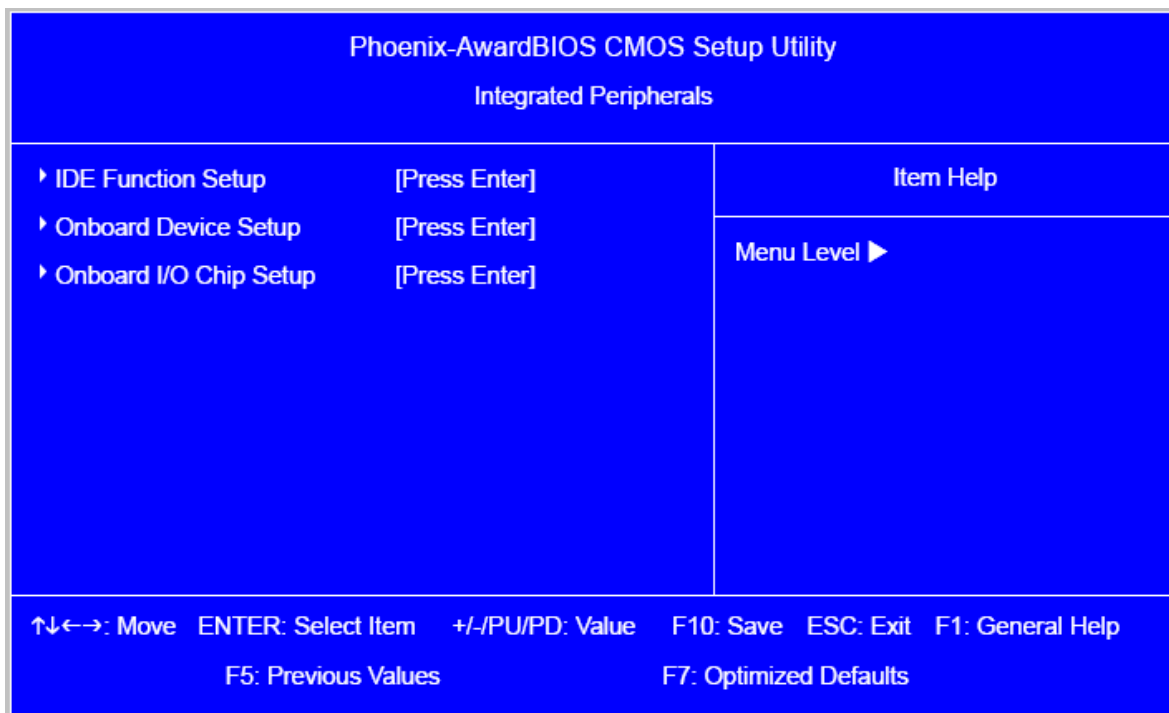

The following table describes the parameters found in this menu.

Parameter	Description	Options
IDE Function Setup	This page allows you to setup IDE function	[Press Enter]
Onboard Device Setup	This page allows you to setup onboard devices.	[Press Enter]
Onboard I/O Chip Setup	This page allows you to setup onboard I/O chip.	[Press Enter]

Integrated Peripherals-IDE Function Setup

Phoenix-AwardBIOS CMOS Setup Utility		
IDE Function Setup		
OnChip IDE Channel0	[Enabled]	Item Help
Primary Master	PIO [Auto]	Menu Level ►
Primary Slave	PIO [Auto]	
Primary Master	UDMA [Auto]	
Primary Slave	UDMA [Auto]	
OnChip IDE Channel1	[Enabled]	
Primary Master	PIO [Auto]	
Primary Slave	PIO [Auto]	
Primary Master	UDMA [Auto]	
Primary Slave	UDMA [Auto]	
IDE DMA Transfer Access	[Enabled]	
SATA 1	[Enabled]	
SATA 2	[Enabled]	
IDE Prefetch Mode	[Enabled]	
IDE HDD Block Mode	[Enabled]	
SATA Port Speed Settings	[Auto]	

↑↓←→: Move ENTER: Select Item +/-/PU/PD: Value F10: Save ESC: Exit F1: General Help
 F5: Previous Values F7: Optimized Defaults

The following table describes the parameters found in this menu.

Parameter	Description	Options
IDE Primary/Secondary Master/Slave PIO	The four IDE PIO fields let you set a PIO mode (0-4) for each of the four IDE devices that the onboard IDE interface supports. Modes 0 through 4 provide increased performance. In Auto mode, the system automatically determines the best mode for each device.	
On-Chip IDE First/Second Channel	The Chipset contains a PCI IDE interface with support for two IDE channels. Select Enabled to activate the first and/or second IDE interface. Select Disabled to deactivate an interface, if you install a primary and/or secondary add-in IDE interface.	[Enabled], [Disabled]
IDE Primary/Secondary Master/Slave UDMA	UDMA (Ultra DMA) is a DMA data transfer protocol that utilized ATA transfer protocol that utilizes ATA commands and the ATA bus to allow DMA commands to transfer data at a maximum burst rate of 33 MB/s. When you select Auto in the four IDE UDMA fields (for each of up to four IDE devices that the internal PCI IDE interface supports), the system automatically determines the optimal data transfer rate for each IDE device.	
IDE DMA Transfer Access	This category allows you to enable or disable DMA transfer access of IDE device (or IDE HDD)	[Enabled], [Disabled]
SATA 1/2	Enable/Disable Serial-ATA 1 or Serial-ATA-2. SATA 1 control port 1 and 3, SATA 2 control port 2 and 4.	
IDE Prefetch Mode	The onboard IDE drive interfaces supports IDE prefetching, for faster drive accesses. If you install a primary and/or secondary add-in IDE interface, set this field to Disabled if the interface does not support prefetching.	

Parameter	Description	Options
IDE HDD Block Mode	Block mode is also called block transfer, multiple commands, or multiple sectors read/write. If your IDE hard drive supports block mode(most new drives do), select Enabled for automatic detection of the optimal number of block read/write per sector the drive can support.	[Enabled], [Disabled]
SATA PORT Speed Settings	This category allows you to determine the speed of SATA port.	[Auto],

Integrated Peripherals-Onboard Device Setup

Phoenix-AwardBIOS CMOS Setup Utility		
Onboard Device Setup		
OnChip USB	[V1.1+V2.0]	Item Help
USB Memory Type	[SHADOW]	Menu Level ▶
USB KB Legacy Support	[Enabled]	
USB Mouse Legacy Support	[Enabled]	
AC97 Audio	[Auto]	
MAC Lan	[Auto]	
MAC Lan Boot ROM	[Disabled]	
↑↓←→: Move ENTER: Select Item +/-/PU/PD: Value F10: Save ESC: Exit F1: General Help F5: Previous Values F7: Optimized Defaults		

The following table describes the parameters found in this menu.

Parameter	Description	Options
On Chip USB	This field allows you to determine on chip USB type or disable on chip USB.	[V1.1+V2.0], [V1.1]
UDB Memory Type	Use this item to change the type of USB memory to shadow or Base memory.	[Shadow], [Base Memory]
USB KB Legacy Support	This field enables or disables USB keyboard support function.	[Enabled], [Disabled]
USB Mouse Support	This field enables or disables USB mouse support function.	[Enabled], [Disabled]
AC 97 Audio	Change the on board Audio to auto or disabled	[Auto], [Disable]
MAC LAN	Enables or disables onboard LAN controller, If you wish to use the motherboard's onboard LAN controller, you should certainly enable this BIOS feature. You can disable this feature if you do not want to use the motherboard's onboard LAN controller. This may free up an IRQ for other devices to use. This is useful if your motherboard does not support APIC and have many devices that can not share IR Qs.	[Enabled], [Disabled]
MAC LAN Boot ROM	Enables or disables on board LAN boot ROM.	[Enabled], [Disabled]

Integrated Peripherals -Onboard I/O Chip Setup

Setup

Phoenix-AwardBIOS CMOS Setup Utility		
Onboard I/O Chip Setup		
Onboard FDC Controller	[Enabled]	Item Help
Onboard Serial Port 1	[3F8/IRQ4]	Menu Level ▶
UART Mode Select	[IrDA]	
UR2 Duplex Mode	[Halt]	
Onboard Parallel Port	[378/IRQ7]	
Parallel Port Mode	[SPP]	
ECP Mode Use DMA	[3]	
↑↓←→: Move ENTER: Select Item +/-/PU/PD: Value F10: Save ESC: Exit F1: General Help F5: Previous Values F7: Optimized Defaults		

The following table describes the parameters found in this menu.

Parameter	Description	Options
Onboard FDC Controller	Select Enabled if your system has a floppy disk controller (FDC) installed on the system board and you wish to use it. If you install an add-in FDC or the system has no floppy drive, select Disabled in this field.	[Enabled]. [Disabled]
Onboard Serial Port 1	Select a logical COM port name and matching address for the serial port. Select an address and corresponding interrupt for the serial port.	
UR2 Duplex Mode	In an infrared port mode, this field appears. Full-duplex mode permits simultaneous two-direction transmission. Half-duplex mode permits transmission in one direction only at a time. Select the value required by the IR device connected to the IR port.	
Onboard Parallel Port	Select a logical LPI port address and corresponding interrupt for the physical parallel port.	[xxx+IRQx]
Parallel Port Mode	Select an operating mode for the onboard parallel (printer) port.	[Normal], [EPP], [EPP], [EPP+ECP]
ECP Mode used DMA	This item allows users to manually set the DMA channel for ECP mode	

Power Management

The Power Management menu lets you configure your system to most effectively save energy while operating in a manner consistent with your own style of computer use. The following screen shows the Power Management parameters and their default settings:

Phoenix-AwardBIOS CMOS Setup Utility		
Power Management Setup		
		Item Help
ACPI Function	[Enabled]	
ACPI Suspend Type	[S3(STR)]	
Video off Method	[DPMS Support]	
HDD Power Down	[Disabled]	Menu Level ►
HDD Down In Suspend	[Disabled]	
Soft-Off by PWR-BTTN	[Delay 4 Sec]	
WOL (PME#) From Soft-Off	[Disabled]	
X WOR (R1#) From Soft-Off	Disabled	
USB Resume from S1/S3	[Disabled]	
Resume by Alarm	[Disabled]	
X Date of Month Alarm	0	
X Time(hh:mm:ss) Alarm	00:00:0	
POWER ON function	[BUTTON ONLY]	
PWRON After PWR-Fail	[Former-Sts]	

↑↓←→: Move ENTER: Select Item +/-/PU/PD: Value F10: Save ESC: Exit F1: General Help
F5: Previous Values F7: Optimized Defaults

The following table describes the parameters found in this menu.

Parameter	Description	Options
ACPI Function	This item allows you to enable or disable the ACPI function	[Enabled], [Disabled]
ACPI Suspend Type	This item specifies the power saving modes for ACPI function. S1 (POSP): The S1 sleep mode is a low power state.. In this state, no system context (SPU or chipset) is lost and hardware maintains all system context/ S3 (STR): The S3 sleep mode is a power-down state in which power is supplied only to essential components such as main memory and wake-capable devices and all system context is saved to main memory. The information stored in memory will be used to restore the PC to the previous state when an wake-up event occurs.	[S1 (POS)]: Set ACPI suspend type to S1/POS (Power On Suspend). [S3 (STR)]: Set ACPI suspend type to S3/STR
HDD Power Down	The setting controls how long a hard disk drive must be left idle before it spins down.	[Disabled], [Standby], [Suspend]
HDD Down In Suspend	Enables or Disables the functionality of HDD down in suspend	[Enabled], [Disabled]

Parameter	Description	Options
Soft-off by PWR/BTTN	When Enabled, turning the system off with the on/off button places the system in a very low-power-usage state, with only enough circuitry receiving power to detect power button activity or Resume by Ring activity.	[Instant-off]: Press down button then power off instantly [Delay 4 Sec.]: Press Power button 3 sec. to power off. Enter suspend if button is pressed less than 4 sec.
WOL (PME#) From Soft-Off	This category enables or disables wake-on-Lan from soft-off	[Enabled], [Disabled]
Resume by Alarm	You can set "Resume by Alarm" item to enabled and key in Date/Time to power on system.	[Disabled] [Enabled]: Enable alarm function to Power On system. If RTC Alarm Lead to Power On is Enabled, Date(of Month) Alarm: Everyday, 1~31 Time(hh:mm:ss) Alarm: (0~23):(0-59):(0~59)
POWER ON Function	Select the method to power on the system	[Button Only], [Keyboard 98], [Hot Key], [Mouse Left], [Mouse Right]
POWER After PWR-Fail	This field allows you to determine the power status to on/off or former-sts after the system	[FORMER-Sts], [On], [Off]

PCI/PnP Setup

Phoenix-AwardBIOS CMOS Setup Utility		
PnP/PCI Configuration		
Init Display First	[PCIEx]	Item Help
Reset Configuration Data	[Disabled]	
Resources Controlled By	[Auto(ESCD0)]	Menu Level ►
X IRQ Resources	Press Enter	
PCI/VGA Palette Snoop	[Disabled]	
** PCI Express relative items**		
Maximum Payload Size	[4096]	

↑↓←→: Move ENTER: Select Item +/-/PU/PD: Value F10: Save ESC: Exit F1: General Help
F5: Previous Values F7: Optimized Defaults

The following table describes the parameters found in this menu.

Parameter	Description	Options
Init Display First	Initialize the AGP video display before initializing any other display device on the system. Thus the AGP display becomes the primary display.	
Reset Configuration Data	Normally, you leave this field Disabled. Select Enabled to reset Extended System Configuration Data (ESCD) when you exit Setup if you have installed a new add-on and the system reconfiguration has caused such a serious conflict that the operating system cannot boot	[Enabled], [Disabled]
Resources Controlled By	This item allows user to assign PnP resource (I/O address, IRQ&DMA channels) for Plug and Play compatible devices automatically or manually	[Auto] [Manual]
IRQ Resources	When resource are controlled by manually, assign each system interrupt a type , depending on the type of device using the interrupt. Option: [PCI Device]: Assign this IRQ for PCI device. [Reserved]: Reserve this IRQ for other device.	[Press Enter]
PCI/VGA Palette Snoop	This option is only very rarely needed. It should be left at "Disabled" unless a video device specifically requires the setting enabled upon installation.	[Disabled], [Enabled]
Maximum Payload Size	This field displays maximum payload size of the system	[128-4096]
PCI 1/2 IRQ Assignment	This item allows user to assign PCI IRQ for device	[Auto], [3] , [4] , [5] , [6] , [7], [10] , [11] , [12] , [14] , [15]

PC Health Status

Phoenix-AwardBIOS CMOS Setup Utility

PC Health Status

CPU Vcore	1.21V	Item Help
+3.3V	3.34V	
+5V	4.94V	
+12V	11.90V	Menu Level ▶
+5USB	5.16V	
Voltage Battery	2.92V	
Current CPU Temperature	49°F	
Current SYSTEM Temperature	40°C	
CPU FAN Speed	2900 RPM	
System FAN Speed	0 RPM	

↑↓←→: Move ENTER: Select Item +/-/PU/PD: Value F10: Save ESC: Exit F1: General Help
F5: Previous Values F7: Optimized Defaults

The following table describes the parameters found in this menu:

Parameter	Description	Options
V core	Detect system's voltage status automatically	
CPU Temperature	Detect CPU Temperature automatically	
CPU/SYSTEM FAN Speed (RPM)	Detect CPU/SYSTEM Fan Speed Status automatically	
CPU Smart FAN Control	The item displays the system Smart Fan Function status. It is always enabled by system.	

Frequency/Voltage Control

CMOS Setup Utility - Copyright (C) 1985-2005,American Megatrends,Inc. Frequency/Voltage Control	
Manufacturer: Intel	Help Item
Ratio Status: Unlocked (Min:06,Max:10)	
Ratio Actual Value: 10	Options
CPU Frequency : 266MHz	Disabled
Auto Detect DIMM/PCI CLK Enabled	Enabled
Spread Spectrum Enabled	
↑↓←→ :Move Enter: Select +/-:Value F10:Save ESC:Exit F1:General Help F9:Optimized Defaults	

The following table describes the parameters found in this menu:

Parameter	Description	Options
Auto Detect DIMM/PCI CLK	This option allows you to enable/disable the feature of auto detecting the clock frequency of the installed PCI bus.	Enabled Disabled
Manufacturer	This item specifies CPU Manufacturer	Intel
CPU frequency	This item specifies CPU frequency	266MHz
Spread Spectrum	When the motherboard's clock generator pulses, the extreme values (spikes) of the pulses create EMI (Electromagnetic Interference). The spread Spectrum function reduces the EMI generated by modulating the pulses so that the spikes of the pulses are reduced to flatter curves. If you do not have any EMI problem, leave the setting at Disabled for optimal system stability and performance. But if you are plagued by EMI, setting to Enabled for EMI reduction. Remember to disable Spread Spectrum if you are overlooking because even a slight jitter can introduce a temporary boost in clock speed which may just cause your over locked processor to lock up.	Enabled

Load Default Settings

This option opens a dialog box that lets you install defaults for all appropriate items in the Setup Utility.

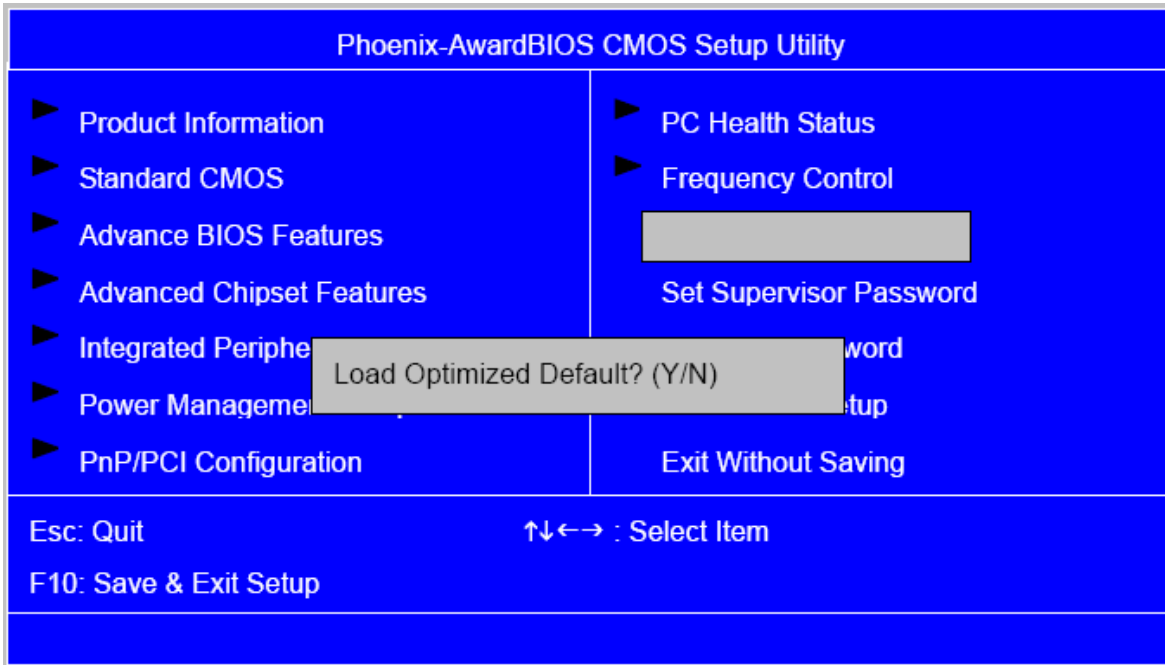

Parameter	Description	Options
Load Default Settings	Select the field loads the factory defaults for BIOS and Chipset Features, which the system automatically detects. This option opens a dialog box that lets you install optimized defaults for all appropriate items in the Setup Utility.	

Set Supervisor/User Password

When this function is selected, the following message appears at the center of the screen to assist you in creating a password.

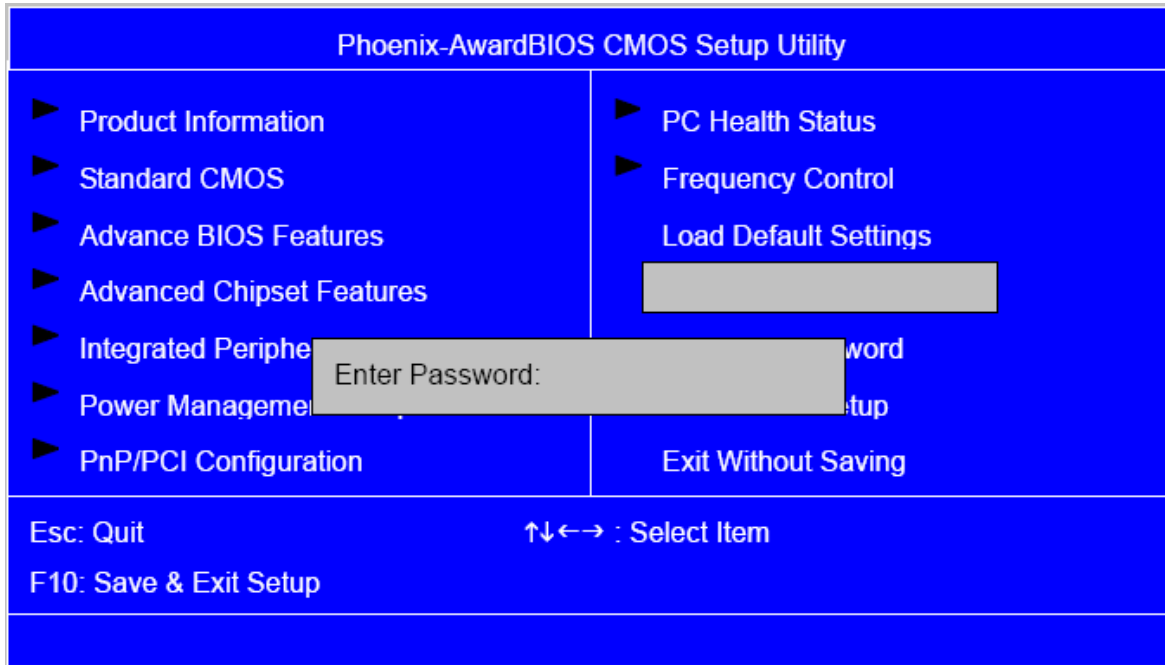

Parameter	Description	Options
Set Supervisor/User Password	<p>When this function is selected, the following message appears at the center of the screen to assist you in creating a password.</p> <p>ENTER PASSWORD</p> <p>Type the password, up to eight characters, and press<Enter>. The password typed now will clear any previously entered password from CMOS Memory. You will be asked to confirm the password. Type the password again and press <Enter>. You may also press<ESC> to abort the selection.</p> <p>PASSWORD DISABLED</p> <p>To disable password, just press<Enter> when you are prompted to enter password with empty. A message will confirm the password being disabled.</p> <p>If you have selected “System” in “Security Option” of “BIOS Feature Setup” menu, you will be prompted for the password every time the system reboots or any time you try to enter BIOS Setup. If you have selected “Setup” at “Security Option” from “BIOS Features Setup” menu, you will be prompted for the password only when you enter BIOS Setup.</p> <p>Supervisor Password has higher priority than User Password. You can use Supervisor Password when booting the system or entering BIOS Setup to modify all settings.</p>	

Save & Exit Setup

Highlight this item and press <Enter> to save the changes that you have made in the Setup Utility and exit the Setup Utility.

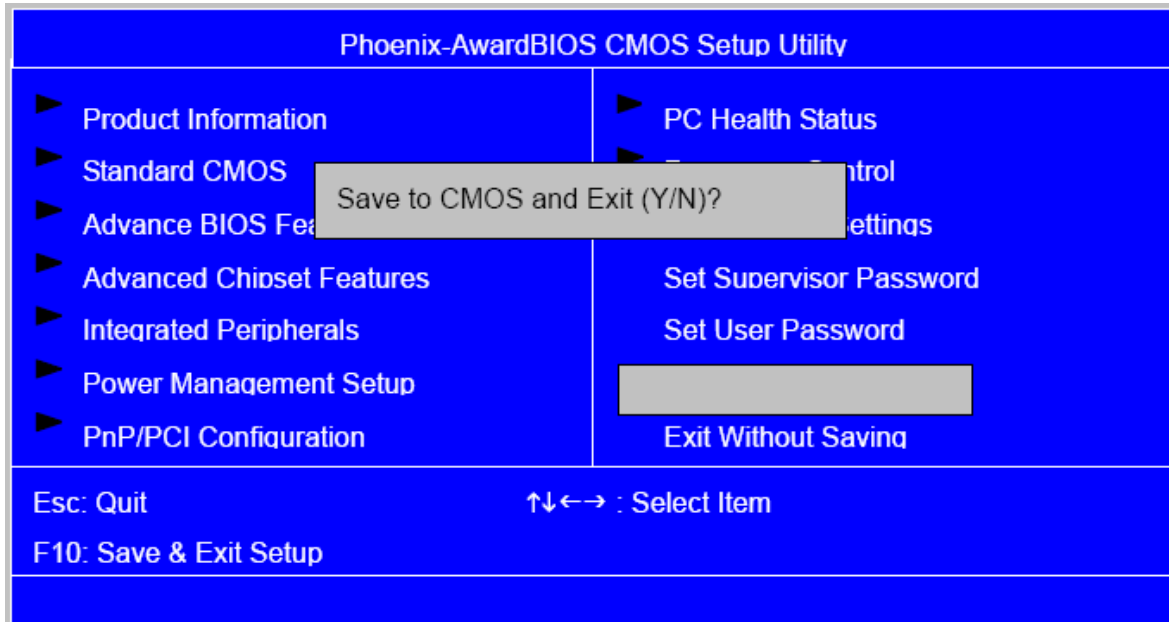

Parameter	Description	Options
Save & Exit Setup	Press <Enter> to save the changes that have made in the Setup Utility and exit the Setup Utility. Press<Y> to save and Exit or <N> to return to the main menu.	

Exit Without Saving

Highlight this item and press <Enter> to discard any changes that you have made in the Setup Utility and exit the Setup Utility.

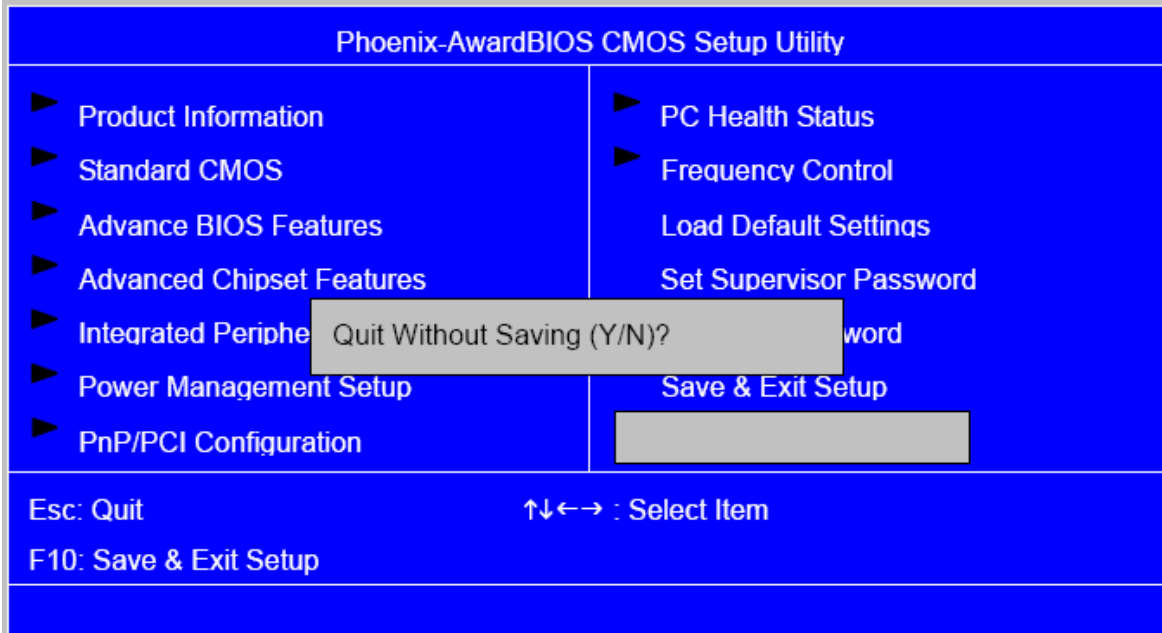

Parameter	Description	Options
Exit Without Saving	Press<Enter> to discard any changes and exit the Setup Utility	

Machine Disassembly and Replacement

To disassemble the computer, you need the following tools:

Wrist grounding strap and conductive mat for preventing electrostatic discharge.

Wire cutter.

Phillips screwdriver (may require different size).

NOTE: The screws for the different components vary in size. During the disassembly process, group the screws with the corresponding components to avoid mismatches when putting back the components.

General Information

Before You Begin

Before proceeding with the disassembly procedure, make sure that you do the following:

1. Turn off the power to the system and all peripherals.
2. Unplug the AC adapter and all power and signal cables from the system

Disassembly Procedure

This section tells you how to disassemble the system when you need to perform system service. Please also refer to the disassembly video, if available.

CAUTION: Before you proceed, make sure you have turned off the system and all peripherals connected to it.

Aspire M1620 Standard Disassembly Process

Opening the System

1. Place the system unit on a flat, steady surface.



2. Turn the housing down, slide the Lock-handle as shown , meanwhile slide the left side door out .



Remove the ADD ON Cards

1. Release the PCI-Lock as shown bellow, then remove it.



2. Release the VGA-slot Lock shown bellow, then pull out the VGA Card.



3. Remove the Modem card.



Remove the Cables

1. Disconnect the AUDIO cable from the MB "AUDIO".



2. Disconnect the USB and Card-reader cables from the MB connector "F_USB1, F_USB2".

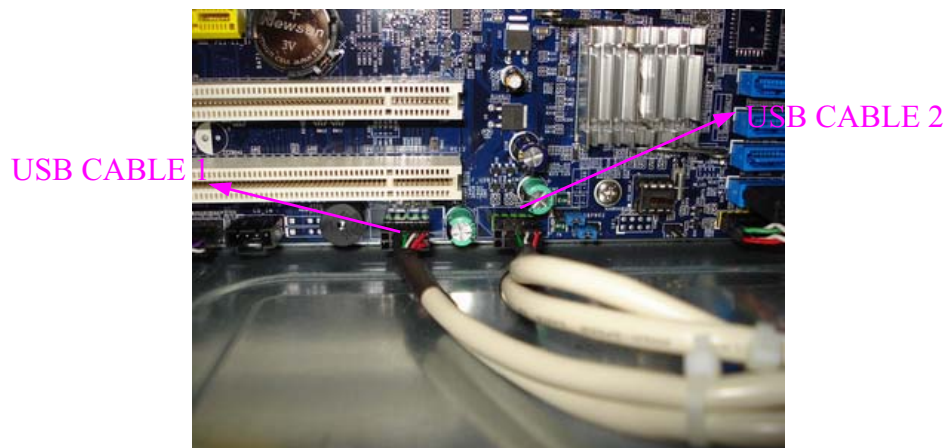

-
3. Disconnect the LED cable ASSY from the MB Connector “F_PANEL”.

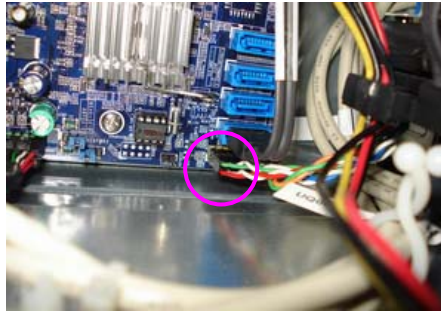

4. Disconnect the 12V power cable “PD” from the MB Connector.

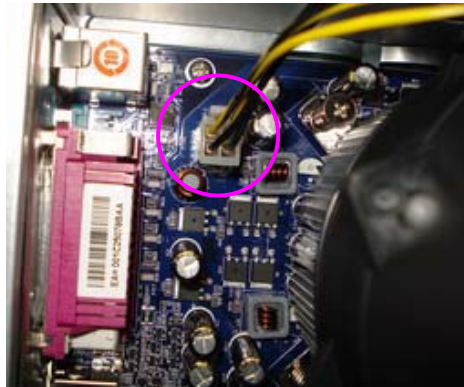

5. Disconnect the CPU fan power cable from the MB Connector “CPU_FAN”.



6. Disconnect the 4 Pin power cable “PE” from the ODD.



7. Disconnect the ODD IDE cable from the ODD.



7-1. Disconnect the FDD IDE cable from the FDD.



8. Disconnect the FDD power cable from the FDD.



9. Disconnect the power cable from the HDD.



10. Disconnect the HDD DATA cable from the HDD.



11. Disconnect the P1 power cable from the MB connector.

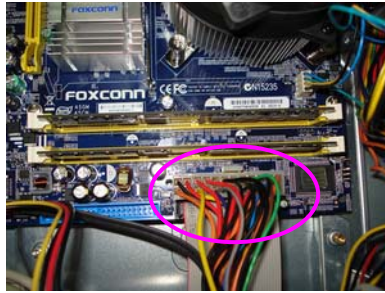

12. Disconnect the FDD IDE cable from the MB connector.



13. Disconnect the ODD IDE cable from the MB connector.



14. Disconnect the HDD DATA cable from the MB connector.

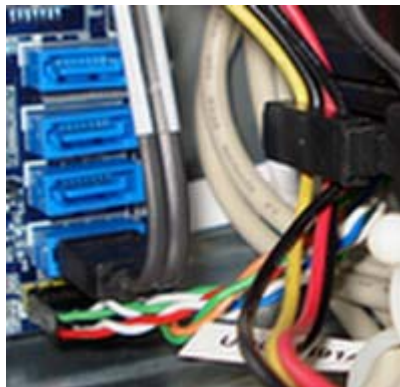

Remove the front bezel

Release the three latches on the front bezel, then remove the front bezel.



Remove the CD-ROM, Floppy, Card-reader and HDD

1. Release the ODD-Holder, meanwhile pull the ODD out of the chassis.

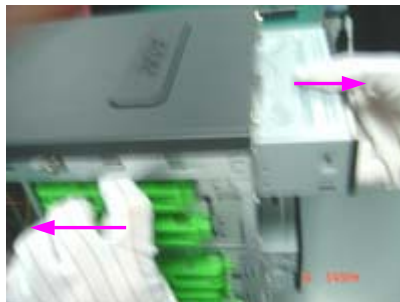

2. Release the FDD-Holder1, meanwhile pull the FDD out of the chassis.

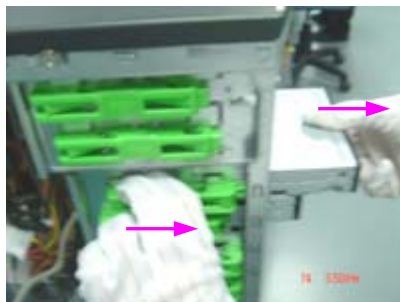

3. Release the FDD-Holder2, meanwhile pull the Card-reader Module out of the chassis.



-
4. Release the HDD-Holder, meanwhile pull the HDD out of the chassis.

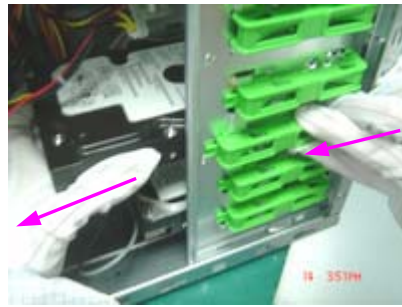

Remove the Memory

Loose the DIMM Latch and pop out the two memory shown bellow.



Remove the Heatsink module.

Remove the four screws shown bellow , then remove the Heatsink.



Removing the USB Module

Remove the screw as shown bellow, detach the USB Module, then pull down the USB&Audio cable from the USB board.



Remove the Mainboard

Remove the five screws and remove the Mainboard shown bellow.



Remove the CPU from the MB

Release the CPU latch, then remove the CPU from the MB.



Remove the Power-supply

Remove the four screws shown bellow and remove the Power-supply.



VeritonM262 Standard Disassembly Process

Opening the System

3. Place the system unit on a flat, steady surface.



4. Turn the housing down, slide the Lock-handle as shown , meanwhile slide the left side door out .



Remove the ADD ON Cards

4. Release the PCI-Lock as shown bellow, then remove it.



5. Release the VGA-slot Lock shown bellow, then pull out the VGA Card.



6. Remove the Modem card.



Remove the Cables

15. Disconnect the AUDIO cable from the MB "AUDIO".



16. Disconnect the USB and Card-reader cables from the MB connector "F_USB1, F_USB2".



17. Disconnect the LED cable ASSY from the MB Connector “F_PANEL”.

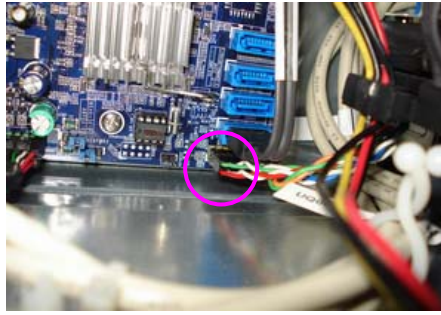

18. Disconnect the 12V power cable “PD” from the MB Connector.

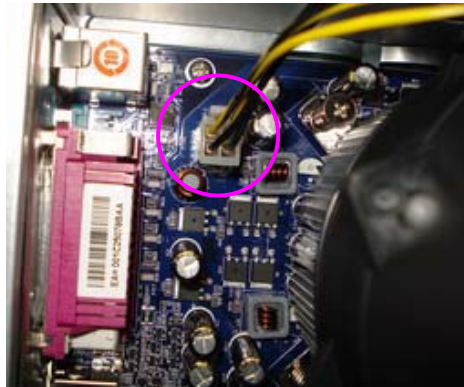

19. Disconnect the CPU fan power cable from the MB Connector “CPU_FAN”.



20. Disconnect the 4 Pin power cable “PE” from the ODD.



21. Disconnect the ODD IDE cable from the ODD.



7-1. Disconnect the FDD IDE cable from the FDD.



22. Disconnect the FDD power cable from the FDD.



23. Disconnect the power cable from the HDD.



24. Disconnect the HDD DATA cable from the HDD.



25. Disconnect the P1 power cable from the MB connector.

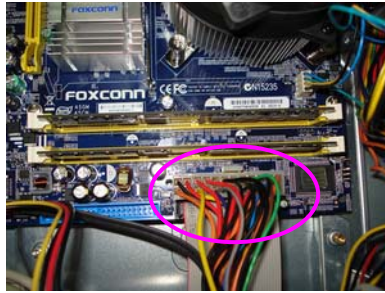

26. Disconnect the FDD IDE cable from the MB connector.

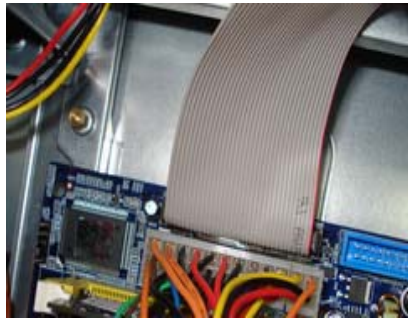

27. Disconnect the ODD IDE cable from the MB connector.

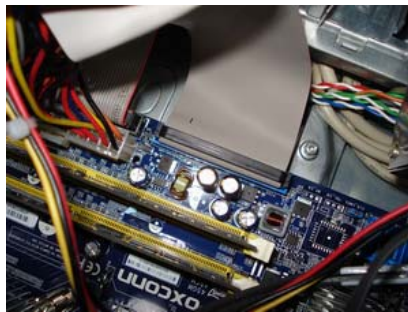

28. Disconnect the HDD DATA cable from the MB connector.

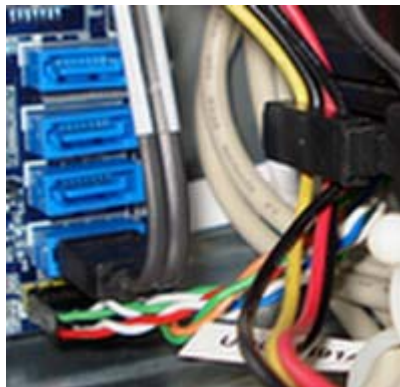

Remove the front bezel

Release the three latches on the front bezel, then remove the front bezel.



Remove the CD-ROM, Floppy, Card-reader and HDD

5. Release the ODD-Holder, meanwhile pull the ODD out of the chassis.

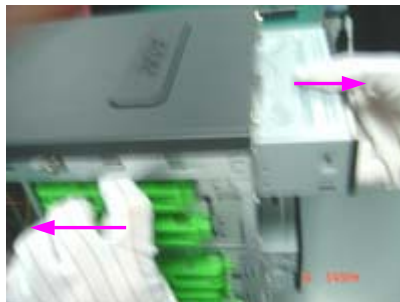

6. Release the FDD-Holder1, meanwhile pull the FDD out of the chassis.

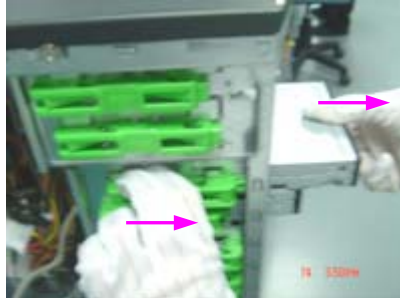

7. Release the FDD-Holder2, meanwhile pull the Card-reader Module out of the chassis.



8. Release the HDD-Holder, meanwhile pull the HDD out of the chassis.

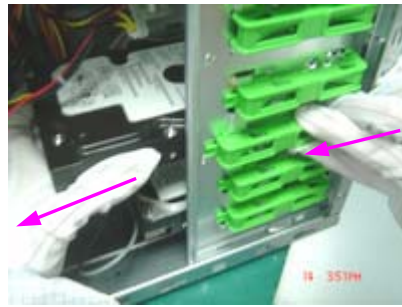

Remove the Memory

Loose the DIMM Latch and pop out the two memory shown bellow.



Remove the Heatsink module.

Remove the four screws shown bellow , then remove the Heatsink.



Removing the USB Module

Remove the screw as shown bellow, detach the USB Module, then pull down the USB&Audio cable from the USB board.



Remove the Mainboard

Remove the five screws and remove the Mainboard shown bellow.



Remove the CPU from the MB

Release the CPU latch, then remove the CPU from the MB.



Remove the Power-supply

Remove the four screws shown bellow and remove the Power-supply.



Troubleshooting

Please refer to generic troubleshooting guide for troubleshooting information relating to following topics:

- Power-On Self-Test (POST)
- POST Check Points
- POST Error Messages List
- Error Symptoms List

Jumper and Connector Information

Jumper Setting

This section explains how to set jumpers for correct configuration of the mainboard.

Setting Jumper

Use the motherboard jumpers to set system configuration options. Jumpers with more than one pin are numbered. When setting the jumpers, ensure that the jumper caps are placed on the correct pins.

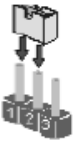
Description	Illustration
The illustrations show a 2-pin jumper. When the jumper cap is placed on both pins, the jumper is SHORT. If you remove the jumper cap, or place the jumper cap on just one pin, the jumper is OPEN.	 SHORT OPEN
This illustration shows a 3-pin jumper. Pins 1 and 2 are SHORT	

Clear CMOS

Jumper	Type	Description	Setting(Default)	Illustration
CLR_CMOS	3-pin	CLEAR CMOS	1-2 : Clear 2-3 : Normal Before clearing the CMOS,make sure to turn off the system	Clear CMOS  1

Checking Connector

CPU_FAN: CPU Cooling Fan Connector

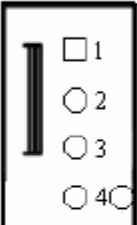
	Pin	Signal Name	Function
	1	GND	System Ground
	2	+12V	Power +12V
	3	Sense	Sensor
	4	Control	FAN Control Signal

SYS_FAN/PWR_FAN: FAN Power Connectors

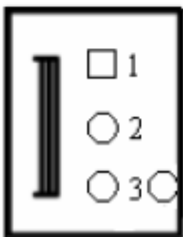
	Pin	Signal Name	Function
	1	GND	System Ground
	2	+12V	Power +12V
	3	Sense	Sensor

ATX12V: ATX 12V Power Connector

Pin	Signal Name
1	Ground
2	Ground
3	+12V
4	+12V

ATX_POWER: ATX 24-pin Power Connector

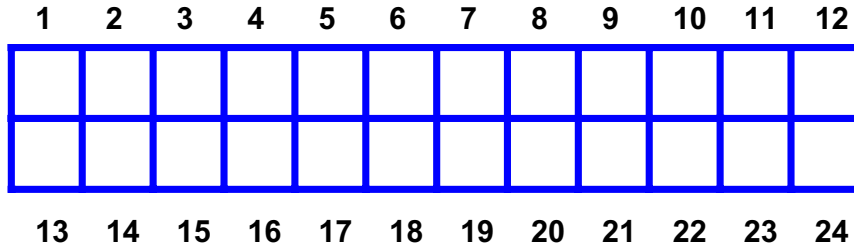

Pin	Signal Name	Pin	Signal Name
1	+3.3	13	+3.3V
2	+3.3	14	-12V
3	COM	15	COM
4	+5V	16	PS_ON
5	COM	17	COM
6	+5V	18	COM
7	COM	19	COM
8	PWR OK	20	-5V
9	5VSB	21	+5V
10	+12V	22	+5V
11	+12V	23	+5V
12	+3.3V	24	COM

Front Panel Header

The front panel header (PANEL1) provides a standard set of switch and LED connectors commonly found on ATX or Micro ATX cases. Refer to the table below for information:

Illustration	Pin	Signal	Pin	Signal
	1	5V_SYS	2	GPIO_GRN_HDR_R
	3	HDD_LED_R	4	GPIO_YLW_HDR_R
	5	GND	6	PSIN
	7	ICH_SYS_RS TJ	8	GND
	9	5V_SYS	10	KEY
	11	NC	12	5V_SB
	13	NC	14	LAN_ACTJ

Front USB

Illustration	Pin	Signal	Function	Pin	Signal	Function
	1	VREG_FP_U SBPWR0	Front panel USB power(Ports 0,1)	2	VREG_FP_U SBPWR0	Front panel USB power(Ports 0,1)
	3	USB_FP_P0-	Front panel USB Port 0 Negative Signal	4	USB_FP_P1-	Front panel USB Port 1 Negative Signal
	5	USB_FP_P0+	Front panel USB Port 0 Positive Signal	6	USB_FP_P1+	Front panel USB Port 1 Positive Signal
	7	GROUND		8	GROUND	
	9	KEY		10	GROUND	

Front Audio

Illustration	Pin	Signal Name	Pin	Signal Name
	1	MIC2-L	2	AUD_GND
	3	MIC2-R	4	AUD_PRESENCE_L
	5	LINE2-R	6	MIC2-JD
	7	FRONT-IO-SENSE	8	KEY
	9	LINE2-L	10	LINE2-JD

Front 1394

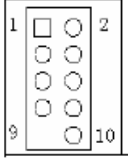
Illustration	Pin	Signal Name	Pin	Signal Name
	1	TPA+	2	TPA-
	3	GROUND	4	GROUND
	5	TPB+	6	TPB-
	7	+12V(FUSED)	8	+12V(FUSED)
	9	KEY	10	GROUND

Aux_In

Illustration	Pin	Signal Name	Pin	Signal Name
	1	CD_IN_L	2	GROUND
	3	GROUND	4	CD_IN_R
	5	KEY		

Intruder

Pin	Signal Name	Pin	Signal Name
1	INTRUDERJ	2	GROUND

J3(for requested)

Pin	Signal Name	Pin	Signal Name
1	AGPIO1	2	GROUND

J4(for requested)

Pin	Signal Name	Pin	Signal Name
1	AGPIO2	2	GROUND

SPDIF_OUT

Illustration	Pin	Signal Name	Pin	Signal Name
	1	5V_SYS	2	KEY
	3	SPDIF_OUT	4	GND

IRDA(Reserved)

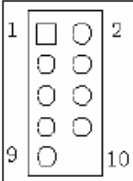
Illustration	Pin	Signal Name	Pin	Signal Name
	1	5V_SB	2	IR_26
	3	SIO_RSMRSTJ	4	RESETCONJ
	5	IR_20	6	IR_27
	7	IR_RE	8	IR_21
	9	GND	10	KEY

COM2

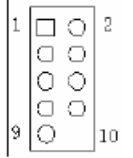
Illustration	Pin	Signal Name	Pin	Signal Name
	1	NDCDB	2	NSINB
	3	NSOUTB	4	NDTRB
	5	GND	6	NDSRB
	7	NDSRB	8	NCTSB
	9	NRIB	10	KEY

COM1

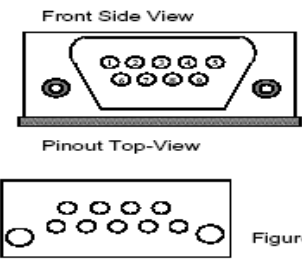
Illustration	Pin	Signal Name
 <p>Figure-(2)</p>	1	DCD
	2	RxD
	3	TxD
	4	DTR
	5	Ground
	6	DSR
	7	RTS
	8	CTS
	9	RI

LPT

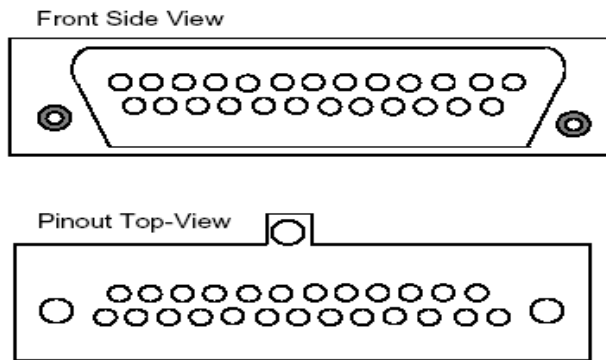

Pin	Signal Name	Pin	Signal Name
1	STROBE	14	ALF
2	PD0	15	ERROR
3	PD1	16	INIT
4	PD2	17	SLCTIN
5	PD3	18	GROUND
6	PD4	19	GROUND
7	PD5	20	GROUND
8	PD6	21	GROUND
9	PD7	22	GROUND
10	ACK	23	GROUND
11	BUSY	24	GROUND
12	PE	25	GROUND
13	SLCT		

FDD

(Top-View)

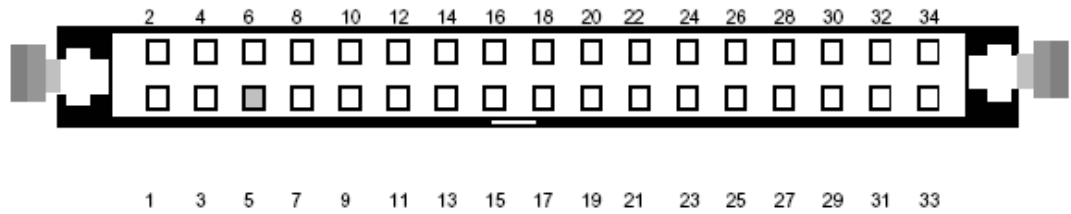

Pin	Signal Name	Pin	Signal Name
1	Ground	2	DRVDE0
3	Ground	4	HDL-
5	Keypin	6	DS3-
7	Ground	8	INDEX-
9	Ground	10	MTR0-
11	Ground	12	DS0-
13	Ground	14	DS1-
15	Ground	16	MTR1-
17	Ground	18	DIR-
19	Ground	20	STEP-
21	Ground	22	WDATA
23	Ground	24	WGATE-
25	Ground	26	TRK0-
27	Ground	28	WP-
29	Ground	30	RDATA
31	Ground	32	HDSEL-
33	Ground	34	DSKCHG-

IDE1

(Top-View)

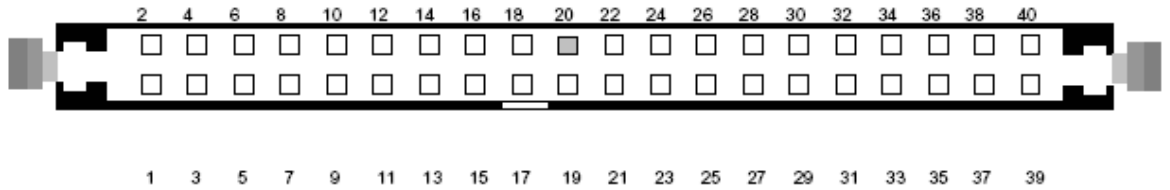

Pin	Signal Name	Pin	Signal Name
1	RESET-	2	Ground
3	DD7	4	DD8
5	DD6	6	DD9
7	DD5	8	DD10
9	DD4	10	DD11
11	DD3	12	DD12
13	DD2	14	DD13
15	DD1	16	DD14
17	DD0	18	DD15
19	Ground	20	Keypin
21	DMARQ	22	Ground
23	DIOW-	24	Ground
25	DIOR-	26	Ground
27	IORDY	28	PSYNC:CSEL
29	DMACK-	30	Ground
31	INTRQ	32	IOCS16-
33	DA1	34	PDIAG-
35	DA0	36	DA2
37	CS1FX-	38	CS3FX-
39	DASP-	40	Ground

FRU (Field Replaceable Unit) List

This chapter gives you the FRU (Field Replaceable Unit) listing in global configurations of **Aspire M1620 VeritonM262**. Refer to this chapter whenever ordering for parts to repair or for RMA (Return Merchandise Authorization).

NOTE: Please note WHEN ORDERING FRU PARTS, that you should check the most up-to-date information available on your regional web or channel (<http://aicsl.acer.com.tw/spl/>, if you do not own a specific account, you can still access the system with guest; guest). For whatever reasons a part number change is made, it will not be noted in the printed Service Guide. For ACER-AUTHORIZED SERVICE PROVIDERS, your Acer office may have a DIFFERENT part number code to those given in the FRU list of this printed Service Guide. You MUST use the local FRU list provided by your regional Acer office to order FRU parts for repair and service of customer machines.

Exploded Diagram

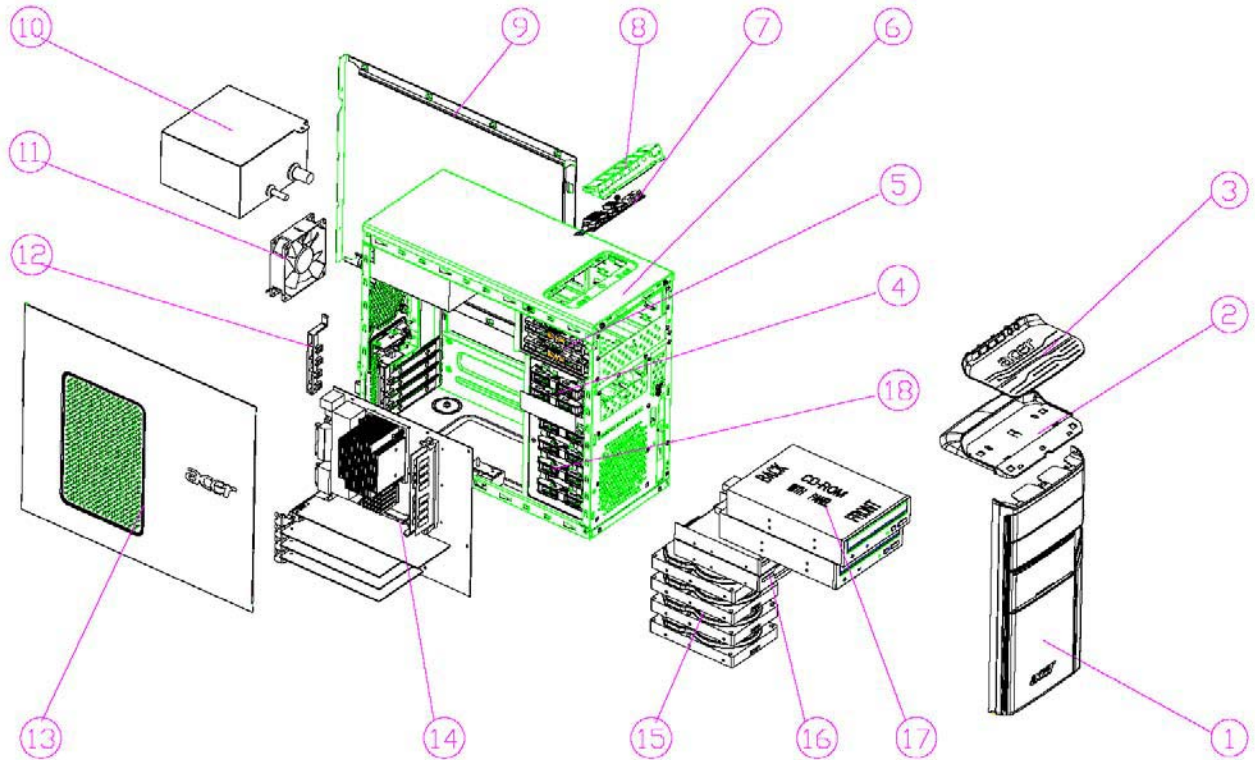

NO	DESCRIPTION	NO	DESCRIPTION
1	AM30_MAIN_BEZEL	10	POWER SUPPLY
2	AM50_USB	11	FAN
3	AM50_USB_PANEL	12	PCI-BRACKET
4	FDD_LOCK_SLIDE	13	LEFT SIDE DOOR
5	CD_ROM LOCK SLIDE	14	MOTHER BOARD
6	CHASSIS	15	HDD
7	USB_PCB_ASN	16	3.5 DEVICE
8	USB-SHIELDING	17	CD-ROM
9	RIGHT SIDE DOOR	18	HDD-LOCK-SLIDE

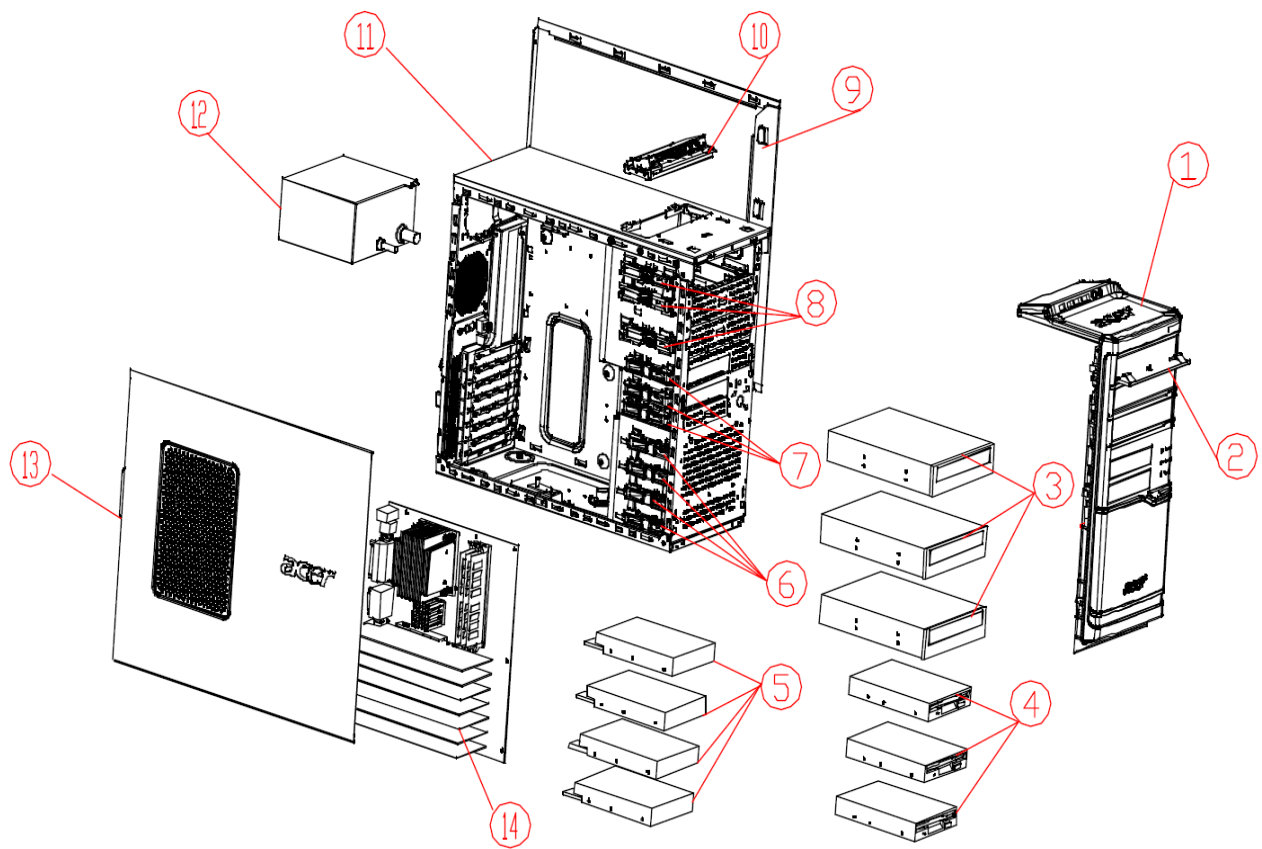

NO	DESCRIPTION	NO	DESCRIPTION
1	TOP-SHOELD	8	CDROM-LOCK-SLIDE
2	3.25 ROTATE COVER	9	RIGHT-SIDE
3	CD-ROM	10	USB MODULE
4	FDD	11	CHASSIS
5	HDD	12	POWER-SUPPLY
6	HDD-LOCK-SLIDE	13	LEFT-SCDE
7	FDD-LOCK-SLIDE	14	MAINBOARD

PARTS

ASPIRE M1620

CATEGORY	PARTNAME	DESCRIPTION	ACER PART NO.
BOARD	POWER SWITCH DB, ROHS	POWER SWITCH DB	55.P22VF.002
BOARD	USB BOARD	USB BOARD	55.S950A.001
CARD READERS	3.5 USB1.1 9-IN-1 CARD READER, WITH USB CABLE , WITH IMPROVED USB CONNECTOR,SUPPORT USB2.0	NEW CR126	CR.10400.002
CABLE	FRONT PANEL CABLE. 4PINS	FRONT PANEL CABLE. 4PINS	50.S950A.004
CABLE	IDE CD-ROM CABLE ATA66 40PIN	IDE CD-ROM CABLE ATA66 40PIN	50.S46VF.008
CABLE	HDD CABLE SATA_1	HDD CABLE SATA_1	50.S46VF.001
CABLE	SATA ODD CABLE	SATA ODD CABLE	50.P37VF.002
CABLE	SATA ODD CABLE	SATA ODD CABLE	50.P40VF.003
CABLE	USB CABLE	USB CABLE	50.S46VF.002
CABLE	AUDIO CABLE	AUDIO CABLE	50.S46VF.004
CABLE	IDE FDD CABLE 34PIN	IDE FDD CABLE 34PIN	50.S46VF.007
CASE/COVER/BRACKET ASSEMBLY	COVER SLOT, ROHS	COVER SLOT	33.P22VF.001
CASE/COVER/BRACKET ASSEMBLY	S-LOCK-HANDLE	S-LOCK-HANDLE H401/H701 ABS	42.S46VF.004
CASE/COVER/BRACKET ASSEMBLY	ODD HOLDER ASSY	ODD HOLDER ASSY	42.S46VF.005
CASE/COVER/BRACKET ASSEMBLY	FDD HOLDER ASSY	FDD HOLDER ASSY	42.S46VF.006
CASE/COVER/BRACKET ASSEMBLY	HDD HOLDER ASSY	HDD HOLDER ASSY	42.S46VF.007

CATEGORY	PARTNAME	DESCRIPTION	ACER PART NO.
CASE/COVER/BRACKET ASSEMBLY	PCI-BKT	DF2 PCI-BKT	42.S46VF.008
CASE/COVER/BRACKET ASSEMBLY	USB HOLDER ASSY	USB BKT FOR AM10	42.S890F.001
CASE/COVER/BRACKET ASSEMBLY	FDD COVER FOR AM100 300 500 BEZEL	3-5-COVER	42.S950A.002
CASE/COVER/BRACKET ASSEMBLY	5-25 ODD COVER OF AM300 BEZEL,BLACK	5-25-COVER(BLANK,BLACK)	42.S950A.003
CASE/COVER/BRACKET ASSEMBLY	RUBBER FOOT, ROHS	FOOT	47.P22VF.002
CASE/COVER/BRACKET ASSEMBLY	ACER_LOGO1 IN TOP-COVER, ROHS	LOGO ACER 55.12*13.4*0.5	47.P35VF.001
CASE/COVER/BRACKET ASSEMBLY	TOP-LOGO	PLASTIC TOP-LOGO FOR AM10	47.S890F.001
CASE/COVER/BRACKET ASSEMBLY	AM100 BEZEL_ASSY(2USB)	AM100 BEZEL_ASSY(2USB) W/I AM10-POWER-BUTTON LAN-LED LED-HOLDER 5-25-COVER 3-5-COVER ACER_LOGO POWER SWITCH DB FRONT PANEL LED CABLE	60.S890F.002
CASE/COVER/BRACKET ASSEMBLY	H402 CHASSIS W/ SIDE DOORS W/O BEZEL AND TOP-COVER	H402 BASIC CHASSIS W/ SIDE DOORS,W/O TOP COVER	60.S950A.001
CASE/COVER/BRACKET ASSEMBLY	UPPER CASE(PAINTED)	TOP-COVER (PAINTED,IRON)	60.S950A.002
CASE/COVER/BRACKET ASSEMBLY	RIGHT-SIDE COVER (PAINTED)	RIGHT-SIDE COVER (PAINTED)	60.S950A.003
CASE/COVER/BRACKET ASSEMBLY	LEFT-SIDE COVER (PAINTED)	LEFT-SIDE COVER (PAINTED)	60.S950A.004
ADD-ON CARD	RADEON 2400PRO 128MB(ONBOARD) HYNIX HY5PS56121A FP-25,	188-01E40-011AC	VG.APC24.P01

CATEGORY	PARTNAME	DESCRIPTION	ACER PART NO.
ADD-ON CARD	PRONET PCI MODEM CARD HPI56M3F W/ATX BKT, ROHS	HPI56M3	FX.56M03.003
CPU/PROCESSOR	CELERON D 430	CD430	KC.D0001.430
CPU/PROCESSOR	CORE 2 DUO E4500 (2.2G 2M 800FSB)	C2DE4500	KC.45001.DE0
CPU/PROCESSOR	CORE 2 DUO E4400 (2.0G 2M 800FSB)	C2DE4400	KC.44001.DE0
CPU/PROCESSOR	PENTIUM DUAL CORE E2160 (1.8G 1M 800FSB)	PDCE2160	KC.21601.DEP
CPU/PROCESSOR	PENTIUM DUAL CORE E2140 (1.6G 1M 800FSB)	PDCE2140	KC.21401.DEP
CPU/PROCESSOR	CPU INTEL PENTIUM DUAL-CORE E2180 PGA 2.0G 1M 800 775 65W	PDCE2180	KC.21801.DEP
FAN SINK	FOXCONN CPU COOLER PKP367G01U12 + SUNON 9225 4200RPM FAN	PKP367G01U12 + SUNON 9225 4200RPM FAN	HI.3670C.001
DVD-RW DRIVE	DH-A1S16 LF BLACK BEZEL HA11 SATA	DH-A1S1	KU.01609.004
DVD-RW DRIVE	16X , PATA	GSA-H40N , LF , DASP , SIP 5.0	KU.0160D.029
DVD DUAL DRIVE	HLDS SATA DVD-DUAL GSA-H31N LF , SATA , SIP 5.0 , NEW BEZEL , F/W: 1.01, FOR VISTA	GSA-H31N	KU.0160D.025
FDD/FLOPPY DISK DRIVE	SONY FDD 1.44M 3.5(BLACK) , ROHS	MPF920	PZ.12700.008
HDD/HARD DISK DRIVE	80G SATA3.0GBPS 8MB 7200 NCQ,	PATHFINDER II, HDS721680PLA380	KH.08007.024
HDD/HARD DISK DRIVE	160G SATA3.0GBPS 8MB 7200 NCQ,	PATHFINDER II, HDS721616PLA380	KH.16007.015
HDD/HARD DISK DRIVE	250G SATA3.0GBPS 8MB 7200 NCQ,	VANCOUVER V, HDT25025VLA380	KH.25007.010
KEYBOARD	USB KEYBOARD KU-0355 US VER. 104KS(WITH EKEY VISTA) ROHS	USB KEYBOARD KU-0355 US VER. 104KS(WITH EKEY VISTA) ROHS	KB.KUS03.222

CATEGORY	PARTNAME	DESCRIPTION	ACER PART NO.
KEYBOARD	USB KEYBOARD KU-0355 T.CHINESE VER. 104KS(WITH EKEY VISTA) ROHS	USB KEYBOARD KU-0355 T.CHINESE VER. 104KS(WITH EKEY VISTA) ROHS	KB.KUS03.223
KEYBOARD	USB KEYBOARD KU-0355 IN'L US VER. 104KS(WITH EKEY VISTA) ROHS	USB KEYBOARD KU-0355 IN'L US VER. 104KS(WITH EKEY VISTA) ROHS	KB.KUS03.225
KEYBOARD	USB KEYBOARD KU-0355 ARABIC VER. 104KS(WITH EKEY VISTA) ROHS	USB KEYBOARD KU-0355 ARABIC VER. 104KS(WITH EKEY VISTA) ROHS	KB.KUS03.226
KEYBOARD	USB KEYBOARD KU-0355 THAI VER. 104KS(WITH EKEY VISTA) ROHS	USB KEYBOARD KU-0355 THAI VER. 104KS(WITH EKEY VISTA) ROHS	KB.KUS03.227
KEYBOARD	USB KEYBOARD SK-9610 US VER. 104KS(WITH EKEY VISTA) ROHS	SK-9610	KB.USB0B.006
KEYBOARD	USB KEYBOARD SK-9610 T.CHINESE VER. 104KS(WITH EKEY VISTA) ROHS	SK-9610	KB.USB0B.007
KEYBOARD	USB KEYBOARD SK-9610 S.CHINESE 104KS(WITH EKEY VISTA) ROHS	SK-9610	KB.USB0B.008
KEYBOARD	USB KEYBOARD SK-9610 IN'L US VER. 104KS(WITH EKEY VISTA) ROHS	SK-9610	KB.USB0B.009
KEYBOARD	USB KEYBOARD SK-9610 ARABIC VER. 104KS(WITH EKEY VISTA) ROHS	SK-9610	KB.USB0B.010
KEYBOARD	USB KEYBOARD SK-9610 THAI VER. 104KS(WITH EKEY VISTA) ROHS	SK-9610	KB.USB0B.011
POINTING DEVICE	PS/2 BALL MOUSE, 2 BUTTON+WHEEL, LEAD-FREE	NETSCROLL PS2(BLACK)	MS.NET04.002
POINTING DEVICE	USB OPTICAL MOUSE, MUV ACR1, (ROHS), W/ STK LABEL	M-UV ACR1 (BLACK), (ROHS)	MS.MUV01.005
POINTING DEVICE	PS/2 OPTICAL MOUSE, SBF96, ROHS	SBF96 (BLACK)	MS.PS201.002
POINTING DEVICE	USB OPTICAL MOUSE, N12ROU, ROHS	USB OPTICAL MOUSE, N12ROU, ROHS	MS.N1204.001

CATEGORY	PARTNAME	DESCRIPTION	ACER PART NO.
MAINBOARD	MB KIT F945GC INTEL945GC+ICH7 / INTEL LGA775 CPU / DDRII / HD CODEC / LF / RM / IO SHIELDING	MB KIT F945GC	MB.SAA09.002
MEMORY	DDRII 667 512MB	NT512T64U88B0BY-3C	KN.51203.034
MEMORY	DDRII 667 1024MB	NT1GT64U8HB0BY-3C	KN.1GB03.017
POWER SUPPLY	FSP ATX-250PA(1PF) (PFC) POWER SUPPLY (250W)	FSP ATX-250PA(1PF) (PFC) POWER SUPPLY (250W)	PY.25008.019
POWER SUPPLY	PSU DELTA 250W NONE PFC PS2 SATA X 4 & PATA X 1	PSU DELTA 250W NONE PFC PS2 SATA X 4 & PATA X 1	PY.25009.006
SPEAKER	JS 2.0 SPEAKER,USB,M-1118C ACER LOGO ROHS	M-118C	SP.10600.008
SPEAKER	SPEAKER 2.0 USB JS M-1118B, ACER LOGO, LEAD-FREE	SPEAKER 2.0 USB JS M-1118B, ACER LOGO, LEAD-FREE	SP.11805.003

VERITON M262

CATEGORY	PARTNAME	DESCRIPTION	ACER PART NO.
BOARD	FRONT USB BOARD	FRONT USB BOARD	55.S650F.001
CARD READERS	3.5" USB1.1 9-in-1 card reader, with USB2.0 cable , with USB 2.0 connector	CR126	CR.10400.002
CABLE	SATA ODD Cable	SATA ODD Cable	50.P37VF.001
CABLE	SATA ODD POWER CONVERTOR CABLE	SATA ODD POWER CONVERTOR CABLE	50.P37VF.002
CABLE	LED CABLE ASSY (POWER SWITCH CABLE, POWER LED CABLE, HDD LED CABLE),ROHS	LED CABLE ASSY,ROHS	50.S34VF.007
CABLE	HDD CABLE SATA_1	SATA-HDD DATA CABLE	50.S46VF.001
CABLE	USB CABLE	USB CABLE (460MM)	50.S46VF.002
CABLE	AUDIO CABLE	AUDIO CABLE (560MM)	50.S46VF.004
CABLE	IDE FDD CABLE 34PIN	FDD DATA CABLE	50.S46VF.007
CASE/COVER/BRA CKET ASSEMBLY	I/O BRACKET, ROHS	COVER SLOT, ROHS	33.P22VF.001
CASE/COVER/BRA CKET ASSEMBLY	EMPTY COVER FOR 5.25" DEVICE,ROHS	5.25" FILLER PANEL,ROHS	42.S34VF.002
CASE/COVER/BRA CKET ASSEMBLY	FILLER COVER FOR 3 1/2" DEVICE,ROHS	3.5" FILLER PANEL,ROHS	42.S34VF.003
CASE/COVER/BRA CKET ASSEMBLY	S-LOCK-HANDLE	S-LOCK-HANDLE	42.S46VF.004
CASE/COVER/BRA CKET ASSEMBLY	ODD HOLDER ASSY	ODD HOLDER ASSY	42.S46VF.005
CASE/COVER/BRA CKET ASSEMBLY	FDD HOLDER ASSY	FDD HOLDER ASSY	42.S46VF.006
CASE/COVER/BRA CKET ASSEMBLY	HDD HOLDER ASSY	HDD HOLDER ASSY	42.S46VF.007
CASE/COVER/BRA CKET ASSEMBLY	IO BRACKET HOLDER	PCI-BKT	42.S46VF.008

CATEGORY	PARTNAME	DESCRIPTION	ACER PART NO.
CASE/COVER/BRA CKET ASSEMBLY	RUBBER FOOT, ROHS	RUBBER FOOT, ROHS	47.P22VF.002
CASE/COVER/BRA CKET ASSEMBLY	H402 BASIC CHASSIS W/ SIDE DOORS W/O BEZEL AND TOP-COVER (PAINTED)	H402 BASIC CHASSIS W/ SIDE DOORS W/O BEZEL AND TOP-COVER (PAINTED)	60.S950A.001
CASE/COVER/BRA CKET ASSEMBLY	RIGHT-SIDE DOOR (PAINTED)	RIGHT-SIDE COVER (PAINTED)	60.S950A.003
CASE/COVER/BRA CKET ASSEMBLY	LEFT-SIDE DOOR (PAINTED)	LEFT-SIDE COVER (PAINTED)	60.S950A.004
CASE/COVER/BRA CKET ASSEMBLY	VM200 BEZEL ASSY WITH POWER-BUTTON(PAINTED), LED-HOLDER, 5.25-COVER ABS, 3.5'-COVER, Front panel power/HDD LED cabl	VM200 BEZEL ASSY WITH POWER-BUTTON(PAINTED) , LED-HOLDER, 5.25-COVER ABS, 3.5'-COVER, Front panel power/HDD LED cabl	60.V580F.001
CASE/COVER/BRA CKET ASSEMBLY	USB HOLDER 2USB	USB HOLDER 2USB	33.S710F.001
CASE/COVER/BRA CKET ASSEMBLY	TOP COVER (PAINTED,SAME AS H401)	TOP COVER (PAINTED,SAME AS H401 &402)	60.S710F.001
ADD-ON CARD	Radeon 2400Pro 128MB(onboard) Hynix HY5PS56121A FP-25, 188-01E40-011AC, D-SUB/DVI/Video out	188-01E40-011AC	VG.APC24.P01
ADD-ON CARD	PC PARTNER GEFORCE 8600GS 512MB DDR2 (128bits) VGA+TVO+DVI PAL W/ATX BKT ROHS 188-06N02-00AAC	188-06N02-00AAC	VG.PC86G.S11
ADD-ON CARD	Pronet PCI Modem Card HPI56M3F w/ATX BKT, RoHS	HPI56M3F	FX.56M03.003
ADD-ON CARD	MODEM CARD PCI HPI56MIII W/ATX BKT, ROHS PRONET	MODEM CARD PCI HPI56MIII W/ATX BKT, ROHS PRONET	FX.56M03.001
COMBO MODULE	52X, SATA	DH-52C1S , LF , SATA	KO.05209.014
DVD DUAL DRIVE	Liteon 16X SATA DVD-Dual DH-16W1S, RoHS, F/W: 2A11	DH-16W1S	KU.01609.002

CATEGORY	PARTNAME	DESCRIPTION	ACER PART NO.
DVD RW DRIVE	16X SuperMulti Model:DH-16A1P,RoHS F/W RA11	DH-16A1P	KU.01609.003
DVD RW DRIVE	Lite-On SuperMulti Model:DH-16A1S SATA ROHS FW:HA11	DH-16A1S	KU.01609.004
DVD-ROM DRIVE	Lite-On Combo Model:DH-52C2S SATA FW:NA12	DH-52C2S	KO.05209.015
DVD-ROM DRIVE	Liteon DVD-ROM DH-16D1P, RoHS, F/W: FA11	DH-16D1P	KV.01609.001
DVD-ROM DRIVE	16X, SATA	DH-16D1S , LF , SATA	KV.01609.002
CPU/PROCESSOR	Celeron 430 (1.8G 512K 800FSB LGA775)	430	KC.D0001.430
CPU/PROCESSOR	Core 2 Duo E4500(2.2G 2M 800FSB)L2	E4500	KC.45001.DE0
CPU/PROCESSOR	Core 2 Duo E4400(2.0G 2M 800FSB)L2	C2DE4400	KC.44001.DE0
CPU/PROCESSOR	Pentium Dual Core E2180 (2.0G 1M 800FSB),M0	E2180	KC.21801.DEM
CPU/PROCESSOR	Pentium Dual Core E2160 (1.8G 1M 800FSB) L2 Stepping	E2160	KC.21601.DEP
CPU/PROCESSOR	Pentium Dual Core E2140 (1.6G 1M 800FSB) L2 Stepping	E2140	KC.21401.DEP
FAN SINK	Foxconn cpu cooler PKP367G01U12 + Sunon 9225 4200rpm fan	PKP367G01U12 + Sunon 9225 4200rpm fan	HI.3670C.001
FDD/FLOPPY DISK DRIVE	Sony FDD 1.44M 3.5"(black), Model:MPF920, RoHS	MPF920	PZ.12700.008
FDD/FLOPPY DISK DRIVE	FDD 1.44MB PANASONIC JU-256A048P BLACK	FDD,PANASONIC,JU-256A048P BLACK	KF.25602.003
HDD/HARD DISK DRIVE	Hitachi 80G HDD 7200rpm Pathfinder-2 SATA HDS721680PLA380 FW:P21OAB3A	HDS721680PLA380	KH.08007.024
HDD/HARD DISK DRIVE	Hitachi 160G HDD 7200rpm Pathfinder-2 SATA HDS721616PLA380	HDS721616PLA380	KH.16007.015
HDD/HARD DISK DRIVE	HGST 3.5" 7200rpm 250GB HDT25025VLA380 Vancouver V SATA II LF	HDT25025VLA380	KH.25007.010
KEYBOARD	USB Keyboard KU-0355 US Ver. 104KS(with eKey Vista) RoHS	KU-0355	KB.KUS03.222

CATEGORY	PARTNAME	DESCRIPTION	ACER PART NO.
KEYBOARD	USB Keyboard KU-0355 T.Chinese Ver. 104KS(with eKey Vista) RoHS	KU-0355	KB.KUS03.223
KEYBOARD	USB Keyboard KU-0355 S.Chinese 104KS(with eKey Vista) RoHS	KU-0355	KB.KUS03.224
KEYBOARD	USB Keyboard KU-0355 In'l US Ver. 104KS(with eKey Vista) RoHS	KU-0355	KB.KUS03.225
KEYBOARD	USB Keyboard KU-0355 Arabic Ver. 104KS(with eKey Vista) RoHS	KU-0355	KB.KUS03.226
KEYBOARD	USB Keyboard KU-0355 Thai Ver. 104KS(with eKey Vista) RoHS	KU-0355	KB.KUS03.227
KEYBOARD	USB Keyboard KU-0355 Spanish Ver. 105KS(with eKey Vista) RoHS	KU-0355	KB.KUS03.228
KEYBOARD	USB Keyboard KU-0355 Canadian/French Ver. 105KS(with eKey Vista) RoHS	KU-0355	KB.KUS03.230
KEYBOARD	USB Keyboard KU-0355 Brazilian Ver. 107KS(with eKey Vista) RoHS	KU-0355	KB.KUS03.231
KEYBOARD	USB Keyboard KU-0355 JPNese 109KS(with eKey Vista) RoHS	KU-0355	KB.KUS03.232
KEYBOARD	USB Keyboard KU-0355 French Ver. 105Keys (with eKey Vista) RoHS	KU-0355	KB.KUS03.262
KEYBOARD	USB Keyboard KU-0355 Spanish Latin Ver. 105KS(with eKey Vista) RoHS	KU-0355	KB.KUS03.264
KEYBOARD	USB Keyboard KU-0355 US Ver. 104KS JPN ABS(with eKey Vista) RoHS	KU-0355	KB.KUS03.233
KEYBOARD	USB Keyboard KU-0355 In'l US Ver. 104KS JPN ABS(with eKey Vista) RoHS	KU-0355	KB.KUS03.234
KEYBOARD	USB Keyboard KU-0355 Arabic Ver. 104KS JPN ABS(with eKey Vista) RoHS	KU-0355	KB.KUS03.235
KEYBOARD	USB Keyboard KU-0355 Germany Ver. 105KS JPN ABS(with eKey Vista) RoHS	KU-0355	KB.KUS03.236
KEYBOARD	USB Keyboard KU-0355 Italian Ver. 105KS JPN ABS(with eKey Vista) RoHS	KU-0355	KB.KUS03.237
KEYBOARD	USB Keyboard KU-0355 French Ver. 105KS JPN ABS(with eKey Vista) RoHS	KU-0355	KB.KUS03.238
KEYBOARD	USB Keyboard KU-0355 Sweden Ver. 105KS JPN ABS(with eKey Vista) RoHS	KU-0355	KB.KUS03.239

CATEGORY	PARTNAME	DESCRIPTION	ACER PART NO.
KEYBOARD	USB Keyboard KU-0355 UK Ver. 105KS JPN ABS(with eKey Vista) RoHS	KU-0355	KB.KUS03.240
KEYBOARD	USB Keyboard KU-0355 Spanish Ver. 105KS JPN ABS(with eKey Vista) RoHS	KU-0355	KB.KUS03.241
KEYBOARD	USB Keyboard KU-0355 Dutch Ver. 105KS JPN ABS(with eKey Vista) RoHS	KU-0355	KB.KUS03.242
KEYBOARD	USB Keyboard KU-0355 Portugese Ver. 105KS JPN ABS(with eKey Vista) RoHS	KU-0355	KB.KUS03.243
KEYBOARD	USB Keyboard KU-0355 Swiss Ver. 105KS JPN ABS(with eKey Vista) RoHS	KU-0355	KB.KUS03.244
KEYBOARD	USB Keyboard KU-0355 Belgium Ver. 105KS JPN ABS(with eKey Vista) RoHS	KU-0355	KB.KUS03.245
KEYBOARD	USB Keyboard KU-0355 Iceland Ver. 105KS JPN ABS(with eKey Vista) RoHS	KU-0355	KB.KUS03.247
KEYBOARD	USB Keyboard KU-0355 Norwegian Ver. 105KS JPN ABS(with eKey Vista) RoHS	KU-0355	KB.KUS03.248
KEYBOARD	USB Keyboard KU-0355 Hebrew Ver. 104KS JPN ABS(with eKey Vista) RoHS	KU-0355	KB.KUS03.249
KEYBOARD	USB Keyboard KU-0355 Polish Ver. 105KS JPN ABS(with eKey Vista) RoHS	KU-0355	KB.KUS03.250
KEYBOARD	USB Keyboard KU-0355 Slovenian Ver. 105KS JPN ABS(with eKey Vista) RoHS	KU-0355	KB.KUS03.251
KEYBOARD	USB Keyboard KU-0355 Slovakian Ver. 105KS JPN ABS(with eKey Vista) RoHS	KU-0355	KB.KUS03.252
KEYBOARD	USB Keyboard KU-0355 Turkey Ver. 105KS JPN ABS(with eKey Vista) RoHS	KU-0355	KB.KUS03.253
KEYBOARD	USB Keyboard KU-0355 RussiamVer. 104KS JPN ABS(with eKey Vista) RoHS	KU-0355	KB.KUS03.254
KEYBOARD	USB Keyboard KU-0355 Hungaria Ver. 105KS JPN ABS(with eKey Vista) RoHS	KU-0355	KB.KUS03.255
KEYBOARD	USB Keyboard KU-0355 Greek Ver. 104KS JPN ABS(with eKey Vista) RoHS	KU-0355	KB.KUS03.256
KEYBOARD	USB Keyboard KU-0355 Denmark Ver. 104KS JPN ABS(with eKey Vista) RoHS	KU-0355	KB.KUS03.257
KEYBOARD	USB Keyboard KU-0355 Czech Ver. 104KS JPN ABS(with eKey Vista) RoHS	KU-0355	KB.KUS03.258

CATEGORY	PARTNAME	DESCRIPTION	ACER PART NO.
KEYBOARD	USB Keyboard KU-0355 Italian new layout 105KS JPN ABS(with eKey Vista) RoHS	KU-0355	KB.KUS03.259
KEYBOARD	USB Keyboard KU-0355 Romanian Ver. 105KS JPN ABS(with eKey Vista) RoHS	KU-0355	KB.KUS03.260
KEYBOARD	USB Keyboard KU-0355 Turkey/French Ver. 105KS JPN ABS(with eKey Vista) RoHS	KU-0355	KB.KUS03.261
KEYBOARD	USB Keyboard KU-0355 French+Arabic 105KS (with eKey Vista) RoHS	KU-0355	KB.KUS03.263
KEYBOARD	USB Keyboard SK-9610 US Ver. 104KS(with eKey Vista) RoHS	SK-9610	KB.USB0B.006
KEYBOARD	USB Keyboard SK-9610 T.Chinese Ver. 104KS(with eKey Vista) RoHS	SK-9610	KB.USB0B.007
KEYBOARD	USB Keyboard SK-9610 S.Chinese 104KS(with eKey Vista) RoHS	SK-9610	KB.USB0B.008
KEYBOARD	USB Keyboard SK-9610 In'l US Ver. 104KS(with eKey Vista) RoHS	SK-9610	KB.USB0B.009
KEYBOARD	USB Keyboard SK-9610 Arabic Ver. 104KS(with eKey Vista) RoHS	SK-9610	KB.USB0B.010
KEYBOARD	USB Keyboard SK-9610 Thai Ver. 104KS(with eKey Vista) RoHS	SK-9610	KB.USB0B.011
KEYBOARD	USB Keyboard SK-9610 Spanish Ver. 105KS(with eKey Vista) RoHS	SK-9610	KB.USB0B.012
KEYBOARD	USB Keyboard SK-9610 Portugese Ver. 105KS(with eKey Vista) RoHS	SK-9610	KB.USB0B.013
KEYBOARD	USB Keyboard SK-9610 Canadian/French Ver. 105KS(with eKey Vista) RoHS	SK-9610	KB.USB0B.014
KEYBOARD	USB Keyboard SK-9610 Brazilian Ver. 107KS(with eKey Vista) RoHS	SK-9610	KB.USB0B.015
KEYBOARD	USB Keyboard SK-9610 JPNese 109KS(with eKey Vista) RoHS	SK-9610	KB.USB0B.016
KEYBOARD	USB Keyboard SK-9610 Germany Ver. 105KS (with eKey Vista) RoHS	SK-9610	KB.USB0B.017
KEYBOARD	USB Keyboard SK-9610 Italian Ver. 105KS (with eKey Vista) RoHS	SK-9610	KB.USB0B.018
KEYBOARD	USB Keyboard SK-9610 French Ver. 105KS (with eKey Vista) RoHS	SK-9610	KB.USB0B.019

CATEGORY	PARTNAME	DESCRIPTION	ACER PART NO.
KEYBOARD	USB Keyboard SK-9610 Sweden Ver. 105KS (with eKey Vista) RoHS	SK-9610	KB.USB0B.020
KEYBOARD	USB Keyboard SK-9610 UK Ver. 105KS (with eKey Vista) RoHS	SK-9610	KB.USB0B.021
KEYBOARD	USB Keyboard SK-9610 Dutch Ver. 105KS (with eKey Vista) RoHS	SK-9610	KB.USB0B.022
KEYBOARD	USB Keyboard SK-9610 Swiss Ver. 105KS (with eKey Vista) RoHS	SK-9610	KB.USB0B.023
KEYBOARD	USB Keyboard SK-9610 Belgium Ver. 105KS (with eKey Vista) RoHS	SK-9610	KB.USB0B.024
KEYBOARD	USB Keyboard SK-9610 Iceland Ver. 105KS (with eKey Vista) RoHS	SK-9610	KB.USB0B.025
KEYBOARD	USB Keyboard SK-9610 Norwegian Ver. 105KS (with eKey Vista) RoHS	SK-9610	KB.USB0B.026
KEYBOARD	USB Keyboard SK-9610 Hebrew Ver. 104KS (with eKey Vista) RoHS	SK-9610	KB.USB0B.027
KEYBOARD	USB Keyboard SK-9610 Polish Ver. 105KS (with eKey Vista) RoHS	SK-9610	KB.USB0B.028
KEYBOARD	USB Keyboard SK-9610 Slovenian Ver. 105KS (with eKey Vista) RoHS	SK-9610	KB.USB0B.029
KEYBOARD	USB Keyboard SK-9610 Slovakian Ver. 105KS (with eKey Vista) RoHS	SK-9610	KB.USB0B.030
KEYBOARD	USB Keyboard SK-9610 Turkey Q-Type Ver. 105KS (with eKey Vista) RoHS	SK-9610	KB.USB0B.031
KEYBOARD	USB Keyboard SK-9610 Russian Ver. 104KS (with eKey Vista) RoHS	SK-9610	KB.USB0B.032
KEYBOARD	USB Keyboard SK-9610 Hungaria Ver. 105KS (with eKey Vista) RoHS	SK-9610	KB.USB0B.033
KEYBOARD	USB Keyboard SK-9610 Greek Ver. 104KS (with eKey Vista) RoHS	SK-9610	KB.USB0B.034
KEYBOARD	USB Keyboard SK-9610 Denmark Ver. 104KS (with eKey Vista) RoHS	SK-9610	KB.USB0B.035
KEYBOARD	USB Keyboard SK-9610 Czech Ver. 104KS (with eKey Vista) RoHS	SK-9610	KB.USB0B.036
KEYBOARD	USB Keyboard SK-9610 Romanian Ver. 105KS (with eKey Vista) RoHS	SK-9610	KB.USB0B.037

CATEGORY	PARTNAME	DESCRIPTION	ACER PART NO.
KEYBOARD	USB Keyboard SK-9610 Turkey F-Type Ver. 105KS (with eKey Vista) RoHS	SK-9610	KB.USB0B.038
KEYBOARD	USB Keyboard SK-9610 French+Arabic 105KS (with eKey Vista) RoHS	SK-9610	KB.USB0B.039
KEYBOARD	USB Keyboard SK-9610 Spanish Latin Ver. 105KS(with eKey Vista) RoHS	SK-9610	KB.USB0B.040
KEYBOARD	USB Keyboard SK-9610 Italian Ver. S1 105KS (with eKey) RoHS	SK-9610	KB.USB0B.041
KEYBOARD	USB Keyboard SK-9610 Italian Ver. S1 105KS (with eKey Vista) RoHS	SK-9610	KB.USB0B.042
KEYBOARD	USB Keyboard SK-9610 US Ver. 104KS(with eKey Vista) RoHS	SK-9610	KB.9610B.045
KEYBOARD	USB Keyboard SK-9610 T.Chinese Ver. 104KS(with eKey Vista) RoHS	SK-9610	KB.9610B.046
KEYBOARD	USB Keyboard SK-9610 S.Chinese 104KS(with eKey Vista) RoHS	SK-9610	KB.9610B.047
KEYBOARD	USB Keyboard SK-9610 In'l US Ver. 104KS(with eKey Vista) RoHS	SK-9610	KB.9610B.048
KEYBOARD	USB Keyboard SK-9610 Arabic Ver. 104KS(with eKey Vista) RoHS	SK-9610	KB.9610B.049
KEYBOARD	USB Keyboard SK-9610 Thai Ver. 104KS(with eKey Vista) RoHS	SK-9610	KB.9610B.050
KEYBOARD	USB Keyboard SK-9610 Spanish Ver. 105KS(with eKey Vista) RoHS	SK-9610	KB.9610B.051
KEYBOARD	USB Keyboard SK-9610 Portugese Ver. 105KS(with eKey Vista) RoHS	SK-9610	KB.9610B.052
KEYBOARD	USB Keyboard SK-9610 Canadian/French Ver. 105KS(with eKey Vista) RoHS	SK-9610	KB.9610B.053
KEYBOARD	USB Keyboard SK-9610 Brazilian Ver. 107KS(with eKey Vista) RoHS	SK-9610	KB.9610B.054
KEYBOARD	USB Keyboard SK-9610 JPNese 109KS(with eKey Vista) RoHS	SK-9610	KB.9610B.055
KEYBOARD	USB Keyboard SK-9610 Germany Ver. 105KS (with eKey Vista) RoHS	SK-9610	KB.9610B.056
KEYBOARD	USB Keyboard SK-9610 Italian Ver. 105KS (with eKey Vista) RoHS	SK-9610	KB.9610B.057

CATEGORY	PARTNAME	DESCRIPTION	ACER PART NO.
KEYBOARD	USB Keyboard SK-9610 French Ver. 105KS (with eKey Vista) RoHS	SK-9610	KB.9610B.058
KEYBOARD	USB Keyboard SK-9610 Sweden Ver. 105KS (with eKey Vista) RoHS	SK-9610	KB.9610B.059
KEYBOARD	USB Keyboard SK-9610 UK Ver. 105KS (with eKey Vista) RoHS	SK-9610	KB.9610B.060
KEYBOARD	USB Keyboard SK-9610 Dutch Ver. 105KS (with eKey Vista) RoHS	SK-9610	KB.9610B.061
KEYBOARD	USB Keyboard SK-9610 Swiss Ver. 105KS (with eKey Vista) RoHS	SK-9610	KB.9610B.062
KEYBOARD	USB Keyboard SK-9610 Belgium Ver. 105KS (with eKey Vista) RoHS	SK-9610	KB.9610B.063
KEYBOARD	USB Keyboard SK-9610 Iceland Ver. 105KS (with eKey Vista) RoHS	SK-9610	KB.9610B.064
KEYBOARD	USB Keyboard SK-9610 Norwegian Ver. 105KS (with eKey Vista) RoHS	SK-9610	KB.9610B.065
KEYBOARD	USB Keyboard SK-9610 Hebrew Ver. 104KS (with eKey Vista) RoHS	SK-9610	KB.9610B.066
KEYBOARD	USB Keyboard SK-9610 Polish Ver. 105KS (with eKey Vista) RoHS	SK-9610	KB.9610B.067
KEYBOARD	USB Keyboard SK-9610 Slovenian Ver. 105KS (with eKey Vista) RoHS	SK-9610	KB.9610B.068
KEYBOARD	USB Keyboard SK-9610 Slovakian Ver. 105KS (with eKey Vista) RoHS	SK-9610	KB.9610B.069
KEYBOARD	USB Keyboard SK-9610 Turkey Q-Type Ver. 105KS (with eKey Vista) RoHS	SK-9610	KB.9610B.070
KEYBOARD	USB Keyboard SK-9610 RussiamVer. 104KS (with eKey Vista) RoHS	SK-9610	KB.9610B.071
KEYBOARD	USB Keyboard SK-9610 Hungaria Ver. 105KS (with eKey Vista) RoHS	SK-9610	KB.9610B.072
KEYBOARD	USB Keyboard SK-9610 Greek Ver. 104KS (with eKey Vista) RoHS	SK-9610	KB.9610B.073
KEYBOARD	USB Keyboard SK-9610 Denmark Ver. 105KS (with eKey Vista) RoHS	SK-9610	KB.9610B.074
KEYBOARD	USB Keyboard SK-9610 Czech Ver. 104KS (with eKey Vista) RoHS	SK-9610	KB.9610B.075

CATEGORY	PARTNAME	DESCRIPTION	ACER PART NO.
KEYBOARD	USB Keyboard SK-9610 Romanian Ver. 105KS (with eKey Vista) RoHS	SK-9610	KB.9610B.076
KEYBOARD	USB Keyboard SK-9610 Turkey F-Type Ver. 105KS (with eKey Vista) RoHS	SK-9610	KB.9610B.077
KEYBOARD	USB Keyboard SK-9610 French+Arabic 105KS (with eKey Vista) RoHS	SK-9610	KB.9610B.078
KEYBOARD	USB Keyboard SK-9610 Spanish Latin Ver. 105KS(with eKey Vista) RoHS	SK-9610	KB.9610B.079
KEYBOARD	USB Keyboard SK-9610 Italian Ver. S1 105KS (with eKey) RoHS	SK-9610	KB.USB0B.002
KEYBOARD	USB Keyboard SK-9610 Italian Ver. S1 105KS (with eKey Vista) RoHS	SK-9610	KB.USB0B.001
MAINBOARD	MB Kit F945GC Intel945GC+ICH7 / Intel LGA775 CPU / DDRII / HD codec / LF / RM / IO shielding	MB Kit F945GC Intel945GC+ICH7 / Intel LGA775 CPU / DDRII / HD codec / LF / RM / IO shielding	MB.SAA09.002
MEMORY	UNB-DIMM DDRII 667 512MB NT512T64U88B0BY-3C LF 0.09um	NT512T64U88B0BY-3C	KN.51203.034
MEMORY	UNB-DIMM DDRII 667 1GB NT1GT64U8HB0BY-3C LF 0.09um	NT1GT64U8HB0BY-3C	KN.1GB03.017
MEMORY	Samsung DDR2 667 1GB M378T2953EZ3-CE6 Rohs	M378T2953EZ3-CE6	KN.1GB0B.013
POINTING DEVICE	Logitech USB Optical M-UVACR1 new resonator M-UVACR1(black),LF	M-UVACR1	MS.11200.006
POINTING DEVICE	KYE USB Optical Mouse, N12ROU new Cypress chip, Black, RoHS	N12ROU	MS.11200.005
POINTING DEVICE	Logitech PS2 Ball Mouse Model:SBN96	SBN96	MS.11200.008
POINTING DEVICE	USB optical mouse, MUV ACR1, w/ STK label, RoHS	M-UV ACR1	MS.MUV01.005
POINTING DEVICE	USB OPTICAL MOUSE, MUV ACR1(BLACK),LEAD-FREE	USB OPTICAL MOUSE, MUV ACR1(BLACK),LEAD-FREE	MS.MUV01.004
POINTING DEVICE	USB OPTICAL MOUSE, N12ROU, BLACK, ROHS KYE	KYE USB OPTICAL MOUSE, N12ROU, BLACK, ROHS	MS.N1204.001

CATEGORY	PARTNAME	DESCRIPTION	ACER PART NO.
POWER SUPPLY	250W ATX-250PA(1PF) PFC 9PA250BE00	ATX-250PA(1PF)	PY.25008.019
POWER SUPPLY	DPS-250AB-22 E (4SATA1PATA) Non-PFC RoHS	DPS-250AB-22 E	PY.25009.006
POWER SUPPLY	ATX-250PA(1) (4SATA1PATA)	ATX-250PA(1) (4SATA1PATA)	PY.25008.022
SPEAKER	JS 2.0 Speaker,USB,M-1118C Acer Logo RoHS	M-118C	SP.10600.008
SPEAKER	Logitech 2.0 speaker, S100, 230V w/ Australia plug type, Acer logo (RoHS)	S100	SP.S1006.009
SPEAKER	Logitech 2.0 speaker, S100, 230V with Europe plug type,Logitech Logo (RoHS)	S100	SP.S1006.007
SPEAKER	Logitech 2.0 Speaker S100 110V w/US plug type Acer logo&STK label (RoHS)	S100	SP.S1006.010
SPEAKER	JS 2.0 speaker, USB, M-1118B, Acer logo,RoHS	M-1118B,LF	SP.11805.003

Free Manuals Download Website

<http://myh66.com>

<http://usermanuals.us>

<http://www.somanuals.com>

<http://www.4manuals.cc>

<http://www.manual-lib.com>

<http://www.404manual.com>

<http://www.luxmanual.com>

<http://aubethermostatmanual.com>

Golf course search by state

<http://golfingnear.com>

Email search by domain

<http://emailbydomain.com>

Auto manuals search

<http://auto.somanuals.com>

TV manuals search

<http://tv.somanuals.com>