

Acer

**Aspire M5910(G)
Service Guide**

PRINTED IN TAIWAN

Revision History

Please refer to the table below for the updates made on this service guide.

Date	Chapter	Updates

Copyright

Copyright © 2010 by Acer Incorporated. All rights reserved. No part of this publication may be reproduced, transmitted, transcribed, stored in a retrieval system, or translated into any language or computer language, in any form or by any means, electronic, mechanical, magnetic, optical, chemical, manual or otherwise, without the prior written permission of Acer Incorporated.

Disclaimer

The information in this guide is subject to change without notice.

Acer Incorporated makes no representations or warranties, either expressed or implied, with respect to the contents hereof and specifically disclaims any warranties of merchantability or fitness for any particular purpose. Any Acer Incorporated software described in this manual is sold or licensed "as is". Should the programs prove defective following their purchase, the buyer (and not Acer Incorporated, its distributor, or its dealer) assumes the entire cost of all necessary servicing, repair, and any incidental or consequential damages resulting from any defect in the software.

Acer is a registered trademark of Acer Corporation.

Intel is a registered trademark of Intel Corporation.

Pentium Dual-Core, Celeron Dual-Core, Core 2 Duo, Core 2 Quad, Celeron, and combinations thereof, are trademarks of Intel Corporation.

Other brand and product names are trademarks and/or registered trademarks of their respective holders.

Conventions

The following conventions are used in this manual:

SCREEN MESSAGES	Denotes actual messages that appear on screen.
NOTE	Gives additional information related to the current topic.
WARNING	Alerts you to any physical risk or system damage that might result from doing or not doing specific actions.
CAUTION	Gives precautionary measures to avoid possible hardware or software problems.
IMPORTANT	Reminds you to do specific actions relevant to the accomplishment of procedures.

Service Guide Coverage

This Service Guide provides you with all technical information relating to the BASIC CONFIGURATION decided for Acer's "global" product offering. To better fit local market requirements and enhance product competitiveness, your regional office MAY have decided to extend the functionality of a machine (e.g. add-on card, modem, or extra memory capability). These LOCALIZED FEATURES will NOT be covered in this generic service guide. In such cases, please contact your regional offices or the responsible personnel/channel to provide you with further technical details.

FRU Information

Please note WHEN ORDERING FRU PARTS, that you should check the most up-to-date information available on your regional web or channel. If, for whatever reason, a part number change is made, it will not be noted in the printed Service Guide. For ACER-AUTHORIZED SERVICE PROVIDERS, your Acer office may have a DIFFERENT part number code to those given in the FRU list of this printed Service Guide. You MUST use the list provided by your regional Acer office to order FRU parts for repair and service of customer machines.

Table of Contents

System Tour	1
Features	1
Block Diagram	4
System Components	5
Front Panel	5
Rear Panel	6
Hardware Specifications and Configurations	7
Power Management Function(ACPI support function)	10
System Utilities	11
CMOS Setup Utility	11
Entering CMOS setup	12
Navigating Through the Setup Utility	12
Setup Utility Menus	13
System Disassembly	26
Disassembly Requirements	26
Pre-disassembly Procedure	27
Removing the Side Panel	28
Removing the Heat Sink Fan Assembly	29
Removing the Processor	30
Removing the VGA Card	31
Removing the TV Card	32
Removing the Mode Card	33
Removing the Hard Disk Drive	35
Removing the Front Bezel	36
Removing the Rear USB Board	37
Removing the Cables	38
Removing the System Fan	39
Removing the Optical Drive	40
Removing the Power Supply	41
Removing the Memory Modules	42
Removing the Removable HDD bay	43
Removing the Mainboard	45
System Troubleshooting	46
Hardware Diagnostic Procedure	46
System Check Procedures	47
Power System Check	47
System External Inspection	47
System Internal Inspection	47
Beep Codes	48
Checkpoints	49
BIOS Recovery	52
Jumper and Connector Information	53
M/B Placement	53
Jumper Setting	55
Setting Jumper	55

FRU (Field Replaceable Unit) List**61**

Aspire M5910(G) Exploded Diagram(AM551 ASSY)
Aspire M5910(G) Exploded Diagram(AM550 ASSY)
Aspire M5910(G) FRU List

62
63
64

System Tour

Features

Below is a brief summary of the computer's many feature:

NOTE: The features listed in this section is for your reference only. The exact configuration of the system depends on the model purchased.

Operating System

- Microsofte Windows 7 Home Premium 64-bit
- Microsofte Windows 7 Home Basic 64-bit
- Microsofte Windows 7 Home Premium 32-bit
- Microsofte Windows 7 Home Basic 32-bit
- Linpus X-window mode
- FreeDos

Processor

- Socket Type: Intel Socket T LGA 1156 pin
- Socket Quantity: 1
- Processor Type:
 - Intel Lynnfield / Clarkdale
- FMB
 - 95W + 65W FMB

Chipset

- PCH: Intel H57
- Design Criteria:
 - Must meet Intel Lynnfield and Clarkdale platform design guides
- Super I/O: ITE8720
 - Should support Intel ASFC
 - Should support Intel PECI

PCB

- uATX / 244*244mm / 4 Layers

Memory subsystem

- Socket Type: DDR III connector
 - Socket Quantity: 4
 - Channel A: slot 0, 1; Channel B: slot 2, 3
 - Different colors for slot 0/2 and slot 1/3
- Dual channel support
- Capacity support:
 - Support DDR3 1.5V 1066/1333 (1GB / 2GB / 4GB)

-
- 1GB to 16GB Max memory support
 - Design Criteria:
 - Must meet Intel Lynnfield and Clarkdale Chipset platform design guide

Hard disk

- Support up to two SATA ports
- 3.5", 25.4mm
- Capacity and models are listed on AVLC

Optical disk

- Support two SATA 5.25" standard ODD
- Support DVD-ROM, DVD-SuperMulti, BD-combo, BD-rewrite
- Maximum ODD depth to 185mm with bezel
- Models are listed on AVLC

Graphics card

- No mechanical restriction to support for double slot, full length graphics cards in the single PSle X16 slot

On-Board Graphic solution

- Intel HD Graphics (Clarkdale series CPU)
 - DVMT 5.0 technology support
 - Enhanced 3D and Clear Video technology support
 - 1 D-sub VGA port on rear
 - Dual View function support

Serial ATA controller

- Slot Type: SATA connector
- Six SATA ports:
 - 4 for HDD
 - 2 for ODD
- Storage Type support:
 - 1.HDD : Support RAID 0/1/5/10
 - 2.CD-ROM/CD-RW/DVD-ROM/DVD-RW/DVD+RW/DVD Dual/DVD SuperMultiPlus/Blu-Ray ODD
 - 3.AHCI mode supported for internal SATA port

Audio

- Chip : Realtek ALC662VC-0
- Connectors support:
 - Rear 3 jack follow HD audio definition
 - 1 front panel audio header (2*5)

LAN

- MAC Controller: H57
- PHY: REALTEK RTL8111E Giga LAN(ASF suport)

USB ports

- Ports Quantity: 12
 - 6 back panel ports
 - On-board: 2 2*5 headers
 - 4 ports for front daughter board
 - Connector Pin: standard Intel FPIO pin definition
- Data transfer rate support: USB 2.0/1.1

Extension slot

- Support one PCIe x 16 slot
- Support two PCIe x 1 slots
- Support one PCI slot

Total I/O ports

- 1 PS/2 Keyboard port,
- 1 PS/2 Mouse port
- 1 D-Sub VGA port
- 1 RJ45 LAN port
- 6 USB ports
- 3 ports Audio jack
- One HD headphone output in front bezel
- One MIC-IN in front bezel
- 4 * USB H5X2 Header (support 8 ports)
- 1 * Front Audio Pannel H5X2 header
- 1 * Front Panel IO H7X2 Header for Acer pin define
- 1 * H1X4 CPU with SAMRT FAN controller
- 1 * H1X3 System with SAMRT FAN controller
- 1 * H1X4 SPDIFOUT Header for Acer pin define
- 1 * H3X1 Clear CMOS Header (with jumper)
- 1 * onboard Buzzer
- 2 * H1X2 GPIO header

System BIOS

- 16Mbits / 2M Bytes
- AMI Kernel with Acer skin

Power supply

- FR500W

Block Diagram

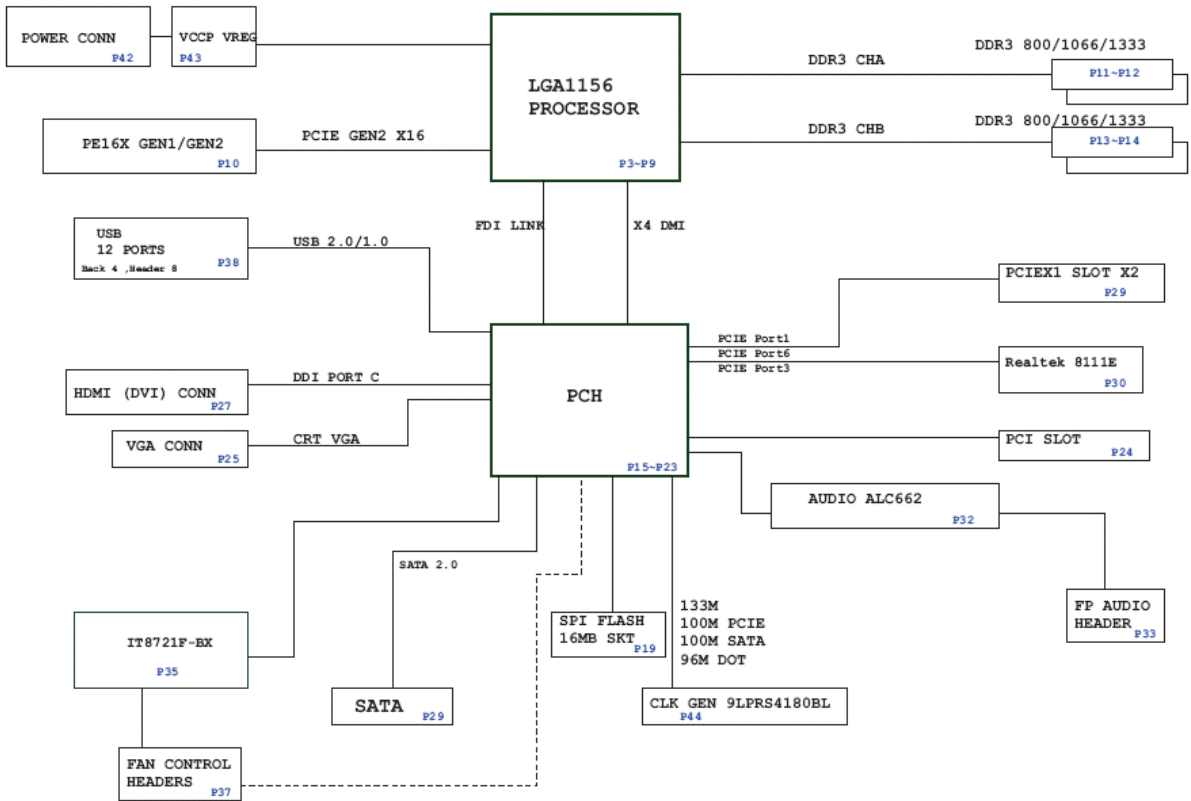

System Components

This section is a virtual tour of the system's interior and exterior components.

Front Panel



No.	Component
1	USB 2.0 ports
2	Acer logo
3	Optical drive button
4	Optical drive button (Removable HDD bay for AM551 bezel)
5	Removable HDD bay
6	Power button
7	16 in 1 Card Reader
8	Headphone/Speaker-out/line-out jack
9	Microphone-in jack

Rear Panel

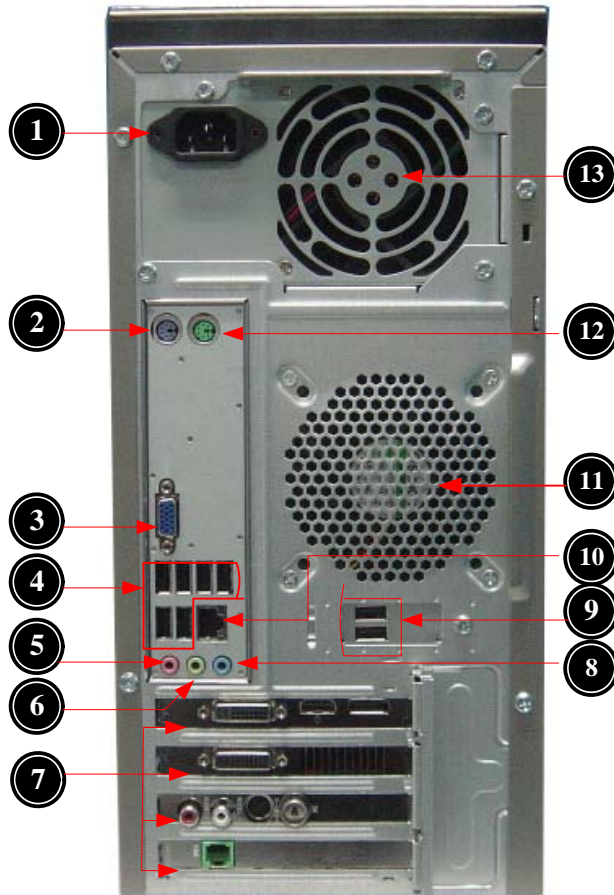

No.	Component
1	Power connector
2	PS2 keyboard port
3	VGA port
4	USB 2.0 ports
5	Mic-in
6	Line-out
7	Expansion slot (graphics card and TV tuner card and Mode card)
8	Line-in
9	USB 2.0 ports
10	LAN connector
11	System FAN
12	PS2 mouse port
13	Fan aperture

Hardware Specifications and Configurations

Processor

Item	Specification
Processor Type	CPUs which complaint with Intel FSB 800/1066/1333 MHz CPUs
Socket Type	Intel Socket T LGA 1156 pin
Minimum operating speed	0 MHz (If Stop CPU Clock in Sleep State in BIOS Setup is set to Enabled.)

BIOS

Item	Specification
BIOS code programer	AMI Kernel with Acer skin
BIOS version	P01-A0
BIOS ROM type	SPI ROM
BIOS ROM size	2Mb
Support protocol	SMBIOS(DMI)2.4/DMI2.0
Device Boot Support	Support BBS spec 1st priority: HDD 2nd priority: CD-ROM 3th priority: Removable Device 4th priority: LAN
Support to LS-120 drive	YES
Support to BIOS boot block feature	YES

IOS Hotkey List

Hotkey	Function	Description
Del	Enter BIOS Setup Utility	Press while the system is booting to enter BIOS Setup Utility.

Main Board Major Chips

Item	Specification
Chipset	PCH: Intel H57
Audio controller	Realtek ALC662VC-0
LAN controller	REALTEK RTL8111E Giga LAN(ASF suport)
HDD controller	PCH: Intel H57

Memory Combinations

Slot	Memory	Total Memory
Slot 1	1GB,2GB,4G	1G ~4GB
Slot 2	1GB,2GB,4G	1G ~4GB
Slot 3	1GB,2GB,4G	1G ~4GB
Slot 4	1GB,2GB,4G	1G ~4GB
Maximum System Memory Supported		1G~16GB

System Memory

Item	Specification
Memory slot number	4 slot
Support Memory size per socket	1GB/2GB/4GB
Support memory type	DDRIII
Support memory interface	DDRIII 1066/1333
Support memory voltage	1.5V
Support memory module package	240-pin DDRIII
Support to parity check feature	Yes
Support to error correction code (ECC) feature	No
Memory module combinations	You can install memory modules in any combination as long as they match the above specifications.

Audio Interface

Item	Specification
Audio controller	PCH: Intel H57
Audio controller type	Realtek ALC662VC-0
Audio channel	codec 5.1
Audio function control	No
Mono or stereo	Stereo
Compatibility	The ALC662VC series support host audio controller from the Intel ICH series chipset, and also from any other HDA compatible audio controller. With EAX/ Direct Sound 3D/I3DL2/A3D compatibility, and excellent software utilities like environment sound emulation, multiple bands of software equalizer and dynamic range control, optional Dolby, Digital Live, DTS CONNECT, and Dolby Home Theater programs, provides an excellent home entertainment package and game experience for PC users.
Music synthesizer	No
Sampling rate	192KHz (max)
MPU-401 UART support	No
Microphone/Headphone jack	Supported

SATA Interface

Item	Specification
SATA controller	PCH: Intel H57
SATA controller resident bus	PCI bus
Number of SATA channel	SATA X 6
Support bootable CD-ROM	YES

USB Port

Item	Specification
Universal HCI	USB 2.0/1.1
USB Class	Support legacy keyboard for legacy mode
USB Connectors Quantity	6 back real ports 4 top bezel ports 2 H5X2 Hedaer

Environmental Requirements

Item	Specification
Temperature	
Operating	+5°C ~ +35°C
Non-operating	-20 ~ +60°C (Storage package)
Humidity	
Operating	15% to 80% RH
Non-operating	10% to 90% RH
Vibration	
Operating (unpacked)	5 ~ 500 Hz: 2.20g RMS random, 10 minutes per axis in all 3 axes. 5 ~500 Hz: 1.09g RMS random, 1 hour per axis in all 3 axes.

Power Management

Devices	S1	S3	S4	S5
Power Button	V	V	V	V
USB Keyboard/Mouse	V	V	N/A	N/A
PME	Disabled	Disabled	Disabled	Disabled
RCT	Disabled	Disabled	Disabled	Disabled
WOR	Disabled	Disabled	Disabled	Disabled

- Devices wake up from S3 should be less than.
- Devices wake up from S5 should be less than 10 seconds.

Power Management Function(ACPI support function)

Device Standby Mode

- Independent power management timer for hard disk drive devices(0-15 minutes,time step=1minute).
- Hard Disk drive goes into Standby mode(for ATA standard interface).
- Disable V-sync to control the VESA DPMS monitor.
- Resume method:device activated (keyboard for DOS, keyboard &mouse for Windows).
- Resume recovery time 3-5sec

Global Standby Mode

- Global power management timer(2-120minutes,time step=10minute).
- Hard disk drive goes into Standby mode(for ATA standard interface).
- Disable H-sync and V-sync signals to control the VESA DPMS monitor.
- Resume method: Resume to original state by pushing external switch Button,modem ring in,keyboard an mouse for APM mode.
- Resume recovery time :7-10sec

Suspend Mode

- Independent power management timer(2-120minutes,time step=10minute)or pushing extern switch button.
- CPU goes into SMM
- CPU asserts STPCLK# and goes into the Stop Grant State.
- LED on panel turns amber colour.
- Hard disk drive goes into SLEEP mode (for ATA standard interface).
- Disable H-sync and V-sync signals to control the VESA DPMS monitor.
- Ultra I/O and VGA chip go into power saving mode.
- Resume method: Resume to original state by pushing external switch Button,modem ring in,keyboard an mouse for APM mode
- Return to original state by pushing external switch button,modem ring in and USB keyboard for ACPI mode.

ACPI

- ACPI specification 1.0b
- S0,S1,S2 and S5 sleep state support.
- On board device power management support.
- On board device configuration support.

System Utilities

CMOS Setup Utility

CMOS setup is a hardware configuration program built into the system ROM, called the complementary metal-oxide semiconductor (CMOS) Setup Utility. Since most systems are already properly configured and optimized, there is no need to run this utility. You will need to run this utility under the following conditions.

- When changing the system configuration settings
- When redefining the communication ports to prevent any conflicts
- When modifying the power management configuration
- When changing the password or making other changes to the security setup
- When a configuration error is detected by the system and you are prompted ("Run Setup" message) to make changes to the CMOS setup

NOTE: If you repeatedly receive Run Setup messages, the battery may be bad. In this case, the system cannot retain configuration values in CMOS. Ask a qualified technician for assistance.

CMOS setup loads the configuration values in a battery-backed nonvolatile memory called CMOS RAM. This memory area is not part of the system RAM which allows configuration data to be retained when power is turned off.

Before you run the *CMOS Setup Utility*, make sure that you have saved all open files. The system reboots immediately after you close the Setup.

NOTE: *CMOS Setup Utility* will be simply referred to as "BIOS", "Setup", or "Setup utility" in this guide.

The screenshots used in this guide display default system values. These values may not be the same those found in your system.

Entering CMOS setup

1. Turn on the server and the monitor.

If the server is already turned on, close all open applications, then restart the server.

2. During POST, press **Delete**.

If you fail to press **Delete** before POST is completed, you will need to restart the server.

The Setup Main menu will be displayed showing the Setup's menu bar. Use the left and right arrow keys to move between selections on the menu bar.

Navigating Through the Setup Utility

Use the following keys to move around the Setup utility.

- **Left** and **Right** arrow keys – Move between selections on the menu bar.
- **Up** and **Down** arrow keys – Move the cursor to the field you want.
- **PgUp** and **PgDn** keys – Move the cursor to the previous and next page of a multiple page menu.
- **Home** – Move the cursor to the first page of a multiple page menu.
- **End** – Move the cursor to the last page of a multiple page menu.
- **+** and **-** keys – Select a value for the currently selected field (only if it is user-configurable). Press these keys repeatedly to display each possible entry, or the **Enter** key to choose from a pop-up menu.

NOTE: Grayed-out fields are not user-configurable.

- **Enter** key – Display a submenu screen.

NOTE: Availability of submenu screen is indicated by a (>).

- **Esc** – If you press this key:
 - On one of the primary menu screens, the Exit menu displays.
 - On a submenu screen, the previous screen displays.
 - When you are making selections from a pop-up menu, closes the pop-up without making a selection.
- **F1** – Display the General Help panel.
- **F6** – Press to load optimized default system values.
- **F7** – Press to load fail-safe default system values.
- **F10** – Save changes made the Setup and close the utility.

Setup Utility Menus

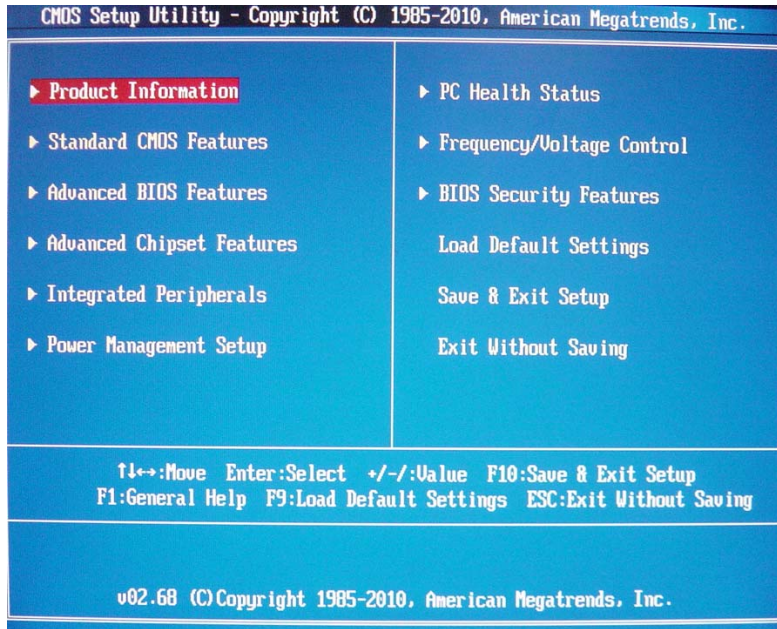

The Setup Main menu includes the following main setup categories.

Parameter	Description
Product Information	This page shows the relevant information of the main board
Standard CMOS Features	This setup page includes all the items in standard compatible BIOS
Advanced BIOS Features	This setup page includes all the items of Award special enhanced features
Advanced Chipset Features	This setup page includes all advanced chipset features
Integrated Peripherals	This setup page includes all onboard peripherals
Power Management Setup	This setup page includes all the items of Green function features
PC Health Status	This setup page is the System auto detect Temperature, voltage, and fan speed
Frequency/Voltage Control	This setup page is the System Frequency setup
BIOS Security Features	Change, set or disable password. It allows you to limit access to the System
Load Default Setting	Load Default Setting indicates the value of the system parameters which the system would be in best performance configuration
Save & Exit Setup	Save CMOS value settings to CMOS and exit setup
Exit Without Saving	Abandon all CMOS value changes and exit setup

In the descriptive table following each of the menu screenshots, settings in **boldface** are the default and suggested settings.

Product Information

The Product Information menu displays basic information about the system. These entries are for your reference only and are not user-configurable.

CMOS Setup Utility - Copyright (C) 1985-2010, American Megatrends, Inc.	
Product Information	
	Help Item
Processor Type : Intel(R) Pentium(R) CPU G6950 @ 2.80GHz	
Processor Speed : :2.80GHz	
System Memory : :2048MB	
Product Name : :Aspire M5910	
System Serial Number :	
System BIOS Version : :P01-A0	
BIOS Release Date : :03/19/2010	
Asset Tag Number :	
↑↓←→:Move Enter:Select +/-:Value F10:Save & Exit Setup F1:General Help F9:Load Default Settings ESC:Exit Without Saving	

Parameter	Description
Processor Type	Type of CPU installed on the system.
Processor Speed	Speed of the CPU installed on the system.
System Memory	Total size of system memory installed on the system.
Product Name	Product name of the system.
System Serial Number	Serial number of the system.
System BIOS Version	Version number of the BIOS setup utility.
BIOS Release Date	Date when the BIOS setup utility was released
Asset Tag Number	Asset tag number of this system.

Standard CMOS Features

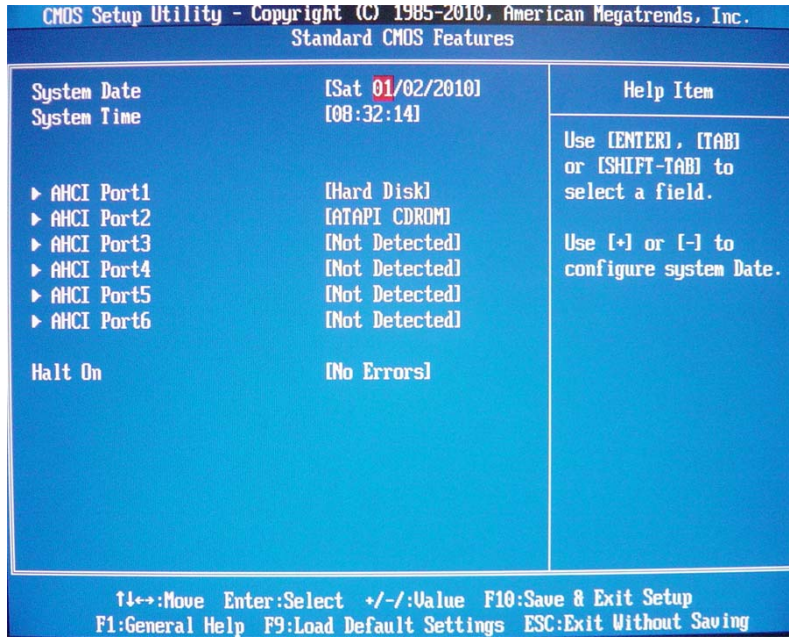

Parameter	Description	Option
System Date	Set the date following the weekday-month-day-year format.	
System Time	Set the system time following the hour-minute-second format.	
Halt On	Determines whether the system will stop for an error during the POST.	All, But Keyboard No Errors All Errors

Advanced BIOS Feature

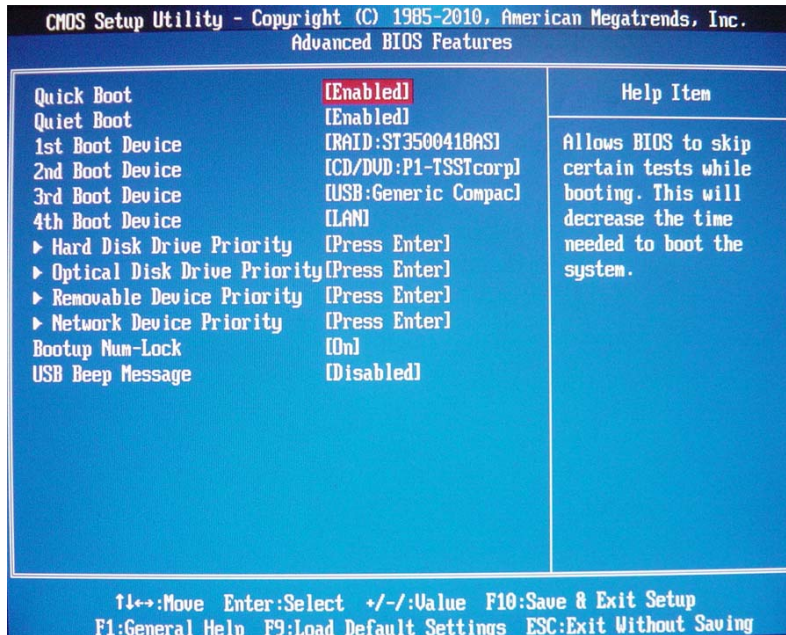

Parameter	Description	Option
Quick Boot	Allows you to decrease the time it takes to boot the computer by shortening or skipping certain standard booting process.	Enabled Disabled
Quiet Boot	When enabled, the BIOS splash screen displays during startup. When disabled, the diagnostic screen displays during startup.	Enabled Disabled
1st/2nd/3rd/4th Boot Device	Specifies the boot order from the available devices.	Hard Disk CD^DVD Removable Device LAN
Hard Disk Drive Priority	Press Enter to access the Hard Disk Drive Priority submenu and specify the boot device priority sequence from available hard drives.	
Optical Disk Drives Priority	Press Enter to access the Optical Disk Drive Priority submenu and specify the boot device priority sequence from available CD/DVD drives.	
Removable Device Priority	Press Enter to access the Removable Device Priority submenu and specify the boot device priority sequence from available removable drives.	
Bootup Num-Lock	Selects power on state for Num Lock.	On Off
USB Beep Message	Enables or disables BIOS to display error beeps or messages during USB device enumeration.	Disabled Enabled

Advanced Chipset Features

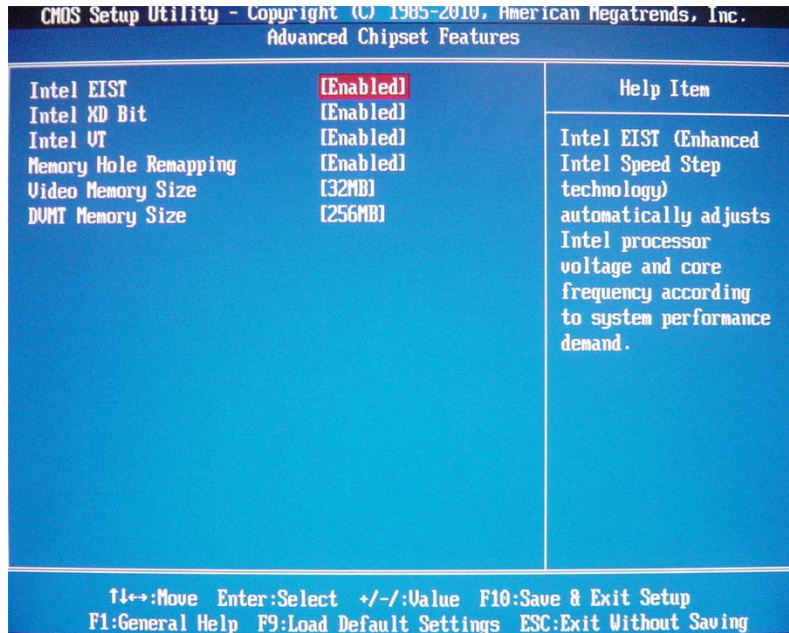

Parameter	Description	Option
Intel EIST	When enabled, this feature allows the OS to reduce power consumption. When disabled, the system operates at maximum CPU speed.	Enabled Disabled
Intel XD Bit	When enabled, the processor disables code execution when a worm attempts to insert a code in the buffer preventing damage and worm propagation. When disabled, the processor forces the Execute Disable (XD) Bit feature flag to always return to 0.	Enabled Disabled
Intel VT	Enables or disables the Virtualization Technology (VT) availability. If enabled, a virtual machine manager (VMM) can utilize the additional hardware virtualization capabilities provided by this technology. Note: A full reset is required to change the setting.	Enabled Disabled
Memory Hole Remapping	Enables or disables remapping of overlapped PCI memory above the total physical memory.	Enabled Disabled
Video Memory Size	Select a Video memory size	32MB
DVMT Memory Size	Select a DVMT memory size	256MB

Integrated Peripherals

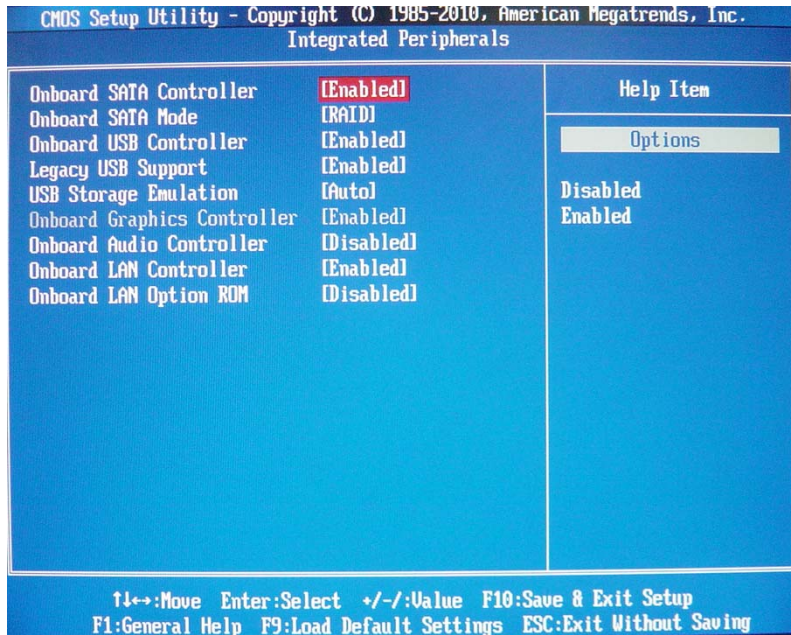

Parameter	Description	Option
Onboard SATA Controller	Enables or disables the onboard SATA controller.	Enabled Disabled
Onboard SATA Mode	Select an operating mode for the onboard SATA.	RAID Native IDE
Onboard USB Controller	Enables or disables the onboard USB controller.	Enabled Disabled
Legacy USB Support	Enables or disables support for legacy USB devices.	Enabled Disabled
USB Storage Emulation	Enables or disables support for legacy USB devices.	Enabled Disabled
Onboard Audio Controller	Enables or disables the onboard audio controller.	Enabled Disabled
Onboard LAN Controller	Enables or disables the onboard LAN controller.	Enabled Disabled
Onboard LAN Option ROM	Enables or disables the load of embedded option ROM for onboard network controller.	Enabled Disabled

Power Management Setup

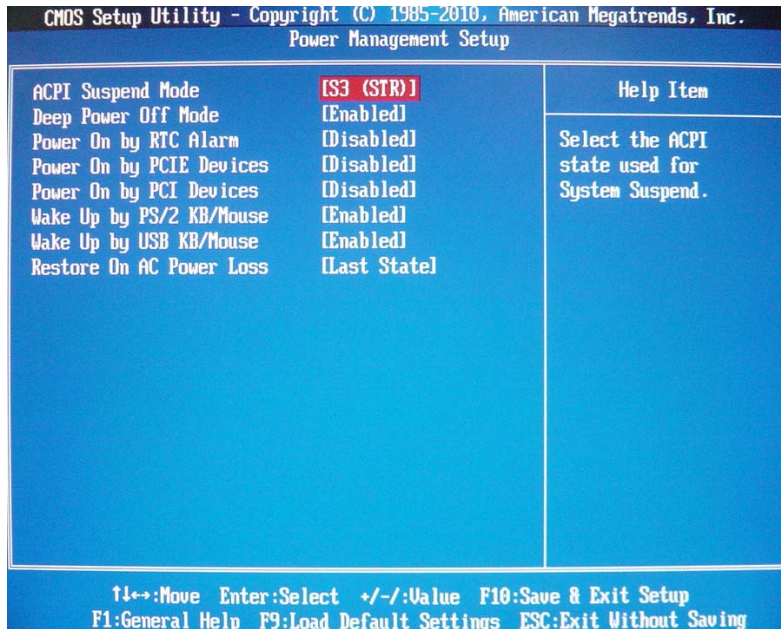

Parameter	Description	Option
ACPI Suspend Mode	Select an ACPI state.	S3 (STR) S1 (POS)
Deep power off mode	Select the Deep power off Mode	Enabled Disabled
Power On by RTC Alarm	Enables or Disables to wake up the system by RTC Alarm Function	Enabled Disabled
Power On by PCIE Devices	Enables or disables to wake up the system from a power saving mode through an event on PCI Express device.	Enabled Disabled
Power On by PCI Devices	Enables or disables to wake up the system from a power saving mode through an event on PCI device.	Enabled Disabled
Wake Up by PS/2 KB/ Mouse	Enables or disables to wake up the system from a power saving mode using a PS2 keyboard or mouse.	Enabled Disabled
Wake Up by USB KB/ Mouse	If enabled, press any key or click the mouse will wake system from S1/ S3 state.	Enabled Disabled
Restore On AC Power Loss	Enables or disables the system to reboot after a power failure or interrupt occurs.	Power Off Power On Last State

PC Health Status

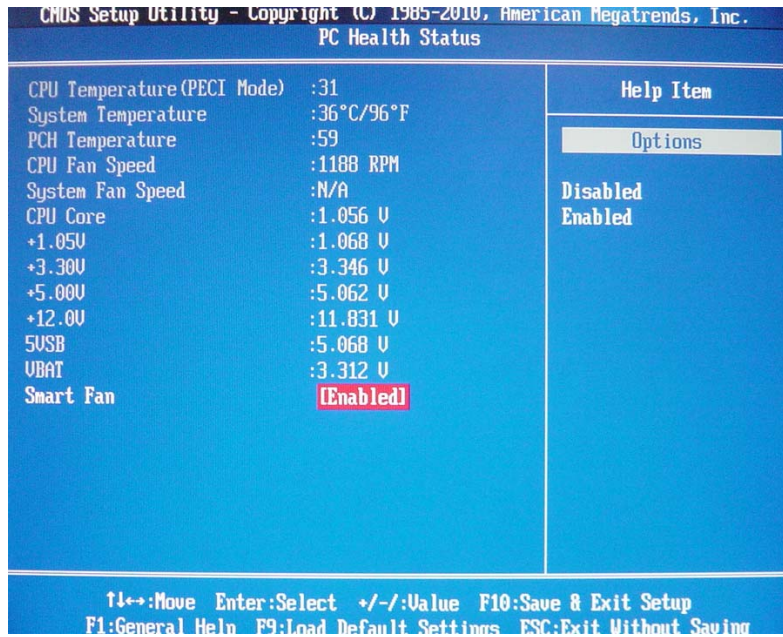

Parameter	Description	Option
Smart FAN	Enables or disables the smart system fan control function.	Enabled Disabled

Frequency/Voltage Control

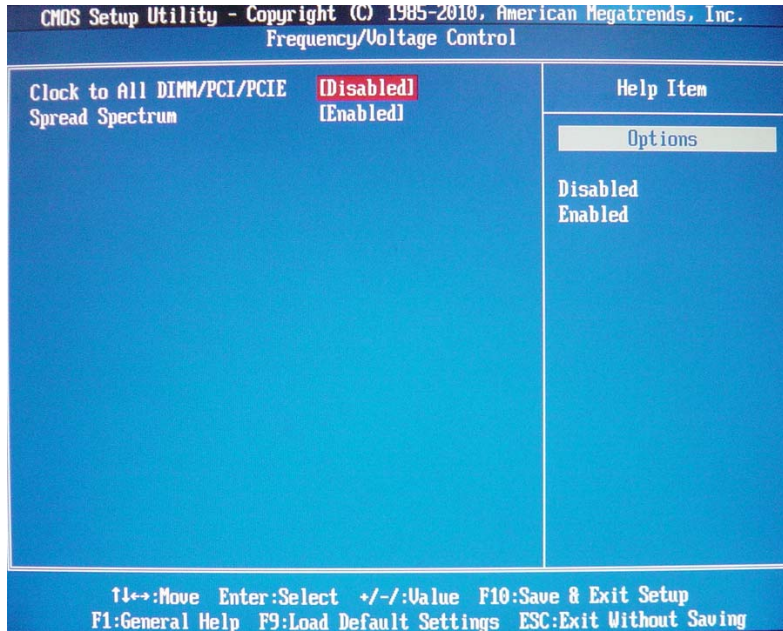

Parameter	Description	Option
Clock to All DIMM/PCI	Enables or disables control the clock to all DIMM/PCI	Enabled Disabled
Spread Spectrum	Enables or disables the reduction of the mainboard's EMI. Note: Remember to disable the Spread Spectrum feature if you are overclocking. A slight jitter can introduce a temporary boost in clock speed causing the overclocked processor to lock up.	Enabled Disabled

BIOS Security Features

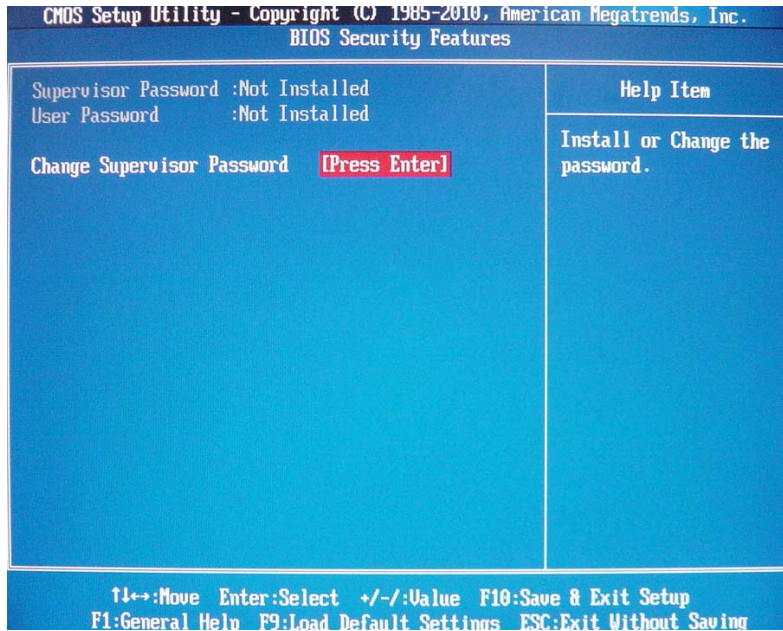

Parameter	Description
Supervisor Password	Indicates the status of the supervisor password.
User Password	Indicates the status of the user password.
Change Supervisor Password	Supervisor password prevents unauthorized access to the BIOS Setup Utility. Press Enter to change the Supervisor password.

Setting a supervisor password

1. Use the up/down arrow keys to select Change Supervisor Password menu then press **Enter**.
A password box will appear.
2. Type a password then press **Enter**.
The password may consist up to six alphanumeric characters (A-Z, a-z, 0-9)
3. Retype the password to verify the first entry then press **Enter** again.
4. Press **F10**.
5. Select **Yes** to save the new password and close the Setup Utility.

Changing the supervisor password

1. Use the up/down arrow keys to select Change Supervisor Password menu then press **Enter**.
2. Type the original password then press **Enter**.
3. Type a new password then press **Enter**.
4. Retype the password to verify the first entry then press **Enter** again.
5. Press **F10**.
6. Select **Yes** to save the new password and close the Setup Utility.

Removing a supervisor password

1. Use the up/down arrow keys to select Change Supervisor Password menu then press **Enter**.
2. Enter the current password then press **Enter**.
3. Press **Enter** twice without entering anything in the password fields.

Load Default Settings

The Load Default Settings menu allows you to load the default settings for all BIOS setup parameters. Setup defaults are quite demanding in terms of resources consumption. If you are using low-speed memory chips or other kinds of low-performance components and you choose to load these settings, the system might not function properly.

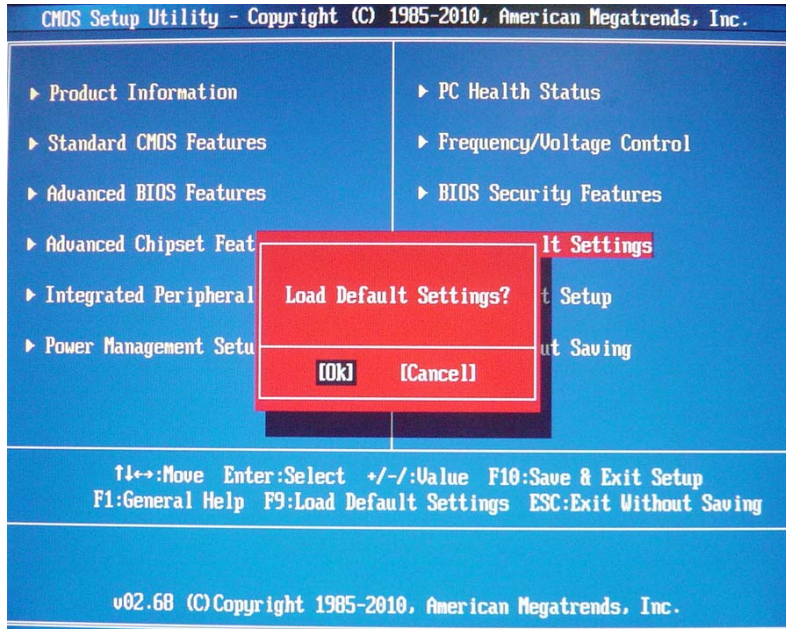

Save & Exit Setup

The Save & Exit Setup menu allows you to save changes made and close the Setup Utility.

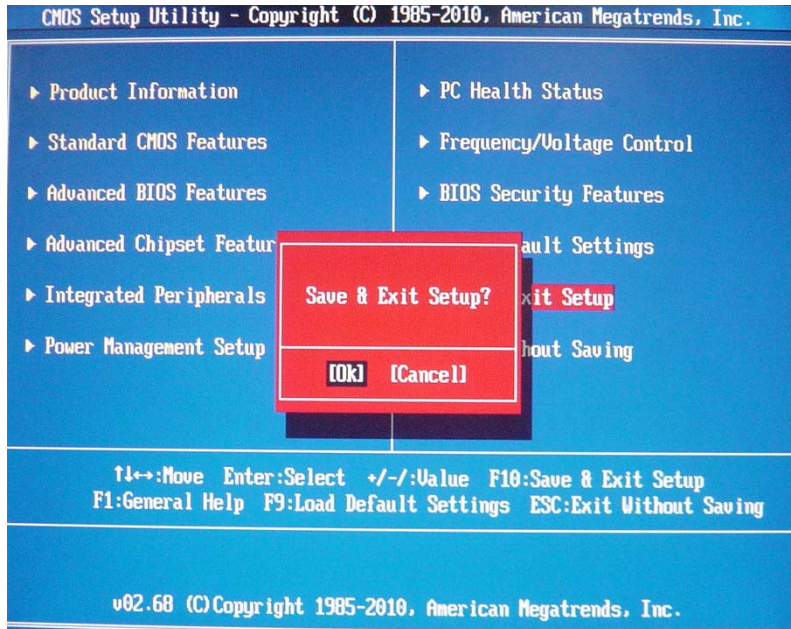

Exit Without Saving

The Exit Without Saving menu allows you to discard changes made and close the Setup Utility.

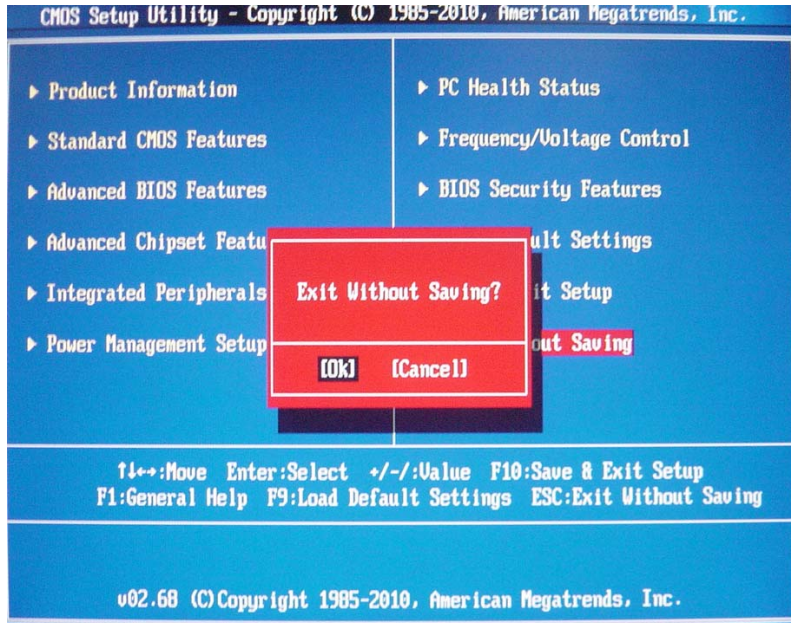

System Disassembly

This chapter contains step-by-step procedures on how to disassemble the desktop computer for maintenance and troubleshooting.

Disassembly Requirements

To disassemble the computer, you need the following tools:

- Wrist grounding strap and conductive mat for preventing electrostatic discharge
- Flat-blade screwdriver
- Philips screwdriver
- Hex screwdriver
- Plastic flat-blade screwdriver
- Plastic tweezers

NOTE: The screws for the different components vary in size. During the disassembly process, group the screws with the corresponding components to avoid mismatch when putting back the components.

Pre-disassembly Procedure

Before proceeding with the disassembly procedure, perform the steps listed below:

1. Turn off the system and all the peripherals connected to it.
2. Unplug the power cord from the power outlets.
3. Unplug the power cord from the system.
4. Unplug all peripheral cables from the system.
5. Place the system unit on a flat, stable surface.

Removing the Side Panel

1. Remove the two screws located on the rear edge of the side panel.



2. Slide the side panel toward the back of the chassis until the tabs on the cover disengage with the slots on the chassis.
3. Lift the side panel away from the server and put it aside for reinstallation later.



Removing the Heat Sink Fan Assembly

WARNING: The heat sink becomes very hot when the system is on. NEVER touch the heat sink with any metal or with your hands.

1. disconnect the fan cable from the mainboard.



2. Use a long-nosed screwdriver to loosen the four screws on the heat sink, in the order as shown below.

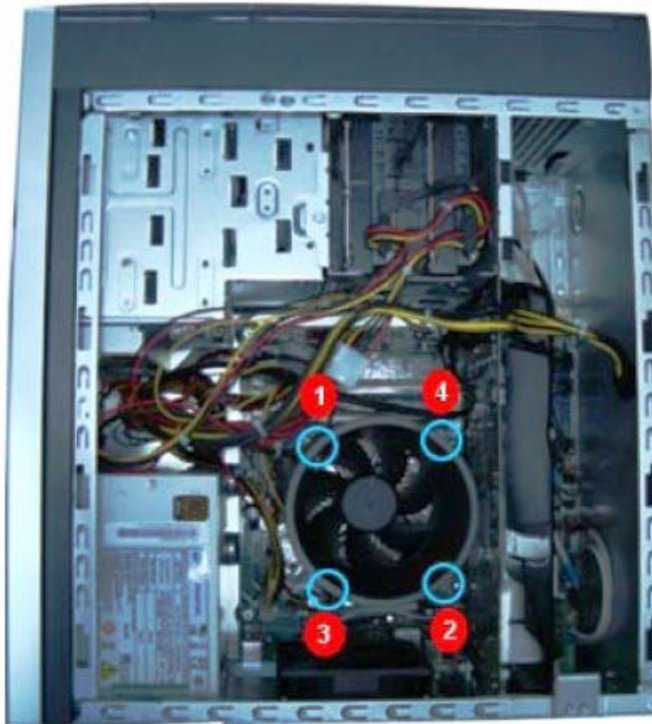

3. Lift the heat sink fan assembly away from the mainboard.

Removing the Processor

IMPORTANT: Before removing a processor from the mainboard, make sure to create a backup file of all important data.

WARNING: The processor becomes very hot when the system is on. Allow it to cool off first before handling.

1. Release the load lever.



2. Lift the load lever and load plate to the fully open, upright position (1) and (2).
3. Pull out the processor from the socket.

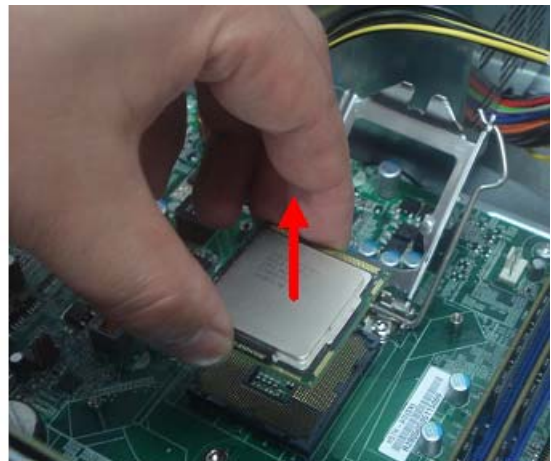
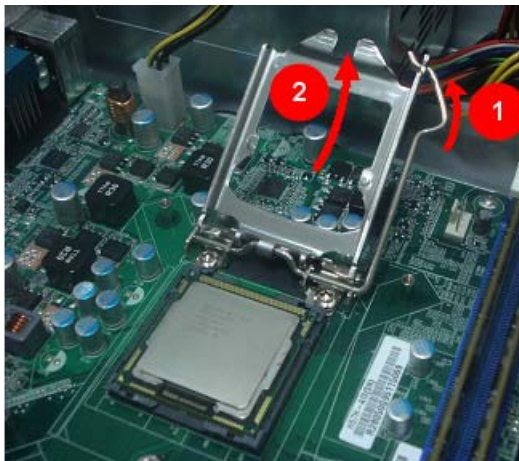

IMPORTANT: If you are going to install a new processor, note the arrow on the corner to make sure the processor is properly oriented over the socket.



Removing the VGA Card

1. Release the Slot cover lock.

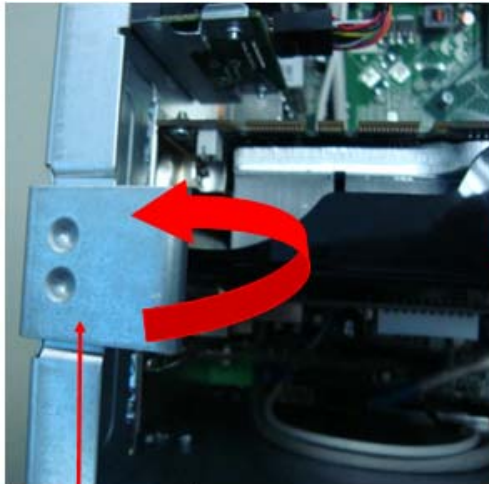

Slot Cover Lock



2. Remove the screw from chassis.
3. Disconnect the power cables from the VGA card.

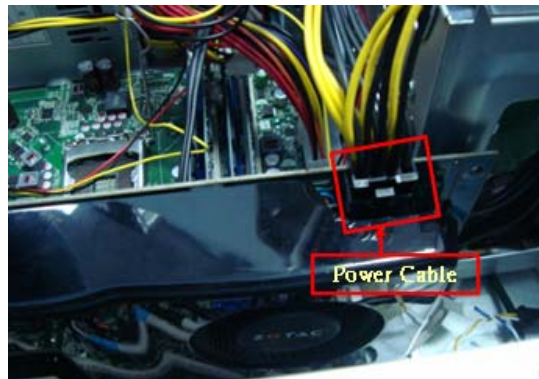
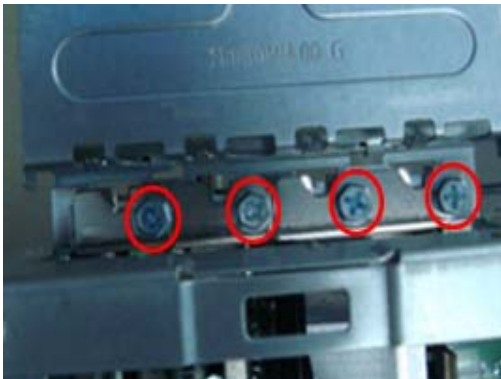

4. One finger Press the clip and the same time Gently pull the card to remove it from the mainboard.

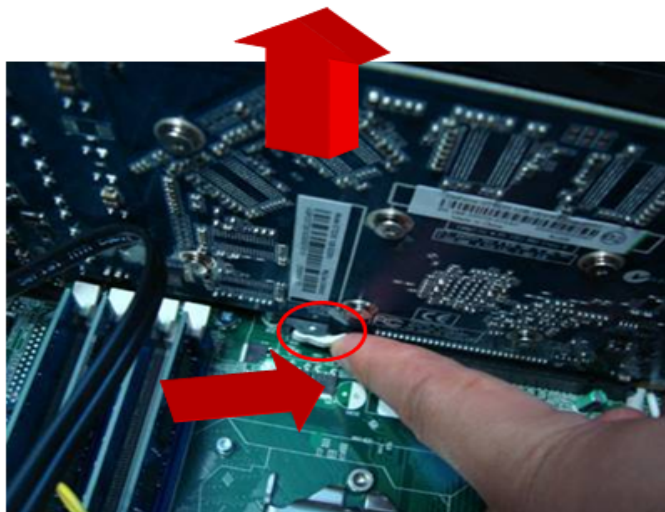

Removing the TV Card

1. Gently pull the TV card to remove it from the mainboard.



Removing the Mode Card

1. Gently pull the Mode card to remove it from the mainboard.

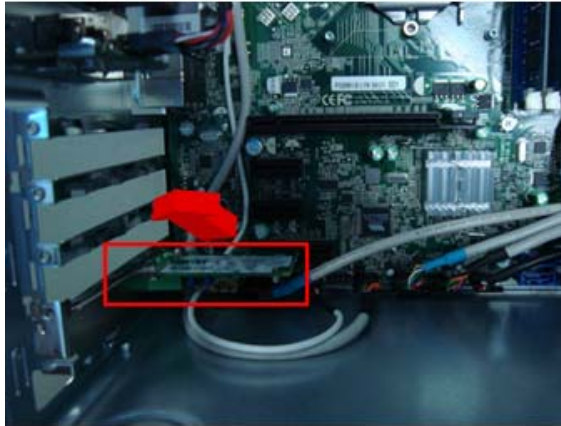

Removing the Hard Disk Drive

1. Disconnect the data and power cables from the rear of the optical drive and the mainboard.

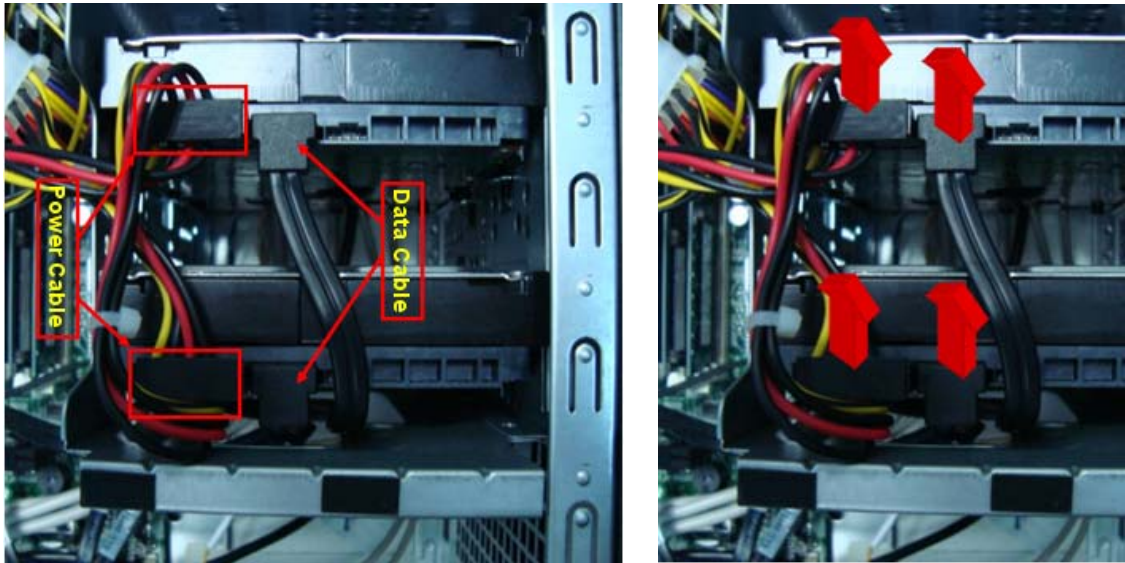

2. Remove the HDD bracket
 - a. Remove the screw that secures the HDD bracket to the ODD bracket.

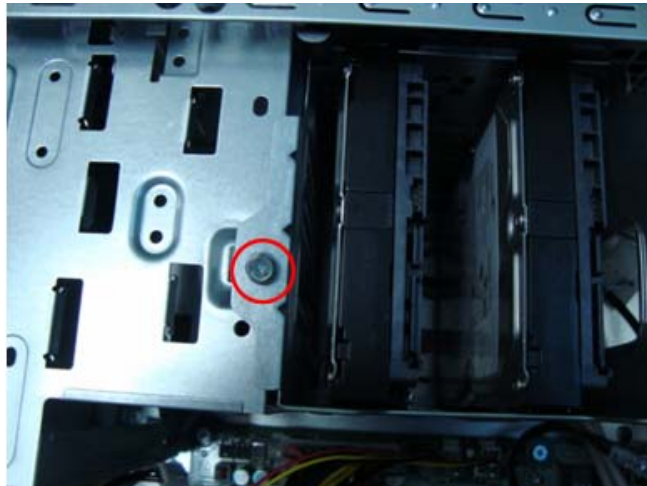

- b. Lift the bracket up and turn it over.

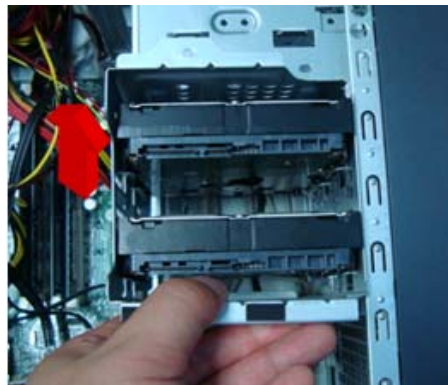

3. Remove the HDD module

- a. Remove the eight screws secure the HDD module to the HDD bracket.

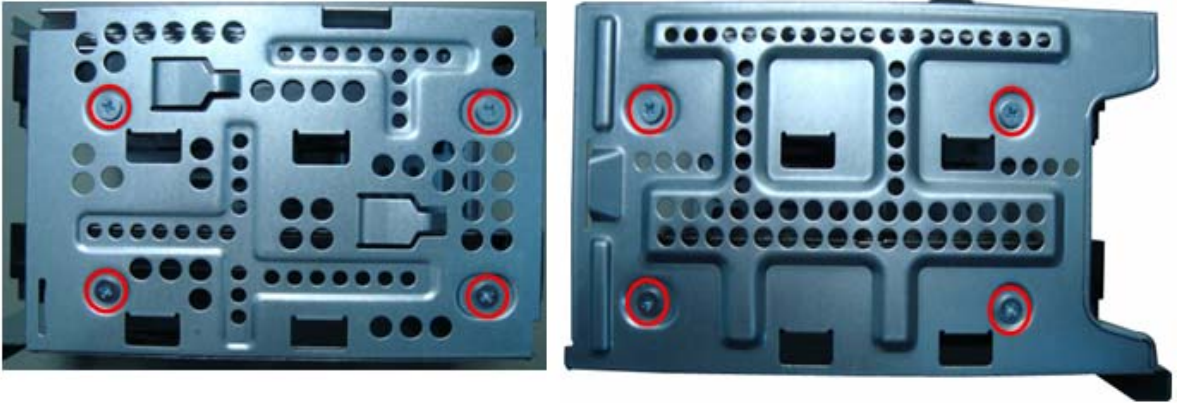

- b. Slide the HDD out of the bracket.

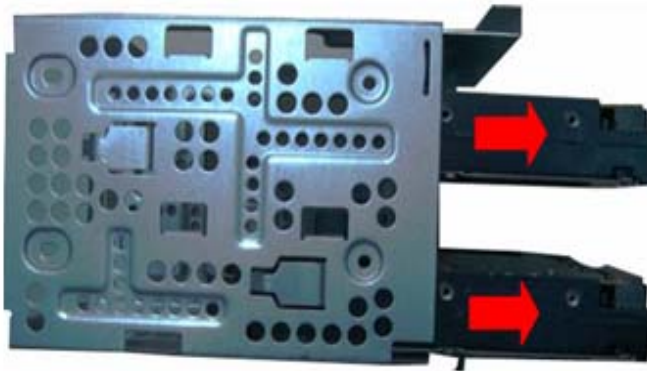

Removing the Front Bezel

1. Disconnect the LED cable.

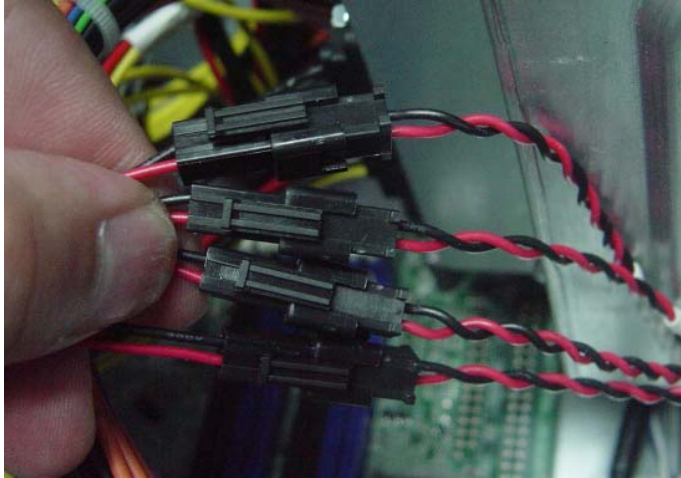

2. Release the front bezel from the chassis interior.

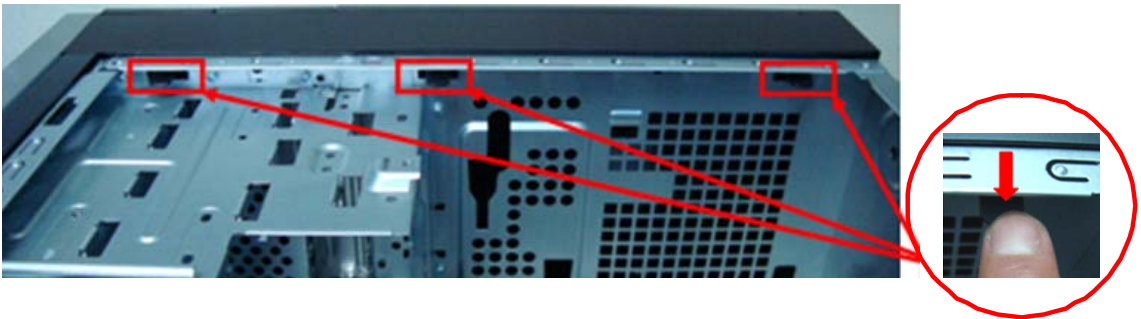

3. Pull the bezel away from the chassis.

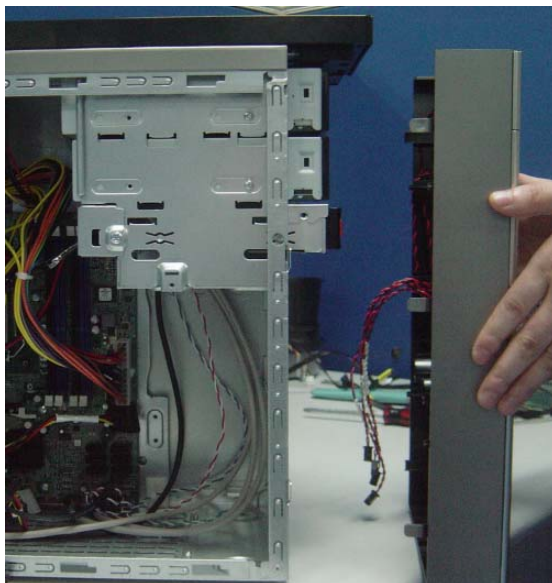

Removing Rear USB Board

1. Remove USB cable

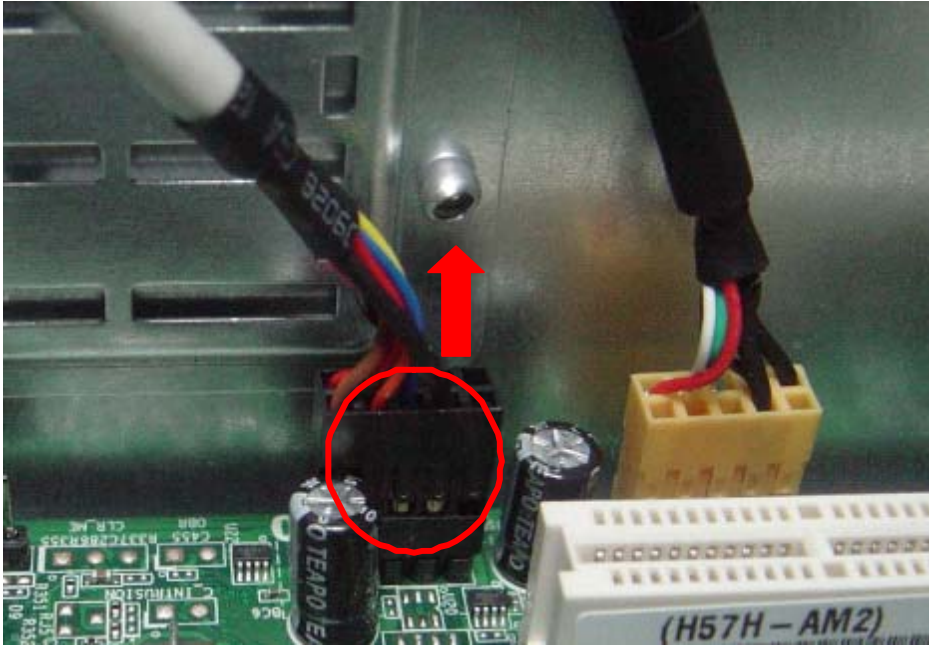

2. Release the screw of rear usb.



3. Remove the rear usb board.



Removing the Cables

1. Remove power switch and LED cables from slot of M/B
2. Remove HDD Data and ODD Data cables from slot of M/B.

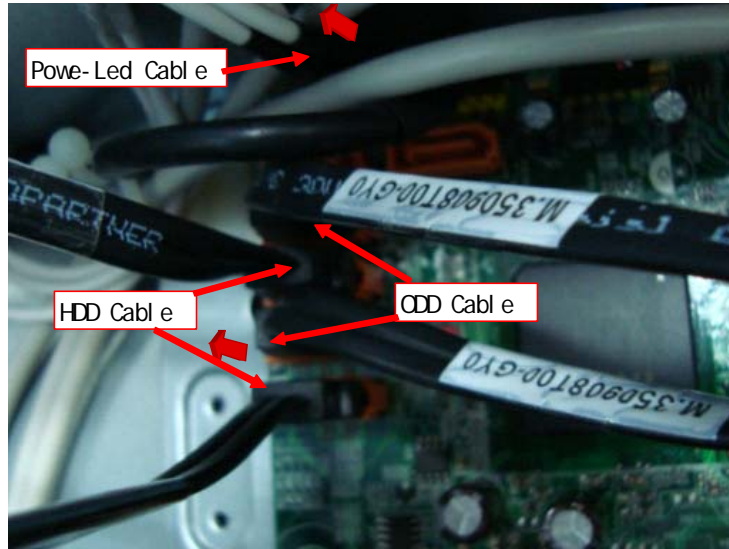

3. Remove USB1/2/3 cable from M/B.
4. Remove FIO cable and Audio cable from M/B

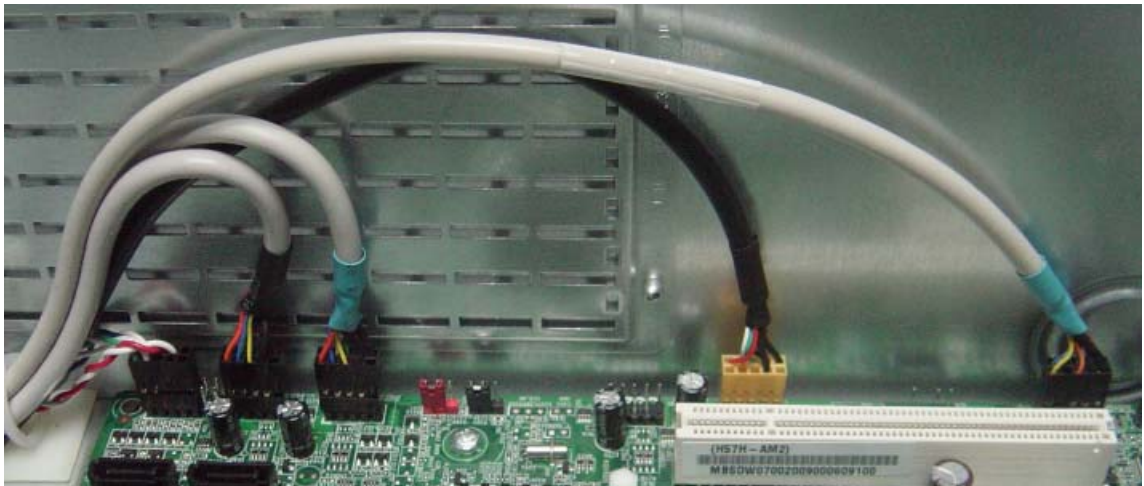

Remove System FAN

1. Remove System FAN cable from M/B.

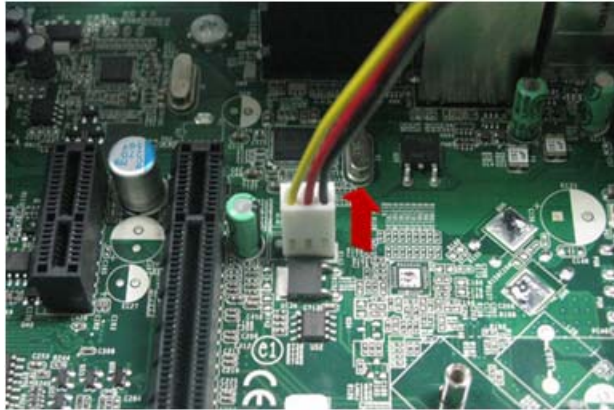

2. Release four screws according to the following picture.



3. Take off the system fan from chassis.

Removing the Optical Drive

1. Disconnect the data and power cables from the rear of the optical drive.

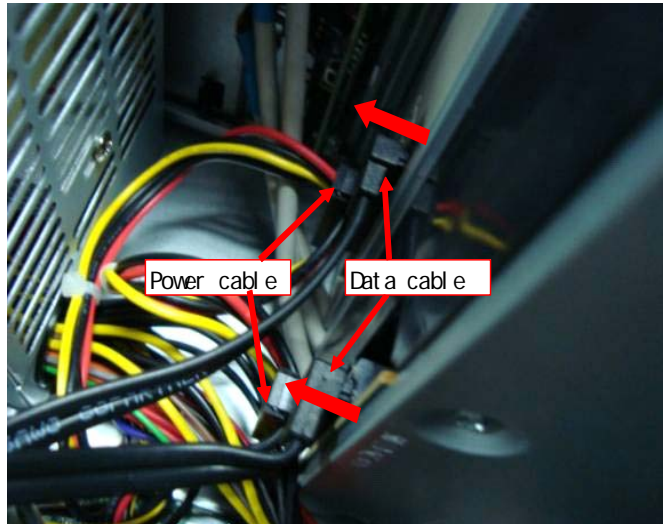

2. Remove Four screw from the optical drive.

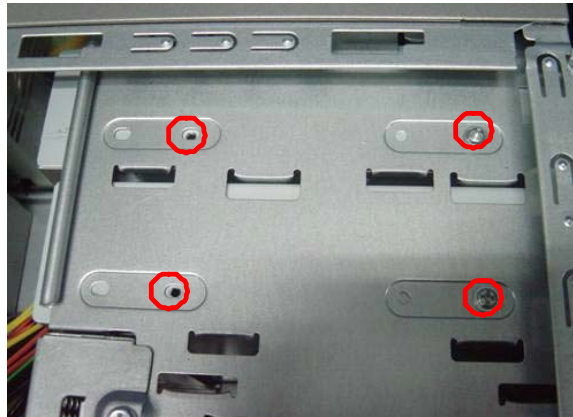

3. Pull the drive out of the drive.



Removing the Power Supply

1. Disconnect the 24-pin and 4-pin power supply cables from the mainboard.

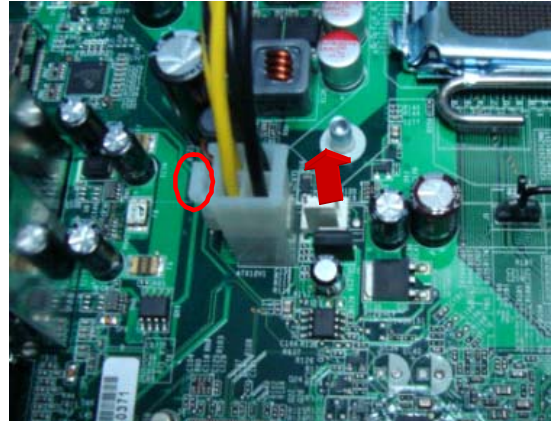
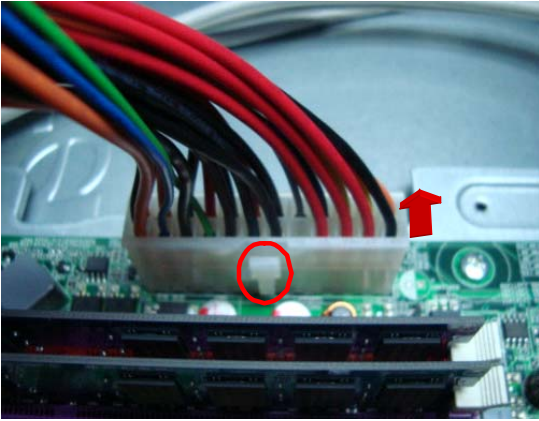

2. Remove the four screws that secure the power supply to the chassis.

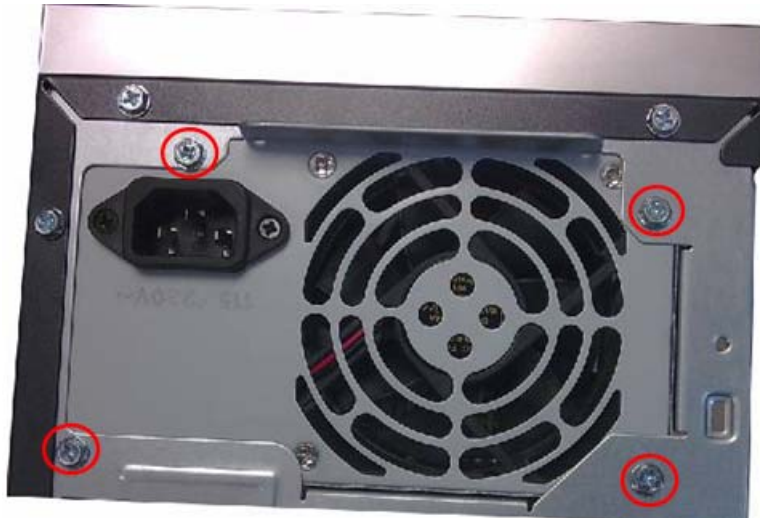

3. Lift the power supply module out of the chassis.



Removing the Memory Modules

IMPORTANT: Before removing any DIMM from the memory board, make sure to create a backup file of all important data.

1. Press the holding clips on both sides of the DIMM slot outward to release the DIMM.
2. Gently pull the DIMM upward to pull it away from the M/B.

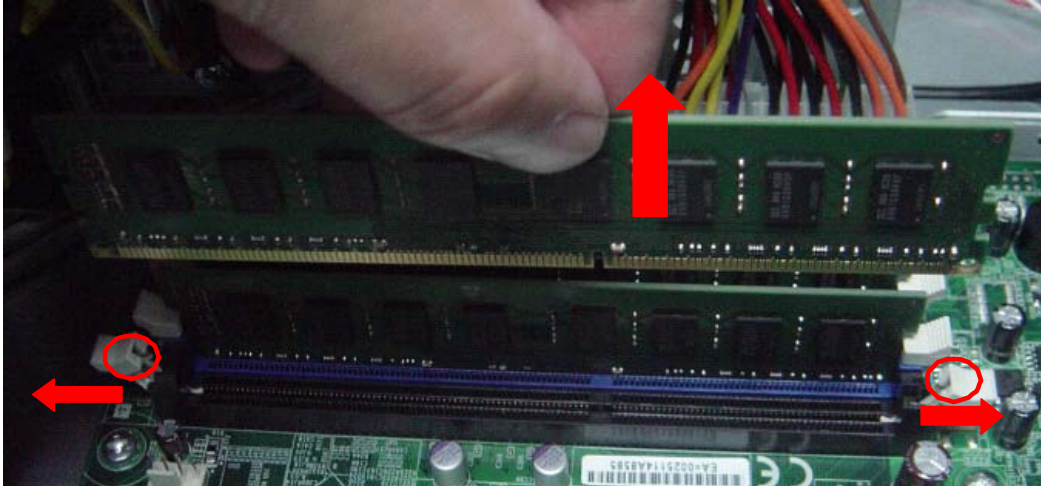

Removing the removable HDD bay

1. Remove the HDD rail



2. Remove the screws that secure the HDD bay.

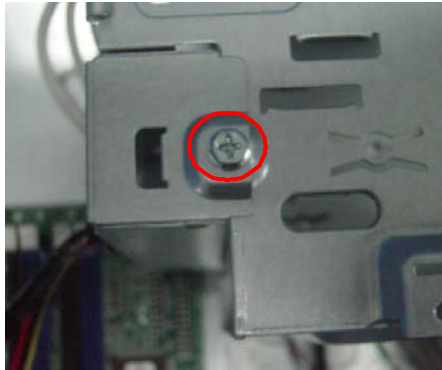

3. Remove the HDD bay.

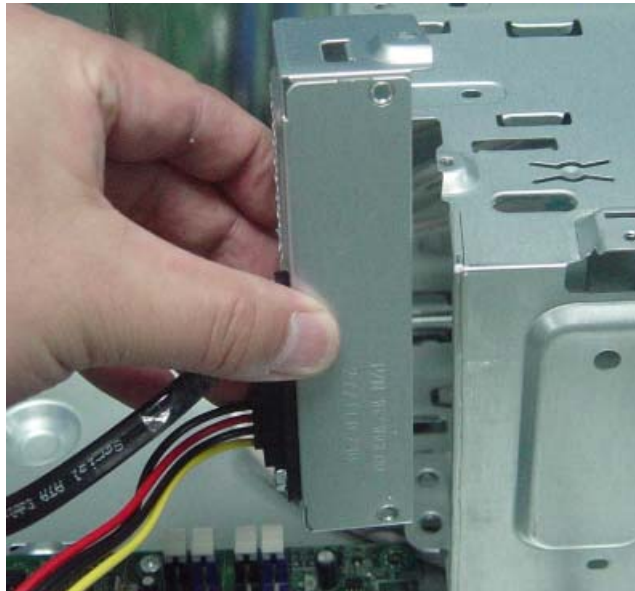

Removing the Mainboard

1. Remove the eight screws that secure the mainboard to the chassis.

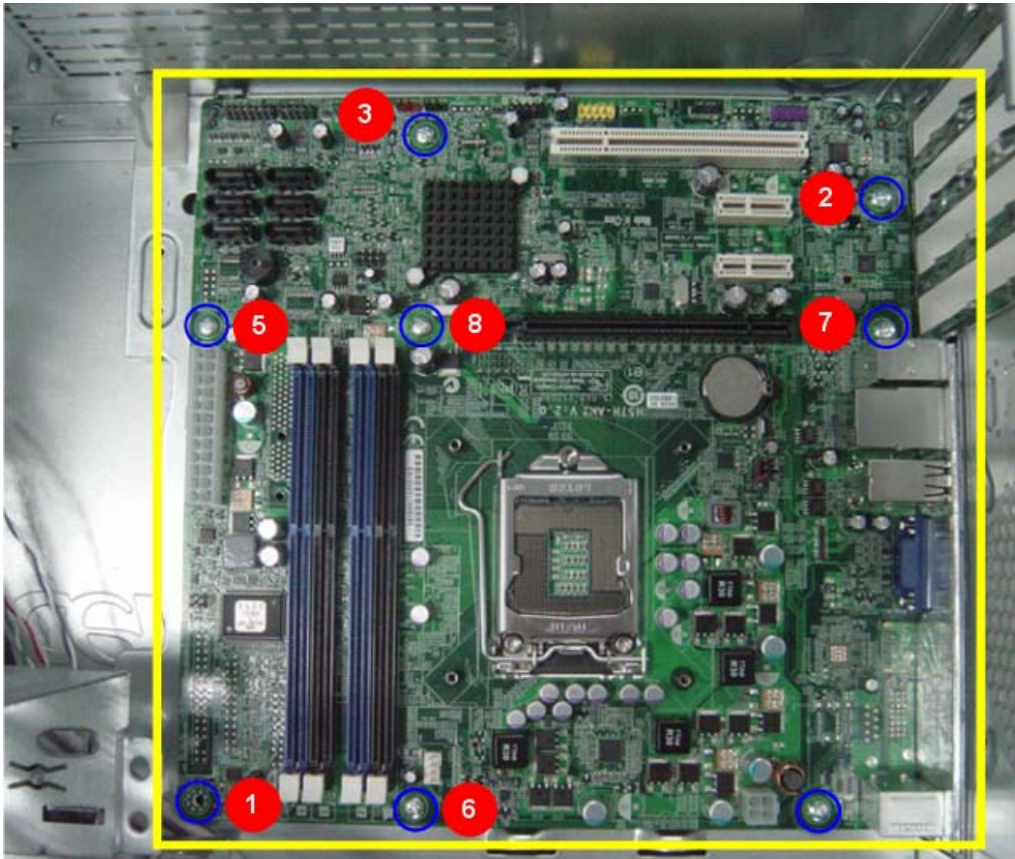

Note: Circuit boards >10 cm² has been highlighted with the yellow rectangle as above image shows.

Please detach the Circuit boards and follow local regulations for disposal.

2. Lift the board from the chassis.



3. Remove the RTC battery.

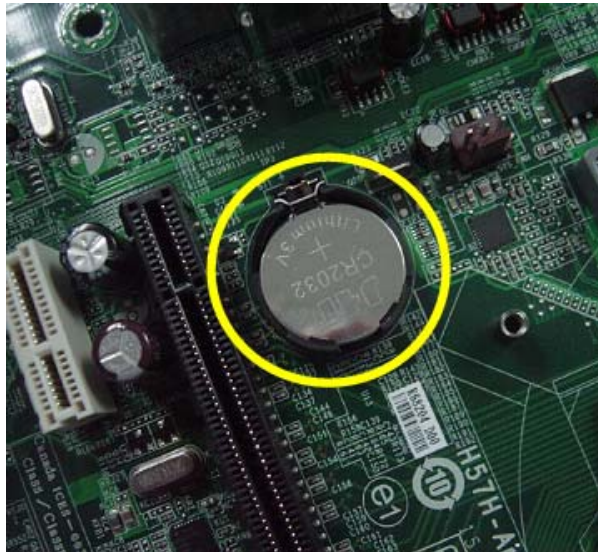

System Troubleshooting

This chapter provides instructions on how to troubleshoot system hardware problems.

Hardware Diagnostic Procedure

IMPORTANT: The diagnostic tests described in this chapter are only intended to test Acer products. Non-Acer products, prototype cards, or modified options can give false errors and invalid system responses.

1. Obtain the failing symptoms in as much detail as possible.
2. Verify the symptoms by attempting to recreate the failure by running the diagnostic tests or repeating the same operation.
3. Refer to “Power System check” and “Beep Codes” to determine which corrective action to perform.

System Check Procedures

Power System Check

If the system will power on, skip this section. Refer to System External Inspection.

If the system will not power on, do the following:

- Check if the power cable is properly connected to the system and AC source.
- Check if the voltage selector switch is set to the correct voltage setting.

System External Inspection

1. Inspect the LED indicators on the front panel, which can indicate the malfunction.
2. Make sure that air flow is not blocked.
3. Make sure nothing in the system is making contact that could short out power.
4. If the problem is not evident, continue with System Internal Inspection.

System Internal Inspection

1. Turn off the system and all the peripherals connected to it.
2. Unplug the power cord from the power outlets.
3. Unplug the power cord from the system.
4. Unplug all peripheral cables from the system.
5. Place the system unit on a flat, stable surface.
6. Remove the system covers. For instructions on removing system covers, refer to "System Disassembly".
7. Verify that components are properly seated.
8. Verify that all cable connectors inside the system are firmly and correctly attached to their appropriate connectors.
9. Verify that all components are Acer-qualified and supported.
10. Replace the system covers.
11. Power on the system.
12. If the problem with the system is not evident, you can try viewing the POST messages and BIOS event logs during the system startup.

Beep Codes

Beep codes are used by the BIOS to indicate a serious or fatal error to the end user. Beep codes are used when an error occurs before the system video has been initialized. Beep codes will be generated by the system board speaker, commonly referred to as the PC speaker.

AMIBIOS displays the checkpoints in the bottom right corner of the screen during POST. This display method is limited, since it only displays checkpoints that occur after the video card has been activated.

Not all computers using AMIBIOS enable this feature. In most cases, a checkpoint card is the best tool for viewing AMIBIOS checkpoints.

Beep Symptom	Cause and Description
One short beep	System is ready. System is OK.
Continuous one long beep	Memory not installed or memory error.
One long beep and two short beeps then repeat.	VGA not installed or VGA error. Graphics card error/not installed, graphics card memory error or graphics card BIOS checksum error.
One long beep then two short beep	BIOS damaged. BIOS is damaged, BIOS POST jumps to Boot Block to execute the default procedures.
Two short beeps	CMOS damaged. CMOS checksum error or CMOS battery loss occurs.

Checkpoints

A checkpoint is either a byte or word value output to I/O port 80h. The BIOS outputs checkpoints throughout bootblock and Power-On Self Test (POST) to indicate the task the system is currently executing. Checkpoints are very useful in aiding software developers or technicians in debugging problems that occur during the pre-boot process.

Viewing BIOS checkpoints

Viewing all checkpoints generated by the BIOS requires a checkpoint card, also referred to as a POST card or POST diagnostic card. These are ISA or PCI add-in cards that show the value of I/O port 80h on a LED display. Checkpoints may appear on the bottom right corner of the screen during POST. This display method is limited, since it only displays checkpoints that occur after the video card has been activated.

Bootblock Initialization Code Checkpoints

The Bootblock initialization code sets up the chipset, memory, and other components before system memory is available. The following table describes the type of checkpoints that may occur during the bootblock initialization portion of the BIOS.

NOTE: Please note that checkpoints may differ between different platforms based on system configuration. Checkpoints may change due to vendor requirements, system chipset or option ROMs from add-in PCI devices.

Checkpoint	Description
Before D0	If boot block debugger is enabled, CPU cache-as-RAM functionality is enabled at this point. Stack will be enabled from this point.
D0	Early Boot Strap Processor (BSP) initialization like microcode update, frequency and other CPU critical initialization. Early chipset initialization is done.
D1	Early super I/O initialization is done including RTC and keyboard controller. Serial port is enabled at this point if needed for debugging. NMI is disabled. Perform keyboard controller BAT test. Save power-on CPUID value in scratch CMOS. Go to flat mode with 4GB limit and GA20 enabled.
D2	Verify the boot block checksum. System will hang here if checksum is bad.
D3	Disable CACHE before memory detection. Execute full memory sizing module. If memory sizing module not executed, start memory refresh and do memory sizing in Boot block code. Do additional chipset initialization. Re-enable CACHE. Verify that flat mode is enabled.
D4	Test base 512KB memory. Adjust policies and cache first 8MB. Set stack.
D5	Bootblock code is copied from ROM to lower system memory and control is given to it. BIOS now executes out of RAM. Copies compressed boot block code to memory in right segments. Copies BIOS from ROM to RAM for faster access. Performs main BIOS checksum and updates recovery status accordingly.
D6	Both key sequence and OEM specific method is checked to determine if BIOS recovery is forced. Main BIOS checksum is tested. If BIOS recovery is necessary, control flows to checkpoint E0. See Bootblock Recovery Code Checkpoints section for more information.
D7	Restore CPUID value back into register. The Bootblock-Runtime interface module is moved to system memory and control is given to it. Determine whether to execute serial flash.
D8	The Runtime module is uncompressed into memory. CPUID information is stored in memory.
D9	Store the Uncompressed pointer for future use in PMM. Copying Main BIOS into memory. Leaves all RAM below 1MB Read-Write including E000 and F000 shadow areas but closing SMRAM.

Checkpoint	Description
DA	Restore CPUID value back into register. Give control to BIOS POST (ExecutePOSTKernel). See POST Code Checkpoints section of document for more information.
DC	System is waking from ACPI S3 state.
E1-E8 EC-EE	OEM memory detection/configuration error. This range is reserved for chipset vendors & system manufacturers. The error associated with this value may be different from one platform to the next.

Bootblock Recovery Code Checkpoints

The Bootblock recovery code gets control when the BIOS determines that a BIOS recovery needs to occur because the user has forced the update or the BIOS checksum is corrupt. The following table describes the type of checkpoints that may occur during the Bootblock recovery portion of the BIOS.

NOTE: Checkpoints may differ between different platforms based on system configuration. Checkpoints may change due to vendor requirements, system chipset or option ROMs from add-in PCI devices.

Checkpoint	Description
E0	Initialize the floppy controller in the super I/O. Some interrupt vectors are initialized. DMA controller is initialized. 8259 interrupt controller is initialized. L1 cache is enabled.
E9	Set up floppy controller and data. Attempt to read from floppy.
EA	Enable ATAPI hardware. Attempt to read from ARMD and ATAPI CDROM.
EB	Disable ATAPI hardware. Jump back to checkpoint E9.
EF	Read error occurred on media. Jump back to checkpoint EB.
F0	Search for pre-defined recovery file name in root directory.
F1	Recovery file not found.
F2	Start reading FAT table and analyze FAT to find the clusters occupied by the recovery file.
F3	Start reading the recovery file cluster by cluster.
F5	Disable L1 cache.
FA	Check the validity of the recovery file configuration to the current configuration of the flash part.
FB	Make flash write enabled through chipset and OEM specific method. Detect proper flash part. Verify that the found flash part size equals the recovery file size.
F4	The recovery file size does not equal the found flash part size.
FC	Erase the flash part
FD	Program the flash part.
FF	The flash has been updated successfully. Make flash write disabled. Disable ATAPI hardware. Restore CPUID value back into register. Give control to F000 ROM at F000:FFF0h.

BIOS Recovery

1. This function only effects when the BIOS BootBlock section is healthy.
2. Allow to execute recovery function media: FDD / USB storage / ODD.
3. The recovery media to support Boot function is unnecessary.
4. Recovery step as follow:
 - 4-1. Copy the latest BIOS ROM file to the root directory of recovery media.
 - 4-2. Rename the BIOS ROM file to be "AMIBOOT.ROM".
 - 4-3. Insert the recovery device to system and then power on the system.
 - 4-4. Don't do anything during the recovery function to be progress but just only observe the recovery media has been loading or not.
 - 4-5. If the recovery function run normally, the recovery function will execute 1~3 minutes.
 - 4-6. The system will auto reboot after the recovery function finished and please enter the setup menu to load default after system reboot.

Jumper and Connector Information

M/B Placement

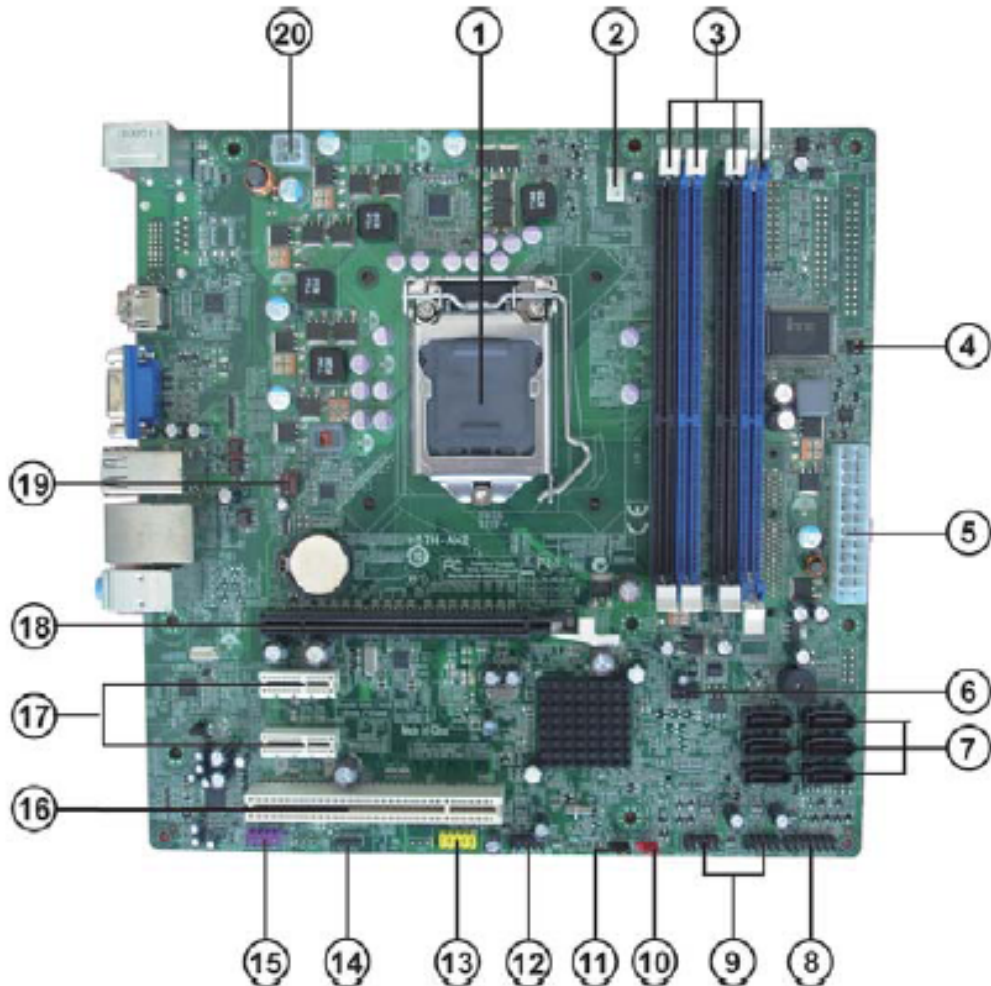

LABEL	COMPONENTS
1. CPU Socket	Supports the LGA1156 Intel Lynnfield/Havendale/Clarkdale processors
2. CPU_FAN	CPU cooling fan connector
3. DIMM1~4	240-Pin DDR3 SDRAM slots(Channel A: DIMM4, DIMM2 Channel B: DIMM3, DIMM1) * Single Channel Mode: DIMM2 must be populated. * Dual Channel Mode: DIMM2 and DIMM1 must be populated.
4. GPIO0~1	General Purpose I/O Signals
5. ATX1	Standard 24-pin ATX power connector
6. SPI_DEBUG	SPI debug header-factory use only
7. SATA1~6	Serial ATA connectors
8. F_PANEL	Front panel switch/LED header
9. F_USB3~4	Front panel USB headers
10. CLR_CMOS	Clear CMOS jumper
11. ME_DISABLE	ME disable jumper
12. F_USB2	Front panel USB header
13. F_USB1	Front panel USB header(Card Reader)
14. SPDIF_OUT1	SPDIF out header
15. F_AUDIO1	Front panel audio header
16. PCI1	32-bit add-on card slots
17. PCIE1X-1~2	PCI Express x1 slot
18. PCIE16X	PCI Express x16 slot
19. SYS_FAN	System cooling fan connector
20. ATX_12V	Auxiliary 4-pin power connector

Jumper Setting

The section explains how to set jumper for correct configuration of the mainboard.



Setting Jumper

Use the motherboard jumpers to set system configuration options. Jumpers with more Than one pin are numbered. When setting the jumpers, ensure that the jumper caps are Placed on the correct pins.

Checking Jumper Settings

The following illustration shows the location of the motherboard jumpers. Pin 1 is labeled.



Jumper	Type	Description	Setting (default)	
CLR_CMOS	3-pin	CLEAR CMOS	1-2: NORMAL 2-3: CLEAR Before clearing the CMOS, make sure to turn the system off.	 CLR_CMOS
ME_DISABLE		MEDISABLE	1-2: NORMAL 2-3: MEDISABLE	 ME_DISABLE

Connecting Optional Devices

Refer to the following for information on connecting the motherboard's optional devices:

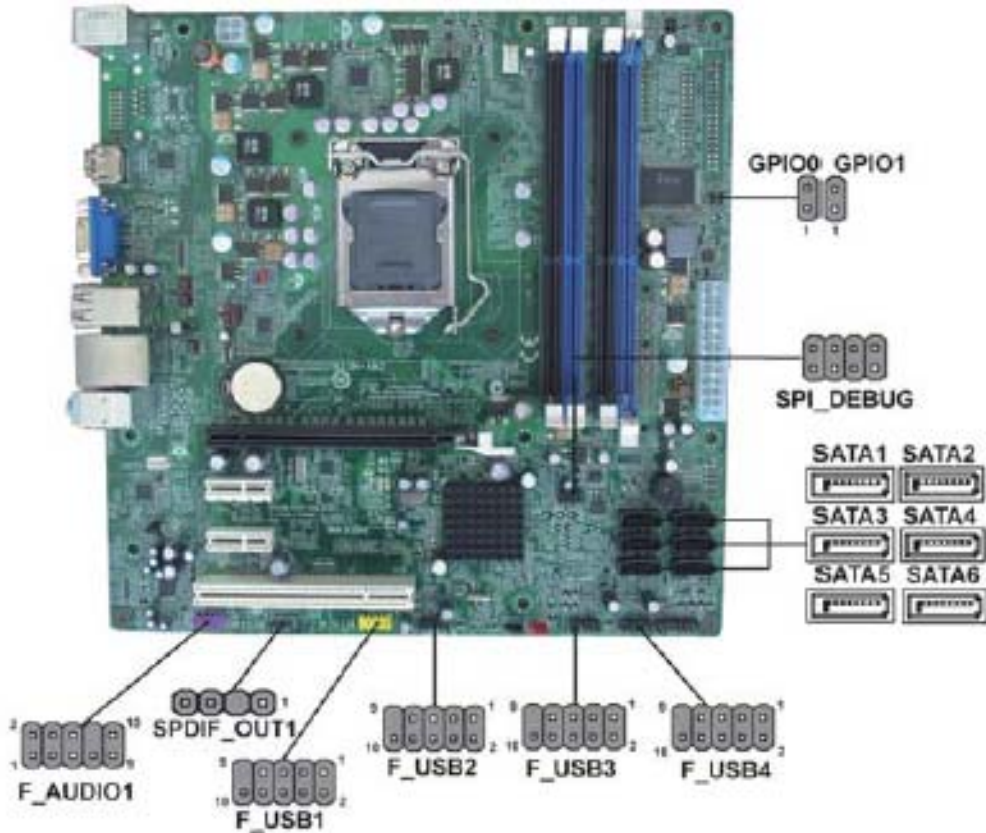

SATA1~6: Serial ATA connectors

These connectors are used to support the new Serial ATA devices for the highest data transfer rates (3.0 Gb/s), simpler disk drive cabling and easier PC assembly. It eliminates limitations of the current Parallel ATA interface. But maintains register compatibility and software compatibility with Parallel ATA.

Pin	Signal Name	?Pin	Signal Name
1	Ground	2	TX+
3	TX-	4	Ground
5	RX-	6	RX+
7	Ground	-	-

F_USB1~4: Front Panel USB headers

The motherboard has four USB ports installed on the rear edge I/O port array. Additionally, some computer cases have USB ports at the front of the case. If you

have this kind of case, use auxiliary USB connector to connect the front-mounted ports to the motherboard.

Pin	Signal Name	Function
1	USBPWR me	Front Panel USB Power
2	USBPWR	Front Panel USB Power
3	USB_FP_P0-	USB Port 0 Negative Signal
4	USB_FP_P1-	USB Port 1 Negative Signal
5	USB_FP_P0+	USB Port 0 Positive Signal
6	USB_FP_P1+	USB Port 1 Positive Signal
7	GND	Ground
8	GND	Ground
9	Key	No pin
10	USB_FP_OC0	NC

Please make sure that the USB cable has the same pin assignment as indicated above. A different pin assignment may cause damage or system hang-up.

COM2: Onboard serial port header

Connect a serial port extension bracket to this header to add a second serial port to your system.

Pin	Signal Name	Function
1	DCD me	Data Carrier Detect
2	SIN	Serial Input
3	SOUT	UART B Serial Output
4	DTR	UART B Data Terminal Ready
5	GND	Ground
6	DSR	Data Set Ready
7	RTS	RART B Request to Send
8	CTS	Clear to Send
9	RI	Ring Indicator
10	NC	No pin

SPDIF_OUT1: SPDIF out header

This is an optional header that provides an SPDIF_OUT (Sony/Philips Digital Interface) output to digital multimedia device through optical fiber or coaxial connector.

Pin	Signal Name	Pin	Signal Name
1	+5V	2	KEY
3	SPDIF	4	GND

C_INTRUSION: Chassis detect header

This detects if the chassis cover has been removed. This function needs a chassis equipped with intrusion detection switch and needs to be enabled in BIOS.

Pin	Signal Name
1	Caseopen
2	GND

INT_SPK1: Internal speaker

Pin	Signal Name	Pin	Signal Name
1	Output_L	2	GND
3	Output_R	4	Ground
5	GND	6	GND
7	N/A	8	VCC

OBR: Button recovery jumper

Pin	Signal Name
1	OBR
2	GND

PRINTER: Oboard parallel port header

Pin	Signal Name	Pin	Signal Name
1	STROBE	2	PD0
3	PD1	4	PD2
5	PD3	6	PD4
7	PD4	8	PD6

Pin	Signal Name	Pin	Signal Name
9	PD7	10	ACK
11	BUSY	12	PE
13	SLCT	14	ALF
15	ERROR	16	INTT
17	SLCTIN	18	Ground
19	Ground	20	Ground
21	Ground	22	Ground
23	Ground	24	Ground
25	Ground	26	NC

TPM: TPM Module Header

This header allows user to protect the PC from impermissible visit.

Pin	Signal Name	Pin	Signal Name
1	CK_P_33M_T PM	2	GND
3	FWH4	4	NC
5	PCIRST_L1	6	SMBDATA
7	PCIRST_L1	8	FWH2
9	VCC3	10	FWH1
11	FWH0	12	GND
13	NC	14	NC
15	3VSBY	16	SIRQ
17	GND	18	GND
19	LPCPD_L	20	SMBCLK

SPI_DEBUG: SPI_DEBUG header

Pin	Signal Name	Pin	Signal Name
1	CS	2	WP Signal Name
3	DI	4	HOLD

Pin	Signal Name	Pin	Signal Name
5	VCC	6	CLK
7	GND	8	DO

GPIO0~1: Button recovery jumper

Pin	Signal Name
1	GP36(GP16)
2	GND

FRU (Field Replaceable Unit) List

This chapter offers the FRU (Field Replaceable Unit) list in global configuration of the Aspire M5910(G) desktop computer. Refer to this chapter whenever ordering the parts to repair or for RMA (Return Merchandise Authorization).

NOTES:

- When ordering FRU parts, check the most up-to-date information available on your regional web or channel. For whatever reasons a part number is changed, it will NOT be noted on the printed Service Guide. For Acer authorized service providers, your Acer office may have a different part number code from those given in the FRU list of this printed Service Guide. You MUST use the local FRU list provided by your regional Acer office to order FRU parts for service.
- To scrap or to return the defective parts, follow the local government ordinance or regulations on how to dispose it properly, or follow the rules set by your regional Acer office on how to return it.
- This document will be updated as more information about the FRU list becomes available.

Aspire M5910(G) Exploded Diagram(AM551 ASSY)

NOTE: This section will be updated when more information becomes available.

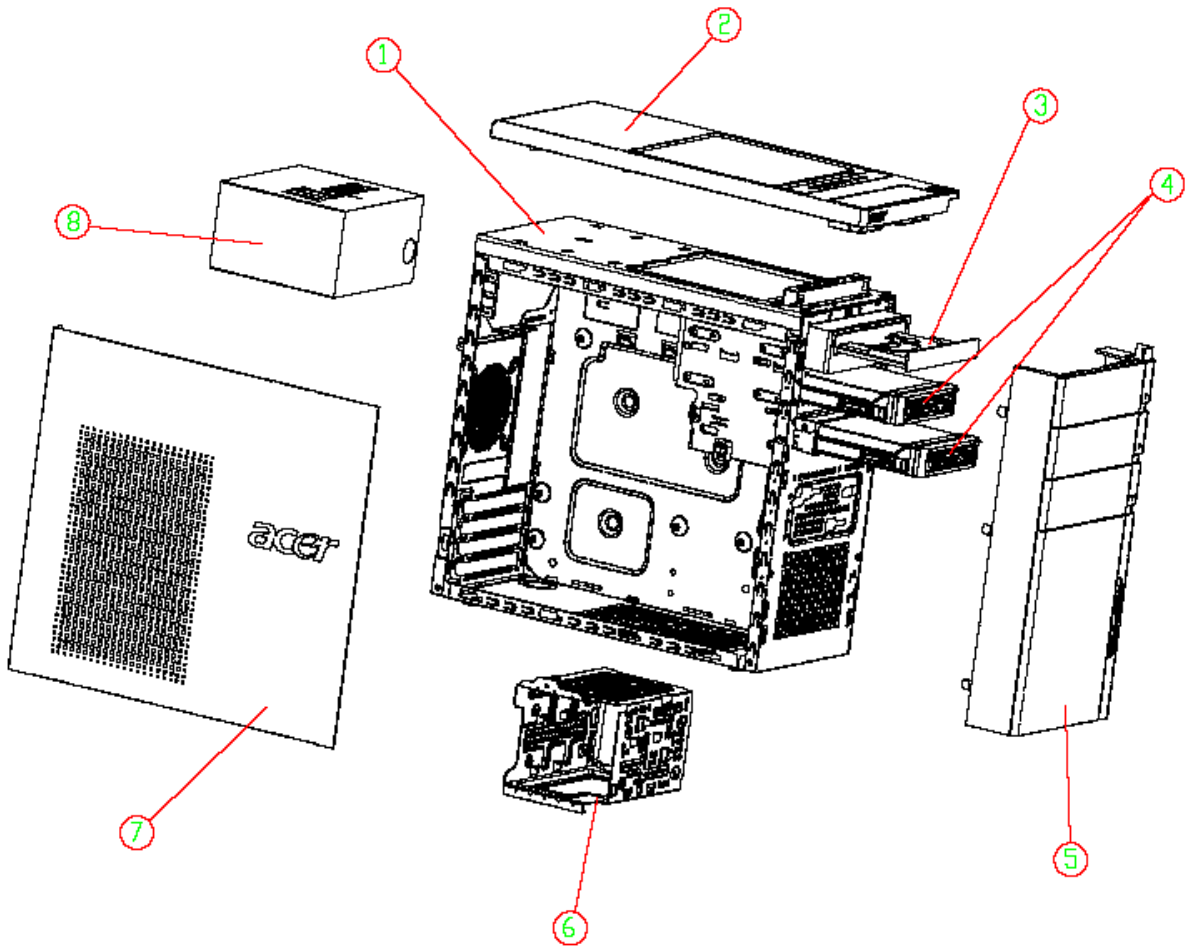

ITEM	NAME	Q'TY	ITEM	NAME	Q'TY
1	CHASSIS ASM	1	5	FRONT BEZEL	1
2	TOP-COVER	1	6	HDD COVER	1
3	ODD	1	7	SIDE COVER	1
4	REMOVABLE HDD CARRIER	2	8	POWER	1



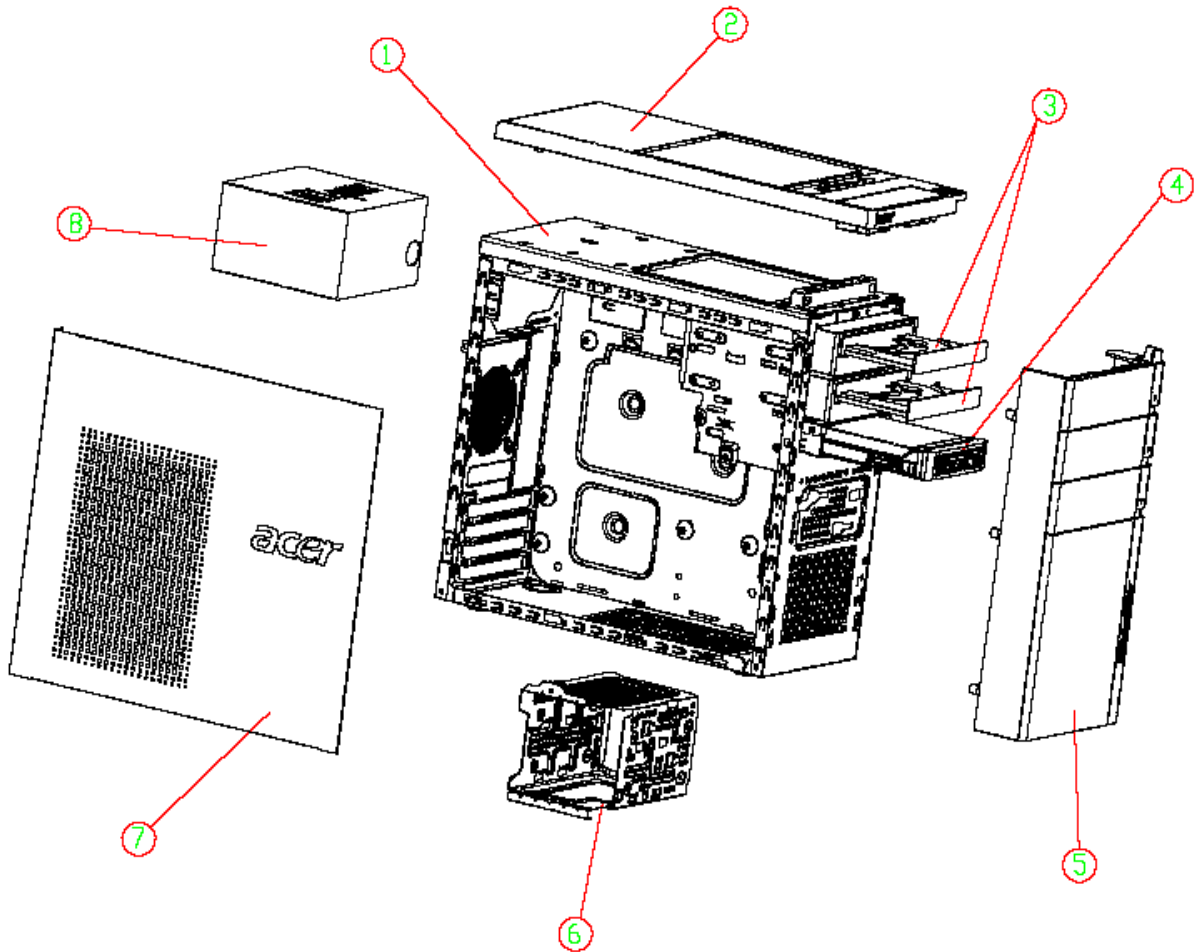

Aspire M5910(G) Exploded Diagram(AM550 ASSY)



NOTE: This section will be updated when more information becomes available.







ITEM	NAME	Q'TY	ITEM	NAME	Q'TY
1	CHASSIS ASM	1	5	FRONT BEZEL	1
2	TOP-COVER	1	6	HDD COVER	1
3	ODD	1	7	SIDE COVER	1
4	REMOVABLE HDD CARRIER	2	8	POWER	1

Aspire M5910(G) FRU List

Components	Model Name or Key Spec.	Acer P/N
MB Kit		
	MB Kit aSampras EIH57MK for M5 Intel H57 Realtek RTL8111E Giga LAN ATX W/O 1394 LF w/i D-Sub port	MB.SDW07.002
Chassis		
	Hon Hai Chassis MicroATX HM090H with front USB 4 port for Aspire AM550 bezel	HS.13100.117
	Hon Hai Chassis MicroATX HM090K w/i 3.5" carrierx2 w/i FIO USB 4 port for Aspire AM551 bezel	HS.13100.124
Bezel		
	Hon Hai Aspire Bezel AM550 USB 4 port bezel for HM090H chassis	PZ.11900.175
	Hon Hai Aspire Bezel AM551 w/i 3,5"x2 carrier ,USB 4 port bezel for HM090K chassis	PZ.11900.182
Card Reader		
	16-in-1 CR Realtek RTS-5181, 720mm USB cable, for 2010 M5	CR.10400.116
	16-in-1 CR RI236 UT330-LK, 720mm USB cable, for 2010 M5	CR.10400.115
CPU Cooler		
	Cooler Intel LGA 1156 FXC PKP775G01U12 w/i duct	HI.10800.049
	CM iCooler LGA1156 w/i pure al 93x93x40h w/i 9025 fan w/i 75mm duct	HI.10800.058
System Fan		
	SYSTEM FAN KDE 1209/GP 92*92*25 (ROHS)	HI.S150F.002
Power Supply		
	FR 500W EUP 82+ (ES5.0)	PY.50008.004
	FR 500W EUP 82+ (ES5.0)	PY.50008.005
	FR 500W EUP 82+ (ES5.0)	PY.5000B.003

Components	Model Name or Key Spec.	Acer P/N
CPU		
	CPU Intel Core i7 870 LGA 2.93G 8M 1333 1156 95W B-1 Quad Core	KC.87001.CI7
	CPU Intel Core i7 860 LGA 2.8G 8M 1333 1156 95W B-1 Quad Core	KC.86001.CI7
	CPU Intel Core i5 750 LGA 2.66G 8M 1333 1156 95W B-1	KC.75001.CI5
	CPU Intel Core i5 670 LGA 3.46G 4M 1333 1156 C-2 73W, Dual Core	KC.67001.CI5
	CPU Intel Core i5 661 LGA 3.33G 4M 1333 1156 C-2 87W, Dual Core	KC.66101.CI5
	CPU Intel Core i5 660 LGA 3.33G 4M 1333 1156 C-2 73W Dual Core	KC.66001.CI5
	CPU Intel Core i5 650 LGA 3.2G 4M 1333 1156 C-2 73W, Dual Core	KC.65001.CI5
	CPU Intel Core i3 540 LGA 3.06G 4M 1333 1156 73W C-2 Dual Core	KC.54001.CI3
	CPU Intel Core i3 530 LGA 2.93G 4M 1333 1156 73W C-2 Dual Core	KC.53001.CI3
	Pentium Dual Core G6950 (2.8G 2M 1066FSB)	KC.69501.DEG
Memory		
	M378B2873FHS-CH9 LF 128*8 46nm	KN.1GB0B.036
	M378B5673FH0-CH9 LF 128*8 46nm	KN.2GB0B.024
	GU502203EP0201 LF 128*8 0.065um	KN.1GB0H.015
	GU512303EP0202 LF 128*8 0.065um	KN.2GB0H.009
	75.073C1.G02 LF 128*8 0.065um	KN.1GB01.031
	75.A73C1.G02 LF 128*8 0.065um	KN.2GB01.025
	M378B2873EH1-CH9 LF 128*8 0.055um	KN.1GB0B.030
	M378B5673EH1-CH9 LF 128*8 0.055um	KN.2GB0B.014
HDD		
	500	KH.50007.012
	640	KH.64007.002
	1T	KH.01K07.003
	500	KH.50001.012
	1T	KH.01K01.007
	1.5TB	KH.15K01.002
	500	KH.50008.014
	640	KH.64008.003
	1T (5400 RPM)	KH.01K08.005
	1.5T(5400RPM)	KH.15K08.001
	2T (5400 RPM)	KH.02K08.001
DVD-ROM		
	DH-16D5S Win7	KV.0160F.002
	DH-20N(H/F) Win7	KV.0160D.016

Components	Model Name or Key Spec.	Acer P/N
	ODD TOSHIBA DVD-ROM HH DL 16X TS-H353C LF Black Bezel SATA (HF+Win7)	KV.01601.001
	GH-41F(H/F) Win7 non-Labelflash	KU.0160D.049
	DH-16AASH (H/F) Win7 non-Labelflash	KU.0160F.009
	ODD TOSHIBA Super-Multi DRIVE HH DL 16X TS-H653G LF Black Bezel SATA (HF+Win7)	KU.01601.007
	DH-4O3S Win7	KV.0040F.002
	ODD HLDS BD COMBO HH 6X CH10N Black Bezel SATA w/ WIN7	KO.0060D.004
	ODD HLDS BD COMBO HH 6X CH20N Black Bezel SATA HF + Win7	KO.0060D.005
	DH-6E2S Win7 non-Labelflash	KO.0060F.002
	ODD HLDS BD RW HH 6X BH30N Black Bezel SATA HF +Win7	KU.0060D.004
	ODD HLDS BD RW HH 6X BH20F Black Bezel SATA (Win7 FW)	KU.0060D.005
VGA		
	NV GT340 1GB DDR5 DVI+HDMI+VGA ATX (HYNIX)	VG.PCPT3.401
	NV GT330 2GB DDR2 DVI+HDMI+VGA ATX (SAMSUNG)	VG.PCPT3.301
	NV GT330 2GB DDR2 DVI+HDMI+VGA ATX (HYNIX)	VG.PCPT3.302
	NV GT320 1GB sDDR3 DVI+HDMI+VGA ATX (SAMSUNG)	VG.PCPT3.201
	NV GT320 1GB sDDR3 DVI+HDMI+VGA ATX (HYNIX)	VG.PCPT3.202
	NV 315 512MB sDDR3 DVI+HDMI+VGA ATX (SAMSUNG)	VG.PCPT3.151
	NV 315 512MB sDDR3 DVI+HDMI+VGA ATX (HYNIX)	VG.PCPT3.152
	GEFORCE 310 512MB DDR2 SAMSUNG (64BITS) VGA DVI HDMI ATX BRACKET ROHS	VG.PCPT3.101
	GEFORCE 310 512MB DDR2 HYNIX (64BITS) VGA DVI HDMI ATX BRACKET ROHS	VG.PCPT3.102
	HD5850 1GB (256BITS) GDDR5 SAMSUNG DVI DVI HDMI DP ATX BRACKET ROHS	VG.A5850.001
	HD5750 1GB GDDR 5 (128BITS) HYNIX DVI DVI HDMI DP W/ATX BKT ROHS	VG.APC57.501
	HD5570 1GB DDR 3 (128BITS) SAMSUNG DVI HDMI VGA W/ATX BKT ROHS	VG.APC55.701
	HD5450 512MB SDDR 3 (64BITS) SAMSUNG DVI HDMI VGA W/ATX BKT ROHS	VG.APC54.501
TV-Tuner		
	Avermedia H751-A TV Tuner Card PCIe Hybrid ATSC, S/W Encoder	TU.10500.045
	Avermedia H751-D TV Tuner Card PCIe Hybrid DVB-T, S/W Encoder	TU.10500.048
	Avermedia A750 TV Tuner Card PCIe DMB-TH Digital, w/i external antenna	TU.10500.063
Modem		

Components	Model Name or Key Spec.	Acer P/N
	Lite-On PCI Modem card, D-1156I#/A7A, LSI Universal Modem (PCI) 56K V.92 - Pinball (P40)	FX.10100.004
WLAN		
	WP81R1, WLAN PCI Card 802.11b/g/n 1T x 2R, Realtek RTL8190	NI.10200.021
	WN7600R, WLAN PCI-Ex1 card 802.11 b/g/n 1T x 2R, Ralink 1T x 2R, RT2790+RT2720	NI.10200.008
	WN7601R, Ralink RT3090, 802.11b/g/n 1x1 WLAN PCI-E x1 card	NI.10200.037
Mouse		
	Lite-on Optical mouse USB SM-9625 with new color AC-MT-018	MS.11200.048
	Chicony RF2.4 MG-0766 with new silver color	MS.11200.054
	Lite-on Optical mouse USB SM-9625S new silver color AC-MT-113	MS.11200.068
	Chicony wireless mouse RF2.4 MG-0766 new silver color AC-MT-113	MS.11200.069
External Speaker		
	Neosonica Speaker Acer logo /LF /0810 / 9M-20A200-000	SP.10600.011
	Neosonica speaker USB new silver color AC-MT-113	SP.10600.035
KB		
	Keyboard LITE-ON SK-9625S USB 104KS Silver US new silver color AC-MT-113	KB.USB0B.203
	Keyboard LITE-ON SK-9625S USB 104KS Silver US new silver color AC-MT-113	KB.USB0B.242
	Keyboard CHICONY KU-0760 USB Standard 104KS Black US w/o eKey	KB.USB03.192
	Keyboard CHICONY KU-0760 USB Standard 104KS Black US w/o eKey	KB.USB03.311
	Keyboard LITE-ON SK-9625 USB Standard 104KS Black US w/o eKey	KB.USB0B.158
	Keyboard LITE-ON SK-9625 USB Standard 104KS Black US w/o eKey	KB.USB0B.202

Free Manuals Download Website

<http://myh66.com>

<http://usermanuals.us>

<http://www.somanuals.com>

<http://www.4manuals.cc>

<http://www.manual-lib.com>

<http://www.404manual.com>

<http://www.luxmanual.com>

<http://aubethermostatmanual.com>

Golf course search by state

<http://golfingnear.com>

Email search by domain

<http://emailbydomain.com>

Auto manuals search

<http://auto.somanuals.com>

TV manuals search

<http://tv.somanuals.com>