

TravelMate 360 series

User's guide

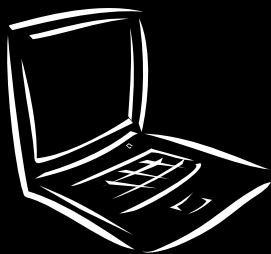

Copyright © 2001. Acer Incorporated.
All Rights Reserved.

TravelMate 360 series User's guide
Original Issue: September 2001

Changes may be made periodically to the information in this publication without obligation to notify any person of such revision or changes. Such changes will be incorporated in new editions of this manual or supplementary documents and publications. This company makes no representations or warranties, either expressed or implied, with respect to the contents hereof and specifically disclaims the implied warranties of merchantability or fitness for a particular purpose.

Record the model number, serial number, purchase date, and place of purchase information in the space provided below. The serial number and model number are recorded on the label affixed to your computer. All correspondence concerning your unit should include the serial number, model number, and purchase information.

No part of this publication may be reproduced, stored in a retrieval system, or transmitted, in any form or by any means, electronic, mechanical, photocopy, recording, or otherwise, without the prior written permission of Acer Incorporated.

TravelMate 360 series Notebook Computer

Model number: _____

Serial number: _____

Purchase date: _____

Place of purchase: _____

Acer and the Acer logo are registered trademarks of Acer Incorporated. Other company's product names or trademarks are used herein for identification purposes only and belong to their respective companies.

First things first

We would like to thank you for making the TravelMate series of notebook computers your choice for your mobile computing needs. We hope you will be happy with your TravelMate as much as we enjoyed making it for you.

Your guides

To help you use your TravelMate, we have designed a set of guides:



First off, the **Just for Starters...** poster helps you get started with setting up your computer.



This **User's guide** introduces you to the many ways your computer can help you be more productive. This guide provides clear and concise information about the computer, so read it thoroughly.

If you ever need to print out a copy, this User's guide is also available in PDF (Portable Document Format). Follow these steps:

1 Click on **Start, Programs, TravelMate**.

2 Click on **TravelMate User's guide**.

Note: Viewing the file requires Adobe Acrobat Reader installed. If Adobe Acrobat Reader is not installed on your computer, clicking on TravelMate User's guide will run the Acrobat Reader setup program first. Follow the instructions on the screen to complete the installation. For instructions on how to use Adobe Acrobat Reader, access the **Help** menu.



A handy **Hot key pocket reference** card is useful for quick glances at functional key combinations.



An **Online guide** is your helping hand on-the-go, with easy to access, detailed and linked information about your computer.

To access the online guide:

- 1** Click on **Start, Programs, TravelMate.**
- 2** Click on **TravelMate Online guide.**



Lastly, there may be a **Read me first** sheet included with your package which contains important reminders and updates. So, please read through it.

For more information about our products, services, and support information, please visit our web site (<http://global.acerc.com>).

Basic care and tips for using your computer

Turning your computer on and off

To turn on the computer, simply slide and then release the power switch on the left side of your TravelMate.

To turn the power off, do any of the following:

- Use the Windows **Shut Down...** command

Click on **Start, Shut Down...**, and select Shut down; then click on **OK.**

- Use the power switch



Note: You can also use the power switch to perform power management functions. See "Basic power management" on page 28.

- Use the customized functions for power management

You can also shut down the computer by closing the display cover, or by pressing the sleep hot key (**Fn-F4**). See "Basic power management" on page 28.



Note: If you cannot power off the computer normally, press and hold the power switch for more than four seconds to shut down the computer. If you turn off the computer and want to turn it on again, wait at least two seconds before powering up.

Taking care of your computer

Your computer will serve you well if you take care of it.

- Do not expose the computer to direct sunlight. Do not place it near sources of heat, such as a radiator.
- Do not expose the computer to temperatures below 0°C (32°F) or above 50°C (122°F).
- Do not subject the computer to magnetic fields.
- Do not expose the computer to rain or moisture.
- Do not spill water or any liquid on the computer.
- Do not subject the computer to heavy shock and vibration.
- Do not expose the computer to dust and dirt.
- Never place objects on top of the computer to avoid damaging the computer.
- Do not slam the computer display when you close it.
- Never place the computer on uneven surfaces.

Taking care of your AC adapter

Here are some ways to take care of your AC adapter:

- Do not connect the adapter to any other device.
- Do not step on the power cord or place heavy objects on top of it. Carefully route the power cord and any cables away from personal traffic.
- When unplugging the power cord, do not pull on the cord itself but pull on the plug.
- The total ampere ratings of the equipment plugged in should not exceed the ampere rating of the cord if you are using an extension cord. Also, the total current rating of all equipment plugged into a single wall outlet should not exceed the fuse rating.

Taking care of your battery pack

Here are some ways to take care of your battery pack:

- Use only batteries of the same kind as replacements. Turn the power off before removing or replacing batteries.
- Do not tamper with batteries. Keep them away from children.
- Dispose of used batteries according to local regulations. Recycle if at all possible.

Cleaning and servicing

When cleaning the computer, follow these steps:

- 1** Power off the computer and remove the battery pack.
- 2** Disconnect the AC adapter.
- 3** Use a soft cloth moistened with water. Do not use liquid or aerosol cleaners.

If any of the following occurs:

- The computer has been dropped or the body has been damaged.
- Liquid has been spilled into the product.
- The computer does not operate normally.

Please refer to "Troubleshooting my computer" on page 57.

Contents

First things first	iii
Your guides	iii
Basic care and tips for using your computer	iv
1 Getting to know your TravelMate	1
A TravelMate tour	3
Front view	3
Left view	5
Right view	6
Rear view	6
Bottom view	8
Features	9
Indicators	11
Using the keyboard	13
Special keys	13
Touchpad	21
Touchpad basics	21
Storage	23
Hard disk	23
EasyLink combo drive	23
Using software	25
Audio	27
Adjusting the volume	27
Basic power management	28
Moving around with your TravelMate	29
Disconnecting from the desktop	29
Moving around	29
Taking the computer home	30
Traveling with the computer	32
Traveling internationally with the computer	32
Securing your computer	34
Using a computer security lock	34
Using the SmartCard	34
Using passwords	41
2 Customizing your computer	45
Expanding through options	47
Connectivity options	47
Upgrade options	51
Notebook Manager	52
Launch Manager	53
BIOS Utility	55

3 Troubleshooting your computer	57
Frequently-asked questions	59
Troubleshooting tips	63
Error messages	64
Requesting service	66
International Traveler's Warranty (ITW)	66
Before you call	66
Appendix A Specifications	69
Appendix B Notices	75
Index	83

1 Getting to know your TravelMate

Your TravelMate computer combines high-performance, versatility, power management features and multimedia capabilities with a unique style and ergonomic design. Work with unmatched productivity and reliability with your new power computing partner.



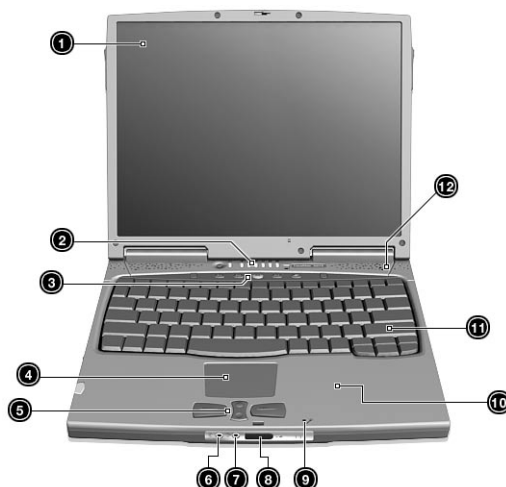

A TravelMate tour

After setting up your computer as illustrated in the **Just for Starters...** poster, let us show you a round your new TravelMate computer.

Front view



#	Item	Description
1	Display screen	Also called LCD (liquid-crystal display), displays computer output.
2	Status indicators	LEDs (light-emitting diodes) that turn on and off to show the status of the computer and its functions and components.
3	Launch keys	Buttons for launching frequently used programs. See "Launch Keys" on page 18 for more details.
4	Touchpad	Touch-sensitive pointing device which functions like a computer mouse.

#	Item	Description
5	Click buttons (left, center and right)	The left and right buttons function like the left and right mouse buttons; the center button serves as a scroll up/down button.
6	Speaker/ Headphone-outjack 	Connects to audio line-out devices (e.g., speakers, headphones).
7	Line-in jack 	Accepts audio line-in devices (e.g., audio CD player, stereo walkman).
8	Infrared port 	Interfaces with Infrared devices (e.g., infrared printer, IR-aware computers).
9	Microphone 	Inputs sounds and voices into your computer.
10	Palrest	Comfortable support area for your hands when you use the computer.
11	Keyboard	Inputs data into your computer.
12	Speaker	Outputs sound.

Left view



#	Item	Description
1	EasyLink combo drive connector	Connects to an EasyLink combo drive.
2	IEEE 1394 port	Connects to IEEE 1394 devices.
3	Power switch	Turns on the computer power.
4	PC Card eject button	Ejects PC Card from the card slot.
5	PC Card slot 	Accepts to one Type II 16-bit PC Card or 32-bit CardBus PC Card.
6	SmartCard eject button	Ejects the SmartCard from the slot.
7	SmartCard slot	Slot for SmartCard interface with pre-boot authentication system.
8	Video capture kit slot	Accepts the video capture kit option on the left side of the computer.

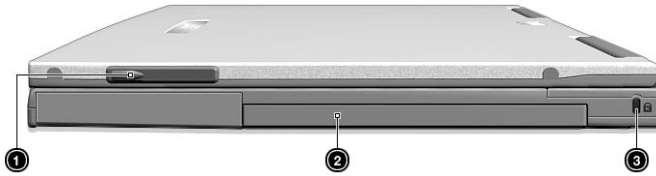

Right view





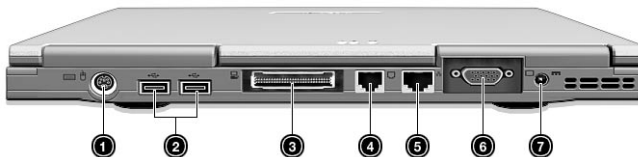

#	Item	Description
1	Video capture kit slot	Accepts the video capture kit option on the right side of the computer.
2	Battery bay	Houses the computer's battery pack.
3	Security keylock	Connects to a Kensington-compatible computer security lock.

Rear view



#	Item	Description
1	PS/2 port 	Connects to PS/2-compatible device (e.g., PS/2 keyboard/mouse/keypad).
2	USB ports (two) 	Connect to any Universal Serial Bus devices (e.g., USB mouse, USB camera).

#	Item	Description
3	Expansion port 	Connects to I/O replica tor or EasyPort expansion devices.
4	Modem jack 	Connects to a phone line.
5	Network jack 	Connects to an Ethernet 10/100-based network.
6	External display port 	Connects to a display device (e.g., external monitor, LCD projector) and displays up to 64K colors at 1280x1024 resolution.
7	Power jack 	Connects to an AC adapter.

Bottom view

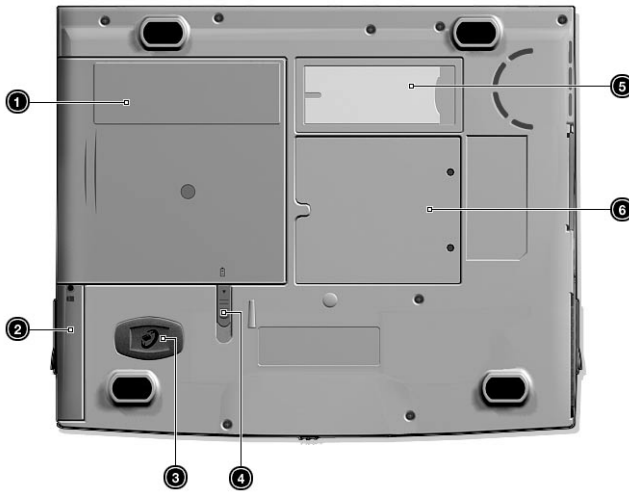

#	Item	Description
1	Battery bay	Houses the computer's battery pack.
2	Hard disk bay	Houses the computer's hard disk (secured by a screw).
3	Hard disk anti-shock protection	Disk Anti-Shock Protection (DASP) protects your hard disk against accidental shock and vibration.
4	Battery release latch	Unlatches the battery to remove the battery pack.
5	Personal identification slot	Insert a business card or similar-sized identification card to personalize your computer.
6	Memory compartment	Houses the computer's main memory.

Features

Below is a brief summary of the computer's many features:

Performance

- Mobile Intel® Pentium® III Processor-M with 512 KB level 2 cache featuring the new Enhanced Intel® SpeedStep™ technology
- Memory expandable up to 1024 MB or 1 GB and supports PC 133 Mhz bus speed
- External EasyLink™ combo drive (floppy and CD-ROM/DVD-ROM/DVD-RW drive)
- High-capacity, Enhanced-IDE hard disk
- Li-ion main battery pack
- Power management system with ACPI (Advanced Configuration Power Interface)
- Smart Card interface with pre-boot authentication system for added security.

Display

- 13.3" Thin-Film Transistor (TFT) liquid-crystal display (LCD) displaying 24-bit true-color at 1024x768 Extended Graphics Array (XGA) resolution
- 8 MB Video DRAM with DVMT (Dynamic Video Memory Technology™) up to 32 MB
- 3D capabilities
- Simultaneous LCD and CRT display support
- Supports other output display devices such as LCD projection panels for large-audience presentations
- "Automatic LCD dim" feature that automatically decides the best settings for your display and conserves power
- Dual display capability

Multimedia

- 16-bit high-fidelity AC '97 PCI stereo audio with wave table synthesizer
- Built-in speaker and microphone

- High-speed optical (CD-ROM, DVD-ROM or DVD-RW) drive
- USB video capture kit option

Connectivity

- High-speed fax/data modem port
- Fast infrared wireless communication
- USB (Universal Serial Bus) ports
- Ethernet/Fast Ethernet port
- IEEE 1394 port
- Optional 802.11b wireless LAN
- Optional USB Bluetooth dongle solution

Human-centric design and ergonomics

- Sleek, smooth and stylish design
- Full-sized keyboard
- Ergonomically-centered touchpad pointing device
- Internet scroll key

Expansion







- Type II CardBus PC Card (formerly PCMCIA) slot with ZV (zoomed video) port support
- Upgradeable memory
- EasyPort port replicator

Indicators

The computer has seven easy-to-read status icons below the display screen.



The Power and Sleep status icons are visible even when you close the display cover so you can see the status of the computer while the cover is closed.

Icon	Function	Description
	Wireless Communication	Lights when the Wireless LAN capabilities are enabled.
	Power	Lights when the computer is on.
	Sleep	Lights when the computer enters Sleep mode.
	Media Activity	Lights when the floppy drive, hard disk or EasyLink Combo drive is active.
	Battery Charge	Lights when the battery is being charged.
	Caps Lock	Lights when Caps Lock is activated.

Icon	Function	Description
	Num Lock	Lights when Num Lock is activated.

Using the keyboard

The keyboard has full-sized keys and an embedded keypad, separate cursor keys, two Windows keys and twelve function keys.

Special keys

Lock keys

The keyboard has three lock keys which you can toggle on and off.

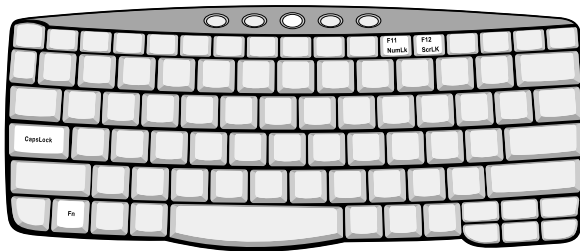

Lock key	Description
Caps Lock	When Caps Lock is on, all alphabetic characters typed are in uppercase.
Num Lock (Fn-F11)	When Num Lock is on, the embedded keypad is in numeric mode. The keys function as a calculator (complete with the arithmetic operators +, -, *, and /). Use this mode when you need to do a lot of numeric data entry. A better solution would be to connect an external keypad.
Scroll Lock (Fn-F12)	When Scroll Lock is on, the screen moves one line up or down when you press the up or down arrow keys respectively. Scroll Lock does not work with some applications.



Note: To access the Num Lock and Scroll Lock functions, hold the Fn key down while pressing the F11 and F12 keys respectively.

Embedded numeric keypad

The embedded numeric keypad functions like a desktop numeric keypad. It is indicated by small characters located on the upper right corner of the keyboard. To simplify the keyboard legend, cursor-control key symbols are not printed on the keys.

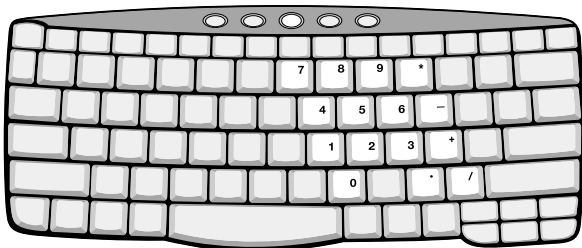

Desired access	Num lock on	Num lock off
Number keys on embedded keypad	Type numbers in a normal manner.	
Cursor-control keys on embedded keypad	Hold Shift while using cursor-control keys.	Hold Fn while using cursor-control keys.
Main keyboard keys	Hold Fn while typing letters on embedded keypad.	Type the letters in a normal manner.





Note: If an external keyboard or keypad is connected to the computer, the Num Lock feature automatically shifts from the internal keyboard to the external keyboard or keypad.

Windows keys

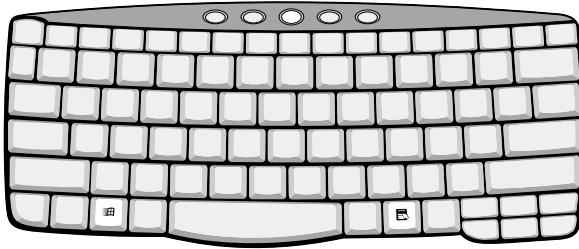
The keyboard has two keys that perform Windows-specific functions.









Key	Description
Windows logo key 	Start button. Combinations with this key perform shortcut functions. Below are a few examples: ⌘ + Tab (Activates next taskbar button) ⌘ + E (Explores My Computer) ⌘ + F (Finds Document) ⌘ + M (Minimizes All) Shift + ⌘ + M (Undoes Minimize All) ⌘ + R (Displays the Run... dialog box)
Application key 	Opens a context menu (same as a right-click).

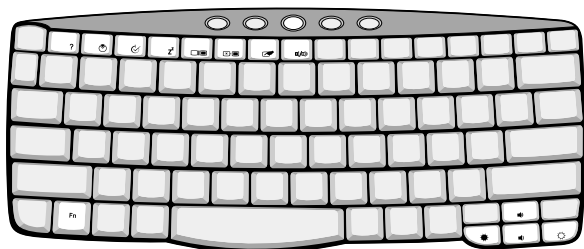





Hot keys

The computer employs hot keys or key combinations to access most of the computer's controls like screen brightness, volume output and the BIOS Utility.

To activate hot keys, press and hold the **Fn** key before pressing the other key in the hot key combination.



Hot key	Icon	Function	Description
Fn-F1	?	Hot Key Help	Displays help on hot keys.
Fn-F2		Setup	Accesses the computer's configuration utility.
Fn-F3		Power Management Scheme Toggle	Switches the power management scheme used by the computer (function available if supported by operating system). See "Basic power management" on page 28.
Fn-F4		Sleep	Puts the computer in Sleep mode. See "Basic power management" on page 28.
Fn-F5		Display Toggle	Switches display output between the display screen, external monitor (if connected) and both the display screen and external monitor.
Fn-F6		Screen Blank	Turns the display screen backlight off to save power. Press any key to return.

Hot key	Icon	Function	Description
Fn-F7		Touchpad Toggle	Turns the internal touchpad on and off.
Fn-F8		Speaker Toggle	Turns the speakers on and off.
Fn-↑		Volume up	Increases the speaker volume.
Fn-↓		Volume down	Decreases the speaker volume.
Fn-→		Brightness up	Increases the screen brightness.
Fn-←		Brightness down	Decreases the screen brightness.
Alt Gr- Euro		Euro	Types the Euro symbol (available on some models).

The Euro symbol

If your keyboard layout is set to United States-International or United Kingdom or if you have a keyboard with a European layout, you can type the Euro symbol on your keyboard.



Note for US keyboard users: The keyboard layout is set when you first set up Windows. For the Euro symbol to work, the keyboard layout has to be set to United States-International.

To verify the keyboard type:

- 1 Click on **Start, Settings, Control Panel**.
- 2 Double-click on **Keyboard**.
- 3 Click on the **Language** tab.

- 4 Verify that the keyboard layout used for "En English (United States)" is set to United States-International.

If not, select and click on **Properties**; then select **United States-International** and click on **OK**.

- 5 Click on **OK**.

To type the Euro symbol:

- 1 Locate the Euro symbol on your keyboard.
- 2 Open a text editor or word processor.
- 3 Hold **Alt Gr** and press the Euro symbol.



Some fonts and software do not support the Euro symbol. Please refer to <http://www.microsoft.com/typography/faq/faq12.htm> for more information.

Launch Keys

Located at the top of the keyboard are five buttons. These buttons are called launch keys. They are designated as P1, P2, P3, mail button and Web browser button.



Note: To the left of these five launch keys is the wireless communication button. For more information on this feature, please refer to the wireless communication manual.

Launch key	Default application
P1	User-program mable
P2	User-program mable
P3	Multimedia applica tion
Mail	Email applica tion. The LED of the mail button will flash when the user has incoming email
Web browser	Internet browser applica tion

Email checking function

When you first start up your system, a Mail Checking dialog box will be displayed. In this dialog box, you have the option to launch the program at startup or not, set the time for mail checking, etc. If you already have an email account, you can fill in the Mail Properties in the dialog box.

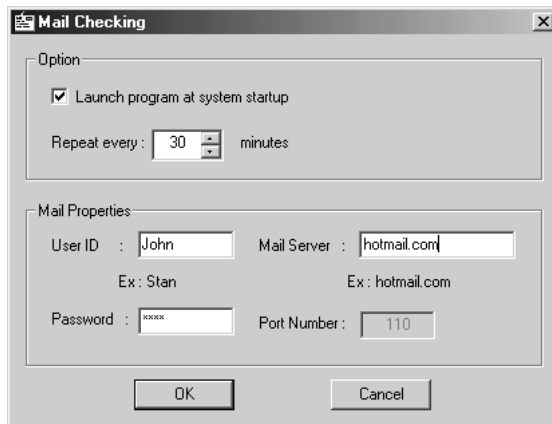

The Mail Server is the server name where you get your email, for example: JohnSmith@hotmail.com, the Mail Server is **hotmail.com**.

Aside from the email checking function, there is a mail button that is used to launch the email application. It is located above the keyboard

right below the LCD. The LED of the mail button will flash when the user has received an incoming email.

You can also access the Mail Checking dialog box by clicking on **Start, Programs, Launch Manager**, then click on **E-Mail checking setting**.

Touchpad

The built-in touchpad is a PS/2-compatible pointing device that senses movement on its surface. This means the cursor responds as you move your finger on the surface of the touchpad. The central location on the palm rest provides optimum comfort and support.



Note: When using an external USB or serial mouse, you can press **Fn-F7** to disable the touchpad. If you are using an external PS/2 mouse, the touchpad is automatically disabled.



Touchpad basics

The following items teach you how to use the touchpad:

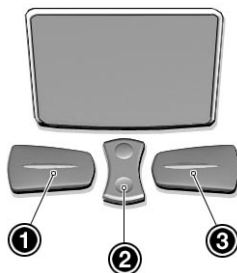

- Move your finger across the touchpad to move the cursor.
- Press the left (1) and right (3) buttons located on the edge of the touchpad to do selection and execution functions. These two buttons are similar to the left and right buttons on a mouse. Tapping on the touchpad produces similar results.
- Use the center (2) button (top and bottom) to scroll up or down a page. This button mimics your cursor pressing on the right scroll

bar of Windows applications.

Function	Left button	Right button	Center buttons	Tap
Execute	Click twice quickly			Tap twice (at the same speed as double-clicking a mouse button)
Select	Click once			Tap once
Drag	Click and hold, then use finger to drag the cursor on the touchpad			Tap twice (at the same speed as double-clicking a mouse button) then hold finger to the touchpad on the second tap and drag the cursor
Access context menu		Click once		
Scroll			Click and hold the up/down button	



Note: Keep your fingers dry and clean when using the touchpad. Also keep the touchpad dry and clean. The touchpad is sensitive to finger movements. Hence, the lighter the touch, the better the response. Tapping harder will not increase the touchpad's responsiveness.

Storage

This computer supplies you the following media storage:

- High-capacity Enhanced-IDE hard disk
- External EasyLink™ combo drive
 - Standard 3.5-inch floppy drive.
 - High-speed optical drive

Hard disk

The high-capacity hard disk is the answer to your storage needs.

EasyLink combo drive

The EasyLink combo drive is a two-in-one floppy/CD-ROM, floppy/DVD-ROM or floppy/DVD-RW "combo" drive that connects externally to the computer.

The floppy drive reads and writes standard 3.5-inch diskettes. The optical drive provides the latest in multimedia in a mobile world.

Connecting and disconnecting the EasyLink combo drive

To connect the EasyLink combo drive:

- 1** Pull out the EasyLink combo drive cable connector from its storage slot.
- 2** Open the EasyLink combo drive connector door (a) on the computer.

- 3 Firmly connect the EasyLink combo drive (connector to connector) (b) to the computer.



To disconnect the EasyLink combo drive:

- 1 Click on the **HotIDE** icon () on the Windows taskbar.
- 2 Select the stop operation.
A message appears to confirm the stop operation.
- 3 Click on **OK**.
- 4 Disconnect the EasyLink combo drive.
- 5 Tuck in the EasyLink combo drive cable connector into its storage slot.



Note: If the computer is on, and you disconnect the EasyLink combo drive without using the HotIDE stop function, the computer will hang (stop operating normally). Connect the EasyLink combo drive again to solve this problem. It is advisable to follow the connect/disconnect procedures discussed above. If the computer is off, you can disconnect the EasyLink combo drive at your convenience.

Ejecting a floppy disk

Press the floppy disk eject button to eject a floppy disk from the floppy drive.



Ejecting the optical drive tray

To eject the optical drive tray when the computer is turned on, press the drive eject button.



When the power is off, you can eject the drive tray using the emergency eject hole. See page 60 for more detail.

Using software

Playing DVD movies

Some models come standard with a DVD-equipped EasyLink DVD combo drive. To play DVD movies on your computer, follow these steps:

- 1 Eject the DVD tray and insert a DVD movie disc; then close the DVD tray.



Important! When you launch the DVD player for the first time, the program asks you to input the region code. DVD discs are divided into 6 regions. Once your DVD drive is set to a region code, it will play DVD discs of that region only. You can set the region code a maximum of five times (including the first time), after which the last region code set will remain permanent. Recovering your hard disk does not reset the number of times the region code has been set. Refer to the table later in this section for DVD movie region code information.

2 The DVD movie will automatically play after a few seconds.

Region code	Country or region
1	U.S.A., Canada
2	Europe, Middle East, South Africa, Japan
3	Southeast Asia, Taiwan, Korea (South)
4	Latin America, Australia, New Zealand
5	Former U.S.S.R., parts of Africa, India
6	People's Republic of China



Note: To change the region code, insert a DVD movie of a different region into the DVD-ROM drive. Please refer to the online help for more information.

Audio

The computer comes with 16-bit high-fidelity PCI stereo audio, and includes a built-in sensitive microphone and stereo speaker.



There are audio ports on the front panel of the computer. See "Front view" on page 3 for more information on connecting external audio devices.

Adjusting the volume

Adjusting the volume on the computer is as easy as pressing some buttons. See "Hot keys" on page 15 for more information on adjusting the speaker volume.

Basic power management

This computer has a built-in power management unit that monitors system activity. System activity refers to any activity involving one or more of the following devices: keyboard, mouse, floppy drive, hard disk, peripherals connected to the serial and parallel ports, and video memory. If no activity is detected for a period of time (called an inactivity timeout), the computer stops some or all of these devices in order to conserve energy.

This computer employs a power management scheme that supports ACPI (Advanced Configuration and Power Interface) which allows for maximum power conservation and maximum performance at the same time. Windows handles all power-saving chores for your computer.

Refer to your online guide for more information.

Moving around with your TravelMate

This section gives you tips and hints on things to consider when moving around or traveling with your computer.

Disconnecting from the desktop

Follow these steps to disconnect your computer from external accessories:

- 1 Save your work in progress.
- 2 Remove any media, diskette or compact disc, from the drive(s).
- 3 Shut down the operating system.
- 4 Turn off the computer.
- 5 Close the display cover.
- 6 Disconnect the computer from the port expansion option, if necessary.
- 7 Disconnect the cord from the AC adapter.
- 8 Disconnect the keyboard, pointing device, printer, external monitor, and other external devices.
- 9 Disconnect the Kensington lock if you are using one to secure the computer.

Moving around

“when you are just moving within short distances, for example, from your office desk to a meeting room”

Preparing the computer

Before moving the computer, close and latch the display cover to place it in Sleep mode. You can now safely take the computer anywhere you go within the building. To bring the computer out of Sleep mode, open the display.

If you are taking the computer to a client's office or a different building, you may choose to shut down the computer:

- 1 Click on **Start, Shut Down....**

2 Select Shut down and click on **OK**.

- or -

you can put the computer in Sleep mode by pressing **Fn-F4**. Then close and latch the display.

When you are ready to use the computer again, unlatch and open the display, and press any key. If the power indicator is off, the computer has entered Hibernation mode and turned off. Press, slide and release the power switch to turn the computer back on. Note that the computer may enter Hibernation mode after it is in Sleep mode for a period of time. Turn the power on to wake up the computer from Hibernation mode.

What to bring to short meetings

A fully charged battery runs the computer for about 3 hours under most circumstances. If your meeting is shorter than that, you probably do not need to bring anything with you other than the computer.

What to bring to long meetings

If your meeting will last longer than 3 hours or if your battery is not fully charged, you may want to bring the AC adapter with you to plug in your computer in the meeting room.

If the meeting room does not have an electrical outlet, reduce the drain on the battery by putting the computer in Sleep mode. Press **Fn-F4** or close the display cover whenever you are not actively using the computer. Then tap any key or open the display to resume.

Taking the computer home

“when you are moving from your office to your home or vice versa”

Preparing the computer

After disconnecting the computer from your desktop, follow these steps to prepare the computer for the trip home:

- Make sure that you have removed any media, diskette and compact disc, in the drive(s). Failure to remove the media can damage the drive head.

- Pack the computer in a protective case that can prevent the computer from sliding around and cushion it if it should fall.



Caution: Avoid packing items next to the top cover of the computer. Pressure against the top cover can damage the screen.

What to bring with you

Unless you already have some items at home, bring the following items with you:

- AC adapter and power cord
- The printed user's manual
- EasyLink module

Special considerations

Follow these guidelines to protect your computer while traveling to and from work:

- Minimize the effect of temperature changes by keeping the computer with you.
- If you need to stop for an extended period of time and cannot bring the computer with you, leave the computer in the trunk of the car to avoid exposing the computer to excessive heat.
- Changes in temperature and humidity can cause condensation. Allow the computer to return to room temperature, and inspect the screen for condensation before turning on the computer. If the temperature change is greater than 18°F (10°C), allow the computer to come to room temperature slowly. If possible, leave the computer for 30 minutes in an environment with a temperature between outside and room temperature.

Setting up a home office

If you frequently work on your computer at home, it may be worthwhile to purchase a second AC adapter for use at home. With a second AC adapter, you can avoid transporting the extra weight to and from home.

If you use your computer at home for significant periods of time, you might also want to add an external keyboard, monitor, or mouse.

Traveling with the computer

“when you are moving within a larger distance, for instance, from your office building to a client’s office building or traveling locally”

Preparing the computer

Prepare the computer as if you were taking it home. Make sure that the battery in the computer is charged. Airport security may require you to turn on your computer when bringing it into the gate area.

What to bring with you

Bring the following items with you:

- AC adapter
- Spare, fully-charged battery pack(s)
- Additional printer driver files if you plan to use another printer
- EasyLink module

Special considerations

In addition to the guidelines for taking the computer home, follow these guidelines to protect your computer while traveling:

- Always take the computer as carry-on luggage.
- If possible, have the computer inspected by hand. Airport security X-ray machines are safe, but do not put the computer through a metal detector.
- Avoid exposing floppy disks to hand-held metal detectors.

Traveling internationally with the computer

“when you are moving from country to country”

Preparing the computer

Prepare the computer as you would normally prepare it for traveling.

What to bring with you

Bring the following items with you:

- AC adapter
- Power cords that are appropriate to the country to which you are traveling
- Spare, fully-charged battery packs
- EasyLink module
- Additional printer driver files if you plan to use another printer
- Proof of purchase, in case you need to show it to customs officials
- International Traveler's Warranty passport

Special considerations

Follow the same special considerations as when traveling with the computer. In addition, these tips are useful when traveling internationally:

- When traveling in another country, check that the local AC voltage and the AC adapter power cord specifications are compatible. If not, purchase a power cord that is compatible with the local AC voltage. Do not use converter kits sold for appliances to power the computer.
- If you are using the modem, check if the modem and connector is compatible with the telecommunications system of the country you are traveling in.

Securing your computer

Your computer is a valuable investment that you need to take care of. Learn how to protect and take care of your computer.

Security features include hardware and software locks — a security notch, smart card and passwords.

Using a computer security lock

A security keylock notch located on the right panel of the computer lets you connect a Kensington-compatible key-based computer security lock. Some keyless models are also available.

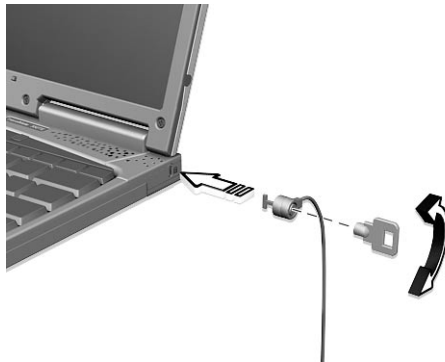

Wrap a computer security lock cable around an immovable object such as a table or locked drawer handle. Insert the lock into the notch and turn the key to secure the lock.

Using the SmartCard

This software includes the following components: PlatinumPAS™, PlatinumSecure™ and PlatinumKey™. Together, they provide you with multiple levels of security.

- PlatinumPAS implements the first security measure at the BIOS level and runs during the BIOS routine check when a computer is powered up or rebooting. If no SmartCard or Emergency Card is detected, the computer will stop booting up to prevent any illegal access to the system.
- PlatinumSecure enhances the secure logon procedure for Windows

Millennium Edition (Me) or 2000 at the Windows operating system level. It provides user authentication through its encryption/decryption function using the SmartCard. If your SmartCard is unavailable, you can use the Emergency Card as a temporary replacement card.

- PlatinumKey auto-authenticate and auto cache with one-click logons to all password-required websites (patent pending), eliminates the overhead costs associated with memorizing and typing user IDs and passwords when surfing the Internet with Microsoft or Netscape web browsers.

A card slot for your SmartCard is located on the left panel of the computer. This new security feature helps you boot up your computer with all your settings built right into your SmartCard. You don't have to remember your password to access your computer.



To remove the SmartCard press the SmartCard eject button (a) and remove the SmartCard (b) as shown in the illustration below.

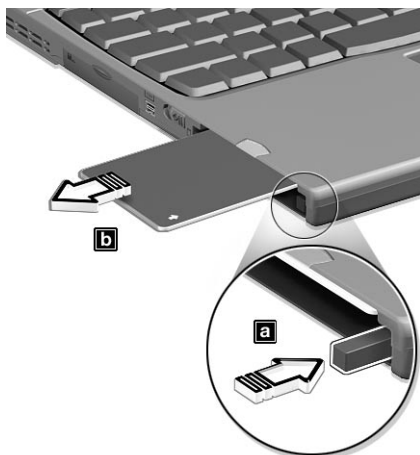

For more details consult your smart card documentation.

Registering your smart card



Important! Your Acer notebook is equipped with a smart card security feature that protects the computer from unauthorized access. If you enable this feature, please make sure that your warranty card is completed and sent back to Acer. This information will be used by Acer service centers to confirm ownership in case your smart card "key" is lost or damaged. Registering your notebook with Acer's service center is extremely important when replacing your lost smart card "key".

If you have already bypassed the smart card registration, please reinstall the application as follows:

- 1 Double-click on **setup.exe** located in C:\Wlan\SmartAP.
- 2 Follow the onscreen instructions.

To enable the smart card security feature, please refer to your SmartCard user manual.

Running PlatinumSecure

PlatinumSecure enhances the secure logon procedure for Windows Me or 2000 at the operating system level. It provides user authentication with an encryption/decryption function using the SmartCard. If your SmartCard is unavailable, the EmergencyCard can serve as a temporary replacement for the SmartCard. After installation, the PlatinumSecure icon appears on the Windows desktop. Double-click on it or click the right mouse button, then select **Open** from the pop-up menu (or launch it from the PlatinumSecure program group). From the menu that appears, you can directly access three operations: PlatinumSecure Options, SmartCard Manager, and Change Password.

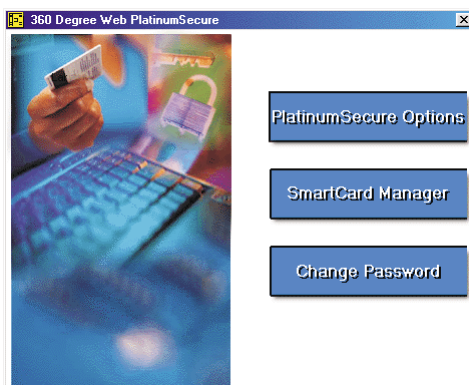

PlatinumSecure Options

Click on the **PlatinumSecure Options** button to open the SmartCard Options window. It provides great flexibility to meet the various privacy protection needs of many different users.

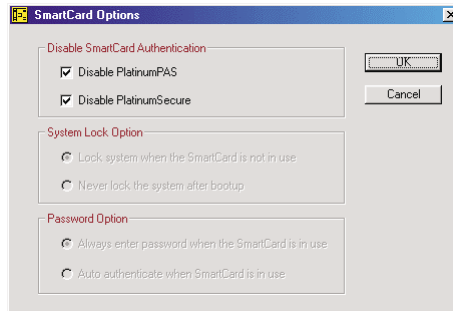

- **Disable SmartCard Authentication**

When **Disable PlatinumPAS** is selected, the PlatinumPAS Preboot Authentication System will be disabled.

When **Disable PlatinumSecure** is selected, the PlatinumSecure Windows Logon Authentication with the SmartCard will be disabled, which means that the protection of your PC as well as other options under **System Lock Option** and **Password Option** will be disabled, too. The SmartCard password is required for this selection.

- **System Lock Option**

When **Lock system when the SmartCard is not in use** (default) is selected, if the SmartCard is removed, the PlatinumSecure screensaver comes up and access to the system is locked. When **Never lock the system after bootup** is selected, there is no protection for the PC after boot up, and Password Option is disabled.

- **Password Option**

When **Always enter password when the SmartCard is in use** (default) is selected, the password is required whenever you need to regain access to the system while the SmartCard is inserted. When **Auto authenticate when SmartCard is in use** is selected, no password is required. All you need to do is insert the SmartCard.

SmartCard Manager

The Multiple users support is implemented and managed in SmartCard Manager. Please note that five users can be registered on one PC. If you registered as the Primary User, **ONLY** you can add/remove other users. If you registered as a regular user, other registered users could add/remove you. All registered users will be able to use the View SmartCard users option.

Change Password

Click the **Change Password** button, fill in the three fields in the Change Password dialog box, and then close the dialog box by clicking the **OK** button to change the SmartCard password.

Encrypt/Decrypt

PlatinumSecure can also be used to encrypt/decrypt files except for system files or files that are already encrypted with other applications. Double-click on a file to automatically encrypt/decrypt it. However, if the file is associated with an application, it will be opened with that application instead of being encrypted. Note that the encryption is not recursive. That is, when you encrypt a folder, only the files immediately under that folder are encrypted, other files under subfolders are not.

To find the Encrypt/Decrypt commands:

- Right-click on the Start menu,
- Right-click on a folder or icon on your Windows desktop, or
- In Windows Explorer, right-click on a selected folder, file, or group

of files.

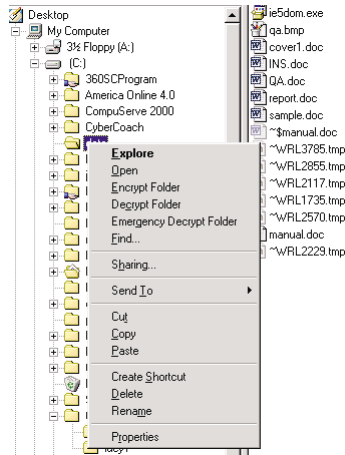

Running PlatinumKey

PlatinumKey provides one-click logon to all password-required websites. With its unique SmartCard caching technology, you can greatly extend the limited card memory size to unlimited use by storing your private data in an encrypted file either on the SmartCard, or on the 360 Degree Web secure website server.

Information in PlatinumKey, like the ones in My Info and Credit Cards, can be transferred to other applications using the "drag-and-drop" method: simply point the cursor to the field containing the information, press and hold the left mouse button, then drag the cursor to the application and drop the information there.

PlatinumKey also makes it convenient to change your password. There is always a PWD button available, which is equivalent to the Change Password button in PlatinumSecure.

Follow these steps to use PlatinumKey:

- 1 Open your browser to connect to the Internet.
- 2 Double-click on the PlatinumKey icon on your Windows desktop.
- 3 Enter your SmartCard password and click **OK**.
- 4 If PlatinumKey is being used for the very first time, it will ask "Would you like to link to 360 Degree Web secure website server to backup the information on your SmartCard?" The default

answer is Yes, and it will enable you to store your information (excluding the Credit Cards) on the 360 Degree Web secure website server for backup purposes in case the card is lost/stolen. If you choose No, you will only be able to save My Info, Credit Cards and 5 Websites on your SmartCard.

- 5 Log in to a website where you are already registered.
- 6 PlatinumKey automatically stores your login data and asks for your confirmation to automatically log you in the next time you access the site. Click **Yes** and continue browsing.
- 7 To close PlatinumKey when you are finished browsing, right-click on the PlatinumKey icon on your Windows taskbar and select Close PlatinumKey.

PlatinumKey provides a list of all the logon pages that you have stored. To go directly to any site on the list either double-click it or select it and click the Go button. Also, you can click the View button to view the selected website information including Web Name, User Name, Password, and Web URL. Similarly, type the first letter(s) of a site on the list, and the site will be searched and selected.

You can Edit and Delete the sites as well as other information, and Save or Cancel the changes you made, by selecting the button corresponding to each command.

Using passwords

Three password types protect your computer from unauthorized access. Setting these passwords creates several different levels of protection for your computer and data:

- Setup Password prevents unauthorized entry into the BIOS Utility. Once set, you must key-in this password to gain access to the BIOS Utility. See "BIOS Utility" on page 55 and your online guide for more details.
- Power-On Password secures your computer against unauthorized use. Combine the use of this password with password checkpoints on boot-up and resume from hibernation for maximum security.
- Hard Disk Password protects your data by preventing unauthorized access to your hard disk. Even if the hard disk is removed from the computer and moved to another computer, it cannot be accessed without the Hard Disk Password.



Important! Do not forget your Setup and Hard Disk Password! If you forget your password, please get in touch with your dealer or an authorized service center.

Entering passwords

When a password is set, a password prompt appears in the left-hand corner of the display screen.

- When the Setup Password is set, the following prompt appears when you press **F2** to enter the BIOS Utility at boot-up.

Setup Password

Type the Setup Password and press **Enter** to access the BIOS Utility.

- When the Power-on Password is set, the following prompt appears at boot-up.



Type the Power-on Password (a . symbol appears for each character you type) and press **Enter** to use the computer. If you enter the password incorrectly, an **x** symbol appears. Try again and press **Enter**.

- When the Hard Disk Password is set, the following prompt appears at boot-up.



Type the Hard Disk Password (a . symbol appears for each character you type) and press **Enter** to use the computer. If you enter the password incorrectly, an **x** symbol appears. Try again and press **Enter**.



Important! You have three chances to enter a password. If you successfully entered the password, you are presented with a correct entry symbol. If you fail to enter the password correctly after three tries, the

following message or symbol appears.

Setup
Incorrect password specified. System disabled.

Power-on/Hard Disk



Slide and hold the power switch for four seconds to shut down the computer. Then turn on the computer again, and try again. If you fail to enter the Hard Disk Password, please contact your dealer or an authorized service center.

Setting passwords

You can set passwords using:

- Notebook Manager
- BIOS Utility

See your online guide for more details.

2 Customizing your computer

After learning the basics of your TravelMate computer, let's get acquainted with the advanced features of your computer. In this chapter, you will learn how to add options, upgrade components for better performance, and customize your computer.

key link: accessories.acer.com

Expanding through options

Your TravelMate offers you a complete mobile computing experience.

Connectivity options

Ports allow you to connect peripheral devices to your computer as you would with a desktop PC. For instructions on how to connect different external devices to the computer, see your online guide for more details.

Fax/data modem

Some models have a built-in V.90 56Kbps software modem.



.....
Warning! This modem port is not compatible with digital phone lines. Plugging this modem into a digital phone line will damage the modem.

To use the fax/data modem port, connect a phone cable from the modem port to a telephone jack.



Start your communications software program. See your communications manual for instructions.

Built-in network feature

The built-in network feature allows you to connect your computer to an Ethernet-based (10/100 Mbps) network.

To use the network feature, connect an Ethernet cable from the network jack on the rear of the computer to a network jack or hub on your network.



Fast infrared

The computer's fast infrared (FIR) port allows you to do wireless data transfer with other IR-aware computers and peripherals such as infrared printers. The infrared port can transfer data at speeds of up to four megabits per second (Mbps) at a distance of up to one meter.

To use FIR, position two IR-aware devices such that their IR ports are no more than one meter apart and offset no more than 15 degrees.



When the two computers are in position, simply begin the data transfer as you normally would. See your file transfer software for details.

Universal Serial Bus

The Universal Serial Bus (USB) port is a high-speed serial bus which allows you to connect and daisy-chain in USB peripherals without taking up precious system resources. Your computer has two ports available.

PC Card slots

There is a type II CardBus PC Card slot found on the left side of the computer. This slot accepts credit-card-sized cards that enhance the usability and expandability of the computer. These cards should have a PC Card logo on them.

PC Cards (formerly PC MC IA) are add-on cards for portable computers, giving you expansion possibilities long afforded by desktop PCs. Popular type II cards include flash memory, SRAM, fax/data modem, LAN and SCSI cards. CardBus improves on the 16-bit PC card technology by expanding the bandwidth to 32 bits.

ZV (Zoomed Video) allows your computer to support hardware MPEG in the form of a ZV PC card.



Note: Refer to your card's manual for details on how to install and use the card and its functions.

Inserting a PC Card

Insert the card into the slot and make the proper connections (e.g., network cable), if necessary. See your card manual for details.



Ejecting a PC Card

Before ejecting a PC Card:

- 1 Exit the application using the card.
- 2 Left-click on the PC Card icon on the taskbar and stop the card operation.
- 3 Press the slot eject button (a) to pop out the eject button; then press it again (a) to eject the card (b).

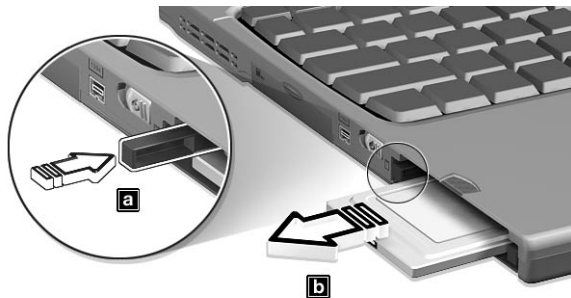

Port expansion devices

Two types of expansion devices are available for your computer:

- I/O replicator - adds serial port and parallel port connections to your computer.
- EasyPort - adds a host of ports for your computer, and allows you to connect and disconnect peripherals from your computer in one quick step.

See your dealer for more information.

Upgrade options

Your computer delivers superior power and performance. However, some users and the applications they use may demand more. This computer allows you to upgrade key components when you need increased performance.



Note: Contact your authorized dealer if you decide to perform a key component upgrade.

Memory upgrade

Memory is expandable to 1024 MB or 1 GB, employing 128/256/512-MB and supports 133 Mhz industry standard soDIMMs (Small Outline Dual Inline Memory Modules). The computer supports SDRAM (Synchronous Dynamic Random Access Memory).

There are two memory slots on your computer, one of which is occupied by standard memory. You can upgrade memory by installing a memory module into the available slot, or replacing the standard memory with a higher-capacity memory module.

Installing memory

Follow these steps to install memory:

- 1 Turn off the computer, unplug the AC adapter (if connected) and remove the battery pack. Then turn the computer over to access its base.

- 2 Remove the screw (a) from the memory cover; then lift up and remove the memory cover (b).

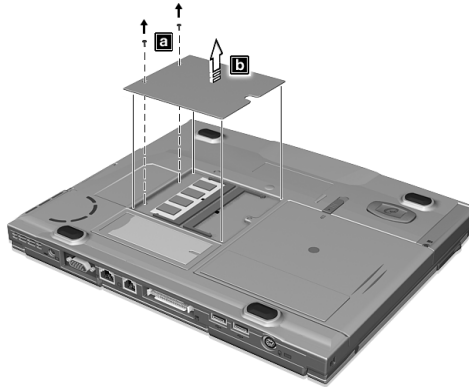

- 3 Insert the memory module diagonally into the slot (a), then gently press it down (b) until it clicks into place.

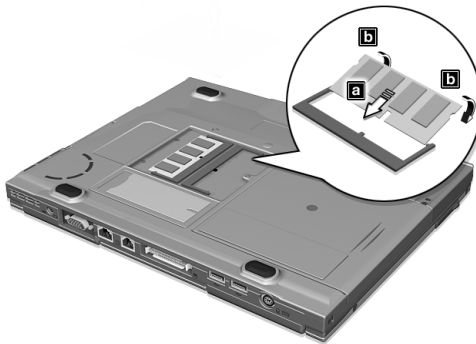

- 4 Replace the memory cover and secure it with the screw.

The computer automatically detects and reconfigures the total memory size.

Notebook Manager

The computer has a built-in system setup program called Notebook Manager. The Windows-based Notebook Manager allows you to set passwords, the startup sequence of the drives, and power management settings. It also shows current hardware configurations.

To start the Notebook Manager, press **Fn-F2** or follow these steps:

- 1 Click on **Start, Programs**, then **Notebook Manager**.
- 2 Select the **Notebook Manager** application to run the program.

See your online guide for more information.

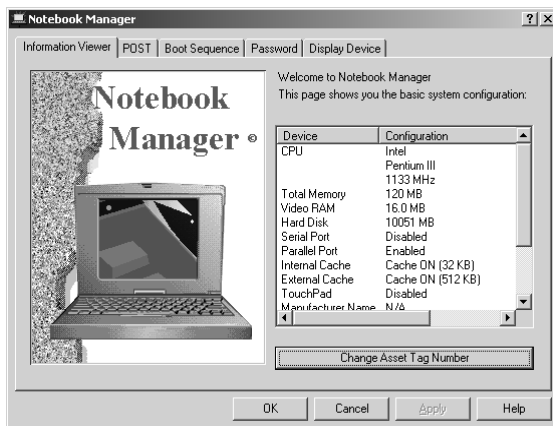

Launch Manager

Launch Manager allows you to set the five launch keys located above the keyboard. See "Launch Keys" on page 18 for the location of the launch key.

You can access the Launch Manager by clicking on **Start, Programs**, and then **Launch Manager** to start the application.

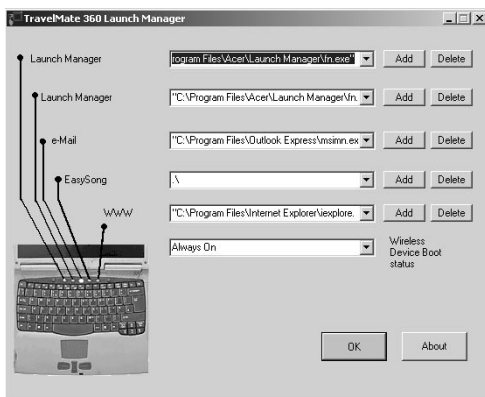

Launch Manager and 802.11b Wireless LAN

By default, the 802.11b wireless LAN is set to "Always On". You can manually switch off the 802.11b wireless LAN by pressing the  button. Manually turning off 802.11b wireless LAN does not change this default setting which is re-enabled when you restart your computer. You have to use the Launch Manager to set it to "Always Off", so that when you turn on your computer, 802.11b wireless LAN will be off.

In Windows 2000, only the administrator can change the setting in the Launch Manager. For all other users, press the  button, then wait for the following dialog box to display.

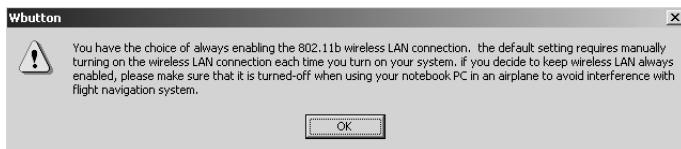

Read this note and click on **OK**.

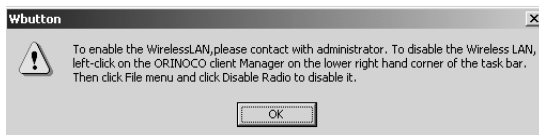

Read the instructions on how to turn off 802.11b wireless LAN and click on **OK**.

BIOS Utility

The BIOS Utility is a hardware configuration program built into your computer's BIOS (basic input/output system).

Your computer is already properly configured and optimized, and you do not need to run this utility. However, if you encounter configuration problems, you may need to run it.

To activate the BIOS Utility, press **F2** during the POST (power-on self-test) while the TravelMate logo is being displayed. See your online guide for more information.

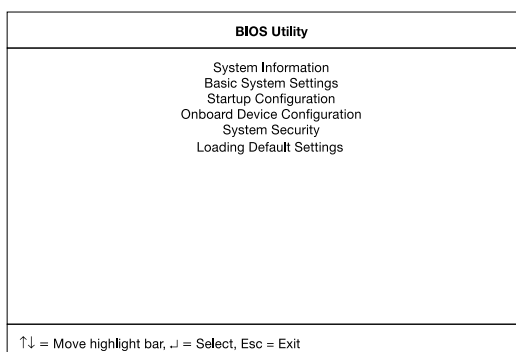

3 Troubleshooting your computer

This chapter instructs you on how to deal with common system problems. Read it before calling a technician if a problem occurs. Solutions to more serious problems require opening up the computer. Do not attempt to open the computer by yourself. Contact your dealer or an authorized service center for assistance.

key link: www.acersupport.com

Frequently-asked questions

The following is a list of possible situations that may arise during the use of your computer. Easy answers and solutions are provided for each one.

I pressed the power switch and opened the display, but the computer does not start or boot-up.

Look at the Power indicator (refer to "Indicators" on page 11):

- If it is not lit, no power is being applied to the computer. Check the following:
 - If you are running on battery power, it may be low and unable to power the computer. Connect the AC adapter to recharge the battery pack.
 - Make sure that the AC adapter is plugged in properly to the computer and to the power outlet.
- If it is lit, check the following:
 - If the Sleep indicator is lit, the computer is in Sleep mode. Press any key or tap on the touchpad to resume.
 - Is a non-bootable (non-system) diskette in the floppy drive? Remove or replace it with a system diskette and press **Ctrl-Alt-Del** to restart the system.
- The operating system files may be damaged or missing. Insert the startup disk you created during Windows setup into the floppy drive and press **Ctrl-Alt-Del** to restart the system. This will diagnose your system and make necessary fixes.

Nothing appears on the screen.

The computer's power management system automatically blanks the screen to save power. Press any key to turn the display back on.

If pressing a key does not turn the display back on, two things might be the cause:

- The brightness level might be too low. Press **Fn→** (increase) and **Fn←** (decrease) to adjust the brightness level.
- The display device might be set to an external monitor. Press the display toggle hot key **Fn-F5** to toggle the display back to the computer.

Image is not full-screen.

Make sure that the resolution is set to 1024x768 which the system supports natively. Right-click on your Windows desktop and select Properties to bring up the **Display Properties** dialog box. Then click on the Settings tab to make sure the resolution is set to the appropriate resolution. Resolutions lower than the specified resolution are not full-screen on the computer or on an external monitor.

No audio is heard from the computer.

Check the following:

- The volume may be muted. In Windows, look at the volume control (speaker) icon on the taskbar. If it is crossed-out, click on the icon and deselect the Mute option.
- The speakers may be turned off. Press **Fn-F8** to turn the speakers on (this hot key also turns the speakers off).
- The volume level may be too low. In Windows, look at the volume control icon on the taskbar. You can also use the volume control buttons to adjust the volume. See "Hot keys" on page 15.
- If headphones, earphones or external speakers are connected to the line-out port on the computer's right panel, the internal speakers automatically turn off.

I want to eject the optical drive tray without turning on the power. I cannot eject the optical drive tray.

There is a mechanical eject button on the optical drive. Simply insert the tip of a pen or paperclip and push to eject the tray.



The keyboard does not respond.

Try attaching an external keyboard to the PS/2 connector on the computer's rear. If it works, contact your dealer or an authorized service center as the internal keyboard cable may be loose.

I prefer using an external keyboard and mouse, but both have PS/2 connectors and there is only one PS/2 port on the computer.

To connect two PS/2-type devices to the computer, you need to use an optional PS/2 Y-bridge connector.

The infrared port does not work.

Check the following:

- Make sure that the infrared ports of the two devices are facing each other (+/- 15 degrees) a maximum of 1 meter apart.
- Make sure that there is a clear path between the two infrared ports. Nothing should be blocking the ports.
- Make sure that you have the appropriate software running on both devices (for file transfers) or that you have the appropriate drivers (for printing to an infrared printer).
- During the POST, press **F2** to access the BIOS Utility and verify that the infrared port is enabled.
- Make sure that both devices are IrDA-compliant.

I want to set up my location to use the internal modem.

To properly use your communications software (e.g., HyperTerminal), you need to set up your location:

- 1** Click on **Start, Settings, Control Panel**.
- 2** Double-click on **Modems**.
- 3** Click on **Dialing Properties** and begin setting up your location.

Refer to the Windows manual.

I get a "Not Enough Space for Allocation" error message from the Sleep Manager program.

This is an error message that may appear when Sleep Manager is creating the Hibernation file. There are several different reasons that may cause this error:

- The size of the free disk space on your hard disk is less than the required size.

For example, if the onboard memory (including video memory) is 64MB, the total free disk space required will be around 64MB. If the total free disk space is less than this, you have to free up space on the hard disk.

- The hard disk has enough free space, but this free space exists as small fragments.

The free disk space that Sleep Manager requires needs to be contiguous. To solve this problem, use tools such as Disk Defragmenter (Windows) to compact these free disk spaces. Then run Sleep Manager again to create the file.

- Disk compression utilities are used.

Sleep Manager can work with most compression software. However, Sleep Manager can only create the space on a host drive. A host drive stores original file information and cannot be compressed. The free space on the host drive is usually very small, so the compression software needs to be run again to enlarge the size of the host (uncompressed) drive for Sleep Manager.

Troubleshooting tips

This notebook computer incorporates an advanced design that delivers on-screen error message reports to help you solve problems.

- If the system reports an error message or an error symptom occurs, see "Error messages" on page 64.

Error messages

If you receive an error message, note the message and take the corrective action. The following table lists the error messages in alphabetical order together with the recommended course of action.

Error Messages	Corrective Action
CMOS Battery Bad	Contact your dealer or an authorized service center.
CMOS Checksum Error	Contact your dealer or an authorized service center.
Disk Boot Failure	Insert a system (bootable) diskette into the floppy drive (A:), then press Enter to reboot.
Diskette Drive Controller Error or No Controller Present	Contact your dealer or an authorized service center.
Diskette Drive Error	Contact your dealer or an authorized service center.
Diskette Drive Type Mismatch	Press F2 (during POST) to enter the BIOS Utility; then press Esc to exit and reconfigure the computer.
Equipment Configuration Error	Press F2 (during POST) to enter the BIOS Utility; then press Esc to exit and reconfigure the computer.
Hard Disk 0 Error	Contact your dealer or an authorized service center.
Hard Disk 0 Extended Type Error	Contact your dealer or an authorized service center.
I/O Parity Error	Contact your dealer or an authorized service center.
Insert system diskette and press <Enter> key to reboot	Insert a system (bootable) diskette into the floppy drive (A:), then press Enter to reboot.

Error Messages	Corrective Action
Keyboard Error or No Keyboard Connected	Contact your dealer or an authorized service center.
Keyboard Interface Error	Contact your dealer or an authorized service center.
Memory Size Mismatch	Press F2 (during POST) to enter the BIOS Utility; then press Esc to exit and reconfigure the computer.
Missing operating system	Press F2 (during POST) to enter the BIOS Utility; then press Esc to exit and reconfigure the computer.
Non-system disk or disk error. Replace and strike any key when ready.	Insert a system (bootable) diskette into the floppy drive (A:), then press Enter to reboot.
Pointing Device Error	Contact your dealer or an authorized service center.
Pointing Device Interface Error	Contact your dealer or an authorized service center.
Protected Mode Test Fail	Contact your dealer or an authorized service center.
RAM BIOS Bad	Contact your dealer or an authorized service center.
RAM Parity Error	Contact your dealer or an authorized service center.
Real-Time Clock Error	Press F2 (during POST) to enter the BIOS Utility; then press Esc to exit and reconfigure the computer.
Video RAM BIOS Bad	Contact your dealer or an authorized service center.

If you still encounter problems after going through the corrective measures, please contact your dealer or an authorized service center for assistance. Some problems may be solved using the BIOS Utility.

Requesting service

International Traveler's Warranty (ITW)

Your computer is backed by an International Traveler's Warranty (ITW) that gives you security and peace of mind when traveling. Our worldwide network of service centers are there to give you a helping hand.

An ITW passport comes with your computer. This passport contains all you need to know about the ITW program. A list of available, authorized service centers are in this handy booklet. Read this passport thoroughly.

Always have your ITW passport on hand, especially when you travel to receive the benefits from our support centers. Place your proof-of-purchase in the flap located inside the front cover of the ITW passport.

If the country you are traveling in does not have an Acer-authorized ITW service site, you can still get in contact with our offices worldwide.

There are three ways to access Acer for technical support and information:

- Internet service worldwide, visit <http://www.acersupport.com/>
- Telephone support in the United States and Canada, call 1-800-816-2237
- Technical support numbers in various countries

You can view a list of technical support numbers by following these steps:

- 1 Click on **Start, Settings, Control Panel**.
- 2 Double-click on **System**.
- 3 Click on the **Support Information** button.

Before you call

Please have the following information available when you call Acer for online service, and please be at your computer when you call. With your support, we can reduce the amount of time a call takes and help solve your problems efficiently.

If there are error messages or beeps reported by your computer, write them down as they appear on the screen (or the number and sequence in the case of beeps).

If you haven't registered your notebook computer, you will be required to register during your first call to Acer.

You are required to provide the following information:

Name: _____

Address: _____

Telephone number: _____

Machine and model type: _____

Serial number: _____

Date of purchase: _____

Appendix A

Specifications

This appendix lists the general specifications of your computer.

Microprocessor

- Mobile Intel® Pentium® III Processor-M with 512 KB level 2 cache featuring the new Enhanced Intel® SpeedStep™ technology

Memory

- Main memory expandable to 1024 MB or 1 GB
- Dual 144-pin soDIMM socket SDRAM (Synchronous Dynamic Random Access Memory) supports 133 Mhz bus speed
- 512 KB Flash ROM BIOS

Data storage

- One external EasyLink Combo drive (floppy drive + optical drive)
- One high-capacity, Enhanced-IDE hard disk

Display and video

- 13.3" Thin-Film Transistor (TFT) liquid-crystal display (LCD) displaying 24-bit true-color at 1024x768 Extended Graphics Array (XGA) resolution
- 8 MB Video DRAM with DVMT (Dynamic Video Memory Technology™) up to 32 MB
- 3D capabilities
- Simultaneous LCD and CRT display support
- Dual display capability

Audio

- 16-bit AC '97 PCI stereo audio with built-in wavetable synthesizer
- Built-in speaker and microphone
- Sound Blaster Pro and Windows Sound System-compatible
- Separate audio ports for headphone-out, line-in and microphone-in devices

Keyboard and pointing device

- Full-sized keyboard
- Ergonomically-centered touchpad pointing device with scroll function

I/O ports

- **Built-in:**
 - One type II/III CardBus socket
 - One Smart Card interface socket
 - One PS/2 keyboard/mouse port
 - One RJ-11 phone jack
 - One RJ-45 LAN jack
 - One DC-in jack (AC adapter)
 - One external monitor port
 - One microphone-in jack
 - One speaker/headphone-out jack
 - One FIR wireless communications port (IrDA-compliant)
 - Two USB ports
 - One EasyPort port replicator connector
 - One IEEE 1394 port

Weight and dimensions

- 4 lbs (1.8 kg) for 13.3" LCD
- 292 (W) x 234 (D) x 21 (H)mm

Temperature

- **Operating:** 10°C ~ 35°C
- **Non-operating:** -20°C ~ 60°C

Humidity (non-condensing)

- **Operating:** 20% ~ 80%RH
- **Non-operating:** 20% ~ 80%RH

System

- ACPI support
- DMI 2.0-compliant
- LDCM support

Battery pack

- 34 WH Li-Ion main battery pack
- Smart battery management technology
- 1.5-hour rapid charge/2.5-hour charge-in-use

AC adapter

- 60-Watt
- Auto sensing 100~240Vac, 50~60Hz

Options

- 128-/256-MB memory upgrade module
- Higher-capacity hard disk drive
- One EasyLink Combo module
- PS/2 Y-bridge cable
- Additional AC adapter and battery pack
- USB video capture kit
- File transfer cable
- Infrared Red (IR) remote control
- External battery charger
- USB Bluetooth dongle solution
- 802.11b wireless LAN

Appendix B

Notices

This appendix lists the general notices of your computer.

FCC notice

This device has been tested and found to comply with the limits for a Class B digital device pursuant to Part 15 of the FCC Rules. These limits are designed to provide reasonable protection against harmful interference in a residential installation. This device generates, uses, and can radiate radio frequency energy and, if not installed and used in accordance with the instructions, may cause harmful interference to radio communications.

However, there is no guarantee that interference will not occur in a particular installation. If this device does cause harmful interference to radio or television reception, which can be determined by turning the device off and on, the user is encouraged to try to correct the interference by one or more of the following measures:

- Reorient or relocate the receiving antenna
- Increase the separation between the device and receiver
- Connect the device into an outlet on a circuit different from that to which the receiver is connected
- Consult the dealer or an experienced radio/television technician for help

Notice: Shielded cables

All connections to other computing devices must be made using shielded cables to maintain compliance with FCC regulations.

Notice: Peripheral devices

Only peripherals (input/output devices, terminals, printers, etc.) certified to comply with the Class B limits may be attached to this equipment. Operation with non-certified peripherals is likely to result in interference to radio and TV reception.

Caution

Changes or modifications not expressly approved by the manufacturer could void the user's authority, which is granted by the Federal Communications Commission, to operate this computer.

Use conditions

This part complies with Part 15 of the FCC Rules. Operation is subject to the following two conditions: (1) this device may not cause harmful interference, and (2) this device must accept any interference received, including interference that may cause undesired operation.

Notice: Canadian users

This Class B digital apparatus meets all requirements of the Canadian Interference-Causing Equipment Regulations.

Remarque à l'intention des utilisateurs canadiens

Cet appareil numérique de la classe B respecte toutes les exigences du Règlement sur le matériel brouilleur du Canada.

Modem notices

FCC

This equipment complies with Part 68 of the FCC rules. Located on the bottom side of the modem is a label that contains, among other information, the FCC Registration Number and Ringer Equivalence Number (REN) for this equipment. Upon request, you must provide this information to your telephone company.

If your telephone equipment causes harm to the telephone network, the telephone company may discontinue your service temporarily. If possible, they will notify you in advance. But, if advance notice is not practical, you will be notified as soon as possible. You will also be informed of your right to file a complaint with the FCC.

Your telephone company may make changes in its facilities, equipment, operations, or procedures that could affect the proper functioning of your equipment. If they do, you will be notified in advance to give you an opportunity to maintain uninterrupted telephone service.

If this equipment should fail to operate properly, disconnect the equipment from the phone line to determine if it is causing the problem. If the problem is with the equipment, discontinue use and contact your dealer or vendor.

CTR 21

This equipment has been approved [Council Decision 98/482/EC - "CTR 21"] for pan-European single terminal connection to the Public Switched Telephone Network (PSTN). However, due to differences between the individual PSTNs provided in different countries, the approval does not, of itself, give an unconditional assurance of successful operation on every PSTN termination point. In the event of problems, you should contact your equipment supplier in the first instance.

Important safety instructions

Read these instructions carefully. Save these instructions for future reference.

- 1** Follow all warnings and instructions marked on the product.
- 2** Unplug this product from the wall outlet before cleaning. Do not use liquid cleaners or aerosol cleaners. Use a damp cloth for cleaning.
- 3** Do not use this product near water.
- 4** Do not place this product on an unstable cart, stand, or table. The product may fall, causing serious damage to the product.
- 5** Slots and openings in the cabinet and the back or bottom are provided for ventilation; to ensure reliable operation of the product and to protect it from overheating, these openings must not be blocked or covered. The openings should never be blocked by placing the product on a bed, sofa, rug, or other similar surface. This product should never be placed near or over a radiator or heat register, or in a built-in installation unless proper ventilation is provided.
- 6** This product should be operated from the type of power indicated on the marking label. If you are not sure of the type of power available, consult your dealer or local power company.
- 7** Do not allow anything to rest on the power cord. Do not locate this product where persons will walk on the cord.
- 8** If an extension cord is used with this product, make sure that the total ampere rating of the equipment plugged into the extension cord does not exceed the extension cord ampere rating. Also, make sure that the total rating of all products plugged into the wall outlet does not exceed the fuse rating.
- 9** Never push objects of any kind into this product through cabinet slots as they may touch dangerous voltage points or short out parts that could result in a fire or electric shock. Never spill liquid of any kind on the product.
- 10** Do not attempt to service this product yourself, as opening or removing covers may expose you to dangerous voltage points or other risks. Refer all servicing to qualified service personnel.
- 11** Unplug this product from the wall outlet and refer servicing to qualified service personnel under the following conditions:
 - a** When the power cord or plug is damaged or frayed
 - b** If liquid has been spilled into the product
 - c** If the product has been exposed to rain or water
 - d** If the product does not operate normally when the operating instructions are followed. Adjust only those controls that are covered by the operating instructions since improper adjustment of other

controls may result in damage and will often require extensive work by a qualified technician to restore the product to normal condition.

- e** If the product has been dropped or the cabinet has been damaged
 - f** If the product exhibits a distinct change in performance, indicating a need for service.
- 12** Replace the battery with the same type as the product's battery we recommend. Use of another battery may present a risk of fire or explosion. Refer battery replacement to a qualified serviceman.
 - 13** Warning! Batteries may explode if not handled properly. Do not disassemble or dispose of them in fire. Keep them away from children and dispose of used batteries promptly.
 - 14** Use only the proper type of power supply cord set (provided in your accessories box) for this unit. It should be a detachable type: UL listed/CSA certified, type SPT-2, rated 7A 125V minimum, VDE approved or its equivalent. Maximum length is 15 feet (4.6 meters).

Laser compliance statement

The CD-ROM or DVD-ROM drive used with this computer is a laser product. The CD-ROM or DVD-ROM drive's classification label (shown below) is located on the drive.

CLASS 1 LASER PRODUCT

CAUTION: INVISIBLE LASER RADIATION WHEN OPEN. AVOID EXPOSURE TO BEAM.

APPAREIL A LASER DE CLASSE 1 PRODUIT

LASERATTENTION: RADIATION DU FAISCEAU LASER INVISIBLE EN CAS D'OUVERTURE. EVITER TOUTE EXPOSITION AUX RAYONS.

LUOKAN 1 LASERLAITE LASER KLASSE 1

VORSICHT: UNSICHTBARE LASERSTRAHLUNG, WENN ABDECKUNG GEÖFFNET NICHT DEM STRAHLEN AUSSETZEN

PRODUCTO LÁSER DE LA CLASE I

ADVERTENCIA: RADIACIÓN LÁSER INVISIBLE AL SER ABIERTO. EVITE EXPONERSE A LOS RAYOS.

ADVARSEL: LASERSTRÅLING VED ÅBNING SE IKKE IND I STRÅLEN.

VARO! LAVATTAESSA OLET ALTINA LASERSÄTEILYLLE.

WARNING: LASERSTRÅLNING NÅR DENNA DEL ÅR ÖPPNAD ÅLÅ TUIJOTA SÄTEESEENSTIRRA EJ IN I STRÅLEN

WARNING: LASERSTRÅLNING NAR DENNA DEL ÅR ÖPPNADSTIRRA EJ IN I STRÅLEN

ADVARSEL: LASERSTRÅLING NAR DEKSEL ÅPNESSTIRR IKKE INN I STRÅLEN

Lithium battery statement

CAUTION

Danger of explosion if battery is incorrectly replaced. Replace only with the same or equivalent type recommended by the manufacturer. Discard used batteries according to the manufacturer's instructions.

ADVARSEL!

Lithiumbatteri - Eksplosjonsfare ved feilagtig håndtering. Udsiftning må kun ske med batteri af samme fabrikat og type. Léver det brugte batteri tilbage til leverandøren.

ADVARSEL

Eksplosjonsfare ved feilaktig skifte av batteri. Benytt samme batteritype eller en tilsvarende type anbefalt av apparatfabrikanten. Brukte batterier kasseres i henhold til fabrikantens instruksjoner.

VARNING

Explosionsfara vid felaktigt batteribyte. Använd samma batterityp eller en ekvivalent typ som rekommenderas av apparattillverkaren. Kassera använt batteri enligt fabrikantens instruktion.

VAROITUS

Päristo voi räjähtää, jos se on virheellisesti asennettu. Vaihda päristo ainoastaan laitevalmistajan suosittelemaan tyyppiin. Hävitä käytetty päristo valmistajan ohjeiden mukaisesti.

VORSICHT!

Explosionsgefahr bei unsachgemäßen Austausch der Batterie. Ersatz nur durch denselben oder einem vom Hersteller empfohlenen ähnlichen Typ. Entsorgung gebrauchter Batterien nach Angaben des Herstellers.

Year 2000 compliance statement

The TravelMate 360 series notebook computer carries the "Hardware NSTL Tested Year 2000 Compliant" logo, which certifies that this model has been tested by NSTL using the YMark2000 test, and has been found to meet NSTL's standards for Year 2000 hardware compliance.



For more details, check the Acer Year 2000 Resource Center Web site (<http://global.acer.com/service/pcy2000.html>)

Macrovision copyright protection notice

This product incorporates copyright protection technology that is protected by method claims of certain U.S. patents and other intellectual property rights owned by Macrovision Corporation and other rights owners. Use of this copyright protection technology must be authorized by Macrovision Corporation, and is intended for home and other limited viewing uses only unless otherwise authorized by Macrovision Corporation. Reverse engineering or disassembly is prohibited.

Apparatus Claims of U.S. Patent Nos. 4,631,603, 4,577,216, 4,819,098, and 4,907,093 licensed for limited viewing uses only.

Index

A

- AC adapter
 - caring for v
- audio 27
 - adjusting the volume 27
 - troubleshooting 60

B

- battery pack
 - caring for vi
 - charging indicator 11
- BIOS utility 55
- brightness
 - hotkeys 17

C

- caps lock 13
 - on indicator 11
- care
 - AC adapter v
 - battery pack vi
 - computer v
- CD-ROM
 - ejecting 25
 - ejecting manually 60
 - troubleshooting 60
- cleaning
 - computer vi
- computer
 - bringing to meetings 30
 - caring for v
 - cleaning vi
 - disconnecting 29
 - features 3, 9
 - indicators 11
 - keyboards 13
 - moving around 29
 - on indicator 11
 - performance 9
 - security 34
 - setting up a home office 31
 - taking home 30
 - traveling internationally 32
 - traveling on local trips 32

- troubleshooting 58
- tuning off iv
- Wireless Communication indicator 11

- connections
 - network 48
- connectivity options
 - port expansion devices 51
- contrast
 - hotkeys 17

D

- display
 - hotkeys 16
 - troubleshooting 59, 60
- DVD 25
- DVD movies
 - playing 25

E

- EasyLink combo drive 23
- email checking function 19
- error messages 64
- Euro 17

F

- FAQ 59
- front view 3

H

- hard disk 23
- help
 - online manual iv
 - online services 66
- Hibernation mode
 - hotkey 16
- hotkeys 15

I

- indicator lights 11
- infrared 48
 - troubleshooting 61
- ITW. See warranty

K

- keyboard 13
 - embedded numeric keypad 14
 - hotkeys 15
 - lock keys 13

troubleshooting 61
Windows keys 15

L

LEDs 11

M

media access
 on indicator 11
memory
 installing 51– 52
 upgrading 51
messages
 error 64
modem 47

N

network 48
Notebook Manager 52
 hotkey 16
notice
 DVD copyright protection 82
 year 2000 compliance 81
num lock 13
 on indicator 12
numeric keypad
 embedded 14
 num lock 14

O

online services 66
options
 memory upgrade 51

P

password 41
 types 41
PC Card 49
 ejecting 50
 inserting 50
ports 47
POST (power-on self-test) 55
problems
 CD-ROM 60
 display 59, 60
 infrared 61
 keyboard 61
 Sleep Manager 61
 startup 59

troubleshooting 58

Q

questions
 multiple PS/2 devices 61
 setting location for modem use
 61

S

safety
 CD-ROM 80
 FCC notice 77
 general instructions 79
 lithium battery 81
 modem notices 78
scroll lock 13
security
 keylock 34
 passwords 41
 smart card 34
service
 when to call vi
Sleep Manager
 troubleshooting 61
SmartCard 34
 PlatinumKey 35
 PlatinumPAS 34
 PlatinumSecure 34
 PlatinumSecure options 38
speakers
 hotkey 17
 troubleshooting 60
specifications 70
Standby mode
 hotkey 16
 status indicator 11
status indicators 11
storage 23
 EasyLink combo drive 23
 hard disk 23
support
 information 66

T

touchpad 21
 hotkey 17
 using 21– 22
travel
 international flights 32

- local trips 32
- troubleshooting 58
- tips 63

U

- universal serial bus (USB) 49

V

- view
 - front 5
 - left 5

- rear 6
- right 6
- volume
 - adjusting 27

W

- warranty
 - International Traveler's Warra-
ty 66
- Windows keys 15

Free Manuals Download Website

<http://myh66.com>

<http://usermanuals.us>

<http://www.somanuals.com>

<http://www.4manuals.cc>

<http://www.manual-lib.com>

<http://www.404manual.com>

<http://www.luxmanual.com>

<http://aubethermostatmanual.com>

Golf course search by state

<http://golfingnear.com>

Email search by domain

<http://emailbydomain.com>

Auto manuals search

<http://auto.somanuals.com>

TV manuals search

<http://tv.somanuals.com>